

Systema Naturae: shared practices between physical computing and algorithmic composition

Andrea Valle

CIRMA-StudiUm - Università di Torino
andrea.valle@unito.it

Mauro Lanza

IRCAM-Paris
mauro.lanza@ircam.fr

ABSTRACT

Systema Naturae is a cycle of four compositions written for various instrumental ensembles and electromechanical setups. The workflow includes design and construction of electromechanical instruments, algorithmic composition, automated notation generation, real-time control of the setups and synchronization with the acoustic ensemble during the performances. These various aspects have to be integrated in a unique working pipeline, that has to be shared between the two authors, and thus requires to define communication protocols for sharing data and procedures. The paper reports on those aspects and on the integration required between hardware and software, non-real time and real time operations, acoustic and mechanical instruments, and, last but not least, between the two composers.

1. INTRODUCTION

The cycle *Systema Naturae* (2013-17, [1]) includes four 20 minute pieces. Its main feature is the use of acoustic instruments together with computer-controlled physical objects placed in a specific spatial organisation¹.

Two references are at the base of whole cycle. The first is the Medieval tradition of bestiaria, herbaria and lapidaria intended as multi-faceted catalogues of miscellaneous beings. A second reference for the work is taxonomy, that is, the systematic description of living organisms that dates back to Linnaeus' *Systema Naturae* (hence the name of the whole cycle) as the rationalistic possibility of ordering the polymorphous (and many times teratomorphic) appearance of nature. Each piece of the cycle is organised as a catalog of short pieces that receive an invented Latin name in binomial nomenclature (see two examples in Figure 11 and 14). *Regnum animale* (RA), featuring a string trio and 25 objects, has been commissioned by Milano Musica Festival and premiered by RepertorioZero (2013). *Regnum vegetabile* (RV), for sextet, includes 30 hacked hair dryers, and has been commissioned by Ensemble Mosaik (Darmstadt, 2014). *Regnum Lapidum* (RL), for septet and 25 objects is a commission by Ensemble 2e2m and has been

¹Photo/video documentation can be found at <http://vimeo.com/vanderaalle> and <http://www.flickr.com/photos/vanderaalle/albums>

Copyright: © 2017 Andrea Valle et al. This is an open-access article distributed under the terms of the [Creative Commons Attribution 3.0 Unported License](https://creativecommons.org/licenses/by/3.0/), which permits unrestricted use, distribution, and reproduction in any medium, provided the original author and source are credited.

premiered in Paris (2016). The cycle is intended to have a final chapter, *Fossilia*, to be premiered in 2017. *Fossilia* is a conclusive piece, to be played together with all the *Regna* as the final chapter of the *Systema*, and it is scored for all the players and the three setups. Figures 1,2,3 show respectively RepertorioZero premiering RA, RV setup installed during a performance by ensemble mosaik, Ensemble 2e2m rehearsing RL.

In the following, we will not discuss algorithmic composition techniques, rather we will focus on instrument design and construction, and on shared communication protocols for music composition in a physical computing environment.



Figure 1. RepertorioZero premiering *Regnum animale*.



Figure 2. ensemble mosaik performing *Regnum vegetabile*.



Figure 3. Ensemble 2e2m rehearsing *Regnum lapideum*.

2. ELECTROMECHANICAL INSTRUMENTARIUM

The main idea at the basis of the electromechanical setups is to create “residual orchestras” [2], that is, ensemble of instruments made up of debris and re-cycled objects (hence on, sound bodies). Residual orchestras belong to two worlds, as they are both everyday objects with a mechanized control and offer an acoustic behaviour similar to music instruments. The main ratio at the basis of the composition of *Systema naturae* is thus to create and explore a middle ground where mechanized objects can be controlled in a standard –even if basic– musical way (by creating events, exploring their spectra, organizing their dynamics) while music instruments are treated in an “object-like” fashion by means of a wide usage of extended techniques. As an example, string trio and guitar include strings prepared with Patafix glue pads to create inharmonic spectra, while wind instruments largely use multiphonics and percussive sounds. To be successful, sound integration between objects and instrument has been based on a complete analysis of sounds, recorded from both objects and instruments, so that acoustic information could be stored and used as a sort of homogenous ground while composing. Audio simulation of the pieces has proven fundamental in avoiding misconception about acoustic behaviour and in interactively exploring an unusual acoustic territory (see Section 3). Given such a technological infrastructure, it has then become possible to exploit a wide range of “classic” algorithmic techniques for composition (e.g. cellular automata, canonic techniques, data sonification, etc.). On the same side, a classification of objects in ethnomusicological terms (see in the following) has proven useful in creating a common conceptual ground with acoustic instruments.

Residual orchestras are meant to challenge the notion of instrument by reducing it to its minimal root. The seminal classification by Hornbostel and Sachs (H-S) [3] has prompted a vast, still on-going, debate among ethnomusicologists about the nature of music instrument [4]. By taking into account also electronic and digital music instruments [5] [6] it is possible to propose a minimal definition, that considers a music instrument as a device capable of generating sound once a certain amount of energy is provided. Three elements are thus relevant: the physical body, an energy source, and a control interface that allows a (variably) fine tuning of the latter, so that the physical body can respond properly. In residual orchestras, physical bodies are designed and assembled following three main principles, inspired by sustainable design ([7]; [8]; in particular here [9]): refabrication, softening, flexibility.

Refabrication: many practices around the world have traditionally developed specific attitudes towards the “refabrication” of objects as a normal way of shaping and re-shaping the semiotic status of material culture [10]. A first example of residual orchestra by the author is the Rumentarium project [11].

Softening refers to the sound body hardware: being so simple and intrinsically costless, sound bodies can be “produced while designed” in an improvisation-like mood, starting from available materials. As a consequence, their hard-

ware nature is quite “soft”: sound bodies, and their parts, can be replaced easily and effortlessly. Sound bodies in most cases remain open, that is, accessible for manipulation. All the orchestras typically present a no-case look, overtly showing components and connections.

Flexibility is here intended as the capability of the residual orchestras to be modified in relation to specific needs: as an example, a performance may require a certain setup in relation e.g. to the presence of microphones for the amplification of sound bodies. Orchestras are assembly of various objects, thus they are made of modular components, that e.g. can be easily replaced.

While the previous considerations may apply to a variety of sound instruments based on a DIY approach, both acoustic [12] and electronic [13], in residual orchestras the energy source does not involve at all the human body (an important feature in ethnomusicological classification, [4]), as it is electromechanical, and typically (even if not always) exploits low voltage motors/actuators. This feature is crucial in bridging sound bodies with computational control, that covers the third element of the previous minimal definition of music instrument. Since 2000 microcontroller boards (e.g. Arduino) have played a pivotal role in physical computing [14], not only in providing an interface between software and the physical environment, but have prompted a new design perspective [15], that has revitalised the DIY technological community. At the moment, many options are indeed available, including the flourishing of single-board computers, like Raspberry PI, UDOO or Bela. In the context of residual orchestras, physical computing provides the control layer for instrument behaviour. Physical computing also implements the principle of flexibility in relation to information processing and symbolic manipulation, as a computer’s main strength is that it ensures not only programming but also re-programming. In short, by means of computational control, residual orchestras allow to create an “acoustic computer music” [11]. *Systema naturae* is entirely based on various residual orchestras that provides an apt correlate of the main aesthetic assumption at the base of the cycle, nature as a catalog of heterogeneous –and most time bizarre– entities, that, yet, can be used in relation to advanced algorithmic composition techniques. The instrumentarium prepared for *Systema Naturae* has to respect three complex constraints:

Low cost construction and maintenance: technical budget is typically very limited and must be distributed (by design) over a large set of sound bodies, the building of each of them having thus to cope with a severely reduced average budget. Typically, budget does not allow to outsource instrument building: setups are thus entirely designed and built by the authors. A DIY approach is fundamental as, due to the nature of sound bodies, maintenance is required while installing setups for concerts.

Transportability: for each piece, the whole setup has to be “designed for disassembly” [9], as it must be assembled/disassembled easily and quickly as possible in order to perform the piece in various locations and in the context of concerts including other complex setups. All technical materials (sound bodies, physical computing inter-

face, powering units, cables) should be included, to avoid issues (and additional cost) on location with rented materials. Due to the hacked nature of the materials, some spare parts should be included in the transported package. Moreover, the overall volume and weight of the technical material must be reduced to be easily transportable. Since their premieres, both RA and RV have been performed more than 10 times in various European locations.

Time responsivity: the previous two constraints necessarily reduce the complexity of sound body, so that their behaviour is extremely simple, in many cases resulting in the production of a single fixed sound with unvarying spectral and dynamic features. To cope with this from a composition perspective, it is crucial to be able at least to finely tune their temporal behaviour. This means that sound bodies must provide a fast attack and decay, so that complex rhythmical organization becomes possible.

In the following, we describe various designs for sound bodies. As noted by [4], the classification of music instruments can be quite complex if only considering sound production, while, on the other side, it can be extended to include various criteria depending on specific ethnographical practices. The classic taxonomic organisation by Hornbostel and Sachs [3] (H-S) can be tailored to fit generic needs by distinguishing among macrofamilies of instruments on the base of mechanical features. In fact, other criteria may be applied resulting in a multidimensional classification (as proposed by [5]). In our case:

Control behaviour: a basic distinction opposes sound bodies with discrete behaviour (on/off, D) to those allowing a continuous one (C).

Control technology: most sound bodies are operated via microcontroller (M), but a subset requires a soundcard (S). While this is not relevant from the user perspective, thanks to software abstraction, nevertheless this implies a specific different technical implementation. In turn, microcontrollers can be used to activate 12 V DC/AC devices or > 12 V (mostly, 230 V) AC ones, a feature that requires specific attention.

Pitch: an important feature in order to compose with sound bodies is the opposition between pitched and unpitched ones (P/U), as pitched sound bodies may be tightly integrated with harmonic content provided by acoustic instruments.

Setup context: sound bodies have been designed in relation to each piece of the cycle and its instrumental setup. RA includes a string trio, surrounded in circle by an amass of computer-driven, electro-mechanical devices built from discarded and scavenged everyday objects and appliances (electric knives, radio clocks, turntables, and so on). RV setup includes a traditional acoustic instrument sextet (string and wind trio), placed behind a 7-meter line of 30 wind sound bodies (vs. RA's circle), all using the same model of hair dryer. In RL the instrumental ensemble is focused on percussive and plucked instruments (two strings, two woodwinds, guitar, piano and percussion), and the same happens for the electromechanical setup that includes plucked strings and percussions, scattered on the floor. While RA was mostly heterogenous and based on house appliances,

and RV focused on wind instruments, RL favours a metallic, percussive approach.

In the following, sound bodies are described following H-S basic principles (see in particular [16]), adding specific tags from the previous classification schema. The subscripts in the Control and Setup tags indicate respectively the current voltage and type (only if V = 12 and type = AC) and the number of occurrences in the specified piece. Figure 4 shows the resulting multidimensional classification, in which only the parts of the H-S tree relevant for sound bodies are represented (e.g. membranophones are not represented). Sound bodies have been named following a sort of distortion process applied to various references to instrument/object name.

I. Idiophones

The idiophone family consists of objects that directly produce sounds by their whole body.

Cono (D, S, U, RL₈): “coni” are 8 woofer loudspeakers to be placed directly on the ground. Each cono is surmounted by an object, simply placed on its top. Loudspeakers are intended to deliver audio impulses that make the surmounting object shake or resonate. Objects include various metal boxes and two large water PVC pipes, having the diameter of the woofer and respectively 80 and 112 cm long. They act as resonators, filtering the impulses provided, with a clear kick drum sound. (see the two orange pipes in Figure 3).

Lampadina (D, M₂₃₀, U, RA₁): a light bulb that can be turned on/off via a relay. It allows to exclusively hear the sonorous relay click while providing at the same time a visual rhythmic cue.

Meshugghello (D, M_{12AC}, P, RA₁) an AC doorbell, that provides a metallic, intermittent pitched sound.

Cimbalo (C, M₁₂, U, RL₂): “cimbali” are scraped instruments in which a plastic beater variably rotates over a metal plate (e.g. a pan).

Sistro (C, M₁₂, U, RL₂): a vessel rattle in which the beater rotates inside a metal box, causing the scraping of various elements (e.g. buttons, seeds, rice) on the internal surface.

Molatore (C, M₁₂, U, RA₄): literally “grinder”, it is a scavenged component from tape decks (typically, cassette or VHS players) that generates low-volume, noisy, continuous sounds by rubbing against various metallic surfaces.

Spremoagrumo (D, M₂₃₀, U, RA₁): a juicer featuring a low-pitched rumble caused by friction between its rotating element and the container.

Rasoio (D, M₁₂, U, RA₁): an electric shaver put into a metal box partially filled with buttons, that provides a buzzing, almost snare-like sound (Figure 5-4).

Segopiatto (D, M₂₃₀, U, RA₄): a “segopiatto” is built by shortly exciting a cymbal (or, in general, a metal resonating plate) by means of an electric knife. The knife's blade is leaning above the cymbal. The knife's motor is operated at 230 V and switched on/off by a 12 V relay. Figure 5-3 shows a segopiatto on a cymbal.

Tola (D, M₁₂, P, RL₆): an idiophone made up of a metal bar screwed into a metal can (Figure 7). Once the bar is struck, the metal can acts as a resonator, the resulting sound including both spectral components from the bar and the

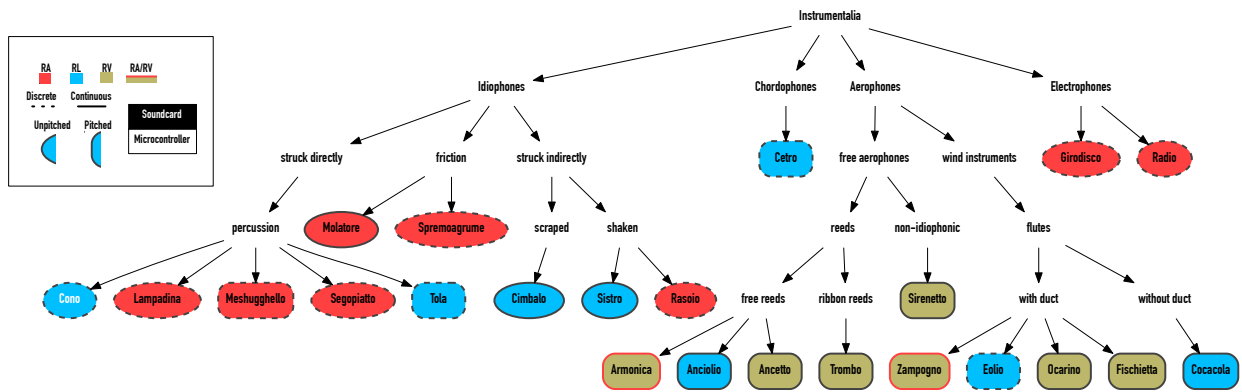

Figure 4. Taxonomy of sound bodies.

can. In order to struck the bar, an eccentric (Lego) wheel has been connected to the motor axle, thus hitting the bar once per rotation. To solve the complex stand issue [12], each tola is loosely glued to the floor, and the motor is supported by small metal bars again taped on the floor.

II. Aerophones

Aerophone construction is particularly affected by design constraints. In relation to air pressure for wind instruments, compressors have been widely used to in automated instruments (e.g. by artists like Marcel-lí Antúnez Roca, Cabo San Roque, Jean-François Laporte) but could not be taken into account because of their dimension and weight. As a general (and low cost solution), modified hair dryers have been used for air generation with controllable, variable pressure. The heating resistor is removed from hair dryers, that can thus be directly powered by a 12 V current. As a result, they are typically not capable of delivering the pressure required to activate reeds, with some exceptions.

Trombo (C, M₁₂, P, RV₁₀): as low pressure is an issue to be taken into account, trombi have been designed starting from football toy trumpet, that features a very thin, and thus efficient, plastic membrane. In this sense, they are reed instruments. Trumpet horns have been modified in various ways, e.g. extended by means of water PVC pipes, including curves for easier layout, reaching a low B (≈ 61.7 Hz). Figure 6, *a* to *d* shows respectively the toy trumpet mouthpiece glued to the hair dryer, the horn, a PVC pipe extension, the use of curves.

Armonica (C, M₁₂, P, RA₃-RV₆): they are built by connecting a harmonica to a hair dryer (Figure 5-5). As the direction of the flow of air depends on motor polarity, by inverting the wiring on the motor it is possible to use both blow and draw reeds.

Anciolio (C, M₁₂, P, RL₁): a single, large accordion reed (C \sharp , ≈ 69.3 Hz) is accommodated inside a metal can, on top of which a computer fan pushes the air flow.

Ancetto (C, M₁₂, P, RV₁): a small toy reed instrument (Figure 6, *g*).

Zampogno (C, M₁₂, P, RA₄-RV₆): a “zampogno” is a set of three recorders connected to a modified hair dryer, acting like a bagpipe (Figure 5-1). A zampogno may include various recorder sizes, from tenor to sopranino. Some standard tunings produce microtonal alteration due to hair dry-



Figure 5. Sound bodies in *Regnum animale*.

ers’ air pressure.

Eolio (D, M₂₄, P, RL₄): a hair dryer is used as source for a PVC pipe flute, but, in order to increase air pressure, it is operated at 24 V, and switched on/off via relays. The resulting wind instrument produces high pitched, gliding aeolian sounds, its actual pitch depending both on pipe length and on the duration of the provided air packet.

Cocacola (C, M₁₂, P, RL₁): a bottle of Coca-Cola blown directly on its edge, with a clear pitch.

Sirenetto (C, M₁₂, U, RV₂): three toy jet whistles packed so to be operated via a single hair dryer (Figure 6, *f*).

Ocarino (C, M₁₂, P, RV₂): two plastic ocarinas packed so to be blown by a single hair dryer (Figure 6, *h*).

Fischietta (C, M₁₂, P, RV₁): a toy whistle blown by hair dryer (Figure 6, *e*).

III. Chordophones

The only member of this group is the “cetro”, but it is also the most complex sound body used in the cycle. The **Cetro** (D, M₁₂, P, RL₁) is an automated zither. Inspired by instruments like the cymbalom, it features a wooden box with 12 electric bass steel strings. The cetro is tuned by tones from low C \sharp (≈ 69.3 Hz) to A \sharp (220 Hz), with a semitone between the sixth and seventh string, thus distributing twelve chromatic pitches over two octaves, in order to wide the available register. In order to pluck the strings, twelve 12 V DC motors, one for each string, are suspended over a bridge. As strings present a large gauge, reduced gear motors are in use, to ensure proper torque. Due to the inelastic response of the axle, flexible rubber picks have been preferred to stiffer (e.g. vinyl) one, to avoid breakage.



Figure 6. Some wind instruments for *Regnum vegetabile*.

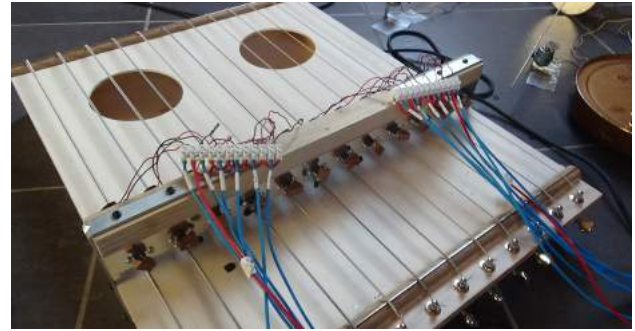

Figure 8. The cetro.



Figure 7. “Tole” (It. plur. for “tola”).

IV. Electrophones

The electrophone extension proposed by Galpin to the original H-S taxa is notoriously problematic and the following examples are not exceptions. In this sense, it has been suggested that the electronic generation can be intended as a modification of existing categories [17]. In our case, on one side all sound bodies are electromechanical in terms of energy supply, on the other side, sound bodies that are strictly based on electronic sound production, like the following ones, neither are inserted into an electroacoustic control chain (they generate sound through internal amplification, as autonomous objects) nor are controlled in a specific way.

Girodisco (D, M_{230} , U, RA_3): low quality, self-amplified turntables with a direct connection between the motor and the rotating plate (Figure 5, 6). The relay opens/closes the motor powering. This results in a gliding behaviour, both in speeding up and down the plate. In order to emphasise the gliding sound, each girodisco plays a 33rpm disc at 45rpm. Content of the disc is irrelevant, as what can be heard is the gliding tone, almost uncoupled from the played vinyl.

Radio (D, M_{230} , U, RA_3): a small radio clock in which the loudspeaker is interrupted by an associated relay (Figure 5, 2). By open/closing the audio signal going to the loudspeaker, a clicking burst of sound is obtained. In the case of radios, a very fast attack is thus possible. Radios are tuned on a frequency where no signal is detected (white or hum noise).

From the previous behaviour description, it is clear that girodisco and radio could be considered respectively as friction and struck idiophones.

3. ALGORITHMIC COMPOSITION PRACTICES AND SHARED PROTOCOLS

The design of the sound bodies (and of their control procedures) is a crucial part of the work, but it has a counterpart on composition. Music composition, at least if referring to the Western corpus of classic practices related to acoustic instruments and Common Practice Notation (CPN), is typically a one-man activity, the composer working by her/himself. On the contrary, *Systema Naturae* is a shared effort with a minimum division of labour between the two authors. Composition work includes the design and construction of electromechanical instruments (see before), algorithmic composition, automated notation generation, real-time control of sound bodies and their synchronization with the acoustic ensemble during the performances. These various aspects had to be integrated in a single working pipeline, thus requiring to define communication protocols for sharing data and procedures in relation to all the aforementioned aspects. Moreover, the authors live in different countries, and large part of the work had to be realised remotely via internet (e.g. via GitHub, file sharing services, VoIP): in the case of RL the authors never met face to face while composing. This working situation was particularly complex as it included experimentation with physical objects (i.e. the sound bodies) and their behaviour. Finally, while sharing a common attitude towards algorithmic composition, the authors favour different programming paradigms and languages (respectively, functional programming in Lisp via Open Music –OM– for ML [18], and object-oriented programming in SuperCollider –SC– for AV [19]). The composition work can be described as a three step process: architectural design, sound organisation, performance design. In Figure 9 the three steps are represented vertically (bold rectangles), activities by the two composer are placed on opposite sides (ML and AV), while the dotted area in the middle represents contents that are shared over internet (shared information), crossbreeding both sides. Rectangles inside step 2 represent, more than objects, activity modules that result in data outputs. Grey rectangles indicate outputs that are passed to step 3. In the following discussion, numbers refer to Figure 9.

1. Architectural design

A pre-production phase that focuses on the meta-organisation of a piece, including general organisation of the composition (e.g. the catalog form, the average duration of each

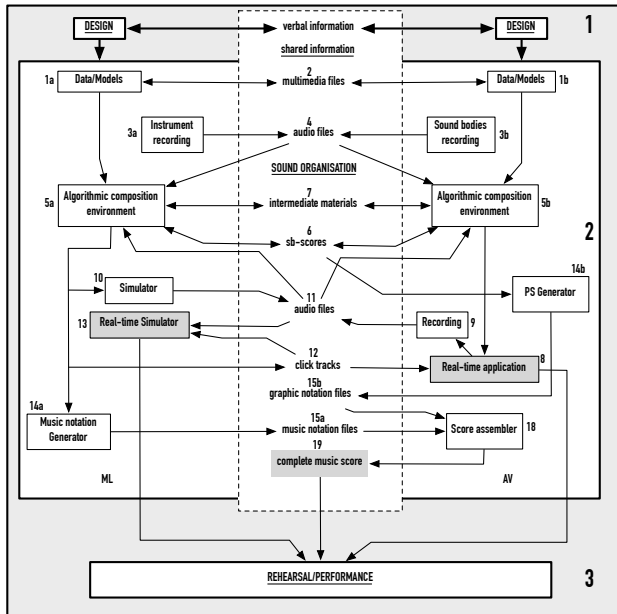

Figure 9. Shared composition information flow.

piece, the choice of acoustic instruments and timbre), the design and building of sound bodies, the development of software to be used while composing (e.g. music notation generation, sound analysis, sound resynthesis for simulating the result).

2. Sound organisation

The core step concerns indeed the organisation of sound materials, that typically includes various algorithmic techniques (see Data/Models 1a-b). Shared output includes data files, algorithms and implementations, graphics etc (2). In order to clearly foresee composition results, sound bodies are recorded (3b) and sound files shared (4). The same happens for instrumental samples (3a), that are mostly recorded from scratch (rather than imported from libraries), as they include special playing techniques. These sound files (4) can be used to feed various algorithms while composing, e.g. audio analysis to gather spectral data (in the Algorithmic composition environments, 5a-b, respectively in OM –Figure 10– and SC). The main output of the two Algorithmic composition environments are “sb-scores” (i.e. scores for sound bodies, 6). Sb-scores are ASCII files that specify events to be triggered in the sound bodies. Sb-scores are defined by the following protocol, loosely inspired by Csound score file format [20]:

```
ocarino1 79.876 0.036 210 210
zampogno7 37.556 0.074 50 50
```

where each line specifies an event by means of instrument name, start time and duration (in seconds), initial and final values (as integers with a 8-bit resolution). Sb-scores represent the main interchange format as they can be parsed on both side in order to be modified (e.g. for post-processing, or to be analysed in order to include acoustic instruments), thus they are fed back into each Algorithmic composition environment (5a-b). Similar scores, even if incomplete, are exchanged as intermediate materials (7), e.g. as composition sketches including numerical specifications (like

in sb-scores) for events to be performed by acoustic instruments. Intermediate materials include indeed a very heterogeneous collection of working materials. Sb-scores are the final output of composition for sound bodies, but they have also to be processed (5b) to obtain the final data format for real-time usage (see later), and then fed into the Real-time Application (8). Sb-scores are played on the electromechanical setups and recorded (9), thus providing feedback on final composition results for sound bodies. A Csound-based, non real time Simulator (10, see [21]) is able to include all the sound samples (both of sound bodies and acoustic instruments) to generate an audio file with a complete and accurate simulation of the piece (11). The Algorithmic composition environment (5a) generates automatically click tracks via OM (12, i.e. audio files). Click tracks are used to synchronise musicians with sound bodies and have to be played back during live performance: they are thus integrated into the Real-time application (8). Another component, the Real-time Simulator (13) performs a different function, as it plays back sound files of the sound body parts of pieces, syncing them with the relative click tracks on a separate channel. Its main usage is during rehearsals with musicians, and proved fundamental, as setups cannot be easily transported, and simulation of sound bodies’ parts provides accurate feedback for performers while rehearsing. The Music notation generator (14a, via OM [22]) is used to generate CPN scores for instruments (music notation files, 15a), while the PS Generator (14b) creates automatic PostScript visualization from sb-score parsing (graphic notation files, 15b), that gives a visual overview of the sound body parts (Figure 11). In general, automatic music notation generation is a complex task but it is instrumental in ensuring an integrated algorithmic composition (IAC) pipeline, rather than a computer assisted one (CAC) [23]. These two graphical outputs are then assembled automatically by the Score assembler (18), that generates ConTeXt files [24], a T_EX-based typesetting macropackage preferred to L^AT_EX for its flexibility [23]. The resulting final complete music score (in PDF, 19) can then be delivered to musicians.

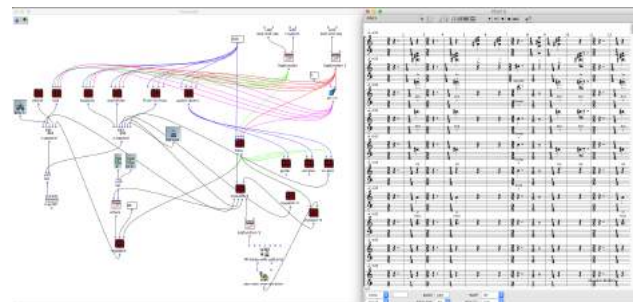

Figure 10. Algorithmic composition environment (OM).

3. Performance design

A specific post-production step is dedicated to design and development (hardware and software) of the real-time performance, particularly delicate as it includes musicians and sound bodies. Rehearsing and live situations require to develop control strategies as robust and flexible as possible.

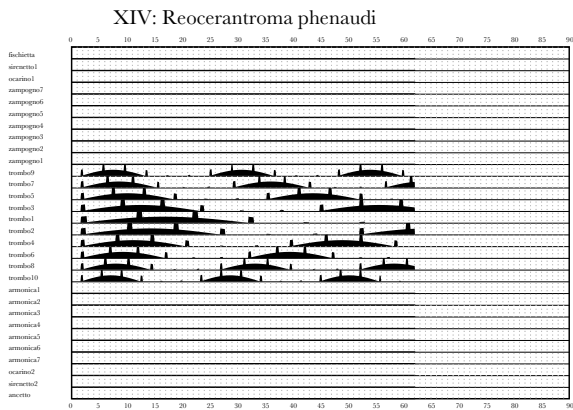

Figure 11. PostScript automatic sound body notation.

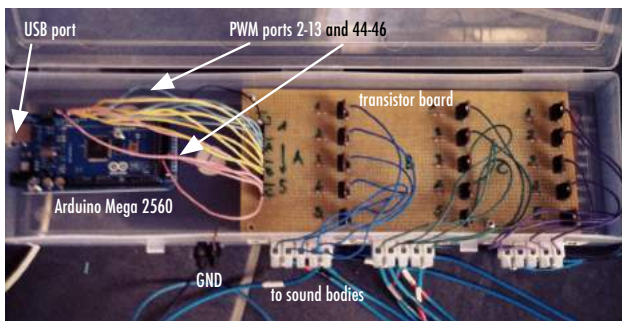

Figure 12. Arduino and transistor board.

This step includes GUI development for sound body control and simulation with click tracks.

In *Sistema Naturae* all the control is demanded to the main computer, as many high-level processes are required, including parsing of textual scores, real-time audio generation for click tracks, GUI creation for live performing. The pieces are all performed live, but there is not interaction between sound bodies and musicians. The main DAC components are Arduino boards converting digital control data (via PWM in case of “continuous“ control) in analog signals that drive a circuit based on a Darlington TIP120 transistor (or similar, see [14]). The transistor board then modulates current to feed the electromechanical components of the objects. The operating voltage is 12 V, that allows to directly drive small DC motors or to trigger relays that can be used also to switch on/off 230 V AC devices. Figure 12 shows an Arduino Mega 2560 encased with its transistor board. In this case (RV), only the 15 PWM ports are used (as indicated). In case of loudspeakers, a sound card acts as a DAC, generating audio signal (in form of impulses), then delivered to an amplifier and finally to loudspeakers. Figure 13 depicts the flow of information for the real-time performance of the pieces, in the general case of RL that includes also audio generation for coni (loudspeakers). The software (in grey) is written in SuperCollider, as the latter provides a high-level language, GUI generation, audio synthesis and playback [19]. It features two components, the Controller and the Scheduler (in solid lines). In Figure 13, GUI elements are dash-dotted, data are dashed, normal lines represent control informa-

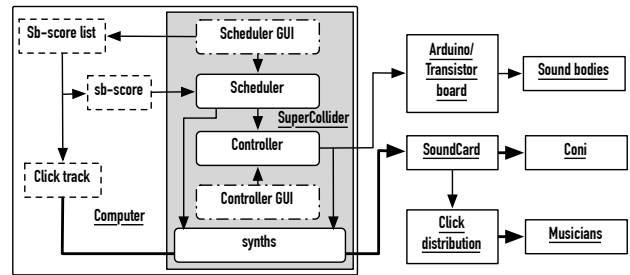

Figure 13. Real-time information flow.

tion, bold lines audio information, solid line rectangles are hardware components (already discussed). In the SuperCollider application, the Controller component accesses the Arduino boards, opening the USB ports, and in the case of audio generation, it is also interfaced to audio synthesis for impulse generation (synths are standard SuperCollider objects for sound synthesis). A GUI element allows easy control over each instrument’s behaviour for checking, tuning etc. The Scheduler is responsible for real-time performance of the pieces. It delivers time-stamped information to the Controller, that, in turn, activates the sound bodies. In order to be sequenced in real-time, sb-scores are post-processed and converted into a new format by means of a sampling process with a sample period $T = 0.01$ seconds. A note event, defined in the sb-score by its initial and final values over a duration, is linearly sampled. Sampling is required by the Controller as the latter can only deal with the setting of a specific value for a port in Arduino. Sb-score sampling results in a $sb \times (100 \times d)$ matrix, where sb is the number of sound bodies and d is the duration in seconds of each sb-score. During real-time scheduling, every 10 ms a bundle of n messages is sent to the Arduino boards. A control is performed so that, if the sound body is not playing or its value has not changed, the relative message is not sent. This means that the bundle has a maximum size of sb (all sound bodies playing) and a minimum of 1 (only one instrument), while in case of silence no message is sent. Sampling solves an issue related to having many parallel process (i.e. “notes” in “voices”) by allowing to implement a single scheduling process with a fixed computational cost (and a maximum network cost). The Scheduler loads the click audio files (one for each piece), the post-processed sb-scores, and connects itself to the Controller module. Its GUI allows complete control over the score scheduling and is provided as the main interface for the performer. Figure 14 shows the scheduler GUI for *Fossililia*. It allows to load a score by referring to its progressive number, and to play/stop the score. For sake of simplicity, in live performances –after a score has been played back– the next score is loaded automatically.

4. CONCLUSIONS

Systema naturae is a four year effort that has required to integrate elements and activities that are typically kept separate: sound bodies had to meet various criteria, from design to packaging, from music control to live synchronisation



Figure 14. Scheduler GUI for *Fossilia*.

with musicians; all activities, ranging from low- (object construction) to high level (music composition) –passing through physical computing organisation– had to be shared between the authors. All these constraints have prompted to establish a clear working methodology that is mostly unusual in contemporary composition.

Acknowledgments

We thank RepertorioZero, ensemble mosaik and Ensemble 2e2m for the commissions, Finder for relais in RA, Liuteria Alvermann for the cetro, Simone Pappalardo for the anciolio and Francesco Richiardi for technical support.

5. REFERENCES

- [1] P. Roullier, Ed., *Mauro Lanza et Andrea Valle: Systema naturae*. Champigny-sur-Marne: Ensemble 2e2m, 2016.
- [2] A. Valle, “Residual orchestras: Notes on low profile, automated sound instruments,” in *Proc. of the Cumulus Conf. '15*. Milano: McGraw-Hill, 3-7 June 2015, pp. 717–729.
- [3] E. M. v. Hornbostel and C. Sachs, “Classification of musical instruments.” *The Galpin Society Journal*, vol. 14, pp. 3–29, 1961.
- [4] M. Kartomi, “The classification of musical instruments: Changing trends in research from the late nineteenth century, with special reference to the 1990s,” *Ethnomusicology*, vol. 45, no. 2, pp. 283–314, 2001.
- [5] R. T. A. Lysloff and J. Matson, “A new approach to the classification of sound-producing instruments,” *Ethnomusicology*, vol. 29, no. 2, pp. 213–36, 1985.
- [6] S. Jordà, “FMOL toward user-friendly, sophisticated new musical instruments,” *Computer Music Journal*, vol. 26, pp. 23–39, 2002.
- [7] W. McDonough and M. Braungart, *Cradle to Cradle: Remaking the Way We Make Things*. New York: North Point, 2002.
- [8] J. F. McLennan, *The Philosophy of Sustainable Design*. Kansas City: Ecotone, 2004.
- [9] P. Tamborrini, *Design sostenibile. Oggetti, sistemi e comportamenti*. Milan: Electa, 2009.
- [10] S. Seriff, *Recycled Re-seen*. Santa Fe: Museum of International Folk Art, 1996, ch. Folk Art from the Global Scrap Head: The Place of Irony in the Politics of Poverty, pp. 8–29.
- [11] A. Valle, “Making acoustic computer music: The rumenarium project,” *Organised Sound*, vol. 18, no. 3, pp. 242–254, 12 2013.
- [12] B. Hopkin, *Musical Instrument Design: Practical Information for Instrument Design*. Tucson: Sharp Press, 1996.
- [13] N. Collins, *Handmade Electronic Music. The art of hardware hacking*. New York–London: Routledge, 2006.
- [14] D. O’Sullivan and T. Igoe, *Physical Computing*. Boston, Mass.: Course Technology, 2004.
- [15] M. Banzi, *Getting started with Arduino*. O’Reilly, 2009.
- [16] “Revision of the Hornbostel-Sachs Classification of Musical Instruments,” MIMO, <http://www.mimo-international.com/documents/HornbostelTech>. Rep., July 2011.
- [17] M. B. Bakan, W. Bryant, G. Li, D. Martinelli, and K. Vaughn, “Demystifying and calssifying electronic music instruments,” *Select Reports in Ethnomusicology*, vol. 8, pp. 37–64, 1990.
- [18] J. B. C. Agon, G. Assayag, Ed., *The OM Composer’s Book*. Paris: Editions Delatour France/IRCAM, 2006, vol. 1.
- [19] S. Wilson, D. Cottle, and N. Collins, Eds., *The Super-Collider Book*. Cambridge, Mass.: The MIT Press, 2011.
- [20] R. Boulanger, Ed., *The Csound Book*. Cambridge, Mass.: The MIT Press, 2000.
- [21] M. Lanza, “La libreria OpenMusic om4Csound,” in *Prossime distanze. Atti del XVIII CIM*, A. Valle and S. Bassanese, Eds., AIMI. Venezia: DADI, 2011.
- [22] J. Bresson, C. Agon, and G. Assayag, “Openmusic: Visual programming environment for music composition, analysis and research,” in *Proceedings of the 19th ACM MM*. New York, NY, USA: ACM, 2011, pp. 743–746.
- [23] A. Valle, “Integrated algorithmic composition,” in *NIME 208: Proceedings*, 2008, pp. 253–256.
- [24] H. Hagen, *ConTeXt the manual*, PRAGMA Advanced Document Engineering, Hasselt NL, 2001.