

# T-18 NEWSLETTER

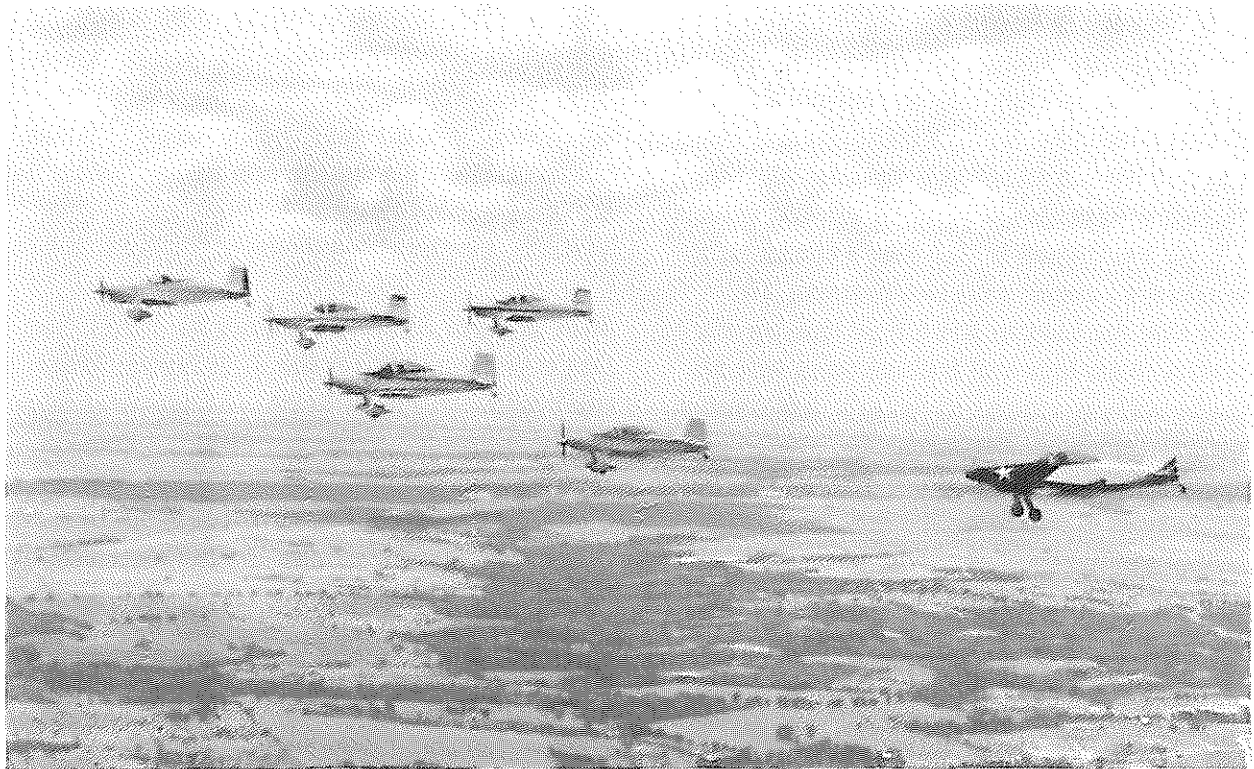

*"Wings over Texas"*

## IN THIS ISSUE:

**Lessons Learned The Hardway**

**Wood Prop Care** *by Mike Demuth*

**5th Annual Placerville Fly-In** *by Jennifer Hill*

**Project Progress Report** *by Robert Clayton*

**"Bogey" "Bogey" "Bogey"** *by Marion Smallwood*

**Classic Sport Aircraft up Date**

**Will the Real Bill Essenburg? -- Please stand up!**

**Kentucky Dam Photos**

**1997 Renewal for The T-18/S-18 Mutual Aid Society**

*NOTICE: (STANDARD DISCLAIMER) As always , in the past, present, and future newsletters, we would like to make you aware that this newsletter is only presented as a clearing house for ideas and opinions, or personal experiences and that anyone using these ideas, opinions, or experiences, do so at their own discretion and risk. Therefore, no responsibility or liability is expressed or implied and is without recourse against anyone.*

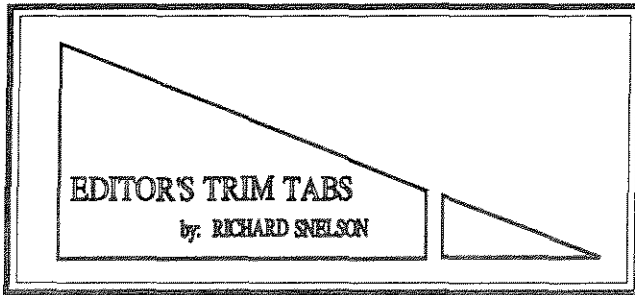

As the year winds down, the Midwest winter offers an opportunity for sitting in front of the south window and thinking about both the high and lows of another year of great flying fun and adventure. I want to tell you about a call that came a few days ago. The caller is looking for a T-18. He has owned two T-18s, a Glasair and now owns a Lancair with two partners. He relates that the Lancair has a fluid leak on one of the retract gear legs and both partners wonder when he will get around to fixing it. His answer, "You guys can have the darn thing, I'm going to get another Thorp. If I had a T-18 I'd be flying now, instead of sitting on the ground." What does that say for the T-18? Just as we thought, it's a classic airplane that provides great transportation and lots of flying enjoyment.

With the help of a couple of friends and the addition of a local internet service provider we now have a World Wide Web homepage. To find it point your web browsers at:  
<http://homepage.dave-world.net/~rsnelson/thorp.html>

I will post important information there. Both events and safety concerns, so add a bookmark to your web site list to make it easy to get back to it. It starts out with "Snelson's World" but don't despair, I had to call it my homepage to avoid paying special commercial rates for it. You will find info about Sun N Fun, Placerville Photos, and information about the newsletter. I will be adding T-18 specs and info on the suppliers of drawings and parts. One of the best parts of surfing the web is that homepages have links to other sites. I'll be adding them later. If you have

a homepage and want a link from the T-18 page just email me you http address. Please note I have a new email address:

[rsnelson@dave-world.net](mailto:rsnelson@dave-world.net)

I gave up on America On Line when the local provider came to Clinton. No more long distance calls. I do think that AOL is the best way to get started with email and using the internet. I've tried to compile a list of email address but it's difficult. They keep changing as people move from service to service. Note, there is a free email service, it's Juno. They have an 800 number to call for information and free software. 1-800-654-5866.

Well let's get down to business for 1997! Sun N Fun is going all out for the T-18 bunch. Warm up you engines and head south. Join what we hope will be the largest gathering of T-18s ever on Florida soil. And then join the fellowship on Thursday evening when we cook the steaks. An to top it all off, award the "John Thorp Trophy" for the best T-18/S-18. How about that for a great event. See you there. **Classic Sport Aircraft is planning on rolling out their T-18/S-18 business at Sun N Fun '97 They have a booth and are looking forward to seeing and meeting you there.**

I am planning a T-18 Fly-In at Coles County Airport, Mattoon, Illinois. in May or June 97. It's a beautiful airport, nice places to stay, and hangar space for all T-18s that show up. There are several neat places to vist from there by ground and air. I'll have the details in the next newsletter.

On a sad note. There was a fatal T-18 crash on August 7, 1996, at the Double Eagle Airport near Albuquerque, New Mexico. The pilot, Howard Culbertson and his wife Marilyn were fatally injured. The NTSB report on the crash states that it appeared to be "Stall Spin related". Winds were around 30 knots at the time of the accident. Our thoughts and prayers go out to their friends and family.

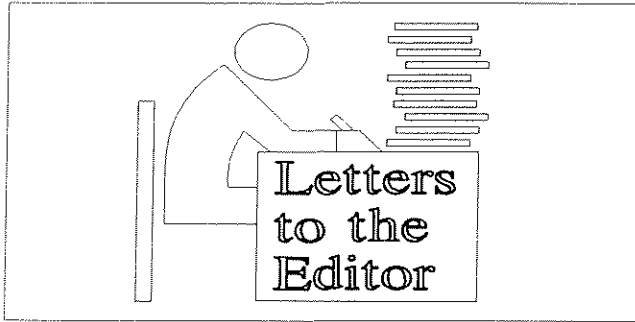

From:  
Lee English <wlee@hartcom.net>

I have picked up my Thorp from Tom Zuber in Columbus, Ga. It has 325 Total and 325 SMOH on an O320, 160 HP. It is a good flying airplane. I need the mailing address to send for the newsletter and back issues. If you would send me this plus any other helpful info, I will appreciate it. I tried to send you Email earlier, but have had trouble with my Email provider and don't know whether you received it. Looking forward to receiving the newsletters and will possibly see you at Lakeland. Thank you. Lee English



From: "Robert F. Clayton"  
rclayton@utah.uswest.net

Regarding the T-18 accident I mentioned earlier - I am trying to get hold of the pilot to get his permission to relate the story. I think it will be ok, but I haven't made contact with him yet. It was one of those stupid accidents that we could all learn from, and I don't think he will mind reviewing the events. More later. I am working on the cowling on my project now and also other areas. I was thinking of using a solenoid type primer on the firewall to keep one less gas hookup inside the cockpit. I am trying to keep things as simple as possible and this seemed to be one way of doing it. My 0290 has a complete priming system that was on the original engine. If the solenoid is a good idea, I will have only the main line from the tank to the shutoff and out the firewall which I like. Your thoughts on that idea, please. Regards, R. Clayton

From:  
woof2@ix.netcom.com

I was very pleased to find the T-18 Society is still alive and on the Net!! In the mid seventies while attending college I became very good friends with the Late Francis Richardson and Dick Cavin. At the time both of these Gentlemen were in the process of building T-18's. Francis was engaged in building his second T-18. They got me all fired up and I began building one, #1151 I believe. It wasn't long till I met Dick Cavin's brother who was building a round back model T-18 I liked it so much that I followed suit. When Francis was killed in his plane, it took some wind out of my sails. I let the project sit for years, plus being government connected I've moved around a great deal. I would like to know price of your newsletters(book form) if they are available. I now reside in New Orleans, LA. I am also building the C folding wing and a type of Gull wing door arrangement. Thanks, Gordon L. Cronin jr.

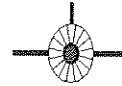

Subject: Howdy!  
Date: Thu, 28 Nov 1996 13:02:37 -0500  
From: BHigh22406@aol.com  
To: rsnelson@dave-world.net

Just stopped by your site, (T-18 homepage) but you weren't home. Looks great, keep up the good work! Bob Highley (the other one)



Subject: HAO Builders Group  
Date: Sun, 24 Nov 1996 19:54:17 -0500  
From: GRAUM@aol.com  
To: rsnelson@dave-world.net

Rich,  
Just a short note to let you know how things are going. We're still plugging away on some of the "small projects." We've begun to assemble the rudder and have completed rib construction for

the horizontal stabilizer meaning we can begin to assemble that as well.

Joe Prokpop(?) flew down Saturday before last and Jim Paine and friends showed up last Saturday in beautifully restored (J-3) observer and a Luscombe. Certainly is nice to have them offer words of encouragement and advice. Best Wishes, Tom Graumlich



Subject: Experimental Wanted  
 Date: Mon, 18 Nov 1996 16:01:30 -0800  
 From: rkulp@atl.mindspring.com  
 To: rsnelson@dave-world.net

Dear Richard,

Please keep me in mind if you come across a really nice T-18/S-18, Midget Mustang, RV-4, RV-6A, Glasair I FT or similiar sport plane for sale. I wrote you about a month ago after selling my Glasair I RG. Thanks, Bob Kulp P. O. Box 1102 Roswell, GA 30077 Phone: (770) 998-1794 FAX: (770) 992-8841



Richard,

I joined the T-18 M.A.S. @ Oshkosh,'96 & got to eat some "Brats" with the crowd. As a current T-18 builder it was exciting & inspiring and a confidence builder. Since Oshkosh we've had a small storm named hurricane Fran which has caused lots of upheaval in North Carolina. Among other damages my construction hangar @ South Raleigh Airport was flooded by a broken dam plus 9" of rain. The result was 4 1/2' of water & silt in and on everything, plane, tools, and building supplies. A lot of work later it is 95% cleaned up. Thankfully there is not much permanent damage. My T-18 is completely built, on

tis gear, 0-360 W/Hartzell C-Speed prop installed, fully plumbed static system, and all electrical & instrumentation installed. Got the radios & Mac aileron & elevator trims @ Oshkosh they are yet to be installed. We're getting close to engine test run time. Hopefully Oshkosh '97 will find another T-18 on the flight line. Thanks for being there to help in such a friendly manner. John E. Cotten 1541 N. Main St. Fuquay-Varina, NC 27526 Phone: 919-552-7123



1 November 1996

3618 Lancaster Road  
 Erie, Pa. 16506

Richard

I was in the Air Force in the late 50s, stationed in Rapid City, South Dakota. A lot of people suffered hail damage to their cars in that area. I was told of a quick and easy way of getting the indentations out of your car. I never tried it so I don't know if it works. Solution — place a piece of dry ice in the center of the indentation and the metal contraction will draw the dimple back out. It is worth a try. Wish-you luck, John C. Buffington



Hi Richard;  
 I received your phonemail message and it was nice to hear from you. I printed another copy of the newsletter using another print style hopefully this one should be easier for your scanner. I'll drop it in the mail on the way home this evening (or I should say on the way to the airport). I'm helping my friend on some maintenance things on the 172 I've been flying. (Honest, they aren't breaking because I'm at the yoke!!) He's very generous to let me use his plane for my training for nothing - not to mention brave. The plane has been in his family since it was new ('69).

I thought Hal was pulling my leg the other day when he said he saw my picture on the internet! I couldn't imagine where & why. I told Mac & he said he would get online & see if it was true. Funny, I was on the World Wide Web & didn't even know it. I'm thrilled that it was somehow related to aviation. The whole saga of me flying is kinda funny ... not much more than a yr ago I had a hard time sitting in the right seat of the 172. Now I'm off the ground in anything I can get near - last week at the AOPA event at Reid-Hillview (that's where I'm based, as well as Mac & Hal) I went up with Robin Reid in his 1930 Fairchild KR21 - a real cool bi-plane. Mac & I fly often in his T-18 or I'm off practicing my own skills. I just soled in August & Hal would like me to get into my cross country stuff soon (I think by Fri!!) He says with my experience we can skip the dual & go on to mini solo cross country treks. So, that's probably what I'll be up to on my next day off (Fri).

My Email address is:  
Jennifer.Hill@SiemensCom.com

I hope that's the correct one, our company just changed names again & dropped the name Rolm off the end of Siemens, so now its Siemens Communications. Anyway, give it a try or drop me a phonecall, that always works. So, when do you plan on getting this newsletter out?? I'm so anxious to see the finished product. I've never written anything like that before. But, Hal & Mac said I needed to have a reason to be at the event - not just to have fun, meet nice people & fly around in everyone's plane!!!

I better run, I've got some work stuff to do before I sneak out early to go to the airport, but I hope to hear from you and I'll drop the new print of the article off to you today. Have a good day, Jennifer 'Take me Flying' Hill

*Editor's Note: Thank's for the story about the Placerville Fly-In. I hope to make it out for the next one. I just looked at my first logbook and my first dual was from Reid Hillview, I think it was Mountain View then, with Amelia Reid. It was in November 1962 and in her L2 Taylor Craft, N66713. That might be the first year she instructed. I still remember her bluejeans and cowboy boots. Say hi for me if you run into her.*

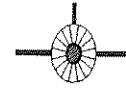

**Wanted- Four three ring pistons for a Lycoming 0290 D, D2 or D2B with new piston rings.** These are quite expensive from the suppliers and if anyone has an 0290G that they have never converted and have these parts I am interested in them.

Question- My plans have Thorps upgrade for the balanced horizontal tail. He did this to control flutter at 200mph+ speeds. I have never seen a horizontal tail on a T-18 with this feature visible. Have builders opted to not incorporate this feature or is there another fix to this problem or is it even a problem?

*Editor: I've only seen one T-18 without the tail mod.*

Question- I have been advised that there is a folding wing option that can be incorporated into the original fuselage. Who has/sells these plans as I am interested in them.

*Editor: Classic Sport Aircraft, see update from them in this newsletter.*

If there are other T-18 owners/builders in the central Florida area I would like to hear from you.

Thank you for your informative newsletter.  
Sincerely Jeff Wilde 183 Lawn St.Oviedo, Fl.  
32765 407-366-0512

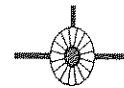

Dear Rich, I have my Thorp T-18, standard body for sale. It was built by Jack Haynes and I am the second owner. The aircraft has 360 hours on it and the engine 50 hrs it was overhauled by Mattituck after a prop strike. It's a 0320, 150 hp. and is turning a Aymar Demuth prop. The radio and GPS is a KLX-135 King. Aircraft has new gyros and is equipped with a Mode C Xponder. My price is \$29,000. Thank you, Scott Keller  
Phone: 617-259-3153

# LESSONS LEARNED

## "the hard way"

Cleveland Brake Problems Again.....

My experience has proven that a dragging brake is a serious problem. If my accident isn't enough to convince you, then a letter from Rick and LouAnn Jones might.

THIS IS AN OPEN LETTER TO ALL OF THE T-18 PEOPLE

DURING OUR DEPARTURE FROM KY DAM THE LEFT BRAKE LOCKED AT 50KTS. THE AIRCRAFT GROUND-LOOPEd OFF THE RUNWAY AND NOSED OVER. THE REAL GOOD NEWS IS THAT NO INJURIES WERE SUFFERED, AND AS BAD AS IT WAS TO SEE A DAMAGED THORP, WE ACTUALLY HAD A VERY HEART-WARMING EXPERIENCE. WITHIN 3 MINUTES OF THE IMPACT, THERE WAS A TREMENDOUS TURNOUT (ALL) OF THE PEOPLE AT THE FIELD. THEIR (YOUR) MAIN CONCERN WAS FOR OUR SAFETY, AND FOLLOWING THAT WE HAD MANY OFFERS OF

- 1) AUTO AND AIRCRAFT RIDES TO ANY AIRPORT THAT WE COULD GET A DELTA FLIGHT HOME
- 2) TIME
- 3) EXPERTISE IN FIXING THE PLANE
- 4) LOANER PROPS, SPINNERS, BRAKES, TOOLS
- 5) OFFERS TO DRIVER 4+ HOURS TO MEET ME AT KY DAM TO FIX THE PLANE
- 6) AND IN GENERAL ANYTHING WE NEEDED!!!!

LOUANN AND I SINCERELY APPRECIATE EVERYONE'S CONCERN AND ALL OF THE HELP OFFERED. ALL OF THIS IS JUST A ROUTINE REAFFIRMATION OF THE FACT THAT THE T-18 GROUP IS THE ABSOLUTE FINEST BUNCH OF PEOPLE ON THE PLANET!!'

IT SEEMS THAT SEVERAL INCIDENTS HAVE OCCURRED WITH CLEVELAND BRAKES HANGING WITH NO PILOT INPUT. MINE WERE NEW (LESS THAN 30 HOURS) AND I HAD EXPERIENCED SOME DRAGGING WHICH I THOUGHT WAS A NUISANCE - I DID NOT THINK THAT THEY WOULD LOCK ON T/O WITH NO BRAKE APPLICATION. I WILL LET EVERYONE KNOW WHAT MALFUNCTIONED WHEN I TEAR THEM DOWN. IN THE INTERIM I STRONGLY SUGGEST YOU NOT FLY IF YOU SUSPECT THAT YOUR BRAKES ARE DRAGGING.

WE STILL HAD A GREAT WEEK-END AND LOOK FORWARD TO NEXT YEAR. THANKS AGAIN.

RICK AND LOUANN

And then for those of you that didn't read the first account of my brake fire:

During runup, a heavy application of the brakes, caused the right brake to partially lock.. Winds were 20 knots at the time and turning onto the runway didn't give a clear indication that the brake was dragging. When the aircraft didn't line up as expected I turned back off the runway. No pressure was needed on the left brake to control the taxi so I taxied about 500 feet after clearing the runway. At that time the dragging became extreme and the aircraft rotated in taxi to the right. My passenger exited the aircraft to check on the problem. Smoke was coming from the right wheel. Before I could get out of the plane the wheel was burning. The fire burned a wheel pant off and damaged the bottom skin of the wing. The fire was advancing up the gear leg cuff

toward the engine compartment when it was finally put out by an airport based fire dept that took 15 minutes to get to the airplane. Yes, I'm still pissed at them, but mostly at my self.

At Kentucky Dam, this year, I witnessed two of my friends (Jones) in their Thorp having a dragging brake on takeoff. It locked up completely after 75 feet of takeoff roll and caused them to veer off the runway. The aircraft nosed over destroying their gear and wiping out the prop. Thank goodness no one was injured. It's not extreme thinking that both of these accidents could have resulted in someone being trapped in a airplane.

In both of these cases, prior events had proven that the brakes were having problems. My Clevelands had locked up twice in the weeks before the fire. The first time, the problem was fixed by kicking the brake until it let go. The second time the assembly was kicked again and then later taken apart and cleaned. I had received the warnings but didn't go far enough with the maintenance. I didn't check the piston for problems. Jones' Thorp also had a prior problem, but they (Rick, sorry LuAnn) choose to put up with the nuisance and tried to kick the wheel and brake into submission. We both know that doesn't work.

Some of the Causes:

After my problem I asked an A&P, in our EAA Chapter, to go over the brakes and show me how he would maintain them. Most aircraft mechanics see a lot of brake problems and know what's necessary to prevent lockups from happening. He was a great help and I'm passing along some of his tips in this article.

When my new Cleveland brake assemblies arrived I found that older Clevelands have shorter pins or sliders. The outer calipers moves on the sliders as the piston pushes it. The older sliders don't extend far enough through the holes and when they get dirty or rusty they stick. When one side of the caliper sticks, it allows the whole assembly to cock sideways, this in turn allows the piston to

cock and stick. Kicking or hitting the assembly may loosen the piston and free up the brakes temporary. I learned that the first lockup often damages the piston causing a burr. This will cause later lockups and the problem only gets worse. The newer Clevelands have pins that are about a half inch longer and extend nearly through the holes. This provides less chance for the ends to get cocked in the holes. The longer pins help but without proper care the dragging problem can still occur when they rust or get dirty.

I now perform maintenance on my brakes three times a year. With the brake calipers removed, I clean the pins using a Scotch Brite pad, rubbing until they are semi-polished. They using a 1" wide piece of the same pad stick it through the holes and scrub until they shine. If the piston has locked up or been sticking I take it out to check for burrs and to check the o-ring. Removing the piston will make it necessary to bleed the brakes, it's worth the extra effort, to eliminate a potential brake lock up.

Don't put any grease in the pin/slider areas. All this will do is cause the whole thing to collect dirt and gum up the works. Use only dry graphite spray on the pins. Spray it on and let it dry for a couple of minutes. Reassemble the brakes and check carefully to be sure the brake lines and fittings don't cause any binding when the brakes are applied. It's a good time to pack the wheel bearing while doing the brake work, don't over grease. I think there was too much grease floating around in the axle area when I had the brake lockup. It caught on fire first.

I have heard other methods for fixing this problem, but believe, there is no substitute for regular maintenance. Once the problem occurs the piston should be pulled and checked for burrs. If you have older Clevelands, consider replacing the sliders.

**\*\*Don't taxi when the brakes are dragging.\*\***

# Wood Prop Care

Contribution by:  
Mike Demuth

Aymar - DeMuth Propellers  
8213 Elberta Dr. Ellicott City, Md. 21043  
Phone: (410) 461-4329

Thank you for selecting a high -performance Aymar- DeMuth propeller. We are confident that you will find it to be of quality workmanship and performance. All of our propellers are designed and hand crafted to meet your specific needs.

We take great pride in our work, that is why we carefully give the prop a final inspection before shipping to assure that it is perfectly balanced and that the track is less than 1/8" tolerance.

To store: Position horizontally on hub or hang from center hole. Once installed, always leave in the horizontal position.

To install: Insert waxed bolts through crush plate then through the prop and into the flange. (Note: do not bottom out bolt in the nut.) Tighten each bolt 5ft./lbs. at a time. Be sure to tighten bolts that are diametrically opposite.

Torque: 5/16" diameter bolts 11 ft./lbs. on a 5" diameter hub

3/8" diameter bolts 18 ft./lbs. on a 6" diameter hub

7/16" diameter bolts same as 3/8"

1/2" diameter bolts 28 ft./lbs. on a 7" diameter hub

**Always torque the prop when the engine is cold !**

Retorquing: Check after first flight and after 10 hours. Then approximately every 25 hours. Also check if the plane has been inactive for a long period of time. Install shims where necessary to insure proper tracking. Safetying: Be sure to safety wire in the proper direction.

Even though our props have an ultra-violet sunblock, we recomend that you cover your prop whenever possible. Reduction of air speed and RPM should be practiced when flying in visable moisture. This is not necessary, when using our IFR prop.

Inspect and clean every flight. If any nicks are found, reseal with a good polyurethane. For minor damage fill with any good wood filler to just above the surface, when hard, sand flush and seal with polyurethane. Rough spots on the leading edge protection should be feathered smooth by light sanding. Don't put off refinishing time! Balance should also be checked. Your satisfaction is guaranteed when you fly with Aymar-DeMuth. Questions ?? Just call us !!

*Editor's Note: Thanks Mike for the advice, sounds like it can be applied to any wooden prop.*



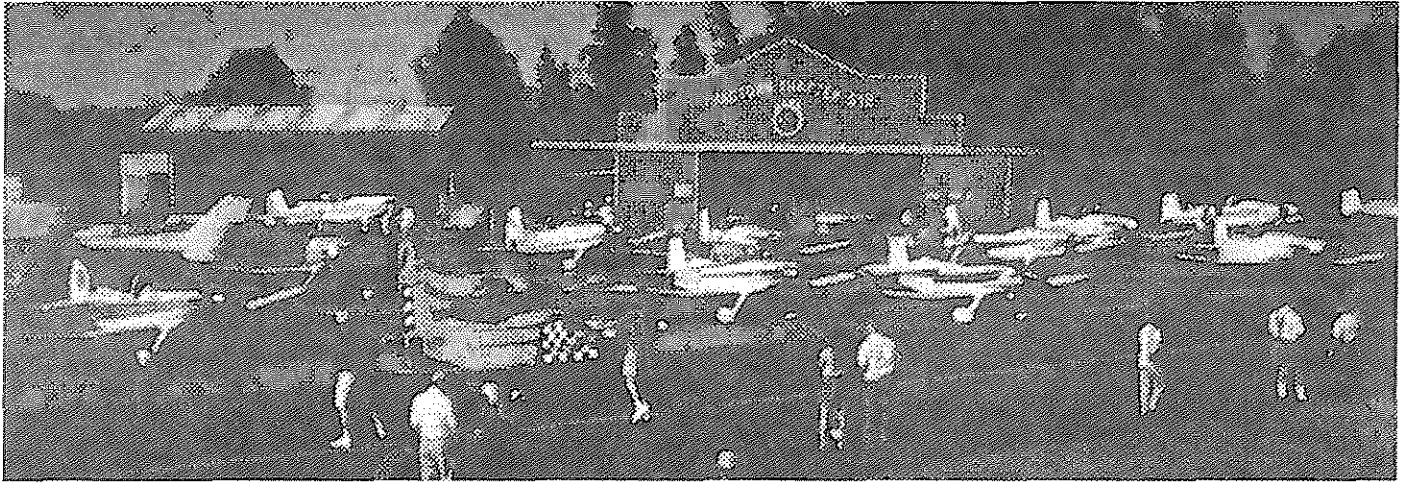

## The 5th Annual Thorp T-18 Fly-In Placerville, Calif.

A spectacular weekend was enjoyed by all that attended the 5th Annual Thorp T-18 Fly In. The event was held Sept. 6, 7 & 8 at the Placerville (aka Hangtown) EAA Chapter 512 hangar. This years festivity drew 32 Thorp T-18's & 1 Sky Scooter and it was noticed that there were other non-Thorp T-18 aircraft in the proximity as well. Attendance for the event was roughly 70 people, larger than the previous years and it felt much like a family reunion for Thorpians. Although most of the travelers were from all parts of California others flew in from many different states. Amos Rauck, David Hamilton, Brad & Sonia Chapman, Brad Janzen arrived from Oregon. Ross Mahon came from Washington. Gary & Maxine Green winged their way from Texas. Al & Helen Chivers, Ann & Vern Lack traveled from Idaho. Dean Cochran, John Evens journeyed from Colorado. And last but not least was Bob & Traci Leider, Norm & Brenda Hibbard, Bob Park, George & Barbara Leider, Wes & Edwin Brush from Nevada. Hats off to those of you who ventured from these greater distances to be a part of this occasion. (I hope I didn't forget any names !) A generous write up in the local Placerville newspaper by the Critchfield's brought local town folk up to see all the beautiful home built T-18s first hand.

Great weather was on tap for the weekend which made for perfect flying conditions for those who offered rides to interested aviation enthusiasts or sitting in on the T-18 forum directed by Lyle Trusty. Visitors who wanted to venture down to Hangtown or up the road to Apple Hill were shuffled by the local sponsors Jim & Lillian Critchfield or Hal & Nancy Stephens. Once the bugle was blown by the bugle boy himself Hal, the long awaited Champagne Cork Fly Off contest was held on the taxi way. Taking 1st place was Gus Gordan, 2nd place to Mac Booth Jr. & 3rd place went to Sonia Chapman. This was Gus's second 1st place victory, we'll wait for next year to see if he can retain his champion status by pulling in a three-pete. Everyone celebrated the day by sharing & savoring the champagne and waiting for the feast that followed. And what a top notch feast it was. Steaks were imported from the Bay Area by Mac & Rena Booth and bar-b-que'd to perfection. Salads, dips, beans, tasty deviled eggs & more fresh Apple Hill pies than anyone could imagine were also on hand. After dinner a raffle was held and various aviation items were won. The 4 (or was it 5) T-18's from Nevada departed in the afternoon sun and flew a striking formation over the area and off towards the Sierra Nevada's.

This years fly in brought together great people, beautiful T-18's and was lots of fun as well as successful. Special Thanks go out to the people who worked to put it together: Nancy & Hal 'Bugle Boy' Stephens, Lillian & Jim 'I want to fly my T-18' Critchfield and Rena & Mac '2nd place Champagne Champ' Booth. Also, Thanks go out to all of you who joined us this year and look forward to seeing more new faces & new planes at next years gala!

Written & Submitted by: Jennifer 'I want to go Flying' Hill Student Pilot & potential future T-18 owner

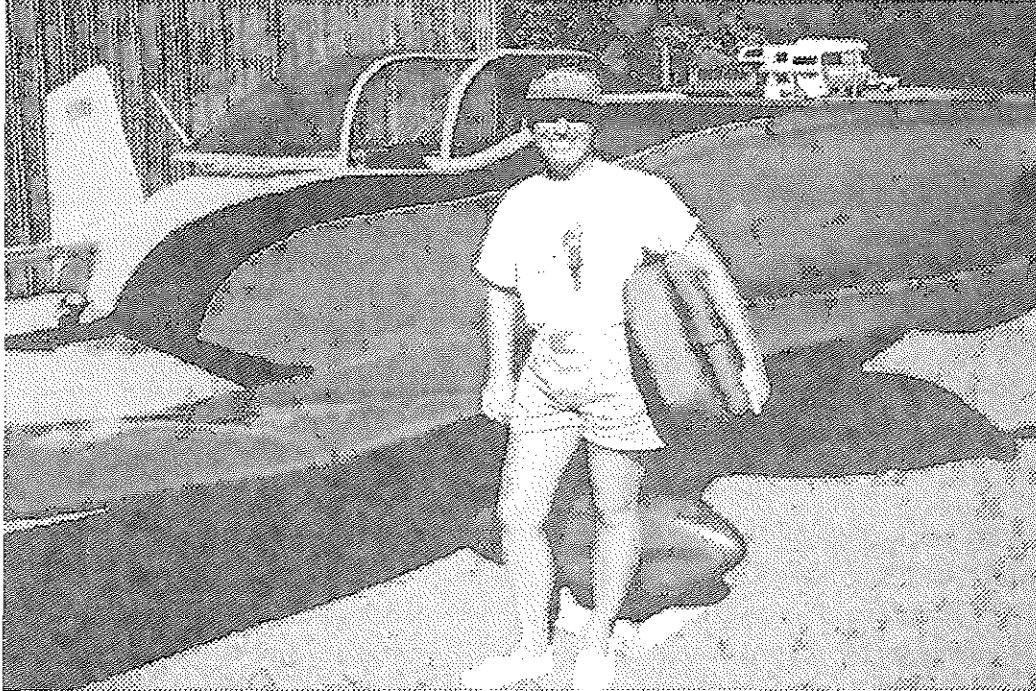

*Jennifer "I want to go flying in a T-18" Hill*

*Reporters Personal Comments; I want to thank the nice guys who gave me rides in their T18's & were brave enough to give the stick to a student. Bill Jennings & Dave Tennant. I got a particular thrill when Dave handed me the co-pilots stick that he keeps in the back of the plane during the flight and told me where to stick it. I did & we zoomed all around to the tunes of Top Gun! Bill asked me if I knew the way to Georgetown, (doesn't everyone?) I showed him and we did a touch & go. My special thanks to Mac Booth for flying me up & back. I had a 'blast' and have a few bruises to show for it. Maybe I'll be invited back next year. Currently, I am a student of Hal Stephens & am learning to fly in a friends Cessna 172.*

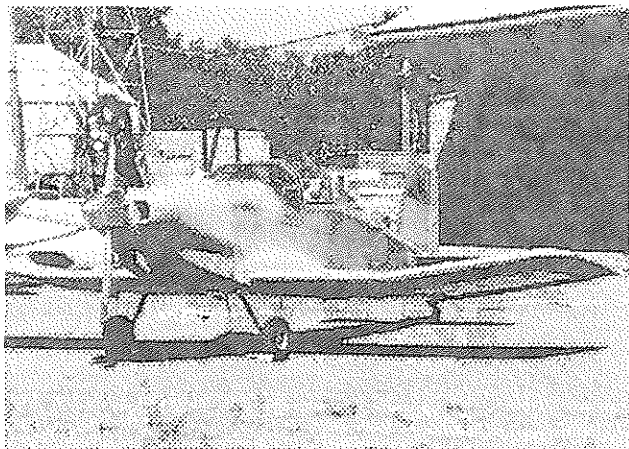

*Jim Critchfield's N8TT Ready for the first flight.*

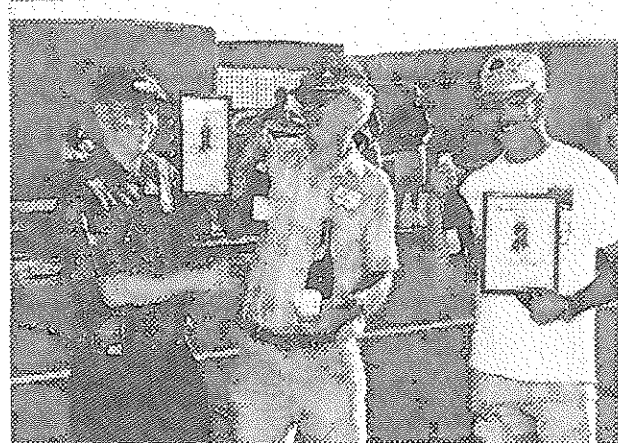

*The Winners, Gus Gordon, & Mac Booth Hal Stephens giving congratulations.*

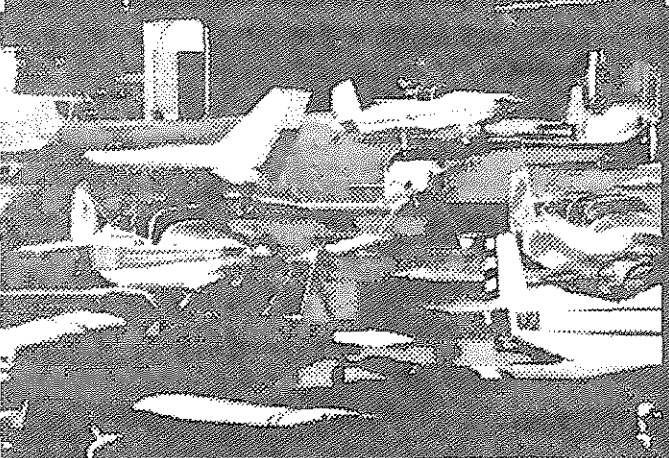
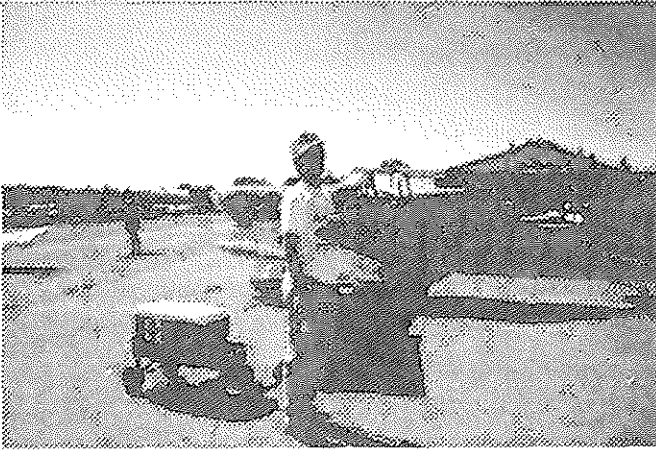
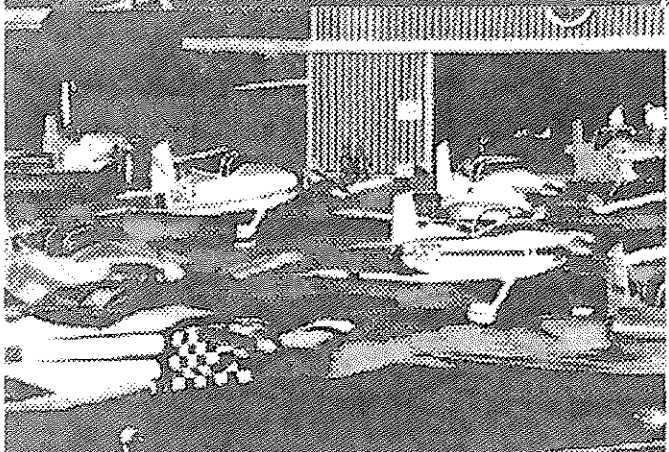
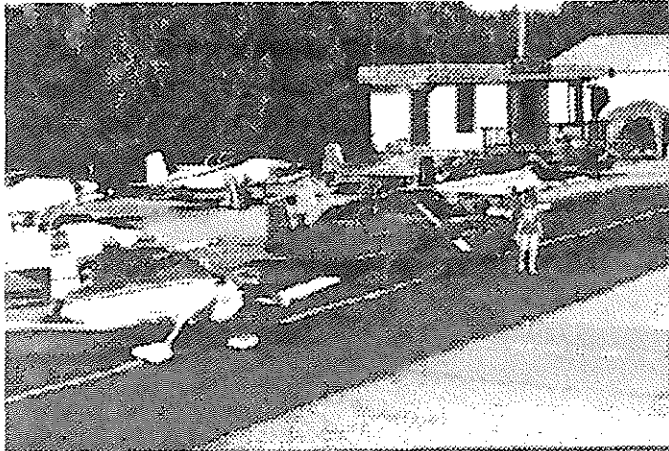

Top-Down:  
The Big Feast-cast of thousands  
Master Chef- Jim Critchfield  
Welcome Wagon-Rena Booth

## Progress Report

by: Robert Clayton

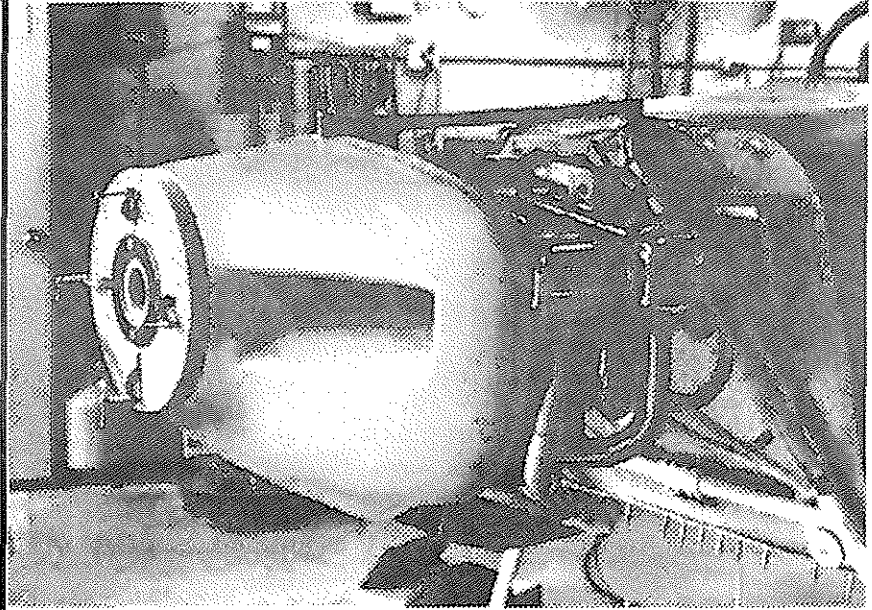

*My method to lock the nose bowl in place. Since this was taken, I have added another 3/4" spacer disk next to the nose bowl to compensate for the flange on the rear spinner bulkhead. 1/4" space allowed between nose bowl and spinner. If Dean Cochran's exhaust looks a little shiny, it is coated inside and out with the HPC Thermal barrier coating. They claim it will never discolor.*

Now for an update. I retired last Jan. and I can't understand why I ever had time to go to work. Anyway, I had some retirement incentive coming and I decided to do something with my mouse motor (0290 D), so I went to work on it.

I really started in earnest when the FAA mentioned the fact that I may have a bad crank, and since my crank had been sitting around since 1960, I had it checked with a good shop in Salt Lake and they saved it. I went from there and did everything. The only original parts were the case, cylinders, rods, some gears, push rods and rocker arms. Everything else is new. I chickened out putting it all together myself and turned it over to the engine shop. They yellow tagged the crank and rods, but not the rest since I had piston skirts, valves, valve springs coated with special thermal barrier coatings by HPC High Performance Coatings used on Indy cars and elsewhere around the country. I'll send some info on this company with some pics I am just finishing up.

Well, my mouse motor is on the mount and partially hooked up. I think I resolved my trim system ok, especially after receiving the correction in the newsletter, which made a big difference. I installed the limit switches per the drawing in the newsletter (that was a cute little process to get it right) - pics to also follow showing my installation. My tail section is finished. With a bad back, I don't ever want to crawl back there again, especially with the push pull tube in place. Battery installed with wiring. No starter yet. Ran out of money for a while (Honey do projects took over for a while this summer).

About 75% of the wiring done. Instrument panel in and almost wired. Have installed a SkySports fuel probe in my tank (not cheap, but simple). Misc. other things accomplished and right now I am starting the cowling (now there is a fun little project!). Several Oshkosh's back I saw Gary Cotner's cowling and I decided that was for me, so that is what I am working on. My last trip to

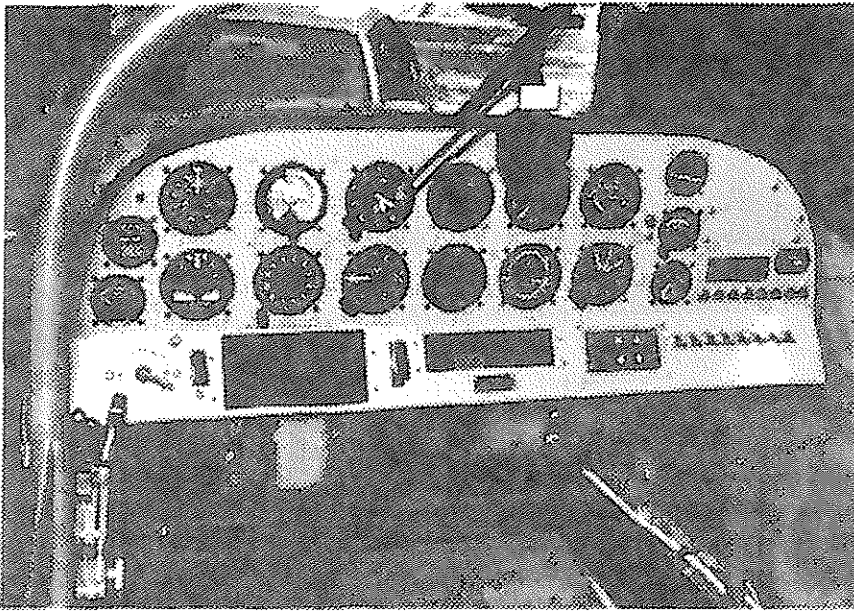

*My 3rd panel- I would like to make another one but you have to stop sometime and live with it. A 9 mag on left, RST Navcom over my knees, master switch left, start right--Transponder center, ACK ELT test center, RST Intercom panel mounted, RST omni top center, Heathkit clock below - nice because it displays local and GMT together. I do have a clear view of the tach when I'm seated. Gary Cotner's throttle quad on the left.*

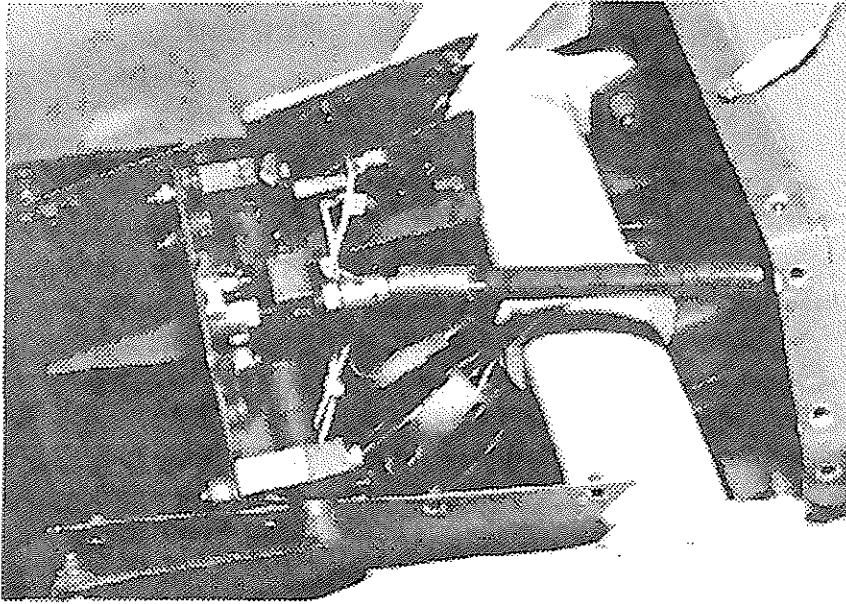

*Trim limit switches according to newsletter article. I had almost 3 turns from center on the jack screw when I started and after installing switches I'm down to 2 1/2 turns. Adjustment of the switches needs wiggle room. I guess if you put in the most expensive Army/Navy switches you could narrow down the adjustment.*

Osh was three years ago and I took a few pics (should have taken more and also taken some measurements), so I am sending (today, infact) some pics of my progress and my method of securing the nose bowl. Well that is about it for now. I have a lot of questions to ask but will work on them later. I can't believe I have been at this since 1973. Fortunately, I am in pretty good health and there is light at the end of the runway. I'm not giving up! Regards to all, Robert Clayton

**"BOGEY!"**  
**"BOGEY!"**  
**"BOGEY!"**

by:  
 Marion A. Smallwood

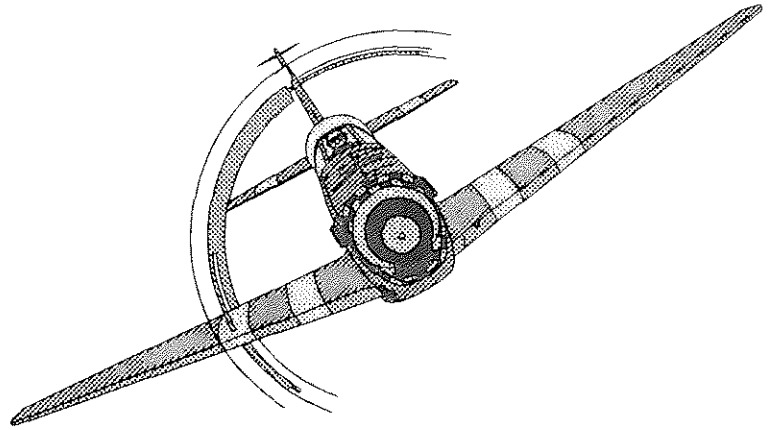

As many of you know, I bought the Dawson Thorp T-18SP, a single place retract, shown in the 1994 winter bulletin with the V-6 T-18 and several other attention-grabbing T18's at Kentucky Dam.

I was initially suspicious of the O-320 in the airplane. But beyond suspicion I wanted climb power and effortless cruise with smooth safe performance, knowing for sure what was inside the engine of such a high wing loaded airplane. So, I acquired a VO-360 A1B vertical Brantly helicopter engine for certified rebuild to replace the O-320. Since it had been flying for several hundred hours I thought it was safe enough for checkout. But, that 200 mph low pass at Kentucky Dam came back to haunt me. The O-320 turned out to have three unrepairable cylinders. Although it appeared excellent to the eye, the crankshaft had cracks on the-main bearing surface and small cracks on the side of the first journal. There was end play wear which allowed pressure on the front seal from any possible reverse thrust. Five lifters and gears were bad as well. The cam and rods made it, but the case, while cleaned, was not checked since the other main parts failed. Recently from log book compression data and first compression data I estimate the O-320 was putting out 125 hp instead of 150 hp.

There was a lot of research involving the O-320 from the T-18SP to see if it could be rebuilt worth the money for resale. No matter how I figured it, after I found four O-320 cylinders already machined for \$1000, the O-320 only made sense for an individual to build it up for himself, certified, at a cost of about \$8500. With no financial room for re-sale it would be trading dollars. I was offered a salvage price of about \$1700 which I will probably take after O-360 installation. Traded back for new parts, it will be crushed at Lycoming.

Some of the research was necessary just to go through part numbers that had been superseded several times in order to get a current part number, such as for rings which turned out to be standard for the O-360 and the Lycoming O-540 six cylinder. The pistons are, however, four ring with the fourth ring, a compression ring, acting as an oil scraper. I balanced the pistons and crankshaft and when two rods didn't have enough material for the AD bolt mod, I acquired a set of closely matched rods.

The engine came with an altitude adjusting carburetor and retard breaker shower of sparks mags, designated by the A1B in the VO-360-A1B. But after the Kentucky Dam conversation on mags and the engine builder's opinion, I will use the Bendix impulse mags from the 0-320. I will keep the altitude carburetor which is now yellow tagged. I like the idea of a simple carburetor leaning itself as the pseudo P51 rapidly gains altitude. Unlike a pressure carburetor, it simply leans the engine according to barometric pressure.

The prop has been disassembled and inspected and verified to be in excellent shape. The variable pitch 71" prop has a narrow blade. Following a prop discussion in Texas at Pecan Plantation I came away believing that was very appropriate for the installation and dropped my fantasy about a three-blade prop.

As if there were not enough frustration in the engine buildup delay because of a spare time deal out of hand, I became committed to getting a Defiant to replace my 195. A real nice one from an estate was sold out from under me at the last minute after I went to look at it just before the Texas fly-in. It was like a factory made aircraft, but I learned from the FBO line chief it had a prop strike. The prop had been mysteriously repaired and put back on the aircraft without a log book entry. (Lycoming says an engine MUST come down for inspection after any prop strike.) The widow wanted to check it out before accepting a deposit and lower offer. As a result, the A & P who was to annual the airplane bought it out from under me. He was alleged to have been a friend of the builder.

Last year after Kentucky Dam I had flown a Defiant which belonged to a gentleman who has built three Thorps and owned two Defiants. He was going to take my 195 on his Defiant, but sold it for cash and told me afterwards. So, after a year of this I have decided to reject the Defiants as part of a learning experience, especially since I realized in the process I was actually going to give up the 195 after 21 years, a roomy cabin "Businessliner" with cockpit room like the DC3.

I have learned there is no end to the "rest of the story" on Lycoming engines. There are many important details not covered in the service manuals and always "something else." There may be some late AD or late Service Bulletin just out that may affect a lot of variables in the overall picture. For example, the recent Service Bulletin on rust in a hollow crank has not only cost individuals a lot, but has driven up prices overall. It is motivating some greedy individuals to falsify yellow tags on red tagged crankshafts, according to an FAA repair station manager.

It would be very difficult for a homebuilder to know he is keeping up with all of this. An A&P of our own suggests the best thing to do is have your engine built by or in cooperation with a quality FAA repair station engine shop. Perhaps you can follow the engine closely as they build or help you build your engine. Yes, more money, but it may be excellent insurance money. I trust you would make your deal so it doesn't take as long as did mine!

But, unless a homebuilder of an engine has been intensively involved in engine building, and is therefore humble, he may not be aware of all the nuances necessary for safe engine building for himself, "a loved one"...or, of course, his family and friends for that matter. *'I Mean, I Mean,'* after all those building hours the bird is a "loved one"...even to the family who too made sacrifices to its construction.

Even though I'm not a builder, Mr. Dawson proudly built a one-of-a-kind bird that fit my fantasies for which he gave; much credit and appreciation to John Thorp in a letter in 1972.

If I'm relatively safe with the big Jake in the 195 with a feel like a B-17 ... well, Beech 18 anyway, then I choose to build an 0-360 certified airworthy engine rather than a certified for experimental for a feeling of safety as I fly the Thorp pseudo P-51 looking for another 195 to escort, or a squadron of Thorps to join ... if they don't scatter for safety, announcing "Bogey" on the radio.

Marion S. Smallwood, ED. D. R2 B327, Lowell, AR 72745 Phone, 501/756-6565

## Classic Sport Aircraft Update

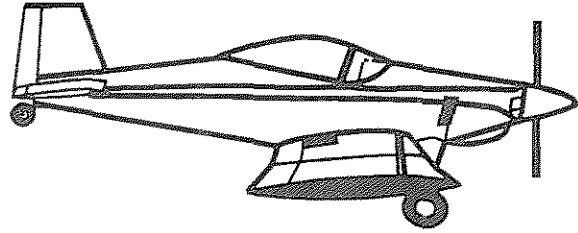

Date: October 28, 1996

Hi again from Classic Sport Aircraft (CSA). We just returned from the EAA Copperstate Fly-In and had a great time, met lots of builders and potential builders. There were 4 Thorps at Copperstate - 3 ea T-18's and 1 ea. S-18. It would be great if more Thorp owners could fly to more of the fly-in's so that Thorps are well represented.

We have been very busy building and shipping parts - perhaps not quite as fast as everyone would like, but we are making progress and are continuing to set up new suppliers.

1. We are now shipping the canopy frames in three pieces with pieces of tubing supplied for adjustment and connecting them together (no welding required). The best part is they can be shipped UPS which saves a great deal of cost over a truck delivery.
2. We are also working on kits. We are planning on being able to supply kits in time for Sun & Fun.
3. Working on a Logo so we can get some shirts, patches and hats made. We have had many requests for these items.
4. What do all of you think about having a 'special name' for the S-18—NOT Wide Body, but a good name like the T-18 is the Tiger, so let's hear from some of you with some suggestions. E-mail is [TI8Thorp@AOL.COM](mailto:TI8Thorp@AOL.COM) or drop us a line.

One of our goals is to update previous drawing changes or clarify items listed. We will start including these in the Newsletter for all to see. Anyone requiring information, please don't hesitate to call or drop a line.

Drawing #859 has an angle not identified. It is P/N A580-16-2. A bracket riveted to the underside of 669 opposite the canopy rails. For added support add a second bracket A580-16-2 just forward of Station 119.0. See picture on the next page.

Also, we are negotiating for canopy prices. Anyone ready and needing a canopy, please call. A larger order at one time will help the cost for everyone. LET'S HEAR FROM YOU!!

Mike & Phil  
Frankie & Phyllis  
Phone: 209-539-2755



Mike & Phil  
Frankie & Phyllis.

ANGLE ON 859 DRAWING.  
SECOND A580-16-2

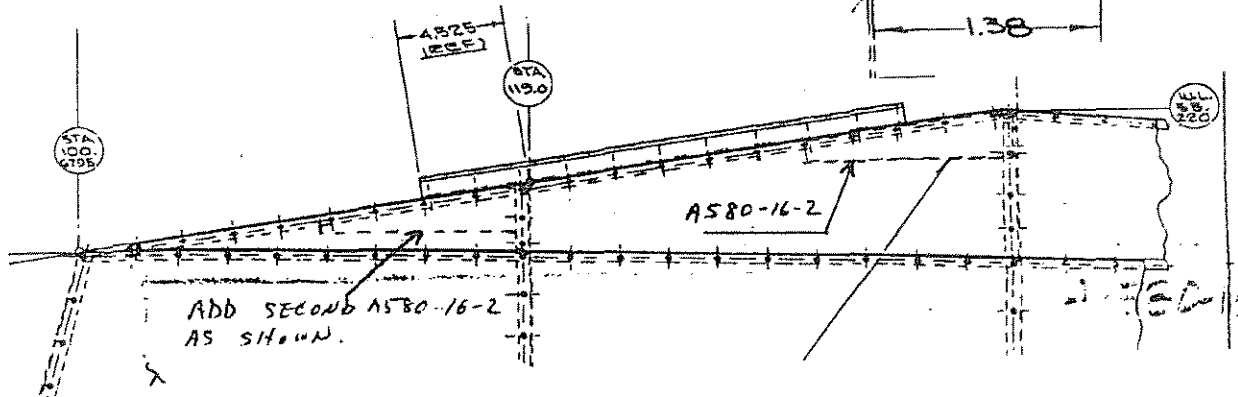
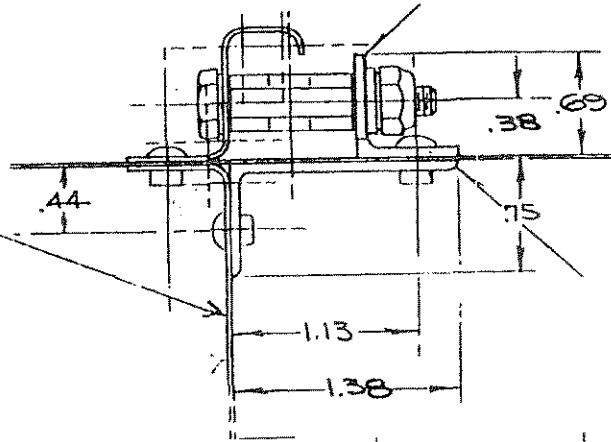

## FOR SALE

### T-18 Parts for Sale:

- Walking Beam complete 550
- Sockets 552 (2)
- Plates 553 (4)
- Bushings 554 (2)
- Beam Assembly 551
- 2 Link
- Available: Main beam parts,
- 522 Fittings (2)
- 556 Control Mountings (2)
- 4 Spacers (2)
- 5 Fittings (2)
- 537 Main beam inner wing, miss drilled holes in top of spar.
- All parts from damaged T-18, used \$150 all plus shipping

Elmer Hymen  
201-444-7432

### Parts for Sale:

- Set of Plans, standard body
- set of ribs, fiberglass wing tips, Horiz tail spar & doubler, fiberglass horz tail tips, fuel tank, nose bowl, prop spinner, main wing spar ext. & web.
- S/S firewall, aileron counter weights & arms.
- main wing fittings for spar to outer wing, outer wing spar material, rudder peddals, control stick socket fittings, aileron bell cranks, main wing to fuselage attach brackets, aileron & flap ribs, some trailing edge tapered ext. material. various Alum. angles & piano hinge, windshield rollover bar and other stiffeners and fittings. Price for the lot is \$2500 or best offer.

### Other items not included above:

- 1 New Carb air box. \$145
- Set of 500x5 Goodyear wheels/brakes & axles \$225

Contact Jim Putney 1707 W. Lavender Ln.  
Arlington, TX 76013  
Phone: 817-469-9391

*Will The "REAL"*

***BILL ESSENBURG***

*Please standup*



*Will the real Bill Essenburg please standup? Here he is folks!  
Ok, so your editor and a couple of other folks made a mistake.*

**A letter from the real Bill Essenburg.**

Dear Richard, As usual when I receive the T-18 Newsletter I read it from cover to cover, non stop. I was pleased to see a picture of me (receiving an award) and of my airplane! What a handsome guy and pretty airplane--except that's not me and that's not my plane!

I was there with N77AJ but that good looking gentleman is someone else. No problem. My wife and I had a good chuckle.

You're doing a great job on the newsletter. I enjoyed Oshkosh and the forum a lot. It sure was fun to fly my T-18 there for the first of what will be many trips to Oshkosh.

I'd still be glad to discuss plans for a T-18 fly-in at Viroqua, WI (V-51). We have a nice airport friendly town, beautiful countryside and a Super 8 Motel with a pool. Enclosed is a crowded picture of me and N77AK at Oshkosh. Now find out who the other guy is! Sincerely, Bill Essenburg. **Who Was That Guy????**

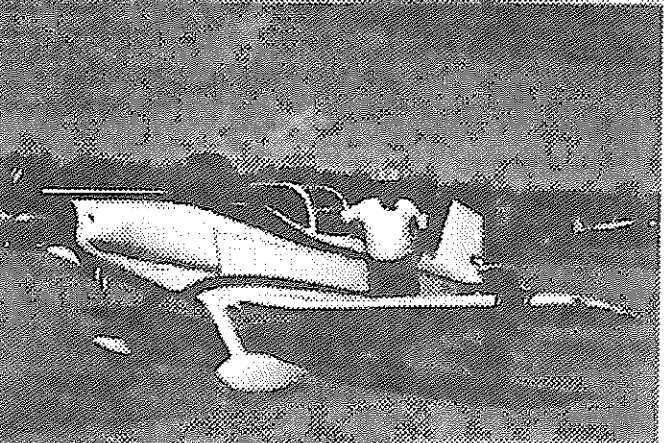
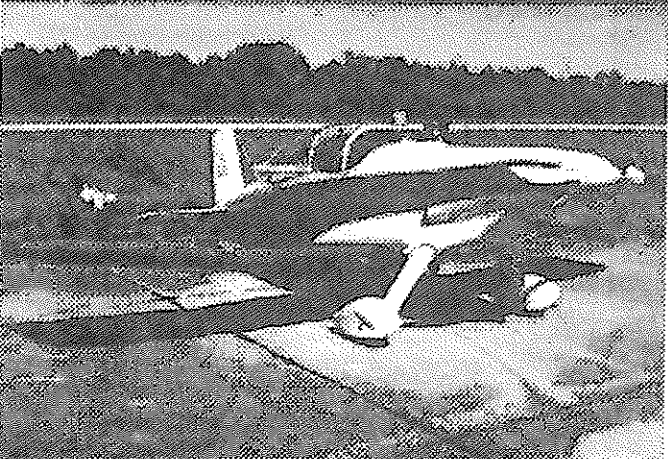
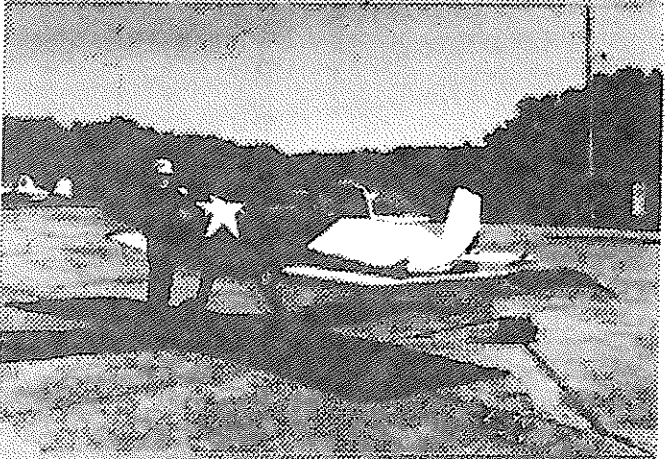
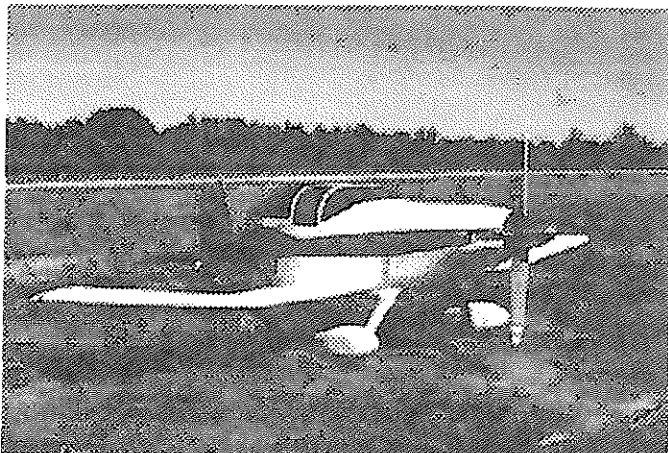
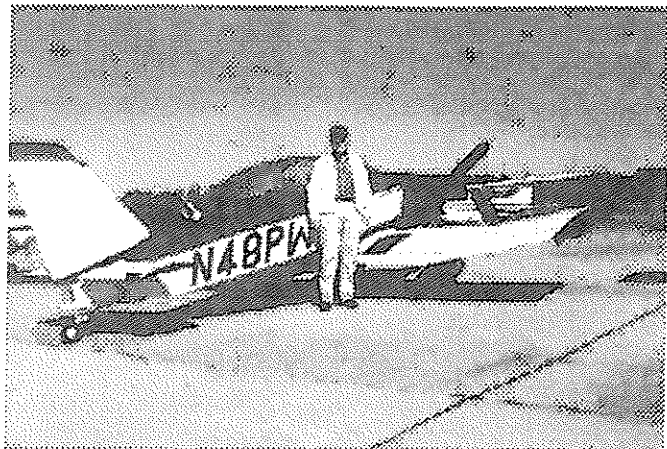

K  
E  
N  
T  
U  
C  
K  
Y  
  
D  
A  
M

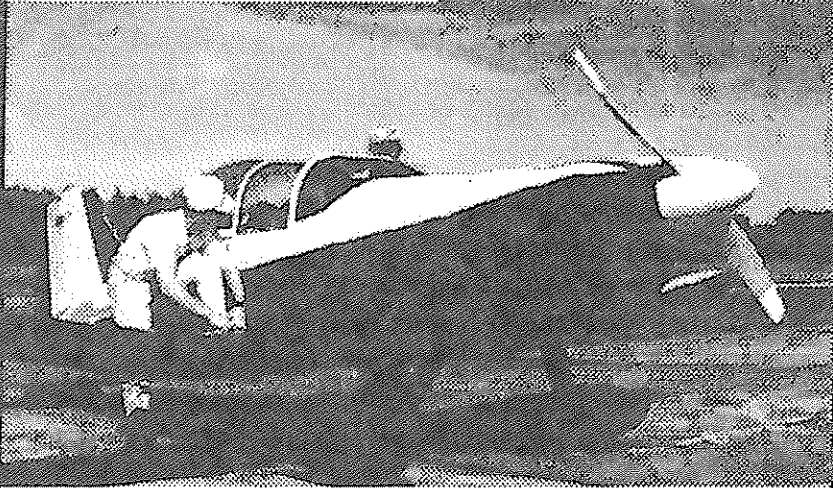

1  
9  
9  
6

T-18 NEWSLETTER  
ROUTE 3, BOX 295  
CLINTON, IL 61727  
1-217-935-4215  
Issue #101, Dec. 96

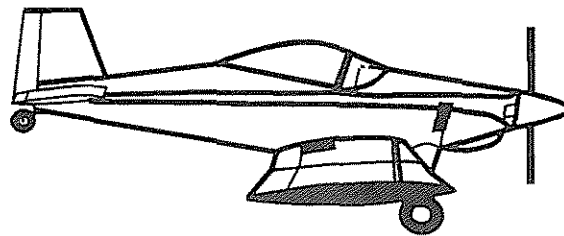

The folks at Sun'n Fun (April 6-12, 1997) plan to award the first ever "John Thorp Trophy". The winning Thorp will be selected from the flight line and the award made at a Thursday (April 10) evening John Thorp Award Dinner. The red carpet is out for T-18/S-18s folks so lets have a great turnout. The dinner is \$10 per person and please R.S.V.P. to Bill Williams c/o Sun N Fun, P.O. Box 6750, Lakeland, FL 33807-6750 by April 1, 1997.

**THORP T-18/S-18 MUTUAL AID SOCIETY 1997 DUES**

Please continue your support of this valuable exchange of ideas, building tips and safety information covering John Thorp's great design. Make checks payable to Richard Snelson, Route 3 Box 295, Clinton, IL 61727 \$25.00 US, \$30.00 other.

Name: \_\_\_\_\_  
 Address \_\_\_\_\_  
 City: \_\_\_\_\_ State \_\_\_\_\_ Zip Code: \_\_\_\_\_  
 Phone: \_\_\_\_\_  
 Aircraft: \_\_\_\_\_ Hours on Aircraft: \_\_\_\_\_  
 Email address: \_\_\_\_\_  
 Notes: (Building?, Flying?, Thinking about it?etc.) \_\_\_\_\_

**Please help by sending your dues in now!**