

TROUBLESHOOTING

If normal function of the product is disturbed or interrupted, strong electro-magnetic interference may be causing the issue. To reset product, turn the head and body completely off, then turn it back on. If normal operation does not resume, move the product to another location and try again. To ensure normal performance, charge the batteries, as low batteries may not allow full function.

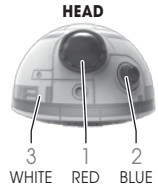

CONDITION	RED LED 1	BLUE LED 2	WHITE LED (VR) 3
Low Battery (Head)	X	Flashing - 1Hz	OFF
Low Battery (Body)	Flashing - 1 Hz	X	OFF
System Error	Flashing - 2Hz	Flashing - 2Hz	Flashing - 2Hz

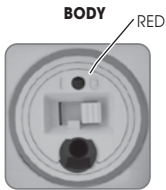

CONDITION	RED LED 1
Head & Body Not Linked	Fast Flashing
Low Battery (Body)	Flashing - 1Hz

TIP: If BB-8 is acting up, try a reset. Turn body and head completely off, then turn both power switches back on. If this does not work make sure the head and body are fully charged then try again.

IMPORTANT INFORMATION

Remove all packaging before use. Retain this information, addresses and phone numbers for future reference. Please read User Instruction Guide for additional important information. Content may vary from pictures. An adult should periodically check this toy to ensure no damage or hazards exist, if so, remove from use. Children should be supervised during play. Keep away from obstacles and electrical hazards.

CARE AND MAINTENANCE

Always remove batteries from the controller when it is not being used for a long period of time (controller/charger only). Wipe the toy gently with a clean damp cloth. Keep the toy away from direct heat. Do not submerge the toy in water. This can damage the electronic assemblies. Turn off the power on the controller when not in use.

Charge the main body (NiMH battery) every 6 months for battery maintenance.

TM & © Spin Master Ltd. All rights reserved.
Tous droits réservés.
SPIN MASTER LTD., 450 FRONT STREET WEST,
TORONTO, ON M5V 1B6 CANADA

Imported into EU by/Importé dans l'UE par
SPIN MASTER INTERNATIONAL, S.A.R.L., 20 RUE DES PEUPLIERS, L-2328, LUXEMBOURG
Customer Service: 1-800-622-8339 Email: customercare@spinmaster.com

© & ™ Lucasfilm Ltd.

www.starwars.com

T52116_0001_20073849_NEN_IS_R3

For additional help videos,
go to www.herodroidbb8.com



STAR WARS

HERO DROID BB-8

! CAUTION-ELECTRIC TOY

– Not recommended for children under 6 years of age. As with all electric products, precautions should be observed during the handling and use to prevent electric shock.

RESPONDS TO ENGLISH ONLY

3x AAA(LR03)
1.5V 1.5V
BATTERIES NOT INCLUDED

1x Ni-MH 1800mAh
BATTERY INCLUDED

1x 400mAh/3.7V Lipo
BATTERY INCLUDED

! WARNING:
CHOKING HAZARD – Small parts. Not for children under 3 years. Adapter cord could be a strangulation hazard. This toy contains inaccessible magnets.

INSTRUCTION GUIDE



! CAUTION: This toy contains inaccessible magnets. Keep away from electronic and medical devices. Exposed magnets, if inhaled or swallowed can stick together or to other metal objects, and cause serious or fatal injury.

DO NOT RETURN TO THE STORE.

NORTH AMERICA – 1-800-622-8339,
CUSTOMERCARE@SPINMASTER.COM

WWW.SPINMASTER.COM



www.starwars.com



TABLE OF CONTENTS

CAUTIONS.....	2
CONTENTS	3
INDICATOR LIGHTS	3
BATTERY REMOVAL & INSTALLATION	4
CHARGING (BB-8 BODY).....	5
CHARGING (BB-8 HEAD).....	6
ASSEMBLY.....	7
CHARGE PORT FUNCTIONS (BB-8 BODY)	7
CHARGE PORT FUNCTIONS (BB-8 HEAD).....	7
REMOTE CONTROL FUNCTIONS.....	8
GET STARTED.....	9
PLAY MODES.....	9
REMOTE CONTROL MODE	9
VOICE COMMAND MODE.....	9
FOLLOW ME	10
BB-8 MOODS	10
ANIMATION BUTTON	10
SLEEP MODE	10
FCC INFORMATION.....	11
SAFETY INFORMATION	11
TROUBLE SHOOTING	12
IMPORTANT INFORMATION.....	12
CARE AND MAINTENANCE	12

CAUTIONS

Before first use: Read the user's information together with your child.

INDOOR TOY.

⚠ CAUTION: Using item outdoors may cause damage to surface finish and function. Use on smooth level surface. Do not use near or on incline. Do not use near or on stairs. Abrasive surfaces will damage product.

Special Note to Adults: Regularly examine for damage to the plug, enclosure and other parts. In the event of any damage, the toy must not be used with the controller until the damage has been repaired.

NOTE: If normal function of the product is disturbed or interrupted, strong electromagnetic interference may be causing the issue. To reset product, turn it completely off, then turn it back on. If normal operation does not resume, move the product to another location and try again. To ensure normal performance, change or re-charge the batteries, as low batteries may not allow full function.

CONTENTS

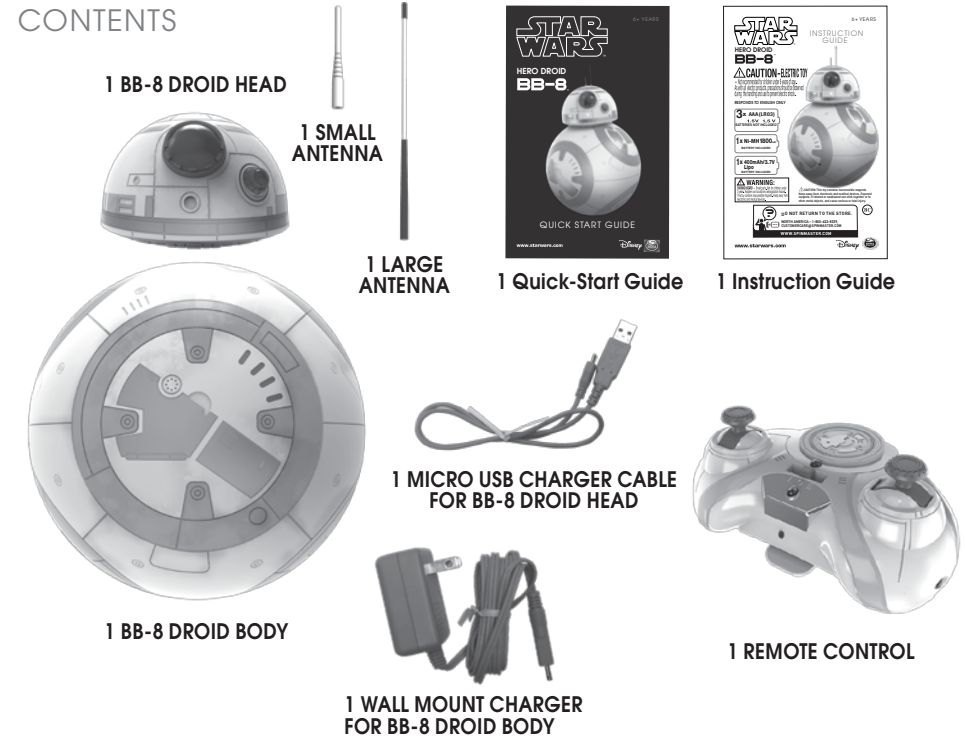

INDICATOR LIGHTS

BB-8 HEAD

RED Power Light
RED = ON
NO LIGHT = OFF

Blue Light
Indicates power status of BB-8 (see table on page 12 for details)



White Light

White = Ready for Voice Commands

NO Light = Not ready for Voice Commands

TIP: Look for the WHITE LIGHT before giving BB-8 voice commands!

BB-8 BODY

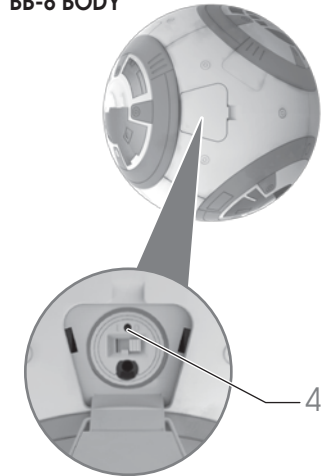

4. RED LIGHT - ON indicates that there is power to the Droid's body. OFF indicates that there is no power to the Droid's body.

BATTERY REMOVAL AND INSTALLATION

1. Locate the battery door on the remote control.
2. Open the battery door with a philips screwdriver (not included). If used or spent batteries are present, remove these batteries from the unit by pulling up on one end of each battery. DO NOT remove or install batteries using sharp or metal tools.

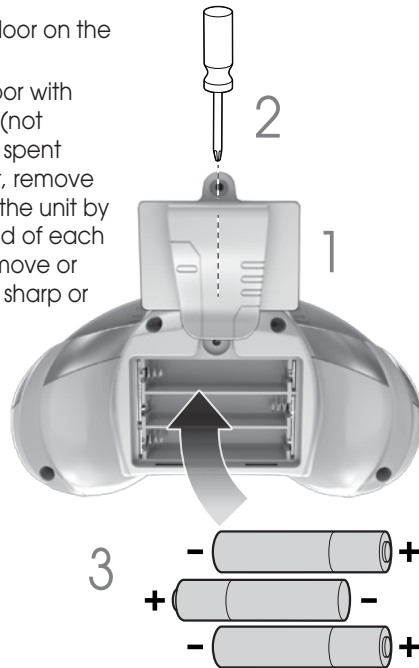

3. Install 3 new "AAA"(LR03) batteries (not included) as shown in the polarity diagram (+/-) inside the battery compartment.
4. Replace battery door securely.
5. Check your local laws and regulations for correct recycling and/or battery disposal.

Battery Safety Information:

- Requires 3 X 1.5V "AAA" (LR03) batteries (NOT INCLUDED).
- Batteries are small objects.
- Replacement of batteries must be done by adults.
- Follow the polarity (+/-) diagram in the battery compartment.
- Promptly remove dead batteries from the toy.
- Dispose of used batteries properly
- Remove batteries for prolonged storage.
- Only batteries of the same or equivalent type as recommended are to be used.
- DO NOT incinerate used batteries.
- DO NOT dispose of batteries in fire, as batteries may explode or leak.
- DO NOT mix old and new batteries or types of batteries (i.e. alkaline/standard/rechargeable).
- Using rechargeable batteries is not recommended due to possible reduced performance. Rechargeable batteries are only to be charged under adult supervision. Replaceable-rechargeable batteries are to be removed from the toy before being charged.
- DO NOT recharge non-rechargeable batteries.
- DO NOT short-circuit the supply terminals.

CHARGING (BB-8 BODY)

1. Locate the Charging Port Door on the BB-8 body section.

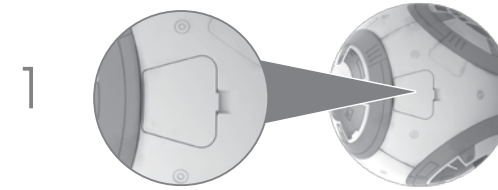

2. Open the Charging Port Door.
3. Move the Power Switch to the OFF Position. Red power indicator light will go OFF.



4. Plug the AC/DC wall mount charger (9V DC 700mA, 6.3W) into the wall outlet.
5. Plug the Charging Cord into the Charging Port in BB-8. Red Light on wall mount charger will indicate charging is in progress. No light shows in BB-8 Charging port area.

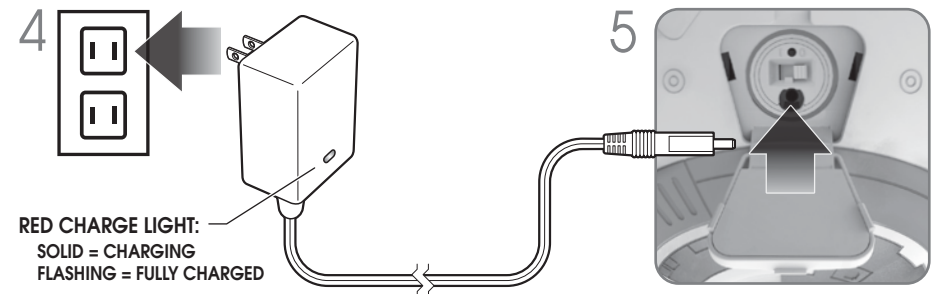

RED CHARGE LIGHT:
SOLID = CHARGING
FLASHING = FULLY CHARGED

6. Charge around 3 hours, or until red charge light flashes.
7. Unplug the Charging Cord from the Charging Port.
8. Unplug the AC/DC wall mount charger from the wall outlet.
9. Close the Charging Port Door.

NOTE: If the red light does not show on the wall mount charger make sure the plug is fully inserted into the charge port and the power switch on the body is set to the OFF position.

Alternative Charges



Europe/ Korea



Australia



United Kingdom

CHARGING (BB-8 HEAD)

1. Locate the Charging Port Door on the BB-8 head section.

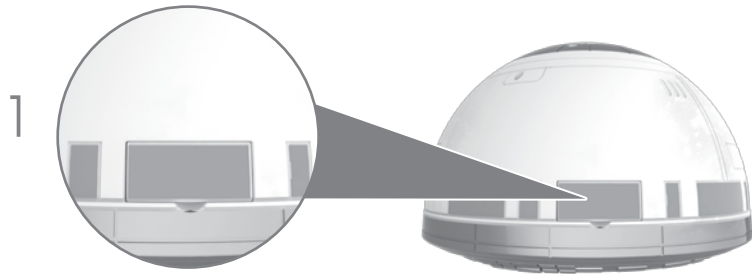

2. Open the Charging Port Door.
3. Move the Power Switch to the OFF Position. Charging indicator light will go OFF.

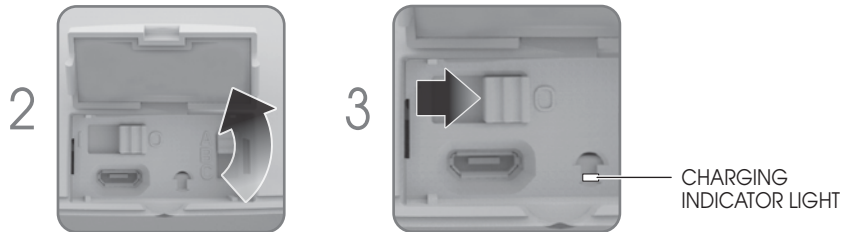

4. Plug the micro USB cable into the Charging Port.
5. Plug the USB Cable into an appropriate source. RED Light will indicate charging is in progress. GREEN Light will indicate full charge.

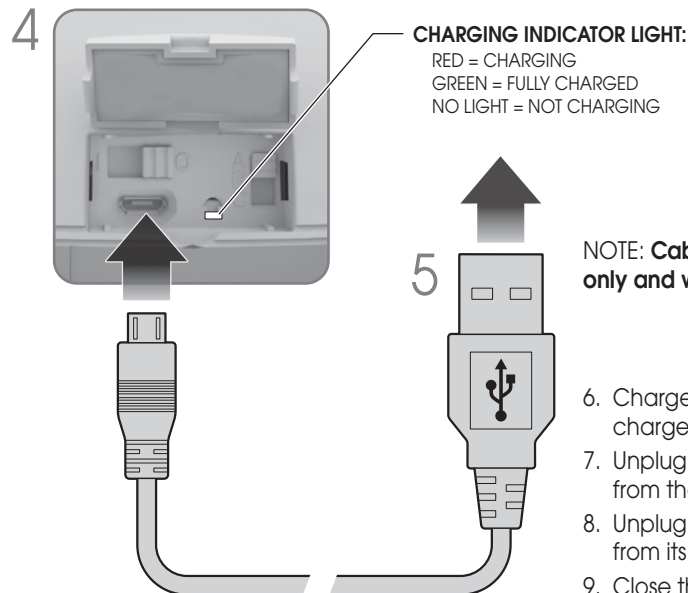

NOTE: Cable is for charging only and will NOT transfer data.

6. Charge around 1 hour, or until charge light turns GREEN.
7. Unplug the micro USB cable from the Charging Port.
8. Unplug the USB Cable from its source.
9. Close the Charging Port Door.

ASSEMBLY

1. Connect the Antenna to the Top of BB-8.
2. Place BB-8 head on top of the body.
3. Assembly complete.

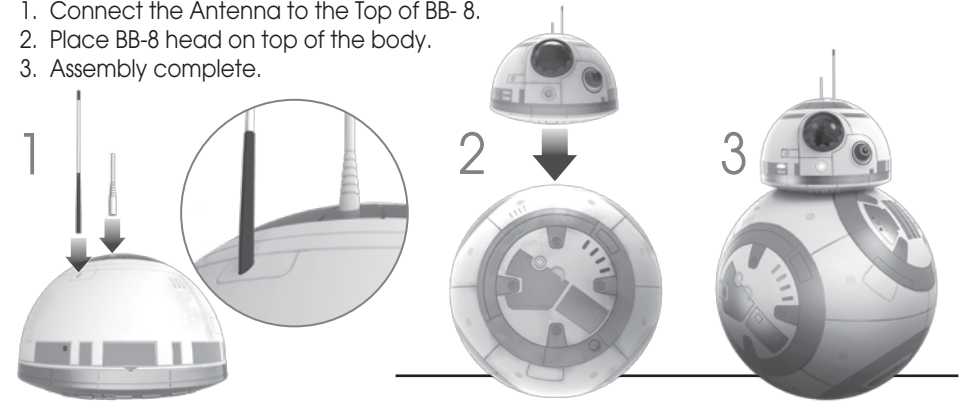

NOTE: You may need to twist BB-8's head to lock it into place. If BB-8's head is not locked into position it will lean to the side and the head may fall off easily.

CHARGE PORT FUNCTIONS (BB-8 DROID BODY)

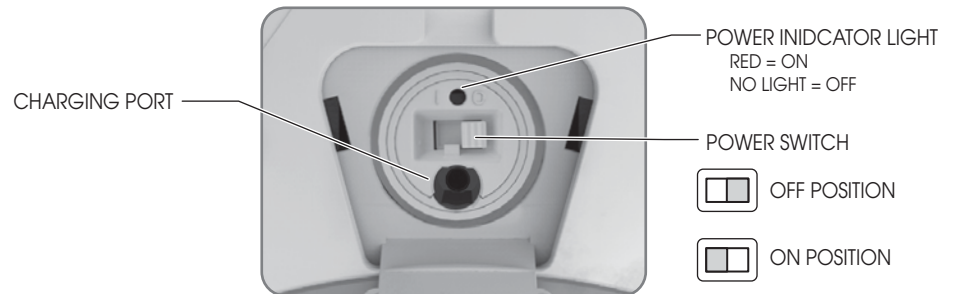

CHARGE PORT FUNCTIONS (BB-8 DROID HEAD)

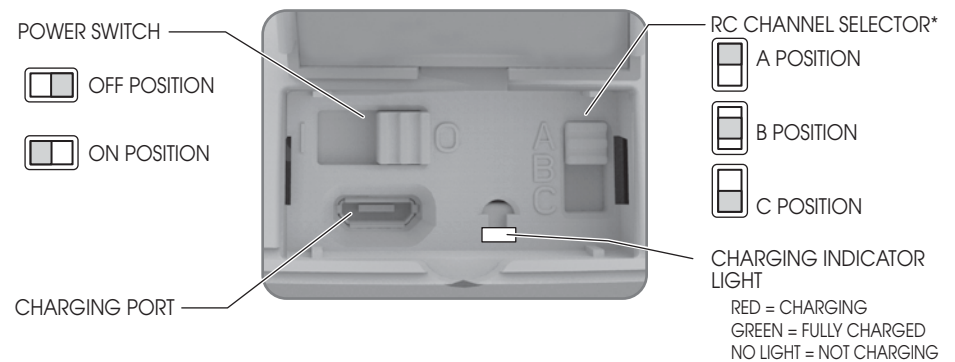

*The RC CHANNEL SELECTOR must be in the same position as on the REMOTE CONTROL. It may be changed to a different channel when playing with a friend who has another BB-8, or similar product. This will let you maintain control of your BB-8 and not interfere with the other BB-8.

REMOTE CONTROL FUNCTIONS FRONT SIDE

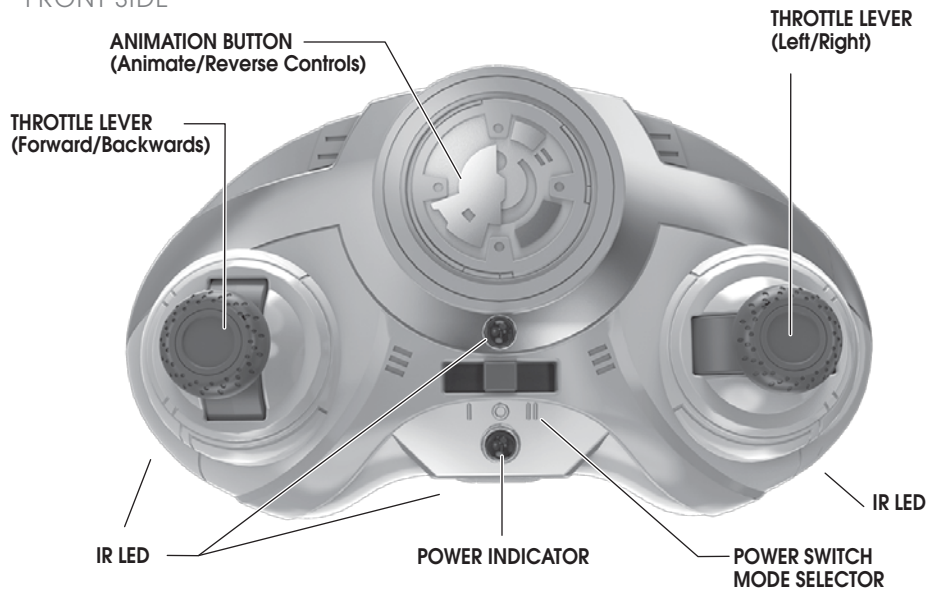

NOTE: To Animate BB-8 press the animation button once. To reverse controls press and hold the animation button for 2 seconds.

- RC MODE
- OFF (VOICE COMMAND MODE)
- FOLLOW ME MODE

REMOTE CONTROL REAR SIDE

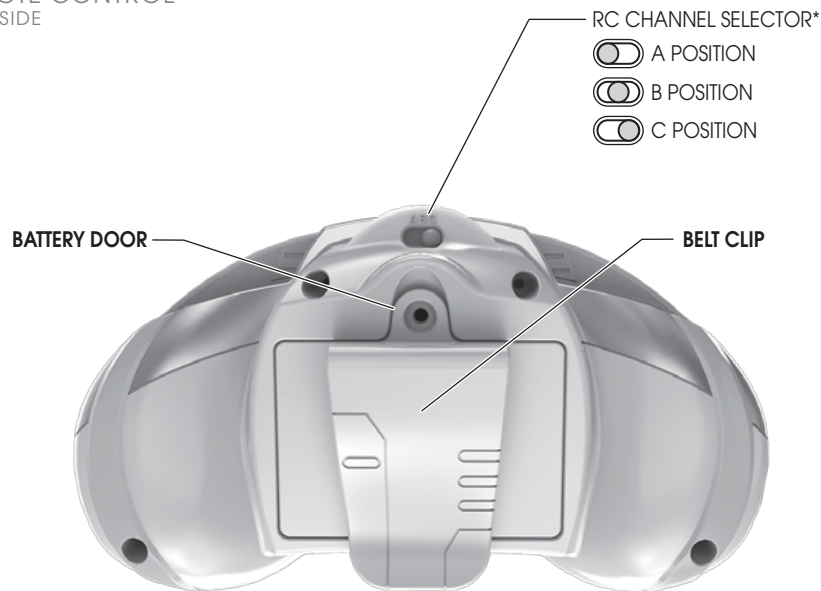

GET STARTED

1. Open the Charging Port Door on the BB-8 Droid body.
2. Move the Power Switch to the ON position. Red power indicator light will go ON. Close the Charge Port Door.
3. Open the Charging Port Door on the BB-8 Droid head.
4. Move the Power Switch to the ON position. Red power light will go ON. Close the Charge Port Door.
5. BB-8 will calibrate before normal play modes begin.



NOTE: **Keep BB-8 still and on a flat surface when powering on.**

PLAY MODES

BB-8 has 3 PLAY MODES:

- REMOTE CONTROL (RC) - Direct control of BB-8's movements
- VOICE COMMAND FOLLOW ME - Verbally interact with BB-8
- BB-8 will follow you

REMOTE CONTROL MODE

1. Set the Remote Control to RC Mode.
2. Move the Throttle to move BB-8.



NOTE: **Maintain a distance within 40 feet, between the Remote Control and BB-8.**

VOICE COMMAND MODE

1. Turn the remote OFF while BB-8 is powered ON.
2. White light indicates that BB-8 is listening for Voice Commands.
3. Speak clearly to BB-8, using the phrases listed at right. Await BB-8's reactions.

BB-8	COME HERE - CLOSER
HELLO	STORMTROOPER
KYLO REN	STAND GUARD*
MOVE BALL	WHERE IS POE?
GO TO SLEEP	HAVE YOU SEEN REY?
HOW ARE YOU?	DROID PLEASE

*NOTE: BB-8 will start scanning the room for intruders. If any are detected, BB-8 will alert you.

RESPONDS TO ENGLISH ONLY



FOLLOW ME MODE

1. Clip the Remote Control to your side and set to FOLLOW ME Mode.
2. Keeping controller around 5'-6'. Facing BB-8 begin walking slowly.
3. BB-8 will move toward the Remote Control.

⚠ CAUTION:

Do not walk down stairs, BB-8 will follow and could get damaged.



NOTE: Use the follow me mode only in large areas to avoid running into walls or other objects. If BB-8 stops moving towards you and begins to beep move closer so BB-8 can regain the remote control IR LED signal. Make sure you do not cover the IR LED's on the remote control.

BB-8 MOODS

BB-8 may randomly display any of the following six moods: BOLD; SAD; SASSY; HAPPY; SCARED; CURIOUS

RC/ ANIMATION BUTTON

1. Set the Remote Control to RC Mode.
2. Press the Animation Button once.
3. BB-8 will randomly animate.
4. Press and hold the Animation Button for 2 seconds.
5. BB-8's head will turn in the opposite direction.
6. The controls over BB-8 will reverse.



SLEEP MODE

1. After 3 - 5 minutes of no interaction, the Droid will go into SLEEP MODE. In SLEEP MODE, say "BB-8" to reactivate the Droid. Press the Controller's Direction Knob OR the Animation Button to reactivate.
2. After 5 minutes, the Droid will go into Power Down Mode.
3. Open both Charge Ports.
4. Move the Power Switches to the OFF Position.
5. Move the Power Switches back to the ON Position. Droid will re-activate.

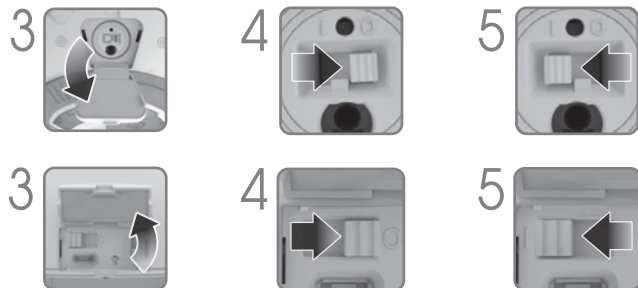

FCC STATEMENT: This product complies with Part 15 of the FCC rules. Operation is subject to the following two conditions:

(1) This device may not cause harmful interference, and (2) This device must accept any interference received, including interference that may cause undesirable operation. This equipment has been tested and found to comply with the limits for Class B digital devices pursuant to Part 15 of the FCC rules. These limits are designed to provide reasonable protection against harmful interference to radio communications. Because this toy generates, uses, and can radiate radio frequency energy, if not installed and used in accordance with the instruction, may cause harmful interference to radio communication. However there can be no guarantee that interference will not occur. If this toy does cause interference to radio or television reception (you can check this by turning the toy off and on while listening for the interference), one or more of the following measures may be useful:

- Reorient or relocate the receiving antenna
- Increase the separation between the toy and the radio or the TV
- Consult the dealer or an experienced TV-radio technician for help.

Shielded cables must be used with this unit to ensure compliance with the Class B FCC limits.

NOTE: Changes, adjustments or modifications to this unit, including but not limited to, replacement of any transmitter component (crystal, semiconductor, etc) could result in a violation of FCC rules under part 15 and/or 95 and must be expressly approved by Spin Master Ltd or they could void the user's authority to operate the equipment. Shielded cables must be used with this unit to insure compliance with the Class B FCC limits.

CANADIAN Class B statement: This device complies with Industry Canada licence-exempt RSSs standard(s). Operation is subject to the following two conditions: 1) this device may not cause interference, and 2) this device must accept any interference, including interference that may cause undesired operation of the device.

CAN ICES-3(B)/NMB-3(B)

POWER ADAPTER SAFETY INFORMATION

- The transformer is not a toy and should be connected to the wall outlet by an adult. It should be periodically examined for conditions that may result in the risk of fire, electrical shock or injury to persons, such as damage to the cord, plug, blades, housing or other parts, and in the event of such conditions, the transformer must not be used until the damage is repaired. The cord of this transformer cannot be replaced; if the cord is damaged, dispose of the transformer in accordance with your local electrical product recycling regulations.
- Transformers and power supplies for toys are not intended to be used as toys, and the use of these products by children shall be under the full supervision of parents.
- The toy must be used only with the recommended transformer.
- The toy is not to be connected to more than the recommended number of power supplies.
- Toys to be cleaned with a liquid are to be disconnected from the transformer before cleaning.
- To clean transformer, disconnect it from the wall and clean with a cloth dampened with water. Do not immerse in water or use soap or other chemicals. Allow to dry before reusing. Do not connect to the AC outlet if wet or damaged.
- AC Adapter Electrical Ratings: US, CAN Input: ~ 120V AC, 60Hz, 300mA. UK Input: ~ 240V, 50Hz. Australia and New Zealand Input: ~ 240V, 50 Hz. Output: 9V DC, 700mA
- Batteries are only to be charged by adults or by children at least 8 years old.

This toy is equipped with LiPo and NiMH batteries. SPECIAL BATTERY INSTRUCTIONS:

- Never charge battery unattended.
- Charge battery in an isolated area. Keep away from flammable materials.
- Do not expose to direct sunlight. There is a risk of the batteries exploding, overheating, or igniting.
- Do not disassemble, modify, heat, or short circuit the batteries.
- Do not place them in fires or leave them in hot places.
- Do not drop or subject to strong impacts.
- Do not allow the batteries to get wet.
- Only charge the batteries with the specified Spin Master™ battery charger.
- Only use the batteries in the device specified by Spin Master™.
- Carefully read the instruction guide and use the batteries correctly.
- In the unlikely event of leakage or explosion use sand or a chemical fire extinguisher for the battery.
- Batteries must be recycled or disposed of properly.

Special Battery Removal Instruction for LiPo, NiMH:

Product Battery Removal Instructions: Internal battery is factory installed, product disassembly and battery removal must be performed by an adult. Do not puncture, cut, tear, compress or deform product during disassembly. Ensure product is turned off, then use a screw driver to remove all screws. Separate product body halves to expose internal electronics. When battery is visible in its entirety use scissors to cut a single battery wire, immediately wrap the cut wire end with tape to isolate it, repeat until all battery wires are cut and isolated, and the battery is free from the rest of the product. Dispose of battery in accordance with your local battery recycling or disposal laws. **NOTE:** Opening of product and/or removal of battery will render product inoperative and voids manufacturer warranties, dispose of remaining product components in accordance with local laws.

www.starwars.com