

---

# CONVERTIBLE TOPS

Subject	Page
<b>E36 Convertible Tops</b>	
Overview .....	2
E36 Automatic Electro Mechanical Convertible Tops .....	4
• Features .....	4
• Components	
- Control Module .....	6
- Top Switch .....	6
- Motors .....	7
- Top Drive Linkage/Thrust Rods .....	8
- Top Cover Latches/Drive Linkage.....	8
- Micro Switches .....	9
- Components Review.....	11
• Operation .....	12
• EM Top Emergency Operation.....	17
• Re-connecting the drive motors .....	18
• EM Top Initialization .....	19
• Control Module Diagnosis/Troubleshooting.....	20
• Convertible Top Storage Lid Position Hall Sensor Tests.....	22
• E36 Convertible Top Adjustments (Repair Manual excerpts) .....	23
• E36 Convertible Specific Service Information Bulletin Reference....	29
<b>Z3 Convertible Top</b>	
Overview .....	30
• Components .....	31
• Operation .....	32
• Adjustments .....	33
• Z3 Convertible Specific Service Information Bulletin Reference.....	35

---

# E36 CONVERTIBLE TOP

## OVERVIEW

**E36 - 318i, 323i, 325i and 328i:** The top design consists of two pivoting sections; the tension bow at the rear and the foldable top section with multiple bows.

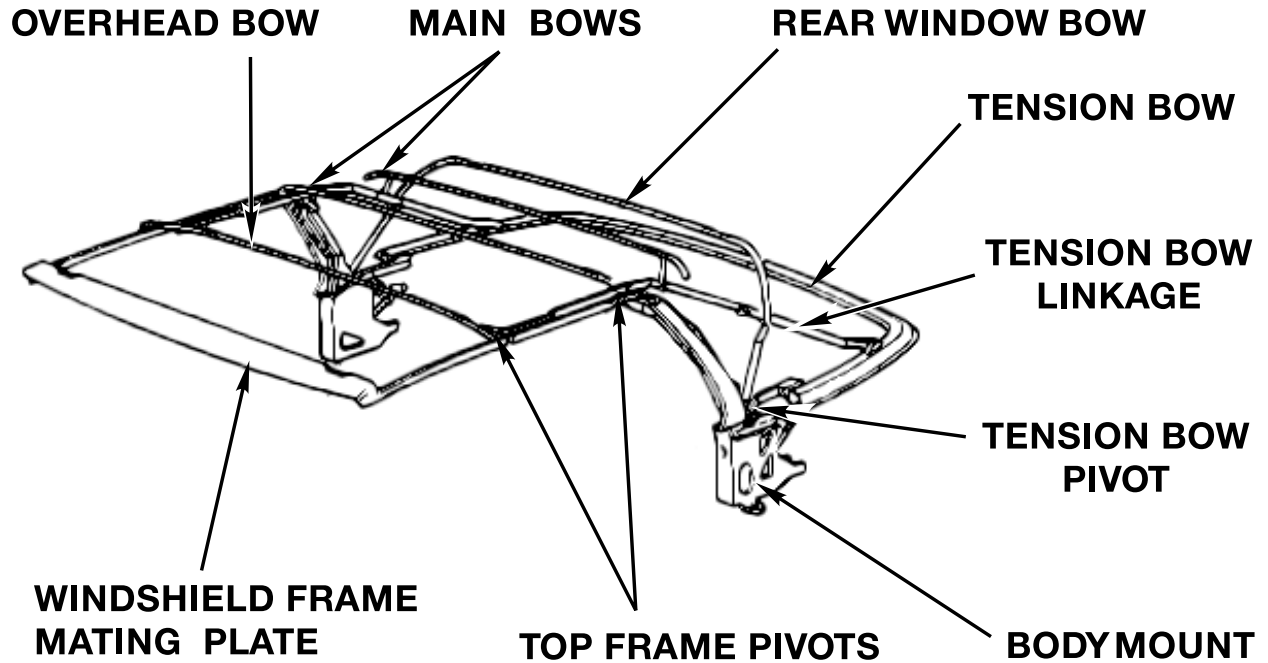

When lowered, the top is stowed in a storage well behind the rear seat. The well is covered by a hinged convertible top cover.

---

---

---

---

---

---

---

---

---

---

---

---

The E36 base convertible top is manually operated. The higher line top is an Electro Mechanical variant that has evolved through two versions:

- Semi Automatic
- Fully Automatic

The mechanical movement and sequenced steps of operation are the same for all three variations.

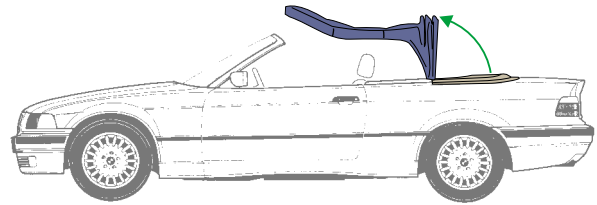
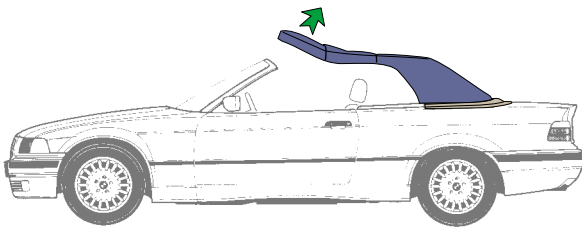

- After the windows have been lowered slightly, the top is released from windshield frame.

- The tension bow is then raised to a vertical position.

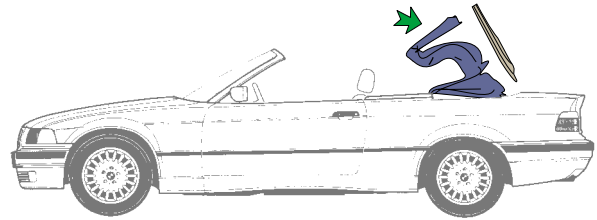
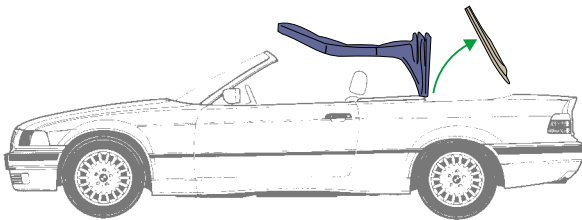

- The top cover body panel is then raised which opens the storage well for top stowage.

- The top is folded back into the storage well.

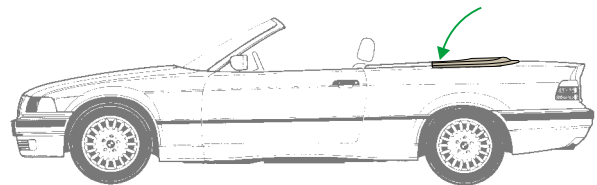
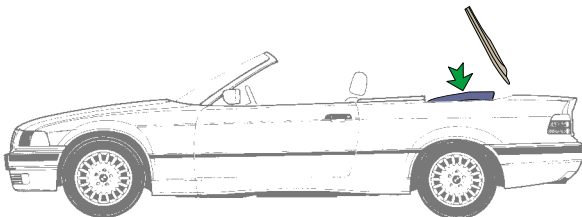

- The storage cover is then lowered and latched closed.

---

## E36 AUTOMATIC ELECTRO MECHANICAL (EM) CONVERTIBLE TOPS

The Automatic EM convertible top was introduced as a “*Semi*” Automatic in the 1994 model year. The top was upgraded to a fully automatic top in 1997. Except for a few additional components and an additional function on the fully automatic version, both systems function the same. For this reason the systems are described simultaneously and highlighted as required where differences occur.

### FEATURES

The top is designed as a self tensioning, electric mechanical power operated folding top. The main features include:

#### **BOTH VERSIONS:**

- Electrical interlock of the trunk lid when the top storage cover is unlocked or open.
- Automatic partial lowering of the four side windows when lowering or raising the top.
- Automatic full raising of all four windows once top is stored in the storage compartment.
- Fully diagnosable EM Top Control Module.
- A textile, crease free interior liner clipped to the top frame.
- Emergency release handle inside the passenger compartment, for manually raising the top with an electrical failure.
- A removable (zipper) green tinted plastic rear window.
- Soft top material of 3-ply with 40% cotton fabric lining and 100% Arcyl outer skin.

#### **SEMI AUTO ONLY:**

- A centrally located turn lock fastener on the forward edge of the top for locking and unlocking the top to the windshield frame.

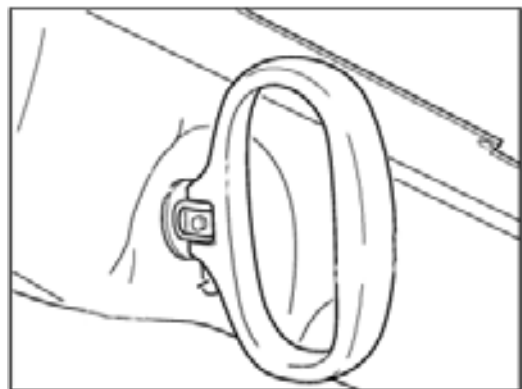



## COMPONENTS

### CONTROL MODULE:

- Located behind the left side rear seat interior quarter trim panel (1).
- All relays and operating electronics are installed in the module. The control module is fully diagnosable with the DIS or MoDiC.

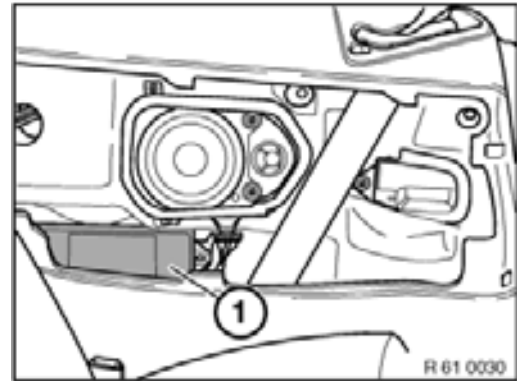

### TOP SWITCH:

- The top switch is positioned in the center console.
- The switch of the fully automatic system contains an LED that flashes when the top is not fully closed and locked to the windshield frame.

However, the LED will not flash when the top is fully stowed in the top compartment with the lid closed. Control module memory of lid position via Hall sensor.



## MOTORS:

- Top drive motor (A) with gear assembly and position micro switches (S1 & S2). The top drive motor is located under the top storage compartment on the left side of the trunk.
- Top storage cover motor (B) with drive linkage and an integrated hall sensor. The cover motor is located in the trunk on the left side behind the trim cover.

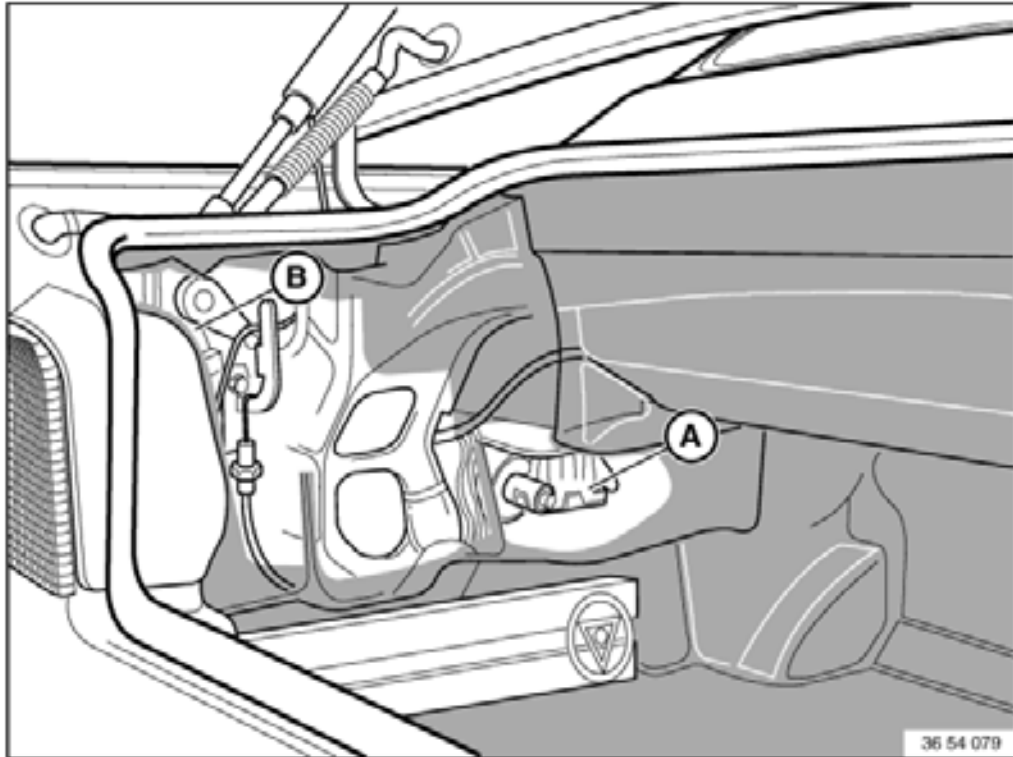

- **FULL AUTO ONLY:** Top Lock Motor with flexible drive tubes and lock drive mechanisms. The lock drive mechanisms also activate the off tension linkage rods for automatically moving the top to the off tension position.

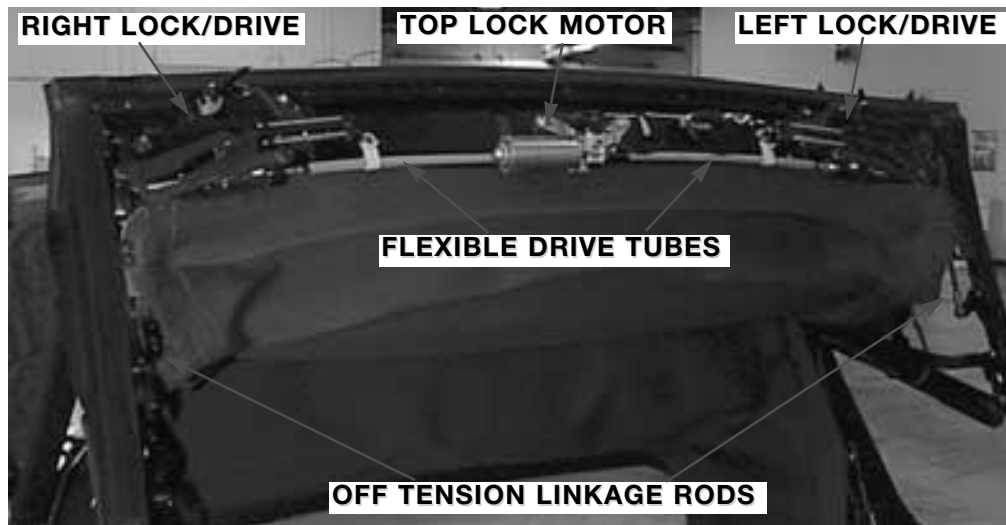

## TOP DRIVE LINKAGE/THRUST RODS:

Located in the top storage compartment on the left side are two actuating rods, one for the tension bow and the other for the top frame.

The rods are moved in a predetermined sequence based on the pivots and notches of the main drive and tension bow plates.

The top drive motor is linked to the top motor drive plate by a splined shaft.

When the motor is activated, the drive plate turns either pushing or pulling the rods to move the top to the predetermined position.

When the top is lowered into the storage well the tension bow plate completely disengages from the top motor drive plate.

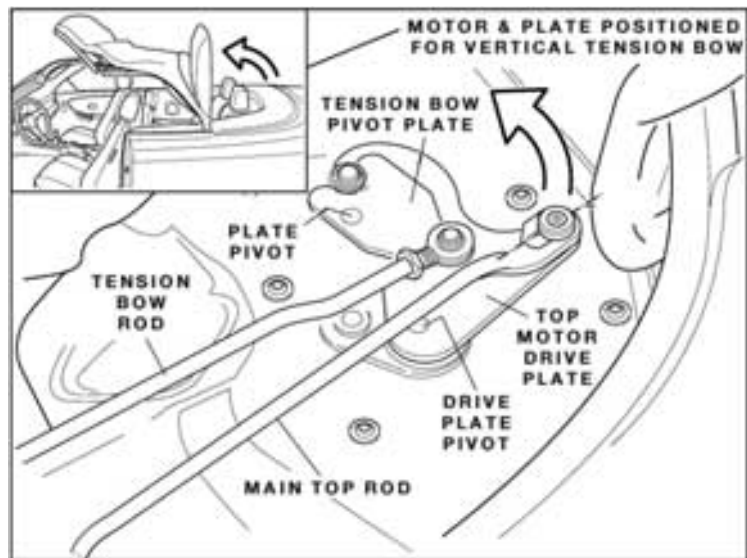
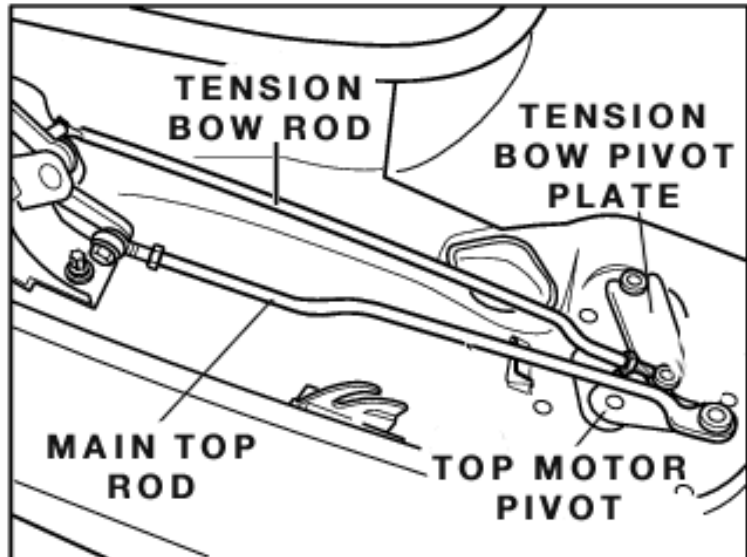

## TOP COVER LATCHES/ DRIVE LINKAGE

The convertible top cover motor unlatches the cover locks via bowden cables and raises/lowers the cover panel via a linkage rod.

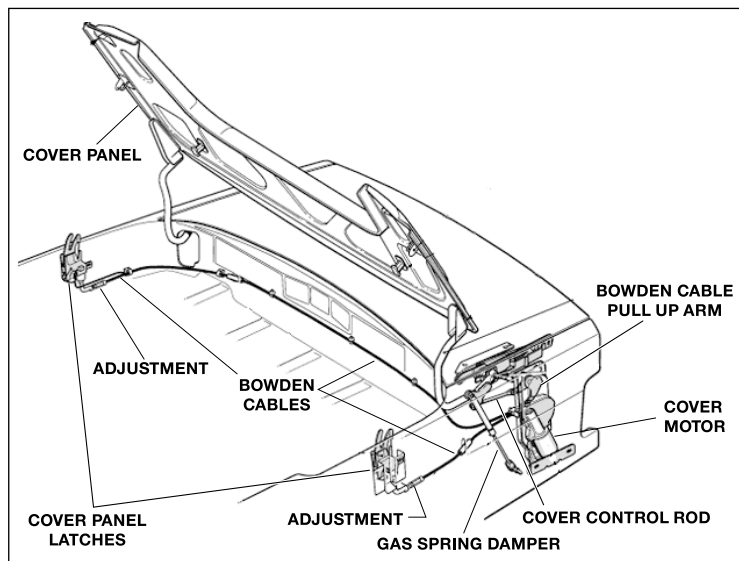



---

## MICRO SWITCHES:

### S1 - Identified as Convertible Top Position Microswitch in the ETM (Not Adjustable)

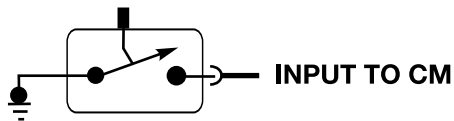

- Located on Top Motor (not adjustable)
- Open when top is fully up or fully down.
- Closed when tension bow is not horizontal.
- Open when tension bow is horizontal.

### S2 - Identified as Convertible Top Position Microswitch in the ETM (Not Adjustable)

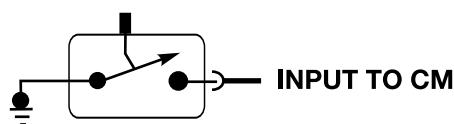

- Located on Top Motor (not adjustable)
- Open when top is fully up or fully down.
- Closed when tension bow is vertical.
- Open whenever tension bow is not vertical.

### S3 - Identified as Rear Window Blower Microswitch in the ETM (Adjustable)

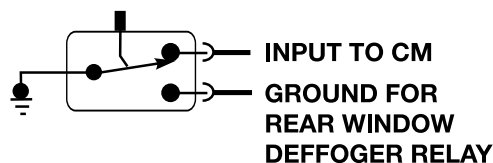

- Located in Storage Well on driver side folding top hinge assy.
- Closed when top is stored in well
- Open when top is up

This switch also provides a ground for the rear window blower when top is up.

### S4 - SEMI AUTOMATIC TOP ONLY: Identified as Convertible Top End Position Micro Switch in the ETM (Adjustable)

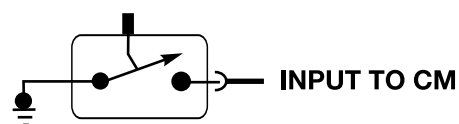

- Located on the driver side tension bow linkage arm.
- Closed when top is up and locked to windshield frame
- Open when top is pushed past tension point

---

---

---

---

---

---

---

---

### S5 - Identified as Trunk Lid Microswitch in the ETM (Not Adjustable)

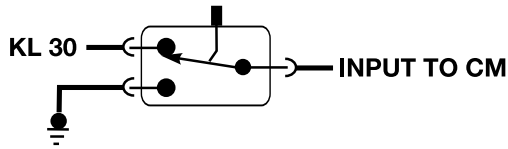

- Located on Trunk Lock. Prevents convertible top operation when trunk is open.

- S5 is also used on fully manual top. It provides a ground for the convertible top storage lid lock motor. This is a unique component only found on the manual top system which electrically prevents the storage lid from being opened manually when the trunk lid is opened.
- S5 utilization on the automatic top system provides a ground signal to the control module when the trunk is open. The control module cancels any top operation when this ground signal is present.

### S6 - Identified as Convertible Top Storage Lid Microswitch in the ETM (Adjustable)

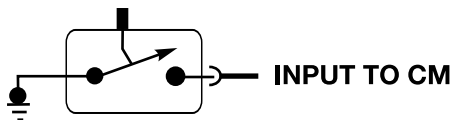

- Located on Right Side Storage Cover Lock Latch
- Signal is input to ZKE IV General Module.
- Low signal indicates convertible top storage cover is open. Trunk can not be opened.

### S7 - FULLY AUTOMATIC TOP ONLY: Identified as Position Microswitch Locking in the ETM (Not Adjustable)

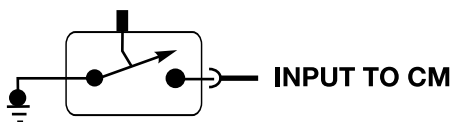

- Located on Top Lock Drive Assembly.
- Open anytime top is not locked to windshield frame.
- Closed when top is locked to windshield frame.

### S8 - FULLY AUTOMATIC TOP ONLY: Identified as Position Microswitch Unlocking in the ETM (Not Adjustable)

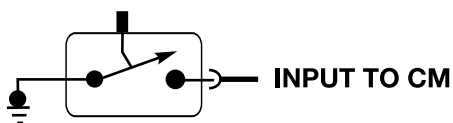

- Located on Top Lock Drive Assembly.
- Closed only when the top lock motor is driven to the fully unlocked position.
- Open all other times.



# COMPONENTS REVIEW

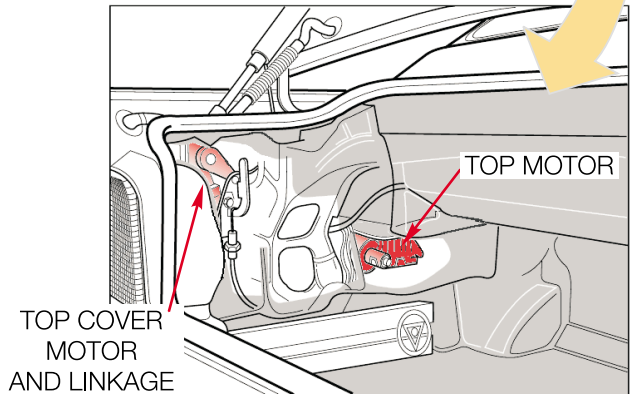
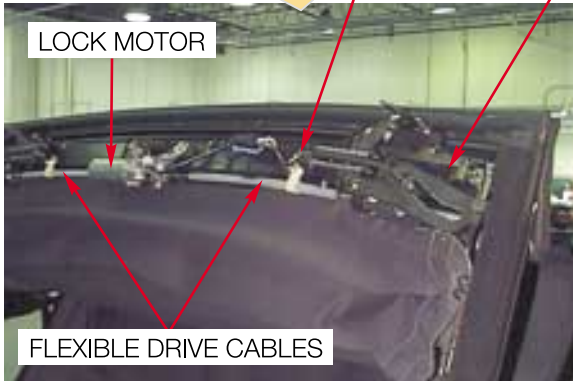
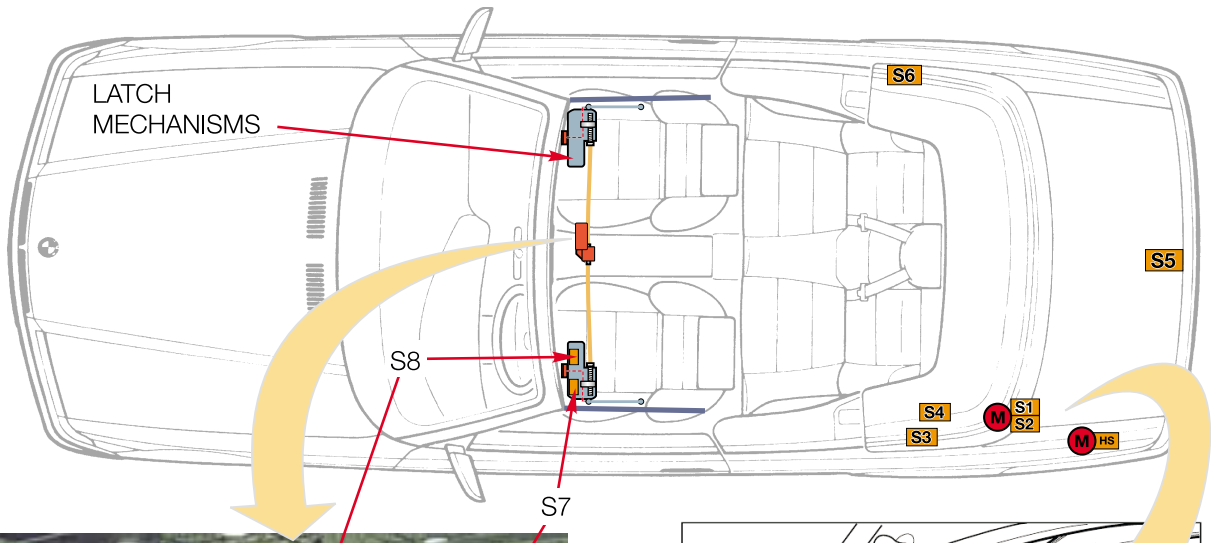
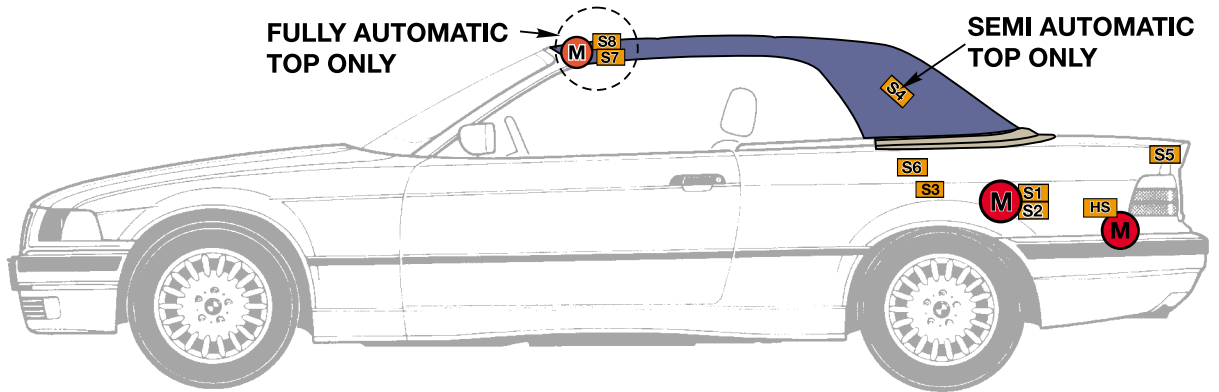

---



---



---



---



---

---

## OPERATION

The following prerequisites must be met for the top to function:

**Trunk Lid Closed** - Electrical interlock of the trunk and top. Due to the design of the top storage cover and trunk lid, damage to the cover or lid would occur if both were open at the same time.

**Ignition key switched on KL R**, (preferably engine running to prevent unnecessary battery drain)

**Vehicle stopped** (speed "A" signal <3 MPH)

**Roll over bars retracted (if equipped)** - bars interfere with the top operation as it is lowering into the storage compartment.

## LOWERING THE TOP

- **SEMI AUTOMATIC TOP ONLY** - *Unlock the top with the turn lock fastener and push the top over the tension point. S4 must close for the top to operate. Press and hold the top switch. Go to "TENSION BAR RAISED" on next page.*
- **FULLY AUTOMATIC TOP ONLY** - *Press and hold the top switch. All Side windows lower automatically regardless of their position, by a signal from the top module to the General Module (ZKE IV).*
  1. The top lock motor is powered in the unlock direction.
  2. The left and right side locks are mechanically released via the drive cables.
  3. Microswitch S7 opens indicating the top is unlatched from the windshield frame.
  4. Once the locks are completely released, the top lock motor continues to run lifting the front bow above the tension point via the tension rods.
  5. As the front bow passes the tension point, micro switch S8 closes. The top lock motor switches off and the top motor is switched ON.

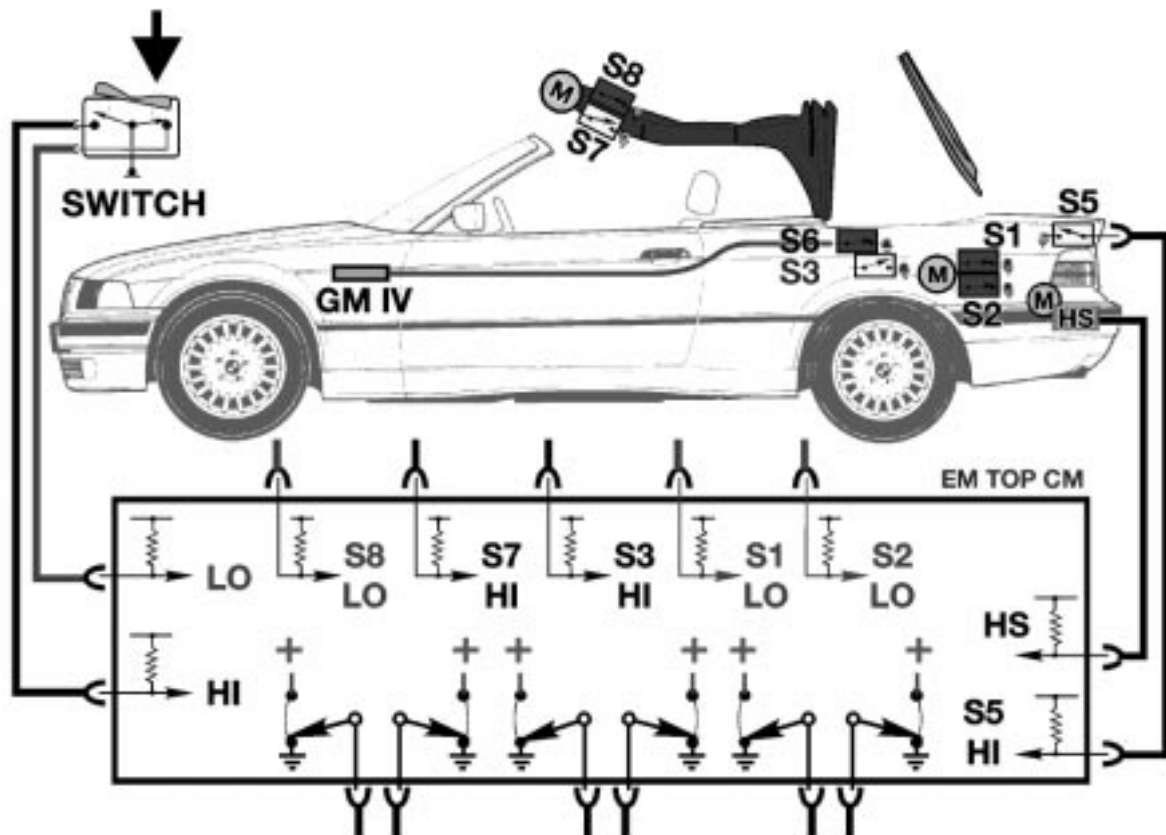

### TENSION BAR RAISED

At the same time the windows are lowering, the top drive motor is switched on and the tension bar is raised to a vertical position. The drive lever of the top linkage rotates counter clockwise to push the tension bar to a raised position.

The control module recognizes the raising of the tension bar by the closed contacts of micro switch S1 in the motor assembly.

When the tension bar has raised to the full vertical position micro switch S2 closes and the motor is switched off.

### STORAGE COVER OPENED

The top storage cover motor is switched on and turns counter-clockwise. This action releases the locks of the cover via the bowden cables. The locks are forced out of the clamps by spring pressure.

The drive linkage continues to push the cover to a raised position. A hall sensor integrated in the cover motor provides status of the storage lid movement and position to the CVM. The motor is switched off when it reaches the end of its predetermined travel.

S6 also closes the moment the storage cover is released from its locked position. The signal is provided the GM to prevent the trunk from opening.

## TOP ASSEMBLY LOWERED

The top motor turns clockwise immediately opening S1 & S2. It pulls the top into the storage compartment. The tension bar drive linkage is mechanically released from the top drive as the motor continues to run. Once the top is completely lowered microswitch S3 closes signalling the control module to switch the motor off.

## STORAGE COVER CLOSED

The storage cover motor is switched on and the drive linkage pulls the cover down. As the locking clamps grab onto the cover locks, the linkage engages the bowden cables and the cover is locked closed.

The CVM monitors the storage lid position via the hall effect sensor signal. When the fully closed position is detected, the top cover motor is switched off.

## WINDOW RAISING

If the top switch is held down after the top storage cover is closed, the windows will automatically close. The EM top module signals the ZKE to closed the windows. Once the top switch is released the window operation is terminated.

<b>E36 Fully Automatic Convertible Top Micro-Switch Logic Chart</b>								
<b>Top Position</b>	<b>S1</b>	<b>S2</b>	<b>S3</b>	<b>S5</b>	<b>S6 (GM)</b>	<b>S7</b>	<b>S8</b>	<b>Hall Sensor</b>
Top Up and locked	Hi	Hi	Hi	Hi	Hi	Lo	Hi	Not active
Switch pressed to open, top lock motor activated	Hi	Hi	Hi	Hi	Hi	Hi	Hi	Not active
Front of top automatically raised past tension point	Hi	Hi	Hi	Hi	Hi	Hi	Lo	Not active
Tension Bow Raising	Lo	Hi	Hi	Hi	Hi	Hi	Lo	Not active
Tension Bow fully raised	Lo	Lo	Hi	Hi	Hi	Hi	Lo	Not active
Storage cover opening	Lo	Lo	Hi	Hi	Lo	Hi	Lo	<b>Active</b>
Cover opened and top lowering	Hi	Hi	Hi	Hi	Lo	Hi	Lo	Not active
Top fully lowered in storage comp.	Hi	Hi	Lo	Hi	Lo	Hi	Lo	Not active
Storage Cover Lowering	Hi	Hi	Lo	Hi	Lo	Hi	Lo	<b>Active</b>
Storage Cover Closed	Hi	Hi	Lo	Hi	Hi	Hi	Lo	Not active
Trunk opened	--	--	--	<b>Lo</b>	--	--	--	Not active

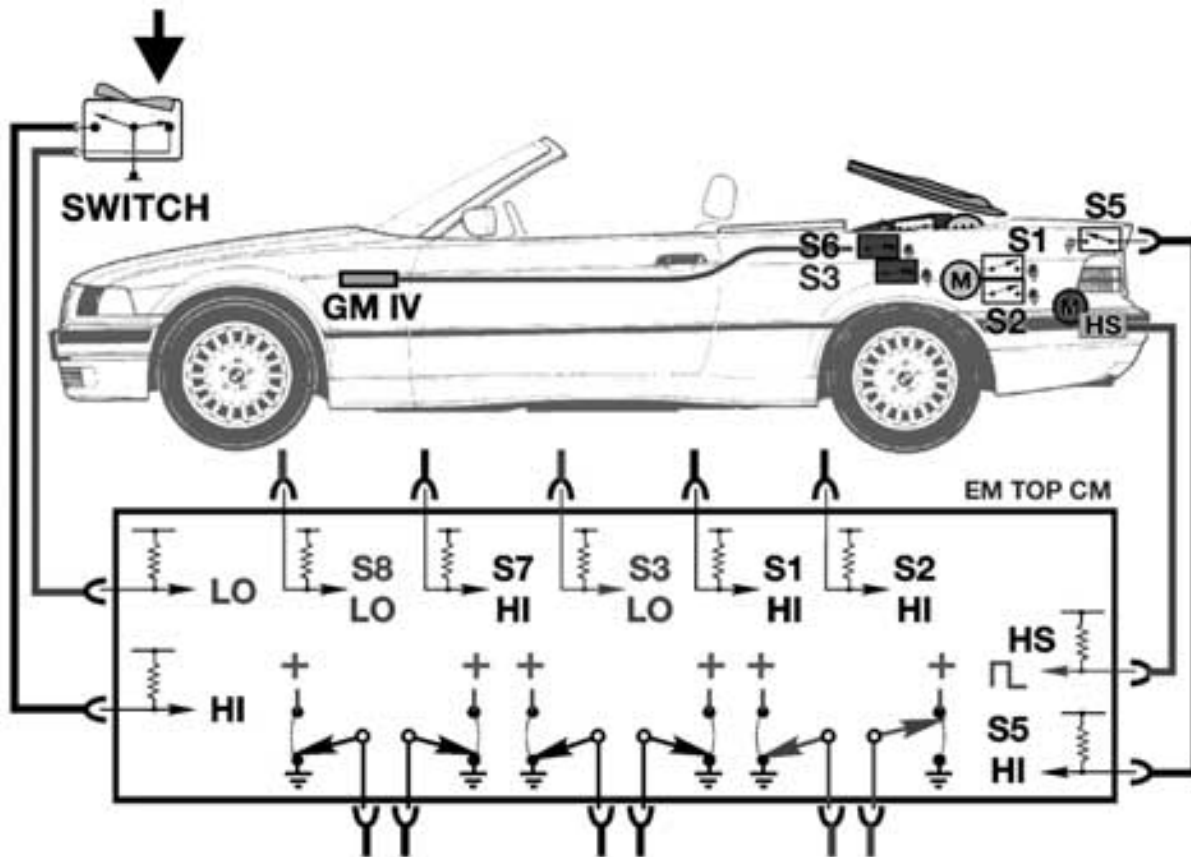

<b>E36 Semi Automatic Convertible Top Micro-Switch Logic Chart</b>							
<b>Top Position</b>	<b>S1</b>	<b>S2</b>	<b>S3</b>	<b>S4</b>	<b>S5</b>	<b>S6 (GM)</b>	<b>Hall Sensor</b>
Top Up and locked	Hi	Hi	Hi	Hi	Hi	Hi	Not active
Top Unlocked and pushed past tension point	Hi	Hi	Hi	Lo	Hi	Hi	Not active
Tension Bow Raising	Lo	Hi	Hi	Lo	Hi	Hi	Not active
Tension Bow fully raised	Lo	Lo	Hi	Lo	Hi	Hi	Not active
Storage cover opening	Lo	Lo	Hi	Lo	Hi	Lo	<b>Active</b>
Cover opened and top lowering	Hi	Hi	Hi	Lo	Hi	Lo	Not active
Top fully lowered in storage Comp.	Hi	Hi	Lo	Lo	Hi	Lo	Not active
Storage Cover Lowering	Hi	Hi	Lo	Lo	Hi	Lo	<b>Active</b>
Storage Cover Closed	Hi	Hi	Lo	Lo	Hi	Hi	Not active
Trunk opened	--	--	--	--	Lo	--	Not active

---

## RAISING THE TOP

The procedure for raising the top follows the same pattern as lowering.

Press and hold the top switch.

- The windows are automatically lowered.
- The top storage cover opens
- The top is raised out of the storage compartment
- The top storage cover is closed and locked.
- The tension bar is lowered. Micro-switch S1 signals the lowered position of the tension bar.

**FULLY AUTOMATIC TOP** - The top lock motor is activated, S8 opens. The motor is switched off the moment S7 closes. The top is fully raised and locked to the windshield.

**SEMI AUTOMATIC TOP** - Pull the top over the tension point and lock it to the windshield frame.

The automatic closing of the windows on raising the top is not functional due to lack of anti trap feature during this function.

---

---

---

---

---

---

---

---

---

---

---

---

---

---

---

---

---

---

---

---

---

---

---

---

---

---

---



## EM TOP EMERGENCY OPERATION

In the event of electrical failure, the top can be raised manually. The procedure is as follows:

- Pull the release lever located under the left rear seat cushion as shown.



- Both motors are disconnected from the gear drives.
- The top storage cover is unlocked.

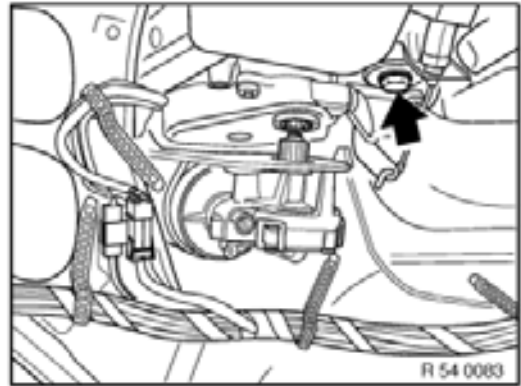

**NOTE:** The top can not be lowered again until electrical power is restored to the system. This is due to the fact that the top storage cover can not be locked until power is restored.

---

---

---

---

---

---

---

---

---

---

---

---

---

---

---

---

---

## RE-CONNECTING DRIVE MOTORS

Due to the interlock of the trunk lid and an unlocked top storage cover, the following procedure must be followed to reconnect the top drive motors, to restore electrical operation:

- Lower all the side windows with the central switch
- Unlock the top from the windshield frame, raise it over the tension point and open the storage cover.
- Lower the top into the storage compartment and close the storage cover.
- Disconnect fuse #7 in the front power distribution box (this will override the forced locking of the trunk).
- Open the trunk lid and remove the trim cover from the left side of the trunk.
- Reconnect the motors with the gear drives. The actuating rods can be moved slightly to allow the gear teeth to engage.
- Close trunk lid and reinstall fuse #7.
- The EM top system must now be initialized to restore normal operation.

---

---

---

---

---

---

---

---

---

---

---

---

---

---

---

---

---

---

---

---

---

---

---

## EM TOP INITIALIZATION

Initialization of the system is required for the CVM to learn the end limits of the top storage cover. The CVM counts the pulses from the integrated hall sensor in the cover motor to determine the cover position.

An initialization run occurs automatically after every eighth operation of the top. This ensures that the hall sensor counting circuit is not adversely affected by any backlash or elasticity of the top cover drive mechanism.

The hall sensor counter reading is stored in a NV RAM, however it is possible for this data to be incorrect or out of sync for the following conditions:

- Power supply interrupted while top is in operation
- Electrical failures that require manual closing of the top.

Follow the procedures on this page or refer to Group 54 in the Repair Manual of TIS.

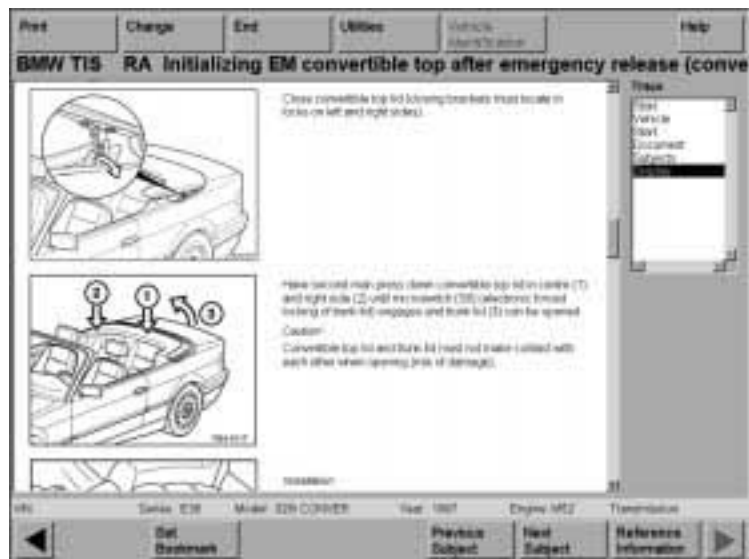

## INITIALIZATION PROCEDURE

1. The top must be placed in the storage compartment
  - Motors engaged with the drives.
  - Top storage cover closed
2. Ignition key switched OFF.
3. Press and hold the top switch in the lowering direction.
4. Switch the ignition on (KL R).
5. After approximately 10 seconds the top storage cover will start to close and lock.
6. At this point release the the top switch. The initialization procedure will continue running. The procedure is complete approximately 0.5 seconds after the top storage cover is closed and locked.

**NOTE:** The initialization procedure can be interrupted by switching the ignition off.

## CONTROL MODULE DIAGNOSIS/TROUBLESHOOTING

- Faults that occur during operation of the top are stored in the CVM.
- They are accessed with the DIS Tester or MoDiC.
- The table reflects the possible fault codes stored in the CVM.

Fault Code	Description
1	Short to ground motor
2	Short to B+ motor
3	Position not plausible
4	Distance/time measurement of the convertible top
5	Fault "rollover sensor"
6	Internal fault of the module
7	Current through CVM too great

- Additionally, the diagnostic requests (status) and component activation function provides quick diagnostic checks of signal status and output function of components.
- Always verify the control module identification against the tester display screen when testing or troubleshooting the EM top system.
- Always check any associated or inter-connected systems when troubleshooting EM top problems. (ie: ZKE IV).
- Check the coding data to make sure the control module is coded correctly for the specific top system in the vehicle.
- Always use the latest software available to test and troubleshoot the system.

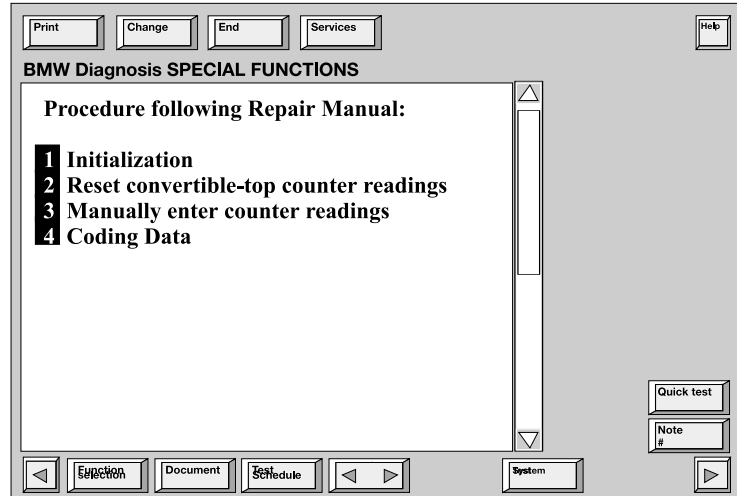
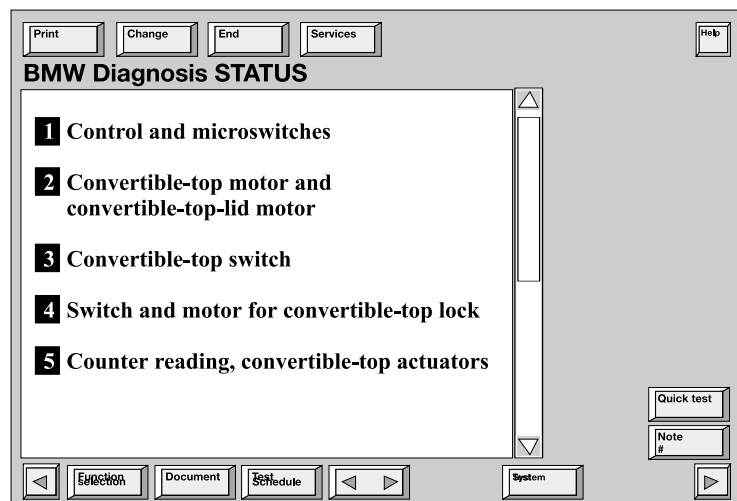

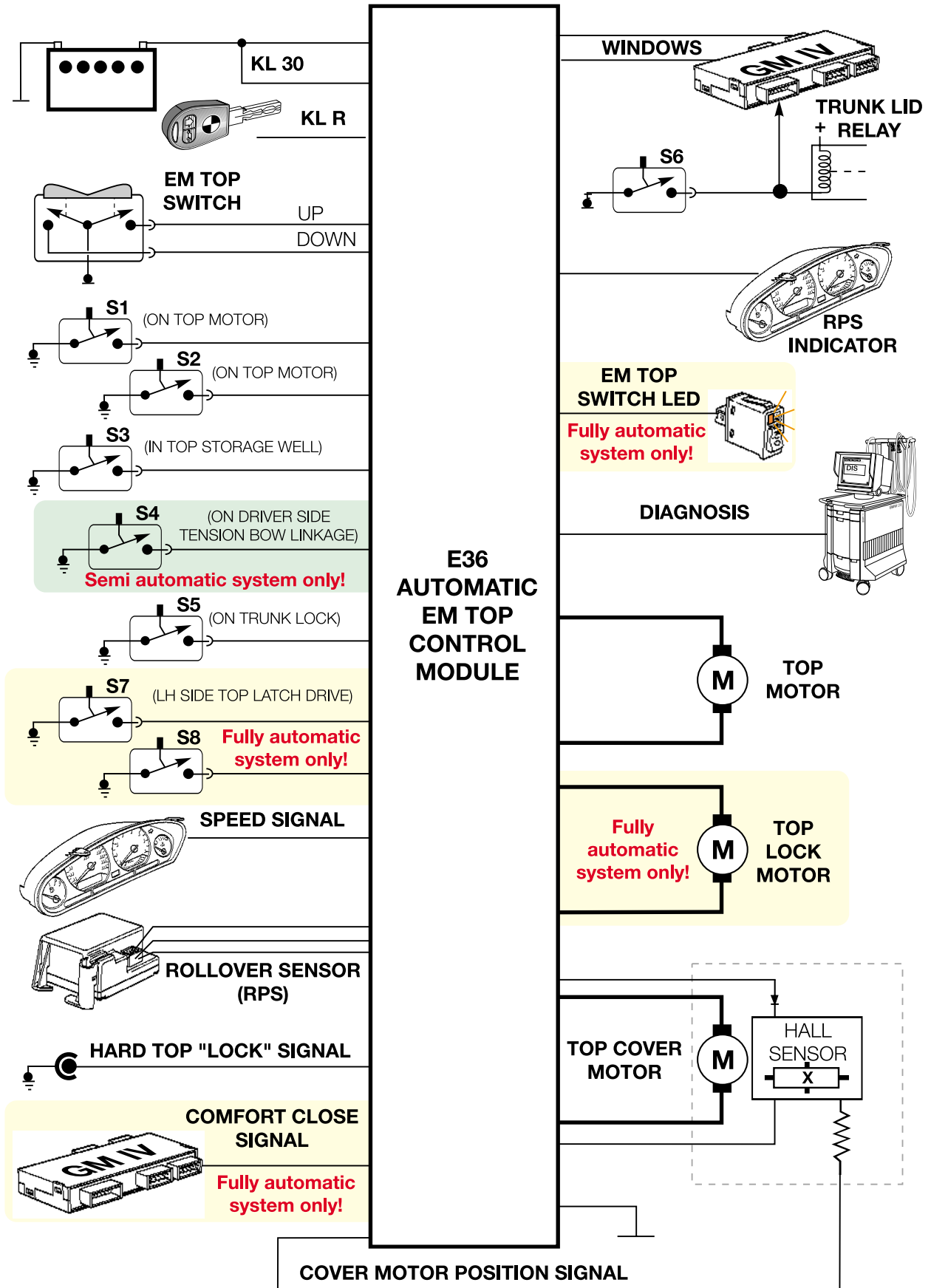

## CONVERTIBLE TOP STORAGE LID POSITION HALL SENSOR TESTS

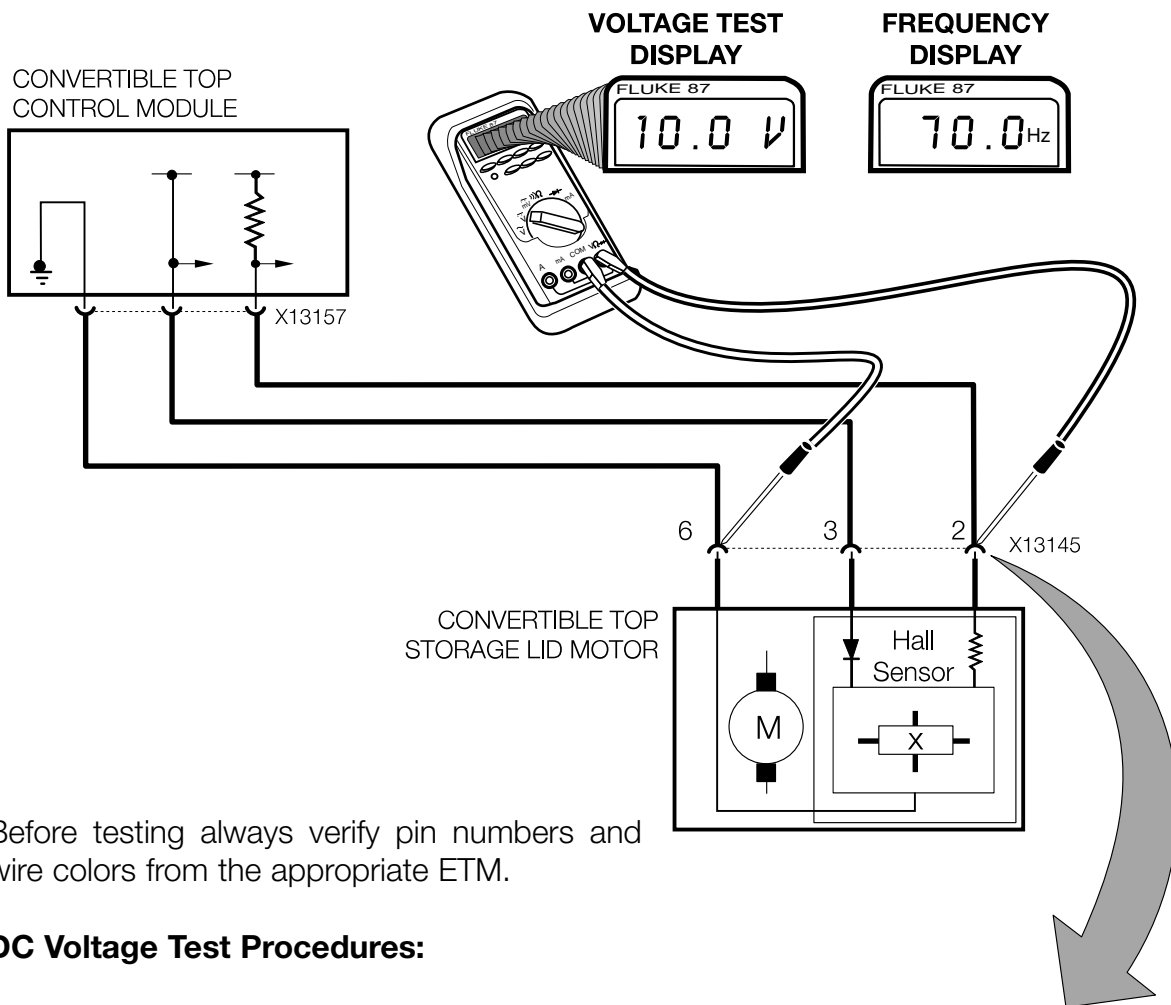

Before testing always verify pin numbers and wire colors from the appropriate ETM.

### DC Voltage Test Procedures:

- At X13145 disconnect and access ground (pin 6) and the hall sensor supply voltage (pin 3) = battery voltage.
- Re-connect plug and check hall sensor signal (pin 2), activate convertible top, with storage lid in motion = 5.0 volts.

Tap switch to display high/low signal -High = 10.0 volts.

Low = 0 volts.

### Voltage Frequency Test Procedure:

- With storage compartment lid moving in either direction, pin 2 = 70 Hz.

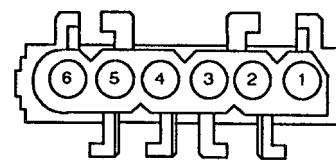

X13145

# E36 CONVERTIBLE TOP ADJUSTMENTS

**NOTE: All mechanical adjustments are critical for synchronous top operation.**

The following adjustments are possible on E36 convertibles. The Repair Manual section of TIS provides system component R&R and adjustment procedures.

The following Repair Manual screens are from **Groups 51 & 54.**

The individual listings provide all of the pertinent procedures for effectively repairing a defect and adjusting the components to effectively maintain the precision operation of the top mechanisms.



**Example:** Adjusting left or right soft top compartment cover lock.

Group 5125.. additionally includes the following E36 convertible top specific procedures:

- Configuration of convertible top cover
- Replace actuating lever
- R&R Bowden Cables
- R&R Top Cover Lock
- R&R Gas Struts for Top Cover

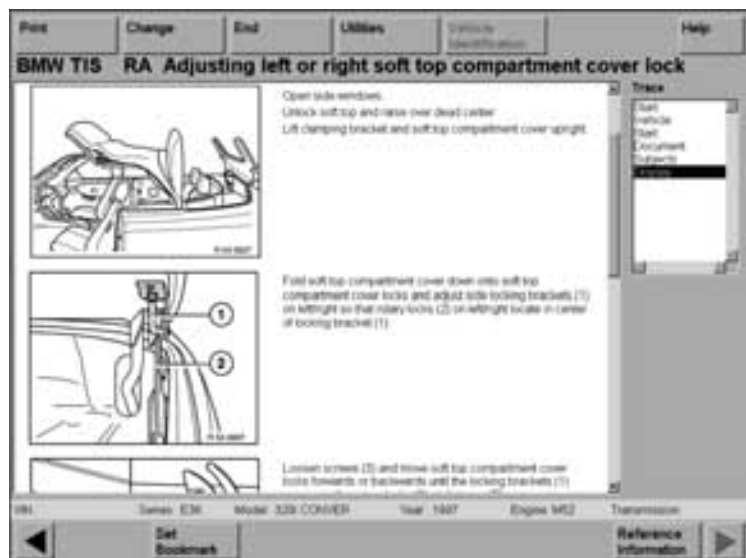

Group 54 25.. includes the following:

- Adjusting both top lid locks.

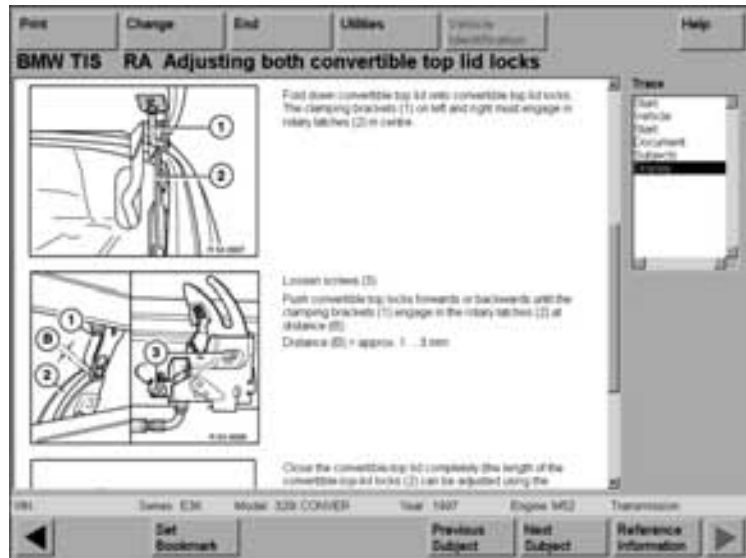

- Adjusting electric motor for convertible top lid.

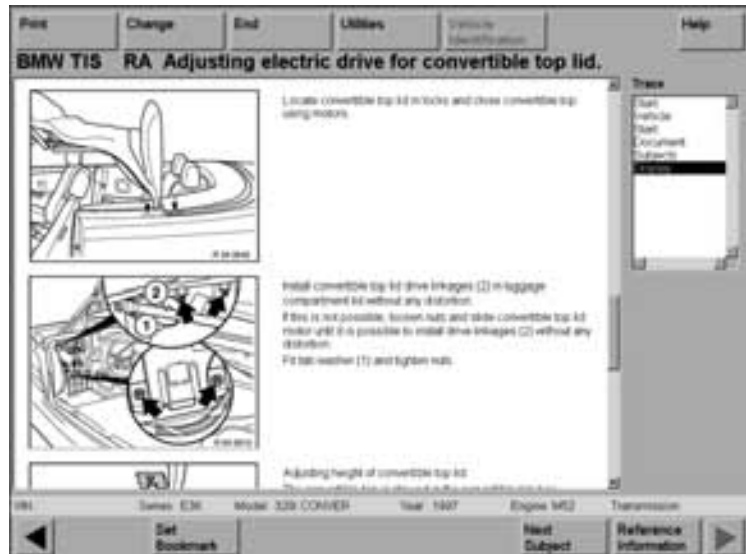

- Adjusting both bowden cables for convertible top lid locks.

Group 54 25.. additionally includes the following E36 convertible top specific procedures:

- R&R electrical convertible top lid drive unit
- R&R both convertible top locks.
- R&R both bowden cables for convertible top lid locks.

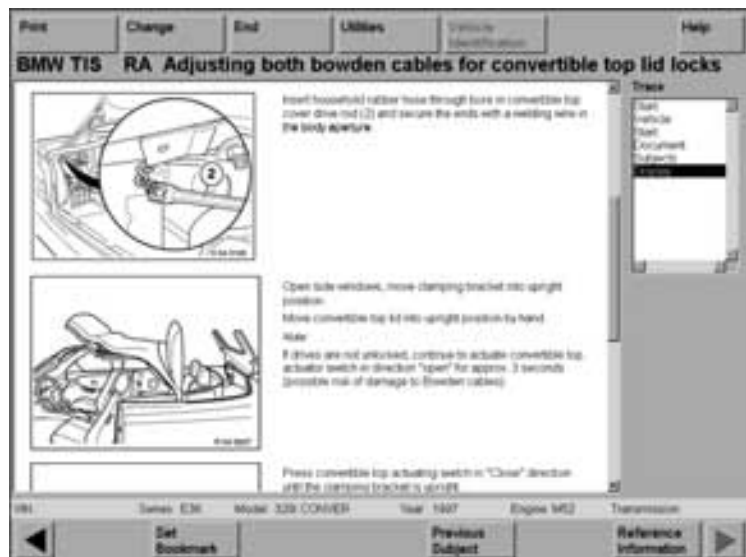



Group 54 31.. includes the following:

- Adjusting convertible top (mechanical).

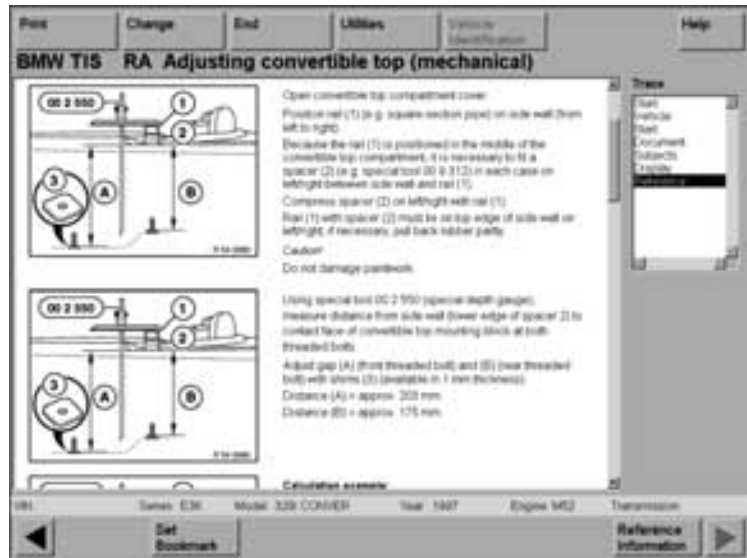

- Adjusting EM convertible top.



Group 54 31.. additionally includes the following E36 convertible top specific procedures:

- R&R complete EM Convertible Top
- Replacing rear window in convertible top
- Replacing convertible top fabric.
- R&R handle for convertible top lock
- R&R headlining in convertible top
- Replacing convertible top lid cover
- R&R base plate on left or right

Group 54 34.. includes the following:

- Adjusting Left/Right Convertible top lock (fully automatic system).



Group 54 34.. additionally includes the following E36 convertible top specific procedures:

- Initialization EM Convertible top
- Replacing linkages for convertible
- R&R electrical convertible top drive unit
- Replacing convertible top cover
- R&R finisher on convertible top lock
- R&R headlining in convertible top
- R&R both convertible top locks (fully automatic system)
- R&R motor for converter top lock (fully automatic system)

---

---

---

---

---

---

---

---

---

---

---

---

---

---

---

---

---

---

---

---

---

---

---

---

---

Group 61 31.. includes the following:

- Adjusting micro switch S4.

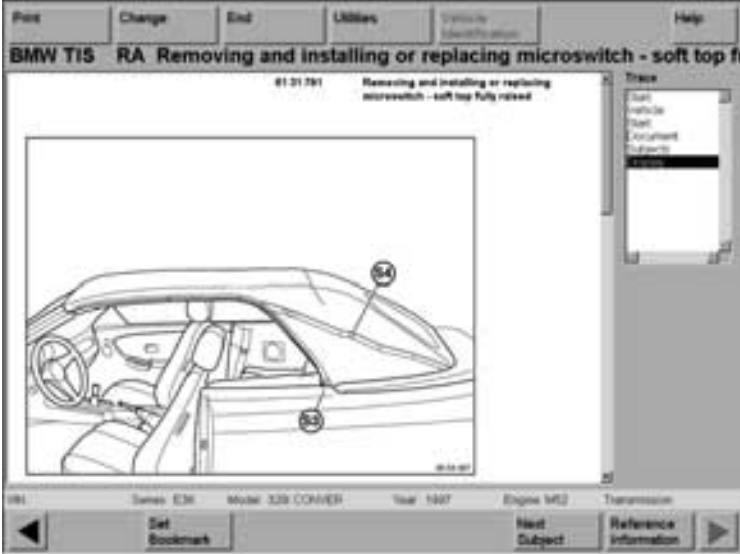

- Adjusting micro switch S3.

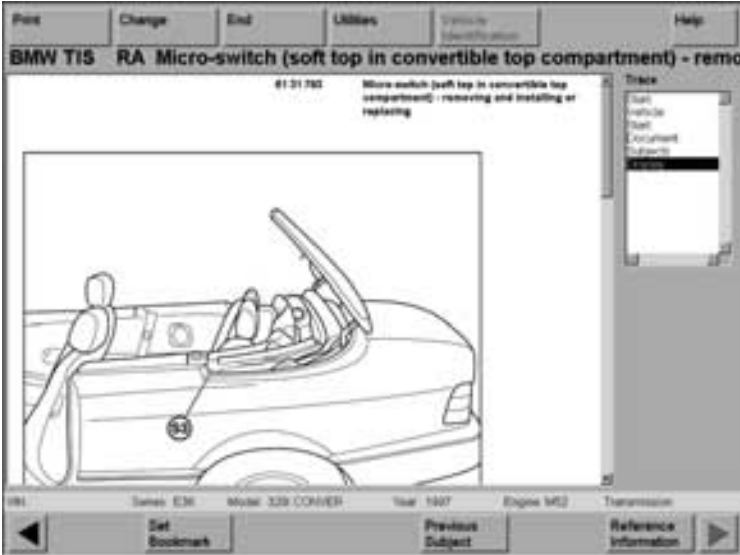

---

---

---

---

---

---

---

---

---

---

---

---

---

Group 54 90.. includes troubleshooting charts for the Semi and Fully Automatic Systems with links to repair procedures.

**BMW TIS RA Troubleshooting convertible (trunk lid/EM-cover semi-automatic)**

Fault	Cause	Remedy
Electrical convertible top fails to open or close	<ul style="list-style-type: none"> <li>a) Battery voltage is + 10.5 V</li> <li>b) Terminal "W" not switched on</li> <li>c) Convertible top not unlocked and raised over dead center post</li> <li>d) Vehicle rds + 5 inch</li> <li>e) Trunk lid opened</li> <li>f) Microswitch (S5) or trunk lock defective</li> <li>g) Microswitch setting not OK</li> <li>h) Fuses defective</li> <li>i) Leads interrupted</li> <li>k) Plug connections interrupted</li> <li>l) Control unit defective</li> </ul>	<ul style="list-style-type: none"> <li>a) Charge battery, let engine run</li> <li>b) Switch on terminal "W", check fuse terminal "W"</li> <li>c) Open convertible top as per specification</li> <li>d) Slow vehicle down to complete operation</li> <li>e) Close trunk lid</li> <li>f) Refer to <a href="#">S4 25 02</a></li> <li>g) Refer to Diagnosis and Repair Manual</li> <li>h) Refer to fuse allocation diagram</li> <li>i) Refer to Diagnosis</li> <li>k) Repair plug connection</li> <li>l) Refer to Diagnosis</li> </ul>
Trunk lid fails to open	<ul style="list-style-type: none"> <li>a) Microswitch (S5) or right trunk lid lock defective</li> <li>b) Trunk lid lock on right side not correctly adjusted</li> </ul>	<ul style="list-style-type: none"> <li>a) Refer to <a href="#">S4 25 02</a> for Diagnosis</li> <li>b) Refer to <a href="#">S4 25 02</a></li> </ul>

Series: EM Model: 329 CONVERT Year: 1997 Engine: M52 Transmission:

**BMW TIS RA Troubleshooting convertible (trunk lid/convertible top, electric motor fully automatic)**

Fault	Cause	Remedy
EM convertible top (fully automatic) fails to open or close	<ul style="list-style-type: none"> <li>a) Battery voltage is + 10.5 V</li> <li>b) Terminal "W" not switched on</li> <li>c) Vehicle rds + 5 inch</li> <li>d) Trunk lid opened</li> <li>e) Microswitch (S5) or trunk lock defective</li> <li>f) Microswitch setting not OK</li> <li>g) Fuses defective</li> <li>h) Leads interrupted</li> <li>i) Plug connections interrupted</li> <li>k) Control unit defective</li> <li>l) Lock on convertible top not switched and raised over dead center post</li> </ul>	<ul style="list-style-type: none"> <li>a) Charge battery, let engine run</li> <li>b) Switch on terminal "W", check fuse terminal "W"</li> <li>c) Slow vehicle down to complete operation</li> <li>d) Close trunk lid</li> <li>e) Refer to <a href="#">S4 25 02</a></li> <li>f) Refer to Diagnosis and Repair Manual</li> <li>g) Refer to fuse allocation diagram</li> <li>h) Refer to Diagnosis</li> <li>i) Repair plug connection</li> <li>k) Refer to Diagnosis</li> <li>l) Engine lock defective</li> </ul>
Electrical convertible top fails to open or close	<ul style="list-style-type: none"> <li>a) Battery voltage is + 10.5 V</li> <li>b) Terminal "W" not switched on</li> <li>c) Convertible top not unlocked and raised over dead center post</li> <li>d) Vehicle rds + 5 inch</li> </ul>	<ul style="list-style-type: none"> <li>a) Charge battery, let engine run</li> <li>b) Switch on terminal "W", check fuse terminal "W"</li> <li>c) Open convertible top as per specification</li> </ul>

Series: EM Model: 329 CONVERT Year: 1997 Engine: M52 Transmission:

Group 54 90.. also includes a micro switch logic table for diagnosis.

**BMW TIS RA Troubleshooting table for microswitch on EM convertible top (electric motor fully automatic)**

**Test requirements:**

- Check diagram: refer to Electrical Troubleshooting Manual for 3 Series - EM.
- DS, MUC or BMW SERVICE-TESTER
- Diagnosis device for DS, MUC or BMW SERVICE-TESTER
- Battery charged: When battery voltage is below 10.5 V the drive units are switched off by the control unit.
- Fuses in good working order
- Ignition lock in setting "W"
- Trunk lid (S5) closed

**Open EM convertible top (fully automatic)**

Condition	Activated
Convertible top closed and locked off	Activated: S5, S6, S7
Unlock convertible top	Activated: S5, S8
Convertible top raised over dead center position	Activated: S5, S6, S8
Raise follow-bar	Activated: S1, S5, S6, S8
Follow-bar extended	Activated: S1, S2, S5, S6, S8
Unlock convertible top lid	Activated: S1, S2, S5, S8
Convertible lid open (interlock)	Activated: S1, S2, S5, S8, M0
Follow-bar retracts	Activated: S1, S5, S8
Follow-bar retracted	Activated: S5, S8
Convertible top stored in convertible top box	Activated: S1, S5, S8

Series: EM Model: 329 CONVERT Year: 1997 Engine: M52 Transmission:

---

## E36 CONVERTIBLE SPECIFIC SI BULLETINS

Refer to the following list of Service Information bulletins when servicing an E36 convertible. Always check the most up-to-date SI's and recent DCS messages for current service information.

- E-36 CONVERTIBLE TOP HEADLINER SAGS.  
Repair kit P/N 54 31 8 227 354. **SIB 54 03 96.**
- CONVERTIBLE TOP CLEANING KIT. P/N 83 12 9 407 806. **SIB 54 07 95.**
- CONVERTIBLE STORAGE LID PROTECTIVE CAP INSTALLATION. **SIB 54 06 95.**
- CONVERTIBLE FOLDING ASSIST ROD. P/N 54 31 8 203 869. **SIB 54 05 95.**
- CONVERTIBLE HEADLINER PLASTIC PANEL REPLACEMENT. P/N 54 31 8 211 902.  
**SIB 54 04 95.**
- CONVERTIBLE TOP PLASTIC BREAKS AT C PILLAR.  
Repair Kit P/N 54 31 8 209 781. **SIB 54 02 95.**
- CONVERTIBLE HEADLINER SAGS. **SIB 54 04 94.**
- CONVERTIBLE TOP FAILS WHEN LOWERING.  
--Needs new drive levers-- **SIB 54 03 94.**
- CONVERTIBLE TOP SEAL SQUEAKS.
- CONVERTIBLE TOP ACTUATING ROD REPLACEMENT.
- CONVERTIBLE STORAGE LID LATCHING CABLES. **SIB 54 06 93.**
- E-36 CONVERTIBLE TOP INITIALIZATION. **SIB 54 04 93.**
- E-36 CONVERTIBLE GLOVE LIGHT STAYS ON. **SIB 63 03 93**

---

---

---

---

---

---

---

---

---

# Z3 CONVERTIBLE TOP

## OVERVIEW

This Convertible top design is a single retractable mechanism that folds into a storage well behind the seats. When stowed the top is covered by a clip on vinyl top cover. The top is rigidly connected at the rear which eliminates the need for a tension bow as used on the E36 top design. The top is latched to the windshield frame with catches on the left and right sides.

The Z3 was introduced in the 1996 model year with a manual variant of the convertible top. Starting with 4/97 production, the manual top was fitted with an additional gas spring strut to assist the driver while raising or lowering the top. For the 1998 model year an optional Electro Hydraulic variant also became available.

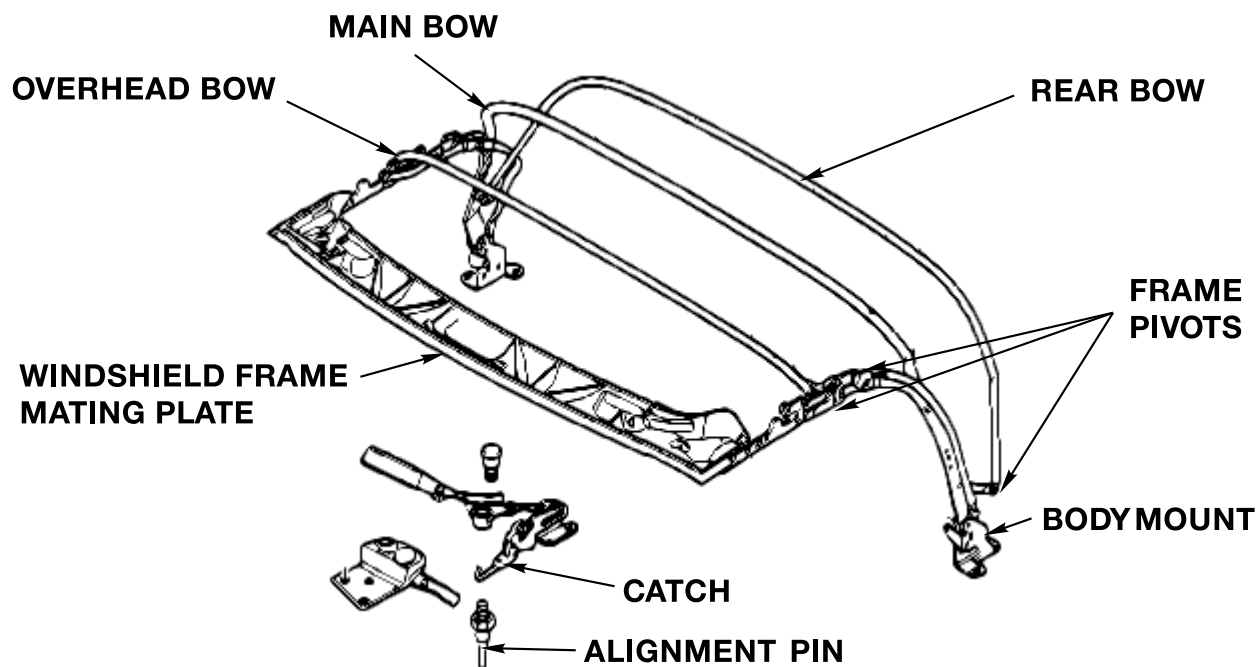

Regardless of the mode of automation, the mechanical pivot points and movement while raising or lowering are the same for both variations.

---

---

---

---

---

## Z3 ELECTRO HYDRAULIC TOP COMPONENTS

The system components include:

- Electric motor/pump with reservoir and relays,
- Hydraulic tubing,
- Hydraulic cylinder with piston,
- “Off tension” microswitch
- Console mounted switch

Located in the driver’s side B pillar, the hydraulic piston connects to the body by a clip and the top frame by a ball pin.

The electric motor/ hydraulic pump assembly is in the left rear corner of the trunk. The hydraulic tubing runs through an opening in the trunk bulkhead to the hydraulic piston.

The “see thru” reservoir of the pump has “min/max” fill lines which allows quick visual confirmation of the system fluid level.

Use hydraulic oil from kit P/N: 54 34 8 410 308.

**Emergency Valve:** The hydraulic unit has an Emergency Valve located on its top surface.

If the top can not be operated due to an electrical or hydraulic fault, the valve is unscrewed 1/2 turn allowing the top to be raised manually.

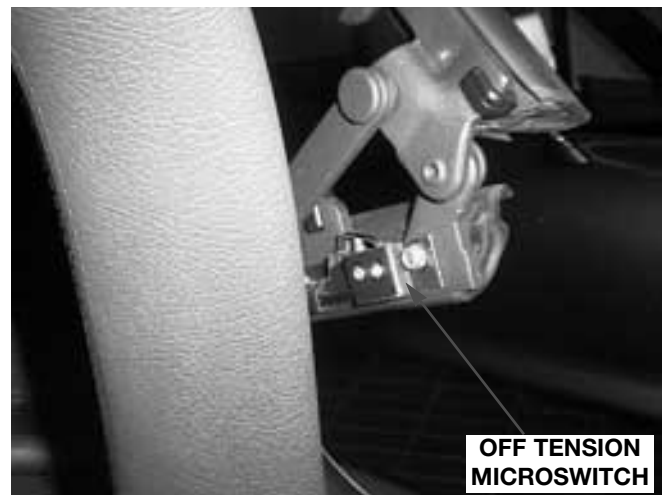
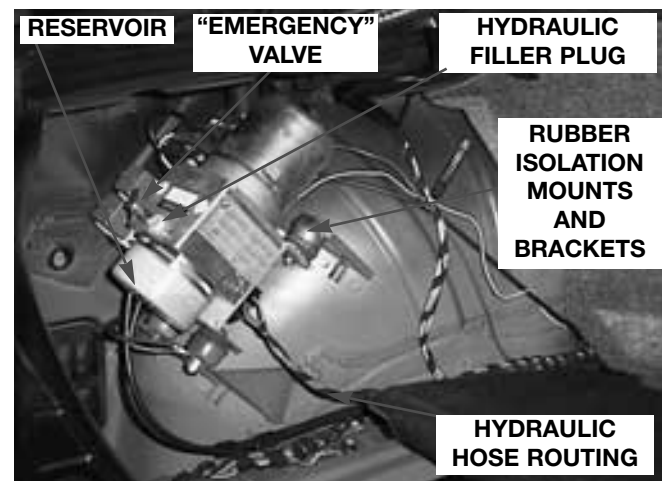
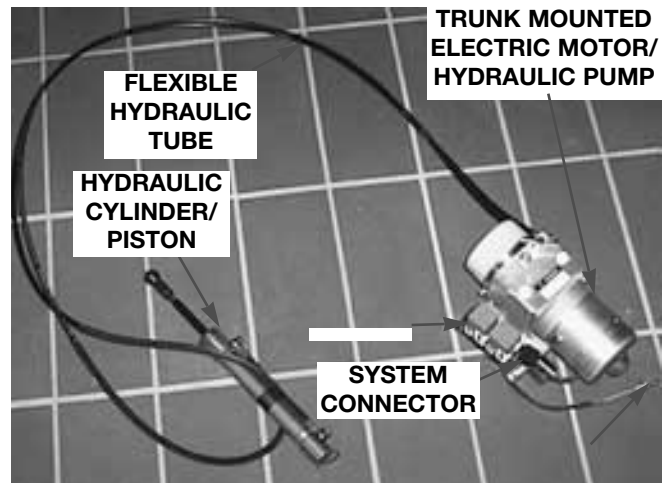

## OPERATION

- Top operation is dependent on a stationary vehicle with the brake pedal depressed.
- Unlock the top at the windshield frame and raise past the tension point (microswitch closes).
- With the windows lowered press the top switch in the console panel.
- The switch provides a ground for the control circuit of either the up or down relay. Power is provided through the brake light switch circuit when the brake pedal is depressed.
- The activated relay provides operating power to the pump motor which is grounded through the other relays not active contacts.
- Release switch once top is at end of travel.
- Motor reversal is achieved when the switch is pressed in the opposite direction activating the other relay.

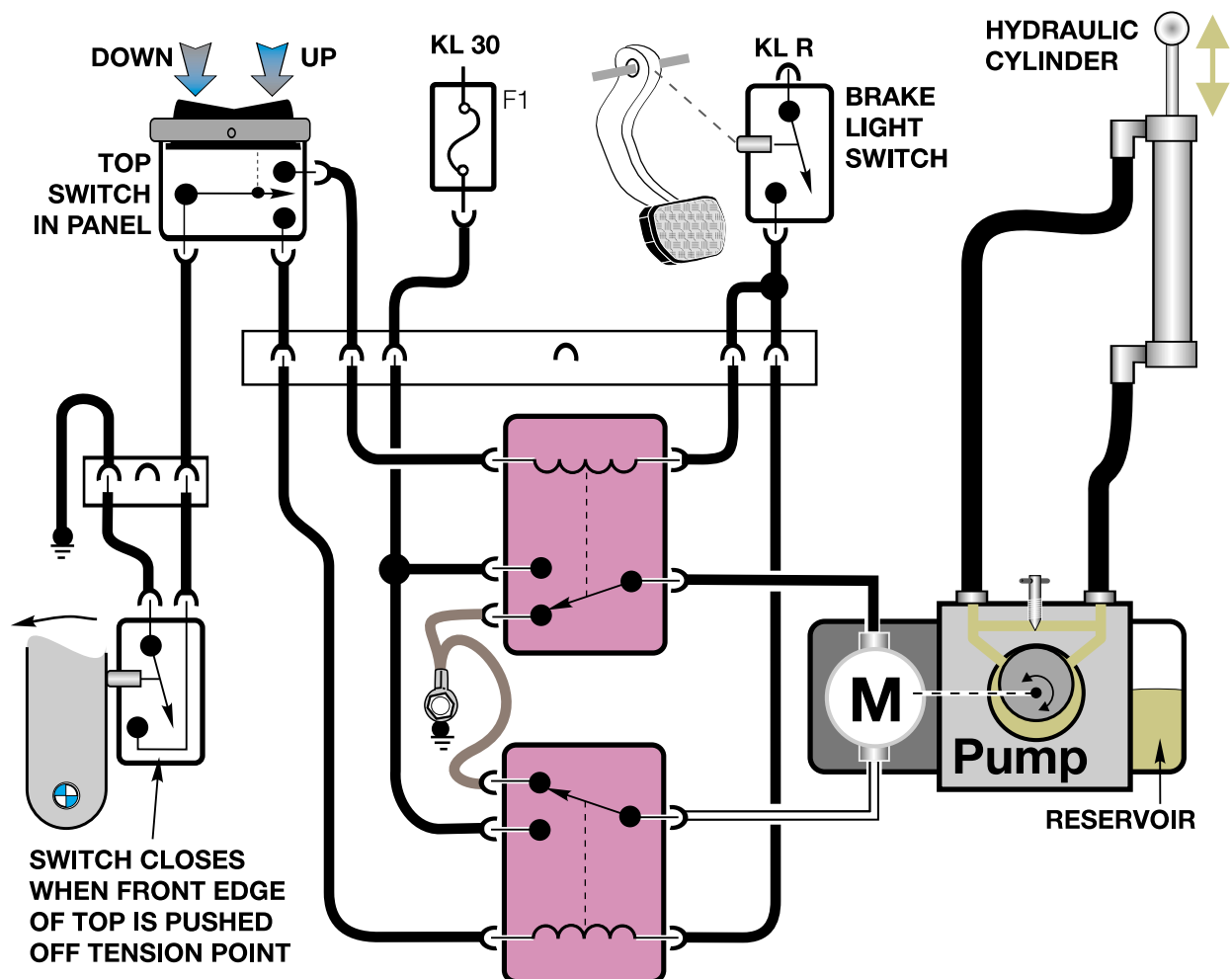



## Z3 CONVERTIBLE TOP ADJUSTMENTS

The following adjustments are possible on Z3 convertible tops. The Repair Manual section of TIS provides system component R&R and adjustment procedures.

- Adjustment Shims for Base mount to body. Procedures for R&R top.

Additionally, the Repair Manual has procedures for:

- Replacing Rear Window
- Replacing Convertible Cover
- Replacing gas spring strut

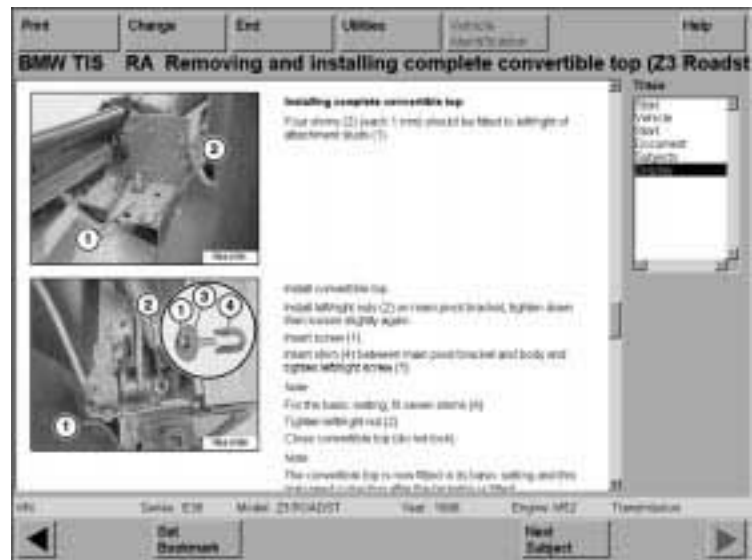

Not included in the repair manual is the adjustment procedure for the windshield latch hooks.

The hook(s) can be adjusted to correct for inadequate sealing at the windshield seal or if the hooks are excessively hard to close.

Loosen the small recessed allen set screw. Screw the threaded hook in or out as needed to adjust. Pull the allen screw completely out and apply a light coating of loctite on the threads. Tighten set screw.

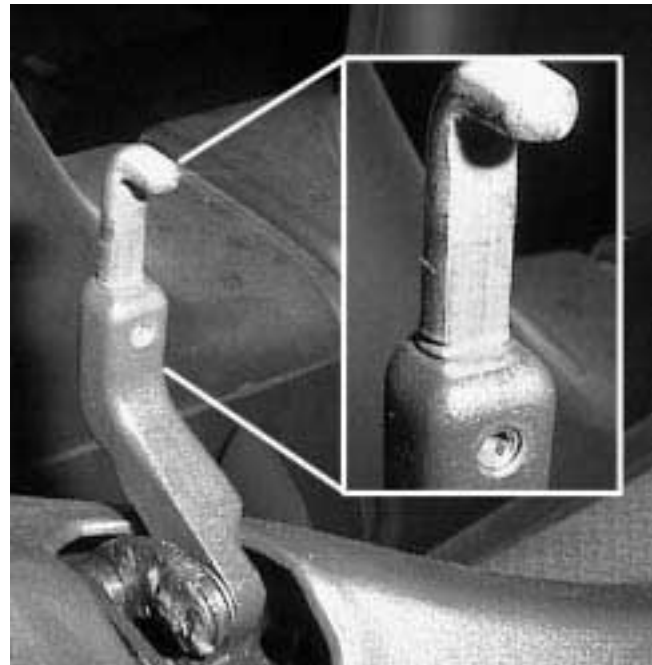

The following information on the Z3 convertible top is also available in the Repair Manual:

- Notes on electrohydraulic convertible top.

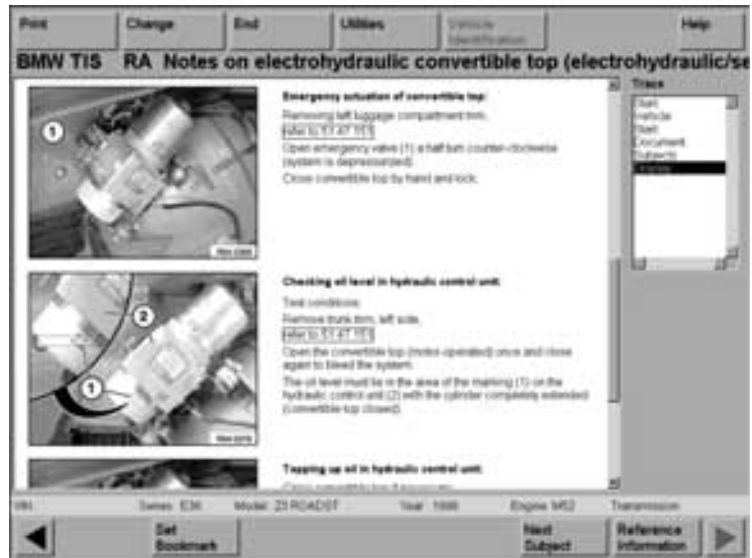

- R&R hydraulic control unit

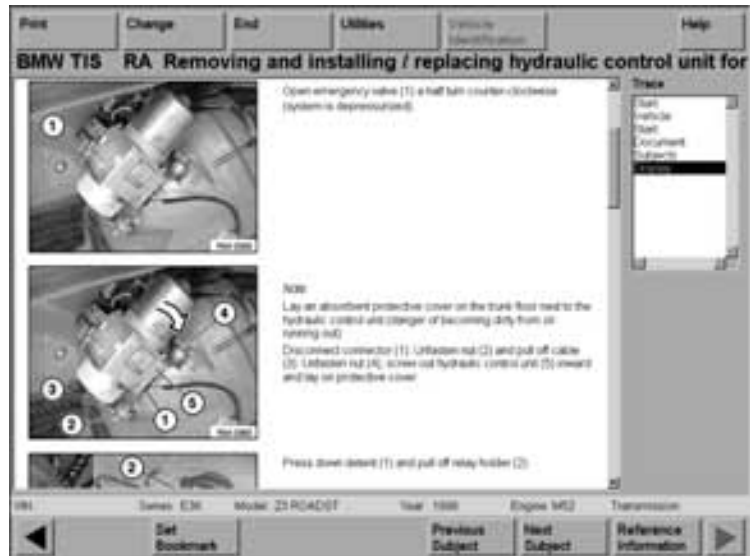

- R&R Hydraulic Cylinder

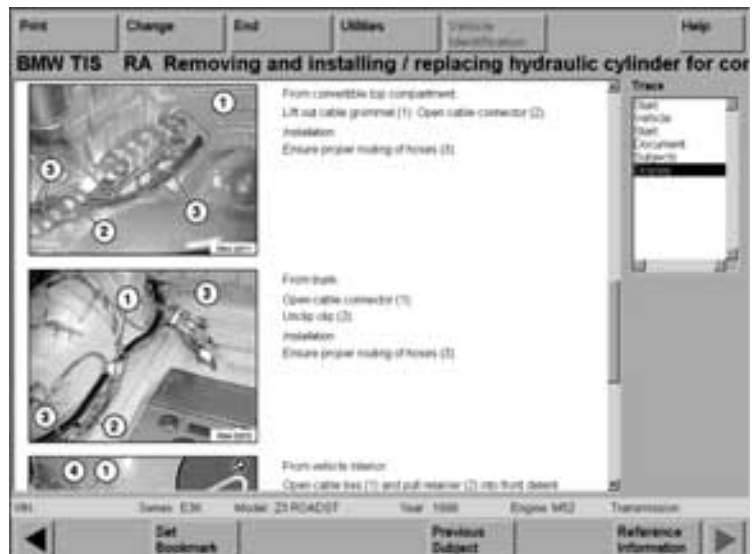



---

## BASIC TROUBLESHOOTING

- Always personally verify the customer complaint.
- Always verify that the complaint is truly a system malfunction.
- Perform a Quick Test to determine if the vehicle systems have logged fault codes.
- Call up the faulted system or appropriate test schedule to verify the correct control module is installed in the car.
- Follow the Diagnostic Information System (DIS) on screen instructions and perform all tests as specified.
- Use the DIS and fault symptom diagnostic procedures as trained.
- Follow the appropriate test module procedures for systems that malfunction but fail to set faults in memory.
- System problems which elude diagnostic procedures must be brought to the attention of BMW of North America, Inc.
- **BMW Technical Assistance Hotline 1-800-472-7222**
- **BMW Service Training Feedback Message Center 1-201-573-2186**

---

---

---

---

---

---

---

---

---

---

---

---

---

---

---

---

---

---

---

---

---

---

---