

# Table of contents

## LATHE CHUCKS - INDEPENDENT CHUCKS

### Key bar chucks

DURO-T	3005
Jaws DURO-T	3012
Accessories DURO-T	3013
DURO A	3016
Jaws DURO A	3018
Accessories DURO A	3019

### Geared scroll chucks

ZG-ZS	3022
Jaws ZG-ZS	3031
Accessories ZG-ZS	3038
ZGU-ZSU	3040
ZGU-ZSU heavy design	3047
Jaws ZGU-ZSU	3051
Accessories ZGU-ZSU	3055

### Two-jaw lathe chucks

ZGF	3057
Jaws ZGF	3058
Accessories ZGF	3059

### Geared scroll chucks

ZGD	3065
Jaws ZGD	3067
Accessories ZGD	3069

### Lathe and grinding chucks

ZG Hi-Tru	3073
Jaws ZG Hi-Tru	3074
Accessories ZG Hi-Tru	3077

### Lever scroll chucks

KRF	3078
KRF - on base plate	3079
Jaws KRF	3080
Accessories KRF	3081

### Geared scroll chucks

EG-ES	3082
Jaws EG-ES	3088
Accessories EG-ES	3089

### Jaw cutting attachment

BAV	3093
-----	------

### Flansche

Safety driving adapter plates	3094
Steel adapter plates	3095

### Steel independent chucks

USE-USU	3097
Jaws USE-USU	3102
Accessories USE-USU	3103

### Cast iron independent chucks

UGE-UGU	3106
Jaws UGE-UGU	3109
Accessories UGE-UGU	3110

Particularly successful and effective when  
power is attributed maximum priority.

With firm grip on larger sizes and heavy weights - to be sure!





## LATHE CHUCKS - INDEPENDENT CHUCKS

Key bar chucks DURO-T	3005
Lathe chucks ZG-ZS	3022
Lathe chucks ZGU-ZSU	3040
Lathe chucks ZGF	3057
Lathe chucks ZGD	3065
Lathe chucks ZG Hi-Tru	3073
Lathe chucks KRF	3078
Lathe chucks EG-ES	3082
Jaw cutting attachment	3093
Steel adapter plates	3094
Steel independent chucks USE-USU	3097
Cast iron independent chucks UGE-UGU	3106

**Please note:**  
The delivery time specified in the catalogue is valid from 01.01.2012

# Operation Guide

	Key bar chucks		Geared scroll chucks				
Type	DURO-T	DURO A	ZG / ZGU / heavy design	ZS / ZSU / heavy design	ZGF	ZGD	ZG Hi-Tru
Chucking capacities	3 - 646	3 - 646	2 - 1400	2 - 1400	(3 - 400)	4 - 500	2 - 315
Mount	DIN 6350 ISO 702-1 (DIN 55026) ISO 702-2 (DIN 55029) ISO 702-3 (DIN 55027)	DIN 6350 ISO 702-2 (DIN 55029) ISO 702-3 (DIN 55027)	DIN 6350 ISO 702-1 (DIN 55026) ISO 702-2 (DIN 55029) ISO 702-3 (DIN 55027) DIN 6350 BVV (mounting from front)	DIN 6350 ISO 702-1 (DIN 55026) ISO 702-2 (DIN 55029) ISO 702-3 (DIN 55027) DIN 6350 BVV (mounting from front)	DIN 6350 DIN 6350 BVV (mounting from front)	DIN 6350 ISO 702-1 (DIN 55026) ISO 702-2 (DIN 55029) ISO 702-3 (DIN 55027)	DIN 6350
Through-hole							
Number of jaws							
Types of jaws							
Workpiece							
Machining							
Rotating/ Stationary							
Clamping							
Clamping force							
Speed max.							
Precision							
Feature	quick-acting jaw change system				soft top jaws	double jaw guides	radial precision adjustment, with special seal for grinding machines
Page	3005	3016	3022 / 3040 / 3047	3022 / 3040 / 3047	3057	3065	3073



yes



optional



no



2-jaw chuck



3-jaw chuck



4-jaw chuck



6-jaw chuck



pipe



bar



disc



flange



asymmetrical workpiece

# Operation Guide

Type	Geared scroll chucks			Independent chucks	
	KRF	EG	ES	USE / USU	UGE / UGU
Chucking capacities	2 - 200	3 - 630	3 - 630	20 - 1270	8 - 1250
Mount	Cylindrical centre mount	DIN 6350 ISO 702-1 (DIN 55026) ISO 702-2 (DIN 55029) ISO 702-3 (DIN 55027)	DIN 6350 ISO 702-1 (DIN 55026) ISO 702-2 (DIN 55029) ISO 702-3 (DIN 55027)	Cylindrical centre mount ISO 702-1 (DIN 55026) ISO 702-2 (DIN 55029) ISO 702-3 (DIN 55027)	Cylindrical centre mount ISO 702-1 (DIN 55026) ISO 702-2 (DIN 55029) ISO 702-3 (DIN 55027)
Through-hole					
Number of jaws					
Types of jaws					
Workpiece					
Machining					
Rotating/ Stationary					
Clamping					
Clamping force					
Speed max.					
Precision					
Feature					
Page	3078	3082	3082	3097	3106



Inside jaw + outside jaw



base jaw



base- and top jaw



reversible jaw



length machining



side machining



Rotating



Stationary



Self-centering



independently adjustable

# Operation guide

## Technical features

All components which are important for transmitting the chucking force are hardened and ground. Pinions and operating screws are recessed into the chuck body to reduce the risk of accidents. Chuck bodies made out of steel are drop-forged. Lathe chucks respectively scroll threads are balanced. The recommended speed is shown on the chuck. The various types of jaws can be ordered as spares. They are interchangeable.

## Guide for use of hand-operated RÖHM chucks and independent chucks

Range of application, special features	Duro-T	Duro-A	ZG ZGU ZGD	ZS ZSU	ZGF	Hi-Tru	KRF	EG ES	Independent chucks
	Chucks with thrust ring and keybars		DIN 6350					DIN 6351	
Machining of flange-type workpieces	■	■	■	■	■	■		■	■
Bar and tubework	■		■	■	■	■		■	▲
Machining of parts requiring a very high concentricity accuracy	●	●	■	■		● <sup>1)</sup>			
Twist drill grinding							●		
Clamping of parts on grinding machines	■	●	▲	▲		●		▲	
Machining of eccentr. parts, of assym. and irregul. shaped workpieces								●	●
Machining of workpiece requiring especially high gripping force	●	●	■	■					
Machining of workpieces requiring a very high speed	●	●		●					
Measuring and inspection works requiring a very high concentricity accuracy	●	●				●			
Clamping of parts on measuring machines							●		

1) With additional sealing

- = normal application
- = particularly suitable
- ▲ = possible, with reservations

# DURO-T

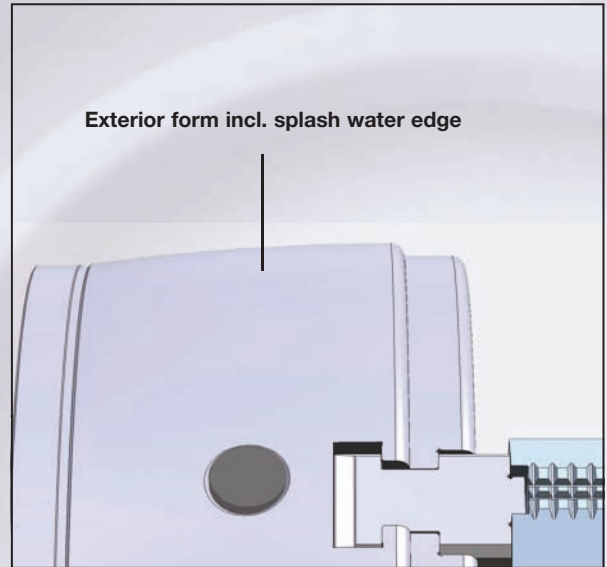

### Technical features

#### RÖHM DURO-T Manual chucks:

- 20% higher clamping forces
- Chuck body stiffer (guarantees precision at higher loads)
- Surface of chuck body completely hardened
- Highly operator friendly
- Superior Design:
  - Indicator marks for quick jaw adjustment
  - Meaningful lettering engraved in body front face (i.e. chuck number, techn. details)
  - attractive, tared shape incl. drop-off wedge for water
- High jaw-changing repeatability
- Optimized wearing parts (i.e. safety lock)
- Chuck statically balanced
- Enhanced life at higher precision
- Radial and axial run-out tolerances only half of the permitted values according to the DIN-accuracy class 1
- Better corrosion prevention
- Lubrication possibility of the highly loaded sliding surfaces:
  - Spindle thread and spindle-counterface
  - wedge bars
  - drive ring
  - slides
- With safety key (required acc. DIN EN 1550)
- Base- and top-jaws of other manufacturers are compatible

## Clamping force comparison DURO vs. DURO-T

Chuck size		125	160	200	250	315	400	500	630
<b>Total gripping force DURO 1)</b>	kN	8	25	40	55	67	85	93	93
<b>Total gripping force DURO-T 1)</b>	kN	8,5	30	48	66	80	95	102	102

1) Maintaining the accuracy

### Gripping force

The gripping force is the sum total of all jaw forces acting radially on the stationary workpiece. The specified gripping forces are standard values. They apply to chucks in a perfect condition which have been lubricated with RÖHM grease F79 and F80.

# DURO-T

The key bar chuck DURO-T replaces the well-tried RÖHM-Chuck DURO and ensures ultimate precision by the latest manufacturing technology. The DURO-T features up to 20 % more clamping force and is statically balanced.

### Mechanism

The tangentially arranged operating screw (1) engages the internal thread of the actuating key bar (2) to move a slide (3) which in turn moves the drive ring. Two further slides in the drive ring (4) transmit the force to the other two key bars. The key bars are provided with helical teeth which engages the teeth of the base jaws (5) so that the workpiece is gripped accurately and concentrically. The jaws can be quickly and conveniently reversed, exchanged or relocated over the entire gripping range. After disengaging the key bar by turning the wrench counterclockwise, the indicator pin appears (7). In this position, the jaws are safely locked (6) against movement so that they cannot fly out if the machine spindle is started inadvertently. Each jaw must therefore be unlocked by pressing the corresponding pin (8) on the outside diameter of the chuck.

Large, straight surfaces transmitting the force from the key bar to the jaw teeth guarantee long life and produce a very high gripping force combined with an accuracy which is twice high as required by DIN 6386. The high gripping force is achieved without much physical effort by manually turning the key.

### Lubrication

Lathe chucks must be lubricated regularly to maintain their gripping force. Appropriate directions are included in the operating instructions supplied with each chuck. All lathe chucks are equipped with grease nipples for convenient maintenance.

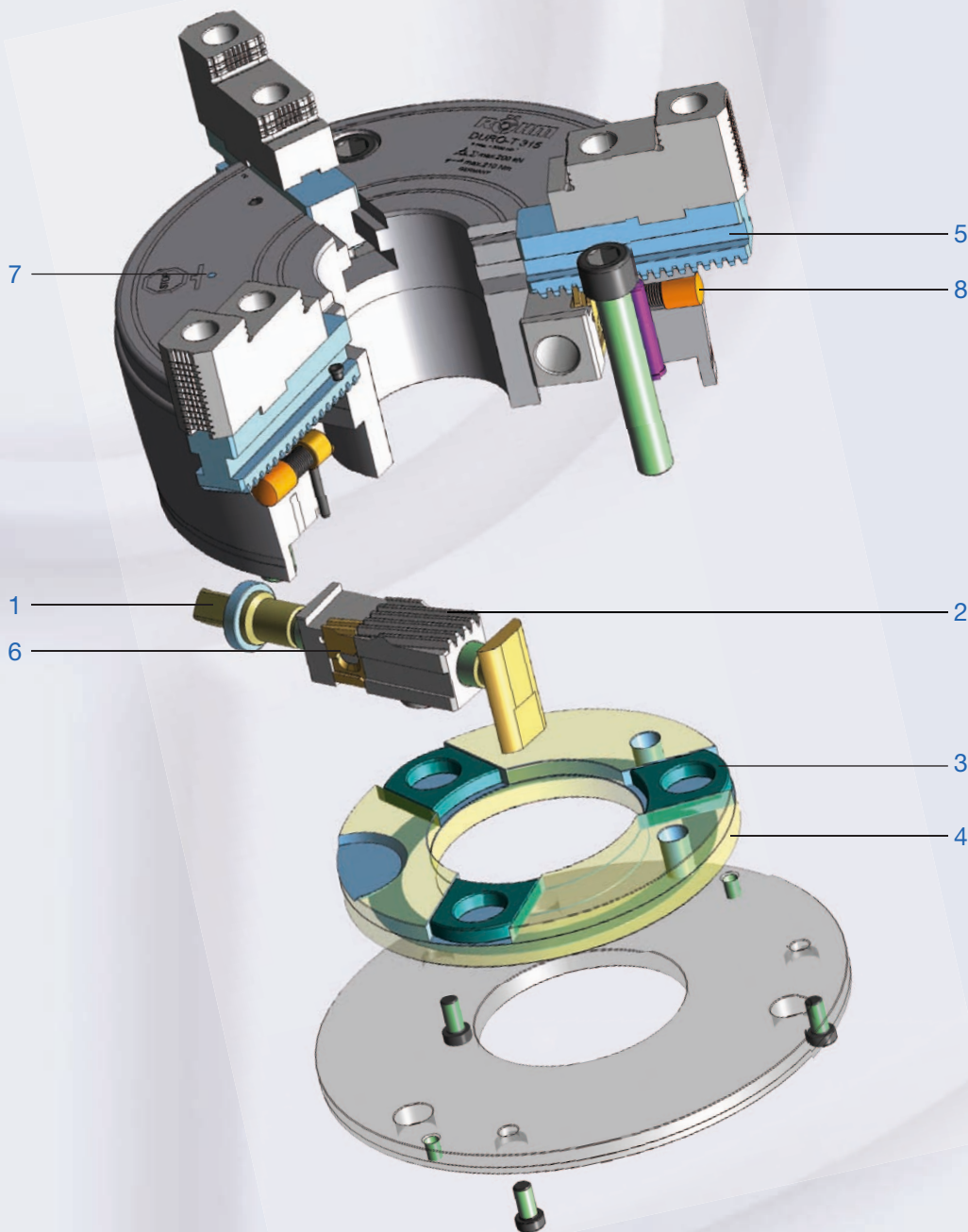



**DURO-T**



DURO-T key bar chucks are successfully used wherever extremely high tension forces, high concentric accuracy and reliable continuous repeatability are needed.

For lathes. Suitable for milling machines, dividing attachments and machining centres in connection with a base plate, non rotating.

The jaws can be quickly and easily reversed, exchanged or relocated over the entire gripping range.

The jaws retain their accuracy if they are always used on the same chuck and when base jaws and top jaws are kept screwed together as a matched set for recurring work.

It is therefore advisable to stock several jaw sets.

**Technical features:**

- with jaw safeguard
- chuck body stiffer (guarantees precision at higher loads)
- indicator marks for quick jaw adjustment
- attractive shape incl. drop-off edge for water
- radial and axial run-out tolerances only half of the permitted values according to the DIN-accuracy class 1
- lubrication possibility of the highly loaded sliding surfaces
- With safety key (required acc. DIN EN 1550)

**Customer advantage:**

- higher clamping forces
- high jaw-changing repeatability
- optimized wearing parts
- better corrosion prevention
- base- and top-jaws of other manufacturers are compatible

Tool group A08  
Type 000  
**with reversible one-piece jaws  
cylindrical centre mount**

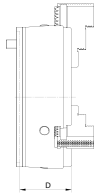

Item no.	Size	Inch	Through-hole	D	Speed max. min-1	Torque Nm	Total clamping force kN
437475 ●	125	5	32	46,5	6000	20	8,5
437476 ●	160	6 1/4	42	63	5400	40	30
437477 ●	200	8	52	81	4600	60	48
437478 ●	250	10	62	92	4200	70	66
437479 ■	315	12 1/2	87	111	3300	80	80
437480 ■	400	15 3/4	102	118	2200	90	95
437481 ■	500	20	162	118	1900	100	102

1) by conserving the precision

Tool group A08  
Type 001  
**with base jaws only  
cylindrical centre mount**

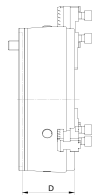

Item no.	Size	Inch	Through-hole	D	Speed max. min-1	Torque Nm	Total clamping force kN
437482 ●	125	5	32	46,5	6000	20	8,5
437483 ●	160	6 1/4	42	63	5400	40	30
437484 ●	200	8	52	81	4600	60	48
437485 ■	250	10	62	92	4200	70	66
437486 ■	315	12 1/2	87	111	3300	80	80
437487 ■	400	15 3/4	102	118	2200	90	95
437488 ■	500	20	162	118	1900	100	102
437489 <sup>1)</sup> ■	630	25	252	143	1100	100	102

1) by conserving the precision

2) at size 630 chuck body without convex outer contours

Tool group A08  
Type 003  
**with base jaws and  
reversible top jaws  
cylindrical centre mount**



Item no.	Size	Inch	Through-hole	D	Speed max. min-1	Torque Nm	Total clamping force kN
437490 ●	160	6 1/4	42	63	5400	40	30
437491 ●	200	8	52	81	4600	60	48
437492 ●	250	10	62	92	4200	70	66
437493 ●	315	12 1/2	87	111	3300	80	80
437494 ■	400	15 3/4	102	118	2200	90	95
437495 ■	500	20	162	118	1900	100	102
437496 <sup>1)</sup> ■	630	25	252	143	1100	100	102

1) by conserving the precision

2) at size 630 chuck body without convex outer contours

# DURO-T

Tool group A08  
Type 011  
**with reversible one-piece jaws ISO 702-1 (DIN 55026),**  
DIN 55021, ASA B 5.9, mounting from front

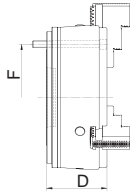

Item no.	Size	Mount short taper	Through-hole	D	F	Speed max. min-1	Torque Nm	Total clamping force kN
437570	160	4	42	76	82,62	5400	40	30
437571	160	5	42	79	104,8	5400	40	30
437572	200	5	52	93	104,8	4600	60	48
437573	200	6	52	97	133,4	4600	60	48
437574	250	6	62	108	133,4	4200	70	66
437575	315	6	87	124	133,4	3300	80	80
437576	315	8	87	130	171,4	3300	80	80
437577	400	8	102	135	171,4	2200	90	95
437578	500	11	162	138	235	1900	100	102

1) by conserving the precision

Tool group A08  
Type 012  
**with base jaws only ISO 702-1 (DIN 55026),**  
DIN 55021, ASA B 5.9, mounting from front

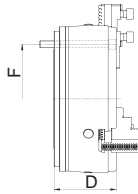

Item no.	Size	Mount short taper	Through-hole	D	F	Speed max. min-1	Torque Nm	Total clamping force kN
437580	160	4	42	76	82,62	5400	40	30
437581	160	5	42	79	104,8	5400	40	30
437582	200	5	52	93	104,8	4600	60	48
437583	200	6	52	97	133,4	4600	60	48
437584	250	6	62	108	133,4	4200	70	66
437585	315	6	87	124	133,4	3300	80	80
437586	315	8	87	130	171,4	3300	80	80
437587	400	8	102	135	171,4	2200	90	95
437588	500	11	162	138	235	1900	100	102
437590 <sup>1)</sup>	630	15	252	167	330,2	1100	100	102

1) by conserving the precision  
2) at size 630 chuck body without convex outer contours

Tool group A08  
Type 014  
**with base jaws and reversible top jaws ISO 702-1 (DIN 55026),**  
DIN 55021, ASA B 5.9, mounting from front

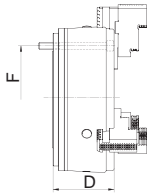

Item no.	Size	Mount short taper	Through-hole	D	F	Speed max. min-1	Torque Nm	Total clamping force kN
437591	160	4	42	76	82,62	5400	40	30
437592	160	5	42	79	104,8	5400	40	30
437593	200	5	52	93	104,8	4600	60	48
437594	200	6	52	97	133,4	4600	60	48
437595	250	6	62	108	133,4	4200	70	66
437596	315	6	87	124	133,4	3300	80	80
437597	315	8	87	130	171,4	3300	80	80
437598	400	8	102	135	171,4	2200	90	95
437599	500	11	162	138	235	1900	100	102
437601 <sup>1)</sup>	630	15	252	167	330,2	1100	100	102

1) by conserving the precision  
2) at size 630 chuck body without convex outer contours

Tool group A08  
Type 015  
**with reversible one-piece jaws ISO 702-3 (DIN 55027),**  
with studs and locknuts

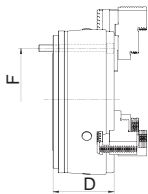

Item no.	Size	Mount short taper	Through-hole	D	F	Speed max. min-1	Torque Nm	Total clamping force kN
437497	125	3	32	60	75	6000	20	8,5
437498	125	4	32	60	85	6000	20	8,5
437499	125	5	32	67	104,8	6000	20	8,5
437500	160	4	42	76	85	5400	40	30
437501	160	5	42	78	104,8	5400	40	30
437502	160	6	42	85	133,4	5400	40	30
437503	200	4	52	94	85	4600	60	48
437504	200	5	52	96	104,8	4600	60	48
437505	200	6	52	97	133,4	4600	60	48
437506	200	8	52	108	171,4	4600	60	48
437507	250	4	62	105	85	4200	70	66
437508	250	5	62	107	104,8	4200	70	66
437509	250	6	62	108	133,4	4200	70	66
437510	250	8	62	110	171,4	4200	70	66
437511	315	6	87	127	133,4	3300	80	80
437512	315	8	87	129	171,4	3300	80	80
437513	315	11	87	131	235	3300	80	80
437514	400	6	102	138	133,4	2200	90	95
437515	400	8	102	138	171,4	2200	90	95
437516	400	11	102	138	235	2200	90	95
437517	400	15	102	160	330,2	2200	90	95
437518	500	8	135	156	171,4	1900	100	102
437519	500	11	162	156	235	1900	100	102
437520	500	15	162	163	330,2	1900	100	102

1) by conserving the precision

# DURO-T

Tool group A08  
Type 016  
**with base jaws only**  
**ISO 702-3 (DIN 55027),**  
with studs and locknuts

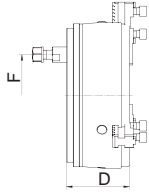

Item no.	Size	Mount short taper	Through-hole	D	F	Speed max. min-1	Torque Nm	Total clamping force kN
437521	125	3	32	60	75	6000	20	8,5
437522	125	4	32	60	85	6000	20	8,5
437523	125	5	32	67	104,8	6000	20	8,5
437524	160	4	42	76	85	5400	40	30
437525	160	5	42	78	104,8	5400	40	30
437526	160	6	42	85	133,4	5400	40	30
437527	200	4	52	94	85	4600	60	48
437528	200	5	52	96	104,8	4600	60	48
437529	200	6	52	97	133,4	4600	60	48
437530	200	8	52	108	171,4	4600	60	48
437531	250	4	60	105	85	4200	70	66
437532	250	5	62	107	104,8	4200	70	66
437533	250	6	62	108	133,4	4200	70	66
437534	250	8	62	110	171,4	4200	70	66
437535	315	6	87	127	133,4	3300	80	80
437536	315	8	87	129	171,4	3300	80	80
437537	315	11	87	131	235	3300	80	80
437538	400	6	102	138	133,4	2200	90	95
437539	400	8	102	138	171,4	2200	90	95
437540	400	11	102	138	235	2200	90	95
437541	400	15	102	160	330,2	2200	90	95
437542	500	8	135	156	171,4	1900	100	102
437543	500	11	162	156	235	1900	100	102
437544	500	15	162	163	330,2	1900	100	102
437545 <sup>1)</sup>	630	11	192	165	235	1100	100	102
437546 <sup>1)</sup>	630	15	252	167	330,2	1100	100	102

1) by conserving the precision  
2) at size 630 chuck body without convex outer contours

Tool group A08  
Type 018  
**with base jaws and reversible top jaws**  
**ISO 702-3 (DIN 55027),**  
with studs and locknuts

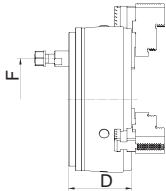

Item no.	Size	Mount short taper	Through-hole	D	F	Speed max. min-1	Torque Nm	Total clamping force kN
437547	160	4	42	76	85	5400	40	30
437548	160	5	42	78	104,8	5400	40	30
437549	160	6	42	85	133,4	5400	40	30
437550	200	4	52	94	85	4600	60	48
437551	200	5	52	96	104,8	4600	60	48
437552	200	6	52	97	133,4	4600	60	48
437553	200	8	52	108	171,4	4600	60	48
437554	250	4	60	105	85	4200	70	66
437555	250	5	62	107	104,8	4200	70	66
437556	250	6	62	108	133,4	4200	70	66
437557	250	8	62	110	171,4	4200	70	66
437558	315	6	87	127	133,4	3300	80	80
437559	315	8	87	129	171,4	3300	80	80
437560	315	11	87	131	235	3300	80	80
437561	400	6	102	138	133,4	2200	90	95
437562	400	8	102	138	171,4	2200	90	95
437563	400	11	102	138	235	2200	90	95
437564	400	15	102	160	330,2	2200	90	95
437565	500	8	135	156	171,4	1900	100	102
437566	500	11	162	156	235	1900	100	102
437567	500	15	162	163	330,2	1900	100	102
437568 <sup>1)</sup>	630	11	192	165	235	1100	100	105
437569 <sup>1)</sup>	630	15	252	167	330,2	1100	100	102

1) by conserving the precision  
2) at size 630 chuck body without convex outer contours

# DURO-T

Tool group A08  
Type 030  
**with reversible one-piece jaws**  
**ISO 702-2 (DIN 55029),**  
Stud for Camlock

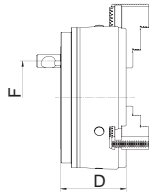

Item no.	Size	Mount short taper	Through-hole	D	F	Speed max. min-1	Torque Nm	Total clamping force kN
437602	125	3	32	67	70,66	6000	20	8,5
437603	125	4	32	68	82,6	6000	20	8,5
437604	160	4	42	83,5	82,6	5400	40	30
437605	160	5	42	87	104,8	5400	40	30
437606	160	6	42	104	133,4	5400	40	30
437607	200	4	52	97,5	82,6	4600	60	30
437608	200	5	52	101	104,8	4600	60	48
437609	200	6	52	106	133,4	4600	60	48
437610	200	8	52	125	171,4	4600	60	48
437611	250	4	60	118,5	82,6	4200	70	66
437612	250	5	62	112	104,8	4200	70	66
437613	250	6	62	117	133,4	4200	70	66
437614	250	8	62	120	171,4	4200	70	66
437615	315	6	87	145	133,4	3300	80	80
437616	315	8	87	136	171,4	3300	80	80
437617	315	11	87	143	235	3300	80	80
437618	400	6	102	153	133,4	2200	90	95
437619	400	8	102	141	171,4	2200	90	95
437620	400	11	102	148	235	2200	90	95
437621	400	15	102	168	330,2	2200	90	95
437622	500	8	135	143	171,4	1900	100	102
437623	500	11	162	148	235	1900	100	102
437624	500	15	162	153	330,2	1900	100	102

1) by conserving the precision

Tool group A08  
Type 031  
**with base jaws only**  
**ISO 702-2 (DIN 55029),**  
Stud for Camlock

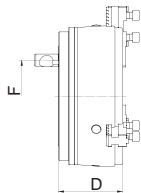

Item no.	Size	Mount short taper	Through-hole	D	F	Speed max. min-1	Torque Nm	Total clamping force kN
437625	125	3	32	67	70,66	6000	20	8,5
437626	125	4	32	68	82,6	6000	20	8,5
437627	160	4	42	83,5	82,6	5400	40	30
437628	160	5	42	87	104,8	5400	40	30
437629	160	6	42	104	133,4	5400	40	30
437630	200	4	52	97,5	82,6	4600	60	48
437631	200	5	52	101	104,8	4600	60	48
437632	200	6	52	106	133,4	4600	60	48
437633	200	8	52	125	171,4	4600	60	48
437634	250	4	60	118,5	82,6	4200	70	66
437635	250	5	62	112	104,8	4200	70	66
437636	250	6	62	117	133,4	4200	70	66
437637	250	8	62	120	171,4	4200	70	66
437638	315	6	87	145	133,4	3300	80	80
437639	315	8	87	136	171,4	3300	80	80
437640	315	11	87	143	235	3300	80	80
437641	400	6	102	153	133,4	2200	90	95
437642	400	8	102	141	171,4	2200	90	95
437643	400	11	102	148	235	2200	90	100
437644	400	15	102	168	330,2	2200	90	95
437645	500	8	135	143	171,4	1900	100	102
437646	500	11	162	148	235	1900	100	102
437647	500	15	162	153	330,2	1900	100	102
437648 <sup>1)</sup>	630	11	192	170	235	1100	100	102
437649 <sup>1)</sup>	630	15	252	175	330,2	1100	100	102

1) by conserving the precision

2) at size 630 chuck body without convex outer contours

# DURO-T

Tool group A08  
Type 033  
**with base jaws and reversible top jaws**  
ISO 702-2 (DIN 55029),  
Stud for Camlock

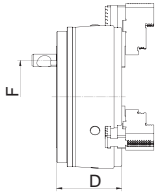

Item no.	Size	Mount short taper	Through-hole	D	F	Speed max. min-1	Torque Nm	Total clamping force kN
437650 ■	160	4	42	83,5	82,6	5400	40	30
437651 ■	160	5	42	87	104,8	5400	40	30
437652 ■	160	6	42	104	133,4	5400	40	30
437653 ■	200	4	52	97,5	82,6	4600	60	48
437654 ■	200	5	52	101	104,8	4600	60	48
437655 ■	200	6	52	106	133,4	4600	60	48
437656 ■	200	8	52	125	171,4	4600	60	48
437657 ■	250	4	60	118,5	82,6	4200	70	66
437658 ■	250	5	62	112	104,8	4200	70	66
437659 ■	250	6	62	117	133,4	4200	70	66
437660 ■	250	8	62	120	171,4	4200	70	66
437661 ■	315	6	87	145	133,4	3300	80	80
437662 ■	315	8	87	136	171,4	3300	80	80
437663 ■	315	11	87	143	235	3300	80	80
437664 ■	400	6	102	153	133,4	2200	90	95
437665 ■	400	8	102	141	171,4	2200	90	95
437666 ■	400	11	102	148	235	2200	90	95
437667 ■	400	15	102	168	330,2	2200	90	95
437668 ▲	500	8	135	143	171,4	1900	100	102
437669 ▲	500	11	162	148	235	1900	100	102
437670 ▲	500	15	162	153	330,2	1900	100	102
437671 <sup>1)</sup> ▲	630	11	192	170	235	1100	100	102
437672 <sup>1)</sup> ▲	630	15	252	175	330,2	1100	100	102

1) by conserving the precision  
2) at size 630 chuck body without convex outer contours

# Jaws DURO-T

Tool group A28  
Type 000 **One-piece jaw EB**, set  
hardened

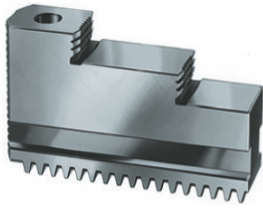

Item no.	Chuck Size	Number of jaws	Contents of delivery	Jaw length	Jaw height	Jaw width
212121 ●	125	3	set	50	34	14
094000 ●	160	3	set	77,7	45	20
094001 ●	200	3	set	94,7	60	22
094002 ●	250	3	set	114	70	26
094003 ●	315	3	set	130	79	32
094043 ●	400/500	3	set	167	93	45

Stepped and hardened jaws, supplied as supplement or as spares, must be ground on the chuck.  
In case of a subsequent jaw delivery please return the chuck.

Tool group A28  
Type 000 **Unstepped Jaw BL**, set  
unstepped, soft, material 16MnCr5

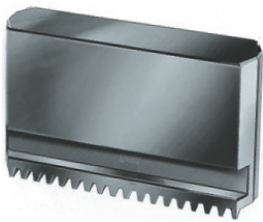

Item no.	Chuck Size	Number of jaws	Contents of delivery	Jaw length	Jaw height	Jaw width
304864 ●	125	3	set	53	34	14
241699 ●	160	3	set	84,4	45	20
249678 ●	200	3	set	98,4	60	22
249679 ●	250	3	set	118,7	70	26
249680 ●	315	3	set	136,6	79	32
249681 ●	400/500	3	set	173,6	93	45

Tool group A28  
Type 003 **Reversible top jaw UB**, set  
hardened



Item no.	Chuck Size	Number of jaws	Contents of delivery	Jaw length	Jaw height	Jaw width
094012 ●	160	3	set	61,5	32,5	20,4
094013 ●	200	3	set	70,5	38	24,4
094014 ●	250	3	set	92	50	34,4
094015 ●	315	3	set	107	56	35,7
094045 ●	400/500	3	set	130	72	50,4
140715 ●	630	3	Satz	185	102	68

Hardened jaws, supplied as supplement or as spares, must be ground on the chuck.  
In case of a subsequent jaw delivery please return the chuck.

Tool group A28  
Type 002 **Unstepped top jaw AB**, set  
standard design, soft, material  
16MnCr5



Item no.	Chuck Size	Number of jaws	Contents of delivery	Jaw length	Jaw height	Jaw width
212123 ●	125	3	set	55	25,5	20,7
094008 ●	160	3	set	85	36,5	20,3
094009 ●	200	3	set	105	40	22
094010 ●	250	3	set	125	50	30,4
094011 ●	315	3	set	145	50	34,3
094046 ●	400/500	3	set	180	73	50,5
140716 ●	630	3	set	260	102	68

Tool group A28  
Type 002 **Unstepped top jaw AB**, set  
extendend design, soft, material  
16MnCr5

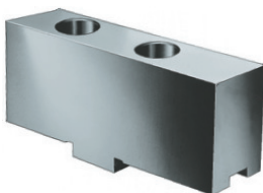

Item no.	Chuck Size	Number of jaws	Contents of delivery	Jaw length	Jaw height	Jaw width
137055 ●	160	3	set	85	42,5	24,4
137056 ●	200	3	set	105	51	34,3
137057 ●	250	3	set	125	75	50,5
137058 ●	315	3	set	145	74	50,5

# Jaws DURO-T

Tool group A28  
Type 002 **Base jaw GB**, set  
with mounting bolts

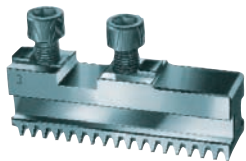

Item no.	Chuck Size	Number of jaws	Contents of delivery	Jaw length	Jaw width
212119 ●	125	3	set	47	14
094004 ●	160	3	set	74	20
094005 ●	200	3	set	90	22
094006 ●	250	3	set	110	26
094007 ●	315	3	set	125	32
094044 ●	400/500	3	set	160	45
140194 ●	630	3	set	230	65

Tool group C15  
Type 0040-Y **Jaw mounting bolt**,  
piece



Item no.	Size	Thread
243893 ●	125	M6x10
200182 ●	160/200	M8x1x22
200183 ●	250	M12x1,5x30
202402 ●	315	M12x1,5x35
227618 ●	400/500	M16x1,5x40
249388 ●	630	M20x50

## Accessories DURO-T

Tool group A08

Type 004 **Rough adaptor plate** for DURO-chucks  
with **cylindrical centre mount**

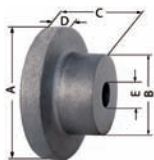

Item no.	Chuck Size	A	B	C	D	E
206652 ■	160	155	80	60	40	30
206653 ■	200	195	80	65	40	40
206654 ■	250	245	120	90	45	50
206655 ■	314	310	165	100	45	50
229081 ■	400	390	230	130	50	70
241780 ■	500	475	240	145	50	80

Tool group A08

Type 000 **Base plate with fixing slots**  
complete with mounting screws and fixed T-slot nuts.  
Other sizes available on request.



Item no.	Size
143163 ■	160
143165 ■	200
143167 ■	250

Tool group A08

Type 000 **Key**



Item no.	Size	Square	L
212124 ●	125	8	85
094016 ●	160	10	140
094017 ●	200	12	160
094018 ●	250	14	220
094019 ●	315	17	230
094047 ●	500	19	250
332938 ●	630	24	410

only for stationary used chucks

Tool group A08

Type 000 **Safety key**



Item no.	Size	Square	L
242172 ●	125	8	85
242173 ●	160	10	140
242174 ●	200	12	160
242175 ●	250	14	220
242176 ●	315	17	230
242177 ●	500	19	250
332939 ●	630	24	410

corresponding with DIN 1550 for rotating chucks

Tool group A08

Type 000 **Chip guard, set**



Item no.	Contents of delivery	Size
212122 ■	set	125
236439 ■	set	160
236440 ●	set	200
236441 ●	set	250
236442 ●	set	315
236443 ●	set	500

Tool group C15

Type 1028 **Special grease F80** for **lathe chucks**  
for lubrication and conservation of chucking power



Item no.	Design	Contents
630886 ●	tube	0,1 kg
308555 ●	cartridge	0,5 kg
028975 ●	tin	1,0 kg

# Chuck dimensions DURO-T

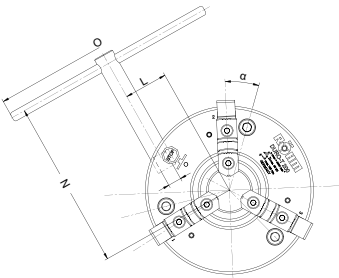
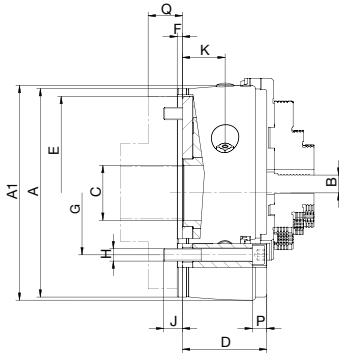

Chuck size A		125	160	200	250	315	400	500	630
Outer-Ø	A1	128	164	206	256	322	407	507	630
Jaw movement	B	4,8	6,2	6,8	8	10,2	12,5	12,5	14
Bore	C	32	42	52	62	87	102	162	252
Bore can be enlarged	C max.	35	45	55	75	102	130	180	270
	D	46,5	63	81	92	111	118	118	143
	E <sup>H6</sup>	115	145	185	235	300	380	460	580
	F	4	5	5	6	6	6	6	6
	G	100	125	160	200	250	315	400	520
	H	3xM8	3xM10	3xM12	3xM16	3xM20	3xM24	3xM24	3xM24
	J	12	15	18	25	30	37	37	37
	K	22,5	31,5	43	47	59	57,7	57,5	72
	L	32,5	42	53,5	66,5	86	110	152,5	196
	M	SW8	SW10	SW12	SW14	SW17	SW19	SW19	SW24
	N	117	182	211	284	309	359	356	570
	O	180	210	270	450	500	600	600	600
	P	8,5	13	14	17	21	25	25	29
	Q	17	30	30	35	35	40	45	55
Min. thickness of flange									
Moment of inertia GD <sup>2</sup> 1)	kgm <sup>2</sup>	-	0,13	0,41	1,14	3,25	8,8	22	70
	α	21° 35'	22°	18°	19°	17°	20°	15°	69° 30'
approx. kg	kg	4,0	9,3	18,6	34,5	64	112	166	300

1) The moment of inertia was measured with base jaws but without top jaws or back plate

The bore could be enlarged (measure C, at surcharge)

■ Enlarged bore max.

### Max. permissible speed

The maximum permissible speed has been fixed so that 1/3 of the gripping force is still available as residual gripping force if the maximum gripping is applied and the chuck is fitted with its heaviest jaws. The jaws may not project beyond the outside diameter of the chuck. The chuck must be in perfect condition. The specification DIN 6386 Part 1 shall be observed.

Chuck size		125	160	200	250	315	400	500	630
Max. speed	min <sup>-1</sup>	6000	5400	4600	4200	3300	2200	1900	1100

### Gripping force

The gripping force is the sum total of all jaw forces acting radially on the stationary workpiece.

The specified gripping forces are standard values.

They apply to chucks in a perfect condition which have been lubricated with RÖHM grease F79 and F80.

Chuck size		125	160	200	250	315	400	500	630
Torque applied on key 1)	Nm	20	40	60	70	80	90	100	100
Total gripping force 1)	kN	8,5	30	48	66	80	95	102	102
Torque applied on key	Nm	40	120	155	190	210	260	320	350
Max. total gripping force	kN	23	73	114	185	240	260	290	320

1) Maintaining the accuracy

### Chuck capacities of jaw steps

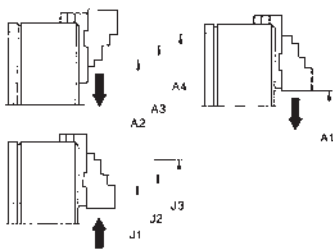

Chuck size		125	160	200	250	315	400	500	630	
External chucking	Jaw position	A1	3-30	5-51	7-70	8-97	12-131	16-168	64-256	30-322
		A2	31-65	45-91	58-123	82-172	93-216	119-278	167-360	200-490
		A3	63-97	89-135	114-179	-	-	-	-	-
		A4	95-129	115-161	142-207	163-253	201-323	260-413	308-501	360-650
Internal chucking	Jaw position	J1	26-59	67-105	71-131	99-182	102-213	120-272	166-360	184-489
		J2	57-91	93-132	99-159	-	-	-	-	-
		J3	89-123	135-174	154-214	178-261	207-319	260-412	306-500	341-646



# Jaw dimensions DURO-T

Reversible one-piece jaw **EB**, hardened and ground, jaw steps not ground

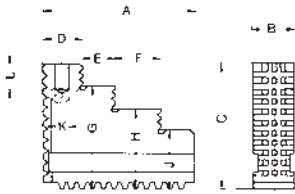

Block jaw **BL**, unstepped, soft, thread and jaw guides hardened and ground

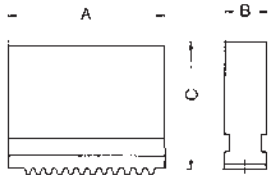

Chuck size	125	160	200	250	315	400+500
A	50	77,7	94,7	114	130	167
B	14	20	22	26	32	45
C	34	45	60	70	79	93
D	10,7	20,6	23	41,5	40,2	50,5
E	16	18,9	19,5	40,3	54	71
F	16	22	28	-	-	-
G	29	37,5	50	56	64	73
H	24	30	40	-	-	-
J	19	22,5	30	42	49	53
K	-	8	10	13	13	20
L	-	16	15	19,5	19,5	30
Jaw approx. kg	0,400	0,500	0,635	1,135	1,835	3,665

Chuck size	125	160	200	250	315	400+500
A	53	84,4	98,4	118,7	136,6	173,6
B	14	20	22	26	32	45
C	34	45	60	70	79	93
Jaw approx. kg	0,435	0,500	0,900	1,535	2,400	5

Reversible top jaw **UB**, completely hardened, cross tenon ground, jaw steps not ground

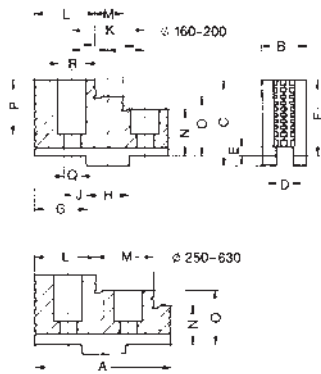

Chuck size	160	200	250	315	400+500	630
A	61,5	70,5	92	107	130	185
B	20,4	24,4	34,4	35,7	50,4	68
C	37	43	55	62	79	110
D	8	10	12	12	18	24
E	3	3,5	3,5	3,5	4,5	4,5
F	32,5	38	50	56	72	102
G	22,5	25,5	30	35,5	41,4	59
H	18	20	20	26	30	40
J	7	10	10	14	15	21
K	32	40	40	54	60	82
L	26,5	28,5	41	40	51	80
M	13	14	40,5	54	71	80
N	17,5	18	22	26	32	42
O	25	28	36	41	52	72
P	23,5	29	39	40	57	82
Q	9	9	14	14	18	22
R	15	15	20	20	26	33
T <sup>1)</sup>	38,5	45	57	63,6	80,6	114
Jaw approx. kg	0,200	0,335	0,800	1,135	2,535	6,350

<sup>1)</sup> Dimension marked on base jaw

Unstepped soft top jaw **AB**, for turning out special chucking diameters

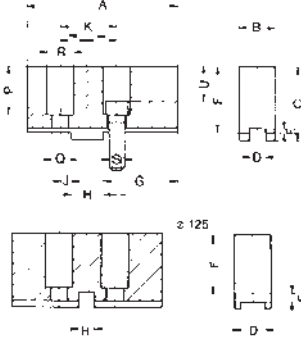

Chuck size	125	160	200	250	315	400+500	630
A	55	85	105	125	145	180	260
B	20,7	20,3	22	30,4	34,3	50,5	68
C	31,3	41	45	55	56	80	110
D	14	8	10	12	12	18	24
E	3,3	3	3,5	3,5	3,5	4,5	4,5
F	25,5	36,5	40	50	50	73	102
G	25	42	50	70	74	100	150
H	5	18	20	20	26	30	40
J	7,5	7	10	10	14	15	21
K	20	32	40	40	54	60	82
P	24	27,5	31	39	34	58	83
Q	6,5	9	9	14	14	18	22
R	11	15	15	20	20	26	33
S	M6	M8x1	M8x1	M12x1,5	M12x1,5	M16x1,5	M20
T <sup>1)</sup>	32	42,5	47	57	57,6	81,6	114
U	18	19,5	23	27	22	42	63
Jaw approx. kg	0,200	0,435	0,735	1,500	2,265	4,500	13,350

<sup>1)</sup> Dimension marked on base jaw

Base jaws **GB**, hardened and ground

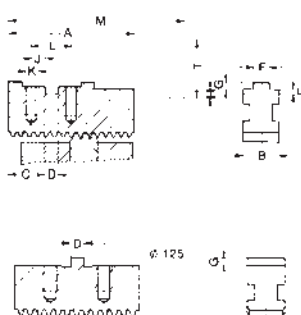

Chuck size	125	160	200	250	315	400+500	630
A	47	74	90	110	125	160	230
B	14	20	22	26	32	45	65
C	21	19	23	26	30	35	52
D	5	18	20	20	26	30	40
E	-	5	5,5	5,5	6,5	7,5	9
F	-	8	10	12	12	18	24
G	2,8	2,5	3	3	3	4	4
H	3,55	6	7	7	7,5	8,6	12
J	7,5	7	10	10	14	15	21
K	M6	M8x1	M8x1	M12x1,5	M12x1,5	M16x1,5	M20
L	20	32	40	40	54	60	82
M	72	103	129	163	196	250 294	399
Jaw approx. kg	0,200	0,265	0,365	0,700	1,065	2,350	5,665

Dimensions DURO-T

**DURO A**



DURO-key bar chucks are successfully used wherever extremely high tension forces, high concentric accuracy and reliable continuous repeatability are needed. For use on grinding machines.

The jaws can be quickly and easily reversed, exchanged or relocated over the entire gripping range. The jaws retain their accuracy if they are always used on the same chuck and when base jaws and top jaws are kept screwed together as a matched set for recurring work. It is therefore advisable to stock several jaw sets.

**Technical features:**

- with cover for protection against dust on the face
- with jaw safeguard
- self-centering
- steel body, jaw guides hardened and ground
- high speeds
- lathe chucks must be lubricated regularly to maintain their gripping force

Key bar chucks  
DURO A

Tool group A08  
Type 000  
**with out- and inward stepped jaws cylindrical centre mount**

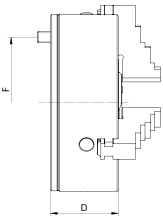

Item no.	Size	Inch	D	F	Speed max. min-1	Torque Nm	Total clamping force kN
329000 ▲	160	6 ¼	63	125	5400	40	25
329002 ▲	200	8	81	160	4600	60	40
329004 ▲	250	10	92	200	4200	70	55

Tool group A08  
Type 001  
**with base jaws only cylindrical centre mount**

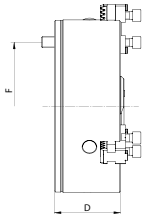

Item no.	Size	Inch	D	F	Speed max. min-1	Torque Nm	Total clamping force kN
329001 ▲	160	6 ¼	63	125	5400	40	25
329003 ▲	200	8	81	160	4600	60	40
329005 ▲	250	10	92	200	4200	70	55

Tool group A08  
Type 015  
**with out- and inward stepped jaws ISO 702-3 (DIN 55027); with studs and locknuts, optional DIN 55021 with set screw and nut**

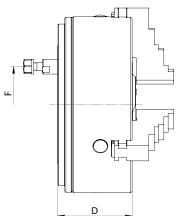

Item no.	Size	Mount short taper	D	F	Speed max. min-1	Torque Nm	Total clamping force kN
329006 ▲	160	4	76	85	5400	40	25
329012 ▲	160	5	80	104,8	5400	40	25
329008 ▲	200	4	94	85	4600	60	40
329014 ▲	200	5	96	104,8	4600	60	40
329018 ▲	200	6	97	133,4	4600	60	40
329010 ▲	250	4	105	85	4200	70	55
329016 ▲	250	5	107	104,8	4200	70	55
329020 ▲	250	6	108	133,4	4200	70	55

# DURO A

Tool group A08  
Type 016  
**with base jaws only**  
ISO 702-3 (DIN 55027);  
with studs and locknuts, optional  
DIN 55021 with set screw and nut

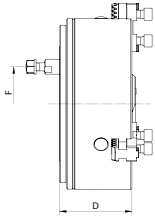

Item no.	Size	Mount short taper	D	F	Speed max. min-1	Torque Nm	Total clamping force kN
329007 ▲	160	4	76	85	5400	40	25
329013 ▲	160	5	80	104,8	5400	40	25
329009 ▲	200	4	94	85	4600	60	40
329015 ▲	200	5	96	104,8	4600	60	40
329019 ▲	200	6	97	133,4	4600	60	40
329011 ▲	250	4	105	85	4200	70	55
329017 ▲	250	5	107	104,8	4200	70	55
329021 ▲	250	6	108	133,4	4200	70	55

Tool group A08  
Type 030  
**with out- and inward stepped jaws**  
ISO 702-2 (DIN 55029);  
ASA B 5.9, Type D, with studs  
for Camlock

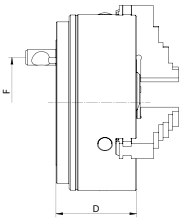

Item no.	Size	Mount short taper	D	F	Speed max. min-1	Torque Nm	Total clamping force kN
329022 ▲	160	4	76	85	5400	40	25
329028 ▲	160	5	86	104,8	5400	40	25
329024 ▲	200	4	94	85	4600	60	40
329030 ▲	200	5	96	104,8	4600	60	40
329034 ▲	200	6	97	133,4	4600	60	40
329026 ▲	250	4	105	85	4200	70	55
329032 ▲	250	5	107	104,8	4200	70	55
329036 ▲	250	6	108	133,4	4200	70	55

Tool group A08  
Type 031  
**with base jaws only**  
ISO 702-2 (DIN 55029);  
ASA B 5.9, Type D, with studs  
for Camlock

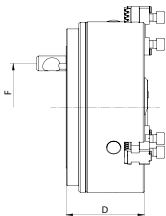

Item no.	Size	Mount short taper	D	F	Speed max. min-1	Torque Nm	Total clamping force kN
329023 ▲	160	4	76	85	5400	40	25
329029 ▲	160	5	86	104,8	5400	40	25
329025 ▲	200	4	94	85	4600	60	40
329031 ▲	200	5	96	104,8	4600	60	40
329035 ▲	200	6	97	133,4	4600	60	40
329027 ▲	250	4	105	85	4200	70	55
329033 ▲	250	5	107	104,8	4200	70	55
329037 ▲	250	6	108	133,4	4200	70	55

# Jaws DURO A

Tool group A28  
Type 000 **Outside jaw DB**, set  
inward stepped jaw, hardened

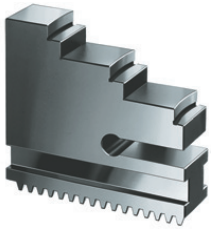

Item no.	Chuck Size	Jaw width
329041 <span style="color: yellow;">■</span>	160	20
329042 <span style="color: yellow;">■</span>	200	22
329043 <span style="color: yellow;">■</span>	250	26

Stepped and hardened jaws, supplied as supplement or as spares, must be ground on the chuck.  
In case of a subsequent jaw delivery please return the chuck.

Tool group A28  
Type 000 **Inside jaw BB**, set  
outward stepped jaw, hardened

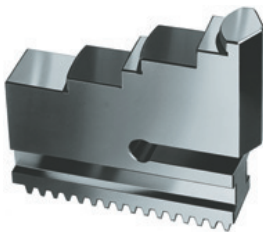

Item no.	Chuck Size	Jaw width
329038 <span style="color: yellow;">■</span>	160	20
329039 <span style="color: yellow;">■</span>	200	22
329040 <span style="color: yellow;">■</span>	250	26

Stepped and hardened jaws, supplied as supplement or as spares, must be ground on the chuck.  
In case of a subsequent jaw delivery please return the chuck.

Tool group A28  
Type 002 **Unstepped top jaw AB**, set  
soft, material 16MnCr5



Item no.	Chuck Size	Jaw length	Jaw height	Jaw width
329044 <span style="color: yellow;">■</span>	160	90	36,5	20,3
329045 <span style="color: yellow;">■</span>	200	100	40	22
094010 <span style="color: green;">●</span>	250	125	50	30,4

Tool group A28  
Type 002 **Base jaw GB**, set  
hardened, with mounting bolts

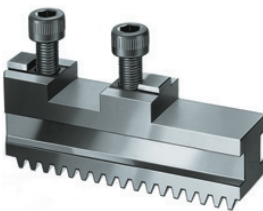

Item no.	Chuck Size	Jaw length	Jaw height	Jaw width
329047 <span style="color: yellow;">■</span>	160	74	8	20
329048 <span style="color: yellow;">■</span>	200	90	10	22
329049 <span style="color: yellow;">■</span>	250	110	12	26

Tool group C15  
Type 0040-Y **Jaw mounting bolt**,  
piece



Item no.	Size	Thread
243893 <span style="color: green;">●</span>	125	M6x10
200182 <span style="color: green;">●</span>	160/200	M8x1x22
200183 <span style="color: green;">●</span>	250	M12x1,5x30
202402 <span style="color: green;">●</span>	315	M12x1,5x35
227618 <span style="color: green;">●</span>	400/500	M16x1,5x40
249388 <span style="color: green;">●</span>	630	M20x50

# Accessories DURO A

Tool group A08

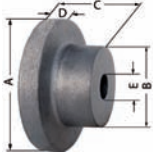
 Type 004 **Rough adaptor plate** for DURO-chucks with **cylindrical centre mount**

Item no.	Chuck Size	A	B	C	D	E
206652 <span style="color: yellow;">■</span>	160	155	80	60	40	30
206653 <span style="color: yellow;">■</span>	200	195	80	65	40	40
206654 <span style="color: yellow;">■</span>	250	245	120	90	45	50
206655 <span style="color: yellow;">■</span>	314	310	165	100	45	50
229081 <span style="color: yellow;">■</span>	400	390	230	130	50	70
241780 <span style="color: yellow;">■</span>	500	475	240	145	50	80

Tool group A08

 Type 000 **Base plate with fixing slots** complete with mounting screws and fixed T-slot nuts. Other sizes available on request.

Item no.	Size
143163 <span style="color: yellow;">■</span>	160
143165 <span style="color: yellow;">■</span>	200
143167 <span style="color: yellow;">■</span>	250

Tool group A08

 Type 000 **Key**

Item no.	Size	Square	L
212124 <span style="color: green;">●</span>	125	8	85
094016 <span style="color: green;">●</span>	160	10	140
094017 <span style="color: green;">●</span>	200	12	160
094018 <span style="color: green;">●</span>	250	14	220
094019 <span style="color: green;">●</span>	315	17	230
094047 <span style="color: green;">●</span>	500	19	250
332938 <span style="color: green;">●</span>	630	24	410

only for stationary used chucks

Tool group A08

 Type 000 **Safety key**

Item no.	Size	Square	L
242172 <span style="color: green;">●</span>	125	8	85
242173 <span style="color: green;">●</span>	160	10	140
242174 <span style="color: green;">●</span>	200	12	160
242175 <span style="color: green;">●</span>	250	14	220
242176 <span style="color: green;">●</span>	315	17	230
242177 <span style="color: green;">●</span>	500	19	250
332939 <span style="color: green;">●</span>	630	24	410

corresponding with DIN 1550 for rotating chucks

Tool group A08

 Type 000 **Chip guard, set**



Item no.	Contents of delivery	Size
212122 <span style="color: yellow;">■</span>	set	125
236439 <span style="color: yellow;">■</span>	set	160
236440 <span style="color: green;">●</span>	set	200
236441 <span style="color: green;">●</span>	set	250
236442 <span style="color: green;">●</span>	set	315
236443 <span style="color: green;">●</span>	set	500

Tool group C15

 Type 1028 **Special grease F80 for lathe chucks** for lubrication and conservation of chucking power

Item no.	Design	Contents
630886 <span style="color: green;">●</span>	tube	0,1 kg
308555 <span style="color: green;">●</span>	Cartridge	0,5 kg
028975 <span style="color: green;">●</span>	Tin	1 kg

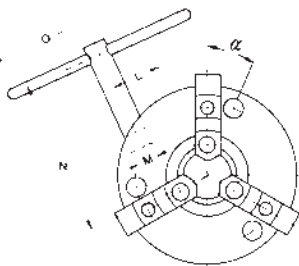
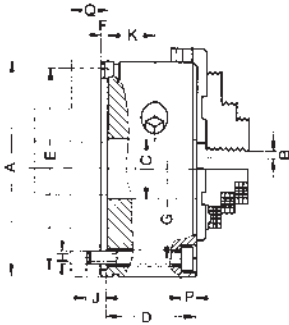
# Chuck dimensions DURO A



Chuck size		125	160	200	250	315	400	500	630
Outer diameter	A	125	160	206	255	318	400	500	630
Jaw movement	B	4,8	6,2	6,8	8	10,2	12,5	12,5	14
Bore	C	32	42	52	62	87	102	162	252
Bore can be enlarged	C max.	35	45	55	75	102	130	180	270
	D	46,5	63	81	92	111	118	118	143
	E/H6	115	145	185	235	300	380	460	580
	F	4	5	5	6	6	6	6	6
	G	100	125	160	200	250	315	400	520
	H	3xM8	3xM10	3xM12	3xM16	3xM20	3xM24	3xM24	3xM24
	J	12	15	18	25	30	37	37	37
	K	22,5	31,5	43	47	59	57,7	57,5	72
	L	32,5	42	53,5	66,5	86	110	152,5	196
	M	SW8	SW10	SW12	SW14	SW17	SW19	SW19	SW24
	N	117	182	211	284	309	359	356	570
	O	180	210	270	450	500	600	600	600
	P	8,5	13	14	17	21	25	25	29
	Q	17	30	30	35	35	40	45	55
Min. thickness of flange									
Moment of inertia GD <sup>2</sup> 1)	kgm <sup>2</sup>	-	0,13	0,41	1,14	3,25	8,8	22	70
	α	21° 35'	22°	18°	19°	20°	20°	15°	69° 30'
approx. kg	kg	3,5	9,5	20	35	64	105	165	300

1) The moment of inertia was measured with base jaws but without top jaws or back plate

The bore could be enlarged (measure C, at surcharge)

■ Enlarged bore max.

### Max. permissible speed

The maximum permissible speed has been fixed so that 1/3 of the gripping force is still available as residual gripping force if the maximum gripping is applied and the chuck is fitted with its heaviest jaws. The jaws may not project beyond the outside diameter of the chuck. The chuck must be in perfect condition. The specification DIN 6386 Part 1 shall be observed.

Chuck size		125	160	200	250	315	400	500	630
Max. speed	min <sup>-1</sup>	6000	5400	4600	4200	3300	2200	1900	1100

### Gripping force

The gripping force is the sum total of all jaw forces acting radially on the stationary workpiece.

The specified gripping forces are standard values.

They apply to chucks in a perfect condition which have been lubricated with RÖHM grease F79 and F80.

Chuck size		125	160	200	250	315	400	500	630
Torque applied on key in <sup>1)</sup>	Nm	20	40	60	70	80	90	100	100
Total gripping force <sup>1)</sup>	kN	8	25	40	55	67	85	93	93
Torque applied on key in	Nm	40	120	155	190	210	260	320	350
Max. total gripping force	kN	21	61	95	155	200	230	255	280

1) Maintaining the accuracy

### Chucking capacities of jaw steps

Chuck size		125	160	200	250	315	400	500	630	
External chucking	Jaw position.	A1	3-30	5-51	7-70	8-97	12-131	16-168	40-256	20-322
		A2	31-65	45-91	58-123	82-172	93-216	119-278	167-360	200-490
		A3	63-97	89-135	114-179	-	-	-	-	-
		A4	95-129	115-161	142-207	163-253	201-323	260-413	308-501	360-650
Internal chucking	Jaw position.	J1	26-59	67-105	71-131	99-182	102-213	120-272	166-360	184-489
		J2	57-91	93-132	99-159	-	-	-	-	-
		J3	89-123	135-174	154-214	178-261	207-319	260-412	306-500	341-646

### Chuck dimensions DURO A - Main dimensions (other dimensions on the table on the top)

Chuck size		160	200	250
Outer diameter	A	160	206	255
External chucking with BB-jaws		3-46	3-60	5-66
External chucking with DB-jaws		23-160	32-200	65-243
Internal chucking with BB-jaws		28-156	32-195	47-225
Central bor for coolant	B	13	13	13
	C	70	85	92
	D	5	6	5

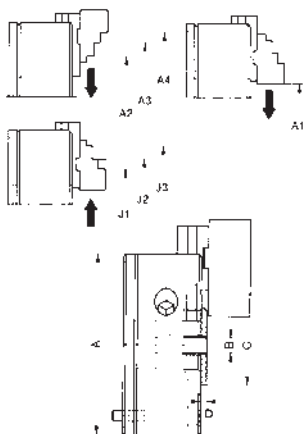

# Jaw dimensions and chucking capacity DURO A

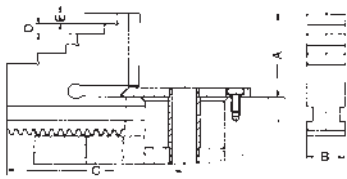

Outward stepped jaw **BB**

Chuck size	160	200	250
A	46	55	60
B	20	22	26
C max.	95	120	143,5
C min.	72	91	113
D	5	7	6
E	6	6	8
Jaw approx. kg	0,465	0,643	1,065

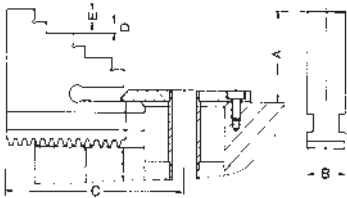

Inward stepped jaw **DB**

Chuck size	160	200	250
A	43	50	50
B	20	22	26
C max.	95	120	143,5
C min.	72	91	113
D	5	7	6
E	6	6	8
Jaw approx. kg	0,435	0,600	1,065

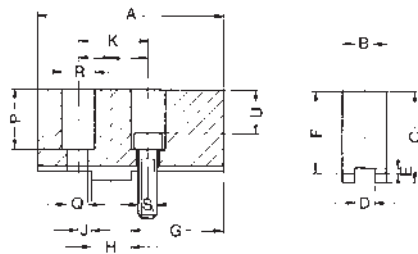

Unstepped soft top jaw **AB**

Chuck size	160	200	250
A	90	100	125
B	20,3	22	30
C	41	45	55
D	8	10	12
E	3	3,5	3,5
F	36,5	40	50
G	55	61	70
H	18	20	20
J	6	6	10
K	30	32	40
P	27,5	31	39
Q	9	9	14
R	15	15	20
S	M8x1	M8x1	M12x1,5
U	19,5	23	27
Jaw approx. kg	0,435	0,800	1,500

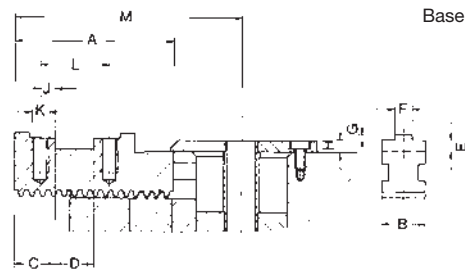

Base jaw **GB**

Chuck size	160	200	250
A	74	90	110
B	20	22	26
C	17	19	26
D	18	20	20
E	5	5,5	5,5
F	8	10	12
G	2,5	7	7
H	6	20	20
J	7	6	10
K	M8x1	M8x1	M12x1,5
L	32	32	40
M max.	105	127	148,5
M min.	91	103	125
Jaw approx. kg	0,335	0,365	0,700

External chucking

Internal chucking



Chucking capacities of jaw steps

Chucking type	Jaw position	A1	A2	A3	A4
		External chucking	3-46	23-76	74-118
Internal chucking	J1	3-60	32-88	87-144	143-200
	J2	5-66	65-125	124-184	183-243
	J3	47-107	106-166	165-225	

# Spiral chuck

This chuck is successfully established where high clamping forces, a high run-out accuracy and a good repeatability are required.

### Mechanism

The radial positioned Pinion (4) transmits the power via a bevel gearing to the Spiral Ring (3), where the spiral transmits it to the Jaws (5). Steel or cast iron body (1), Cover (2).

### Lubrication

Lathe chucks must be lubricated regularly to maintain their gripping force. Appropriate directions are included in the operating instructions supplied with each chuck. All lathe chucks are equipped with grease nipples for convenient maintenance.

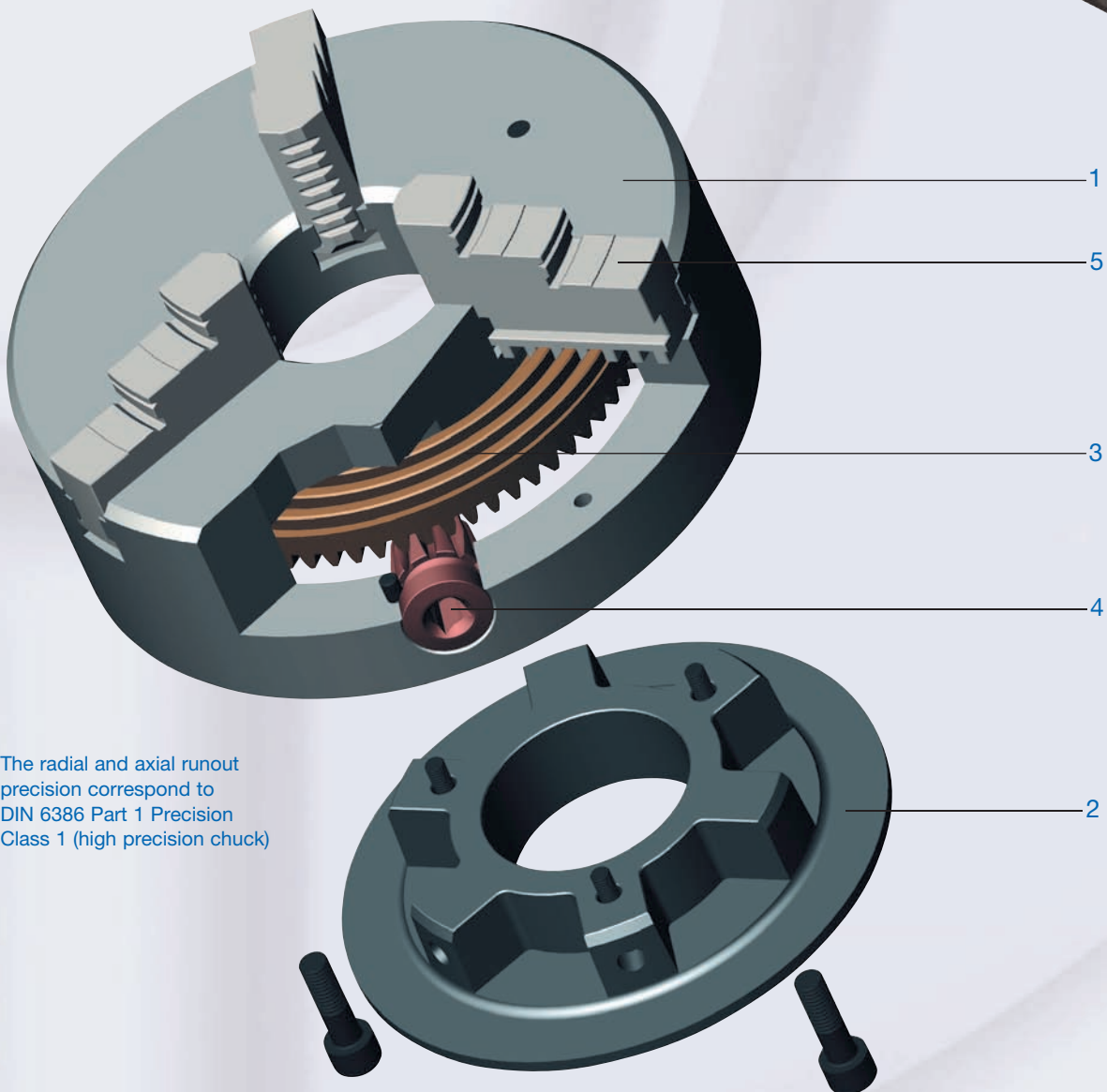

The radial and axial runout precision correspond to DIN 6386 Part 1 Precision Class 1 (high precision chuck)



**ZG-ZS**

The spiral ring chuck - a proven and universal suitable clamping system - finds its application wherever a high clamping force, high runout accuracy and very high repeatability are required. For use on lathes, rotary tables, dividing heads, etc.

The jaws can be moved across the entire clamping range by turning a key. Due to this, workpieces with different diameters can be clamped without changing or shifting the jaws. Special flat design with direct mounting.

**Technical features:**

- with one-piece jaws
- with scroll
- self-centering
- lathe chucks must be lubricated regularly to maintain their gripping force

**Delivery includes:**

- 1 set of outward stepped jaws (BB) mounted in the chuck,
- 1 set of inward stepped jaws (DB),
- 1 operating key, mounting bolts

Tool group A09  
Type 300 **3-jaw-chuck**  
**cast iron body**  
DIN 6350; cylindrical centre mount,  
form A

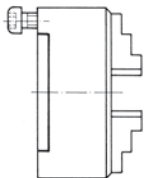

Item no.	Size	ZA	Through-hole	Speed max. min-1	Torque Nm	Total clamping force kN
102528 <sup>1)</sup> ●	74	56	15	5000	30	11
102509 ●	80	56	19	5000	30	13
112537 <sup>2)</sup> ●	85	60	19	5000	30	13
101781 ●	100	70	20	4500	60	27
112538 <sup>2)</sup> ●	110	80	27	4300	60	27
101628 ●	125	95	32	4000	80	31
105783 <sup>2)</sup> ●	140	105	40	3700	90	40
100300 ●	160	125	42	3600	110	47
100000 ●	200	160	55	3000	140	55
100200 ●	250	200	76	2500	150	63
101248 ●	315	260	103	2000	180	69
104132 <sup>2)</sup> ●	350	290	115	1700	210	74
102061 ●	400	330	136	1600	240	92
106753 ●	500	420	190	1000	260	100
102719 ●	630	545	240	800	280	105

<sup>1)</sup> with one set reversible jaws

<sup>2)</sup> intermediate size

Tool group A09  
Type 600 **3-jaw-chuck**  
**steel body**  
DIN 6350; cylindrical centre mount,  
form A

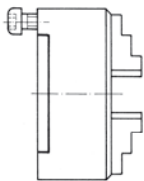

Item no.	Size	ZA	Through-hole	Speed max. min-1	Torque Nm	Total clamping force kN
102513 ●	80	56	19	7000	30	13
101782 ●	100	70	20	6300	60	27
101672 ●	125	95	32	5500	80	31
105784 <sup>1)</sup> ●	140	105	40	5000	90	40
100717 ●	160	125	42	4600	110	47
100186 ●	200	160	55	4000	140	55
100533 ●	250	200	76	3000	150	63
101344 ●	315	260	103	2300	180	69
104800 <sup>1)</sup> ●	350	290	115	1900	210	74
102062 ●	400	330	136	1800	240	92
102555 ●	500	420	190	1300	260	100
102720 ▲	630	545	240	850	280	105

<sup>1)</sup> intermediate size

Tool group A09  
Type 400 **4-jaw-chuck**  
**cast iron body**  
DIN 6350; cylindrical centre mount,  
form A

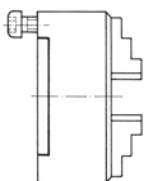

Item no.	Size	ZA	Through-hole	Speed max. min-1	Torque Nm	Total clamping force kN
102501 ●	80	56	19	5000	30	13
112591 <sup>1)</sup> ▲	85	60	19	5000	30	13
102129 ●	100	70	20	4500	60	27
112592 <sup>1)</sup> ●	110	80	27	4300	60	27
106074 ●	125	95	32	4000	80	31
105799 <sup>1)</sup> ●	140	105	40	3700	90	40
100325 ●	160	125	42	3600	110	47
100465 ●	200	160	55	3000	140	55
100834 ●	250	200	76	2500	150	63
101567 ●	315	260	103	2000	180	69
104868 <sup>1)</sup> ●	350	290	115	1700	210	74
102329 ●	400	330	136	1600	240	92
102954 ▲	500	420	190	1000	260	100
102855 ▲	630	545	240	800	280	105

<sup>1)</sup> intermediate size

# ZG-ZS

Tool group A09  
Type 800 **4-jaw-chuck**  
**steel body**  
DIN 6350; cylindrical centre mount,  
form A

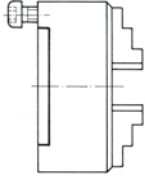

Item no.	Size	ZA	Through-hole	Speed max. min-1	Torque Nm	Total clamping force kN
102505 ●	80	56	19	7000	30	13
102130 ●	100	70	20	6300	60	27
106075 ●	125	95	32	5500	80	31
105800 <sup>1)</sup> ■	140	105	40	5000	90	40
101164 ●	160	125	42	4600	110	47
100466 ●	200	160	55	4000	140	55
101030 ●	250	200	76	3000	150	63
101598 ●	315	260	103	2300	180	69
104936 <sup>1)</sup> ▲	350	290	115	1900	210	74
102330 ■	400	330	136	1800	240	92
103340 ▲	500	420	190	1300	260	100
102856 ▲	630	545	240	850	280	105

<sup>1)</sup> intermediate size

Tool group A09  
Type 600 **6-jaw-chuck**  
**steel body**  
DIN 6350; cylindrical centre mount,  
form A

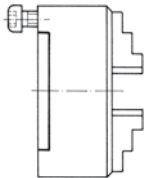

Item no.	Size	ZA	Through-hole	Speed max. min-1	Torque Nm	Total clamping force kN
138363 ▲	125	95	32	3300	80	31
118456 <sup>1)</sup> ▲	140	105	40	3100	90	40
121289 ▲	160	125	42	2700	110	47
114407 ▲	200	160	55	2400	140	55
114408 ▲	250	200	76	1800	150	63
122227 ▲	315	260	103	1400	180	69
176059 <sup>1)</sup> ▲	350	290	115	1150	210	74
123857 ▲	400	330	136	1100	240	92
153884 ▲	500	420	190	750	260	100
143993 ▲	630	545	240	510	280	105

<sup>1)</sup> intermediate size

Further dimensions on request

Tool group A09  
Type 315 **3-jaw-chuck**  
**cast iron body**  
ISO 702-3 (DIN 55027); with studs  
and locknuts, optional DIN 55021  
with set screw and nut

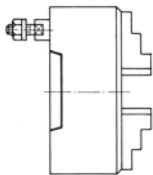

Item no.	Size	Mount short taper	Through-hole	Speed max. min-1	Torque Nm	Total clamping force kN
102105 ▲	100	3	20	4500	60	27
101644 ▲	125	3	32	4000	80	31
101648 ■	125	4	32	4000	80	31
105236 ■	140	3	40	3700	90	40
105237 ▲	140	4	40	3700	90	40
105238 ▲	140	5	40	3700	90	40
105012 ▲	160	3	42	3600	110	47
100358 ■	160	4	42	3600	110	47
100362 ●	160	5	42	3600	110	47
100053 ▲	200	3	51,2	3000	140	55
100057 ▲	200	4	55	3000	140	55
100045 ■	200	5	55	3000	140	55
100047 ■	200	6	55	3000	140	55
123120 ▲	250	4	60,7	2500	150	63
100241 ▲	250	5	76	2500	150	63
100239 ●	250	6	76	2500	150	63
100240 ■	250	8	76	2500	150	63
111195 ▲	315	5	79,6	2000	180	69
101268 ■	315	6	103	2000	180	69
101269 ■	315	8	103	2000	180	69
101270 ▲	315	11	103	2000	180	69
104156 ▲	350	6	103	1700	210	74
104148 ▲	350	8	115	1700	210	74
104152 ▲	350	11	115	1700	210	74
102217 ▲	400	6	103	1600	240	92
102201 ■	400	8	136	1600	240	92
102209 ■	400	11	136	1600	240	92
109734 ▲	500	8	136	1000	260	100
102547 ▲	500	11	190	1000	260	100
102914 ▲	500	15	190	1000	260	100
102751 ▲	630	11	192,7	800	280	105
102759 ▲	630	15	240	800	280	105

**ZG-ZS**

Tool group A09  
Type 615 **3-jaw-chuck**  
**steel body**  
ISO 702-3 (DIN 55027); with studs  
and locknuts, optional DIN 55021  
with set screw and nut

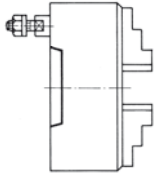

Item no.	Size	Mount short taper	Through-hole	Speed max. min-1	Torque Nm	Total clamping force kN
102106 ▲	100	3	20	6300	60	27
101688 ■	125	3	32	5500	80	31
101692 ●	125	4	32	5500	80	31
105556 ■	140	3	40	5000	90	40
105557 ●	140	4	40	5000	90	40
105558 ●	140	5	40	5000	90	40
105032 ■	160	3	42	4600	110	47
100740 ●	160	4	42	4600	110	47
100744 ●	160	5	42	4600	110	47
100160 ▲	200	3	51,2	4000	140	55
100164 ■	200	4	55	4000	140	55
100152 ●	200	5	55	4000	140	55
100156 ●	200	6	55	4000	140	55
123124 ▲	250	4	60,7	3000	150	63
100557 ■	250	5	76	3000	150	63
100555 ●	250	6	76	3000	150	63
100556 ●	250	8	76	3000	150	63
111193 ▲	315	5	79,6	2300	180	69
101364 ●	315	6	103	2300	180	69
101365 ●	315	8	103	2300	180	69
101366 ●	315	11	103	2300	180	69
104824 ▲	350	6	103	1900	210	74
104816 ▲	350	8	115	1900	210	74
104820 ▲	350	11	115	1900	210	74
102218 ▲	400	6	103	1800	240	92
102202 ■	400	8	136	1800	240	92
102210 ■	400	11	136	1800	240	92
104413 ▲	500	8	136	1300	260	100
102548 ■	500	11	190	1300	260	100
102915 ■	500	15	190	1300	260	100
102752 ▲	630	11	192,7	850	280	105
102760 ▲	630	15	240	850	280	105

Tool group A09  
Type 415 **4-jaw-chuck**  
**cast iron body**  
ISO 702-3 (DIN 55027); with studs  
and locknuts, optional DIN 55021  
with set screw and nut

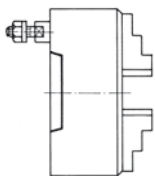

Item no.	Size	Mount short taper	Through-hole	Speed max. min-1	Torque Nm	Total clamping force kN
102153 ▲	100	3	20	4500	60	27
107006 ▲	125	3	32	4000	80	31
107014 ▲	125	4	32	4000	80	31
105249 ▲	140	3	40	3700	90	40
105250 ▲	140	4	40	3700	90	40
105251 ▲	140	5	40	3700	90	40
105052 ▲	160	3	42	3600	110	47
101109 ■	160	4	42	3600	110	47
101113 ■	160	5	42	3600	110	47
101429 ▲	200	3	51,2	3000	140	55
101437 ▲	200	4	55	3000	140	55
100471 ■	200	5	55	3000	140	55
101421 ■	200	6	55	3000	140	55
123122 ▲	250	4	60,7	2500	150	63
100856 ▲	250	5	76	2500	150	63
100854 ■	250	6	76	2500	150	63
100855 ■	250	8	76	2500	150	63
118915 ▲	315	5	79,6	2000	180	69
101585 ■	315	6	103	2000	180	69
101586 ■	315	8	103	2000	180	69
101587 ▲	315	11	103	2000	180	69
104892 ▲	350	6	103	1700	210	74
104884 ▲	350	8	115	1700	210	74
104888 ▲	350	11	115	1700	210	74
101891 ▲	400	6	103	1600	240	92
101875 ▲	400	8	136	1600	240	92
101883 ▲	400	11	136	1600	240	92
105630 ▲	500	8	136	1000	260	100
102970 ▲	500	11	190	1000	260	100
103226 ▲	500	15	190	1000	260	100
102887 ▲	630	11	192,7	800	280	105
103083 ▲	630	15	240	800	280	105

# ZG-ZS

Tool group A09  
Type 815 **4-jaw-chuck**  
**steel body**  
ISO 702-3 (DIN 55027); with studs  
and locknuts, optional DIN 55021  
with set screw and nut

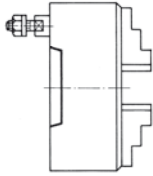

Item no.	Size	Mount short taper	Through-hole	Speed max. min-1	Torque Nm	Total clamping force kN
102154 ▲	100	3	20	6300	60	27
107007 ▲	125	3	32	5500	80	31
107015 ■	125	4	32	5500	80	31
105569 ▲	140	3	40	5000	90	40
105570 ■	140	4	40	5000	90	40
105571 ■	140	5	40	5000	90	40
105072 ▲	160	3	42	4600	110	47
101184 ■	160	4	42	4600	110	47
101188 ●	160	5	42	4600	110	47
101430 ▲	200	3	51,2	4000	140	55
101438 ▲	200	4	55	4000	140	55
100472 ●	200	5	55	4000	140	55
101422 ●	200	6	55	4000	140	55
123125 ▲	250	4	60,7	3000	150	63
101052 ▲	250	5	76	3000	150	63
101050 ●	250	6	76	3000	150	63
101051 ●	250	8	76	3000	150	63
127863 ▲	315	5	79,6	2300	180	69
101919 ■	315	6	103	2300	180	69
101923 ■	315	8	103	2300	180	69
101927 ■	315	11	103	2300	180	69
104960 ▲	350	6	103	1900	210	74
104952 ▲	350	8	115	1900	210	74
104956 ▲	350	11	115	1900	210	74
101892 ▲	400	6	103	1800	240	92
101876 ■	400	8	136	1800	240	92
101884 ■	400	11	136	1800	240	92
105656 ▲	500	8	136	1300	260	100
102971 ▲	500	11	190	1300	260	100
103227 ▲	500	15	190	1300	260	100
102888 ▲	630	11	192,7	850	280	105
103084 ▲	630	15	240	850	280	105

Tool group A09  
Type 320 **3-jaw-chuck**  
**cast iron body**  
ISO 702-1 (DIN 55026); DIN 55021,  
ASA B 5.9, A1/A2 metr.; mounting  
from front

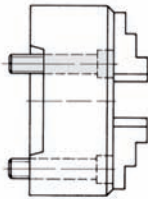

Item no.	Size	Mount short taper	Through-hole	Speed max. min-1	Torque Nm	Total clamping force kN
100371 <sup>1)</sup> ■	160	5	42	3600	110	47
100061 <sup>1)</sup> ■	200	5	42	3000	140	55
100067 <sup>1)</sup> ▲	200	6	55	3000	140	55
100257 ■	250	5	76	2500	150	63
100251 <sup>1)</sup> ■	250	6	55	2500	150	63
100254 <sup>1)</sup> ▲	250	8	76	2500	150	63
101280 ■	315	6	103	2000	180	69
101281 <sup>1)</sup> ▲	315	8	76	2000	180	69
114642 ▲	350	6	103	1700	210	74
116659 <sup>1)</sup> ▲	350	8	76	1700	210	74
102225 ▲	400	8	136	1600	240	92
102233 <sup>1)</sup> ▲	400	11	125	1600	240	92
102561 ▲	500	11	190	1000	260	100
102767 ▲	630	11	190	800	280	105
102783 <sup>1)</sup> ▲	630	15	190	800	280	105

<sup>1)</sup> mounting from front in the inner bolt circle

Tool group A09  
Type 620 **3-jaw-chuck**  
**steel body**  
ISO 702-1 (DIN 55026); DIN 55021,  
ASA B 5.9, A1/A2 metr.; mounting  
from front

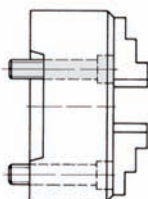

Item no.	Size	Mount short taper	Through-hole	Speed max. min-1	Torque Nm	Total clamping force kN
100753 <sup>1)</sup> ■	160	5	42	4600	110	47
100168 <sup>1)</sup> ■	200	5	42	4000	140	55
100173 <sup>1)</sup> ■	200	6	55	4000	140	55
100571 ▲	250	5	76	3000	150	63
100567 <sup>1)</sup> ■	250	6	55	3000	150	63
100569 <sup>1)</sup> ■	250	8	76	3000	150	63
101376 ■	315	6	103	2300	180	69
101377 <sup>1)</sup> ▲	315	8	76	2300	180	69
114643 ▲	350	6	103	1900	210	74
117319 <sup>1)</sup> ▲	350	8	76	1900	210	74
102226 ▲	400	8	136	1800	240	92
102234 <sup>1)</sup> ▲	400	11	125	1800	240	92
102562 ▲	500	11	190	1300	260	100
102768 ▲	630	11	190	850	280	105
102784 <sup>1)</sup> ▲	630	15	190	850	280	105

<sup>1)</sup> mounting from front in the inner bolt circle

**ZG-ZS**

Tool group A09  
Type 420 **4-jaw-chuck**  
**cast iron body**  
**ISO 702-1** (DIN 55026); DIN 55021,  
ASA B 5.9, A1/A2 metr.; mounting  
from front

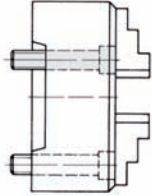

Item no.	Size	Mount short taper	Through-hole	Speed max. min-1	Torque Nm	Total clamping force kN
101121 <sup>1)</sup> ▲	160	5	42	3600	110	47
101445 <sup>1)</sup> ▲	200	5	42	3000	140	55
101453 <sup>1)</sup> ▲	200	6	55	3000	140	55
100868 ▲	250	5	76	2500	150	63
100866 <sup>1)</sup> ▲	250	6	55	2500	150	63
100867 <sup>1)</sup> ▲	250	8	76	2500	150	63
101597 ▲	315	6	103	2000	180	69
101938 <sup>1)</sup> ▲	315	8	76	2000	180	69
114644 ▲	350	6	103	1700	210	74
117057 <sup>1)</sup> ▲	350	8	76	1700	210	74
103322 ▲	400	8	136	1600	240	92
102360 <sup>1)</sup> ▲	400	11	125	1600	240	92
102978 ▲	500	11	190	1000	260	100
102895 ▲	630	11	190	800	280	105
103011 <sup>1)</sup> ▲	630	15	190	800	280	105

<sup>1)</sup> mounting from front in the inner bolt circle

Tool group A09  
Type 820 **4-jaw-chuck**  
**steel body**  
**ISO 702-1** (DIN 55026); DIN 55021,  
ASA B 5.9, A1/A2 metr.; mounting  
from front

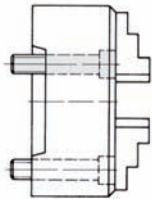

Item no.	Size	Mount short taper	Through-hole	Speed max. min-1	Torque Nm	Total clamping force kN
101196 <sup>1)</sup> ▲	160	5	42	4600	110	47
101446 <sup>1)</sup> ▲	200	5	42	4000	140	55
101454 <sup>1)</sup> ■	200	6	55	4000	140	55
101064 ▲	250	5	76	3000	150	63
101062 <sup>1)</sup> ▲	250	6	55	3000	150	63
101063 <sup>1)</sup> ▲	250	8	76	3000	150	63
101931 ▲	315	6	103	2300	180	69
101939 <sup>1)</sup> ▲	315	8	76	2300	180	69
127557 ▲	350	6	103	1900	210	74
117320 <sup>1)</sup> ▲	350	8	76	1900	210	74
102353 ▲	400	8	136	1800	240	92
102361 <sup>1)</sup> ▲	400	11	125	1800	240	92
102979 ▲	500	11	190	1300	260	100
102896 ▲	630	11	190	850	280	105
103012 <sup>1)</sup> ▲	630	15	190	850	280	105

<sup>1)</sup> mounting from front in the inner bolt circle

Tool group A09  
Type 330 **3-jaw-chuck**  
**cast iron body**  
**ISO 702-2** (DIN 55029); ASA B 5.9,  
Type D, with studs for Camlock

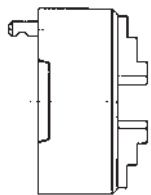

Item no.	Size	Mount short taper	Through-hole	Speed max. min-1	Torque Nm	Total clamping force kN
108677 ▲	100	3	20	4500	60	27
108678 ■	125	3	32	4000	80	31
108682 ▲	125	4	32	4000	80	31
108679 ▲	140	3	40	3700	90	40
108683 ■	140	4	40	3700	90	40
108686 ▲	140	5	40	3700	90	40
108680 ▲	160	3	42	3600	110	47
108684 ●	160	4	42	3600	110	47
108687 ■	160	5	42	3600	110	47
108681 ▲	200	3	51,2	3000	140	55
108685 ■	200	4	55	3000	140	55
108688 ■	200	5	55	3000	140	55
108691 ■	200	6	55	3000	140	55
127860 ▲	250	4	60,7	2500	150	63
108689 ■	250	5	76	2500	150	63
108692 ●	250	6	76	2500	150	63
108696 ■	250	8	76	2500	150	63
124918 ▲	315	5	79,6	2000	180	69
108693 ▲	315	6	103	2000	180	69
108697 ■	315	8	103	2000	180	69
108883 ■	315	11	103	2000	180	69
108695 ▲	350	6	103	1700	210	74
108699 ▲	350	8	115	1700	210	74
108887 ▲	350	11	115	1700	210	74
108694 ▲	400	6	103	1600	240	92
108698 ▲	400	8	136	1600	240	92
108884 ▲	400	11	136	1600	240	92
108834 ▲	500	8	136	1000	260	100
108885 ▲	500	11	190	1000	260	100
108888 ▲	500	15	190	1000	260	100
108886 ▲	630	11	192,7	800	280	105
108889 ▲	630	15	240	800	280	105

# ZG-ZS

Tool group A09  
Type 630 **3-jaw-chuck**  
**steel body**  
ISO 702-2 (DIN 55029); ASA B 5.9,  
Type D, with studs for Camlock

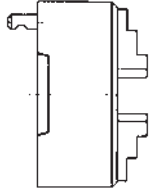

Item no.	Size	Mount short taper	Through-hole	Speed max. min-1	Torque Nm	Total clamping force kN
108890 ▲	100	3	20	6300	60	27
108891 ●	125	3	32	5500	80	31
108895 ■	125	4	32	5500	80	31
108892 ▲	140	3	40	5000	90	40
108896 ■	140	4	40	5000	90	40
108899 ▲	140	5	40	5000	90	40
108893 ■	160	3	42	4600	110	47
108897 ●	160	4	42	4600	110	47
109150 ●	160	5	42	4600	110	47
108894 ▲	200	3	51,2	4000	140	55
108898 ●	200	4	55	4000	140	55
109151 ●	200	5	55	4000	140	55
109154 ●	200	6	55	4000	140	55
127861 ▲	250	4	60,7	3000	150	63
109152 ■	250	5	76	3000	150	63
109155 ●	250	6	76	3000	150	63
109159 ●	250	8	76	3000	150	63
127862 ▲	315	5	79,6	2300	180	69
109156 ■	315	6	103	2300	180	69
109160 ●	315	8	103	2300	180	69
109165 ■	315	11	103	2300	180	69
109158 ▲	350	6	103	1900	210	74
109162 ▲	350	8	115	1900	210	74
109169 ▲	350	11	115	1900	210	74
109157 ▲	400	6	103	1800	240	92
109161 ▲	400	8	136	1800	240	92
109166 ▲	400	11	136	1800	240	92
109163 ▲	500	8	136	1300	260	100
109167 ▲	500	11	190	1300	260	100
109170 ▲	500	15	190	1300	260	100
109168 ▲	630	11	192,7	850	280	105
109171 ▲	630	15	240	850	280	105

Tool group A09  
Type 430 **4-jaw-chuck**  
**cast iron body**  
ISO 702-2 (DIN 55029); ASA B 5.9,  
Type D, with studs for Camlock

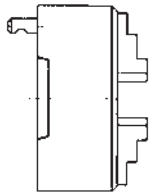

Item no.	Size	Mount short taper	Through-hole	Speed max. min-1	Torque Nm	Total clamping force kN
109017 ▲	100	3	20	4500	60	27
109172 ▲	125	3	32	4000	80	31
109176 ▲	125	4	32	4000	80	31
109173 ▲	140	3	40	3700	90	40
109177 ▲	140	4	40	3700	90	40
109180 ▲	140	5	40	3700	90	40
109178 ■	160	4	42	3600	110	47
109181 ▲	160	5	42	3600	110	47
109175 ▲	200	3	51,2	3000	140	55
109179 ■	200	4	55	3000	140	55
109182 ■	200	5	55	3000	140	55
109185 ■	200	6	55	3000	140	55
127864 ▲	250	4	60,7	2500	150	63
109183 ▲	250	5	76	2500	150	63
109186 ■	250	6	76	2500	150	63
109190 ▲	250	8	76	2500	150	63
127865 ▲	315	5	79,6	2000	180	69
109187 ▲	315	6	103	2000	180	69
109191 ▲	315	8	103	2000	180	69
109196 ▲	315	11	103	2000	180	69
109189 ▲	350	6	103	1700	210	74
109193 ▲	350	8	115	1700	210	74
109200 ▲	350	11	115	1700	210	74
109188 ▲	400	6	103	1600	240	92
109192 ▲	400	8	136	1600	240	92
109197 ▲	400	11	136	1600	240	92
109194 ▲	500	8	136	1000	260	100
109198 ▲	500	11	190	1000	260	100
109201 ▲	500	15	190	1000	260	100
109199 ▲	630	11	192,7	800	280	105
109202 ▲	630	15	240	800	280	105

**ZG-ZS**

Tool group A09  
 Type 830 **4-jaw-chuck**  
**steel body**  
**ISO 702-2** (DIN 55029); ASA B 5.9,  
 Type D, with studs for Camlock

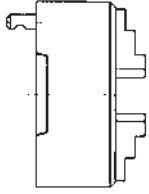

Item no.	Size	Mount short taper	Through-hole	Speed max. min-1	Torque Nm	Total clamping force kN
109203 ▲	100	3	20	6300	60	27
109204 ▲	125	3	32	5500	80	31
109208 ▲	125	4	32	5500	80	31
109205 ▲	140	3	40	5000	90	40
109209 ▲	140	4	40	5000	90	40
109212 ▲	140	5	40	5000	90	40
109210 ●	160	4	42	4600	110	47
109213 ●	160	5	42	4600	110	47
109207 ▲	200	3	51,2	4000	140	55
109211 ■	200	4	55	4000	140	55
109214 ●	200	5	55	4000	140	55
109217 ■	200	6	55	4000	140	55
127866 ▲	250	4	60,7	3000	150	63
109215 ▲	250	5	76	3000	150	63
109218 ●	250	6	76	3000	150	63
109222 ■	250	8	76	3000	150	63
127867 ▲	315	5	79,6	2300	180	69
109219 ▲	315	6	103	2300	180	69
109223 ■	315	8	103	2300	180	69
109228 ▲	315	11	103	2300	180	69
109221 ▲	350	6	103	1900	210	74
109225 ▲	350	8	115	1900	210	74
109232 ▲	350	11	115	1900	210	74
109220 ▲	400	6	103	1800	240	92
109224 ▲	400	8	136	1800	240	92
109229 ▲	400	11	136	1800	240	92
109226 ▲	500	8	136	1300	260	100
109230 ▲	500	11	190	1300	260	100
109233 ▲	500	15	190	1300	260	100
109231 ▲	630	11	192,7	850	280	105
109234 ▲	630	15	240	850	280	105

## ZG-ZS

Tool group A09  
Type 300 **3-jaw-chuck**  
**cast iron body**  
**mounting from front;** cylindrical  
centre mount

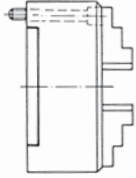

Item no.	Size	ZA	Through-hole	Speed max. min-1	Torque Nm	Total clamping force kN
116304 ●	125	95	32	4000	80	31
115566 ●	160	125	42	3600	110	47
109127 ●	200	160	55	3000	140	55
114301 ●	250	200	76	2500	150	63
109128 ■	315	260	103	2000	180	69
123474 ■	400	330	136	1600	240	92
117327 ■	500	420	190	1000	260	100
111346 ▲	630	545	240	800	280	105

Tool group A09  
Type 600 **3-jaw-chuck**  
**steel body**  
**mounting from front;** cylindrical  
centre mount

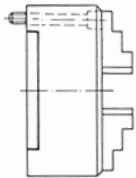

Item no.	Size	ZA	Through-hole	Speed max. min-1	Torque Nm	Total clamping force kN
120155 ●	125	95	32	5500	80	31
115568 ●	160	125	42	4600	110	47
113158 ●	200	160	55	4000	140	55
114304 ■	250	200	76	3000	150	63
120270 ■	315	260	103	2300	180	69
123475 ▲	400	330	136	1800	240	92
127616 ▲	500	420	190	1300	260	100
128545 ▲	630	545	240	850	280	105

Tool group A09  
Type 400 **4-jaw-chuck**  
**cast iron body**  
**mounting from front;** cylindrical  
centre mount

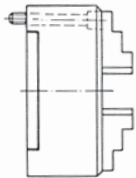

Item no.	Size	ZA	Through-hole	Speed max. min-1	Torque Nm	Total clamping force kN
103053 ■	125	95	32	4000	80	31
115570 ■	160	125	42	3600	110	47
111339 ■	200	160	55	3000	140	55
127916 ■	250	200	76	2500	150	63
120743 ■	315	260	103	2000	180	69
146263 ▲	400	330	136	1600	240	92
129858 ▲	500	420	190	1000	260	100
137545 ▲	630	545	240	800	280	105

Tool group A09  
Type 800 **4-jaw-chuck**  
**steel body**  
**mounting from front;** cylindrical  
centre mount

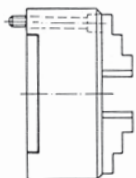

Item no.	Size	ZA	Through-hole	Speed max. min-1	Torque Nm	Total clamping force kN
124447 ■	125	95	32	5500	80	31
125802 ■	160	125	42	4600	110	47
113160 ■	200	160	55	4000	140	55
114306 ■	250	200	76	3000	150	63
129946 ■	315	260	103	2300	180	69
134401 ▲	400	330	136	1800	240	92
123465 ▲	500	420	190	1300	260	100
135061 ▲	630	545	240	850	280	105

Tool group A09  
Type 300 ZG **with base plate**  
**3-jaw-chuck cast iron body**

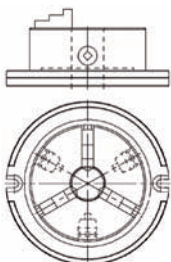

Item no.	Size	Through-hole	Torque Nm	Total clamping force kN
127857 ●	160	42	110	47
127858 ●	200	55	140	55
127859 ●	250	76	150	63
150594 ●	315	103	180	69



# Jaws ZG-ZS

Tool group A09  
Type 300 **Inside jaw BB DIN 6350**  
outward stepped jaw, hardened

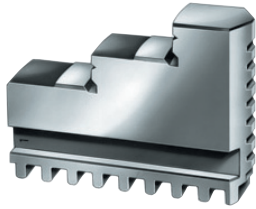

Item no.	Chuck Size	Number of jaws	Jaw length	Jaw height	Jaw width
110154 <sup>1)</sup> ●	74	3	32	23	10
110155 ●	80/85	3	37	26	12
110156 ●	100/110	3	48	33,5	14
110157 ●	125	3	52	41,5	18
110158 ●	140	3	61	41,5	18
110159 ●	160	3	61	47,5	18
110160 ●	200	3	69	53,5	20
110161 ●	250	3	90	67,5	24
110162 ●	315	3	130	79,5	34
110163 ●	350/400	3	130	79,5	34
110164 ▲	500/630	3	190	95	42

<sup>1)</sup> reversible, for use as turning or inside jaws  
Stepped and hardened jaws, supplied as supplement or as spares, must be ground on the chuck.  
In case of a subsequent jaw delivery please return the chuck.

Tool group A09  
Type 400 **Inside jaw BB DIN 6350**  
outward stepped jaw, hardened

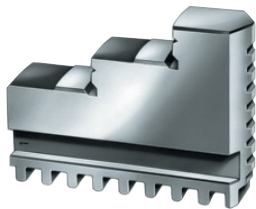

Item no.	Chuck Size	Number of jaws	Jaw length	Jaw height	Jaw width
110063 ▲	80/85	4	37	26	12
110064 ▲	100/110	4	48	33,5	14
110065 ●	125	4	52	41,5	18
110066 ▲	140	4	61	41,5	18
110067 ●	160	4	61	47,5	18
110068 ●	200	4	69	53,5	20
110069 ●	250	4	90	67,5	24
110070 ●	315	4	130	79,5	34
110071 ▲	350/400	4	130	79,5	34
110072 ▲	500/630	4	190	95	42

<sup>1)</sup> jaws reversible  
Stepped and hardened jaws, supplied as supplement or as spares, must be ground on the chuck.  
In case of a subsequent jaw delivery please return the chuck.

Tool group A09  
Type 300 **Outside jaw DB DIN 6350**  
inward stepped jaw, hardened

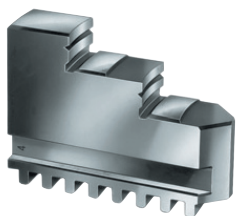

Item no.	Chuck Size	Number of jaws	Jaw length	Jaw height	Jaw width
110165 ●	80/85	3	37	26	12
110166 ●	100/110	3	48	33,5	14
110167 ●	125	3	52	41,5	18
110168 ●	140	3	61	41,5	18
110169 ●	160	3	61	47,5	18
110170 ●	200	3	69	53,5	20
110171 ●	250	3	90	67,5	24
110016 ●	315	3	130	79,5	34
110017 ●	350/400	3	130	79,5	34
110018 ▲	500/630	3	190	95	42

Stepped and hardened jaws, supplied as supplement or as spares, must be ground on the chuck.  
In case of a subsequent jaw delivery please return the chuck.

Tool group A09  
Type 400 **Outside jaw DB DIN 6350**  
inward stepped jaw, hardened

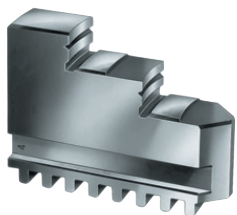

Item no.	Chuck Size	Number of jaws	Jaw length	Jaw height	Jaw width
110073 ▲	80/85/80/85	4	37	26	12
110074 ▲	100/110	4	48	33,5	14
110075 ●	125	4	52	41,5	18
110076 ▲	140	4	61	41,5	18
110077 ●	160	4	61	47,5	18
110078 ●	200	4	69	53,5	20
110079 ●	250	4	90	67,5	24
110080 ▲	315	4	130	79,5	34
110081 ▲	350/400	4	130	79,5	34
110082 ▲	500/630	4	190	95	42

Stepped and hardened jaws, supplied as supplement or as spares, must be ground on the chuck.  
In case of a subsequent jaw delivery please return the chuck.

# Jaws ZG-ZS

Tool group A09  
Type 301 **Unstepped jaw BL**  
**DIN 6350**  
unstepped, soft, 16MnCr5

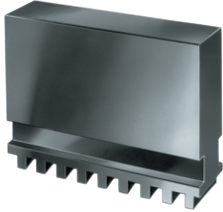

Item no.	Chuck Size	Number of jaws	Jaw length	Jaw height	Jaw width
109114 <sup>1)</sup> ●	74	3	32	23	10
107588 ●	80/85	3	37	26	12
107589 ●	100/110	3	48	33,5	14
107590 ●	125	3	52	41,5	18
107591 ●	140	3	61	41,5	18
107592 ●	160	3	61	47,5	18
107593 ●	200	3	69	53,5	20
107594 ●	250	3	90	67,5	24
107595 ●	315	3	130	79,5	34
107596 ●	350/400	3	130	79,5	34
107597 ●	500/630	3	190	95	42

<sup>1)</sup> jaws reversible

Tool group A09  
Type 401 **Unstepped jaw BL**  
**DIN 6350**  
unstepped, soft, 16MnCr5



Item no.	Chuck Size	Number of jaws	Jaw length	Jaw height	Jaw width
107598 ●	80/85	4	37	26	12
107599 ●	100/110	4	48	33,5	14
107600 ●	125	4	52	41,5	18
107601 ●	140	4	61	41,5	18
107602 ●	160	4	61	47,5	18
107603 ●	200	4	69	53,5	20
107604 ●	250	4	90	67,5	24
107605 ●	315	4	130	79,5	34
107644 ●	350/400	4	130	79,5	34
107645 ▲	500/630	4	190	95	42

<sup>1)</sup> jaws reversible

Tool group A09  
Type 302 **Base jaw GB** **DIN 6350**  
with fixing screw

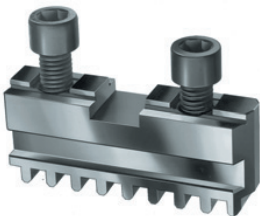

Item no.	Chuck Size	Number of jaws	Jaw length	Jaw width
107500 ●	100/110	3	46	14
107501 ●	125	3	55	18
107502 ●	140	3	65	18
107503 ●	160	3	65	18
107504 ●	200	3	78	20
107505 ●	250	3	92	24
107506 ●	315	3	108	34
107507 ●	350/400	3	127	34
107508 ●	500	3	165	42
107509 ●	630	3	203	42

Tool group A09  
Type 402 **Base jaw GB** **DIN 6350**  
with fixing screw

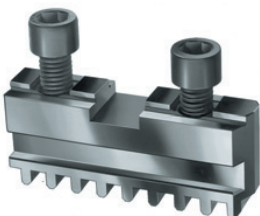

Item no.	Chuck Size	Number of jaws	Jaw length	Jaw width
107542 ●	100/110	4	46	14
107543 ●	125	4	55	18
107544 ▲	140	4	65	18
107545 ●	160	4	65	18
107546 ●	200	4	78	20
107547 ●	250	4	92	24
107548 ●	315	4	108	34
107549 ▲	350/400	4	127	34
107550 ▲	500	4	165	42
107551 ▲	630	4	203	42

# Jaws ZG-ZS

Tool group A09  
Type 303 **Reversible top jaws UB**  
**DIN 6350**  
hardened

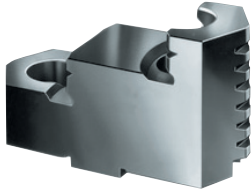

Item no.	Chuck Size	Number of jaws	Jaw length	Jaw height	Jaw width
108045 <span style="color: yellow;">■</span>	100/110	3	47	29,5	22
108046 <span style="color: yellow;">■</span>	125	3	56	37,5	26
107936 <span style="color: green;">●</span>	140/160	3	66,7	41,5	28
107937 <span style="color: green;">●</span>	200	3	79,5	42,5	30
108049 <span style="color: green;">●</span>	250	3	95,3	52,5	36
108050 <span style="color: green;">●</span>	315	3	109,5	57,5	42
108051 <span style="color: green;">●</span>	350/400	3	127	64,5	42
108052 <span style="color: yellow;">■</span>	500/630	3	127	79,5	50

Stepped and hardened jaws, supplied as supplement or as spares, must be ground on the chuck.  
In case of a subsequent jaw delivery please return the chuck.

Tool group A09  
Type 403 **Reversible top jaws UB**  
**DIN 6350**  
hardened

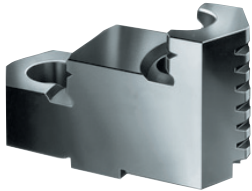

Item no.	Chuck Size	Number of jaws	Jaw length	Jaw height	Jaw width
108053 <span style="color: yellow;">■</span>	100/110	4	47	29,5	22
108054 <span style="color: yellow;">■</span>	125	4	56	37,5	26
107938 <span style="color: yellow;">■</span>	140/160	4	66,7	41,5	28
107939 <span style="color: yellow;">■</span>	200	4	79,5	42,5	30
108057 <span style="color: yellow;">■</span>	250	4	95,3	52,5	36
108058 <span style="color: yellow;">■</span>	315	4	109,5	57,5	42
108059 <span style="color: yellow;">■</span>	350/400	4	127	64,5	42
108060 <span style="color: yellow;">■</span>	500/630	4	127	79,5	50

Stepped and hardened jaws, supplied as supplement or as spares, must be ground on the chuck.  
In case of a subsequent jaw delivery please return the chuck.

Tool group A09  
Type 302 **Unstepped top jaw AB**  
**DIN 6350**  
soft, material 16MnCr5



Item no.	Chuck Size	Number of jaws	Jaw length	Jaw height	Jaw width
107633 <span style="color: green;">●</span>	100/110	3	53	30	22,5
107634 <span style="color: green;">●</span>	125	3	62	38	26,5
108581 <span style="color: green;">●</span>	140/160	3	74	42	28,5
108582 <span style="color: green;">●</span>	200	3	87	43	30,5
107637 <span style="color: green;">●</span>	250	3	103	53	36,5
107638 <span style="color: green;">●</span>	315	3	120	58	42,5
107639 <span style="color: green;">●</span>	350/400	3	137	65	42,5
107640 <span style="color: green;">●</span>	500/630	3	140	80	50,5

Tool group A09  
Type 402 **Unstepped top jaw AB**  
**DIN 6350**  
soft, material 16MnCr5



Item no.	Chuck Size	Number of jaws	Jaw length	Jaw height	Jaw width
107641 <span style="color: yellow;">■</span>	100/110	4	53	30	22,5
107642 <span style="color: green;">●</span>	125	4	62	38	26,5
108583 <span style="color: green;">●</span>	140/160	4	74	42	28,5
108584 <span style="color: green;">●</span>	200	4	87	43	30,5
107579 <span style="color: green;">●</span>	250	4	103	53	36,5
107580 <span style="color: green;">●</span>	315	4	120	58	42,5
107581 <span style="color: green;">●</span>	350/400	4	137	65	42,5
107582 <span style="color: green;">●</span>	500/630	4	140	80	50,5

## Jaws ZG-ZS

Tool group A09  
Type 301 **Unstepped jaw BL**,  
**special length**, soft, 16MnCr5  
DIN 6350

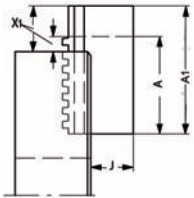

Item no.	Chuck Size	Number of jaws	A1	X1 max.	A	J	X Max.
130031	200	3	100	50	69	32,5	19
132658	250	3	120	56	90	41	26
132184	315	3	160	70	130	46	40
137075	350/400	3	160	70	130	42	40
131540	500/630	3	220	80	190	55	50
130033	200	3	120	70	69	32,5	19
128880	250	3	140	76	90	41	26
118908	315	3	200	110	130	46	40
137079	350/400	3	200	110	130	42	40
137081	500/630	3	280	140	190	55	50
121367	315	3	250	160	130	46	40
137087	350/400	3	250	160	130	42	40

Tool group A09  
Type 401 **Unstepped jaw BL**,  
**special length**, soft, 16MnCr5  
DIN 6350

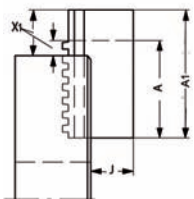

Item no.	Chuck Size	Number of jaws	A1	X1 max.	A	J	X Max.
137073	200	4	100	50	69	32,5	19
137074	250	4	120	56	90	41	26
129894	315	4	160	70	130	46	40
130442	350/400	4	160	70	130	42	40
137076	500/630	4	220	80	190	55	50
137077	200	4	120	70	69	32,5	19
130610	250	4	140	76	90	41	26
137078	315	4	200	110	130	46	40
137080	350/400	4	200	110	130	42	40
137082	500/630	4	280	140	190	55	50
133691	315	4	250	160	130	46	40
137088	350/400	4	250	160	130	42	40

Tool group A09  
Type 301 **Unstepped jaw BL**,  
**special height**, soft, 16MnCr5  
DIN 6350

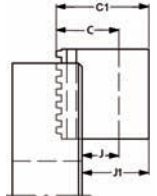

Item no.	Chuck Size	Number of jaws	C1	J1	C	J
125710	200	3	80	58,5	54	32,5
122188	250	3	100	73	68	41
132186	315	3	110	76	80	46
137092	350/400	3	110	72	80	42
137093	500/630	3	150	110	95	55
125712	200	3	120	98,5	54	32,5
122189	250	3	130	103	68	41
137096	315	3	140	106	80	46
137098	350/400	3	140	102	80	42
125117	500/630	3	200	160	95	55
125714	200	3	150	128,5	54	32,5
137102	250	3	150	123	68	41
137104	315	3	160	126	80	46
132879	350/400	3	160	122	80	42

# Jaws ZG-ZS

Tool group A09  
Type 401 **Unstepped jaw BL**,  
**special height**, soft, 16MnCr5  
DIN 6350

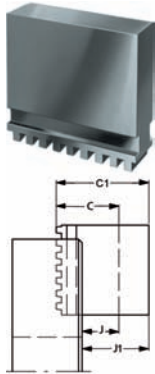

Item no.	Chuck Size	Number of jaws	C1	J1	C	J
132972	200	4	80	58,5	54	32,5
134796	250	4	100	73	68	41
137091	315	4	110	76	80	46
131655	350/400	4	110	72	80	42
137094	500/630	4	150	110	95	55
137095	200	4	120	98,5	54	32,5
130630	250	4	130	103	68	41
137097	315	4	140	106	80	46
137099	350/400	4	140	102	80	42
137100	500/630	4	200	160	95	55
137101	200	4	150	128,5	54	32,5
137103	250	4	150	123	68	41
130340	315	4	160	126	80	46
110109	350/400	4	160	122	80	42

Tool group A09  
Type 302 **Top jaw AB**,  
**special length**, soft, 16MnCr5  
DIN 6350

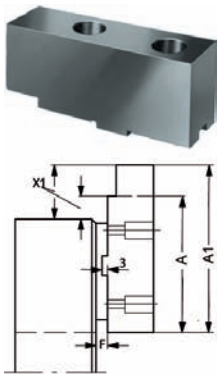

Item no.	Chuck Size	Number of jaws	A1	X1 max.	F	A	X Max.
110086	200	3	100	43	6,8	87	30
112122	250	3	130	63	8	103	36
110624	315	3	160	76	5,5	120	36
110626	350/400	3	160	53	8,5	137	30
103014	500/630	3	170	75	8,5	140	45
112120	200	3	120	63	6,8	87	30
125428	250	3	150	83	8	103	36
112091	315	3	200	116	5,5	120	36
112118	350/400	3	200	93	8,5	137	30
110632	500/630	3	220	125	8,5	140	45
104710	250	3	180	113	8	103	36
112089	315	3	250	166	5,5	120	36
103654	350/400	3	260	153	8,5	137	30
112127	500/630	3	280	185	8,5	140	45

Tool group A09  
Type 402 **Top jaw AB**,  
**special length**, soft, 16MnCr5  
DIN 6350

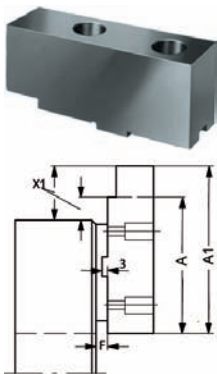

Item no.	Chuck Size	Number of jaws	A1	X1 max.	F	A	X Max.
148139	200	4	100	43	6,8	87	30
129289	250	4	130	63	8	103	36
143764	315	4	160	76	5,5	120	36
141277	350/400	4	160	53	8,5	137	30
103393	500/630	4	170	75	8,5	140	45
148657	200	4	120	63	6,8	87	30
128700	250	4	150	83	8	103	36
147754	315	4	200	116	5,5	120	36
141263	350/400	4	200	93	8,5	137	30
148234	500/630	4	220	125	8,5	140	45
146013	250	4	180	113	8	103	36
147860	315	4	250	166	5,5	120	36
149974	350/400	4	260	153	8,5	137	30
148235	500/630	4	280	185	8,5	140	45

# Jaws ZG-ZS

Tool group A09  
Type 302 **Top jaw AB,**  
**special height,** soft, 16MnCr5  
DIN 6350

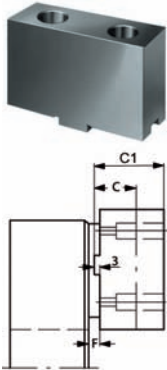

Item no.	Chuck Size	Number of jaws	C1	C	F
132155	200	3	60	43	6,8
119645	250	3	70	53	8
110435	315	3	80	58	5,5
126385	350/400	3	90	65	8,5
128590	500/630	3	100	80	8,5
128564	200	3	80	43	6,8
128571	250	3	100	53	8
110437	315	3	110	58	5,5
110628	350/400	3	120	65	8,5
110630	500/630	3	130	80	8,5
128573	250	3	150	53	8
128569	315	3	150	58	5,5
128567	350/400	3	160	65	8,5
128588	500/630	3	160	80	8,5

Tool group A09  
Type 402 **Top jaw AB,**  
**special height,** soft, 16MnCr5  
DIN 6350

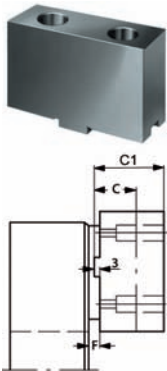

Item no.	Chuck Size	Number of jaws	C1	C	F
132181	200	4	60	43	6,8
135867	250	4	70	53	8
149975	315	4	80	58	5,5
118373	350/400	4	90	65	8,5
149985	500/630	4	100	80	8,5
149976	200	4	80	43	6,8
134999	250	4	100	53	8
129691	315	4	110	58	5,5
135426	350/400	4	120	65	8,5
149977	500/630	4	130	80	8,5
149978	250	4	150	53	8
141671	315	4	150	58	5,5
139591	350/400	4	160	65	8,5
140427	500/630	4	160	80	8,5

Tool group A09  
Type 302 **Top jaw AB,**  
**special width and height,** soft,  
16MnCr5, DIN 6350

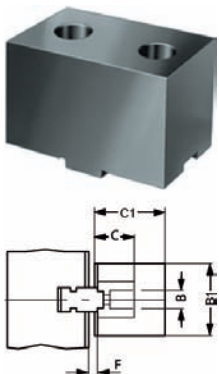

Item no.	Chuck Size	Number of jaws	B1	C1	B	C
105057	200	3	40	70	30.5	43
137090	250	3	50	80	36.5	53
143053	315	3	60	90	42	58
131567	350/400	3	60	90	42.5	65
137084	500/630	3	80	110	50.5	80
133259	200	3	50	80	30.5	43
133653	250	3	60	90	36.5	53
143057	315	3	80	110	42	58
137086	350/400	3	80	110	42.5	65

# Jaws ZG-ZS

Tool group A09  
Type 402 **Top jaw AB**,  
**special width and height**, soft,  
16MnCr5, DIN 6350

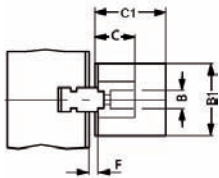
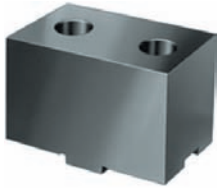

Item no.	Chuck Size	Number of jaws	B1	C1	B	C
105061 <span style="color: yellow;">■</span>	200	4	40	70	30,5	43
141338 <span style="color: yellow;">■</span>	250	4	50	80	36,5	53
149979 <span style="color: yellow;">■</span>	315	4	60	90	42	58
149980 <span style="color: yellow;">■</span>	350/400	4	60	90	42,5	65
149981 <span style="color: yellow;">■</span>	500/630	4	80	110	50,5	80
149982 <span style="color: yellow;">■</span>	200	4	50	80	30,5	43
137526 <span style="color: yellow;">■</span>	250	4	60	90	36,5	53
149983 <span style="color: yellow;">■</span>	315	4	80	110	42	58
149984 <span style="color: yellow;">■</span>	350/400	4	80	110	42,5	65

Tool group C15  
Type 0040-Y  
**Mounting bolt for top jaws  
bolt 1**



Item no.	Size	Thread
249299 <span style="color: green;">●</span>	100/110	M6x20
236949 <span style="color: green;">●</span>	125	M8x25
334571 <span style="color: green;">●</span>	140/160/200	M8x30
233025 <span style="color: green;">●</span>	250	M10x35
233026 <span style="color: green;">●</span>	315	M12x45
220565 <span style="color: green;">●</span>	350/400	M16x50
249003 <span style="color: green;">●</span>	500/630	M20x80

Tool group C15  
Type 0040-Y  
**Mounting bolt for top jaws  
bolt 2**



Item no.	Size	Thread
216528 <span style="color: green;">●</span>	100/110	M6x16
233058 <span style="color: green;">●</span>	125/140/160/200	M8x20
227692 <span style="color: green;">●</span>	250	M12x25
233030 <span style="color: green;">●</span>	315	M12x30
220564 <span style="color: green;">●</span>	350/400	M16x35
233047 <span style="color: green;">●</span>	500/630	M20x40

# Accessories ZG-ZS

**Tool group A09**

 Type 600 **Base plates** for lathe chucks with **cylindrical centre mount** DIN 6350

Item no.	Size
162793 ■	160
162401 ■	200
163036 ■	250
133705 ■	315

**Tool group A09**

 Type 304 **Unfinished adapter plates** for **cylindrical mount**

The unfinished back plate must be machined and fitted on both machine and chuck side

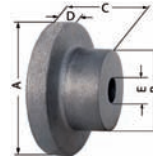

Item no.	Chuck Size	Inch	A	B	C	D	E
017123 ■	74	3	80	56	45	15	-
017113 ●	80	3 ¼	92	56	47	15	20
017114 ●	100	4	120	80	58	20	25
017115 ●	125	5	135	80	58	20	25
017125 ■	140	5 ½	150	80	58	20	25
017116 ●	160	6 ¼	170	80	58	20	30
017117 ●	200	8	210	92	66	22	40
017118 ■	250	10	260	105	92	25	50
017119 ■	315	12 ½	330	165	100	30	50
017124 ■	350	14	365	180	120	30	60

**Tool group A09**

 Type 300 **Chip guard, piece**

Item no.	Contents of delivery	Size
108500 ■	piece	80/85
108501 ●	piece	100/110
108502 ●	piece	125
108503 ●	piece	140/160
108504 ●	piece	200
108505 ●	piece	250
108506 ●	piece	315/350/400
108508 ●	piece	500/630

**Tool group C15**

 Type 1028 **Special grease F80** for **lathe chucks** for lubrication and conservation of chucking power

Item no.	Design	Contents
028975 ●	Tin	1 kg

**Tool group A09**

 Type 300 **Scroll**

Item no.	Size
102521 ●	74
102183 ●	80/85
101754 ●	100
112660 ●	110
101721 ●	125
105827 ●	140
100303 ●	160
100003 ●	200
100203 ●	250
101552 ●	315
105228 ■	350
102497 ●	400
162973 ■	500
162964 ■	630

**Tool group A09**

 Type 300 **Driving pinion**

Item no.	Size
102522 ■	74
102184 ●	80
113198 ■	85
101755 ●	100
112662 ●	110
101722 ●	125
105828 ●	140
100304 ●	160
100005 ●	200
100204 ●	250
101553 ●	315
105229 ●	350
102498 ●	400
162974 ■	500
162965 ■	630

**Tool group A09**

 Type 300 **Pinion holder screw**

Item no.	Size
102523 ■	74
102185 ●	85
100305 ●	160
100006 ●	270
101554 ●	315
102499 ●	400
103300 ●	630

**Tool group A09**

 Type 300 **Standard key**

Item no.	Size	Square	Hexagon	Length
006325 ●	74	-	6	55
107426 ●	80/85	6	-	62
107427 ●	100/110	8	-	75
107428 ●	125/140	9	-	80
107429 ●	160	10	-	90
107430 ●	200/230	11	-	100
107431 ●	250/270	12	-	100
107432 ●	315	14	-	110
107433 ●	350	14	-	140
107434 ●	400	17	-	140
107435 ●	500/630	19	-	150



# Accessories ZG-ZS

Tool group A09

Type 300 **Safety key**



Item no.	Size	Square	Length
154370	80/85	6	110
154371	100/110	8	130
154372	125/140	9	130
154373	160	10	160
154374	200/230	11	160
154375	250/270	12	160
154376	315	14	200
154377	350	14	200
154378	400	17	250
154379	500/630	19	250

Tool group A09

Type 300 **Elongated safety key**



Item no.	Size	Square	Length
154683	125/140	9	170
154685	160	10	180
154687	200/230	11	200
154689	250/270	12	200
154695	315	14	250

Tool group C15

Type 0040-Y **Mounting screws** with **cylindrical centre rim**



Item no.	Size	Thread
249299	74-85	M6x20
334571	100-140	M8x30
249301	160-230	M10x35
233025	250-270	M10x35
220565	315-350	M16x50
229183	400-630	M16x60

Tool group C15

Type 0040-Y **Mounting screws** for lathe chucks with **direct short-taper, for front mounting**



Item no.	Size	Thread	Chuck Size	Taper size
302195	74	M10x55	160	5
200184	80	M10x65	200	5
233006	85	M12x65	200	6
233075	100	M10x90	250	5
216549	110	M12x70	250	6
302194	125	M16x70	250	8
242954	140	M12x100	315	6
358816	160	M16x85	315	8
243665	200/230	M12x130	350	6
236516	315	M16x110	400	8
615744	350	M20x95	400	11
010210	400	M20x130	500	11
328925	500	M20x145	630	11
367648	630	M24x125	630	15

Tool group A09

Type 310 **Set screw with nut DIN 55021**



Item no.	Thread	For taper	Quantity
107453	M10x30	4	3
107455	M10x35	5	4
107456	M12x40	6	4
107457	M16x45	8	4
107458	M20x55	11	6
127618	M24x65	15	6

Tool group A09

Type 315 **Stud and locknut ISO 702-3 (DIN 55027)**



Item no.	Thread	For taper	Quantity
107447	M10x34	3	3
107448	M10x39	4	3
107449	M10x43	5	4
107450	M12x50	6	4
107451	M16x60	8	4
107452	M20x75	11	6
125650	M24x90	15	6
130636	M24x100	20	6

Tool group A09

Type 330 **Stud for Camlock ISO 702-2 (DIN 55029) and cylindrical studs**



Item no.	Thread	For taper	Quantity
107465	7/16-20x35	3	3
107466	7/16-20x37	4	3
107467	1/2-20x43	5	6
107468	5/8-18x49	6	6
107469	3/4-16x55,5	8	6
107470	7/8-14x67	11	6
127621	1-14x76	15	6
130637	1 1/2-12x89	20	6

## ZGU-ZSU



The spiral ring chuck - a proven and universal suitable clamping system - finds its application wherever a high clamping force, high runout accuracy and very high repeatability are required (e. g. lathes, turntables, circular indexing tables, etc.).

Cross tenon to ISO 3442 and ASA B 5.8.

The jaws can be moved across the entire clamping range by turning a key. Due to this, workpieces with different diameters can be clamped without changing or shifting the jaws.

Special flat design with direct mounting.

### Technical features:

- with base jaws and reversible top jaws
- with scroll
- self-centering
- lathe chucks must be lubricated regularly to maintain their gripping force

### Delivery includes:

- 1 set of base jaws (GB),
- 1 set of reversible top jaws (UB),
- 1 operating key, mounting bolts

- The chucks ZGU/ZSU are also available as "Mounting from front with cylindrical centre mount" Please contact us for more information.

Tool group A09  
Type 303 **3-jaw-chuck**  
**cast iron body**  
DIN 6350; cylindrical centre mount,  
form A

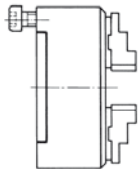

Item no.	Size	ZA	Through-hole	Speed max. min-1	Torque Nm	Total clamping force kN
101787	100	70	20	4500	60	27
114433 <sup>1)</sup>	110	80	27	4300	60	27
101634	125	95	32	4000	80	31
105789 <sup>1)</sup>	140	105	40	3700	90	40
100322	160	125	42	3600	110	47
100014	200	160	55	3000	140	55
100221	250	200	76	2500	150	63
101254	315	260	103	2000	180	69
104135 <sup>1)</sup>	350	290	115	1700	210	74
102067	400	330	136	1600	240	92
102537	500	420	190	1000	260	100
102725	630	545	240	800	280	105

<sup>1)</sup> intermediate size

Tool group A09  
Type 603 **3-jaw-chuck**  
**steel body**  
DIN 6350; cylindrical centre mount,  
form A

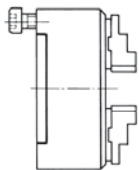

Item no.	Size	ZA	Through-hole	Speed max. min-1	Torque Nm	Total clamping force kN
101788	100	70	20	6300	60	27
101678	125	95	32	5500	80	31
105790 <sup>1)</sup>	140	105	40	5000	90	40
100725	160	125	42	4600	110	47
100189	200	160	55	4000	140	55
100541	250	200	76	3000	150	63
101350	315	260	103	2300	180	69
104803 <sup>1)</sup>	350	290	115	1900	210	74
102068	400	330	136	1800	240	92
102585	500	420	190	1300	260	100
102726	630	545	240	850	280	105

<sup>1)</sup> intermediate size

3-jaw-chucks "mounting from front" as cast iron or steel design available on request

Tool group A09  
Type 403 **4-jaw-chuck**  
**cast iron body**  
DIN 6350; cylindrical centre mount,  
form A

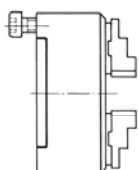

Item no.	Size	ZA	Through-hole	Speed max. min-1	Torque Nm	Total clamping force kN
102135	100	70	20	4500	60	27
114357 <sup>1)</sup>	110	80	27	4300	60	27
106080	125	95	32	4000	80	31
105805 <sup>1)</sup>	140	105	40	3700	90	40
100754	160	125	42	3600	110	47
100483	200	160	55	3000	140	55
100840	250	200	76	2500	150	63
101900	315	260	103	2000	180	69
104871 <sup>1)</sup>	350	290	115	1700	210	74
102335	400	330	136	1600	240	92
102960	500	420	190	1000	260	100
102861	630	545	240	800	280	105

<sup>1)</sup> intermediate size

# ZGU-ZSU

Tool group A09  
Type 803 **4-jaw-chuck**  
**steel body**  
DIN 6350; cylindrical centre mount,  
form A

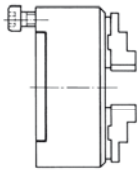

Item no.	Size	ZA	Through-hole	Speed max. min-1	Torque Nm	Total clamping force kN
102136 ▲	100	70	20	6300	60	27
106081 ▲	125	95	32	5500	80	31
105806 <sup>1)</sup> ▲	140	105	40	5000	90	40
101170 ■	160	125	42	4600	110	47
100484 ■	200	160	55	4000	140	55
101036 ■	250	200	76	3000	150	63
101901 ■	315	260	103	2300	180	69
104939 <sup>1)</sup> ▲	350	290	115	1900	210	74
102336 ▲	400	330	136	1800	240	92
103346 ▲	500	420	190	1300	260	100
102862 ▲	630	545	240	800	280	105

<sup>1)</sup> intermediate size  
4-jaw-chucks "mounting from front" as cast iron or steel design available on request

Tool group A09  
Type 603 **6-jaw-chuck**  
**steel body**  
DIN 6350; cylindrical centre mount,  
form A

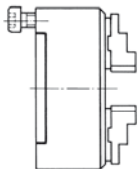

Item no.	Size	ZA	Through-hole	Speed max. min-1	Torque Nm	Total clamping force kN
143989 ▲	250	200	76	1800	150	63
151278 ▲	315	260	103	1400	180	69
176060 <sup>1)</sup> ▲	350	290	115	1150	210	74
149048 ▲	400	330	136	1100	240	92
152602 ▲	500	420	190	750	260	100
144048 ▲	630	545	240	510	280	105

<sup>1)</sup> intermediate size  
6-jaw-chucks "mounting from front" as cast iron or steel design available on request

Tool group A09  
Type 318 **3-jaw-chuck**  
**cast iron body**  
ISO 702-3 (DIN 55027), DIN 55022;  
with studs and locknuts, optional  
DIN 55021 with set screw and nut

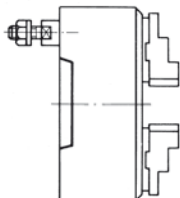

Item no.	Size	Mount short taper	Through-hole	Speed max. min-1	Torque Nm	Total clamping force kN
102111 ▲	100	3	20	4500	60	27
101647 ▲	125	3	32	4000	80	31
101651 ▲	125	4	32	4000	80	31
105522 ▲	140	3	40	3700	90	40
105523 ▲	140	4	40	3700	90	40
105524 ▲	140	5	40	3700	90	40
105015 ▲	160	3	42	3600	110	47
100361 ▲	160	4	42	3600	110	47
100366 ▲	160	5	42	3600	110	47
100056 ▲	200	3	51,2	3000	140	55
100060 ▲	200	4	55	3000	140	55
100051 ▲	200	5	55	3000	140	55
100052 ▲	200	6	55	3000	140	55
127868 ▲	250	4	60,7	2500	150	63
100250 ▲	250	5	76	2500	150	63
100248 ▲	250	6	76	2500	150	63
100249 ▲	250	8	76	2500	150	63
127869 ▲	315	5	79,6	2000	180	69
101277 ▲	315	6	103	2000	180	69
101278 ▲	315	8	103	2000	180	69
101279 ▲	315	11	103	2000	180	69
104159 ▲	350	6	103	1700	210	74
104151 ▲	350	8	115	1700	210	74
104155 ▲	350	11	115	1700	210	74
102223 ▲	400	6	103	1600	240	92
102207 ▲	400	8	136	1600	240	92
102215 ▲	400	11	136	1600	240	92
109737 ▲	500	8	136	1000	260	100
102553 ▲	500	11	190	1000	260	100
102920 ▲	500	15	190	1000	260	100
102757 ▲	630	11	192,7	800	280	105
102765 ▲	630	15	240	800	280	105

## ZGU-ZSU

Tool group A09  
Type 618 **3-jaw-chuck**  
**steel body**  
ISO 702-3 (DIN 55027), DIN 55022;  
with studs and locknuts, optional  
DIN 55021 with set screw and nut

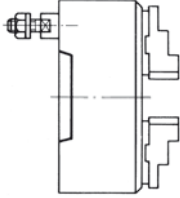

Item no.	Size	Mount short taper	Through-hole	Speed max. min-1	Torque Nm	Total clamping force kN
102112 ▲	100	3	20	6300	60	27
101691 ▲	125	3	32	5500	80	31
101695 ▲	125	4	32	5500	80	31
105742 ▲	140	3	40	5000	90	40
105743 ▲	140	4	40	5000	90	40
105744 ▲	140	5	40	5000	90	40
105035 ▲	160	3	42	4600	110	47
100743 ▲	160	4	42	4600	110	47
100747 ■	160	5	42	4600	110	47
100163 ▲	200	3	51,2	4000	140	55
100167 ▲	200	4	55	4000	140	55
100155 ▲	200	5	55	4000	140	55
100159 ●	200	6	55	4000	140	55
127870 ▲	250	4	60,7	3000	150	63
100566 ▲	250	5	76	3000	150	63
100564 ●	250	6	76	3000	150	63
100565 ■	250	8	76	3000	150	63
127871 ▲	315	5	79,6	2300	180	69
101373 ▲	315	6	103	2300	180	69
101374 ■	315	8	103	2300	180	69
101375 ▲	315	11	103	2300	180	69
104827 ▲	350	6	103	1900	210	74
104819 ▲	350	8	115	1900	210	74
104823 ▲	350	11	115	1900	210	74
102224 ▲	400	6	103	1800	240	92
102208 ▲	400	8	136	1800	240	92
102216 ■	400	11	136	1800	240	92
104456 ▲	500	8	136	1300	260	100
102554 ▲	500	11	190	1300	260	100
102921 ▲	500	15	190	1300	260	100
102758 ▲	630	11	192,7	850	280	105
102766 ▲	630	15	240	850	280	105

Tool group A09  
Type 418 **4-jaw-chuck**  
**cast iron body**  
ISO 702-3 (DIN 55027), DIN 55022;  
with studs and locknuts, optional  
DIN 55021 with set screw and nut

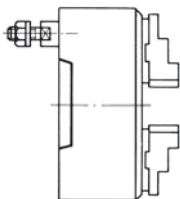

Item no.	Size	Mount short taper	Through-hole	Speed max. min-1	Torque Nm	Total clamping force kN
102159 ▲	100	3	20	4500	60	27
107012 ▲	125	3	32	4000	80	31
107020 ▲	125	4	32	4000	80	31
105539 ▲	140	3	40	3700	90	40
105540 ▲	140	4	40	3700	90	40
105541 ▲	140	5	40	3700	90	40
105055 ▲	160	3	42	3600	110	47
101112 ▲	160	4	42	3600	110	47
101116 ▲	160	5	42	3600	110	47
101435 ▲	200	3	51,2	3000	140	55
101443 ▲	200	4	55	3000	140	55
101419 ▲	200	5	55	3000	140	55
101427 ▲	200	6	55	3000	140	55
127876 ▲	250	4	60,7	2500	150	63
100865 ▲	250	5	76	2500	150	63
100863 ▲	250	6	76	2500	150	63
100864 ▲	250	8	76	2500	150	63
127877 ▲	315	5	79,6	2000	180	69
101594 ▲	315	6	103	2000	180	69
101595 ▲	315	8	103	2000	180	69
101596 ▲	315	11	103	2000	180	69
104895 ▲	350	6	103	1700	210	74
104887 ▲	350	8	115	1700	210	74
104891 ▲	350	11	115	1700	210	74
101897 ▲	400	6	103	1600	240	92
101881 ▲	400	8	136	1600	240	92
101889 ▲	400	11	136	1600	240	92
105633 ▲	500	8	136	1000	260	100
102976 ▲	500	11	190	1000	260	100
103232 ▲	500	15	190	1000	260	100
102893 ▲	630	11	192,7	800	280	105
103089 ▲	630	15	240	800	280	105

**ZGU-ZSU**

Tool group A09  
Type 818 **4-jaw-chuck**  
**steel body**  
ISO 702-3 (DIN 55027); DIN 55022;  
with studs and locknuts, optional  
DIN 55021 with set screw and nut

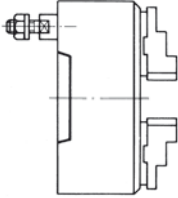

Item no.	Size	Mount short taper	Through-hole	Speed max. min-1	Torque Nm	Total clamping force kN
102160 ▲	100	3	20	6300	60	27
107013 ▲	125	3	32	5500	80	31
107021 ▲	125	4	32	5500	80	31
105759 ▲	140	3	40	5000	90	40
105760 ▲	140	4	40	5000	90	40
105761 ▲	140	5	40	5000	90	40
105075 ▲	160	3	42	4600	110	47
101187 ▲	160	4	42	4600	110	47
101191 ■	160	5	42	4600	110	47
101436 ▲	200	3	51,2	4000	140	55
101444 ▲	200	4	55	4000	140	55
101420 ▲	200	5	55	4000	140	55
101428 ■	200	6	55	4000	140	55
127880 ▲	250	4	60,7	3000	150	63
101061 ▲	250	5	76	3000	150	63
101059 ●	250	6	76	3000	150	63
101060 ■	250	8	76	3000	150	63
127881 ▲	315	5	79,6	2300	180	69
101922 ▲	315	6	103	2300	180	69
101926 ■	315	8	103	2300	180	69
101930 ▲	315	11	103	2300	180	69
104963 ▲	350	6	103	1900	210	74
104955 ▲	350	8	115	1900	210	74
104959 ▲	350	11	115	1900	210	74
101898 ▲	400	6	103	1800	240	92
101882 ▲	400	8	136	1800	240	92
101890 ▲	400	11	136	1800	240	92
105666 ▲	500	8	136	1300	260	100
102977 ▲	500	11	190	1300	260	100
103233 ▲	500	15	190	1300	260	100
102894 ▲	630	11	192,7	850	280	105
103090 ▲	630	15	240	850	280	105

Tool group A09  
Type 323 **3-jaw-chuck**  
**cast iron body**  
ISO 702-1 (DIN 55026); DIN 55021,  
ASA B 5.9, A1/A2 metr.; mounting  
from front

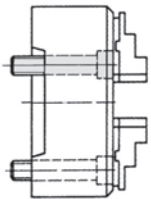

Item no.	Size	Mount short taper	Through-hole	Speed max. min-1	Torque Nm	Total clamping force kN
100376 <sup>1)</sup> ▲	160	5	42	3600	110	47
100066 <sup>1)</sup> ▲	200	5	42	3000	140	55
100071 <sup>1)</sup> ▲	200	6	55	3000	140	55
100268 ▲	250	5	76	2500	150	63
100266 <sup>1)</sup> ▲	250	6	55	2500	150	63
100267 <sup>1)</sup> ▲	250	8	76	2500	150	63
101289 ▲	315	6	103	2000	180	69
101290 <sup>1)</sup> ▲	315	8	76	2000	180	69
127810 ▲	350	6	103	1700	210	74
127803 <sup>1)</sup> ▲	350	8	76	1700	210	74
102231 ▲	400	8	136	1600	240	92
102239 <sup>1)</sup> ▲	400	11	125	1600	240	92
102567 ▲	500	11	190	1000	260	100
102773 ▲	630	11	190	800	280	105
102789 <sup>1)</sup> ▲	630	15	190	800	280	105

<sup>1)</sup> mounting from front in the inner bolt circle

Tool group A09  
Type 623 **3-jaw-chuck steel body**  
ISO 702-1 (DIN 55026); DIN 55021,  
ASA B 5.9, A1/A2 metr.; mounting  
from front

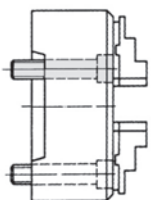

Item no.	Size	Mount short taper	Through-hole	Speed max. min-1	Torque Nm	Total clamping force kN
100757 <sup>1)</sup> ▲	160	5	42	4600	110	47
100172 <sup>1)</sup> ▲	200	5	42	4000	140	55
100177 <sup>1)</sup> ▲	200	6	55	4000	140	55
100580 ▲	250	5	76	3000	150	63
100578 <sup>1)</sup> ▲	250	6	55	3000	150	63
100579 <sup>1)</sup> ▲	250	8	76	3000	150	63
101385 ▲	315	6	103	2300	180	69
101386 <sup>1)</sup> ▲	315	8	76	2300	180	69
127848 ▲	350	6	103	1900	210	74
127847 <sup>1)</sup> ▲	350	8	76	1900	210	74
102232 ▲	400	8	136	1800	240	92
102240 <sup>1)</sup> ▲	400	11	125	1800	240	92
102568 ▲	500	11	190	1300	260	100
102774 ▲	630	11	190	850	280	105
102790 <sup>1)</sup> ▲	630	15	190	850	280	105

<sup>1)</sup> mounting from front in the inner bolt circle

## ZGU-ZSU

Tool group A09  
Type 423 **4-jaw-chuck**  
**cast iron body**  
ISO 702-1 (DIN 55026); DIN 55021,  
ASA B 5.9, A1/A2 metr.; mounting  
from front

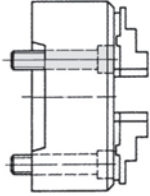

Item no.	Size	Mount short taper	Through-hole	Speed max. min-1	Torque Nm	Total clamping force kN
101124 <sup>1)</sup> ▲	160	5	42	3600	110	47
101451 <sup>1)</sup> ▲	200	5	42	3000	140	55
101459 <sup>1)</sup> ▲	200	6	55	3000	140	55
100877 ▲	250	5	76	2500	150	63
100875 <sup>1)</sup> ▲	250	6	55	2500	150	63
100876 <sup>1)</sup> ▲	250	8	76	2500	150	63
101936 ▲	315	6	103	2000	180	69
101944 <sup>1)</sup> ▲	315	8	76	2000	180	69
127846 ▲	350	6	103	1700	210	74
127845 <sup>1)</sup> ▲	350	8	76	1700	210	74
102358 ▲	400	8	136	1600	240	92
102366 <sup>1)</sup> ▲	400	11	125	1600	240	92
102984 ▲	500	11	190	1000	260	100
103001 ▲	630	11	190	800	280	105
103017 <sup>1)</sup> ▲	630	15	190	800	280	105

<sup>1)</sup> mounting from front in the inner bolt circle

Tool group A09  
Type 823 **4-jaw-chuck**  
**steel body**  
ISO 702-1 (DIN 55026); DIN 55021,  
ASA B 5.9, A1/A2 metr.; mounting  
from front

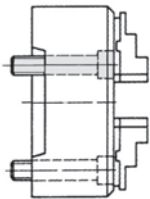

Item no.	Size	Mount short taper	Through-hole	Speed max. min-1	Torque Nm	Total clamping force kN
101199 <sup>1)</sup> ▲	160	5	42	4600	110	47
101452 <sup>1)</sup> ▲	200	5	42	4000	140	55
101460 <sup>1)</sup> ▲	200	6	55	4000	140	55
101073 ▲	250	5	76	3000	150	63
101071 <sup>1)</sup> ▲	250	6	55	3000	150	63
101072 <sup>1)</sup> ▲	250	8	76	3000	150	63
101937 ▲	315	6	103	2300	180	69
101945 <sup>1)</sup> ▲	315	8	76	2300	180	69
127850 ▲	350	6	103	1900	210	74
127849 <sup>1)</sup> ▲	350	8	76	1900	210	74
102359 ▲	400	8	136	1800	240	92
102367 <sup>1)</sup> ▲	400	11	125	1800	240	92
102985 ▲	500	11	190	1300	260	100
103002 ▲	630	11	190	850	280	105
103018 <sup>1)</sup> ▲	630	15	190	850	280	105

<sup>1)</sup> mounting from front in the inner bolt circle

Tool group A09  
Type 333 **3-jaw-chuck**  
**cast iron body**  
ISO 702-2 (DIN 55029); ASA B 5.9,  
Type D, with studs for Camlock

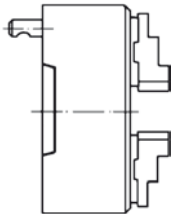

Item no.	Size	Mount short taper	Through-hole	Speed max. min-1	Torque Nm	Total clamping force kN
105842 ▲	100	3	20	4500	60	27
105850 ▲	125	3	32	4000	80	31
105866 ▲	125	4	32	4000	80	31
106306 ▲	160	3	42	3600	110	47
105874 ▲	160	4	42	3600	110	47
105890 ▲	160	5	42	3600	110	47
106354 ▲	200	3	51,2	3000	140	55
106370 ▲	200	4	55	3000	140	55
106322 ▲	200	5	55	3000	140	55
106338 ▲	200	6	55	3000	140	55
127872 ▲	250	4	60,7	2500	150	63
106410 ▲	250	5	76	2500	150	63
106378 ▲	250	6	76	2500	150	63
106394 ▲	250	8	76	2500	150	63
127873 ▲	315	5	79,6	2000	180	69
106434 ▲	315	6	103	2000	180	69
106450 ▲	315	8	103	2000	180	69
106466 ▲	315	11	103	2000	180	69
106698 ▲	350	6	103	1700	210	74
106666 ▲	350	8	115	1700	210	74
106682 ▲	350	11	115	1700	210	74
106622 ▲	400	6	103	1600	240	92
106490 ▲	400	8	136	1600	240	92
106606 ▲	400	11	136	1600	240	92
104404 ▲	500	8	136	1000	260	100
106638 ▲	500	11	190	1000	260	100
104426 ▲	500	15	190	1000	260	100
106650 ▲	630	11	192,7	800	280	105
103324 ▲	630	15	240	800	280	105

**ZGU-ZSU**

Tool group A09  
Type 633 **3-jaw-chuck**  
**steel body**  
ISO 702-2 (DIN 55029); ASA B 5.9,  
Type D, with studs for Camlock

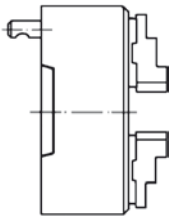

Item no.	Size	Mount short taper	Through-hole	Speed max. min-1	Torque Nm	Total clamping force kN
105846 ▲	100	3	20	6300	60	27
105858 ▲	125	3	32	5500	80	31
105870 ▲	125	4	32	5500	80	31
106310 ▲	160	3	42	4600	110	47
105882 ▲	160	4	42	4600	110	47
105898 ▲	160	5	42	4600	110	47
106362 ▲	200	3	51,2	4000	140	55
106374 ▲	200	4	55	4000	140	55
106330 ■	200	5	55	4000	140	55
106346 ▲	200	6	55	4000	140	55
127874 ▲	250	4	60,7	3000	150	63
106418 ▲	250	5	76	3000	150	63
106386 ▲	250	6	76	3000	150	63
106402 ▲	250	8	76	3000	150	63
127875 ▲	315	5	79,6	2300	180	69
106442 ▲	315	6	103	2300	180	69
106458 ▲	315	8	103	2300	180	69
106474 ▲	315	11	103	2300	180	69
106806 ▲	350	6	103	1900	210	74
106674 ▲	350	8	115	1900	210	74
106690 ▲	350	11	115	1900	210	74
106630 ▲	400	6	103	1800	240	92
106498 ▲	400	8	136	1800	240	92
106614 ▲	400	11	136	1800	240	92
105625 ▲	500	8	136	1300	260	100
103274 ▲	500	11	190	1300	260	100
103275 ▲	500	15	190	1300	260	100
106658 ▲	630	11	192,7	850	280	105
103328 ▲	630	15	240	850	280	105

Tool group A09  
Type 433 **4-jaw-chuck**  
**cast iron body**  
ISO 702-2 (DIN 55029); ASA B 5.9,  
Type D, with studs for Camlock

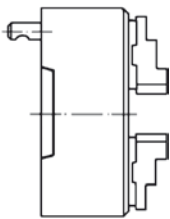

Item no.	Size	Mount short taper	Through-hole	Speed max. min-1	Torque Nm	Total clamping force kN
105844 ▲	100	3	20	4500	60	27
105854 ▲	125	3	32	4000	80	31
105868 ▲	125	4	32	4000	80	31
105878 ▲	160	4	42	3600	110	47
105894 ▲	160	5	42	3600	110	47
106358 ▲	200	3	51,2	3000	140	55
106372 ▲	200	4	55	3000	140	55
106326 ▲	200	5	55	3000	140	55
106342 ▲	200	6	55	3000	140	55
127882 ▲	250	4	60,7	2500	150	63
106414 ▲	250	5	76	2500	150	63
106382 ▲	250	6	76	2500	150	63
106398 ▲	250	8	76	2500	150	63
127883 ▲	315	5	79,6	2000	180	69
106438 ▲	315	6	103	2000	180	69
106454 ▲	315	8	103	2000	180	69
106470 ▲	315	11	103	2000	180	69
106802 ▲	350	6	103	1700	210	74
106670 ▲	350	8	115	1700	210	74
106686 ▲	350	11	115	1700	210	74
106626 ▲	400	6	103	1600	240	92
106494 ▲	400	8	136	1600	240	92
106610 ▲	400	11	136	1600	240	92
105651 ▲	500	8	136	1000	260	100
106642 ▲	500	11	190	1000	260	100
104428 ▲	500	15	190	1000	260	100
106654 ▲	630	11	192,7	800	280	105
104492 ▲	630	15	240	800	280	105

# ZGU-ZSU

Tool group A09  
Type 833 **4-jaw-chuck**  
**steel body**  
**ISO 702-2** (DIN 55029); ASA B 5.9,  
Type D, with studs for Camlock

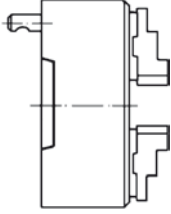

Item no.	Size	Mount short taper	Through-hole	Speed max. min-1	Torque Nm	Total clamping force kN
105848 ▲	100	3	20	6300	60	27
105862 ▲	125	3	32	5500	80	31
105872 ▲	125	4	32	5500	80	31
105886 ▲	160	4	42	4600	110	47
106302 ▲	160	5	42	4600	110	47
106366 ▲	200	3	51,2	4000	140	55
106376 ▲	200	4	55	4000	140	55
106334 ▲	200	5	55	4000	140	55
106350 ▲	200	6	55	4000	140	55
127884 ▲	250	4	60,7	3000	150	63
106422 ▲	250	5	76	3000	150	63
106390 ▲	250	6	76	3000	150	63
106406 ▲	250	8	76	3000	150	63
127885 ▲	315	5	79,6	2300	180	69
106446 ▲	315	6	103	2300	180	69
106462 ▲	315	8	103	2300	180	69
106478 ▲	315	11	103	2300	180	69
106810 ▲	350	6	103	1900	210	74
106678 ▲	350	8	115	1900	210	74
106694 ▲	350	11	115	1900	210	74
106634 ▲	400	6	103	1800	240	92
106602 ▲	400	8	136	1800	240	92
106618 ▲	400	11	136	1800	240	92
105684 ▲	500	8	136	1300	260	100
106646 ▲	500	11	190	1300	260	100
103271 ▲	500	15	190	1300	260	100
106662 ▲	630	11	192,7	850	280	105
106251 ▲	630	15	240	850	280	105



# ZGU-ZSU heavy design



The spiral ring chuck - a proven and universal suitable clamping system - finds its application wherever a high clamping force, high runout accuracy and very high repeatability are required (e. g. lathes, turntables, circular indexing tables, etc.).  
Cross tenon to ISO 3442 and ASA B 5.8.

The jaws can be moved across the entire clamping range by turning a key. Due to this, workpieces with different diameters can be clamped without changing or shifting the jaws.

**Heavy design with large through-hole**

**Technical features:**

- with base jaws and reversible top jaws
- with scroll
- self-centering
- lathe chucks must be lubricated regularly to maintain their gripping force

**Delivery includes:**

- 1 set of base jaws (GB),
- 1 set of reversible top jaws (UB),
- 1 operating key, mounting bolts

Tool group A09  
Type 303 **3-jaw-chuck**  
cast iron body  
cylindrical centre mount

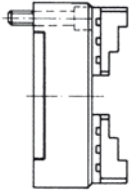

Item no.	Size	ZA	Through-hole	Speed max. min-1	Torque Nm	Total clamping force kN
147500 ▲	700	610	310	650	280	105
104626 ▲	800	710	380	600	300	110
104648 ▲	1000	910	460	480	450	115
104650 ▲	1250	910	550	380	450	115

Tool group A09  
Type 603 **3-jaw-chuck**  
steel body  
cylindrical centre mount

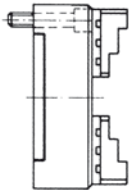

Item no.	Size	ZA	Through-hole	Speed max. min-1	Torque Nm	Total clamping force kN
147501 ▲	700	610	310	800	280	105
104913 ▲	800	710	380	700	300	110
104925 ▲	1000	910	460	560	450	115
104941 ▲	1250	910	550	450	450	115

Tool group A09  
Type 403 **4-jaw-chuck**  
cast iron body  
cylindrical centre mount

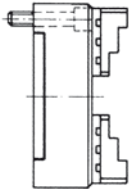

Item no.	Size	ZA	Through-hole	Speed max. min-1	Torque Nm	Total clamping force kN
147514 ▲	700	610	310	650	280	105
104909 ▲	800	710	380	600	300	110
104921 ▲	1000	910	460	480	450	115
104933 ▲	1250	910	550	380	450	115

Tool group A09  
Type 803 **4-jaw-chuck**  
steel body  
cylindrical centre mount

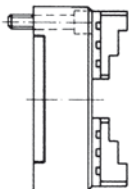

Item no.	Size	ZA	Through-hole	Speed max. min-1	Torque Nm	Total clamping force kN
147515 ▲	700	610	310	800	280	105
104917 ▲	800	710	380	700	300	110
104929 ▲	1000	910	460	560	450	115
104945 ▲	1250	910	550	450	450	115

## ZGU-ZSU heavy

Tool group A09  
Type 318 **3-jaw-chuck**  
**cast iron body**  
**ISO 702-3** (DIN 55027), DIN 55022;  
with studs and locknuts, optional  
DIN 55021 with set screw and nut

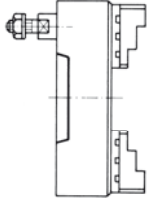

Item no.	Size	Mount short taper	Through-hole	Speed max. min-1	Torque Nm	Total clamping force kN
147502 ▲	700	11	192,7	650	280	105
147504 ▲	700	15	281,2	650	280	105
126908 ▲	800	11	192,7	600	300	110
129291 ▲	800	15	281,2	600	300	110
129292 ▲	800	20	380	600	300	110
129293 ▲	1000	15	281,2	480	450	115
129294 ▲	1000	20	407,5	480	450	115
129295 ▲	1250	15	281,2	380	450	115
129296 ▲	1250	20	407,5	380	450	115

Tool group A09  
Type 618 **3-jaw-chuck**  
**steel body**  
**ISO 702-3** (DIN 55027), DIN 55022;  
with studs and locknuts, optional  
DIN 55021 with set screw and nut

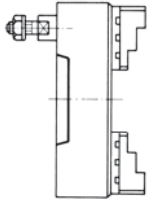

Item no.	Size	Mount short taper	Through-hole	Speed max. min-1	Torque Nm	Total clamping force kN
147503 ▲	700	11	192,7	800	280	105
147505 ▲	700	15	281,2	800	280	105
148253 ▲	800	11	192,7	700	300	110
129339 ▲	800	15	281,2	700	300	110
129340 ▲	800	20	380	700	300	110
129341 ▲	1000	15	281,2	450	450	115
129342 ▲	1000	20	407,5	560	450	115
129343 ▲	1250	15	281,2	450	450	115
129344 ▲	1250	20	407,5	450	450	115

Tool group A09  
Type 418 **4-jaw-chuck**  
**cast iron body**  
**ISO 702-3** (DIN 55027), DIN 55022;  
with studs and locknuts, optional  
DIN 55021 with set screw and nut

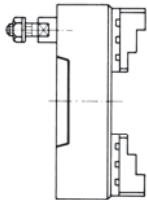

Item no.	Size	Mount short taper	Through-hole	Speed max. min-1	Torque Nm	Total clamping force kN
147516 ▲	700	11	192,7	650	280	105
147518 ▲	700	15	281,2	650	280	105
127266 ▲	800	11	192,7	600	300	110
129323 ▲	800	15	281,2	600	300	110
129324 ▲	800	20	380	600	300	110
129325 ▲	1000	15	281,2	480	450	115
129326 ▲	1000	20	407,5	480	450	115
129327 ▲	1250	15	281,2	380	450	115
129328 ▲	1250	20	407,5	380	450	115

Tool group A09  
Type 818 **4-jaw-chuck**  
**steel body**  
**ISO 702-3** (DIN 55027), DIN 55022;  
with studs and locknuts, optional  
DIN 55021 with set screw and nut

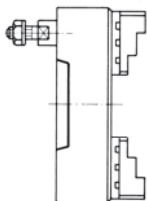

Item no.	Size	Mount short taper	Through-hole	Speed max. min-1	Torque Nm	Total clamping force kN
147517 ▲	700	11	192,7	800	280	105
147519 ▲	700	15	281,2	800	280	105
149067 ▲	800	11	192,7	700	300	110
129355 ▲	800	15	281,2	700	300	110
129356 ▲	800	20	380	700	300	110
129357 ▲	1000	15	281,2	560	450	115
129358 ▲	1000	20	407,5	560	450	115
129359 ▲	1250	15	281,2	450	450	115
129360 ▲	1250	20	407,5	450	450	115

# ZGU-ZSU heavy

Tool group A09  
Type 323 **3-jaw-chuck**  
**cast iron body**  
**ISO 702-1** (DIN 55026); DIN 55021,  
ASA B 5.9, A1/A2 metr.; mounting  
from front

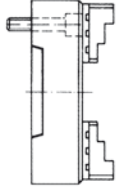

Item no.	Size	Mount short taper	Through-hole	Speed max. min-1	Torque Nm	Total clamping force kN
147506 ▲	700	11	193	650	280	105
147508 ▲	700	15	281,2	650	280	105
126909 ▲	800	11	193	600	300	110
129299 ▲	800	15	281,2	600	300	110
129300 ▲	800	20	380	600	300	110
129301 ▲	1000	15	281,2	480	450	115
129302 ▲	1000	20	407,5	480	450	115
129303 ▲	1250	15	281,2	380	450	115
129304 ▲	1250	20	407,5	380	450	115

Tool group A09  
Type 623 **3-jaw-chuck**  
**steel body**  
**ISO 702-1** (DIN 55026); DIN 55021,  
ASA B 5.9, A1/A2 metr.; mounting  
from front

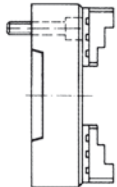

Item no.	Size	Mount short taper	Through-hole	Speed max. min-1	Torque Nm	Total clamping force kN
147507 ▲	700	11	193	650	280	105
147509 ▲	700	15	281,2	650	280	105
139200 ▲	800	11	193	600	300	110
129347 ▲	800	15	281,2	600	300	110
129348 ▲	800	20	380	600	300	110
129349 ▲	1000	15	281,2	480	450	115
129350 ▲	1000	20	407,5	480	450	115
129351 ▲	1250	15	281,2	380	450	115
129352 ▲	1250	20	407,5	380	450	115

Tool group A09  
Type 423 **4-jaw-chuck**  
**cast iron body**  
**ISO 702-1** (DIN 55026); DIN 55021,  
ASA B 5.9, A1/A2 metr.; mounting  
from front

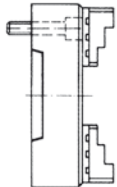

Item no.	Size	Mount short taper	Through-hole	Speed max. min-1	Torque Nm	Total clamping force kN
147520 ▲	700	11	193	650	280	105
147522 ▲	700	15	281,2	650	280	105
127269 ▲	800	11	193	600	300	110
129331 ▲	800	15	281,2	600	300	110
129332 ▲	800	20	380	600	300	110
129333 ▲	1000	15	281,2	480	450	115
129334 ▲	1000	20	407,5	480	450	115
129335 ▲	1250	15	281,2	380	450	115
129336 ▲	1250	20	407,5	380	450	115

Tool group A09  
Type 823 **4-jaw-chuck**  
**steel body**  
**ISO 702-1** (DIN 55026); DIN 55021,  
ASA B 5.9, A1/A2 metr.; mounting  
from front

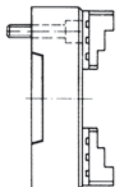

Item no.	Size	Mount short taper	Through-hole	Speed max. min-1	Torque Nm	Total clamping force kN
147521 ▲	700	11	193	650	280	105
147523 ▲	700	15	281,2	650	280	105
139234 ▲	800	11	193	600	300	110
129363 ▲	800	15	281,2	600	300	110
129364 ▲	800	20	380	600	300	110
129365 ▲	1000	15	281,2	480	450	115
129366 ▲	1000	20	407,5	480	450	115
129367 ▲	1250	15	281,2	380	450	115
129368 ▲	1250	20	407,5	380	450	115

# ZGU-ZSU heavy

Tool group A09  
Type 333 **3-jaw-chuck**  
**cast iron body**  
ISO 702-2 (DIN 55029); ASA B 5.9,  
Type D, with studs for Camlock

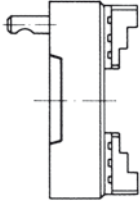

Item no.	Size	Mount short taper	Through-hole	Speed max. min-1	Torque Nm	Total clamping force kN
147510 ▲	700	11	192,7	650	280	105
147512 ▲	700	15	281,2	650	280	105
126911 ▲	800	11	192,7	600	300	110
129307 ▲	800	15	281,2	600	300	110
129308 ▲	800	20	380	600	300	110
129309 ▲	1000	15	281,2	480	450	115
129310 ▲	1000	20	407,5	480	450	115
129311 ▲	1250	15	281,2	380	450	115
129312 ▲	1250	20	407,5	380	450	115

Tool group A09  
Type 633 **3-jaw-chuck**  
**steel body**  
ISO 702-2 (DIN 55029); ASA B 5.9,  
Type D, with studs for Camlock

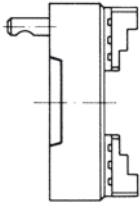

Item no.	Size	Mount short taper	Through-hole	Speed max. min-1	Torque Nm	Total clamping force kN
147511 ▲	700	11	192,7	800	280	105
147513 ▲	700	15	281,2	800	280	105
146526 ▲	800	11	192,7	700	300	110
129371 ▲	800	15	281,2	700	300	110
129372 ▲	800	20	380	700	300	110
129373 ▲	1000	15	281,2	560	450	115
129374 ▲	1000	20	407,5	560	450	115
129375 ▲	1250	15	281,2	450	450	115
129376 ▲	1250	20	407,5	450	450	115

Tool group A09  
Type 433 **4-jaw-chuck**  
**cast iron body**  
ISO 702-2 (DIN 55029); ASA B 5.9,  
Type D, with studs for Camlock

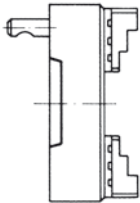

Item no.	Size	Mount short taper	Through-hole	Speed max. min-1	Torque Nm	Total clamping force kN
147524 ▲	700	11	192,7	650	280	105
147526 ▲	700	15	281,2	650	280	105
127273 ▲	800	11	192,7	600	300	110
129315 ▲	800	15	281,2	600	300	110
129316 ▲	800	20	380	600	300	110
129317 ▲	1000	15	281,2	480	450	115
129318 ▲	1000	20	407,5	480	450	115
129319 ▲	1250	15	281,2	380	450	115
129320 ▲	1250	20	407,5	380	450	115

Tool group A09  
Type 833 **4-jaw-chuck**  
**steel body**  
ISO 702-2 (DIN 55029); ASA B 5.9,  
Type D, with studs for Camlock

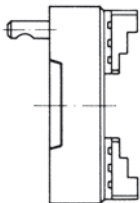

Item no.	Size	Mount short taper	Through-hole	Speed max. min-1	Torque Nm	Total clamping force kN
147525 ▲	700	11	192,7	800	280	105
147527 ▲	700	15	281,2	800	280	105
168101 ▲	800	11	281,2	700	300	110
129379 ▲	800	15	281,2	700	300	110
129380 ▲	800	20	380	700	300	110
129381 ▲	1000	15	281,2	560	450	115
129382 ▲	1000	20	407,5	560	450	115
129383 ▲	1250	15	281,2	450	450	115
129384 ▲	1250	20	407,5	450	450	115

# Jaws ZGU-ZSU

Tool group A09  
Type 302 **Base jaw GB**  
**DIN 6350**  
with fixing screw

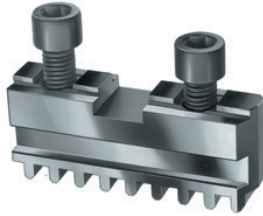

Item no.	Chuck Size	Number of jaws	Jaw length	Jaw width
107500 ●	100/110	3	46	14
107501 ●	125	3	55	18
107502 ●	140	3	65	18
107503 ●	160	3	65	18
107504 ●	200	3	78	20
107505 ●	250	3	92	24
107506 ●	315	3	108	34
107507 ●	350/400	3	127	34
107508 ●	500	3	165	42
107509 ●	630	3	203	42
115098 ■	700	3	253	55
105272 ■	800	3	291	55
105274 ▲	1000	3	329	55
105275 ▲	1250	3	367	55

Tool group A09  
Type 402 **Base jaw GB**  
**DIN 6350**  
with fixing screw

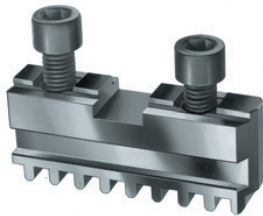

Item no.	Chuck Size	Number of jaws	Jaw length	Jaw width
107542 ●	100/110	4	46	14
107543 ●	125	4	55	18
107544 ■	140	4	65	18
107545 ●	160	4	65	18
107546 ●	200	4	78	20
107547 ●	250	4	92	24
107548 ●	315	4	108	34
107549 ■	350/400	4	127	34
107550 ■	500	4	165	42
107551 ■	630	4	203	42
141621 ■	700	4	253	55
141616 ■	800	4	291	55
141611 ▲	1000	4	329	55
141614 ▲	1250	4	367	55

Tool group A09  
Type 303 **Reversible top jaws UB**  
**DIN 6350**  
hardened

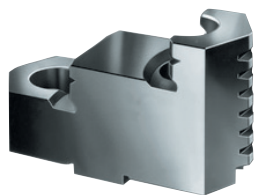

Item no.	Chuck Size	Number of jaws	Jaw length	Jaw height	Jaw width
108045 ■	100/110	3	47	29,5	22
108046 ■	125	3	56	37,5	26
107936 ●	140/160	3	66,7	41,5	28
107937 ●	200	3	79,5	42,5	30
108049 ●	250	3	95,3	52,5	36
108050 ●	315	3	109,5	57,5	42
108051 ●	350/400	3	127	64,5	42
108052 ■	500/630	3	127	79,5	50
105081 ■	700/800	3	210	89	68
105098 ■	1000/1250	3	210	110	68

Stepped and hardened jaws, supplied as supplement or as spares, must be ground on the chuck.  
In case of a subsequent jaw delivery please return the chuck.

Tool group A09  
Type 403 **Reversible top jaws UB**  
**DIN 6350**  
hardened

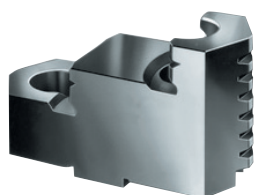

Item no.	Chuck Size	Number of jaws	Jaw length	Jaw height	Jaw width
108053 ■	100/110	4	47	29,5	22
108054 ■	125	4	56	37,5	26
107938 ■	140/160	4	66,7	41,5	28
107939 ■	200	4	79,5	42,5	30
108057 ■	250	4	95,3	52,5	36
108058 ■	315	4	109,5	57,5	42
108059 ■	350/400	4	127	64,5	42
108060 ■	500/630	4	127	79,5	50
105085 ■	700/800	4	210	89	68
105101 ■	1000/1250	4	210	110	68

Stepped and hardened jaws, supplied as supplement or as spares, must be ground on the chuck.  
In case of a subsequent jaw delivery please return the chuck.

# Jaws ZGU-ZSU

Tool group A09  
Type 302 **Unstepped top jaw AB**  
**DIN 6350**  
soft, material 16MnCr5



Item no.	Chuck Size	Number of jaws	Jaw length	Jaw height	Jaw width
107633 ●	100/110	3	53	30	22,5
107634 ●	125	3	62	38	26,5
108581 ●	140/160	3	74	42	28,5
108582 ●	200	3	87	43	30,5
107637 ●	250	3	103	53	36,5
107638 ●	315	3	120	58	42,5
107639 ●	350/400	3	137	65	42,5
107640 ●	500/630	3	140	80	50,5
105103 ■	700/800	3	210	89	68
105107 ●	1000/1250	3	210	110	68

Tool group A09  
Type 402 **Unstepped top jaw AB**  
**DIN 6350**  
soft, material 16MnCr5



Item no.	Chuck Size	Number of jaws	Jaw length	Jaw height	Jaw width
107641 ■	100/110	4	53	30	22,5
107642 ●	125	4	62	38	26,5
108583 ●	140/160	4	74	42	28,5
108584 ●	200	4	87	43	30,5
107579 ●	250	4	103	53	36,5
107580 ●	315	4	120	58	42,5
107581 ●	350/400	4	137	65	42,5
107582 ●	500/630	4	140	80	50,5
105105 ■	700/800	4	210	89	68
105109 ■	1000/1250	4	210	110	68

Tool group A09  
Type 302 **Top jaw AB,**  
**special length,** soft, 16MnCr5  
**DIN 6350**

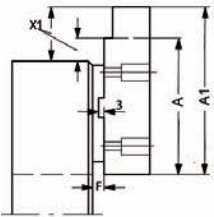
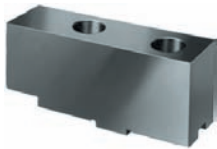

Item no.	Chuck Size	Number of jaws	A1	X1 max.	F	A	X Max.
110086 ■	200	3	100	43	6,8	87	30
112122 ■	250	3	130	63	8	103	36
110624 ■	315	3	160	76	5,5	120	36
110626 ■	350/400	3	160	53	8,5	137	30
103014 ■	500/630	3	170	75	8,5	140	45
112120 ■	200	3	120	63	6,8	87	30
125428 ■	250	3	150	83	8	103	36
112091 ■	315	3	200	116	5,5	120	36
112118 ■	350/400	3	200	93	8,5	137	30
110632 ■	500/630	3	220	125	8,5	140	45
104710 ■	250	3	180	113	8	103	36
112089 ■	315	3	250	166	5,5	120	36
103654 ■	350/400	3	260	153	8,5	137	30
112127 ■	500/630	3	280	185	8,5	140	45

Tool group A09  
Type 402 **Top jaw AB,**  
**special length,** soft, 16MnCr5  
**DIN 6350**

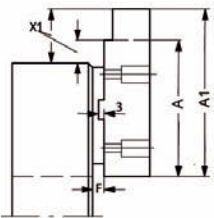
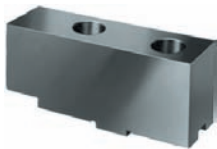

Item no.	Chuck Size	Number of jaws	A1	X1 max.	F	A	X Max.
148139 ■	200	4	100	43	6,8	87	30
129289 ■	250	4	130	63	8	103	36
143764 ■	315	4	160	76	5,5	120	36
141277 ■	350/400	4	160	53	8,5	137	30
103393 ■	500/630	4	170	75	8,5	140	45
148657 ■	200	4	120	63	6,8	87	30
128700 ■	250	4	150	83	8	103	36
147754 ■	315	4	200	116	5,5	120	36
141263 ■	350/400	4	200	93	8,5	137	30
148234 ■	500/630	4	220	125	8,5	140	45
146013 ■	250	4	180	113	8	103	36
147860 ■	315	4	250	166	5,5	120	36
149974 ■	350/400	4	260	153	8,5	137	30
148235 ■	500/630	4	280	185	8,5	140	45

# Jaws ZGU-ZSU

Tool group A09  
Type 302 **Top jaw AB**,  
**special height**, soft, 16MnCr5  
DIN 6350

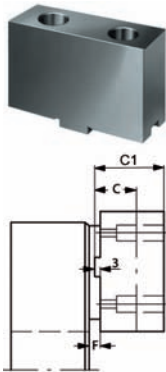

Item no.	Chuck Size	Number of jaws	C1	C	F
132155	200	3	60	43	6,8
119645	250	3	70	53	8
110435	315	3	80	58	5,5
126385	350/400	3	90	65	8,5
128590	500/630	3	100	80	8,5
128564	200	3	80	43	6,8
128571	250	3	100	53	8
110437	315	3	110	58	5,5
110628	350/400	3	120	65	8,5
110630	500/630	3	130	80	8,5
128573	250	3	150	53	8
128569	315	3	150	58	5,5
128567	350/400	3	160	65	8,5
128588	500/630	3	160	80	8,5

Tool group A09  
Type 402 **Top jaw AB**,  
**special height**, soft, 16MnCr5  
DIN 6350

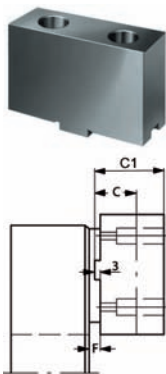

Item no.	Chuck Size	Number of jaws	C1	C	F
132181	200	4	60	43	6,8
135867	250	4	70	53	8
149975	315	4	80	58	5,5
118373	350/400	4	90	65	8,5
149985	500/630	4	100	80	8,5
149976	200	4	80	43	6,8
134999	250	4	100	53	8
129691	315	4	110	58	5,5
135426	350/400	4	120	65	8,5
149977	500/630	4	130	80	8,5
149978	250	4	150	53	8
141671	315	4	150	58	5,5
139591	350/400	4	160	65	8,5
140427	500/630	4	160	80	8,5

Tool group A09  
Type 302 **Top jaw AB**,  
**special width and height**, soft,  
16MnCr5  
DIN 6350

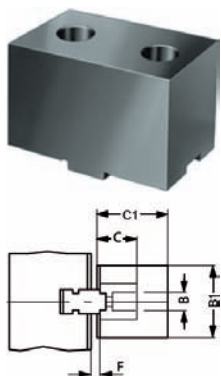

Item no.	Chuck Size	Number of jaws	B1	C1	B	C
105057	200	3	40	70	30.5	43
137090	250	3	50	80	36.5	53
143053	315	3	60	90	42	58
131567	350/400	3	60	90	42.5	65
137084	500/630	3	80	110	50.5	80
133259	200	3	50	80	30.5	43
133653	250	3	60	90	36.5	53
143057	315	3	80	110	42	58
137086	350/400	3	80	110	42.5	65

# Jaws ZGU-ZSU

Tool group A09  
Type 402 **Top jaw AB**,  
**special width and height**, soft,  
16MnCr5  
DIN 6350

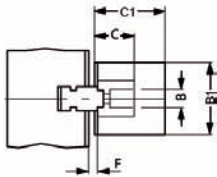

Item no.	Chuck Size	Number of jaws	B1	C1	B	C
105061 <span style="color: yellow;">■</span>	200	4	40	70	30,5	43
141338 <span style="color: yellow;">■</span>	250	4	50	80	36,5	53
149979 <span style="color: yellow;">■</span>	315	4	60	90	42	58
149980 <span style="color: yellow;">■</span>	350/400	4	60	90	42,5	65
149981 <span style="color: yellow;">■</span>	500/630	4	80	110	50,5	80
149982 <span style="color: yellow;">■</span>	200	4	50	80	30,5	43
137526 <span style="color: yellow;">■</span>	250	4	60	90	36,5	53
149983 <span style="color: yellow;">■</span>	315	4	80	110	42	58
149984 <span style="color: yellow;">■</span>	350/400	4	80	110	42,5	65

Tool group C15  
Type 0040-Y  
**Mounting bolt for top jaws  
bolt 1**

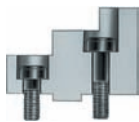

Item no.	Size	Thread
249299 <span style="color: green;">●</span>	100/110	M6x20
236949 <span style="color: green;">●</span>	125	M8x25
334571 <span style="color: green;">●</span>	140/160/200	M8x30
233025 <span style="color: green;">●</span>	250	M10x35
233026 <span style="color: green;">●</span>	315	M12x45
220565 <span style="color: green;">●</span>	350/400	M16x50
249003 <span style="color: green;">●</span>	500/630	M20x80

Tool group C15  
Type 0040-Y  
**Mounting bolt for top jaws  
bolt 2**



Item no.	Size	Thread
216528 <span style="color: green;">●</span>	100/110	M6x16
233058 <span style="color: green;">●</span>	125/140/160/200	M8x20
227692 <span style="color: green;">●</span>	250	M12x25
233030 <span style="color: green;">●</span>	315	M12x30
220564 <span style="color: green;">●</span>	350/400	M16x35
233047 <span style="color: green;">●</span>	500/630	M20x40



# Accessories ZGU-ZSU

Tool group A09

Type 600 **Base plates** for lathe chucks with **cylindrical centre mount** DIN 6350



Item no.	Size
162793 <span style="color: yellow;">■</span>	160
162401 <span style="color: yellow;">■</span>	200
163036 <span style="color: yellow;">■</span>	250
133705 <span style="color: yellow;">■</span>	315

Tool group A09

Type 304 **Unfinished adapter plates** for **cylindrical mount**

The unfinished back plate must be machined and fitted on both machine and chuck side

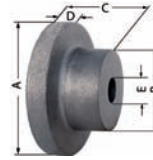

Item no.	Chuck Size	Inch	A	B	C	D	E
017123 <span style="color: yellow;">■</span>	74	3	80	56	45	15	-
017113 <span style="color: green;">●</span>	80	3 ¼	92	56	47	15	20
017114 <span style="color: green;">●</span>	100	4	120	80	58	20	25
017115 <span style="color: green;">●</span>	125	5	135	80	58	20	25
017125 <span style="color: yellow;">■</span>	140	5 ½	150	80	58	20	25
017116 <span style="color: green;">●</span>	160	6 ¼	170	80	58	20	30
017117 <span style="color: green;">●</span>	200	8	210	92	66	22	40
017118 <span style="color: yellow;">■</span>	250	10	260	105	92	25	50
017119 <span style="color: yellow;">■</span>	315	12 ½	330	165	100	30	50
017124 <span style="color: yellow;">■</span>	350	14	365	180	120	30	60

Tool group A09

Type 300 **Chip guard, piece**



Item no.	Contents of delivery	Size
108500 <span style="color: yellow;">■</span>	piece	80/85
108501 <span style="color: green;">●</span>	piece	100/110
108502 <span style="color: green;">●</span>	piece	125
108503 <span style="color: green;">●</span>	piece	140/160
108504 <span style="color: green;">●</span>	piece	200
108505 <span style="color: green;">●</span>	piece	250
108506 <span style="color: green;">●</span>	piece	315/350/400
108508 <span style="color: green;">●</span>	piece	500/630

Tool group C15

Type 1028 **Special grease F80** for **lathe chucks** for lubrication and conservation of chucking power



Item no.	Design	Contents
028975 <span style="color: green;">●</span>	Tin	1 kg

Tool group A09

Type 300 **Scroll**



Item no.	Size
102521 <span style="color: green;">●</span>	74
102183 <span style="color: green;">●</span>	80/85
101754 <span style="color: green;">●</span>	100
112660 <span style="color: green;">●</span>	110
101721 <span style="color: green;">●</span>	125
105827 <span style="color: green;">●</span>	140
100303 <span style="color: green;">●</span>	160
100003 <span style="color: green;">●</span>	200
100203 <span style="color: green;">●</span>	250
101552 <span style="color: green;">●</span>	315
105228 <span style="color: yellow;">■</span>	350
102497 <span style="color: green;">●</span>	400
162973 <span style="color: yellow;">■</span>	500
162964 <span style="color: yellow;">■</span>	630

Tool group A09

Type 300 **Driving pinion**



Item no.	Size
102522 <span style="color: yellow;">■</span>	74
102184 <span style="color: green;">●</span>	80
113198 <span style="color: yellow;">■</span>	85
101755 <span style="color: green;">●</span>	100
112662 <span style="color: green;">●</span>	110
101722 <span style="color: green;">●</span>	125
105828 <span style="color: green;">●</span>	140
100304 <span style="color: green;">●</span>	160
100005 <span style="color: green;">●</span>	200
100204 <span style="color: green;">●</span>	250
101553 <span style="color: green;">●</span>	315
105229 <span style="color: green;">●</span>	350
102498 <span style="color: green;">●</span>	400
162974 <span style="color: yellow;">■</span>	500
162965 <span style="color: yellow;">■</span>	630

Tool group A09

Type 300 **Pinion holder screw**



Item no.	Size
102523 <span style="color: yellow;">■</span>	74
102185 <span style="color: green;">●</span>	85
100305 <span style="color: green;">●</span>	160
100006 <span style="color: green;">●</span>	270
101554 <span style="color: green;">●</span>	315
102499 <span style="color: green;">●</span>	400
103300 <span style="color: green;">●</span>	630

Tool group A09

Type 300 **Standard key**



Item no.	Size	Square	Hexagon	Length
006325 <span style="color: green;">●</span>	74	-	6	55
107426 <span style="color: green;">●</span>	80/85	6	-	62
107427 <span style="color: green;">●</span>	100/110	8	-	75
107428 <span style="color: green;">●</span>	125/140	9	-	80
107429 <span style="color: green;">●</span>	160	10	-	90
107430 <span style="color: green;">●</span>	200/230	11	-	100
107431 <span style="color: green;">●</span>	250/270	12	-	100
107432 <span style="color: green;">●</span>	315	14	-	110
107433 <span style="color: green;">●</span>	350	14	-	140
107434 <span style="color: green;">●</span>	400	17	-	140
107435 <span style="color: green;">●</span>	500/630	19	-	150

# Accessories ZGU-ZSU

**Tool group A09**
**Type 300 Safety key**

Item no.	Size	Square	Length
154370	80/85	6	110
154371	100/110	8	130
154372	125/140	9	130
154373	160	10	160
154374	200/230	11	160
154375	250/270	12	160
154376	315	14	200
154377	350	14	200
154378	400	17	250
154379	500/630	19	250

**Tool group A09**
**Type 300 Elongated safety key**

Item no.	Size	Square	Length
154683	125/140	9	170
154685	160	10	180
154687	200/230	11	200
154689	250/270	12	200
154695	315	14	250

**Tool group C15**
**Type 0040-Y Mounting screws with cylindrical centre rim**

Item no.	Size	Thread
249299	74-85	M6x20
334571	100-140	M8x30
249301	160-230	M10x35
233025	250-270	M10x35
220565	315-350	M16x50
229183	400-630	M16x60

**Tool group C15**
**Type 0040-Y Mounting screws for lathe chucks with direct short-taper, for front mounting**

Item no.	Size	Thread	Chuck Size	Taper size
302195	74	M10x55	160	5
200184	80	M10x65	200	5
233006	85	M12x65	200	6
233075	100	M10x90	250	5
216549	110	M12x70	250	6
302194	125	M16x70	250	8
242954	140	M12x100	315	6
358816	160	M16x85	315	8
243665	200/230	M12x130	350	6
236516	315	M16x110	400	8
615744	350	M20x95	400	11
010210	400	M20x130	500	11
328925	500	M20x145	630	11
367648	630	M24x125	630	15

**Tool group A09**
**Type 310 Set screw with nut DIN 55021**

Item no.	Thread	For taper	Quantity
107453	M10x30	4	3
107455	M10x35	5	4
107456	M12x40	6	4
107457	M16x45	8	4
107458	M20x55	11	6
127618	M24x65	15	6

**Tool group A09**
**Type 315 Stud and locknut ISO 702-3 (DIN 55027)**

Item no.	Thread	For taper	Quantity
107447	M10x34	3	3
107448	M10x39	4	3
107449	M10x43	5	4
107450	M12x50	6	4
107451	M16x60	8	4
107452	M20x75	11	6
125650	M24x90	15	6
130636	M24x100	20	6

**Tool group A09**
**Type 330 Stud for Camlock ISO 702-2 (DIN 55029) and cylindrical studs**

Item no.	Thread	For taper	Quantity
107465	7/16-20x35	3	3
107466	7/16-20x37	4	3
107467	1/2-20x43	5	6
107468	5/8-18x49	6	6
107469	3/4-16x55,5	8	6
107470	7/8-14x67	11	6
127621	1-14x76	15	6
130637	1 1/2-12x89	20	6



Suitable for use on ground and basic plates.

**Technical features:**

- with scroll
- unstepped soft top jaw
- cast iron body
- DIN 6350
- lathe chucks must be lubricated regularly to maintain their gripping force

**Delivery includes:**

- 1 set of base jaws
- 1 set of top jaws soft
- 1 operating key
- mounting bolts

Tool group A09  
Type 152, **2-jaw cast iron body**,  
unstepped top jaws  
**DIN 6350**; cylindrical centre mount,  
form A

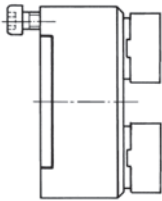

Item no.	Size	Through-hole	Torque Nm	Total clamping force kN
105934 ■	100	20	60	27
105935 ■	125	32	80	31
105937 ■	160	42	110	47
105938 ■	200	55	140	55
105939 ■	250	76	150	63
105940 ▲	315	103	180	69
108459 ▲	350	115	210	74
105941 ▲	400	136	240	92

chucks with short-taper mount on request

Tool group A09  
Type 152, **2-jaw cast iron body**,  
unstepped top jaws  
**mounting from front**; cylindrical  
centre mount

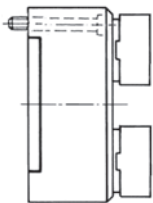

Item no.	Size	Through-hole	Torque Nm	Total clamping force kN
142426 ▲	125	32	80	31
142469 ▲	160	42	110	47
148230 ▲	200	55	140	55
116353 ▲	250	76	150	63
144892 ▲	315	103	180	69
149720 ▲	400	136	240	92

chucks with short-taper mount on request

## Jaws ZGF

Tool group A09  
Type 152 **Base jaw GB DIN 6350**  
with fixing screw

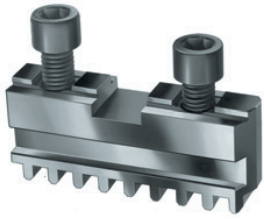

Item no.	Chuck Size	Number of jaws	Jaw length	Jaw width
108950 <span style="color: yellow;">■</span>	100	2	46	14
108951 <span style="color: yellow;">■</span>	125	2	55	18
108953 <span style="color: yellow;">■</span>	160	2	65	18
108954 <span style="color: yellow;">■</span>	200	2	78	20
108955 <span style="color: yellow;">■</span>	250	2	92	24
108956 <span style="color: yellow;">■</span>	315	2	108	34
108957 <span style="color: yellow;">■</span>	350/400	2	127	34

Tool group A09  
Type 152 **Unstepped top jaw AB**  
**DIN 6350**  
soft, material 16MnCr5



Item no.	Chuck Size	Number of jaws	Jaw length	Jaw height	Jaw width
109497 <span style="color: yellow;">■</span>	100	2	53	30	22,5
109498 <span style="color: yellow;">■</span>	125	2	62	38	26,5
109499 <span style="color: yellow;">■</span>	160	2	74	42	28,5
109501 <span style="color: yellow;">■</span>	200	2	87	43	30,5
109502 <span style="color: yellow;">■</span>	250	2	103	53	36,5
109503 <span style="color: yellow;">■</span>	315	2	120	58	42,5
109504 <span style="color: yellow;">■</span>	350/400	2	137	65	42,5

Tool group C15  
Type 0040-Y  
**Mounting bolt for top jaws**  
**bolt 2**



Item no.	Size	Thread
216528 <span style="color: green;">●</span>	100	M6x16
233058 <span style="color: green;">●</span>	125/160/200	M8x20
227692 <span style="color: green;">●</span>	250	M12x25
233030 <span style="color: green;">●</span>	315	M12x30
220564 <span style="color: green;">●</span>	350/400	M16x35

**Accessories ZGF**

Tool group A09

Type 600 **Base plates** for lathe chucks with **cylindrical centre mount** DIN 6350



Item no.	Size
162793	160
162401	200
163036	250
133705	315

Tool group A09

Type 304 **Unfinished adapter plates** for **cylindrical mount**  
The unfinished back plate must be machined and fitted on both machine and chuck side

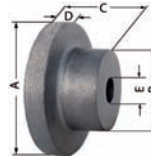

Item no.	Chuck Size	Inch	A	B	C	D	E
017114	100	4	120	80	58	20	25
017115	125	5	135	80	58	20	25
017116	160	6 ¼	170	80	58	20	30
017117	200	8	210	92	66	22	40
017118	250	10	260	105	92	25	50
017119	315	12 ½	330	165	100	30	50
017124	350	14	365	180	120	30	60

Tool group A09

Type 300 **Chip guard, piece**



Item no.	Contents of delivery	Size
108501	piece	100/110
108502	piece	125
108503	piece	140/160
108504	piece	200
108505	piece	250
108506	piece	315/350/400

Tool group C15

Type 1028 **Special grease F80** for **lathe chucks** for lubrication and conservation of chucking power



Item no.	Design	Contents
028975	Tin	1 kg

Tool group A09

Type 300 **Scroll**



Item no.	Size
101754	100
101721	125
100303	160
100003	200
100203	250
101552	315
105228	350
102497	400

Tool group A09

Type 300 **Driving pinion**



Item no.	Size
101755	100
101722	125
100304	160
100005	200
100204	250
101553	315
105229	350
102498	400

Tool group A09

Type 300 **Pinion holder screw**



Item no.	Size
100305	160
100006	270
101554	315
102499	400

Tool group A09

Type 300 **Standard key**



Item no.	Size	Square	Length
107427	100/110	8	75
107428	125/140	9	80
107429	160	10	90
107430	200/230	11	100
107431	250/270	12	100
107432	315	14	110
107433	350	14	140
107434	400	17	140

Tool group A09

Type 300 **Elongated safety key**



Item no.	Size	Square	Length
154683	125/140	9	170
154685	160	10	180
154687	200/230	11	200
154689	250/270	12	200
154695	315	14	250

Tool group A09

Type 300 **Safety key**



Item no.	Size	Square	Length
154371	100/110	8	130
154372	125/140	9	130
154373	160	10	160
154374	200/230	11	160
154375	250/270	12	160
154376	315	14	200
154377	350	14	200
154378	400	17	250

Tool group C15

Type 0040-Y **Mounting screws** with **cylindrical centre rim**



Item no.	Size	Thread
334571	100-140	M8x30
249301	160-230	M10x35
233025	250-270	M10x35
220565	315-350	M16x50
229183	400-630	M16x60

# Chuck dimensions ZG-ZS, ZGU-ZSU and ZGF

For mounting on dividing heads and other attachments from the front, the lathe chucks with a cylindrical centre mount can also be supplied pre-drilled (at surcharge) G<sub>1</sub>, it is also possible to enlarge the bore (measure E, at surcharge)

**Cylindrical centre mount DIN 6350**

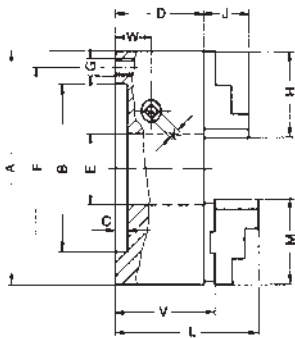

Enlarged bore max.

Size A	74	80	85	100	110	125	140	160	200	250	315	350	400	500	630
B <sup>H6</sup>	56	56	60	70	80	95	105	125	160	200	260	290	330	420	545
C	2,5	3	3	3	3	4	4	4	4	5	5	6	5	5	7
D	32,5	39,5	39,5	50	50	56	60	65	73,5	82	95	100	105	120	135
E	15	19	19	20	27	32	40	42	55	76	103	115	136	190	240
E <sub>max</sub>	-	-	-	21	-	33	43	50	70	92	114	120	150	210	253
F	63	67	72	83	95	108	120	140	176	224	286	318	362	458	586
G	3xM6	3xM6	3xM6	3xM8	3xM8	3xM8	3xM8	3xM10	3xM10	3xM12	3xM16	3xM16	3xM16	6xM16	6xM16
G <sub>1</sub>	-	-	-	-	-	3xØ9*	-	3xØ10,5	3xØ11	3xØ14	3xØ14	-	3xØ18	6xØ18	6xØ18
H	32	37	37	48	48	52	61	61	69	90	130	130	130	190	190
J	14	14	14	18	18	22,5	22,5	26	32,5	40	46	45	43	54,5	54,5
K	6 <sup>1)</sup>	6	6	8	8	9	9	10	11	12	14	14	17	19	19
L	-	-	-	80,5	-	95,5	106	108	119,6	139,6	155	168,5	171,5	201,5	216,5
M	-	-	-	47	47	56	66,7	66,7	79,5	95	109,5	127	127	127	127
V	-	-	-	53,6	53,6	61	67,7	69,7	80,2	89,9	100,4	110,4	113,4	128,4	143,3
W	13	14,5	14,5	18	18	20	21	22,45	25,7	26,5	30	34	35	38	48
approx. kg	1	1,3	1,9	2,9	3,4	4,5	5,8	8,2	14,6	25,7	44,2	56	80	126	208

G<sub>1</sub> = Mounting from front \*4-jaw

**Cylindrical centre mount**

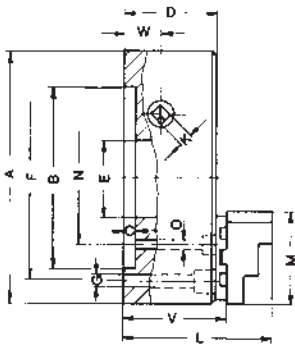

Enlarged bore max.

Size	ØA	700	800	1000	1250
B		610	710	910	910
C <sup>2)</sup>		7+0,03	7+0,03	7+0,03	7+0,03
D		147	147	157	157
E		310	380	460	550
E <sub>max</sub>		330	420	580	580
F		660	760	950	950
3-Jaw	G	6xØ22	6xØ22	6xØ26	6xØ26
4-Jaw	G	8xØ22	8xØ22	8xØ26	6xØ26
K		19	19	24	24
L		240,6	240,6	269,6	269,6
M		210	210	210	210
N		360	460	610	610
3-Jaw	O	6xØ18	6xØ18	6xØ18	6xØ18
4-Jaw	O	4xØ18	4xØ18	4xØ18	6xØ18
V		158	158	166	166
W		48	48	53	53
approx. kg		280	350	590	850

1) Hexagon 2) Adapter plate dimension 7-0,03

Position of fixing screws and pinions on lathe chucks with cylindrical centre mount sizes 74-630 (size 350 on request)

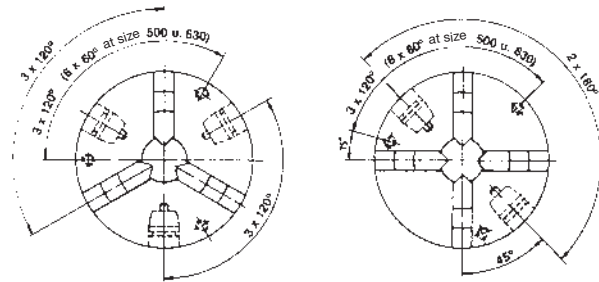

**Short taper mount**

DIN 55021, with setscrews and locknuts



DIN 55027, with setscrews and locknuts

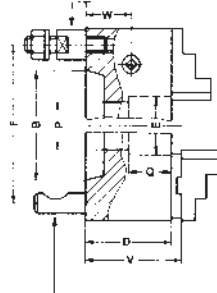

DIN 55029, with studs for Camlock

Size	A	100	125	140	160	200
Taper size		3	3	4	3	4
B		53,9	53,9	63,5	53,9	63,5
D		75	69	69	74	74
E		20	32	32	40	40
DIN	F	75	75	85	75	85
Caml.	F	70,6	70,6	82,5	70,6	82,5
P		-	-	-	-	-
Q		-	-	-	-	-
V		78,3	73,7	73,7	81,7	81,7
W		43	33	33	35	35 <sup>1)</sup>
Mounting holes	DIN	3	3	3	3	4
Caml.		3	3	3	3	6
approx. kg		4	5,5	7	8,5	15,5

1) 50 with Camlock, other dimensions in the table on the top

# Chuck dimensions ZG-ZS, ZGU-ZSU and ZGF

Short taper mount

DIN 55021,  
with setscrews and locknuts

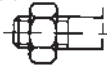

DIN 55027,  
with studs and nuts

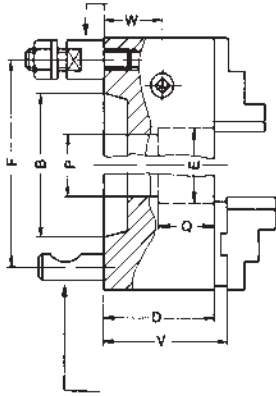

DIN 55029,  
with studs for Camlock

Size A	250				315				350			400		
Taper size	4	5	6	8	5	6	8	11	6	8	11	6	8	11
B	63,5	82,5	106,4	139,7	82,5	106,4	139,7	196,9	106,4	139,7	196,9	106,4	139,7	196,6
D	83	83	83	83	96	96	96	104	122	122	122	106	106	106
E	60,7	76	76	76	79,6	103	103	103	103	115	115	103	136	136
F	85	104,8	133,4	171,4	104,8	133,4	171,4	235	133,4	171,4	235	133,4	171,4	235
P	60,7	-	-	-	79,6	-	-	-	103	-	-	103	-	-
Q	40,5	-	-	-	49	-	-	-	81	-	-	54	-	-
V	90,9	90,9	90,9	90,9	101,4	101,4	101,4	109,4	127,4	127,4	127,4	114,4	114,4	114,4
W	27,5	27,5	27,5	27,5	31	31	31	39	56	56	56	36	36	36
Mounting holes	DIN 3	4	4	4	DIN 4	4	4	6	DIN 4	4	6	DIN 4	4	6
	Caml. 3	6	6	6	Caml. 6	6	6	6	Caml. 6	6	6	Caml. 6	6	6
approx. kg	30				50				71			84		

Size A	500			630		700		800		1000		1250	
Taper size	8	11	15	11	15	11	15	15	20	15	20	15	20
B	139,7	196,9	285,8	196,9	285,8	196,9	285,8	285,8	412,8	285,8	412,8	285,8	412,8
D	122	122	122	137	137	149	149	149	149	159	159	159	159
E	136	190	190	192,7	240	310	310	380	380	460	460	550	550
F	171,4	235	330,2	235	330,2	235	330,2	330,2	463,6	330,2	463,6	330,2	463,6
P	136	-	-	192,7	-	192,7	281,2	281,2	-	281,2	407,5	281,2	407,5
Q	61	-	-	63	-	76	76	76	-	85	85	85	85
V	130,4	130,4	130,4	145,3	145,3	160	160	160	160	168	168	168	168
W	40	40	40	50	50	50	50	50	50	55	55	55	55
Mounting holes	DIN 4	6	6	DIN 6	6	DIN 6	6	DIN 6	6	DIN 6	6	DIN 6	6
	Caml. 6	6	6	Caml. 6	6	Caml. 6	6	Caml. 6	6	Caml. 6	6	Caml. 6	6
approx. kg	150			225		280		350		590		850	

All other dimensions should be taken from the table about chucks with cylindrical centre mount

Short taper mount

DIN 55026  
Mounting from front

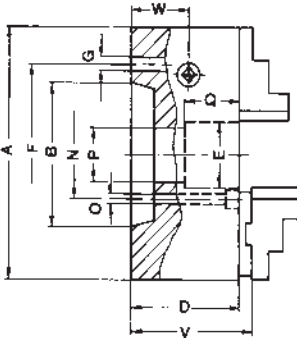

Size A	160		200		250		315		350		400	
Taper size	5	5	6	5	6	8	6	8	6	8	8	11
B	82,5	82,5	106,4	82,5	106,4	139,7	106,4	139,7	106,4	139,7	139,7	196,9
D	66	74,5	74,5	83	83	83	96	96	122	122	106	106
E	42	42	55	76	55	76	103	76	103	76	136	125
F <sup>2)</sup>	-	-	-	104,8	-	-	133,4	-	133,4	-	171,4	-
G	-	-	-	11 <sup>1)</sup>	-	-	14	-	14	-	18	-
N <sup>3)</sup>	61,9	61,9	82,6	-	82,6	111,1	-	111,1	-	111,1	-	165,1
O	11 <sup>1)</sup>	11 <sup>1)</sup>	14	-	14	18	-	18	-	18	-	22
V	70,7	81,2	81,2	90,9	90,9	90,9	101,4	101,4	127,4	127,4	114,4	114,4
W	23,45	26,7	26,7	275	275	275	31	31	56	56	36	36
Mounting holes	*	3	3	6	*	3	6	6	*	6	6	6
	**	4	4	4	**	4	4	4	**	4	4	4
approx. kg	8		14,5		25		44,5		71		82	

Size A	500		630		700		800		1000		1250	
Taper size	11	11	15	11	15	11	15	20	15	20	15	20
B	196,9	196,9	285,9	196,9	285,9	196,9	285,9	412,8	285,9	412,8	285,9	412,8
D	122	137	137	149	149	149	149	149	159	159	159	159
E	190	190	190	310	285	380	380	380	460	505	550	550
F <sup>2)</sup>	235	235	-	235	330,2	235	330,2	463,6	330,2	463,6	330,2	463,62
G	22	22	-	22	26	22	26	26	26	26	26	26
N <sup>3)</sup>	-	-	247,6	-	-	-	-	-	-	-	-	-
O	-	-	26	-	-	-	-	-	-	-	-	-
P	-	-	-	193	281,2	193	281,2	-	281,2	407,5	281,2	407,5
Q	-	-	-	76	76	76	76	-	85	85	85	85
V	130,4	145,3	145,3	159,9	159,9	159,9	159,9	159,9	168	168	168	168
W	40	50	60	50	50	50	50	50	55	55	55	55
Mounting holes	*	3	6	6	*	3	6	6	*	6	8	8
	**	4	8	8	**	4	8	8	**	8	8	8
approx. kg	139		220		295		350		590		850	

1) 12 with ASA B 5.9 inch thread      2) With DIN 55026 Forme A and B; DIN 55021 Forme A and B; ASA B 5.9 A1/A2  
 3) With DIN 55026 Forme B; ASA B 5.9 A1/B1      \* 3-jaw \*\* 4-jaw

# Chuck dimensions ZG-ZS, ZGU-ZSU and ZGF

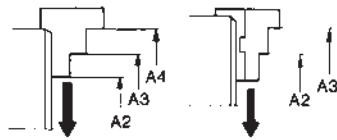
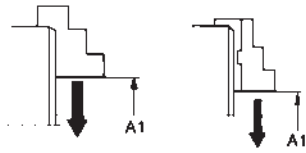
**External chucking**

Ø 74-630

Ø 700-1250

**Chucking capacities of jaw steps (standard values)**

Size	74	80	85	100	110	125	140	160	200	250
A1 (BB)	2-24	2-30	2-30	3-38	3-42	3-53	3-53	3-72	4-100	5-122
A2 (DB)	2-24	2-30	2-30	3-38	3-42	3-53	3-53	3-72	4-100	5-122
A3 (DB)	23-46	27-55	27-55	38-71	39-77	39-89	47-97	47-116	56-152	73-190
A4 (DB)	45-68	52-80	52-80	70-100	70-100	75-125	91-140	91-160	104-200	131-250
max. swing dia.	88	104	104	128	138	157	174	194	238	302
Jaw movement	11	14	14	15	19	25	25	34	48	58

Size	315	350	400	500	630	700	800	1000	1250
A1	6-135	20-180	20-200	35-260	50-350	110-350	150-450	250-600	320-600
A2	6-135	20-180	20-200	35-260	50-350	280-672	325-853	425-1070	490-1150
A3	96-225	110-270	110-300	140-360	190-490	356-748	400-928	500-1150	564-1224
A4	186-315	200-350	200-400	280-500	330-630	-	-	-	-
max. swing dia.	395	440	480	600	730	1000	1170	1390	1476
Jaw movement	64	80	100	110	150	120	150	175	140

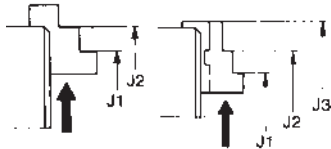
**Internal chucking**

Ø 74-630

Ø 700-1250

Size	74	80	85	100	110	125	140	160	200	250
J1	23-46	25-53	25-53	33-66	33-71	37-87	39-89	39-107	44-140	59-165
J2	45-68	50-78	50-78	65-94	65-104	73-123	83-132	83-152	92-186	119-236

Size	315	350	400	500	630	700	800	1000	1250
J1	96-224	100-260	100-300	135-355	150-450	212-648	251-855	356-1080	426-1162
J2	186-305	190-350	190-390	275-460	290-590	290-758	326-930	430-1150	500-1236
J3	-	-	-	-	-	526-922	566-1094	660-1314	740-1400

Clamping ranges for lathe chucks with individual adjustable jaws (EG-ES) are in approximate conformity with the above values. They are valid for 3- and 4-jaw chucks and lathe chucks with reversible jaws.

**Do not exceed maximum chucking ranges.**

**Max. permissible speeds for ZG-ZS, ZGU-ZSU, ZG Hi-Tru chucks to DIN 6350**

The maximum permissible speed has been fixed so that 1/3 of the gripping force is still available as residual gripping force if the maximum gripping is applied and the chuck is fitted with its heaviest jaws. The jaws may not project beyond the outside diameter of the chuck. The chuck must be in perfect condition. The speed limit for chucks with cast iron bodies is based on the permissible peripheral speed for cast iron. The specification DIN 6386 Part 1 shall be observed.

Size	3 and 4 jaws	
	Cast iron body	Steel body
74	5000	-
80	5000	7000
100	4500	6300
125	4000	5500
140	3700	5000
160	3600	4600
200	3000	4000
250	2500	3000
315	2000	2300
350	1700	1900
400	1600	1800
500	1000	1300
630	800	850
700	650	800
800	600	700
1000	480	560
1250	380	450



# Jaw dimensions ZG-ZS, ZGU-ZSU, ZGF, ZG Hi-Tru

Dimensions F and G apply to outward stepped jaws **BB**  
 Dimensions J and K apply to inward stepped jaws **DB**

Outward stepped jaw (inside jaw) **BB**

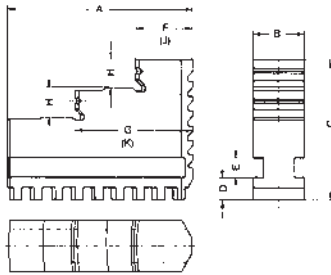

Size	74 <sup>1)</sup>	80/85	100/110	125	140	160	200	250	315	300/400	500/630
A	32	37	48	52	61	61	69	90	130	130	190
B	10	12	14	18	18	18	20	24	34	34	42
C	23	26	33,5	41,5	41,5	47,5	53,5	67,5	79,5	79,5	95
D	4,7	4,8	6,3	7,3	8,3	8,3	8,3	10,3	11,3	11,3	14,9
E	4	4,5	6	7	7	7	8	10	15	15	15
F	10	12	15	17	18	18	20	27	41,5	41,5	50
G	21	24,5	31	35	40	40	44	57	86,5	86,5	120
H	5	6	6	8	8	10	10	14	15	15	20
J	-	12	14	16	17	17	19	26	40	40	50
K	-	24,5	30	34	39	39	43	56	85	85	120
Jaw approx. kg	<b>BB</b> 0,03	0,05	0,1	0,2	0,22	0,25	0,3	0,7	1,8	1,8	3,8
	<b>BL</b> 0,05	0,08	0,15	0,27	0,32	0,38	0,52	1	2,4	2,4	5,2

Unstepped jaw, soft (block jaw) **BL**

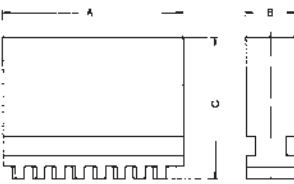

1) Reversible jaws

Base jaw **GB**

Ø 100-400

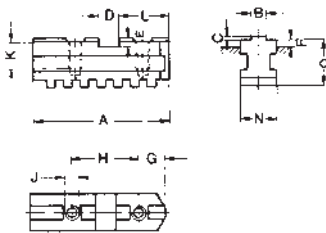

Size	100/110	125	140	160	200	250	315	350/400	500	630
A	46	55	65	65	78	92	108	127	165	203
B <sub>0,05</sub>	7,94	7,94	7,94	7,94	7,94	12,7	12,7	12,7	12,7	12,7
C	2,5	3,1	3,1	3,1	3,1	3,1	3,1	3,1	3,1	3,1
D <sup>+0,01</sup>	9,5	12,68	12,68	12,68	12,68	19,03	19,03	19,03	19,03	19,03
E	6	7,6	7,6	7,6	7,6	7,6	7,6	10,8	10,8	10,8
F	3,4	4,8	7,6	4,8	6,8	8	5,5	10,5 <sup>2)</sup>	8,5	8,5
G	12	13	15,8	15,8	19	22,2	25,4	28,5	28,5	28,5
H	24	32	38,1	38,1	44,45	54	63,5	76,2	38,1	38,1
J	metr. M6	M8	M8	M8	M8	M12	M12	M16	M20	M20
	UNC 1/4"-20	5/16"-18	3/8"-16	3/8"-16	3/8"-16	1/2"-13	1/2"-13	5/8"-11	3/4"-10	3/4"-10
K	12	14,5	16	16	16	20	25	29	33	33
L	19,25	22,6	28,5	28,5	34,9	39,7	47,6	57,1	57,1	57,1
M	-	-	-	-	-	-	-	-	38,1	38,1
N	14	18	18	18	20	24	34	34	42	42
O	19,5	24	27	27	28	35	40	45	49	49
Grooves	1	1	1	1	1	1	1	1	2	3
Tapped holes	2	2	2	2	2	2	2	2	4	5
Jaw approx. kg	0,06	0,12	0,17	0,17	0,22	0,4	0,78	1	1,72	2,1

Ø 500-630

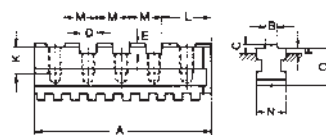

Ø 700-1250

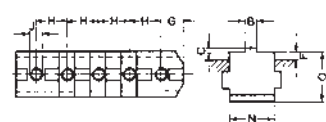

Size	700	800	1000	1250
A	253	291	329	367
B <sub>0,05</sub>	12,7	12,7	12,7	12,7
C	3,1	3,1	3,1	3,1
D <sup>+0,01</sup>	19,03	19,03	19,03	19,03
E	10,8	10,8	10,8	10,8
F	11	11	9	9
G	28,5	28,5	28,5	28,5
H	38,1	38,1	38,1	38,1
J	metr. M20	M20	M20	M20
	UNC 3/4"-10	3/4"-10	3/4"-10	3/4"-10
K	37	37	37	37
L	57,1	57,1	57,1	57,1
M	38,1	38,1	38,1	38,1
N	55	55	55	55
O	62	62	62	62
Grooves	4	5	6	7
Tapped holes	6	7	8	9
Jaw approx. kg	6,2	7,1	8	9

1) Reversible jaws 2) Size

# Jaw dimensions ZG-ZS, ZGU-ZSU, ZGF, ZG Hi-Tru

Reversible top jaw **UB**

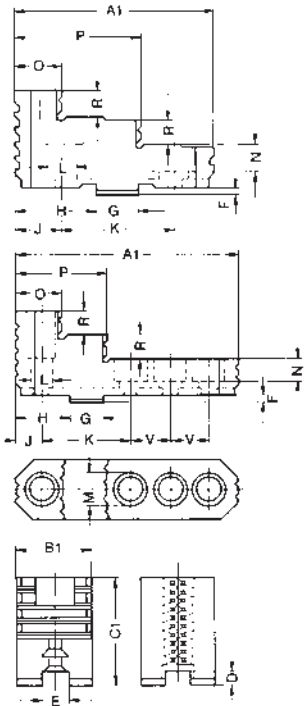

Chuck size		100 110	125	140 160	200 230	250 270	315	350 400	500 630	700 800	1000 1250
A	1	47	56	66,7	79,5	95,3	109,5	127	127	210	210
	2	53	62	74	87	103	120	137	140	210	210
B	1	22	26	28	30	36	42	42	50	68	68
	2	22,5	26,5	28,5	30,5	36,5	42,5	42,5	50,5	68	68
C	1	29,5	37,5	41,5	42,5	52,5	57,5	64,5	79,5	89	110
	2	30	38	42	43	53	58	65	80	89	110
D		5,5	7,6	7,6	7,6	7,6	7,6	10,8	10,8	10,8	10,8
E		7,96	7,96	7,96	7,96	12,72	12,72	12,72	12,72	12,72	12,72
F		2,5	3,1	3,1	3,1	3,1	3,1	6,35	6,35	6,35	6,35
G		9,50	12,68	12,68	12,68	19,03	19,03	19,03	19,03	19,03	19,03
H		19,25	22,6	28,5	34,9	39,7	47,6	57,1	57,1	57,1	57,1
J		12	13	15,8	19	22,2	25,4	28,5	28,5	28,5	28,5
K		24	32	38,1	44,45	53,95	63,5	76,2	76,2	76,2	76,2
L		6,6	9	9 <sup>1)</sup> 10,5 <sup>2)</sup>	9 <sup>1)</sup> 10,5 <sup>2)</sup>	14	14	18	22	22	22
M		11	15	15 <sup>1)</sup> 16 <sup>2)</sup>	15 <sup>1)</sup> 16 <sup>2)</sup>	20	20	26	33	33	33
N		7	9	10	10	13,5	13,5	17	21	21,5	21,5
O		12	13	15,8	19	22,2	25,4	28,5	54,6	51	51
P		29,5	35	42,8	51,5	60,2	67,4	77	88,5	89	89
R		6	8	10	10	14	15	15	20	22	25
S		22,25	25,6	32,2	38,7	43,5	52,9	62,1	63,6	70	70
T		15	16	19,5	22,8	26	30,7	33,55	35	41,5	41,5
U		19	27	30	30	41	43	47	61	65	71
V		-	-	-	-	-	-	-	-	38,1	38,1
Jaw approx. kg	<b>UB</b>	0,12	0,19	0,27	0,39	0,66	1,02	1,27	2	4,45	6,1
	<b>AB</b>	0,21	0,34	0,5	0,7	1,2	1,86	2,18	3,04	8	10,8

Saw-tooth standard model      Cross-grooving from size 250 available from size 700 standard-model

Unstepped top jaw soft **AB**

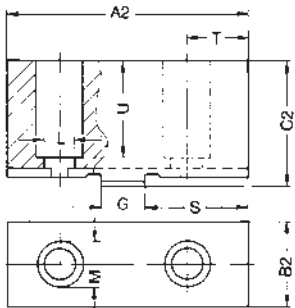



The spiral ring chuck - a proven and universal suitable clamping system - finds its application wherever a high clamping force, high runout accuracy and very high repeatability are required (e. g. lathes, turntables, circular indexing tables, etc.).  
The radial and axial runout precision corresponds to DIN 6386 Part 1, Precision Class 1 (high precision chucks).

The jaws can be moved across the entire clamping range by turning a key. Due to this, workpieces with different diameters can be clamped without changing or shifting the jaws.  
Special flat design with direct mounting.

**Technical features:**

- with double jaw guides
- cast iron body
- with scroll
- self-centering
- three-jaw chuck
- lathe chucks must be lubricated regularly to maintain their gripping force

**Delivery includes:**

- 1 set of outward stepped jaws (BB) mounted in the chuck,
- 1 set of inward stepped jaws (DB),
- 1 operating key, mounting bolts
- or**
- 1 set of base and reversible top jaws (GB+UB),
- 1 operating key, mounting bolts

Tool group A09  
Type 700 **with out- and inward stepped jaws**  
DIN 6350; cylindrical centre mount, form A

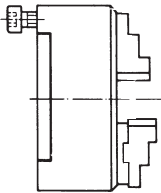

Item no.	Size	ZA	Through-hole	Speed max. min-1	Torque Nm	Total clamping force kN
106069 <span style="color: yellow;">■</span>	200	160	55	2300	140	55
119441 <span style="color: yellow;">■</span>	230	191	65	1900	140	55
106070 <span style="color: yellow;">■</span>	250	200	76	1900	150	63
112258 <span style="color: yellow;">■</span>	270	200	85	1900	150	63
106071 <span style="color: yellow;">■</span>	315	260	103	1500	180	69
128349 <span style="color: red;">▲</span>	400	330	136	1200	240	92
111552 <span style="color: red;">▲</span>	500	420	190	750	260	100

Tool group A09  
Type 703 **with base and reversible top jaws**  
DIN 6350; cylindrical centre mount, form A

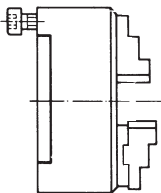

Item no.	Size	ZA	Through-hole	Speed max. min-1	Torque Nm	Total clamping force kN
106060 <span style="color: red;">▲</span>	200	160	55	2300	140	55
119456 <span style="color: red;">▲</span>	230	191	65	1900	140	55
106062 <span style="color: red;">▲</span>	250	200	76	1900	150	63
106064 <span style="color: red;">▲</span>	315	260	103	1500	180	69
104652 <span style="color: red;">▲</span>	400	330	136	1200	240	92
132982 <span style="color: red;">▲</span>	500	420	190	750	260	100

Tool group A09  
Type 715 **with out- and inward stepped jaws**  
ISO 702-3 (DIN 55027), DIN 55022; with studs and locknuts, optional DIN 55021 with set screw and nut

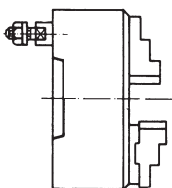

Item no.	Size	Mount short taper	Through-hole	Speed max. min-1	Torque Nm	Total clamping force kN
108145 <span style="color: red;">▲</span>	200	5	55	2300	140	55
108149 <span style="color: red;">▲</span>	200	6	55	2300	140	55
108234 <span style="color: red;">▲</span>	250	5	76	1900	150	63
108226 <span style="color: red;">▲</span>	250	6	76	1900	150	63
108230 <span style="color: red;">▲</span>	250	8	76	1900	150	63
108333 <span style="color: red;">▲</span>	315	6	103	1500	180	69
108337 <span style="color: red;">▲</span>	315	8	103	1500	180	69
128345 <span style="color: red;">▲</span>	400	8	136	1200	240	92
104654 <span style="color: red;">▲</span>	400	11	136	1200	240	92
129810 <span style="color: red;">▲</span>	500	11	190	750	260	100

## ZGD

Tool group A09  
Type 718 **with base and reversible top jaws**  
**ISO 702-3** (DIN 55027), DIN 55022; with studs and locknuts, optional DIN 55021 with set screw and nut

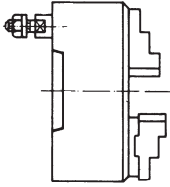

Item no.	Size	Mount short taper	Through-hole	Speed max. min-1	Torque Nm	Total clamping force kN
108148 ▲	200	5	55	2300	140	55
108152 ▲	200	6	55	2300	140	55
108237 ▲	250	5	76	1900	150	63
108229 ▲	250	6	76	1900	150	63
108233 ▲	250	8	76	1900	150	63
108336 ▲	315	6	103	1500	180	69
108340 ▲	315	8	103	1500	180	69
104656 ▲	400	8	136	1200	240	92
104658 ▲	400	11	136	1200	240	92
132983 ▲	500	11	190	750	260	100

Tool group A09  
Type 720 **with out- and inward stepped jaws**  
**ISO 702-1** (DIN 55026); DIN 55021, ASA B 5.9, A1/A2 metr.; mounting from front

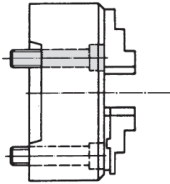

Item no.	Size	Mount short taper	Through-hole	Speed max. min-1	Torque Nm	Total clamping force kN
108161 <sup>1)</sup> ▲	200	5	42	2300	140	55
108165 <sup>1)</sup> ▲	200	6	55	2300	140	55
108238 <sup>1)</sup> ▲	250	6	55	1900	150	63
108242 <sup>1)</sup> ▲	250	8	76	1900	150	63
108345 ▲	315	6	103	1500	180	69
108349 <sup>1)</sup> ▲	315	8	76	1500	180	69
104660 ▲	400	8	136	1200	240	92
104662 <sup>1)</sup> ▲	400	11	125	1200	240	92
111545 ▲	500	11	190	750	260	100

<sup>1)</sup> mounting from front in the inner bolt circle

Tool group A09  
Type 723 **with base and reversible top jaws**  
**ISO 702-1** (DIN 55026); DIN 55021, ASA B 5.9, A1/A2 metr.; mounting from front

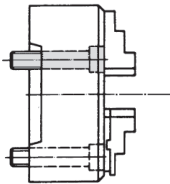

Item no.	Size	Mount short taper	Through-hole	Speed max. min-1	Torque Nm	Total clamping force kN
108164 <sup>1)</sup> ▲	200	5	42	2300	140	55
108168 <sup>1)</sup> ▲	200	6	55	2300	140	55
108241 <sup>1)</sup> ▲	250	6	55	1900	150	63
108245 <sup>1)</sup> ▲	250	8	76	1900	150	63
108348 ▲	315	6	103	1500	180	69
108352 <sup>1)</sup> ▲	315	8	76	1500	180	69
104664 ▲	400	8	136	1200	240	92
104666 <sup>1)</sup> ▲	400	11	125	1200	240	92
132984 ▲	500	11	190	750	260	100

<sup>1)</sup> mounting from front in the inner bolt circle

Tool group A09  
Type 730 **with out- and inward stepped jaws**  
**ISO 702-2** (DIN 55029); ASA B 5.9, Type D, with studs for Camlock

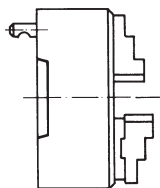

Item no.	Size	Mount short taper	Through-hole	Speed max. min-1	Torque Nm	Total clamping force kN
109237 ▲	200	5	55	2300	140	55
109239 ▲	200	6	55	2300	140	55
119442 ▲	230	5	65	1900	140	55
119443 ▲	230	6	65	1900	140	55
109238 ▲	250	5	76	1900	150	63
109240 ▲	250	6	76	1900	150	63
109242 ▲	250	8	76	1900	150	63
119552 ▲	270	6	82	1900	150	63
112261 ▲	270	8	82	1900	150	63
109241 ▲	315	6	103	1500	180	69
109243 ▲	315	8	103	1500	180	69
104668 ▲	400	8	136	1200	240	92
104670 ▲	400	11	136	1200	240	92
111586 ▲	500	11	190	750	260	100

Tool group A09  
Type 733 **with base and reversible top jaws**  
**ISO 702-2** (DIN 55029); ASA B 5.9, Type D, with studs for Camlock

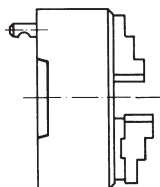

Item no.	Size	Mount short taper	Through-hole	Speed max. min-1	Torque Nm	Total clamping force kN
106739 ▲	200	5	55	2300	140	55
106741 ▲	200	6	55	2300	140	55
108311 ▲	250	5	76	1900	150	63
108307 ▲	250	6	76	1900	150	63
108309 ▲	250	8	76	1900	150	63
108406 ▲	315	6	103	1500	180	69
108408 ▲	315	8	103	1500	180	69
104706 ▲	400	8	136	1200	240	92
104708 ▲	400	11	136	1200	240	92
132985 ▲	500	11	190	750	260	100

# Jaws ZGD

Tool group A09  
Type 700 **Out- and inward stepped jaws**, set outward stepped jaw, hardened

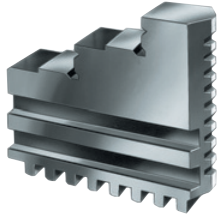

Item no.	Chuck Size	Number of jaws	Jaw length	Jaw height	Jaw width
110019 ●	200	3	75	72	20
119447 ■	230	3	95	72	20
110020 ●	250/270	3	90	75,5	24
110021 ■	315	3	130	91,5	34
128176 ■	400	3	130	103,5	34
111547 ■	500	3	190	115	42

Stepped and hardened jaws, supplied as supplement or as spares, must be ground on the chuck.  
In case of a subsequent jaw delivery please return the chuck.

Tool group A09  
Type 700 **Outside jaw DB**, set inward stepped jaw, hardened

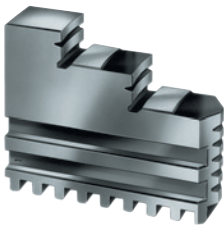

Item no.	Chuck Size	Number of jaws	Jaw length	Jaw height	Jaw width
110022 ■	200	3	75	72	20
119448 ■	230	3	95	72	20
110023 ■	250/270	3	90	75,5	24
110024 ■	315	3	130	91,5	34
128177 ■	400	3	130	103,5	34
111548 ■	500	3	190	115	42

Stepped and hardened jaws, supplied as supplement or as spares, must be ground on the chuck.  
In case of a subsequent jaw delivery please return the chuck.

Tool group A09  
Type 701 **Block jaw BL**, set unstepped, soft, 16MnCr5

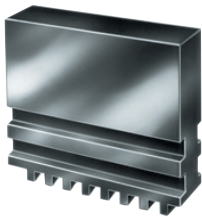

Item no.	Chuck Size	Number of jaws	Jaw length	Jaw height	Jaw width
107646 ■	200	3	75	72	20
119449 ■	230	3	95	72	20
107647 ●	250/270	3	90	76	24
107648 ■	315	3	130	92	34
128178 ■	400	3	130	103,5	34
129811 ■	500	3	190	115	42

Stepped and hardened jaws, supplied as supplement or as spares, must be ground on the chuck.  
In case of a subsequent jaw delivery please return the chuck.

Tool group A09  
Type 702 **Base jaw GB**, set with fixing screw

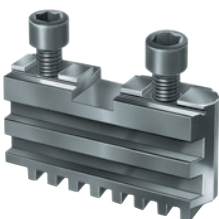

Item no.	Chuck Size	Number of jaws	Jaw length	Jaw height	Jaw width
107510 ■	230	3	80	41	20
107511 ■	250/270	3	92	47	24
107512 ■	315	3	108	56	34
128179 ■	400	3	127	61	34
129812 ■	500	3	165	72	42

Stepped and hardened jaws, supplied as supplement or as spares, must be ground on the chuck.  
In case of a subsequent jaw delivery please return the chuck.

Tool group A09  
Type 303 **Reversible top jaws UB DIN 6350** hardened

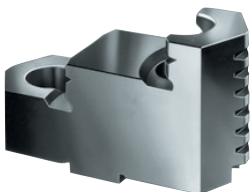

Item no.	Chuck Size	Number of jaws	Jaw length	Jaw height	Jaw width
107937 ●	200	3	79,5	42,5	30
108049 ●	250	3	95,3	52,5	36
108050 ●	315	3	109,5	57,5	42
108051 ●	400	3	127	64,5	42
108052 ■	500	3	127	79,5	50

Stepped and hardened jaws, supplied as supplement or as spares, must be ground on the chuck.  
In case of a subsequent jaw delivery please return the chuck.

# Jaws ZGD

Tool group A09  
Type 302 **Unstepped top jaw AB**  
**DIN 6350**  
soft, material 16MnCr5



Item no.	Chuck Size	Number of jaws	Jaw length	Jaw height	Jaw width
108582 ●	200	3	87	43	30,5
107637 ●	250	3	103	53	36,5
107638 ●	315	3	120	58	42,5
107639 ●	400	3	137	65	42,5
107640 ●	500	3	140	80	50,5

Tool group C15  
Type 0040-Y  
**Mounting bolt for top jaws**  
**bolt 1**



Item no.	Size	Thread
334571 ●	200/230	M8x30
233025 ●	250/270	M10x35
233026 ●	315	M12x45
220565 ●	400	M16x50
249003 ●	500	M20x80

Tool group C15  
Type 0040-Y  
**Mounting bolt for top jaws**  
**bolt 2**



Item no.	Size	Thread
233058 ●	200/230	M8x20
227692 ●	250/270	M12x25
233030 ●	315	M12x30
220564 ●	400	M16x35
233047 ●	500	M20x40

# Accessories ZGD

Tool group A09

 Type 600 **Base plates** for lathe chucks with **cylindrical centre mount**  
DIN 6350

Item no.	Size
162793 <span style="color: yellow;">■</span>	160
162401 <span style="color: yellow;">■</span>	200
163036 <span style="color: yellow;">■</span>	250
133705 <span style="color: yellow;">■</span>	315

Tool group A09

 Type 304 **Unfinished adapter plates** for **cylindrical mount**

The unfinished back plate must be machined and fitted on both machine and chuck side

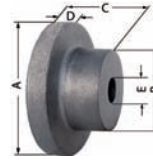

Item no.	Chuck Size	Inch	A	B	C	D	E
017117 <span style="color: green;">●</span>	200	8	210	92	66	22	40
017118 <span style="color: yellow;">■</span>	250	10	260	105	92	25	50
017119 <span style="color: yellow;">■</span>	315	12 ½	330	165	100	30	50
017124 <span style="color: yellow;">■</span>	350	14	365	180	120	30	60
017120 <span style="color: yellow;">■</span>	400	15 ¾	420	230	130	55	70

Tool group A09

 Type 700 **Chip guard, piece**

Item no.	Contents of delivery	Size
120668 <span style="color: yellow;">■</span>	piece	200/230
120669 <span style="color: yellow;">■</span>	piece	250/270
120670 <span style="color: yellow;">■</span>	piece	315/400
129816 <span style="color: yellow;">■</span>	piece	500/630

Tool group C15

 Type 1028 **Special grease F80** for **lathe chucks** for lubrication and conservation of chucking power

Item no.	Design	Contents
028975 <span style="color: green;">●</span>	Tin	1 kg

Tool group A09

 Type 300 **Scroll**

Item no.	Size
100003 <span style="color: green;">●</span>	200
131954 <span style="color: yellow;">■</span>	230
100203 <span style="color: green;">●</span>	250
101552 <span style="color: green;">●</span>	315
105228 <span style="color: yellow;">■</span>	350
102497 <span style="color: green;">●</span>	400
162973 <span style="color: yellow;">■</span>	500

Tool group A09

 Type 300 **Driving pinion**

Item no.	Size
100005 <span style="color: green;">●</span>	200
119256 <span style="color: yellow;">■</span>	230
100204 <span style="color: green;">●</span>	250
112267 <span style="color: yellow;">■</span>	270
101553 <span style="color: green;">●</span>	315
105229 <span style="color: green;">●</span>	350
102498 <span style="color: green;">●</span>	400
162974 <span style="color: yellow;">■</span>	500

Tool group A09

 Type 300 **Pinion holder screw**

Item no.	Size
100006 <span style="color: green;">●</span>	270
101554 <span style="color: green;">●</span>	315
102499 <span style="color: green;">●</span>	400
103300 <span style="color: green;">●</span>	630

Tool group A09

 Type 300 **Standard key**

Item no.	Size	Square	Length
107430 <span style="color: green;">●</span>	200/230	11	100
107431 <span style="color: green;">●</span>	250/270	12	100
107432 <span style="color: green;">●</span>	315	14	110
107433 <span style="color: green;">●</span>	350	14	140
107434 <span style="color: green;">●</span>	400	17	140
107435 <span style="color: green;">●</span>	500/630	19	150

Tool group A09

 Type 300 **Safety key**

Item no.	Size	Square	Length
154374 <span style="color: green;">●</span>	200/230	11	160
154375 <span style="color: green;">●</span>	250/270	12	160
154376 <span style="color: green;">●</span>	315	14	200
154377 <span style="color: green;">●</span>	350	14	200
154378 <span style="color: green;">●</span>	400	17	250
154379 <span style="color: yellow;">■</span>	500/630	19	250

Tool group A09

 Type 300 **Elongated safety key**

Item no.	Size	Square	Length
154687 <span style="color: green;">●</span>	200/230	11	200
154689 <span style="color: green;">●</span>	250/270	12	200
154695 <span style="color: green;">●</span>	315	14	250

# Accessories ZGD

**Tool group C15**
**Type 0040-Y Mounting screws with cylindrical centre rim**

Item no.	Size	Thread
249299 ●	74-85	M6x20
334571 ●	100-140	M8x30
249301 ●	160-230	M10x35
233025 ●	250-270	M10x35
220565 ●	315-350	M16x50
229183 ●	400-630	M16x60

**Tool group C15**
**Type 0040-Y Mounting screws for lathe chucks with direct short-taper, for front mounting**

Item no.	Size	Thread	Chuck Size	Taper size
302195 ●	74	M10x55	160	5
200184 ●	80	M10x65	200	5
233006 ●	85	M12x65	200	6
233075 ●	100	M10x90	250	5
216549 ●	110	M12x70	250	6
302194 ●	125	M16x70	250	8
242954 ●	140	M12x100	315	6
358816 ●	160	M16x85	315	8
243665 ●	200/230	M12x130	350	6
236516 ●	315	M16x110	400	8
615744 ●	350	M20x95	400	11
010210 ●	400	M20x130	500	11
328925 ●	500	M20x145	630	11
367648 ●	630	M24x125	630	15

**Tool group A09**
**Type 310 Set screw with nut DIN 55021**

Item no.	Thread	For taper	Quantity
107455 ●	M10x35	5	4
107456 ●	M12x40	6	4
107457 ▲	M16x45	8	4
107458 ▲	M20x55	11	6

**Tool group A09**
**Type 315 Stud and locknut ISO 702-3 (DIN 55027)**

Item no.	Thread	For taper	Quantity
107449 ●	M10x43	5	4
107450 ●	M12x50	6	4
107451 ●	M16x60	8	4
107452 ●	M20x75	11	6

**Tool group A09**
**Type 330 Stud for Camlock ISO 702-2 (DIN 55029) and cylindrical studs**

Item no.	Thread	For taper	Quantity
107467 ●	1/2-20x43	5	6
107468 ●	5/8-18x49	6	6
107469 ●	3/4-16x55,5	8	6
107470 ●	7/8-14x67	11	6



# Chuck dimensions ZGD

**Cylindrical centre mount DIN 6350**

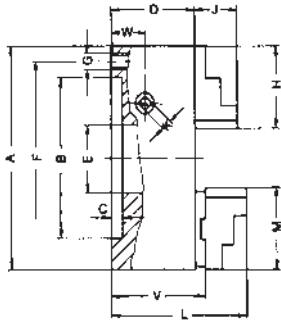

Size A	200	230	250	270	315	400	500
B <sup>H6</sup>	160	191	200	200	260	330	420
C	4	4	5	5	5	5	5
D	84	84	93	93	107	118	140
E	55	65	76	85	103	136	190
E <sub>max</sub>	70	73	92	92	114	150	210
F	176	208	224	224	286	362	458
G	3xM10	3xM12	3xM12	3xM12	3xM16	3xM16	3xM16
H	75	95	90	90	130	130	190
J	40,3	40,3	37,5	37,5	45	54	55
K	11	11	12	12	14	17	19
L	129,6	129,6	148,5	148,5	168	184,5	221,5
M	79,5	79,5	95	95	109,5	127	127
V	90,2	90,2	99	99	113,5	126,4	148,4
W	25,7	25,7	26,5	26,5	30	35	38
approx. kg	16	17	27	29	49	90	152

The bore could be enlarged (measure E, at surcharge)  
 enlarged bore max.

**Short taper mount**

**DIN 55021**

with setscrews and locknuts



**DIN 55027** with studs and nuts

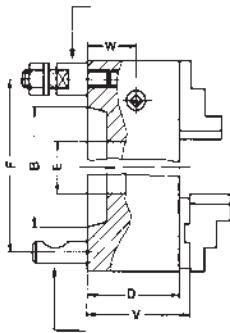

Size	200		230		250		270		315		400		500	
Short-taper size	5	6	5	6	5	6	8	6	8	6	8	8	11	11
B	82,5	106,4	82,5	106,4	82,5	106,4	139,7	106,4	139,7	106,4	139,7	139,7	196,9	196,9
D	85	85	85	85	94	94	94	94	94	108	108	119	119	142
E	55	55	65	65	76	76	82	82	103	103	136	136	190	190
F	104,8	133,4	104,8	133,4	104,8	133,4	171,4	133,4	171,4	133,4	171,4	171,4	235	235
V	91,2	91,2	91,2	91,2	100	100	100	-	-	114,5	114,5	127,4	127,4	150,4
W	26,7	26,7	26,7	26,7	27,5	27,5	27,5	27,5	27,5	31	31	36	36	40
Mount holes	DIN Caml. 4/6		4/-		4/4		4/-		4/4		4/4		6/6	
approx. kg	18		19		30		31		53		95		168	

**DIN 55029** with studs for camlock

**DIN 55026** mounting from front

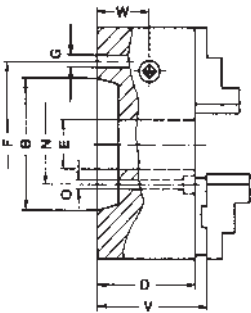

Size A	200		230		250		270		315		400		500	
Short-taper size	5	6	5	6	6	8	6	8	6	8	8	11	11	
B	82,5	106,4	82,5	106,4	106,4	139,7	106,4	139,7	106,4	139,7	139,7	196,9	196,9	
D	85	85	85	85	94	94	94	94	108	108	119	119	142	
E	42	55	42	55	55	76	55	81	103	76	136	125	190	
F <sup>2)</sup>	-	-	-	-	-	-	-	-	133,4	-	171,4	-	235	
G	-	-	-	-	-	-	-	-	14	-	18	-	22	
N <sup>3)</sup>	61,9	82,6	61,9	82,6	82,6	111,1	82,6	111,1	-	111,1	-	165,1	-	
O	11 <sup>1)</sup>	14	11 <sup>1)</sup>	14	14	18	14	18	-	18	-	22	-	
V	91,2	91,2	91,2	91,2	100	100	100	100	114,5	114,5	127,4	127,4	150,4	
W	26,7	26,7	26,7	26,7	27,5	27,5	27,5	27,5	31	31	36	36	40	
Mount. holes	3/6		3/6		6/6		6/6		6/6		6/6		6/6	
approx. kg	18		19		30		31		53		93		165	

1) 12 with ASA B 5.9 inch, all other dimensions should be taken from the table on the top  
 2) with DIN 55026 Form A and B; DIN 55021 Form A and B; ASA B 5.9 A1/A2  
 3) with DIN 55026 form B; ASA B 5.9 A1/B1

# Jaw dimensions ZGD

Dimensions G and H apply to outward stepped jaws **BB**  
 Dimensions K and L apply to inward stepped jaws **DB**

Outward stepped jaw (inside jaw) **BB**

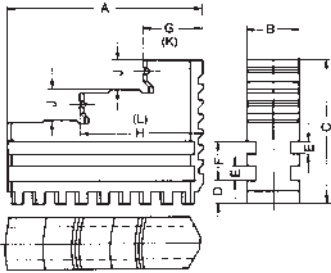

Size	200	230	250	270	315	400	500
A	75	95	90	90	130	130	190
B	20	20	24	24	34	34	42
C	72	72	75,5	75,5	91,5	103,5	115
D	8,3	8,3	10,3	10,3	11,3	11,3	14,9
E	7	7	8	8	10	10	12
F	20	20	23	23	29	29	34
G	25	30	27	27	41,5	41,5	50
H	49	62,5	57	57	86,5	86,5	120
J	16	17	14	14	15	24	20
K	25	30	26	26	40	40	50
L	49	62,5	56	56	85	85	120

Unstepped jaw, soft (block jaw) **BL**

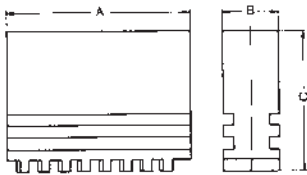

Size	200	230	250	270	315	400	500
A	75	95	90	90	130	130	190
B	20	20	24	24	34	34	42
C	72	72	76	76	92	103,5	115
Jaw approx. kg	BB	BL					
	0,5	0,7	0,6	0,8	0,8	2,1	2,4
			0,85	1,1	1,1	2,8	3,1
							4,8
							6,6

Base jaw **GB**

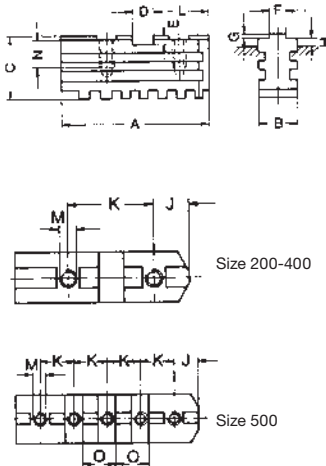

Size	200	230	250	270	315	400	500
A	80	80	92	92	108	127	165
B	20	20	24	24	34	34	42
C	41	41	47	47	56	61	72
D <sup>+0,01</sup>	12,68	12,68	19,03	19,03	19,03	19,03	19,03
E	76	76	76	76	76	10,8	10,8
F <sup>-0,05</sup>	7,94	7,94	12,7	12,7	12,7	12,7	12,7
G	3,1	3,1	3,1	3,1	3,1	3,1	3,1
H	6,3	6,3	6	6	6,5	8,5	8,5
J	19	19	22,2	22,2	25,4	28,5	28,5
K	44,45	44,45	54	54	63,5	76,2	38,1
L	34,9	34,9	39,7	39,7	47,6	57,1	57,1
M	M8	M8	M12	M12	M12	M16	M20
N	16	16	20	20	26	29	36
O <sup>+0,01</sup>	-	-	-	-	-	-	38,1
Grooves	1	1	1	1	1	1	2
Tapped holes	2	2	2	2	2	2	4
Jaw approx. kg	0,28	0,28	0,5	0,5	1,1	1,27	2,38

Reversible top jaws **UB** and unstepped top jaws **AB**

## Special-design jaws

for non-rotating clamping devices, for symmetrical components,  
 for machine vices and NC-compact vices  
 Available in all desired modifications

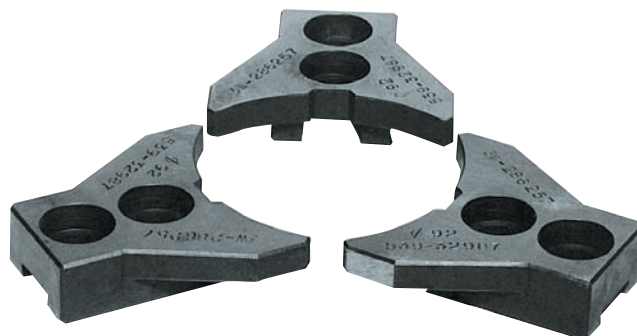

**ZG Hi-Tru**

The ZG Hi-Tru hand-operated lathe chuck is most suitable for the production of components with top concentricity. It is for universal use, but particularly profitable for grinding machines, dividing apparatus and turning machines.

Handling is very simple. The clamped workpiece is adjusted to the required concentricity by means of 3 tangentially arranged adjusting spindles. Self-centering with the aid of scroll and pinion.



**Technical features:**

- with one set outside jaws and one set inside jaws
- with scroll
- with radial precision adjustment for top concentricity
- self-centering
- hardened adjusting spindles
- lathe chucks must be lubricated regularly to maintain their gripping force

**Customer advantage:**

- adjusting accuracy within 0.005 mm
- repeatability 0.015 mm
- induction hardened support surface for adjusting spindle
- steel adapter plate
- cast iron body
- precision adjustment without opening the mounting screws

**Delivery includes:**

- 1 set of outward stepped jaws (BB) mounted in the chuck,
- 1 set of inward stepped jaws (DB),
- 1 operating key, mounting bolts

Tool group A09  
Type 306-00 **ZG Hi-Tru**,  
with one set outward stepped  
jaws and one set inward  
stepped jaws  
**DIN 6350**; cylindrical centre mount,  
form A

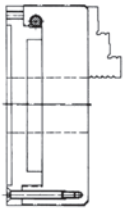

Item no.	Size	ZA	Through-hole	Speed max. min-1	Torque Nm	Total clamping force kN
146195	80	56	19	5000	30	13
146196	100	70	20	4500	60	27
145118	125	95	32	4000	80	31
145119	160	125	42	3600	110	47
144749	200	160	55	3000	140	55
145120	250	200	76	2500	150	63
143545	315	260	103	2000	180	69

on request from size 125 with 6 jaws or with short-taper mount to ISO 702-3 (DIN 55027) or ISO 702-2 (DIN 55029) Camlock

Tool group A09  
Type 306-04 **ZG Hi-Tru**,  
with special seal for grinding  
machines  
**DIN 6350**; cylindrical centre mount,  
form A

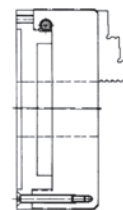

Item no.	Size	ZA	Speed max. min-1	Torque Nm	Total clamping force kN
146197	80	56	5000	30	13
146198	100	70	4500	60	27
144957	125	95	4000	80	31
145116	160	125	3600	110	47
145110	200	160	3000	140	55
145117	250	200	2500	150	63
146199	315	260	2000	180	69

on request from size 125 with 6 jaws or with short-taper mount to ISO 702-3 (DIN 55027) or ISO 702-2 (DIN 55029) Camlock

**DIN 6350**  
Cylindrical centre mount, form A

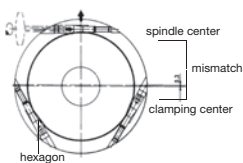

Size A	Inch	B <sup>+0.02</sup>	C	D	F	G	SW	Weight
<b>Typ 306-00 ZG Hi-Tru, with 1 set each outward or inward stepped jaws</b>								
80	3 <sup>1/4</sup>	56	3	50,5	67	3xM6	4	1,7
100	4	70	3	63	83	3xM8	5	3,6
125	5	95	4	72	108	3xM8	5	5,6
160	6 <sup>1/4</sup>	125	4	81	140	3xM10	6	10
200	8	160	4	89,5	176	3xM10	6	17,2
250	10	200	5	102	224	3xM12	8	34,5
315	12 <sup>1/2</sup>	260	5	122	286	3xM16	8	57,5

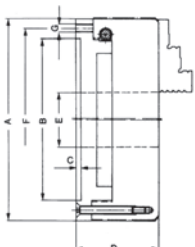

Size A	Inch	B <sup>+0.02</sup>	C	D	F	G	SW	Weight
<b>Typ 306-04 ZG Hi-Tru, with special seal for grinding machines</b>								
80	3 <sup>1/4</sup>	56	3	50,5	67	3xM6	4	1,7
100	4	70	3	63	83	3xM8	5	3,6
125	5	95	4	72	108	3xM8	5	5,6
160	6 <sup>1/4</sup>	125	4	81	140	3xM10	6	10
200	8	160	4	89,5	176	3xM10	6	17,2
250	10	200	5	102	224	3xM12	8	34,5
315	12 <sup>1/2</sup>	260	5	122	286	3xM16	8	57,5

## Jaws ZG Hi-Tru

Tool group A09  
Type 300 **Inside jaw BB DIN 6350**  
outward stepped jaw, hardened

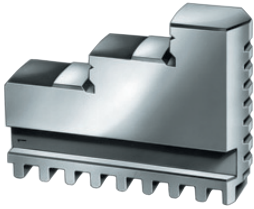

Item no.	Chuck Size	Number of jaws	Jaw length	Jaw height	Jaw width
110155 ●	80	3	37	26	12
110156 ●	100	3	48	33,5	14
110157 ●	125	3	52	41,5	18
110159 ●	160	3	61	47,5	18
110160 ●	200	3	69	53,5	20
110161 ●	250	3	90	67,5	24
110162 ●	315	3	130	79,5	34

<sup>1)</sup> reversible, for use as turning or inside jaws  
Stepped and hardened jaws, supplied as supplement or as spares, must be ground on the chuck.  
In case of a subsequent jaw delivery please return the chuck.

Tool group A09  
Type 300 **Outside jaw DB DIN 6350**  
inward stepped jaw, hardened

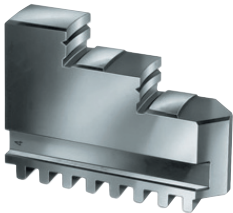

Item no.	Chuck Size	Number of jaws	Jaw length	Jaw height	Jaw width
110165 ●	80	3	37	26	12
110166 ●	100	3	48	33,5	14
110167 ●	125	3	52	41,5	18
110169 ●	160	3	61	47,5	18
110170 ●	200	3	69	53,5	20
110171 ●	250	3	90	67,5	24
110016 ●	315	3	130	79,5	34

Stepped and hardened jaws, supplied as supplement or as spares, must be ground on the chuck.  
In case of a subsequent jaw delivery please return the chuck.

Tool group A09  
Type 301 **Unstepped jaw BL DIN 6350**  
unstepped, soft, 16MnCr5



Item no.	Chuck Size	Number of jaws	Jaw length	Jaw height	Jaw width
107588 ●	80	3	37	26	12
107589 ●	100	3	48	33,5	14
107590 ●	125	3	52	41,5	18
107592 ●	160	3	61	47,5	18
107593 ●	200	3	69	53,5	20
107594 ●	250	3	90	67,5	24
107595 ●	315	3	130	79,5	34

<sup>1)</sup> jaws reversible

Tool group A09  
Type 302 **Base jaw GB DIN 6350**  
with fixing screw

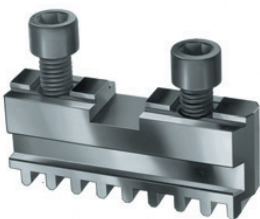

Item no.	Chuck Size	Number of jaws	Jaw length	Jaw width
107500 ●	100	3	46	14
107501 ●	125	3	55	18
107503 ●	160	3	65	18
107504 ●	200	3	78	20
107505 ●	250	3	92	24
107506 ●	315	3	108	34

Tool group A09  
Type 303 **Reversible top jaws UB DIN 6350**  
hardened

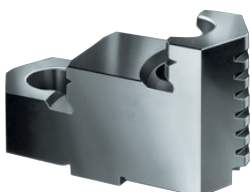

Item no.	Chuck Size	Number of jaws	Jaw length	Jaw height	Jaw width
108045 ■	100	3	47	29,5	22
108046 ■	125	3	56	37,5	26
107936 ●	160	3	66,7	41,5	28
107937 ●	200	3	79,5	42,5	30
108049 ●	250	3	95,3	52,5	36
108050 ●	315	3	109,5	57,5	42

Stepped and hardened jaws, supplied as supplement or as spares, must be ground on the chuck.  
In case of a subsequent jaw delivery please return the chuck.

## Jaws ZG Hi-Tru

Tool group A09  
Type 302 **Unstepped top jaw AB**  
DIN 6350  
soft, material 16MnCr5



Item no.	Chuck Size	Number of jaws	Jaw length	Jaw height	Jaw width
107633 ●	100	3	53	30	22,5
107634 ●	125	3	62	38	26,5
108581 ●	160	3	74	42	28,5
108582 ●	200	3	87	43	30,5
107637 ●	250	3	103	53	36,5
107638 ●	315	3	120	58	42,5

Tool group A09  
Type 301 **Unstepped jaw BL, special length**, soft, 16MnCr5  
DIN 6350

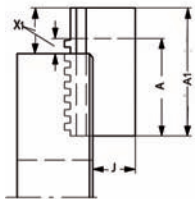

Item no.	Chuck Size	Number of jaws	A1	X1 max.	A	J	X Max.
130031 ■	200	3	100	50	69	32,5	19
132658 ■	250	3	120	56	90	41	26
132184 ■	315	3	160	70	130	46	40
130033 ■	200	3	120	70	69	32,5	19
128880 ■	250	3	140	76	90	41	26
118908 ■	315	3	200	110	130	46	40
121367 ■	315	3	250	160	130	46	40

Tool group A09  
Type 301 **Unstepped jaw BL, special length**, soft, 16MnCr5  
DIN 6350

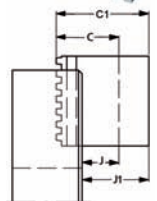

Item no.	Chuck Size	Number of jaws	C1	J1	C	J
125710 ■	200	3	80	58,5	54	32,5
122188 ■	250	3	100	73	68	41
132186 ■	315	3	110	76	80	46
125712 ■	200	3	120	98,5	54	32,5
122189 ■	250	3	130	103	68	41
137096 ■	315	3	140	106	80	46
125714 ■	200	3	150	128,5	54	32,5
137102 ■	250	3	150	123	68	41
137104 ■	315	3	160	126	80	46

Tool group A09  
Type 302 **Top jaw AB, special length**, soft, 16MnCr5  
DIN 6350

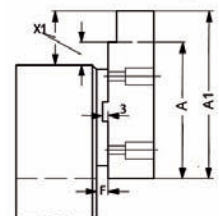
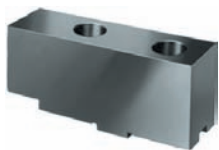

Item no.	Chuck Size	Number of jaws	A1	X1 max.	F	A	X Max.
110086 ■	200	3	100	43	6,8	87	30
112122 ■	250	3	130	63	8	103	36
110624 ■	315	3	160	76	5,5	120	36
112120 ■	200	3	120	63	6,8	87	30
125428 ■	250	3	150	83	8	103	36
112091 ■	315	3	200	116	5,5	120	36
104710 ■	250	3	180	113	8	103	36
112089 ■	315	3	250	166	5,5	120	36

# Jaws ZG Hi-Tru

Tool group A09  
Type 302 **Top jaw AB,**  
**special height,** soft, 16MnCr5  
DIN 6350

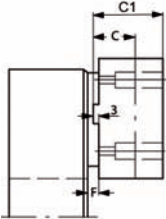

Item no.	Chuck Size	Number of jaws	C1	C	F
132155	200	3	60	43	6,8
119645	250	3	70	53	8
110435	315	3	80	58	5,5
128564	200	3	80	43	6,8
128571	250	3	100	53	8
110437	315	3	110	58	5,5
128573	250	3	150	53	8
128569	315	3	150	58	5,5

Tool group A09  
Type 302 **Top jaw AB,**  
**special width and height,** soft,  
16MnCr5  
DIN 6350

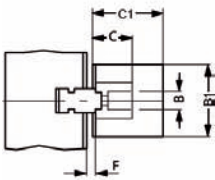

Item no.	Chuck Size	Number of jaws	B1	C1	B	C
105057	200	3	40	70	30,5	43
137090	250	3	50	80	36,5	53
143053	315	3	60	90	42	58
133259	200	3	50	80	30,5	43
133653	250	3	60	90	36,5	53
143057	315	3	80	110	42	58

Tool group C15  
Type 0040-Y  
**Mounting bolt for top jaws**  
**bolt 1**



Item no.	Size	Thread
249299	100	M6x20
236949	125	M8x25
334571	160/200	M8x30
233025	250	M10x35
233026	315	M12x45

Tool group C15  
Type 0040-Y  
**Mounting bolt for top jaws**  
**bolt 2**



Item no.	Size	Thread
216528	100	M6x16
233058	125/160/200	M8x20
227692	250	M12x25
233030	315	M12x30

# Accessories ZG Hi-Tru

Tool group A09

Type 600 **Base plates** for lathe chucks with **cylindrical centre mount** DIN 6350



Item no.	Size
162793 <span style="color: yellow;">■</span>	160
162401 <span style="color: yellow;">■</span>	200
163036 <span style="color: yellow;">■</span>	250
133705 <span style="color: yellow;">■</span>	315

Tool group A09

Type 304 **Unfinished adapter plates** for **cylindrical mount**

The unfinished back plate must be machined and fitted on both machine and chuck side

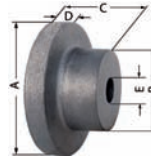

Item no.	Chuck Size	Inch	A	B	C	D	E
017113 <span style="color: green;">●</span>	80	3 ¼	92	56	47	15	20
017114 <span style="color: green;">●</span>	100	4	120	80	58	20	25
017115 <span style="color: green;">●</span>	125	5	135	80	58	20	25
017116 <span style="color: green;">●</span>	160	6 ¼	170	80	58	20	30
017117 <span style="color: green;">●</span>	200	8	210	92	66	22	40
017118 <span style="color: yellow;">■</span>	250	10	260	105	92	25	50
017119 <span style="color: yellow;">■</span>	315	12 ½	330	165	100	30	50

Tool group A09

Type 300 **Chip guard, piece**



Item no.	Contents of delivery	Size
108500 <span style="color: yellow;">■</span>	piece	80/85
108501 <span style="color: green;">●</span>	piece	100/110
108502 <span style="color: green;">●</span>	piece	125
108503 <span style="color: green;">●</span>	piece	140/160
108504 <span style="color: green;">●</span>	piece	200
108505 <span style="color: green;">●</span>	piece	250
108506 <span style="color: green;">●</span>	piece	315/350/400

Tool group C15

Type 1028 **Special grease F80** for **lathe chucks** for lubrication and conservation of chucking power



Item no.	Design	Contents
028975 <span style="color: green;">●</span>	Tin	1 kg

Tool group A09

Type 300 **Scroll**



Item no.	Size
102183 <span style="color: green;">●</span>	85
101754 <span style="color: green;">●</span>	100
101721 <span style="color: green;">●</span>	125
100303 <span style="color: green;">●</span>	160
100003 <span style="color: green;">●</span>	200
100203 <span style="color: green;">●</span>	250
101552 <span style="color: green;">●</span>	315

Tool group A09

Type 300 **Driving pinion**



Item no.	Size
102184 <span style="color: green;">●</span>	80
101755 <span style="color: green;">●</span>	100
101722 <span style="color: green;">●</span>	125
100304 <span style="color: green;">●</span>	160
100005 <span style="color: green;">●</span>	200
100204 <span style="color: green;">●</span>	250
101553 <span style="color: green;">●</span>	315

Tool group A09

Type 300 **Pinion holder screw**



Item no.	Size
102185 <span style="color: green;">●</span>	85
100305 <span style="color: green;">●</span>	160
100006 <span style="color: green;">●</span>	270
101554 <span style="color: green;">●</span>	315

Tool group A09

Type 300 **Standard key**



Item no.	Size	Square	Length
107426 <span style="color: green;">●</span>	80/85	6	62
107427 <span style="color: green;">●</span>	100/110	8	75
107428 <span style="color: green;">●</span>	125/140	9	80
107429 <span style="color: green;">●</span>	160	10	90
107430 <span style="color: green;">●</span>	200/230	11	100
107431 <span style="color: green;">●</span>	250/270	12	100
107432 <span style="color: green;">●</span>	315	14	110

Tool group A09

Type 300 **Safety key**



Item no.	Size	Square	Length
154370 <span style="color: yellow;">■</span>	80/85	6	110
154371 <span style="color: green;">●</span>	100/110	8	130
154372 <span style="color: green;">●</span>	125/140	9	130
154373 <span style="color: green;">●</span>	160	10	160
154374 <span style="color: green;">●</span>	200/230	11	160
154375 <span style="color: green;">●</span>	250/270	12	160
154376 <span style="color: green;">●</span>	315	14	200

Tool group A09

Type 300 **Elongated safety key**



Item no.	Size	Square	Length
154683 <span style="color: green;">●</span>	125/140	9	170
154685 <span style="color: green;">●</span>	160	10	180
154687 <span style="color: green;">●</span>	200/230	11	200
154689 <span style="color: green;">●</span>	250/270	12	200
154695 <span style="color: green;">●</span>	315	14	250

Tool group C15

Type 0040-Y **Mounting screws** with **cylindrical centre rim**



Item no.	Size	Thread
249299 <span style="color: green;">●</span>	74-85	M6x20
334571 <span style="color: green;">●</span>	100-140	M8x30
249301 <span style="color: green;">●</span>	160-230	M10x35
233025 <span style="color: green;">●</span>	250-270	M10x35
220565 <span style="color: green;">●</span>	315-350	M16x50



Three- and four-jaw chuck with cast iron body in the rational employment for positioning and carrying circular workpieces.

**Technical features:**

- cast iron body
- sizes 125 - 200: 4 setscrews for fine adjustment
- lathe chucks must be lubricated regularly to maintain their gripping force

**Delivery includes:**

- 1 set of outward stepped jaws (BB) mounted in the chuck
- 1 set of inward stepped jaws (DB)
- size 70 with reversible jaws
- fixing screws

Lever scroll chucks KRF

Tool group A09  
Type 399-30  
**3-jaws lever scroll chucks**  
with clamping pin, with one set of inward stepped jaws and one set of outward stepped jaws  
**cylindrical centre mount**

Item no.	Size	ZA	Through-hole	Torque Nm	Total clamping force kN
148793 <sup>1)</sup> ●	70	48	16	12	2,5
148757 ●	110	75	26	26	3,2
150757 ●	125	70	35	36	3,5
150759 ●	160	78,5	52	50	4
150761 ●	200	115	64	60	4,5

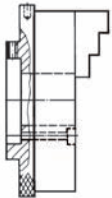

<sup>1)</sup> jaws reversible  
sizes 125 - 200: 4 setscrews for fine adjustment

Tool group A09  
Type 399-40  
**4-jaws lever scroll chuck**  
with clamping pin, with one set of inward stepped jaws and one set of outward stepped jaws  
**cylindrical centre mount**

Item no.	Size	ZA	Through-hole	Torque Nm	Total clamping force kN
148794 <sup>1)</sup> ■	70	48	16	12	2,5
148772 ■	110	75	26	26	3,2
150758 ■	125	70	35	36	3,5
150760 ■	160	78,5	52	50	4
150762 ■	200	115	64	60	4,5

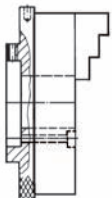

<sup>1)</sup> jaws reversible  
sizes 125 - 200: 4 setscrews for fine adjustment

**Dimensions KRF**  
cylindrical centre mount

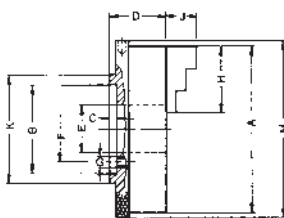

	A	B <sup>H6</sup>	C	D	F	3-jaws G	4-jaws G	H	J	K	M	Clamping range		Weight approx. kg	
												external	internal	3-jaws	4-jaws
70	48	1,5	33	39	3xM6	3xM6	32	13,6	52	72	2-70	23-70	1	1,4	
110	75	2	38	62	3xM8	3xM8	48	19	85	112	3-110	33-104	3	3,4	
125	70	8	53	56	3xØ6,6	4xØ6,6	52	22,5	83	129	3-125	37-123	4	4,5	
160	78,5	8	52	65	3xØ6,6	4xØ6,6	61	26,6	96	164	3-160	39-152	7	7,5	
200	115	13	66	84	3xØ9	4xØ9	69	31	147	205	4-200	44-186	13	14	

Size 70-100

4 setscrews for fine adjustment

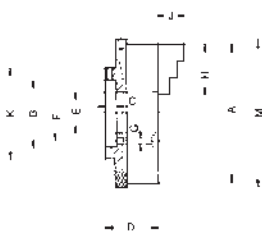

Size 125-200



## KRF

Tool group A09  
Type 399-60  
**6-jaw chuck, cast iron body,**  
with special jaws  
with fine adjustable centre mount,  
for grinding twist drills

Item no.	Size	Through-hole	Torque Nm	Total clamping force kN
127920 ●	125	35	36	3,5
127921 ■	160	52	50	4
127922 ●	200	81	60	4,5
103648 ■	250	102	70	5

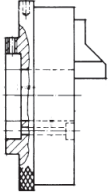

4 setscrews for fine adjustment

**Dimensions KRF**  
4 setscrews for fine adjustment

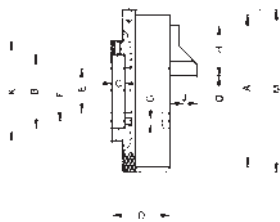

A	Lathe chucks BH6	Spindle B1	C	D	F	G	H	J	K	M
125	70	69,5	8	50	56	3xØ6,6	48	37	83	129
160	78,5	78	8	52	65	3xØ6,6	57	36	96	164
200	115	114,5	13	66	97	6xØ9	85	82	147	205
250	145	144,5	12	77	126	3xØ14	98	78	170	258

## KRF - on base plate

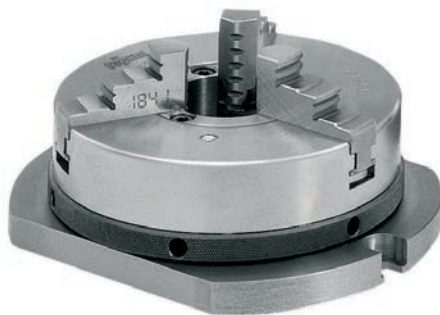

Three- and four-jaw chuck with cast iron body in the rational employment for positioning and carrying circular workpieces.

**Technical features:**

- cast iron body
- sizes 125 - 200: 4 setscrews for fine adjustment
- lathe chucks must be lubricated regularly to maintain their gripping force

**Delivery includes:**

- 1 set of outward stepped jaws (BB) mounted in the chuck
- 1 set of inward stepped jaws (DB)
- size 70 with reversible jaws
- fixing screws

Tool group A09  
Type 399-30 **Lever scroll chucks**  
with base plate  
**3-jaw-chuck cast iron body**

Item no.	Size	Through-hole	D	Torque Nm	Total clamping force kN
150595 <sup>1)</sup> ●	70	16	32,4	12	2,5
150596 ●	110	26	36	26	3,2
150597 ●	125	35	44	36	3,5
150598 ●	160	52	43	50	4
150599 ■	200	64	53	60	4,5

<sup>1)</sup> jaws reversible

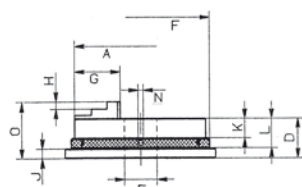
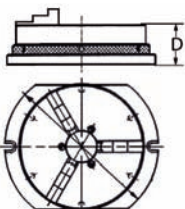

Size	A <sub>1</sub>	B	C	D	F	G	H	J	K	L	M	N	O	Clamping range	
														external	internal
70	100	70	87	46,4	72	32	5	13	21	32,4	9	6	60	2-70	23-70
110	140	110	126	50	112	48	6	13	23	36	9	8	67,5	3-110	33-104
125	170	125	154	59	129	52	8	14	32	44	11	8	81,5	3-125	37-123
160	200	160	184	59	164	61	10	15	31	43	11	8	85	3-160	39-152
200	250	200	230	69	205	69	10	15	39	53	11	8	100	4-200	44-186

## Jaws KRF

Tool group A09  
Type 300 **Inside jaw BB DIN 6350**  
outward stepped jaw, hardened

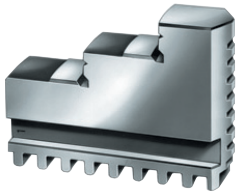

Item no.	Chuck Size	Number of jaws	Jaw length	Jaw height	Jaw width
110154 <sup>1)</sup> ●	70	3	32	23	10
110156 ●	110	3	48	33,5	14
110157 ●	125	3	52	41,5	18
110159 ●	160	3	61	47,5	18
110160 ●	200	3	69	53,5	20

<sup>1)</sup> reversible, for use as turning or inside jaws

Stepped and hardened jaws, supplied as supplement or as spares, must be ground on the chuck.  
In case of a subsequent jaw delivery please return the chuck.

Tool group A09  
Type 400 **Inside jaw BB DIN 6350**  
outward stepped jaw, hardened

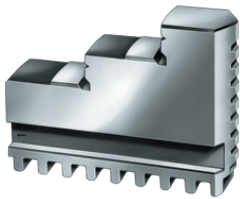

Item no.	Chuck Size	Number of jaws	Jaw length	Jaw height	Jaw width
149305 <sup>1)</sup> ■	70	4	32	23	10
110064 ■	100/110	4	48	33,5	14
110065 ●	125	4	52	41,5	18
110067 ●	160	4	61	47,5	18
110068 ●	200	4	69	53,5	20

<sup>1)</sup> jaws reversible

Stepped and hardened jaws, supplied as supplement or as spares, must be ground on the chuck.  
In case of a subsequent jaw delivery please return the chuck.

Tool group A09  
Type 300 **Outside jaw DB DIN 6350**  
inward stepped jaw, hardened

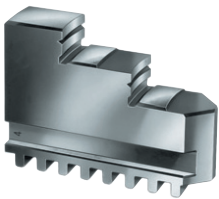

Item no.	Chuck Size	Number of jaws	Jaw length	Jaw height	Jaw width
110166 ●	110	3	48	33,5	14
110167 ●	125	3	52	41,5	18
110169 ●	160	3	61	47,5	18
110170 ●	200	3	69	53,5	20

Stepped and hardened jaws, supplied as supplement or as spares, must be ground on the chuck.  
In case of a subsequent jaw delivery please return the chuck.

Tool group A09  
Type 400 **Outside jaw DB DIN 6350**  
inward stepped jaw, hardened

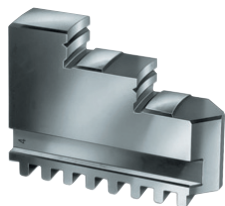

Item no.	Chuck Size	Number of jaws	Jaw length	Jaw height	Jaw width
110074 ■	100/110	4	48	33,5	14
110075 ●	125	4	52	41,5	18
110077 ●	160	4	61	47,5	18
110078 ●	200	4	69	53,5	20

Stepped and hardened jaws, supplied as supplement or as spares, must be ground on the chuck.  
In case of a subsequent jaw delivery please return the chuck.

Tool group A09  
Type 301 **Unstepped jaw BL DIN 6350**  
unstepped, soft, 16MnCr5



Item no.	Chuck Size	Number of jaws	Jaw length	Jaw height	Jaw width
109114 <sup>1)</sup> ●	70	3	32	23	10
107589 ●	110	3	48	33,5	14
107590 ●	125	3	52	41,5	18
107592 ●	160	3	61	47,5	18
107593 ●	200	3	69	53,5	20

<sup>1)</sup> jaws reversible

Tool group A09  
Type 401 **Unstepped jaw BL DIN 6350**, unstepped, soft, 16MnCr5



Item no.	Chuck Size	Number of jaws	Jaw length	Jaw height	Jaw width
149304 <sup>1)</sup> ■	70	4	32	23	10
107599 ●	100/110	4	48	33,5	14
107600 ●	125	4	52	41,5	18
107602 ●	160	4	61	47,5	18
107603 ●	200	4	69	53,5	20

<sup>1)</sup> jaws reversible

# Accessories KRF

Tool group A09

Type 600 **Base plates** for lathe chucks with **cylindrical centre mount** DIN 6350



Item no.	Size
162793 <span style="color: yellow;">■</span>	160
162401 <span style="color: yellow;">■</span>	200

Tool group A09

Type 304 **Unfinished adapter plates** for **cylindrical mount**

The unfinished back plate must be machined and fitted on both machine and chuck side

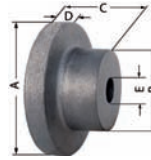

Item no.	Chuck Size	Inch	A	B	C	D	E
017123 <span style="color: yellow;">■</span>	74	3	80	56	45	15	-
017114 <span style="color: green;">●</span>	100	4	120	80	58	20	25
017115 <span style="color: green;">●</span>	125	5	135	80	58	20	25
017116 <span style="color: green;">●</span>	160	6 ¼	170	80	58	20	30
017117 <span style="color: green;">●</span>	200	8	210	92	66	22	40

Tool group A09

Type 300 **Chip guard, piece**



Item no.	Contents of delivery	Size
108501 <span style="color: green;">●</span>	piece	100/110
108502 <span style="color: green;">●</span>	piece	125
108503 <span style="color: green;">●</span>	piece	140/160
108504 <span style="color: green;">●</span>	piece	200

Tool group C15

Type 1028 **Special grease F80** for **lathe chucks** for lubrication and conservation of chucking power



Item no.	Design	Contents
028975 <span style="color: green;">●</span>	Tin	1 kg

This chuck will be used for the adjustment of irregular shaped workpieces

**Mechanism**

The radial positioned Pinion (4, hardened) transmits the power via a bevel gearing to the Spiral Ring (3), where its spiral transmits it to the Base Jaws (13, hardened and grinded), the Adjusting Screw Spindle (16, hardened) and the reversible Top Jaws (14, hardened and grinded). Steel or cast iron body (1), Cover (2).

**Clamping force transmitting system**

The jaws can be moved across the entire clamping range by turning a key.

**Lubrication**

Lathe chucks must be lubricated regularly to maintain their gripping force. Appropriate directions are included in the operating instructions supplied with each chuck. All lathe chucks are equipped with grease nipples for convenient maintenance.

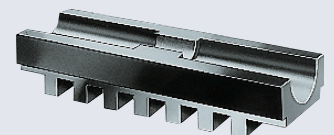
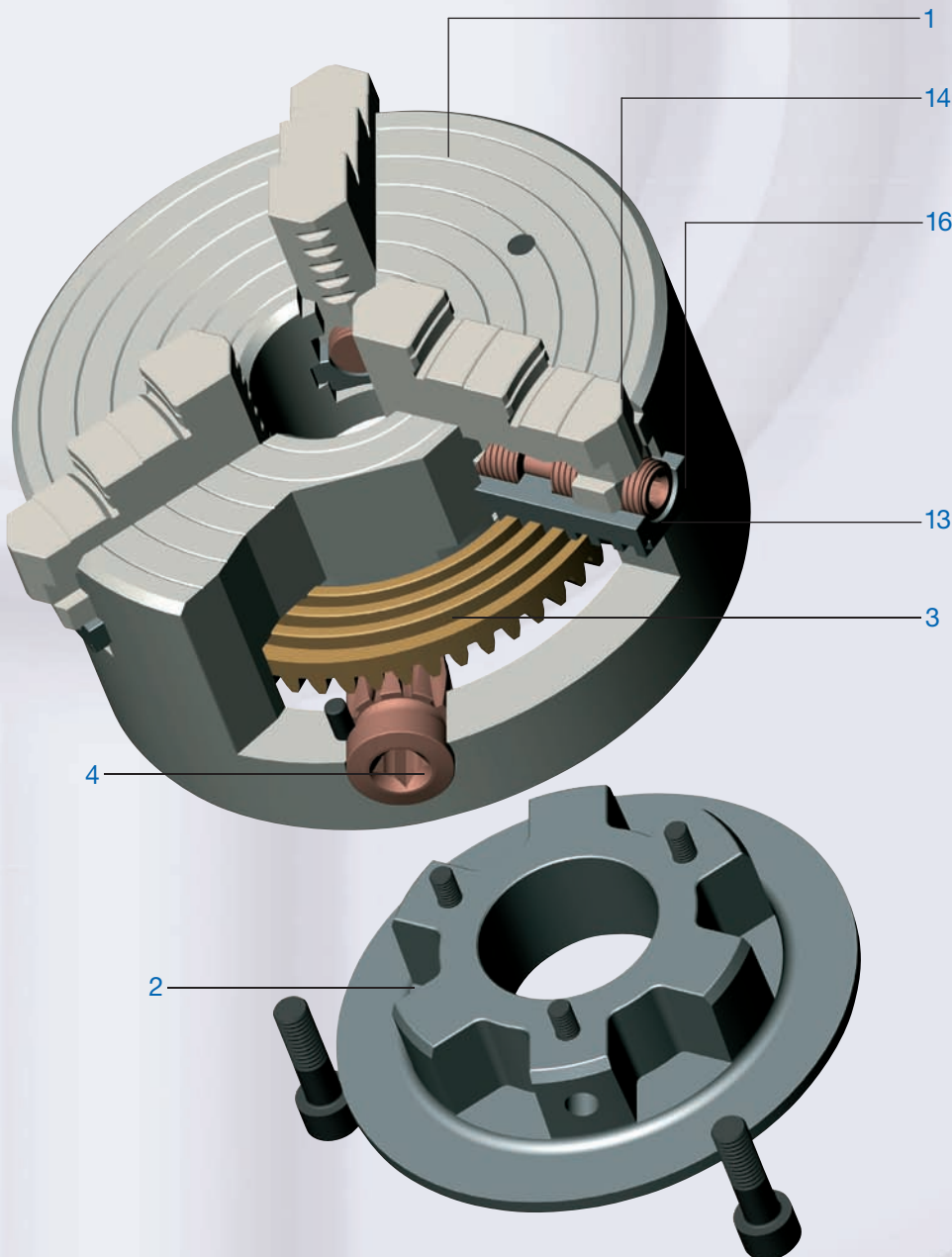

Base jaw GB, hardened and ground

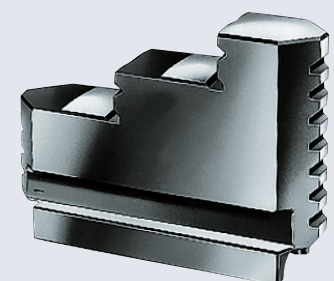

Reversible top jaw UB, hardened and ground

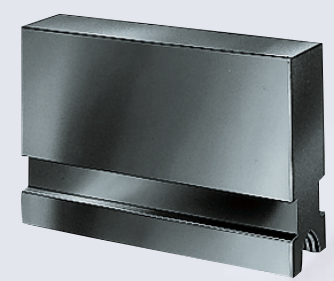

Unstepped jaw BL unstepped, soft, material 16MnCr5

Geared scroll chucks EG-ES

## EG-ES



Three- and four-jaw chucks, cast iron or steel body, particularly suitable for lining up and chucking workpieces of irregular shape.

The jaws can be moved across the entire clamping range by turning a key.

**Technical features:**

- similar to DIN 6350, but with additional adjustment of the reversible jaws
- dimensions and mountings to DIN 6351
- chuck body: drop-forged steel or special cast iron
- scroll: drop-forged and balanced, hardened, thread flanks ground on both sides
- with self-centering and independently adjustable jaws
- lathe chucks must be lubricated regularly to maintain their gripping force

**Delivery includes:**

- 1 set of base jaws (GB),
- 1 set of reversible jaws (UB),
- 1 operating key,
- 1 adjusting key, mounting bolts

Tool group A09  
Type 350 **3-jaw-chuck**  
**cast iron body**  
DIN 6351; cylindrical centre mount,  
form A

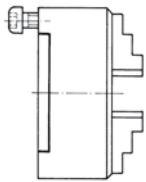

Item no.	Size	ZA	Through-hole	Speed max. min-1	Torque Nm	Total clamping force kN
103144 ■	100	70	20	2700	60	27
104423 ■	125	95	32	2400	80	31
104229 ■	160	125	42	2000	110	47
104279 ■	200	160	55	1600	140	55
104531 ■	250	200	76	1300	150	63
104643 ■	315	260	103	900	180	69
104748 ▲	400	330	136	800	240	92
105143 ▲	500	420	190	630	260	100
104100 ▲	630	545	240	510	280	105

Tool group A09  
Type 650 **3-jaw-chuck**  
**steel body**  
DIN 6351; cylindrical centre mount,  
form A

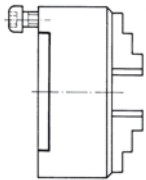

Item no.	Size	ZA	Through-hole	Speed max. min-1	Torque Nm	Total clamping force kN
111360 ■	160	125	42	3000	110	47
111365 ■	200	160	55	2450	140	55
111370 ■	250	200	76	2000	150	63
111375 ■	315	260	103	1350	180	69
111380 ■	400	330	136	1250	240	92
111385 ▲	500	420	190	800	260	100
111390 ▲	630	545	240	700	280	105

Tool group A09  
Type 450 **4-jaw-chuck**  
**cast iron body**  
DIN 6351; cylindrical centre mount,  
form A

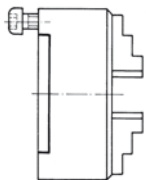

Item no.	Size	ZA	Through-hole	Speed max. min-1	Torque Nm	Total clamping force kN
103166 ■	100	70	20	2700	60	27
104202 ●	125	95	32	2400	80	31
103362 ●	160	125	42	2000	110	47
104327 ●	200	160	55	1600	140	55
104579 ●	250	200	76	1300	150	63
104687 ■	315	260	103	900	180	69
104790 ■	400	330	136	800	240	92
105173 ▲	500	420	190	630	260	100
105657 ▲	630	545	240	510	280	105

## EG-ES

Tool group A09  
Type 850 **4-jaw-chuck steel body**  
**DIN 6351**; cylindrical centre mount,  
form A

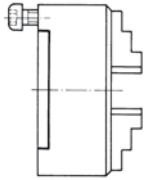

Item no.	Size	ZA	Through-hole	Speed max. min-1	Torque Nm	Total clamping force kN
111789 <span style="color: yellow;">■</span>	160	125	42	3000	110	47
111793 <span style="color: yellow;">■</span>	200	160	55	2450	140	55
111797 <span style="color: yellow;">■</span>	250	200	76	2000	150	63
111801 <span style="color: yellow;">■</span>	315	260	103	1350	180	69
111805 <span style="color: yellow;">■</span>	400	330	136	1250	240	92
111809 <span style="color: red;">▲</span>	500	420	190	800	260	100
111813 <span style="color: red;">▲</span>	630	545	240	700	280	105

Tool group A09  
Type 365 **3-jaw-chuck cast iron body**  
**ISO 702-3** (DIN 55027), DIN 55022;  
with studs and locknuts, optional  
DIN 55021 with set screw and nut

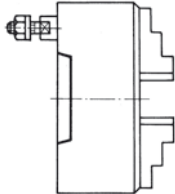

Item no.	Size	Mount short taper	Through-hole	Speed max. min-1	Torque Nm	Total clamping force kN
103371 <span style="color: red;">▲</span>	125	3	32	2400	80	31
103373 <span style="color: red;">▲</span>	125	4	32	2400	80	31
104207 <span style="color: red;">▲</span>	160	4	42	2000	110	47
104209 <span style="color: red;">▲</span>	160	5	42	2000	110	47
104211 <span style="color: red;">▲</span>	160	6	42	2000	110	47
104315 <span style="color: red;">▲</span>	200	4	55	1600	140	55
104285 <span style="color: red;">▲</span>	200	5	55	1600	140	55
104287 <span style="color: red;">▲</span>	200	6	55	1600	140	55
104545 <span style="color: red;">▲</span>	250	5	76	1300	150	63
104541 <span style="color: red;">▲</span>	250	6	76	1300	150	63
104543 <span style="color: red;">▲</span>	250	8	76	1300	150	63
104653 <span style="color: red;">▲</span>	315	6	103	900	180	69
104655 <span style="color: red;">▲</span>	315	8	103	900	180	69
104657 <span style="color: red;">▲</span>	315	11	103	900	180	69
104758 <span style="color: red;">▲</span>	400	8	136	800	240	92
104760 <span style="color: red;">▲</span>	400	11	136	800	240	92
105151 <span style="color: red;">▲</span>	500	11	190	630	260	100
105153 <span style="color: red;">▲</span>	500	15	190	630	260	100
104108 <span style="color: red;">▲</span>	630	11	192,7	510	280	105
104109 <span style="color: red;">▲</span>	630	15	240	510	280	105

Tool group A09  
Type 665 **3-jaw-chuck steel body**  
**ISO 702-3** (DIN 55027), DIN 55022;  
with studs and locknuts, optional  
DIN 55021 with set screw and nut

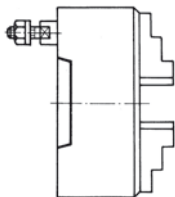

Item no.	Size	Mount short taper	Through-hole	Speed max. min-1	Torque Nm	Total clamping force kN
111468 <span style="color: red;">▲</span>	160	4	42	3000	110	47
111469 <span style="color: red;">▲</span>	160	5	42	3000	110	47
111471 <span style="color: red;">▲</span>	160	6	42	3000	110	47
111475 <span style="color: red;">▲</span>	200	4	55	2450	140	55
111472 <span style="color: red;">▲</span>	200	5	55	2450	140	55
111473 <span style="color: red;">▲</span>	200	6	55	2450	140	55
111478 <span style="color: red;">▲</span>	250	5	76	2000	150	63
111476 <span style="color: red;">▲</span>	250	6	76	2000	150	63
111477 <span style="color: red;">▲</span>	250	8	76	2000	150	63
111479 <span style="color: red;">▲</span>	315	6	103	1350	180	69
111480 <span style="color: red;">▲</span>	315	8	103	1350	180	69
111481 <span style="color: red;">▲</span>	315	11	103	1350	180	69
111482 <span style="color: red;">▲</span>	400	8	136	1250	240	92
111483 <span style="color: red;">▲</span>	400	11	136	1250	240	92
111485 <span style="color: red;">▲</span>	500	11	190	800	260	100
111486 <span style="color: red;">▲</span>	500	15	190	800	260	100
111488 <span style="color: red;">▲</span>	630	11	192,7	700	280	105
111489 <span style="color: red;">▲</span>	630	15	240	700	280	105

**EG-ES**

Tool group A09  
Type 465 **4-jaw-chuck**  
**cast iron body**  
**ISO 702-3** (DIN 55027), DIN 55022;  
with studs and locknuts, optional  
DIN 55021 with set screw and nut

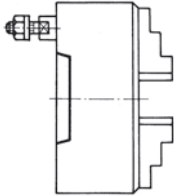

Item no.	Size	Mount short taper	Through-hole	Speed max. min-1	Torque Nm	Total clamping force kN
104218 ▲	125	3	32	2400	80	31
104220 ▲	125	4	32	2400	80	31
103378 ▲	160	4	42	2000	110	47
103382 ■	160	5	42	2000	110	47
103386 ▲	160	6	42	2000	110	47
104345 ▲	200	4	55	1600	140	55
104339 ■	200	5	55	1600	140	55
104341 ■	200	6	55	1600	140	55
104593 ▲	250	5	76	1300	150	63
104589 ■	250	6	76	1300	150	63
104591 ■	250	8	76	1300	150	63
104697 ▲	315	6	103	900	180	69
104699 ■	315	8	103	900	180	69
104701 ▲	315	11	103	900	180	69
105100 ▲	400	8	136	800	240	92
105102 ▲	400	11	136	800	240	92
105181 ▲	500	11	190	630	260	100
105183 ▲	500	15	190	630	260	100
106001 ▲	630	11	192,7	510	280	105
106003 ▲	630	15	240	510	280	105

Tool group A09  
Type 865 **4-jaw-chuck steel body**  
**ISO 702-3** (DIN 55027), DIN 55022;  
with studs and locknuts, optional  
DIN 55021 with set screw and nut

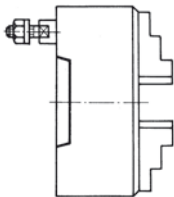

Item no.	Size	Mount short taper	Through-hole	Speed max. min-1	Torque Nm	Total clamping force kN
111891 ▲	160	4	42	3000	110	47
111892 ■	160	5	42	3000	110	47
111894 ▲	160	6	42	3000	110	47
111898 ▲	200	4	55	2450	140	55
111895 ■	200	5	55	2450	140	55
111896 ■	200	6	55	2450	140	55
111901 ▲	250	5	76	2000	150	63
111899 ■	250	6	76	2000	150	63
111900 ▲	250	8	76	2000	150	63
111902 ▲	315	6	103	1350	180	69
111903 ■	315	8	103	1350	180	69
111904 ▲	315	11	103	1350	180	69
111905 ▲	400	8	136	1250	240	92
111906 ▲	400	11	136	1250	240	92
111908 ▲	500	11	190	800	260	100
111909 ▲	500	15	190	800	260	100
111911 ▲	630	11	192,7	700	280	105
111912 ▲	630	15	240	700	280	105

Tool group A09  
Type 370 **3-jaw-chuck**  
**cast iron body**  
**ISO 702-1** (DIN 55026); DIN 55021,  
ASA B 5.9, A1/A2 metr.; mounting  
from front

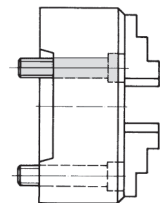

Item no.	Size	Mount short taper	Through-hole	Speed max. min-1	Torque Nm	Total clamping force kN
104213 <sup>1)</sup> ▲	160	5	42	2000	110	47
104290 <sup>1)</sup> ▲	200	5	42	1600	140	55
104292 <sup>1)</sup> ■	200	6	55	1600	140	55
104547 <sup>1)</sup> ▲	250	6	55	1300	150	63
104549 <sup>1)</sup> ▲	250	8	76	1300	150	63
104659 ■	315	6	103	900	180	69
104661 <sup>1)</sup> ▲	315	8	76	900	180	69
104764 ▲	400	8	136	800	240	92
104766 <sup>1)</sup> ▲	400	11	125	800	240	92
105155 ▲	500	11	190	630	260	100
104112 ▲	630	11	190	510	280	105
104113 <sup>1)</sup> ▲	630	15	190	510	280	105

<sup>1)</sup> mounting from front in the inner bolt circle

## EG-ES

Tool group A09  
Type 670 **3-jaw-chuck steel body**  
**ISO 702-1** (DIN 55026); DIN 55021,  
ASA B 5.9, A1/A2 metr.; mounting  
from front

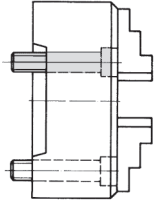

Item no.	Size	Mount short taper	Through-hole	Speed max. min-1	Torque Nm	Total clamping force kN
111515 <sup>1)</sup> ▲	160	5	42	3000	110	47
111517 <sup>1)</sup> ▲	200	5	42	2450	140	55
111519 <sup>1)</sup> ▲	200	6	55	2450	140	55
111521 <sup>1)</sup> ▲	250	6	55	2000	150	63
111523 <sup>1)</sup> ▲	250	8	76	2000	150	63
111527 ▲	315	6	103	1350	180	69
111529 <sup>1)</sup> ▲	315	8	76	1350	180	69
111531 ▲	400	8	136	1250	240	92
111533 <sup>1)</sup> ▲	400	11	125	1250	240	92
111535 ▲	500	11	190	800	260	100
111540 ▲	630	11	190	700	280	105
111542 <sup>1)</sup> ▲	630	15	190	700	280	105

<sup>1)</sup> mounting from front in the inner bolt circle

Tool group A09  
Type 470 **4-jaw-chuck**  
**cast iron body**  
**ISO 702-1** (DIN 55026); DIN 55021,  
ASA B 5.9, A1/A2 metr.; mounting  
from front

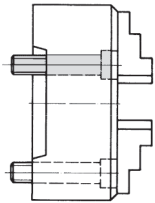

Item no.	Size	Mount short taper	Through-hole	Speed max. min-1	Torque Nm	Total clamping force kN
103390 <sup>1)</sup> ▲	160	5	42	2000	110	47
104347 <sup>1)</sup> ▲	200	5	42	1600	140	55
104349 <sup>1)</sup> ▲	200	6	55	1600	140	55
104595 <sup>1)</sup> ▲	250	6	55	1300	150	63
104597 <sup>1)</sup> ▲	250	8	76	1300	150	63
104703 ▲	315	6	103	900	180	69
104705 <sup>1)</sup> ▲	315	8	76	900	180	69
105106 ▲	400	8	136	800	240	92
105108 <sup>1)</sup> ▲	400	11	125	800	240	92
105185 ▲	500	11	190	630	260	100
106005 ▲	630	11	190	510	280	105

<sup>1)</sup> mounting from front in the inner bolt circle

Tool group A09  
Type 870 **4-jaw-chuck steel body**  
**ISO 702-1** (DIN 55026); DIN 55021,  
ASA B 5.9, A1/A2 metr.; mounting  
from front

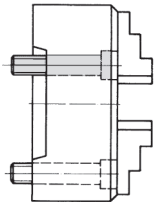

Item no.	Size	Mount short taper	Through-hole	Speed max. min-1	Torque Nm	Total clamping force kN
111938 <sup>1)</sup> ▲	160	5	42	3000	110	47
111940 <sup>1)</sup> ▲	200	5	42	2450	140	55
111942 <sup>1)</sup> ▲	200	6	55	2450	140	55
111944 <sup>1)</sup> ▲	250	6	55	2000	150	63
111946 <sup>1)</sup> ▲	250	8	76	2000	150	63
111950 ▲	315	6	103	1350	180	69
111952 <sup>1)</sup> ▲	315	8	76	1350	180	69
111954 ▲	400	8	136	1250	240	92
111956 <sup>1)</sup> ▲	400	11	125	1250	240	92
111958 ▲	500	11	190	800	260	100
111963 ▲	630	11	190	700	280	105
111965 <sup>1)</sup> ▲	630	15	190	700	280	105

<sup>1)</sup> mounting from front in the inner bolt circle

Tool group A09  
Type 380 **3-jaw-chuck**  
**cast iron body**  
**ISO 702-2** (DIN 55029); ASA B 5.9,  
Type D, with studs for Camlock

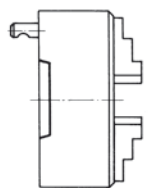

Item no.	Size	Mount short taper	Through-hole	Speed max. min-1	Torque Nm	Total clamping force kN
109401 ▲	125	3	32	2400	80	31
109404 ▲	125	4	32	2400	80	31
109405 ▲	160	4	42	2000	110	47
109407 ▲	160	5	42	2000	110	47
109410 ▲	160	6	42	2000	110	47
109406 ▲	200	4	55	1600	140	55
109408 ▲	200	5	55	1600	140	55
109411 ▲	200	6	55	1600	140	55
109409 ▲	250	5	76	1300	150	63
109412 ▲	250	6	76	1300	150	63
109415 ▲	250	8	76	1300	150	63
109413 ▲	315	6	103	900	180	69
109416 ▲	315	8	103	900	180	69
109419 ▲	315	11	103	900	180	69
109417 ▲	400	8	136	800	240	92
109420 ▲	400	11	136	800	240	92
109421 ▲	500	11	190	630	260	100
109423 ▲	500	15	190	630	260	100
109422 ▲	630	11	192,7	510	280	105
109424 ▲	630	15	240	510	280	105



## EG-ES

Tool group A09  
Type 680 **3-jaw-chuck steel body**  
**ISO 702-2** (DIN 55029); ASA B 5.9,  
Type D, with studs for Camlock

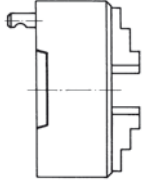

Item no.	Size	Mount short taper	Through-hole	Speed max. min-1	Torque Nm	Total clamping force kN
111604 ▲	160	4	42	3000	110	47
111606 ▲	160	5	42	3000	110	47
111610 ▲	160	6	42	3000	110	47
111618 ▲	200	4	55	2450	140	55
111612 ▲	200	5	55	2450	140	55
111614 ▲	200	6	55	2450	140	55
111624 ▲	250	5	76	2000	150	63
111620 ▲	250	6	76	2000	150	63
111622 ▲	250	8	76	2000	150	63
111626 ▲	315	6	103	1350	180	69
111628 ▲	315	8	103	1350	180	69
111630 ▲	315	11	103	1350	180	69
111632 ▲	400	8	136	1250	240	92
111634 ▲	400	11	136	1250	240	92
111638 ▲	500	11	190	800	260	100
111640 ▲	500	15	190	800	260	100
111644 ▲	630	11	192,7	700	280	105
111646 ▲	630	15	240	700	280	105

Tool group A09  
Type 480 **4-jaw-chuck cast iron body**  
**ISO 702-2** (DIN 55029); ASA B 5.9,  
Type D, with studs for Camlock

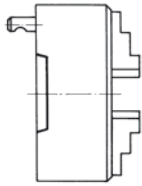

Item no.	Size	Mount short taper	Through-hole	Speed max. min-1	Torque Nm	Total clamping force kN
109427 ▲	125	3	32	2400	80	31
109430 ▲	125	4	32	2400	80	31
109431 ▲	160	4	42	2000	110	47
109433 ▲	160	5	42	2000	110	47
109436 ▲	160	6	42	2000	110	47
109432 ▲	200	4	55	1600	140	55
109434 ▲	200	5	55	1600	140	55
109437 ▲	200	6	55	1600	140	55
109435 ▲	250	5	76	1300	150	63
109438 ▲	250	6	76	1300	150	63
109441 ▲	250	8	76	1300	150	63
109439 ▲	315	6	103	900	180	69
109442 ▲	315	8	103	900	180	69
109445 ▲	315	11	103	900	180	69
109443 ▲	400	8	136	800	240	92
109446 ▲	400	11	136	800	240	92
109447 ▲	500	11	190	630	260	100
109449 ▲	500	15	190	630	260	100
109448 ▲	630	11	192,7	510	280	105
109450 ▲	630	15	240	510	280	105

Tool group A09  
Type 880 **4-jaw-chuck steel body**  
**ISO 702-2** (DIN 55029); ASA B 5.9,  
Type D, with studs for Camlock

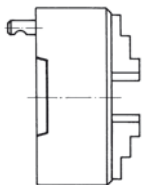

Item no.	Size	Mount short taper	Through-hole	Speed max. min-1	Torque Nm	Total clamping force kN
112024 ▲	160	4	42	3000	110	47
112026 ▲	160	5	42	3000	110	47
112030 ▲	160	6	42	3000	110	47
112038 ▲	200	4	55	2450	140	55
112032 ▲	200	5	55	2450	140	55
112034 ▲	200	6	55	2450	140	55
112044 ▲	250	5	76	2000	150	63
112040 ▲	250	6	76	2000	150	63
112042 ▲	250	8	76	2000	150	63
112046 ▲	315	6	103	1350	180	69
112048 ▲	315	8	103	1350	180	69
112050 ▲	315	11	103	1350	180	69
112052 ▲	400	8	136	1250	240	92
112054 ▲	400	11	136	1250	240	92
112058 ▲	500	11	190	800	260	100
112060 ▲	500	15	190	800	260	100
112064 ▲	630	11	192,7	700	280	105
112066 ▲	630	15	240	700	280	105

# Jaws EG-ES

Tool group A09  
Type 350 **Reversible top jaws UB**  
hardened

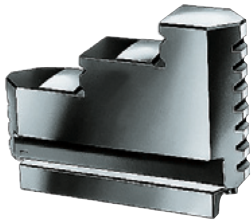

Item no.	Chuck Size	Number of jaws	Jaw length	Jaw height	Jaw width
110117 ■	100/125	3	56	41,5	18
110118 ■	160	3	69	50	20
139666 ■	200	3	85	57,5	24
139667 ■	250	3	90	67,5	24
139668 ■	315/400	3	130	79,5	34
139669 ▲	500/630	3	190	95	42

Tool group A09  
Type 450 **Reversible top jaws UB**  
hardened

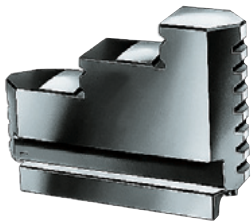

Item no.	Chuck Size	Number of jaws	Jaw length	Jaw height	Jaw width
110123 ■	100/125	4	56	41,5	18
110124 ■	160	4	69	50	20
139670 ■	200	4	85	57,5	24
139671 ■	250	4	90	67,5	24
139672 ■	315/400	4	130	79,5	34
139673 ▲	500/630	4	190	95	42

Tool group A09  
Type 351 **Unstepped jaw BL**  
unstepped, soft



Item no.	Chuck Size	Number of jaws	Jaw length	Jaw height	Jaw width
107668 ■	100/125	3	56	41,5	18
107669 ■	160	3	69	50	20
139674 ■	200	3	85	57,5	24
139675 ■	250	3	90	67,5	24
139676 ■	315/400	3	130	79,5	34
139677 ■	500/630	3	190	95	42

Tool group A09  
Type 451 **Unstepped jaw BL**  
unstepped, soft

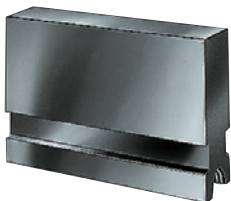

Item no.	Chuck Size	Number of jaws	Jaw length	Jaw height	Jaw width
107674 ■	100/125	4	56	41,5	18
107675 ■	160	4	69	50	20
139678 ■	200	4	85	57,5	24
139679 ■	250	4	90	67,5	24
139680 ■	315/400	4	130	79,5	34
139681 ■	500/630	4	190	95	42

Tool group A09  
Type 350 **Base jaw GB**

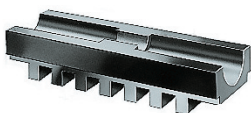

Item no.	Chuck Size	Number of jaws
107652 ■	100	3
107653 ■	125	3
107654 ■	160	3
139682 ●	200	3
139683 ■	250	3
139684 ■	315	3
139685 ■	400	3
107659 ■	500/630	3

Tool group A09  
Type 450 **Base jaw GB**

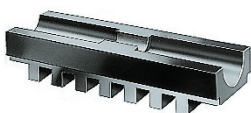

Item no.	Chuck Size	Number of jaws
107660 ■	100	4
107661 ■	125	4
107662 ■	160	4
139686 ●	200	4
139687 ■	250	4
139688 ■	315	4
139689 ■	400	4
107667 ■	500/630	4

# Accessories EG-ES

Tool group A09

Type 600 **Base plates** for lathe chucks with **cylindrical centre mount** DIN 6350



Item no.	Size
162793 <span style="color: yellow;">■</span>	160
162401 <span style="color: yellow;">■</span>	200
163036 <span style="color: yellow;">■</span>	250
133705 <span style="color: yellow;">■</span>	315

Tool group A09

Type 304 **Unfinished adapter plates** for **cylindrical mount**

The unfinished back plate must be machined and fitted on both machine and chuck side

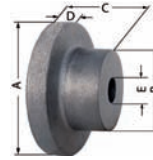

Item no.	Chuck Size	Inch	A	B	C	D	E
017114 <span style="color: green;">●</span>	100	4	120	80	58	20	25
017115 <span style="color: green;">●</span>	125	5	135	80	58	20	25
017116 <span style="color: green;">●</span>	160	6 ¼	170	80	58	20	30
017117 <span style="color: green;">●</span>	200	8	210	92	66	22	40
017118 <span style="color: yellow;">■</span>	250	10	260	105	92	25	50
017119 <span style="color: yellow;">■</span>	315	12 ½	330	165	100	30	50
017120 <span style="color: yellow;">■</span>	400	15 ¾	420	230	130	55	70

Tool group C15

Type 1028 **Special grease F80** for **lathe chucks** for lubrication and conservation of chucking power



Item no.	Design	Contents
028975 <span style="color: green;">●</span>	Tin	1 kg

Tool group A09

Type 350 **Adjusting spindle**



Item no.	For chuck size
103199 <span style="color: green;">●</span>	100
104251 <span style="color: green;">●</span>	125
104271 <span style="color: green;">●</span>	160
137735 <span style="color: green;">●</span>	200
137643 <span style="color: green;">●</span>	250
137701 <span style="color: green;">●</span>	400
137716 <span style="color: green;">●</span>	500

Tool group A09

Type 350 **Adjusting key**



Item no.	For chuck size	Square	Hexagon
107444 <span style="color: green;">●</span>	160	5,5	-
139695 <span style="color: green;">●</span>	400	-	8
139696 <span style="color: green;">●</span>	500	-	12

Tool group A09

Type 300 **Scroll**



Item no.	Size
101754 <span style="color: green;">●</span>	100
101721 <span style="color: green;">●</span>	125
100303 <span style="color: green;">●</span>	160
100003 <span style="color: green;">●</span>	200
100203 <span style="color: green;">●</span>	250
101552 <span style="color: green;">●</span>	315
102497 <span style="color: green;">●</span>	400
162973 <span style="color: yellow;">■</span>	500
162964 <span style="color: yellow;">■</span>	630

Tool group A09

Type 300 **Driving pinion**



Item no.	Size
101755 <span style="color: green;">●</span>	100
101722 <span style="color: green;">●</span>	125
100304 <span style="color: green;">●</span>	160
100005 <span style="color: green;">●</span>	200
100204 <span style="color: green;">●</span>	250
101553 <span style="color: green;">●</span>	315
102498 <span style="color: green;">●</span>	400
162974 <span style="color: yellow;">■</span>	500
162965 <span style="color: yellow;">■</span>	630

Tool group A09

Type 300 **Pinion holder screw**



Item no.	Size
100305 <span style="color: green;">●</span>	160
100006 <span style="color: green;">●</span>	270
101554 <span style="color: green;">●</span>	315
102499 <span style="color: green;">●</span>	400
103300 <span style="color: green;">●</span>	630

# Accessories EG-ES

**Tool group A09**
**Type 300 Standard key**

Item no.	Size	Square	Length
107427 ●	100/110	8	75
107428 ●	125/140	9	80
107429 ●	160	10	90
107430 ●	200/230	11	100
107431 ●	250/270	12	100
107432 ●	315	14	110
107434 ●	400	17	140
107435 ●	500/630	19	150

**Tool group A09**
**Type 300 Safety key**

Item no.	Size	Square	Length
154371 ●	100/110	8	130
154372 ●	125/140	9	130
154373 ●	160	10	160
154374 ●	200/230	11	160
154375 ●	250/270	12	160
154376 ●	315	14	200
154378 ●	400	17	250
154379 ●	500/630	19	250

**Tool group A09**
**Type 300 Elongated safety key**

Item no.	Size	Square	Length
154683 ●	125/140	9	170
154685 ●	160	10	180
154687 ●	200/230	11	200
154689 ●	250/270	12	200
154695 ●	315	14	250

**Tool group C15**
**Type 0040-Y Mounting screws for lathe chucks with direct short-taper, for front mounting**

Item no.	Size	Thread	Chuck Size	Taper size
233059 ●	74	M10x70	160	5
308436 ●	80	M10x85	200	5
200186 ●	85	M12x85	200	6
234615 ●	100	M10x110	250	5
302215 ●	110	M12x90	250	6
202439 ●	125	M16x90	250	8
316244 ●	140	M12x120	315	6
308439 ●	160	M16x105	315	8
342701 ●	315	M16x130	400	8
698878 ●	350	M20x115	400	11
011528 ●	400	M20x155	500	11
358815 ●	500	M20x170	630	11
202509 ●	630	M24x150	630	15

**Tool group A09**
**Type 310 Set screw with nut DIN 55021**

Item no.	Thread	For taper	Quantity
107453 ●	M10x30	4	3
107455 ●	M10x35	5	4
107456 ●	M12x40	6	4
107457 ●	M16x45	8	4
107458 ●	M20x55	11	6
127618 ●	M24x65	15	6

**Tool group A09**
**Type 315 Stud and locknut ISO 702-3 (DIN 55027)**



Item no.	Thread	For taper	Quantity
107447 ●	M10x34	3	3
107448 ●	M10x39	4	3
107449 ●	M10x43	5	4
107450 ●	M12x50	6	4
107451 ●	M16x60	8	4
107452 ●	M20x75	11	6
125650 ●	M24x90	15	6

**Tool group A09**
**Type 330 Stud for Camlock ISO 702-2 (DIN 55029) and cylindrical studs**

Item no.	Thread	For taper	Quantity
107465 ●	7/16-20x35	3	3
107466 ●	7/16-20x37	4	3
107467 ●	1/2-20x43	5	6
107468 ●	5/8-18x49	6	6
107469 ●	3/4-16x55,5	8	6
107470 ●	7/8-14x67	11	6
127621 ▲	1-14x76	15	6

# Chuck dimensions EG-ES

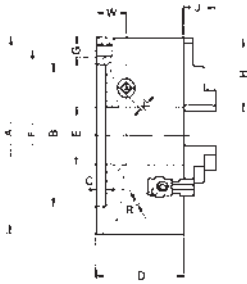
**Cylindrical centre mount DIN 6351**



The bore could be enlarged (measure E, at surcharge)

■ Enlarged bore max.

Size A	100	125	160	200	250	315	400	500	630
BH6	70	95	125	160	200	260	330	420	545
C	3	4	4	4	5	5	5	5	7
D	67	71	80	95,5	100	117	123	145	160
E	20	32	42	55	76	103	136	190	240
E <sub>max.</sub>	21	33	50	70	92	114	150	210	253
F	83	108	140	176	224	286	362	458	586
G	3xM8	3xM8	3xM10	3xM10	3xM12	3xM16	3xM16	6xM16	6xM16
H	56	56	69	85	90	130	130	190	190
J	22	21	28	32,5	40,6	46,5	47	55	55
K	8	9	10	11	12	14	17	19	19
R*	5,5	5,5	5,5	8	8	8	8	12	12
W	20	20	22,45	25,7	26,5	30	35	38	48
approx. kg	4	6	10	18	29	54	88	145	240

\* from Ø 200 hexagon

**Short taper mount**

DIN 55021 with setscrews and nuts



DIN 55027 with studs and locknuts

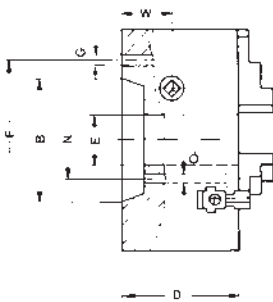

DIN 55029 with studs for camlock

Size A	125		160		200		250				
Short-taper size	3	4	4	5	6	4	5	6	5	6	8
B	53,9	63,5	63,5	82,5	106,4	63,5	82,5	106,4	82,5	106,4	139,7
D	84	84	81	81	81	96,5	96,5	96,5	101	101	101
E	32	32	42	42	42	55	55	55	76	76	76
F	DIN 75	85	85	104,8	133,4	85	104,8	133,4	104,8	133,4	171,4
	Caml. 70,6	82,5	82,5			82,5					
W	21	21	23,45	23,45	23,45	26,7	26,7	26,7	27,5	27,5	27,5
Mouting holes	DIN 3	3	3	4	4	3	4	4	4	4	4
	Caml. 3	3	3	6	6	3	6	6	6	6	6
ca. kg	6		10		19		30				

Size A	315			400		500		630	
Short-taper size	6	8	11	8	11	11	15	11	15
B	106,4	139,7	196,9	139,7	196,9	196,9	285,8	196,9	285,8
D	118	118	118	124	124	147	147	162	162
E	103	103	103	136	136	190	190	240	240
F	133,4	171,4	235	171,4	235	235	330,2	235	330,2
P	-	-	-	-	-	-	-	192,7	-
Q	-	-	-	-	-	-	-	88	-
W	31	31	31	36	36	40	40	50	50
Mouting holes	DIN 4	4	6	4	6	6	6	6	6
	Caml. 6	6	6	6	6	6	6	6	6
approx. kg	56			92		155		250	

All other dimensions should be taken from the table on the top

**DIN 55026**

Mounting from front

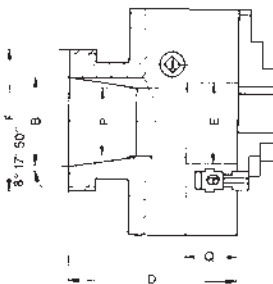

Size A	160	200	250	315	400	500	630
Short-taper size	5	5	6	6	8	8	11
B	82,5	82,5	106,4	106,4	139,7	106,4	139,7
D	81	96,5	96,5	101	101	118	118
E	42	42	55	55	76	103	76
F <sup>3)</sup>	-	-	-	-	-	133,4	-
G	-	-	-	-	-	14	-
N <sup>2)</sup>	61,9	61,9	82,6	82,6	111,1	-	111,1
O	11 <sup>1)</sup>	11 <sup>1)</sup>	14	14	18	-	18
W	23,45	26,7	26,7	27,5	27,5	31	31
Mouting holes	*	3	6	6	6	6	6
	**	4	4	4	4	4	4
approx. kg	10	19	30	56	92	154	250

1) 12 with ASA B 5.9 A1/A2 inch, all other dim. should be taken from the above table.

2) With DIN 55026 form B; ASA B 5.9 A1/B1

3) With DIN 55026 Form A and B; DIN 55021 Forme A and B; ASA B 5.9 A1/A2

\* 3-Jaw

\*\* 4-Jaw

# Jaw dimensions for EG-ES

Reversible jaw UB

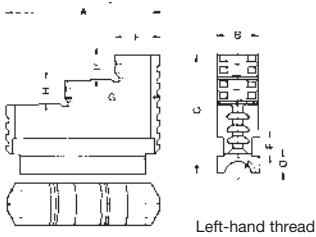

Größe	100	125	160	200	250	315	400	500	630
A	56	56	69	85	90	130	130	190	190
B	18	18	20	24	24	34	34	42	42
C	41,5	41,5	50	57,5	67,5	79,5	79,5	95	95
D	8,7	8,7	9,7	9,7	9,7	11,15	11,15	15	15
E	7	7	8	10	10	15	15	15	15
F	17	17	19	25	26	40	40	50	50
G	35	35	43	54	56	85	85	120	120
H	8	8	10	12	14	15	15	20	20
Thread	Tr14x3	Tr14x3	Tr16x4	Tr18x2	Tr18x2	Tr20x2	Tr20x2	Tr26x3	Tr26x3
approx. kg	0,18	0,18	0,3	0,53	0,7	1,7	1,7	3,7	3,7

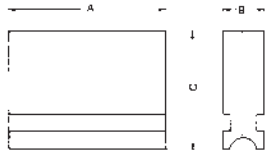



For turning unhardened jaws and grinding hardened jaws, with reversible and stepless adjustable setting jaws.

The BAV cutting attachment is mainly used for turning the inside and outside diameters of soft jaws on 3-jaw chucks.

It permits the chuck to be adjusted to the condition in which the work piece will be gripped within a few seconds (pretightening).

This assures positive gripping and accurate concentricity of the machined clamping surfaces of the chuck jaws in the tightened condition.

**Technical features:**

- only applicable with base jaws (GB) and top jaws (AB)

Tool group A09  
Type 091 Jaw cutting attachment  
for three-jaw chucks

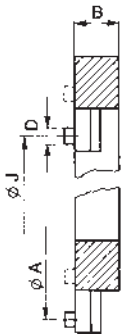

Item no.	Size	For chuck size	Load max.	External Ø	Inner Ø	Overhang distance		B	Thread	Weight approx. kg
						Ø J	Ø A			
220206 <sup>1)</sup>	0	125	15	153	110	50-115	150-215	20	M5	1,6
220207	1	200	30	176	110	35-125	170-260	31	M8	3,4
220208	2	250	30	215	135	70-140	215-285	31	M8	5
220209	3	250	30	244	162	100-175	240-315	31	M8	5,7
220210	4	315	30	290	208	145-215	290-360	31	M8	6,9
220211	5	400	40	342	260	160-270	330-440	31	M10	8,5

<sup>1)</sup> light-duty design

# safety driving adapter plates

Tool group A09  
Type 305-25  
**Safety driving adapter plates  
ISO 702-3 (DIN 55027) and 55022  
with studs and locknuts**

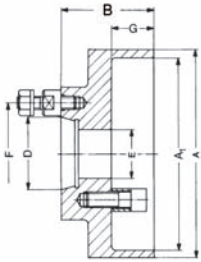

Item no.	Ø A	Taper	Inch	A1	B	D	E	F	G	Weight approx. kg
316409 ▲	160	3	6 ¼	148	73	53,975	37	75	33	5,1
316410 ▲	160	4	6 ¼	148	73	63,513	37	85	33	5,4
316411 ▲	160	5	6 ¼	148	88	82,563	50	104,8	43	7
316412 ▲	200	4	8	188	73	63,513	37	85	33	7,3
316413 ▲	200	5	8	188	88	82,563	50	104,8	43	7,4
316414 ▲	200	6	8	188	107	106,375	69	133,4	59	11,4
316415 ▲	250	5	10	234	88	82,563	50	104,8	43	13,4
316416 ▲	250	6	10	234	107	106,375	69	133,4	59	16
316417 ▲	250	8	10	234	109	139,719	69	171,4	59	19,2
316430 ▲	315	6	12 ½	299	107	106,375	69	133,4	59	25,4
316431 ▲	315	8	12 ½	299	109	139,719	69	171,4	59	27,7
316432 ▲	315	11	12 ½	299	111	196,869	69	235	59	32,3

Tool group A09  
Type 305-40  
**Safety driving adapter plates  
ISO 702-2 (DIN 55029)  
and ASA B 5.9 D1 Camlock**

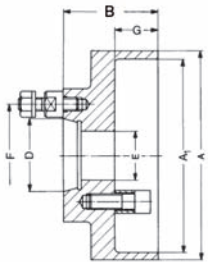

Item no.	Ø A	Taper	Inch	A1	B	D	E	F	G	Weight approx. kg
316418 ▲	160	3	6 ¼	148	73	53,975	37	70,66	33	5,1
316419 ▲	160	4	6 ¼	148	73	63,513	37	82,55	33	5,4
316420 ▲	160	5	6 ¼	148	88	82,563	50	104,8	43	7
316421 ▲	200	4	8	188	73	63,513	37	82,55	33	7,3
316422 ▲	200	5	8	188	88	82,563	50	104,8	43	7,4
316423 ▲	200	6	8	188	107	106,375	69	133,4	59	11,4
316424 ▲	250	5	10	234	88	82,563	50	104,8	43	13,4
316425 ▲	250	6	10	234	107	106,375	69	133,4	59	16
316426 ▲	250	8	10	234	109	139,719	69	171,4	59	19,2
316433 ▲	315	6	12 ½	299	107	106,375	69	133,4	59	25,4
316434 ▲	315	8	12 ½	299	109	139,719	69	171,4	59	27,7
316435 ▲	315	11	12 ½	299	111	196,869	69	235	59	32,3



# Steel adapter plates

Tool group A09  
Type 619-25

**Short-taper adapter plate**  
**ISO 702-3 (DIN 55027) and 55022**  
with studs and locknuts

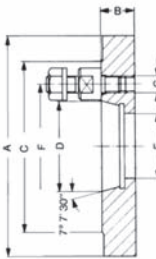

Item no.	Ø A	Taper	Inch	B	C	D	E	F	G	Weight approx. kg
319650	125	3	5	19	102	53,975	40	75	M10	2,3
319651	125	4	5	19	112	63,513	40	85	M10	2,2
319652	160	3	6 ¼	21	102	53,975	40	75	M10	3,9
319653	160	4	6 ¼	21	112	63,513	40	85	M10	3,9
319654	160	5	6 ¼	21	135	82,563	40	104,8	M10	4,6
319655	200	4	8	21	112	63,513	50	85	M10	6,4
319656	200	5	8	21	135	82,563	50	104,8	M10	7,4
319657	200	6	8	23	170	106,375	50	133,4	M12	8,4
319658	250	4	1	21	112	63,513	61	85	M10	10,2
319659	250	5	10	21	135	82,563	63	104,8	M10	11,6
319660	250	6	10	23	170	106,375	63	133,4	M12	13,3
319661	250	8	10	26	220	139,719	63	171,4	M16	13,8
319662	315	5	12 ¼	26	135	82,563	63	104,8	M10	18,6
319663	315	6	12 ¼	26	170	106,375	63	133,4	M12	21,5
319664	315	8	12 ¼	26	220	139,719	63	171,4	M16	22,6
319665	315	11	12 ¼	33	290	196,869	63	235	M20	25,2
319666	400	6	15 ¾	31	170	106,375	63	133,4	M12	35
319667	400	8	15,75	31	220	139,719	63	171,4	M16	37,2
319668	400	11	15,75	31	290	196,869	63	235	M20	42
319669	400	15	15,75	33	400	285,775	63	330,2	M24	42,1
319670	500	8	20	41	220	139,719	80	171,4	M16	62
319671	500	11	20	41	290	196,869	80	235	M20	67
319672	500	15	20	41	400	285,775	80	330,2	M24	68

Tool group A09  
Type 619-30

**Short-taper adapter plate**  
**ISO 702-1 (DIN 55026/55021) -**  
**ASA B 5.9 (without mounting bolts)**  
finished on machine side, faced on  
chuck side, especially

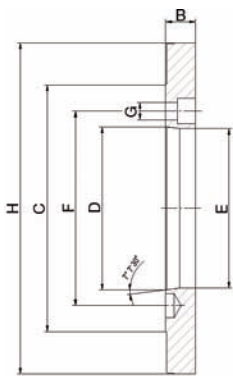

Item no.	Ø A	Taper	B	C	D	E	F	G
144933	125	3	18	-	53,975	40	70,6	3xØ10,5
145296	125	4	18	-	63,513	40	82,6	3xØ11
145328	160	3	18	-	53,975	40	70,6	3xØ10,5
145342	160	4	18	-	63,513	40	82,6	3xØ11
145343	160	5	21	-	82,563	50	104,8	3xØ11
145344	200	4	21	-	63,513	50	82,6	3xØ11
145345	200	5	21	-	82,563	50	104,8	3xØ11
145346	200	6	27	180	106,375	50	133,4	3xØ14
145347	250	4	27	-	63,513	63	82,6	3xØ11
145348	250	5	27	145	82,563	63	104,8	3xØ11
145349	250	6	27	181	106,375	63	133,4	3xØ14
145350	250	8	27	220	139,719	63	171,4	3xØ18
145351	315	5	36	145	82,563	63	104,8	3xØ11
145352	315	6	36	181	106,375	63	133,4	3xØ14
145353	315	8	36	220	139,719	63	171,4	3xØ18
145354	315	11	36	298	196,869	63	235	3xØ22
145355	400	6	40	181	106,375	63	133,4	3xØ14
145356	400	8	40	220	139,719	63	171,4	3xØ18
145357	400	11	40	298	196,869	63	235	3xØ22
145358	400	15	40	-	285,775	63	330,2	3xØ24
145359	500	8	42	227	139,719	80	171,4	3xØ18
145360	500	11	42	290	196,869	80	235	3xØ22
145364	500	15	42	400	285,775	80	330,2	3xØ24

# Steel adapter plates

Tool group A09  
Type 324-50  
**Short-taper adapter plate**  
for ISO 702-1 (DIN 55026),  
finished on both sides

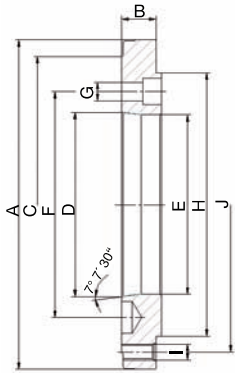

Item no.	Ø A	Taper	B	C	D	E	F	G	H	I	J
176804	125	3	17	102	53,975	51,2	70,6	3xø10,5	95	3x M8	108
176805	125	4	17	117	63,513	60,7	82,6	3x ø11	95	3x M8	108
176806	125	5	17	146	82,563	79,4	104,8	3x ø11	95	3x M8	108
176807	160	4	22	117	63,513	60,7	82,6	3x ø11	125	3x M10	140
176808	160	5	22,5	146	82,563	79,4	104,8	4x ø11	125	3x M10	140
176809	200	4	22,5	117	63,513	60,7	82,6	3x ø11	160	3x M10	176
176810	200	5	22,5	146	82,563	79,4	104,8	3x ø11	160	3x M10	176
176811	200	6	21,5	181	106,375	103	133,4	3x ø14	160	3x M10	176
176812	200	8	27	210	139,719	136	171,4	3x ø18	160	3x M10	176
176813	250	5	21	146	82,563	79,4	104,8	4x ø11	200	3x M12	224
176814	250	6	26	181	106,375	103	133,4	4x ø14	200	3x M12	224
176815	250	8	26	225	139,719	136	171,4	4x ø18	200	3x M12	224
176816	315	6	31,5	181	106,375	103	133,4	4x ø14	260	3x M12	286
176817	315	8	31	225	139,719	136	171,4	4x ø18	260	3x M12	286
176818	315	11	31	298	196,869	192,7	235	6x ø22	260	3x M12	286
176819	400	6	32,5	181	106,375	103	133,4	4x ø14	330	3x M16	362
176820	400	8	32	225	139,719	136	171,4	4x ø18	330	3x M16	362
176821	400	11	32,5	298	196,869	192,7	235	6x ø22	330	3x M16	362
176822	400	15	36	380	285,775	281,2	330,2	6x ø26	330	3x M16	362
176823	500	8	36	225	139,719	136	171,4	4x ø18	420	6x M16	458
176824	500	11	36	298	196,869	192,7	235	6x ø22	420	6x M16	458
176825	500	15	36	380	285,775	281,2	330,2	6x ø26	420	6x M16	458
159882	630	20	42	520	412,775	407,5	463,6	6x ø26	545	6x M16	586
176826	630	11	39	298	196,869	192,7	235	6x ø22	545	6x M16	586
176827	630	15	39	403	285,775	281,2	330,2	6x ø26	545	6x M16	586

Tool group A09  
Type 619-40  
**Short-taper adapter plate**  
ISO 702-2 (DIN 55029) and ASA B  
5.9 D1 Camlock

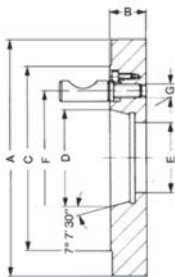

Item no.	Ø A	Taper	Inch	B	C	D	E	F	G	Weight approx. kg
319673	125	3	5	27	92,1	53,975	40	70,66	7/16 - 20	2,3
319674	125	4	5	28	117,5	63,513	40	82,55	7/16 - 20	2,2
319675	160	3	6 ¼	27	92,1	53,975	40	70,66	7/16 - 20	3,9
319676	160	4	6 ¼	28	117,5	63,513	40	82,55	7/16 - 20	3,9
319677	160	5	6 ¼	31	146	82,563	40	104,8	½ - 20	4,6
319678	200	4	8	28	117,5	63,513	50	82,55	7/16 - 20	6,4
319679	200	5	8	31	146	82,563	50	104,8	½ - 20	7,4
319680	200	6	8	36	181	106,375	50	133,4	5/8 - 18	8,4
319681	250	4	1	28	117,5	63,513	61	82,55	7/16 - 20	10,2
319682	250	5	10	31	146	82,563	63	104,8	½ - 20	11,6
319683	250	6	10	36	181	106,375	63	133,4	5/8 - 18	13,3
319684	250	8	10	39	225,4	139,719	63	171,4	¾ - 16	13,8
319685	315	5	12 ¼	31	146	82,563	63	104,8	½ - 20	18,6
319686	315	6	12 ¼	36	181	106,375	63	133,4	5/8 - 18	21,5
319687	315	8	12 ¼	39	225,4	139,719	63	171,4	¾ - 16	22,6
319688	315	11	12 ¼	45	298,4	196,869	63	235	7/8 - 14	25,2
319689	400	6	15 ¾	36	181	106,375	63	133,4	5/8 - 18	35
319690	400	8	15,75	39	225,4	139,719	63	171,4	¾ - 16	37,2
319691	400	11	15,75	45	298,4	196,869	63	235	7/8 - 14	42
319692	400	15	15,75	50	403	285,775	63	330,2	1 - 14	42,1
319693	500	8	20	41	225,4	139,719	80	171,4	¾ - 16	62
319694	500	11	20	45	298,4	196,869	80	235	7/8 - 14	67
319695	500	15	20	50	403	285,775	80	330,2	1 - 14	68

## Steel / Cast iron body Independent chucks

### Independent 4-jaw chucks - Jaws individually adjustable through threaded adjusting spindle.

RÖHM-Independent chucks in steel or cast iron design with individually adjustable jaws are successfully established, where irregular, regular or round workpieces have to be clamped safely.

#### Mechanism

By turning the radial positioned pinion (2, hardened) the power will be transmitted to the clamping jaws (5, 6, hardened) directly. The operating screw will be kept in position by the bearing support (3, 4, hardened). Steel or cast iron body (1)

#### Lubrication

Independent chucks must be lubricated regularly to maintain their gripping force. Appropriate directions are included in the operating instructions supplied with each chuck.

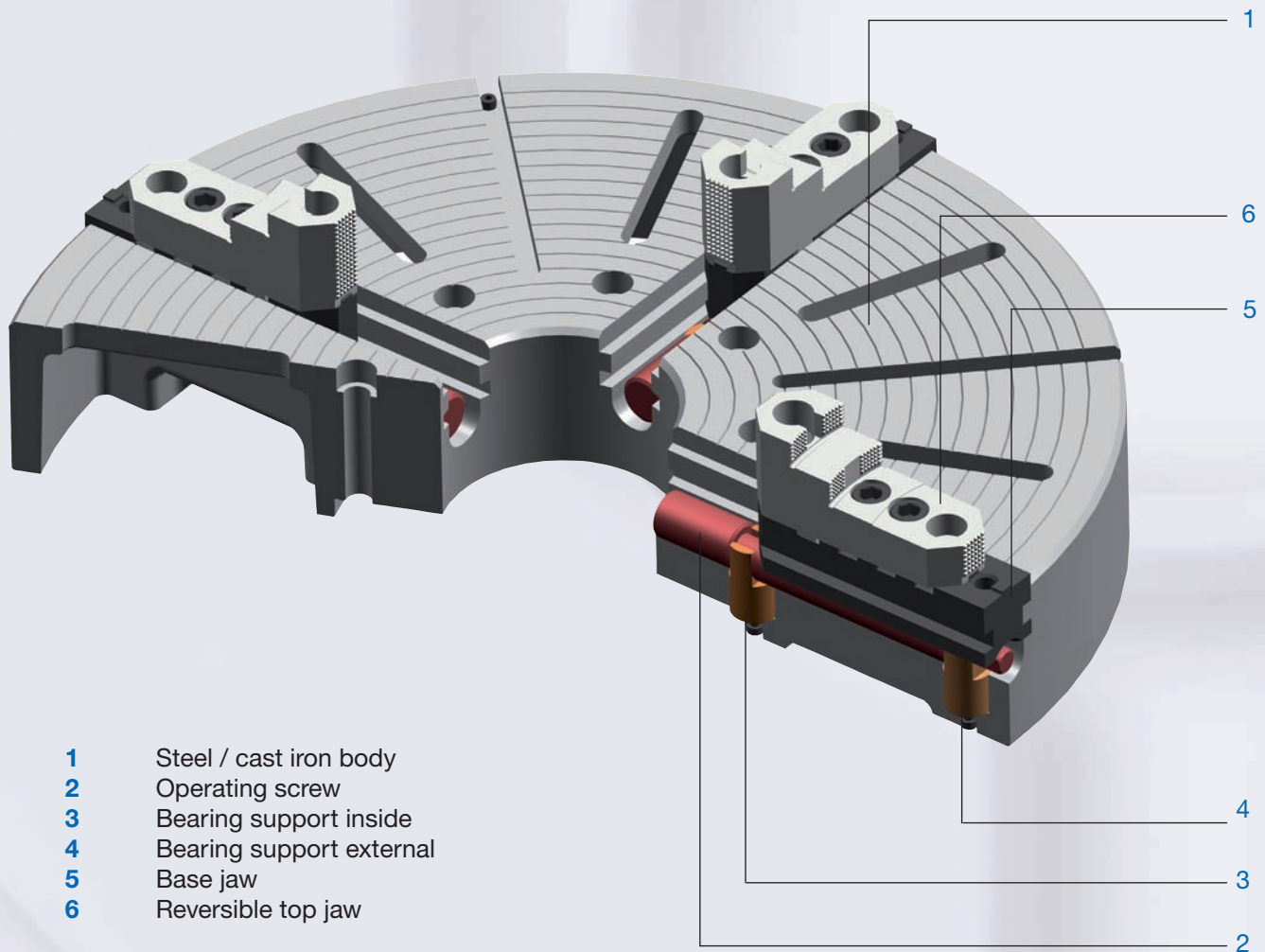

- 1 Steel / cast iron body
- 2 Operating screw
- 3 Bearing support inside
- 4 Bearing support external
- 5 Base jaw
- 6 Reversible top jaw

## USE-USU



The jaws can be centered approximately by adjusting them to the concentric grooves, accurate centering requires the use of a dial indicator.

Independent 4-jaw chuck

**Technical features:**

- jaws individually adjustable through threaded adjusting spindle
- steel version, from size 400 with T-slots and bolt slots

**Delivery includes:**

- 1 set of hard solid reversible jaws,
- 1 wrench,
- mounting screws
- or**
- 1 set of hard master jaws,
- 1 set of hard top jaws,
- 1 wrench,
- mounting screws

Tool group A26  
Type 499-00 Steel body,  
with **one-piece reversible jaws**  
**cylindrical centre mount**  
(without mounting bolts)

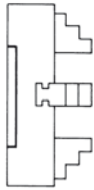

Item no.	Size	Through-hole	Speed max. min-1	Torque Nm	Clamping force/jaw kN
139781 ■	260	70	2350	120	17
139796 ■	310	75	1970	120	17
139827 ■	400	95	1530	170	23
139842 ■	450	95	1360	170	23
139857 ■	500	95	1220	170	23
139887 ■	630	135	970	240	37
140800 ■	710	135	860	240	37
140801 ■	800	190	765	300	45

Tool group A26  
Type 497-00 Steel body,  
with **reversible top jaws**  
**cylindrical centre mount**  
(without mounting bolts)

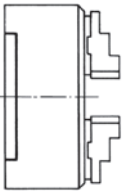

Item no.	Size	Through-hole	Speed max. min-1	Torque Nm	Clamping force/jaw kN
137147 ■	260	70	2350	120	17
139720 ■	310	75	1970	120	17
135368 ■	400	95	1530	170	23
136944 ■	450	95	1360	170	23
135631 ■	500	95	1220	170	23
139723 ■	630	135	970	240	37
141097 ■	710	135	860	240	37
141106 ■	800	190	765	300	45
600634 ▲	900	190	680	300	45
600635 ▲	1000	190	610	320	47
600636 ▲	1100	190	555	320	47
600637 ▲	1200	190	510	450	64

Tool group A26  
Type 499-20 Steel body,  
with **one-piece reversible jaws**  
**ISO 702-3** (DIN 55027), DIN 55022;  
with studs and locknuts, optional  
DIN 55021 with set screw and nut

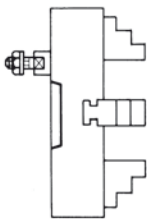

Item no.	Size	Mount short taper	Through-hole	Speed max. min-1	Torque Nm	Clamping force/jaw kN
139782 ▲	260	4	60	2350	120	17
139783 ▲	260	5	70	2350	120	17
139784 ▲	260	6	70	2350	120	17
139797 ▲	310	5	75	1970	120	17
139798 ▲	310	6	75	1970	120	17
139799 ▲	310	8	75	1970	120	17
139828 ▲	400	6	95	1530	170	23
139829 ■	400	8	95	1530	170	23
139830 ▲	400	11	95	1530	170	23
139843 ■	450	6	95	1360	170	23
139844 ▲	450	8	95	1360	170	23
139845 ▲	450	11	95	1360	170	23
139858 ▲	500	6	95	1220	170	23
139859 ■	500	8	95	1220	170	23
139860 ▲	500	11	95	1220	170	23
139888 ▲	630	8	136	970	240	37
139889 ▲	630	11	136	970	240	37
139890 ▲	630	15	136	970	240	37
141088 ▲	710	8	136	860	240	37
141089 ▲	710	11	136	860	240	37
141092 ▲	800	8	200	765	300	45
141093 ▲	800	11	192	765	300	45
141094 ▲	800	15	192	765	300	45

**USE-USU**

Tool group A26  
Type 497-20 Steel body,  
with **reversible top jaws**  
**ISO 702-3** (DIN 55027), DIN 55022;  
with studs and locknuts, optional  
DIN 55021 with set screw and nut

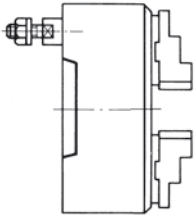

Item no.	Size	Mount short taper	Through-hole	Speed max. min-1	Torque Nm	Clamping force/ jaw kN
137163 ▲	260	4	60	2350	120	17
137164 ▲	260	5	70	2350	120	17
137165 ▲	260	6	70	2350	120	17
139724 ▲	310	5	75	1970	120	17
139725 ▲	310	6	75	1970	120	17
139726 ▲	310	8	75	1970	120	17
135371 ▲	400	6	95	1530	170	23
135372 ▲	400	8	95	1530	170	23
135358 ▲	400	11	95	1530	170	23
136947 ▲	450	6	95	1360	170	23
136948 ▲	450	8	95	1360	170	23
136957 ▲	450	11	95	1360	170	23
135632 ▲	500	6	95	1220	170	23
135633 ▲	500	8	95	1220	170	23
135696 ▲	500	11	95	1220	170	23
139767 ▲	630	8	136	970	240	37
139768 ▲	630	11	136	970	240	37
139769 ▲	630	15	136	970	240	37
141098 ▲	710	8	136	860	240	37
141099 ▲	710	11	136	860	240	37
141414 ▲	710	15	136	860	240	37
600638 ▲	800	8	200	765	300	45
141107 ▲	800	11	192	765	300	45
141108 ▲	800	15	192	765	300	45
600639 ▲	900	11	190	680	300	45
600641 ▲	900	15	190	680	300	45
141115 ▲	1000	11	190	610	320	47
141116 ▲	1000	15	190	610	320	47
600645 ▲	1000	20	190	610	320	47
150500 ▲	1100	11	190	555	320	47
600642 ▲	1100	15	190	555	320	47
600646 ▲	1100	20	190	555	320	47
150501 ▲	1200	11	190	510	450	64
600643 ▲	1200	15	190	510	450	64
600647 ▲	1200	20	190	510	450	64

Tool group A26  
Type 499-30 Steel body,  
with **one-piece reversible jaws**  
**ISO 702-1** (DIN 55026);  
DIN 55021, ASA B 5.9, A1/A2  
metr.; mounting from front  
(without mounting bolts)

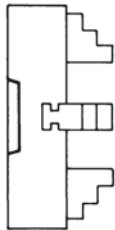

Item no.	Size	Mount short taper	Through-hole	Speed max. min-1	Torque Nm	Clamping force/ jaw kN
139785 <sup>1)</sup> ■	260	4	60	2350	120	17
139786 <sup>2)</sup> ■	260	5	70	2350	120	17
139787 ▲	260	6	70	2350	120	17
139800 <sup>2)</sup> ■	310	5	75	1970	120	17
139801 ▲	310	6	75	1970	120	17
139802 ▲	310	8	75	1970	120	17
139831 ▲	400	6	95	1530	170	23
139832 ▲	400	8	95	1530	170	23
139833 ▲	400	11	95	1530	170	23
139846 ▲	450	6	95	1360	170	23
139847 ▲	450	8	95	1360	170	23
139848 ▲	450	11	95	1360	170	23
139861 ▲	500	6	95	1220	170	23
139862 ▲	500	8	95	1220	170	23
139863 ▲	500	11	95	1220	170	23
139891 ▲	630	8	136	970	240	37
139892 ▲	630	11	136	970	240	37
139893 ▲	630	15	136	970	240	37
141090 ▲	710	8	136	860	240	37
141091 ▲	710	11	136	860	240	37
141095 ▲	800	11	192	765	300	45
141096 ▲	800	15	192	765	300	45

<sup>1)</sup> not for DIN 55021 or A1/A2 inch  
<sup>2)</sup> not for A1/A2 inch

## USE-USU

Tool group A26  
Type 497-30 Steel body,  
with **reversible top jaws**  
**ISO 702-1 (DIN 55026)**;  
DIN 55021, ASA B 5.9, A1/A2  
metr.; mounting from front  
(without mounting bolts)

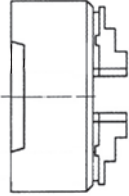

Item no.	Size	Mount short taper	Through-hole	Speed max. min-1	Torque Nm	Clamping force/ jaw kN
137260 <sup>1)</sup> ▲	260	4	60	2350	120	17
137261 <sup>2)</sup> ▲	260	5	70	2350	120	17
137262 ▲	260	6	70	2350	120	17
139727 <sup>2)</sup> ▲	310	5	75	1970	120	17
139728 ▲	310	6	75	1970	120	17
139729 ▲	310	8	75	1970	120	17
135373 ▲	400	6	95	1530	170	23
135374 ▲	400	8	95	1530	170	23
135360 ▲	400	11	95	1530	170	23
136949 ▲	450	6	95	1360	170	23
136950 ▲	450	8	95	1360	170	23
136956 ▲	450	11	95	1360	170	23
135700 ▲	500	6	95	1220	170	23
135701 ▲	500	8	95	1220	170	23
135702 ▲	500	11	95	1220	170	23
139770 ▲	630	8	136	970	240	37
139771 ▲	630	11	136	970	240	37
139772 ▲	630	15	136	970	240	37
141100 ▲	710	8	136	860	240	37
141101 ▲	710	11	136	860	240	37
141415 ▲	710	15	136	860	240	37
600648 ▲	800	8	200	765	300	45
141109 ▲	800	11	192	765	300	45
141110 ▲	800	15	192	765	300	45
600650 ▲	900	11	190	680	300	45
600651 ▲	900	15	190	680	300	45
141117 ▲	1000	11	190	610	320	47
141118 ▲	1000	15	190	610	320	47
600655 ▲	1000	20	190	610	320	47
150502 ▲	1100	11	190	555	320	47
600652 ▲	1100	15	190	555	320	47
600656 ▲	1100	20	190	555	320	47
150503 ▲	1200	11	190	510	450	64
600653 ▲	1200	15	190	510	450	64
600657 ▲	1200	20	190	510	450	64

<sup>1)</sup> not for DIN 55021 or A1/A2 inch

<sup>2)</sup> not for A1/A2 inch

Tool group A26  
Type 499-40 Steel body,  
with **one-piece reversible jaws**  
**ISO 702-2 (DIN 55029)**; ASA B 5.9,  
Type D, with studs for Camlock

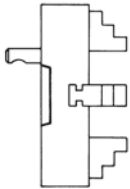

Item no.	Size	Mount short taper	Through-hole	Speed max. min-1	Torque Nm	Clamping force/ jaw kN
139791 ▲	260	4	60	2350	120	17
139792 ▲	260	5	70	2350	120	17
139793 ▲	260	6	70	2350	120	17
139806 ▲	310	5	75	1970	120	17
139807 ▲	310	6	75	1970	120	17
139808 ▲	310	8	75	1970	120	17
139837 ▲	400	6	95	1530	170	23
139838 ▲	400	8	95	1530	170	23
139839 ▲	400	11	95	1530	170	23
139852 ▲	450	6	95	1360	170	23
139853 ▲	450	8	95	1360	170	23
139854 ▲	450	11	95	1360	170	23
139867 ▲	500	6	95	1220	170	23
139868 ▲	500	8	95	1220	170	23
139869 ▲	500	11	95	1220	170	23
139897 ▲	630	8	136	970	240	37
139898 ▲	630	11	136	970	240	37
139899 ▲	630	15	136	970	240	37
140804 ▲	710	8	136	860	240	37
140805 ▲	710	11	136	860	240	37
140810 ▲	800	11	192	765	300	45
140811 ▲	800	15	192	765	300	45

**USE-USU**

Tool group A26  
 Type 497-40 Steel body,  
 with **reversible top jaws**  
**ISO 702-2** (DIN 55029); ASA B 5.9,  
 Type D, with studs for Camlock

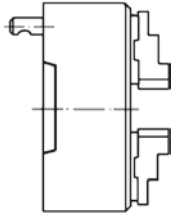

Item no.	Size	Mount short taper	Through-hole	Speed max. min-1	Torque Nm	Clamping force/ jaw kN
137166 ▲	260	4	60	2350	120	17
137254 ▲	260	5	70	2350	120	17
137255 ▲	260	6	70	2350	120	17
139733 ▲	310	5	75	1970	120	17
139734 ▲	310	6	75	1970	120	17
139735 ▲	310	8	75	1970	120	17
135375 ▲	400	6	95	1530	170	23
135376 ▲	400	8	95	1530	170	23
135359 ▲	400	11	95	1530	170	23
136951 ▲	450	6	95	1360	170	23
136952 ▲	450	8	95	1360	170	23
136955 ▲	450	11	95	1360	170	23
135703 ▲	500	6	95	1220	170	23
135704 ▲	500	8	95	1220	170	23
135705 ▲	500	11	95	1220	170	23
139776 ▲	630	8	136	970	240	37
139777 ▲	630	11	136	970	240	37
139778 ▲	630	15	136	970	240	37
141102 ▲	710	8	136	860	240	37
141103 ▲	710	11	136	860	240	37
141418 ▲	710	15	136	860	240	37
600658 ▲	800	8	200	765	300	45
141111 ▲	800	11	192	765	300	45
141112 ▲	800	15	192	765	300	45
600660 ▲	900	11	190	680	300	45
600661 ▲	900	15	190	680	300	45
141119 ▲	1000	11	190	610	320	47
141120 ▲	1000	15	190	610	320	47
600665 ▲	1000	20	190	610	320	47
150504 ▲	1100	11	190	555	320	47
600662 ▲	1100	15	190	555	320	47
600666 ▲	1100	20	190	555	320	47
150505 ▲	1200	11	190	510	450	64
600663 ▲	1200	15	190	510	450	64
600667 ▲	1200	20	190	510	450	64

## Jaws USE-USU

Tool group A09  
Type 493 **Reversible jaw EB**  
hardened

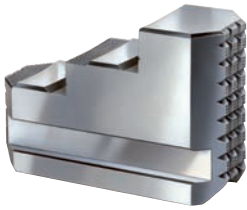

Item no.	Chuck Size	Number of jaws	Jaw length	Jaw height	Jaw width
022985 ■	260	4	85	64	35
022986 ■	310	4	94	66	35
163108 ■	400/450	4	112	80	40
163109 ■	500	4	136	88	40
175358 ■	630/710	4	172	108	45
247823 ■	800	4	185	130	60

Tool group A09  
Type 497 **Base jaw GB**  
with fixing screw

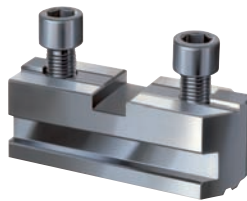

Item no.	Chuck Size	Number of jaws	Jaw length	Jaw height	Jaw width
304656 ■	260	4	91	40,1	35
304657 ■	310	4	107	40,1	35
304658 ■	400/450	4	126	47,1	40
304659 ■	500	4	164,4	47,1	40
304660 ■	630	4	165	51,1	45
304661 ■	710	4	202	51,1	45
304662 ■	800/900/1000/1100	4	240	61,1	60
150543 ▲	1200	4	350	92,2	70

Tool group A09  
Type 403 **Reversible top jaws UB**  
**DIN 6350**  
hardened

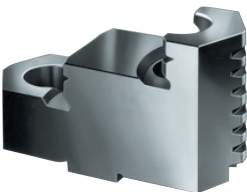

Item no.	Chuck Size	Number of jaws	Jaw length	Jaw height	Jaw width
108057 ■	260	4	95,3	52,5	36
108058 ■	310	4	109,5	57,5	42
108059 ■	400/450	4	127	64,5	42
108060 ■	500/630/710	4	127	79,5	50
105085 ■	800/900	4	210	89	68
105101 ■	1000/1100/1200	4	210	110	68

Stepped and hardened jaws, supplied as supplement or as spares, must be ground on the chuck.  
In case of a subsequent jaw delivery please return the chuck.

Tool group A09  
Type 402 **Unstepped top jaw AB**  
**DIN 6350**  
soft, material 16MnCr5



Item no.	Chuck Size	Number of jaws	Jaw length	Jaw height	Jaw width
107579 ●	260	4	103	53	36,5
107580 ●	310	4	120	58	42,5
107581 ●	400/450	4	137	65	42,5
107582 ●	500/630/710	4	140	80	50,5
105105 ■	800/900	4	210	89	68
105109 ■	1000/1100/1200	4	210	110	68



## Accessories USE-USU

Tool group A26  
Type 493 **Adjusting spindle**



Item no.	Size	Square	Hexagon
169142 <span style="color: yellow;">■</span>	260	10	-
166565 <span style="color: green;">●</span>	310	10	-
162110 <span style="color: yellow;">■</span>	400	13	-
162121 <span style="color: yellow;">■</span>	450	13	-
161629 <span style="color: green;">●</span>	500	13	-
161611 <span style="color: green;">●</span>	630	16	-
247826 <span style="color: green;">●</span>	800	18	-
150544 <span style="color: green;">●</span>	900	18	-
150545 <span style="color: green;">●</span>	1000	18	-
150546 <span style="color: yellow;">■</span>	1100	18	-
149776 <span style="color: yellow;">■</span>	1200	-	24

Tool group A26  
Type 493 **Safety key**



Item no.	Size	Square	Hexagon
160096 <span style="color: green;">●</span>	260/310	10	-
160097 <span style="color: green;">●</span>	400	13	-
160098 <span style="color: green;">●</span>	450/500	13	-
160099 <span style="color: green;">●</span>	630/710	16	-
160100 <span style="color: green;">●</span>	800/900/1000/1100	18	-
150548 <span style="color: yellow;">■</span>	1200	-	24

# Chuck dimensions steel body

Cylindrical centre mount

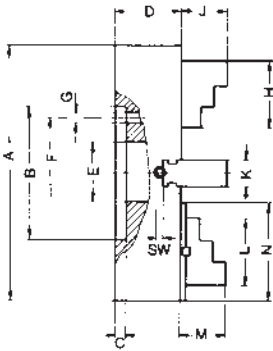

Size A	260	310	400	450	500	630	710	800	900	1000	1100	1200
B <sup>H8</sup>	130	130	210	210	210	260	260	370	370	370	370	550
C	8	8	18	18	18	18	18	18	18	18	18	18
D	USE-USU	85	95	112,5	112,5	112,5	122,5	132,5	145	145	160	200
E	USE-USU	70	75	95	95	95	135	135	180	190	190	190
F		105	105	175	175	175	220	220	330	330	330	500
G		4x13,5	4x13,5	4x17	4x17	4x17	4x20,5	4x20,5	8x22	8x22	8x22	8x26
H		85	94	112	112	136	172	172	185	-	-	-
J		34	35	42	42	50	55,5	55,5	80	-	-	-
K		35	35	40	40	40	45	45	60	60	60	70
L		80	87	105	114	126	140	165	210	210	210	210
M		54	57	72	72	77	82	87	91	91	111	111
N		100	105	125	135	145	165	185	240	240	240	350
SW		10	10	13	13	13	16	16	18	18	18	24 <sup>1)</sup>
approx. kg	23	32	52	76	91	150	190	270	300	395	750	900

1) Outer hexagon

Short taper mount

DIN 55021 with setscrews and locknuts



Size A	260			310			400			450			500			630			
Taper size	4 <sup>1)</sup>	5 <sup>2)</sup>	6	5	6	8	6	8	11	6	8	11	6	8	11	8	11	15	
B	63,5	82,5	106,4	82,5	106,4	139,7	106,4	139,7	196,9	106,4	139,7	196,9	106,4	139,7	196,9	139,7	196,9	285,8	
D	75			82			112,5			112,5			122,5			122,5			
E	61	70	70	75			95			95			95			135			
F	DIN Camlock	85 82,6	104,8	133,4	104,8	133,4	171,4	133,4	171,4	235	133,4	171,4	235	133,4	171,4	235	171,4	235	330,2
G		11	11	14	11	14	18	14	18	22	14	18	22	14	18	22	18	22	26
H		85			94			112			112			136			172		
J		34			35			42			42			50			55,5		
K	USE	35			35			40			40			40			45		
	USU	36			42			42			42			50			50		
L		95,3			109,5			127			127			127			127		
M		56,5			60,5			54			54			69			69		
N		91			107			126			126			164,4			165		
SW		10			10			13			13			13			16		
approx. kg	23			32			52			76			91			150			

DIN 55027 with studs and nuts

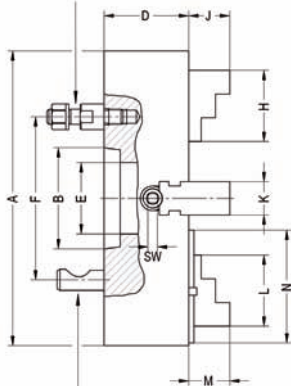

Size A	710			800			900			1000			1100			1200			
Taper size	8	11	15	8	11	15	11	15	11	15	20	11	15	20	11	15	20		
B	139,7	196,9	285,8	139,7	196,9	285,8	196,9	285,8	196,9	285,8	412,8	196,9	285,8	412,8	196,9	285,8	412,8		
D	132,5			145			145			160			160			200			
E	135			180			190			190			190			190			
F	171,4	235	330,2	171,4	235	330,2	235	330,2	235	330,2	463,6	235	330,2	463,6	235	330,2	463,6		
G	18	22	26	18	22	26	22	26	22	26	26	22	26	26	22	26	26		
H	172			185			-			-			-			-			
J	55,5			80			-			-			-			-			
K	USE	45			60			60			60			60			70		
	USU	68			68			68			68			68			68		
L	210			210			210			210			210			210			
M	69			91			91			112			112			112			
N	202			240			240			240			240			350			
SW	16			18			18			18			18			24			
approx. kg	190			270			300			395			750			900			

DIN 55029 with studs for camlock

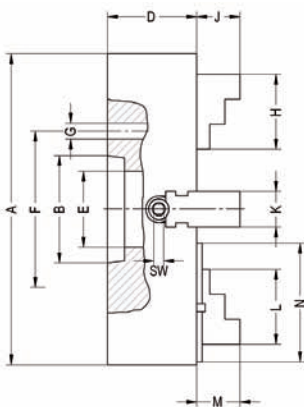

DIN 55026 mounting from front

1) Not for DIN 55021 or A1/A2 inch  
2) Not for A1/A2 inch

# Jaw dimensions steel body

**Reversible one-piece jaw EB**

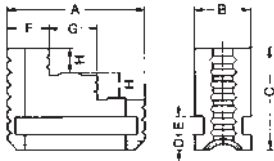

Size	260	310	400	450	500	630	710	800
A	85	94	112		136		172	185
B	35	35	40		40		45	60
C	64	66	80		88		108	130
D	10	10	10		10		12	14
E	12	12	14		14		14	18
F	27	30	36		42		52	55
G	29	32	38		46		60	65
H	14	15	19		23		26	30
approx. kg	0,8	0,9	1,6		2,25		3,5	4,2

**Base jaw GB**

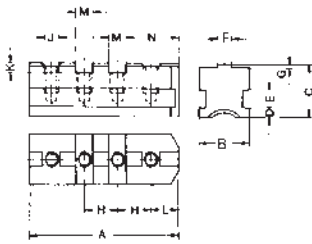

Size	260	310	400	450	630	710	800	900	1000	1100	1200
A	91	107	126		165	202		240			350
B	35	35	40		45	45		60			70
C	40,1	40,1	47,1		51,1	51,1		61,1			92,2
D	10	10	10		12	12		14			13
E	12	12	14		14	14		18			30
F	12,7	12,7	12,7		12,7	12,7		12,7			12,7
G	3,1	3,1	3,1		3,1	3,1		3,1			3,1
H	54	63,5	76,2		38,1	38,1		38,1			38,1
J	M12	M12	M16		M20	M20		M20			M20
K	76	76	10,8		10,8	10,8		10,8			10,8
L	21,2	24,4	27,5		27,5	27,5		27,5			26,4
M	19,03	19,03	19,03		19,03	19,03		19,03			19,03
N	38,7	46,6	56,1		56,1	56,1		56,1			55
Grooves	1	1	1		2	3		4			4
Tapped holes	2	2	2		4	5		6			9
approx. kg	0,8	0,9	1,1		1,4	2,2		2,8			3,5

Reversible top jaw UB and unstepped top jaw

**Adjusting spindle**

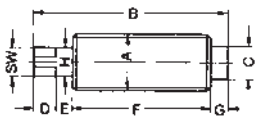

Size	260	310	400	450	500	630	710	800	900	1000	1100	1200
A	26	26	30	30	30	34	34	40	40	40	40	48
B	83,5	99	129	167	167	200	200	240	290	323	372	425
C	14	14	16	16	16	28	28	33	33	33	33	-
D	13	15	16	16	16	20,5	20,5	24	24	24	24	35
E	13,5	15	18,5	18,5	18,5	21,5	21,5	24	24	24	24	30
F	45	55	78	116	116	143	143	172	222	265	305	360
G	12	14	16,5	16,5	16,5	13,5	13,5	20	20	20	20	-
H	14	14	16	16	16	20	20	22	22	22	22	28
SW	10	10	13	13	13	16	16	18	18	18	18	24 <sup>1)</sup>

<sup>1)</sup> with outer hexagon

**Chucking capacities of jaw steps (standard values)**

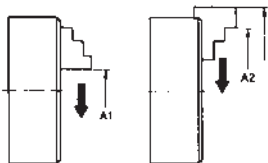

Size	260	310	400	450	500	630	710	800	900	1000	1100	1200
A1 min.	20	20	35	40	40	60	130	190	190	200	210	220
A2 max.	260	295	400	450	500	585	690	800	900	1000	1100	1200
l1 min.	75	80	90	100	145	145	145	170	170	195	195	195
l2 max.	260	310	400	450	520	650	730	820	960	1065	1165	1270
max. swing. dia.	305	355	465	510	570	675	785	870	1020	1120	1220	1320

## UGE-UGU



The jaws can be centered approximately by adjusting them to the concentric grooves, accurate centering requires the use of a dial indicator.  
Independent 4-jaw chuck

**Technical features:**

- jaws individually adjustable through threaded adjusting spindle

**Delivery includes:**

- 1 set of hard solid reversible jaws,
- 1 wrench,
- mounting screws
- or**
- 1 set of hard master jaws,
- 1 set of hard top jaws,
- 1 wrench,
- mounting screws

Cast iron independent chucks UGE-UGU

Tool group A26  
Type 493-00 Cast iron body,  
with **one-piece reversible jaws**  
**cylindrical centre mount**  
(without mounting bolts)

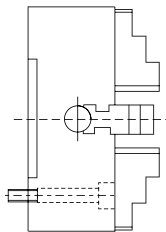

Item no.	Size	Through-hole	Speed max. min-1
1189704 ■	160	45	2000
1189705 ■	200	56	1800
1189706 ■	250	65	1500
1189707 ■	315	80	1200
1189708 ■	400	100	800
1189709 ■	500	125	500
1189710 ■	630	160	400
1189711 ■	800	210	300
1189712 ▲	1000	260	200
1189713 ▲	1250	305	150

Tool group A26  
Type 494-00 Cast iron body,  
with **reversible top jaws**  
**cylindrical centre mount**  
(without mounting bolts)

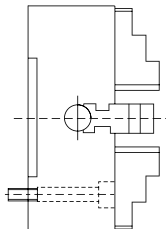

Item no.	Size	Through-hole	Speed max. min-1
1189780 ■	200	56	1800
1189781 ■	250	65	1500
1189782 ■	315	80	1200
1189783 ■	400	100	800
1189784 ■	500	125	500
1189785 ■	630	160	400
1189786 ■	800	210	300
1189787 ▲	1000	260	200
1189788 ▲	1250	305	150

Tool group A26  
Type 493-20 Cast iron body,  
with **one-piece reversible jaws**  
**ISO 702-3** (DIN 55027), DIN 55022;  
with studs and locknuts, optional  
DIN 55021 with set screw and nut

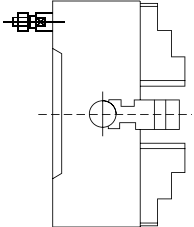

Item no.	Size	Mount short taper	Through-hole	Speed max. min-1
1189714 ■	200	5	56	1800
1189715 ■	200	6	56	1800
1189716 ■	250	5	65	1500
1189717 ■	250	6	65	1500
1189718 ■	250	8	65	1500
1189719 ■	315	5	80	1200
1189720 ■	315	6	80	1200
1189721 ■	315	8	80	1200
1189722 ■	400	6	100	800
1189723 ■	400	8	100	800
1189724 ■	400	11	100	800
1189725 ■	500	6	100	500
1189726 ■	500	8	125	500
1189727 ■	500	11	125	500
1189728 ■	630	8	125	400
1189729 ■	630	11	160	400
1189730 ■	630	15	160	400
1189731 ■	800	11	180	300
1189732 ■	800	15	200	300
1189858 ▲	1000	11	190	200
1189859 ▲	1000	15	190	200
1189860 ▲	1250	11	190	150
1189861 ▲	1250	15	190	150

## UGE-UGU

Tool group A26  
Type 494-20 Cast iron body,  
with **reversible top jaws**  
**ISO 702-3** (DIN 55027), DIN 55022;  
with studs and locknuts, optional  
DIN 55021 with set screw and nut

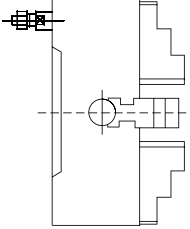

Item no.	Size	Mount short taper	Through-hole	Speed max. min-1
1189789 ■	200	5	56	1800
1189790 ■	200	6	56	1800
1189791 ■	250	5	65	1500
1189792 ■	250	6	65	1500
1189793 ■	250	8	65	1500
1189794 ■	315	5	80	1200
1189795 ■	315	6	80	1200
1189796 ■	315	8	80	1200
1189797 ■	400	6	100	800
1189798 ■	400	8	100	800
1189799 ■	400	11	100	800
1189800 ■	500	6	100	500
1189801 ■	500	8	125	500
1189802 ■	500	11	125	500
1189803 ■	630	8	125	400
1189804 ■	630	11	160	400
1189805 ■	630	15	160	400
1189806 ■	800	11	180	300
1189807 ■	800	15	200	300
1189808 ▲	1000	11	190	200
1189809 ▲	1000	15	190	200
1189810 ▲	1250	11	190	150
1189811 ▲	1250	15	190	150

Tool group A26  
Type 493-30 Cast iron body,  
with **one-piece reversible jaws**  
**ISO 702-1** (DIN 55026); DIN  
55021, ASA B 5.9, A1/A2 metr.;  
mounting from front  
(without mounting bolts)

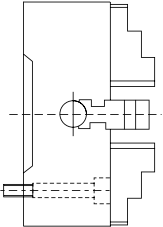

Item no.	Size	Mount short taper	Through-hole	Speed max. min-1
1189757 ■	200	5	50	1800
1189758 ■	200	6	50	1800
1189759 ■	250	5	65	1500
1189760 ■	250	6	65	1500
1189761 ■	250	8	65	1500
1189762 ■	315	5	80	1200
1189763 ■	315	6	80	1200
1189764 ■	315	8	80	1200
1189765 ■	400	6	100	800
1189766 ■	400	8	100	800
1189767 ■	400	11	100	800
1189768 ■	500	6	100	500
1189769 ■	500	8	125	500
1189770 ■	500	11	125	500
1189771 ■	630	8	125	400
1189772 ■	630	11	160	400
1189773 ■	630	15	160	400
1189774 ■	800	11	180	300
1189775 ■	800	15	180	300
1189776 ▲	1000	11	180	200
1189777 ▲	1000	15	190	200
1189778 ▲	1250	11	190	150
1189779 ▲	1250	15	190	150

Tool group A26  
Type 494-30 Cast iron body,  
with **reversible top jaws**  
**ISO 702-1** (DIN 55026); DIN  
55021, ASA B 5.9, A1/A2 metr.;  
mounting from front  
(without mounting bolts)

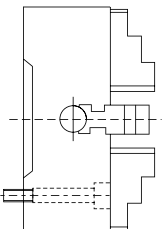

Item no.	Size	Mount short taper	Through-hole	Speed max. min-1
1189835 ■	200	5	50	1800
1189836 ■	200	6	50	1800
1189837 ■	250	5	65	1500
1189838 ■	250	6	65	1500
1189839 ■	250	8	65	1500
1189840 ■	315	5	80	1200
1189841 ■	315	6	80	1200
1189842 ■	315	8	80	1200
1189843 ■	400	6	100	800
1189844 ■	400	8	100	800
1189845 ■	400	11	100	800
1189846 ■	500	6	100	500
1189847 ■	500	8	125	500

## UGE-UGU

Cast iron independent chucks UGE-UGU

Item no.	Size	Mount short taper	Through-hole	Speed max. min-1
1189848 <span style="color: yellow;">■</span>	500	11	125	500
1189849 <span style="color: yellow;">■</span>	630	8	125	400
1189850 <span style="color: yellow;">■</span>	630	11	160	400
1189851 <span style="color: yellow;">■</span>	630	15	160	400
1189852 <span style="color: yellow;">■</span>	800	11	180	300
1189853 <span style="color: yellow;">■</span>	800	15	180	300
1189854 <span style="color: red;">▲</span>	1000	11	180	200
1189855 <span style="color: red;">▲</span>	1000	15	190	200
1189856 <span style="color: red;">▲</span>	1250	11	190	150
1189857 <span style="color: red;">▲</span>	1250	15	190	150

Tool group A26  
Type 493-40 Cast iron body,  
with **one-piece reversible jaws**  
**ISO 702-2** (DIN 55029); ASA B 5.9,  
Type D, with studs for Camlock

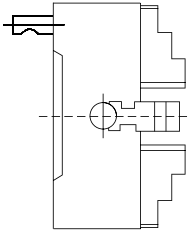

Item no.	Size	Mount short taper	Through-hole	Speed max. min-1
1189733 <span style="color: yellow;">■</span>	200	4	56	1800
1189734 <span style="color: yellow;">■</span>	200	5	56	1800
1189735 <span style="color: yellow;">■</span>	200	6	56	1800
1189736 <span style="color: yellow;">■</span>	250	4	60	1500
1189737 <span style="color: yellow;">■</span>	250	5	65	1500
1189738 <span style="color: yellow;">■</span>	250	6	65	1500
1189739 <span style="color: yellow;">■</span>	250	8	65	1500
1189740 <span style="color: yellow;">■</span>	315	5	80	1200
1189741 <span style="color: yellow;">■</span>	315	6	80	1200
1189742 <span style="color: yellow;">■</span>	315	8	80	1200
1189743 <span style="color: yellow;">■</span>	400	6	100	800
1189744 <span style="color: yellow;">■</span>	400	8	100	800
1189745 <span style="color: yellow;">■</span>	400	11	100	800
1189746 <span style="color: yellow;">■</span>	500	8	125	500
1189747 <span style="color: yellow;">■</span>	500	11	125	500
1189748 <span style="color: yellow;">■</span>	630	8	125	400
1189749 <span style="color: yellow;">■</span>	630	11	160	400
1189750 <span style="color: yellow;">■</span>	630	15	160	400
1189751 <span style="color: yellow;">■</span>	800	11	180	300
1189752 <span style="color: yellow;">■</span>	800	15	200	300
1189753 <span style="color: red;">▲</span>	1000	11	180	200
1189754 <span style="color: red;">▲</span>	1000	15	190	200
1189755 <span style="color: red;">▲</span>	1250	11	190	150
1189756 <span style="color: red;">▲</span>	1250	15	190	150

Tool group A26  
Type 494-40 Cast iron body,  
with **reversible top jaws**  
**ISO 702-2** (DIN 55029); ASA B 5.9,  
Type D, with studs for Camlock

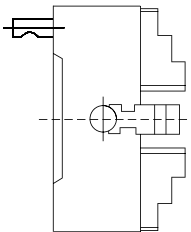

Item no.	Size	Mount short taper	Through-hole	Speed max. min-1
1189812 <span style="color: yellow;">■</span>	200	4	56	1800
1189813 <span style="color: yellow;">■</span>	200	5	56	1800
1189943 <span style="color: yellow;">■</span>	200	6	56	1800
1189814 <span style="color: yellow;">■</span>	250	4	60	1500
1189815 <span style="color: yellow;">■</span>	250	5	65	1500
1189816 <span style="color: yellow;">■</span>	250	6	65	1500
1189817 <span style="color: yellow;">■</span>	250	8	65	1500
1189818 <span style="color: yellow;">■</span>	315	5	80	1200
1189819 <span style="color: yellow;">■</span>	315	6	80	1200
1189820 <span style="color: yellow;">■</span>	315	8	80	1200
1189821 <span style="color: yellow;">■</span>	400	6	100	800
1189822 <span style="color: yellow;">■</span>	400	8	100	800
1189823 <span style="color: yellow;">■</span>	400	11	100	800
1189824 <span style="color: yellow;">■</span>	500	8	125	800
1189825 <span style="color: yellow;">■</span>	500	11	125	800
1189826 <span style="color: yellow;">■</span>	630	8	125	400
1189827 <span style="color: yellow;">■</span>	630	11	160	400
1189828 <span style="color: yellow;">■</span>	630	15	160	400
1189829 <span style="color: yellow;">■</span>	800	11	180	300
1189830 <span style="color: yellow;">■</span>	800	15	200	300
1189831 <span style="color: red;">▲</span>	1000	11	190	200
1189832 <span style="color: red;">▲</span>	1000	15	190	200
1189833 <span style="color: red;">▲</span>	1250	11	190	150
1189834 <span style="color: red;">▲</span>	1250	15	190	150

## Jaws UGE-UGU

Tool group A09  
Type 493-00 **Reversible jaw EB**  
hardened

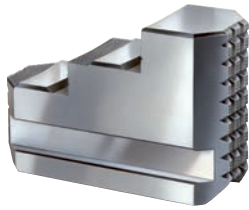

Item no.	Chuck Size	Number of jaws	Jaw length	Jaw height	Jaw width
1189865 <span style="color: yellow;">■</span>	160	4	61,5	51	20
1189866 <span style="color: yellow;">■</span>	200	4	85	61,5	27
1189867 <span style="color: yellow;">■</span>	250	4	92	61,5	27
1189868 <span style="color: yellow;">■</span>	315	4	111	76,5	40
1189871 <span style="color: yellow;">■</span>	400	4	129	76,5	40
1189872 <span style="color: yellow;">■</span>	500	4	152,5	93,5	52
1189873 <span style="color: yellow;">■</span>	630	4	177	100,5	52
1189874 <span style="color: yellow;">■</span>	800	4	202	114,5	70
1189875 <span style="color: red;">▲</span>	1000/1250	4	245	150	80

Tool group A09  
Type 497-00 **Base jaw GB**  
with mounting bolts

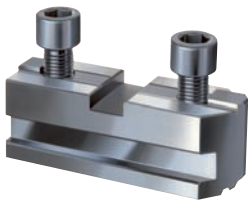

Item no.	Chuck Size	Number of jaws	Jaw length	Jaw height	Jaw width
1189895 <span style="color: yellow;">■</span>	200	4	79	32	27
1189896 <span style="color: yellow;">■</span>	250	4	94	38	27
1189897 <span style="color: yellow;">■</span>	315	4	110	39	40
1189898 <span style="color: yellow;">■</span>	400	4	129	44	40
1189899 <span style="color: yellow;">■</span>	500	4	168	59	52
1189900 <span style="color: yellow;">■</span>	630	4	206	59	52
1189901 <span style="color: red;">▲</span>	800	4	206	59	70
1189902 <span style="color: red;">▲</span>	1000/1250	4	305	76	80

Tool group A09  
Type 402 **Unstepped top jaw AB**  
soft



Item no.	Chuck Size	Number of jaws	Jaw length	Jaw height	Jaw width
1189877 <span style="color: yellow;">■</span>	200	4	90	43,5	40
1189878 <span style="color: yellow;">■</span>	250	4	106	51,5	47
1189879 <span style="color: yellow;">■</span>	315	4	120	55	52
1189880 <span style="color: yellow;">■</span>	400	4	140	64,5	52
1189881 <span style="color: yellow;">■</span>	500	4	145	82	60
1189882 <span style="color: yellow;">■</span>	630	4	145	82	60
1189883 <span style="color: red;">▲</span>	800	4	145	85	80
1189884 <span style="color: red;">▲</span>	1000/1250	4	170	102	85

Tool group A09  
Type 403 **Reversible top jaws UB**  
hardened

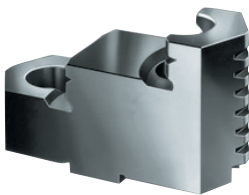

Item no.	Chuck Size	Number of jaws	Jaw length	Jaw height	Jaw width
1189886 <span style="color: yellow;">■</span>	200	4	82	43,5	34
1189887 <span style="color: yellow;">■</span>	250	4	96,5	51,5	34
1189888 <span style="color: yellow;">■</span>	315	4	112,5	55	42
1189889 <span style="color: yellow;">■</span>	400	4	129	64,5	42
1189890 <span style="color: yellow;">■</span>	500	4	136	74,5	54
1189891 <span style="color: yellow;">■</span>	630	4	136	82	54
1189892 <span style="color: yellow;">■</span>	800	4	136	88	72
1189893 <span style="color: yellow;">■</span>	1000/1250	4	160	102	82

# Accessories UGE-UGU

Tool group A26

 Type 493 **Adjusting spindle**

Item no.	Size
1189920	160
1189921	200
1189922	250
1189923	315
1189924	400
1189925	500
1189926	630
1189927	800
1189928	1000
1189929	1250

Tool group A26

 Type 493 **Spindle holder**

Item no.	Size
1189933	160
1189934	200
1189935	250
1189936	315
1189937	400
1189938	500
1189939	630
1189940	800
1189941	1000
1189942	1250

Tool group A26

 Type 493 **Safety key**

Item no.	Size
1189907	160
1189908	200
1189909	250
1189910	315
1189911	400
1189912	500
1189913	630
1189914	800
1189915	1000
1189916	1250

Tool group A 26

 Type 402 **Fixing screws for top jaws bolt 1**

Item no.	Size	Thread
1208225	200	3/8" - 16x30mm
1208226	250/315	1/2" - 13x40mm
1208227	400	5/8" - 11x45mm
1208228	500	3/4" - 10x55mm
1208229	630	3/4" - 10x60mm
1208230	800	3/4" - 10x65mm
1208231	1000/1250	3/4" - 10x45mm

Tool group A 26

 Type 402 **Fixing screws for top jaws bolt 2**

Item no.	Size	Thread
1208232	200	3/8" - 16x20mm
1208233	250/315	1/2" - 13x25mm
1208234	400	5/8" - 11x30mm
1208235	500/630/800	3/4" - 10x40mm
1208236	1000/1250	3/4" - 10x45mm



## Accessories UGE-UGU

Tool group A09  
Type 324 **short taper plate**  
ISO 702-1 (DIN 55026) for cylinder  
screw with mounting from front

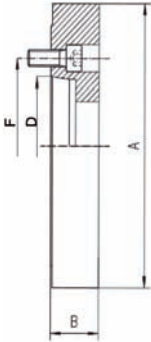

Item no.	Size	Taper	Ø A	B	D	F	Through-hole
1193011	200	5	203	40	82,575	104,8	40
1193012	200	6	203	43	106,39	133,4	55
1193013	250	5	203	40	82,575	104,8	40
1193014	250	6	203	43	106,39	133,4	55
1193015	250	8	203	50	139,735	171,4	79,5
1193016	315	5	253	40	82,757	104,8	40
1193017	315	6	253	43	106,39	133,4	55
1193018	315	8	253	50	139,735	171,4	79,5
1193019	400	6	318	43	106,39	133,4	55
1193020	400	8	318	55	139,735	171,4	79,5
1193021	400	11	318	65	196,885	235	103
1193022	500	6	405	43	106,39	133,4	55
1193023	500	8	405	49	139,735	171,4	79,5
1193024	500	11	405	75	196,885	235	103
1193025	630	8	405	49	139,735	171,4	79,5
1193026	630	11	405	75	196,885	235	103
1193027	630	15	405	75	285,8	330,2	103

finished on machine side, faced on chuck side, especially

Tool group A09  
Type 319 **Short-taper  
adapter plates**  
ISO 702-3 (DIN 55027)  
with studs and locknuts

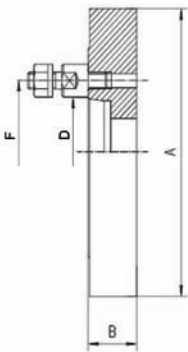

Item no.	Size	Taper	Ø A	B	D	F	Through-hole
1193028	200	5	203	38	82,575	104,8	61
1193029	200	6	203	38	106,39	133,4	61
1193030	250	5	253	33	82,575	104,8	79,5
1193031	250	6	253	50	106,39	133,4	79,5
1193032	250	8	253	46	139,735	171,4	79,5
1193033	315	5	253	33	82,575	104,8	79,5
1193034	315	6	253	50	106,39	133,4	79,5
1193035	315	8	253	46	139,735	171,4	79,5
1193036	400	6	318	38	106,39	133,4	103
1193037	400	8	318	55	139,735	171,4	103
1193038	400	11	318	47	196,885	235	103
1193039	500	6	405	38	106,39	133,4	103
1193040	500	8	405	43	139,735	171,4	103
1193041	500	11	405	47	196,885	235	103
1193042	630	8	405	43	139,735	171,4	103
1193043	630	11	405	47	196,885	235	103
1193044	630	15	405	50	285,8	330,2	103

finished on machine side, faced on chuck side, especially

Tool group A09  
Type 334 **Short-taper  
adapter plates**  
ISO 702-2 (DIN 55029)  
with studs for camlock

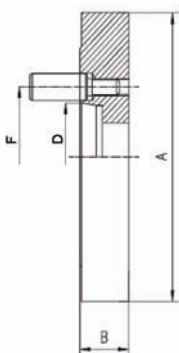

Item no.	Size	Taper	Ø A	B	D	F	Through-hole
1193045	200	4	203	44	63,525	85,6	61
1193046	200	5	203	50	82,575	104,8	61
1193047	200	6	203	42	106,39	133,4	61
1193048	250	4	253	35	63,525	82,1	61
1193049	250	5	203	49	82,575	104,8	79,5
1193050	250	6	253	49	106,39	133,4	79,5
1193051	250	8	253	49	139,735	171,4	79,5
1193052	315	6	253	49	106,39	133,4	79,5
1193053	315	8	253	49	139,735	171,4	79,5
1193054	400	6	318	70	106,39	133,4	103
1193055	400	8	318	55	139,735	171,4	103
1193056	400	11	318	55	196,885	235	103
1193057	500	8	405	55	139,735	171,4	103
1193058	500	11	405	55	196,885	235	103
1193059	630	8	405	55	139,735	171,4	103
1193060	630	11	405	55	196,885	235	103
1193061	630	15	405	60	330,2	235	103

finished on machine side, faced on chuck side, especially

# Chuck dimensions cast iron body

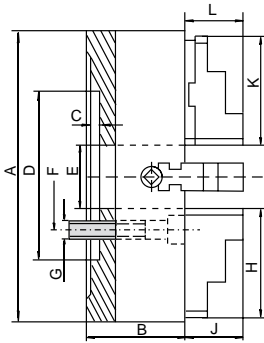
**Cylindrical centre mount**
**DIN 6350**

Size	160	200	250	315	400	500	630	800	1000	1250
A	160	200	250	315	400	500	630	800	1000	1250
B	65	75	85	95	105	120	140	135	150	165
C	5	6	7	7	10	12	12	12	15	15
DH7	65	75	150	175	200	270	270	250	320	400
E	45	56	65	80	100	125	160	210	260	305
F	95	95	104,8	133,4	171,4	235	235	300	370	500
G	4xM10	4xM10	4xM12	4xM16	4xM16	4xM20	4xM20	8xM20	8xM20	8xM20
H	61,5	85	96,5	111	129	152,5	177	202	240	240
J	31,5	35	40,3	49,8	49,8	59,8	59,8	70,8	91	91
L	-	46,4	60,4	60,9	72,3	90,3	97,8	93,8	119	119
K	-	82	96,5	112,5	129	136	136	136	160	160
approx. kg	75	10	25	39	61	105	163	319	370	700

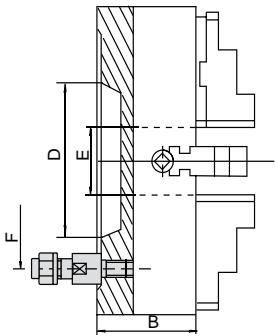
**Short taper mount**
**DIN 55027 with studs and locknuts**

Size	200			250			315			
Taper size	4	5	6	4	5	6	8	5	6	8
B	75	75	75	85	85	85	85	95	95	95
D	63,5	82,5	106,3	63,5	82,5	106,3	139,7	82,5	106,3	139,7
E	56	56	56	60	65	65	65	80	80	80
F	85 <sup>1)</sup>	82,6	104,8	133,4	82,6	104,8	133,4	171,4	104,8	133,4
Mounting holes	DIN	3	4	4	-	4	4	4	4	4
	Camlock	3	6	6	3	6	6	6	6	6
approx. kg	10	10	10	27,5	27,5	27,5	27,5	39,5	39,5	39,5

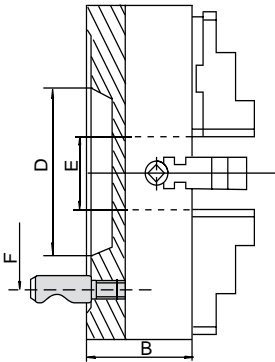
**DIN 55029 with studs for camlock**

Size	400			500			630		
Taper size	6	8	11	6	8	11	8	11	15
B	105	105	105	120	120	120	140	140	140
D	106,3	139,7	196,8	106,3	139,7	196,8	139,7	196,8	285,7
E	100	100	100	100	125	125	125	160	160
F	133,4	171,4	235	133,4	171,4	235	171,4	235	330,2
Mounting holes	DIN	4	6	4	4	6	4	6	6
	Camlock	6	6	6	6	6	6	6	6
approx. kg	60	60	60	95,5	95,5	95,5	165	165	165

Size	800		1000		1250	
Taper size	11	15	11	15	11	15
B	135	135	150	150	165	165
D	196,8	285,7	196,8	285,7	196,8	285,7
E	180	200	190	190	190	190
F	235	330,2	235	330,2	235	330,2
Mounting holes	DIN	6	6	6	6	6
	Camlock	6	6	6	6	6
approx. kg	298	298	370	370	700	700

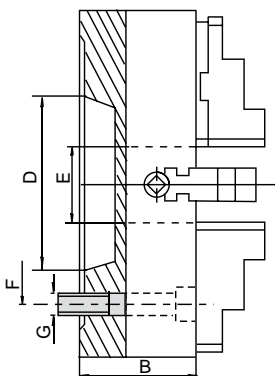
**DIN 55026 mounting from front**

Size	200		250			315			400		
Taper size	5	6	5	6	8	5	6	8	6	8	11
B	75	75	85	85	85	95	95	95	105	105	105
D	82,5	106,3	82,5	106,3	139,7	82,5	106,3	139,7	106,3	139,7	196,8
E	50	50	65	65	65	80	80	80	100	100	100
F	104,8	133,4	104,8	133,4	171,4	104,8	133,4	171,4	133,4	171,4	235
G	4xM10	4xM12	8xM10	4xM12	4xM16	4xM10	8xM12	4xM16	8xM12	4xM16	4xM20
approx. kg	17	17	25,5	25,5	25,5	40	40	40	65	65	65

Size	500			630			800		1000		1250	
Taper size	6	8	11	8	11	15	11	15	11	15	11	15
B	120	120	120	140	140	140	135	135	150	150	165	165
D	106,3	139,7	196,8	139,7	196,8	285,7	196,8	287,7	196,8	287,7	196,8	285,7
E	100	125	125	125	160	160	180	180	180	190	190	190
F	133,4	171,4	235	171,4	235	330,2	235	330,2	235	330,2	235	330,2
G	4xM12	8xM16	8xM20	8xM16	8xM20	4xM24	8xM20	8xM24	8xM20	8xM24	8xM20	8xM24
approx. kg	114	114	114	165	165	165	305	305	370	370	700	700

# Jaw dimensions cast iron body

## Reversible one-piece jaw EB

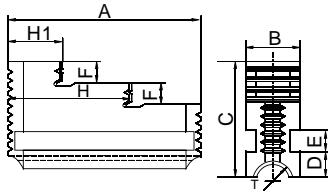

Size	160	200	250	315	400	500	630	800	1000	1250
A	61,5	85	92	111	129	152,5	177	202	245	245
B	20	27	27	40	40	52	52	70	80	80
C	51	61,5	61,	76,5	76,5	93,5	100,5	114,5	150	150
D	9	11,5	11,5	9,7	9,7	11,7	15,7	15,7	25	25
E	10	10	10	12	12	15	18	20	25	25
F	10	12	12	18	18	22	25	25	40	40
H1	20	30,5	30,5	27	32,5	35	45	44	65	65
H	41	58	65,5	67	78,5	93	109	122	160	160
Thread T	22x4	24x4	24x4	Tr32x6	Tr32x6	Tr36x6	Tr40x6	Tr44x8	Tr55x8	Tr55x8

## Base jaw GB

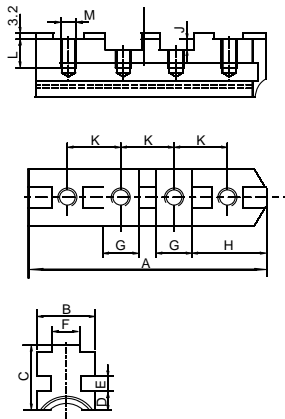

Size	200	250	315	400	500	630	800	1000	1250
A	79	94	110	129	168	206	206	305	305
B	27	27	40	40	52	52	70	80	80
C	32	38	39	44	59	59	59	76	76
D	11,5	11,5	9,7	9,7	11,7	15,7	15,7	25	25
E	10	10	12	12	15	18	20	25	25
F <sub>-0,03</sub>	7,94	12,7	12,7	12,7	12,7	12,7	12,7	12,7	12,7
G <sub>+0,01</sub>	12,69	19,04	19,04	19,04	19,04	19,04	19,04	19,04	19,04
H	33,2	37,5	45,4	54,9	55,5	55,5	55,5	57,74	57,74
J	4	4	4	7,2	7,2	7,2	7,2	7,2	7,2
K	22,25	27	31,75	38,1	38,1	38,1	38,1	38,1	38,1
L	14	20	17,5	22	33,5	33,5	33,5	35	35
M	3/8-16	1/2-13	1/2-13	5/8-11	3/4-10	3/4-10	3/4-10	3/4-10	3/4-10
Thread T	24x4	24x4	Tr32x6	Tr32x6	Tr36x6	Tr40x6	Tr44x8	Tr55x8	Tr55x8

## Unstepped soft top jaw AB

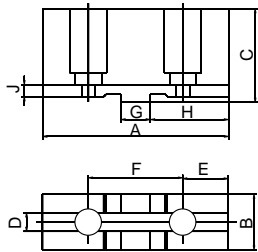

Size	200	250	315	400	500	630	800	1000	1250
A	90	106	120	140	145	145	145	170	170
B	40	47	52	52	60	60	80	85	85
C	43,5	51,5	55	64,5	82	82	85	102	102
D	7,95	12,71	12,71	12,71	12,71	12,71	12,71	12,71	12,71
E	24	27,5	30,7	34,4	34,4	34,4	34,4	46,4	46,4
F	44,5	54	63,5	76,2	76,2	76,2	76,2	76,2	76,2
G	12,69	19,04	19,04	19,04	19,04	19,04	19,04	19,04	19,04
H	40	45	53	63	63	63	63	75	75
J	4	4	4	4	4	4	4	4	4

## Reversible top jaw UB

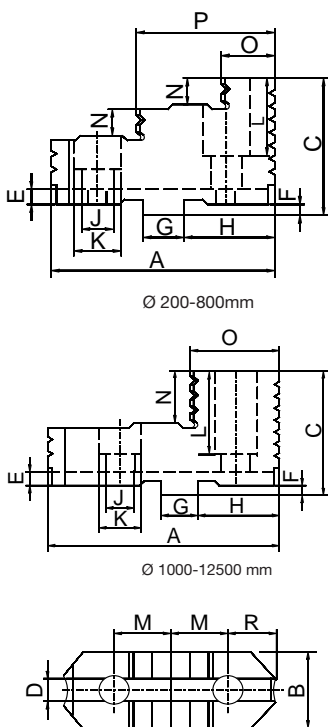

Size	200	250	315	400	500	630	800	1000	1250
A	82	96,5	112,5	129	136	136	136	160	160
B	34	34	42	42	54	54	72	82	82
C	43,5	51,5	55	64,5	74,5	82	88	102	102
D	7,95	12,71	12,71	12,71	12,71	12,71	12,71	12,71	12,71
E	4	4	4	4	4	4	4	4	4
F <sub>-0,03</sub>	3,2	3,2	3,2	6,3	6,3	6,3	6,3	6,3	6,3
G <sub>+0,01</sub>	12,69	19,04	19,04	19,04	19,04	19,04	19,04	19,04	19,04
H	35,2	40	47,9	57,4	58	58	58	70,48	70,48
J	11	14	14	18	22	22	22	22	22
K	18	20	20	26	33	33	33	33	33
L	21,5	26,5	27,5	32	39,5	43	46	71	71
M	3/8-16	1/2-13	1/2-13	5/8-11	3/4-10	3/4-10	3/4-10	3/4-10	3/4-10
N	9,5	12	13	13,5	18	21	24	57	57
O	22	25	27	26,5	37,5	37,5	40	80	80
P	53	62	70,5	79	87	87	89	-	-
R	19,3	22,5	25,7	28,8	29,4	29,4	29,4	41,82	41,82

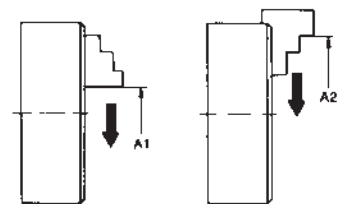

## Chucking capacities of jaw steps (standard values)

Größe mm	160	200	250	315	400	500	630	800	1000	1250
A1 min.	8	10	10	15	20	45	50	50	170	170
A2 max.	160	200	250	315	400	500	630	800	1000	1250
Größter Umlauf-Ø	185	235	296	369	465	570	720	888	1088	1338

Dimensions cast iron independent chucks

# Machine spindle noses for DIN and ASA B 5.9

Machine spindle noses are not included in the scope of delivery!

## DIN 800, with thread

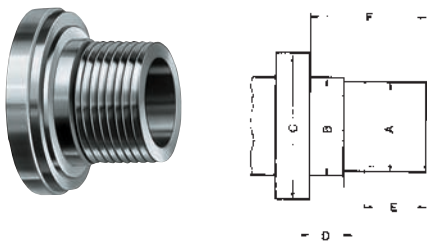

Mean tol. A	Bg5	Minimum C	D	E	F
M20	21	30	6,3	10	20
M24	25	36	8	12	24
M33	34	50	9	14	30
M39	40	56	10	16	35
M45	46	67	11	18	40
M52	55	80	12	20	45
M60	62	90	14	22	50
M76x6	78	112	16	30	63
M105x6	106	150	20	40	80

## DIN 55021

From taper size 4 with driver

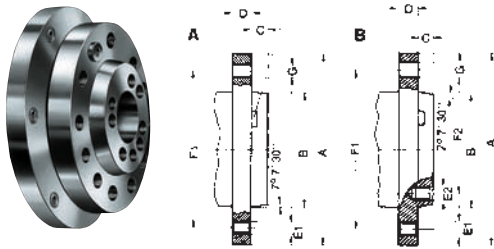

Spindle nose size					Holes on outer bolt circle (F1)		Outer bolt circle	Holes on inner bolt circle		Inner bolt circle
	A	B	C	D	E1	G	F1	(F2) E2	F2	
3	102	53,985	11	16	3xM10	3x10,5	75	-	-	
4	112	63,525	11	20	3xM10	3x10,5	85	-	-	
5	135	82,575	13	22	7xM10	4x10,5	104,8	8xM10	61,9	
6	170	106,390	14	25	7xM12	4x13	133,4	8xM12	82,6	
8	220	139,735	16	28	7xM16	4x17	171,4	8xM16	111,1	
11	290	196,885	18	35	12xM20	6x21	235	11xM20	165,1	
15	380	285,800	20	42	12xM24	6x25	330,2	11xM24	247,6	
20	520	412,800	21	48	12xM24	6x25	463,6	11xM24	368,3	

**Shape A:** Tapped holes and through-holes in flange (without inner bolt circle)

**Shape B:** Tapped holes and through-holes in flange (outer bolt circle) and tapped holes in inner bolt circle

## ISO 702-1 (DIN 55026)

From taper size 4 with driver

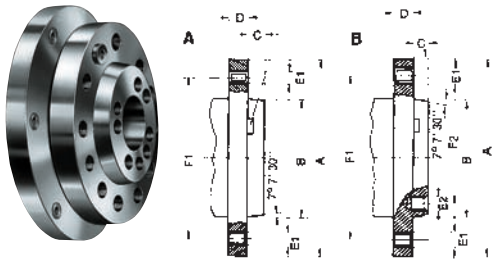

Spindle nose size					Holes on outer bolt circle		Outer bolt circle	Holes on inner bolt circle		Inner bolt circle
	A	B	C	C <sub>1</sub>	D	E1	F1	(F2) E2	F2	
3	92	53,983	11	-	16	3xM10	70,6	-	-	
4	108	63,521	11	-	20	11xM10	82,6	-	-	
5	133	82,573	13	14,288	22	11xM10	104,8	8xM10	61,9	
6	165	106,385	14	15,875	25	11xM12	133,4	8xM12	82,6	
8	210	139,731	16	17,462	28	11xM16	171,4	8xM16	111,1	
11	280	196,883	18	19,05	35	11xM20	235	8xM20	165,1	
15	380	285,791	19	20,638	42	12xM24	330,2	11xM24	247,6	
20	520	412,795	21	22,225	48	12xM24	463,6	11xM24	368,3	

**Shape A:** Tapped holes in flange (outer bolt circle) without inner bolt circle.

**Shape B:** Tapped holes in flange (outer bolt circle) and in inner bolt circle.

## ISO 702-3 (DIN 55027 und 55022)

With bayonet ring fixing (ISO 702/III)

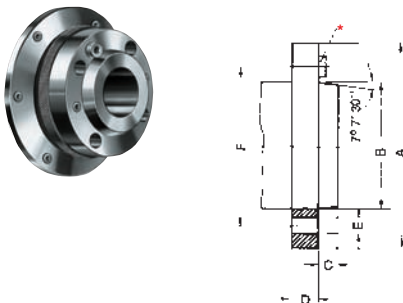

Spindle nose size	A	B	C	D	Number of holes x E	F
3	102	53,985	11	16	3x21	75
4	112	63,525	11	20	3x21	85
5	135	82,575	13	22	4x21	104,8
6	170	106,390	14	25	4x23	133,4
8	220	139,735	16	28	4x29	171,4
11	290	196,885	18	35	6x36	235
15	400	285,800	19	42	6x43	330,2
20	540	412,800	21	48	6x43	463,6

\* From taper size 4 with driver

# Machine spindle noses for DIN and ASA B 5.9

Machine spindle noses are not included in the scope of delivery!

ISO 702-2 (DIN 55029 and ASA B 5.9 D1)  
Camlock fixing (ISO 702-2)

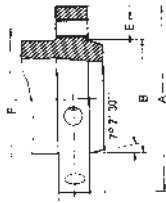

Typ A1-A2, B1-B2

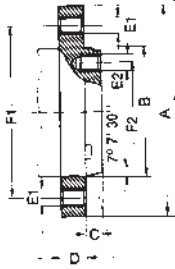

**A1:** Tapped holes in flange (outer bolt circle) and inner bolt circle. From taper size 4 with driver.

**A2:** Tapped holes in flange (outer bolt circle) without inner bolt circle.



**B1:** Through-holes in flange (outer bolt circle), tapped holes in inner bolt circle - from taper size 4 with driver.

**B2:** Through-holes in flange (outer bolt circle) without inner bolt circle.

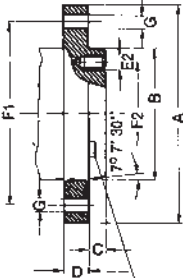

\* From taper size 4 with driver

Spindle nose size	A	B	C	D	E	F
3	92,1	53,985	11,1	31,8	3x15,1	70,66
4	117,5	63,525	11,1	33,3	3x16,7	82,55
5	146	82,575	12,7	38,1	6x19,8	104,8
6	181	106,390	14,3	44,5	6x23	133,4
8	225,4	139,735	15,9	50,8	6x26,2	171,4
11	298,5	196,885	17,5	60,3	6x31	235
15	403	285,800	19	69,9	6x35,7	330,2
20	546	412,800	21	82,5	6x42,1	463,6

Latest edition of relevant DIN standard applies in each case

Spindle nose size					Holes on outer bolt circle (F1)	Outer bolt circle	Holes on inner bolt circle (F2)	Inner bolt circle
	A	B	C <sub>-0,025</sub>	D	E1	F1	E2	F2

**A1 (corresponds ISO 702-1)**

5	133,4	82,575	14,288	22,2	11x 7/16-14 UNC	104,8	8x 7/16-14 UNC	61,9
6	165,1	106,390	15,875	25,4	11x 1/2-13 UNC	133,4	8x 1/2-13 UNC	82,6
8	209,5	139,735	17,462	28,6	11x 5/8-11 UNC	171,4	8x 5/8-11 UNC	111,1
11	279,4	196,885	19,05	34,9	11x 3/4-10 UNC	235	8x 3/4-10 UNC	165,1
15	381	285,800	20,638	41,3	12x 7/8-9 UNC	330,2	11x 7/8-9 UNC	247,6
20	520	412,800	22,225	47,6	12x 1-8 UNC	463,6	12x 1-8 UNC	368,3

Spindle nose size					Holes on outer bolt circle (F1)	Outer bolt circle
	A	B	C	D	E1	F1

**A2 (corresponds ISO 702-1)**

3	92,1	53,985	11,1	15,9	3x 7/16-14 UNC	70,66
4	108	63,525	11,1	19	11x 7/16-14 UNC	82,55
5	133,4	82,575	12,7	22,2	11x 7/16-14 UNC	104,8
6	165,1	106,390	14,3	25,4	11x 1/2-13 UNC	133,4
8	209,5	139,735	15,9	28,6	11x 5/8-11 UNC	171,4
11	279,4	196,885	17,5	34,9	11x 3/4-10 UNC	235
15	381	285,800	19	41,3	12x 7/8-9 UNC	330,2
20	520	412,800	20,6	47,6	12x 1-8 UNC	463,6

Spindle nose size					Outer bolt circle	Holes on inner bolt circle (F2)	Inner bolt circle
	A	B	C <sub>-0,025</sub>	D	F1 G	F1	E2

**B1**

5	133,4	82,575	14,288	22,2	11x11,9	104,8	8x 7/16-14 UNC	61,9
6	165,1	106,390	15,875	25,4	11x13,5	133,4	8x 1/2-13 UNC	82,6
8	209,5	139,735	17,462	28,6	11x16,7	171,4	8x 5/8-11 UNC	111,1
11	279,4	196,885	19,05	34,9	11x20,2	235	8x 3/4-10 UNC	165,1
15	381	285,800	20,638	41,3	12x23,4	330,2	11x 7/8-9 UNC	247,6
20	520	412,800	22,225	47,6	12x26,6	463,6	12x 1-8 UNC	368,3

Spindle nose size					Outer bolt circle
	A	B	C	D	G

**B2**

3	92,1	53,985	11,1	15,9	3x11,9	70,66
4	108	63,525	11,1	19	11x11,9	82,55
5	133,4	82,575	12,7	22,2	11x11,9	104,8
6	165,1	106,390	14,3	25,4	11x13,5	133,4
8	209,5	139,735	15,9	28,6	11x16,7	171,4
11	279,4	196,885	17,5	34,9	11x20,2	235
15	381	285,800	19	41,3	12x23,4	330,2
20	520	412,800	20,6	47,6	12x26,6	463,6

In each case the latest edition of ASA B 5.9 will apply