

Tailoring Carbide Dispersed Steels: *A Path to Increased Strength and Hydrogen Tolerance*

PI: Gregory B. Thompson

The University of Alabama

May 30, 2020

Project ID # IN022

This presentation does not contain any proprietary, confidential, or otherwise restricted information

Overview

Timeline

- Project Start Date: 01/07/2020
- Project End Date: 01/31/2023
- Cost extension request: None
- Percent completion: 8% (for 36 months)

Budget

- Total Project Budget: \$1,424,996.00
 - Total Recipient Share: \$375,027.00
 - Total Federal Share: \$1,049,969.00
 - Total DOE Funds Spent*: \$83,150.59

* As of 04/30/2020

Barriers

- Hydrogen embrittlement of steels results in a loss of strength and component failures in the field
- Carbides have been proposed to trap hydrogen, though the optimal carbide chemistry and trapping potentials are not realized.
- It is unclear if carbide traps, once saturated, can provide further protection or recycling of trapping through cyclic heating cycles.

Partners

- ❖ US Department of Energy (DOE)
- ❖ The University of Alabama (UA)
- ❖ Colorado State University (CSU)
- ❖ Exothermics, Inc.
- ❖ Ames Laboratory
- ❖ Army Research Laboratory
- ❖ Sandia National Laboratory (H-MAT)

Relevance

Project Objectives

Develop a new type of carbide dispersed austenitic/ferritic steel that can be used for hydrogen storage and dispensing businesses. Such tailored carbides enable...

- ✓ Better hydrogen tolerance than conventional steels
- ✓ Maintain 95% of the notched tensile strength after hydrogen charging
- ✓ Yield strengths above 1000 MPa
- ✓ Comparable or better fatigue strength
- ✓ Reduction of cost e.g. maintenance, replacement
- ✓ Establish a processing route for CDS steel

Objectives of the Reported Quarter

To perform initial carbide dispersed strengthened (CDS) steel development in YR1

- Calculation of the theoretical trap energy of hemicarbonides by Density Functional Theory (DFT)
- Customized gas atomized fabrication of Fe-7%Cr by Ames lab
- Acquiring transition metal carbides from vendors with characterization
- Initiate processing milling to disperse nanocarbonides in the iron-rich matrix

Relevance *continued...*

Targets & Milestones [Q1, M1-M3]

Task 1.0: Theoretical Trap Efficacy, M1-M6

- ✓ **Milestone 1.1.1** Determine of binding energy of hydrogen in carbide particles from simulations [M1-M4]
 - 65% completed.

Task 2.0: Small Scale CDS Synthesis, M1-M6

- ✓ **Milestone 2.1.1** Acquire the Fe-7Cr powder from Ames lab and carbide particles from commercial vendors. Quantify particle size, shape and composition [M1-M3]
 - 50% completed. Yet to receive powders from Ames (COVID-19 issue).
- ✓ **Milestone 2.2.1** Create high-energy ball mill powders to create dispersion for sintering fabrication [M3-M4]
 - 25% completed.
- ✓ **Milestone 2.3.1:** Create the first sintered CDS alloy [M4-M7]
 - 50% completed.

Notes: Though some milestones were not fully completed due to some limitation, some future milestones were started.

Approach

- DFT design to identify suitable TMCs H traps
- Synthesize nanoscale TMCs & hemicarbides
- Powder Processing
 - ✓ Ball mill carbides/metal mixture
- Fabricate CDS alloys
 - ✓ Press milled powders into pellets
 - ✓ Sinter/HIP powders for consolidation
- Testing & characterization
 - ✓ Hydrogen charging and testing at SNL
 - ✓ Atom probe to determine H trapping in CDS
 - ✓ Mechanical testing in pre/post H charged conditions
- Scaling up – moving from academic lab bench experiments to full scale powder mixing production for ASTM standard dimensions and mechanical testing.
- Development of a materials guide for CDS materials

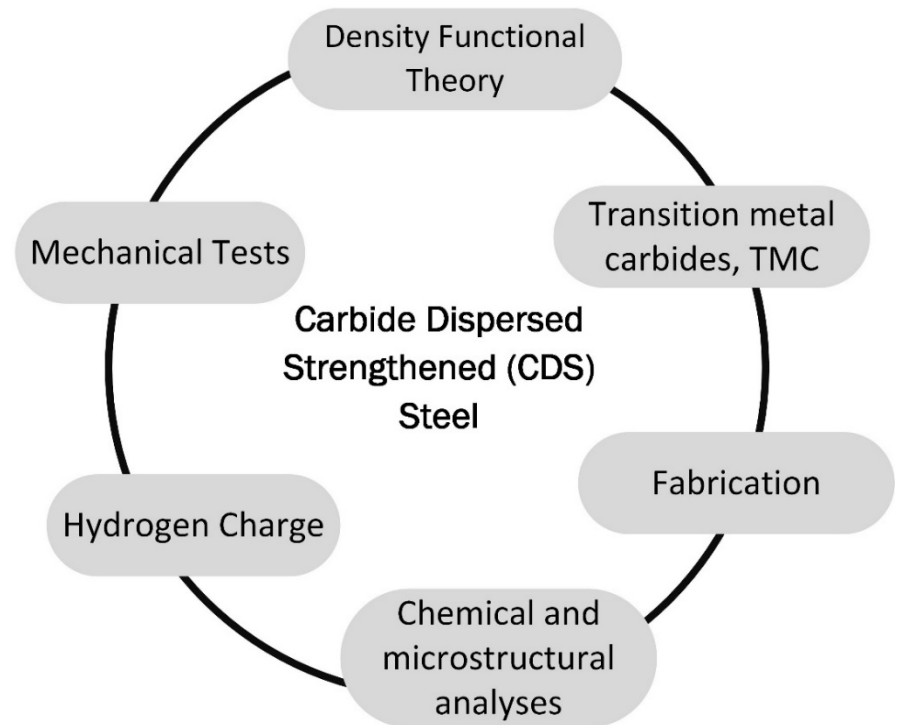

Approach: DFT Modeling

Density Functional Theory: Computing Hydrogen Binding Energy

Use DFT to lead to experiments to 'best' TMCs to use

Carbides can have multiple types of interstices in which to store hydrogen: Multiple Hydrogen Binding Sites

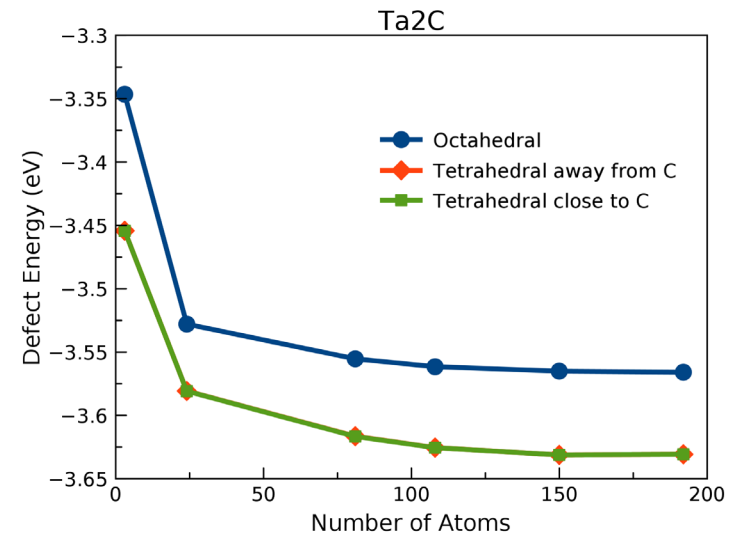
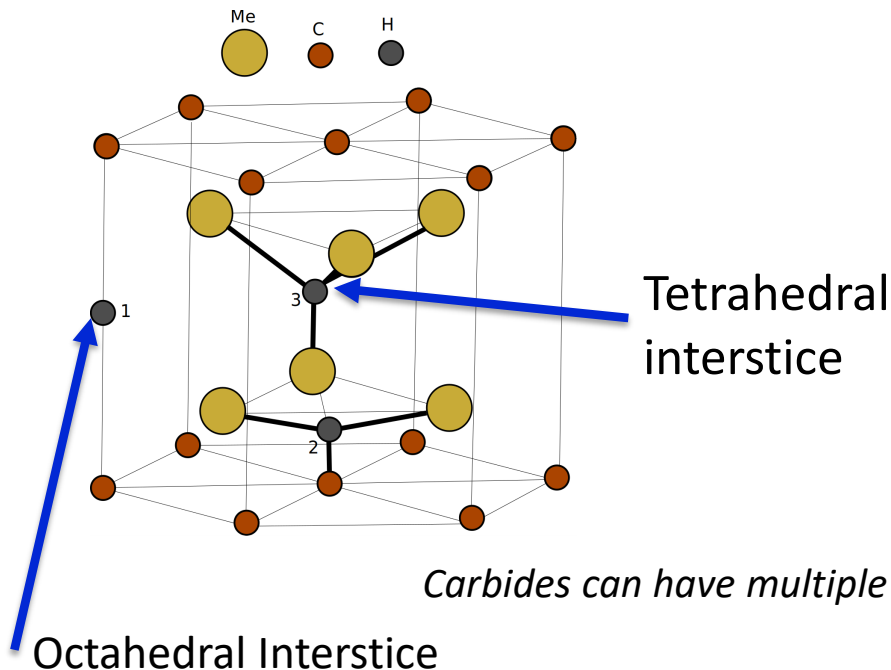

DFT can tell us about which sites are the most favorable for hydrogen binding

Approach: DFT Modeling *continued...*

Different Types of Transition Metal Carbides (TMCs)

Multiple carbides and structures – several opportunities yet explored

periodic table of the elements

1		2-10										11-18	
Alcalins		Transition Metals										not metals	
1 (K)	H											B	
2 (L)	Li	Be									B		
3 (M)	Na	Mg									Al		
4 (N)	K	Ca	Sc	Ti	V	Cr	Mn	Fe	Co	Ni	Cu	Zn	Ga
5 (O)	Rb	Sr	Y	Zr	Nb	Mo	Tc	Ru	Rh	Pd	Ag	Cd	In
6 (P)	Cs	Ba	Lu	Hf	Ta	W	Re	Os	Ir	Pt	Au	Hg	Tl

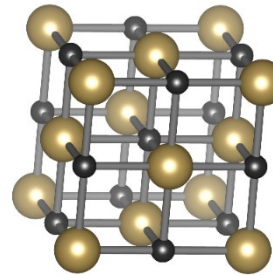

TaC, TiC, etc.

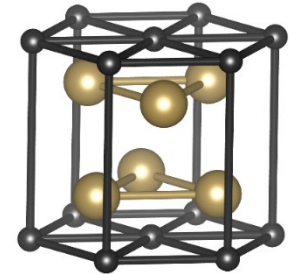

Ta₂C, W₂C

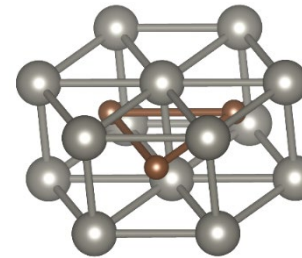

WC

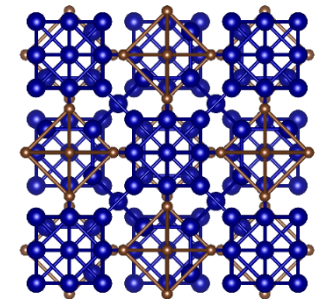

Cr₂₃C₆

Group IV, V and VI Transition Metal Carbides

Approach: Powder Metallurgy Processing

To achieve the tailored carbides in the matrix, the program will exploit powder metallurgy

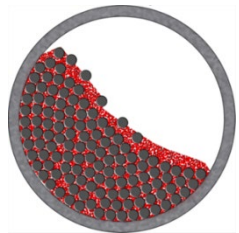

High-energy ball milling



Press powders

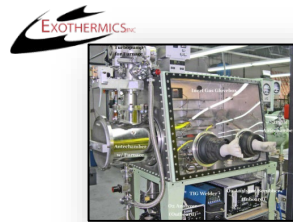

HIP processing

Characterization
+
Hydrogen charging
+
Mechanical testing

Scalability (YR2+YR3)



- *Exothermics* fabricates custom canisters
- ARL open campus has Zoz mill

Approach: TMCs

Commercial
(off-the-shelf)
TMCs

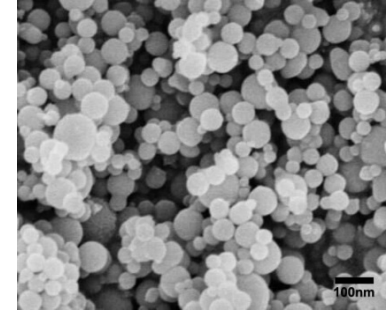

- + Readily available
- Not all TMCs, lead times

Coating of
powders

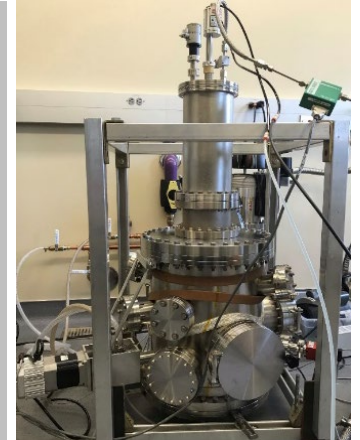
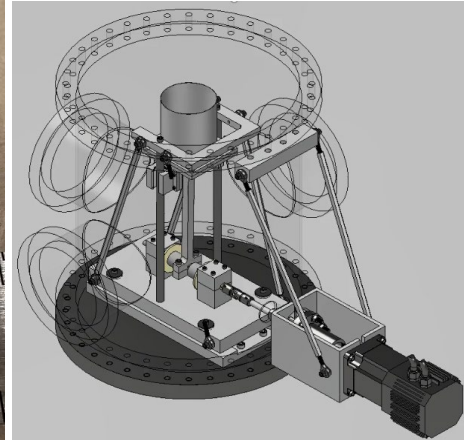
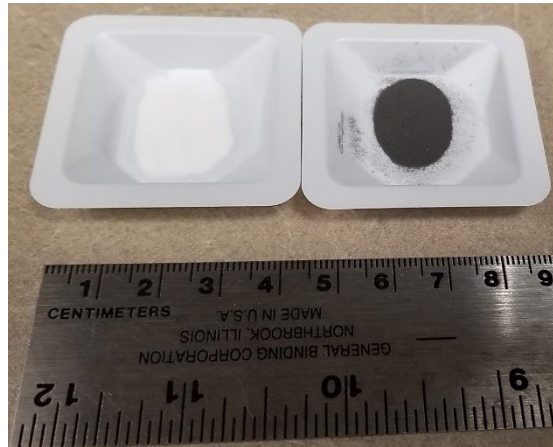

- + Can create needed TMCs
- Will need annealing to mix coating with TMCs

Approach: Custom Powders

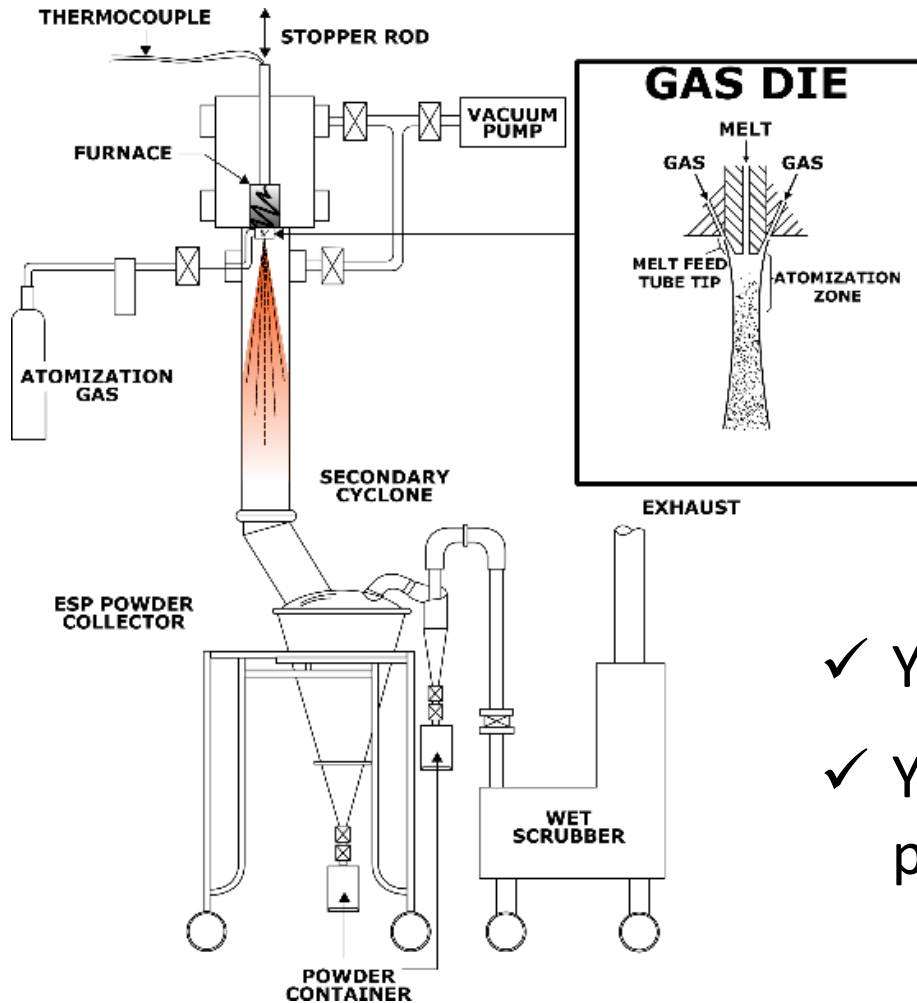

AMES Laboratory

Partners:

Iver Anderson

Trevor Riedemann

Emma White

- ✓ Yr 1: Composition optimization
- ✓ Yr 2 & Yr 3: Scale-up of powders for 'bulk' samples

Approach: Austenitic Fe Matrix

- FCC Fe has significantly slower hydrogen diffusivity (loss) than BCC Fe ... want P/M processed material in austenitic state
- First phase (Yr1): gas atomize Fe-7wt%Cr powders
 - ✓ 5 kg test batch
 - ✓ Largest γ phase field for HIP processing
- Second phase (Yr1): gas atomize new powder
 - 5 kg test batch
 - Adjust Cr composition
- Yr2 + Yr3 ... scale-up powder (25 kg/yr) for larger specimens

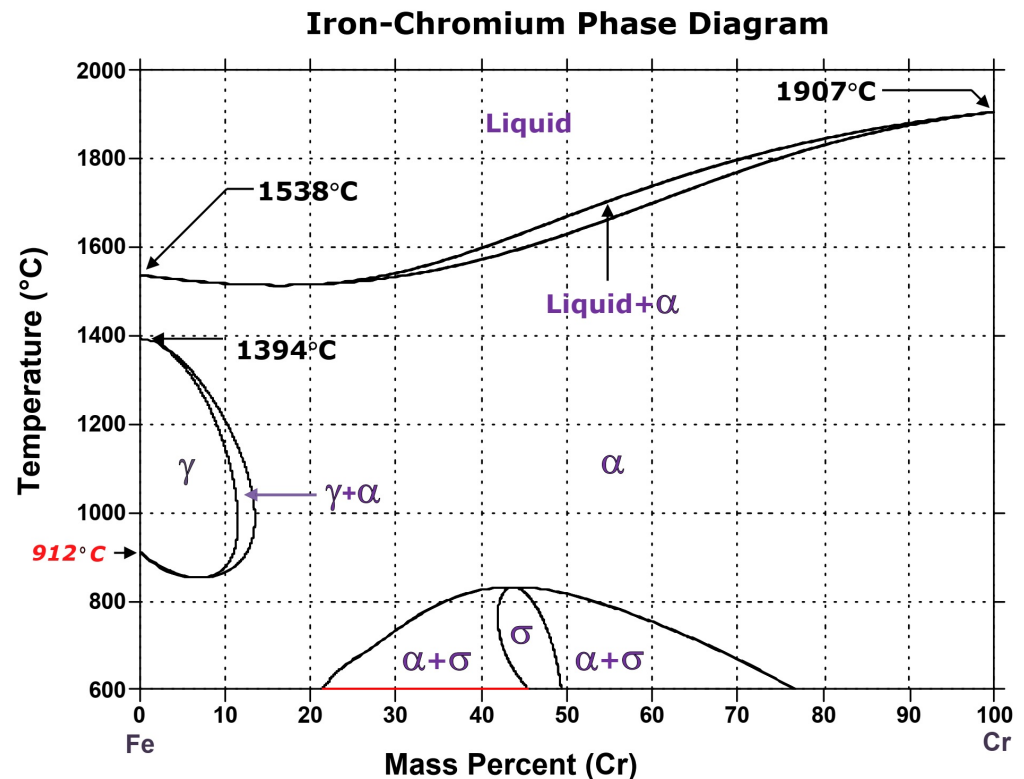

Approach: Testing the Hypothesis

Hydrogen Charging & Atom Probe Tomography

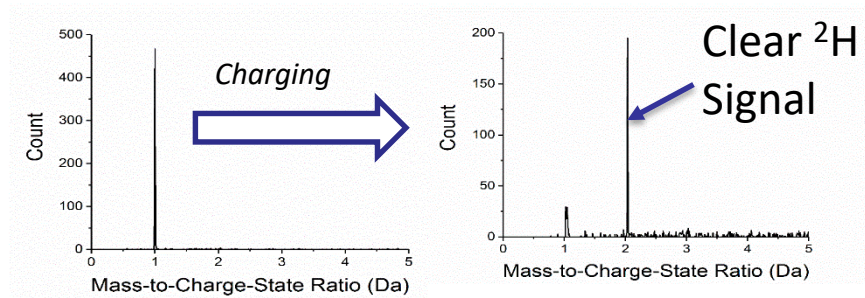
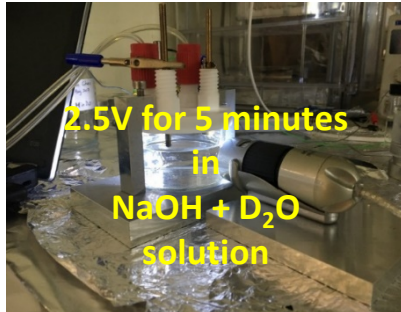

- Electro-charging samples
- Cryo-transfer to mitigate hydrogen loss
- Characterize in the atom probe

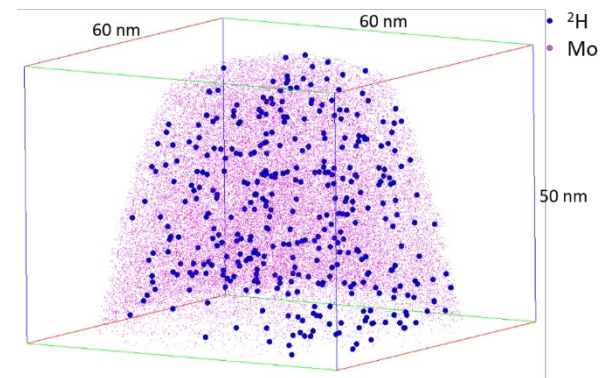

Synergistic work (for NASA by Thompson) in Mo metal; ²H was captured in solution post-charging.

Approach: Mechanical Testing



Conventional indentation



Micro-tensile testing

- Pre/post charging comparison
- Indentation (Tabor's rule: $\sigma = \frac{H_v}{3}$) for “baby billets” (Yr1-3)
- Micro-tensile testing for “baby billets” (Yr1-3)
- Fatigue crack growth testing (ASTM E647) – full scale samples (Yr2-3)
- Collaborate with SNL on unique in situ hydrogen mechanical testing capabilities

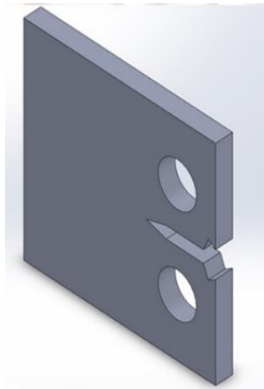
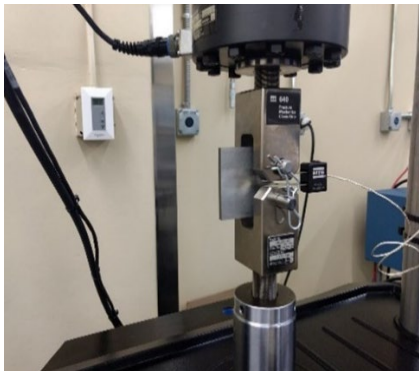

Fatigue crack testing

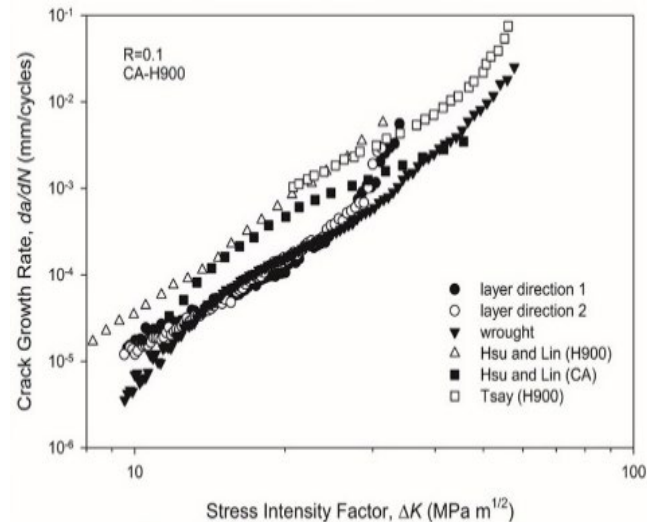

Approach: Timelines of the Project Milestones

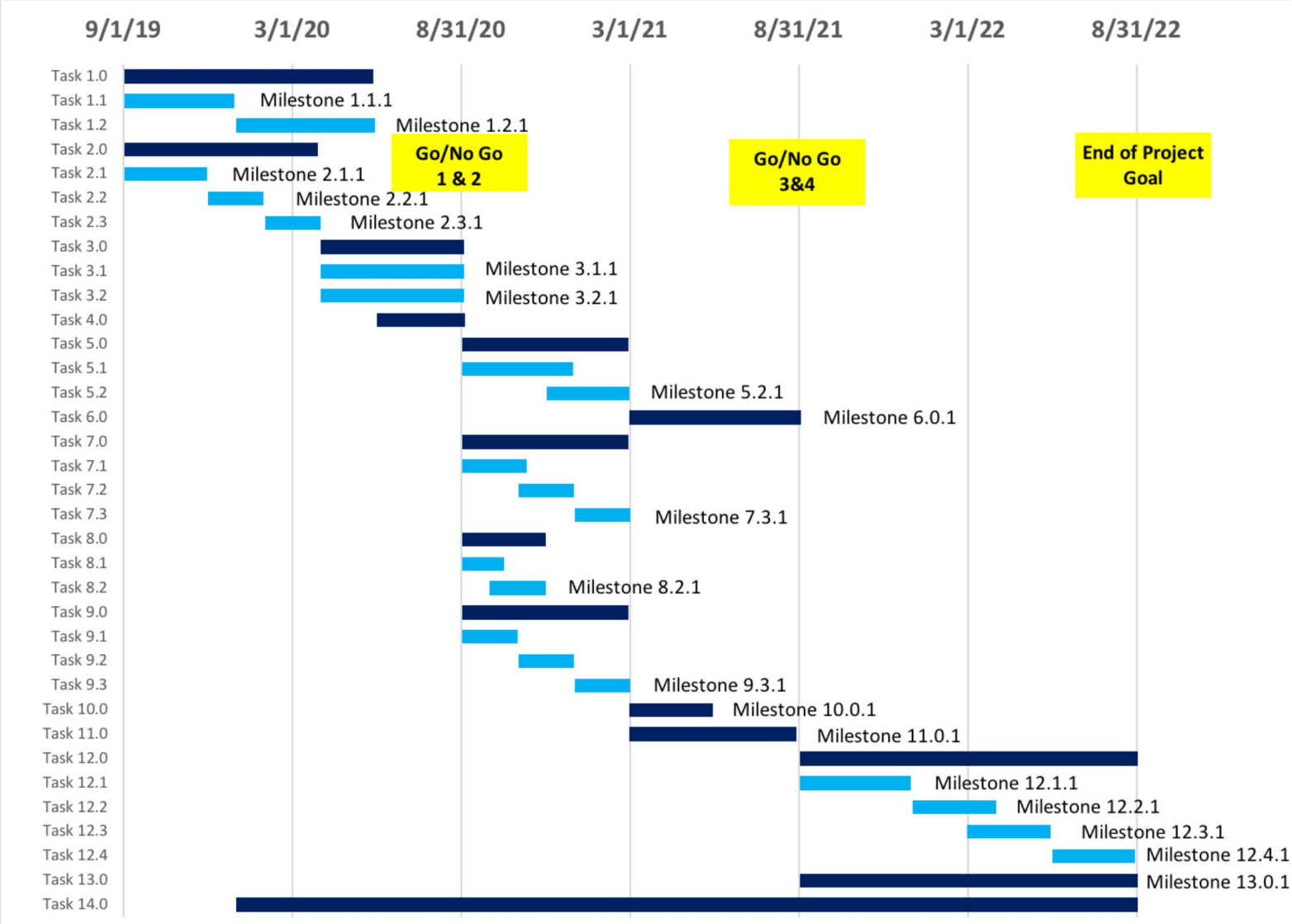

Approach: List of the Project Milestones

Y1Q1: Acquire the Fe-XCr powder from Ames Lab; acquire carbide particles from the commercial vendor; determine particle size, shape, composition, and phase

Y1Q2: Calculation of binding energy of hydrogen in carbide particles. High-energy ball mill powders to create dispersion for sintering fabrication.

Y1Q3: Calculation of the activation energy of hydrogen in carbide particles. Determine the microstructural characteristics (grain size, particle size, particle distribution) of the initial synthesized CDS material.

Y1Q4: Micro-mechanical test the CDS alloy for mechanical property evaluation. Complete hydrogen charging at M-HAT of small-scale CDS alloy.

Y2Q1 Mechanical Test the initial CDS hydrogen charged alloys.

Y2Q2 Determine the thermodynamic stability metal-rich carbide particles in austenite. Experimentally determine the location of hydrogen in metal-rich carbides. Synthesize large scale CDS alloys for fatigue testing.

Y2Q3 Establish the binding energy of hydrogen to carbide particle interfaces. Hydrogen charge large scale CDS samples. Theoretically determine the interface binding energies of metal-rich carbides.

Y2Q4 Determine fatigue strength of hydrogen charged CDS.

Y3Q1: Predict the optimal CDS material for hydrogen tolerance.

Y3Q2: Synthesize new optimized CDS materials from Y3Q1, including attrition milling at ARL and HIP at Exothermics.

Y3Q3: Charge optimized CDS samples with hydrogen at H-MAT (from Y3Q2) and evaluate the mechanical properties.

Y3Q4: Create design guide for hydrogen tolerant steels.

Go/No-Go Decision Points

- The first Go/No-Go decision point is based on (1) demonstrating the efficacy of hydrogen trapping in metal rich particles (2) and demonstrating of our ability to synthesize the CDS alloy.
- The second year Go/No-Go point will be established by the as-determined trapping energy and mechanical properties of a larger scale CDS that has been charged at H-Mat

Approach: Unique Aspects

As the research activities and evaluation continue, some unique approaches and routes will be designed and determined. Some of the projected unique aspects are-

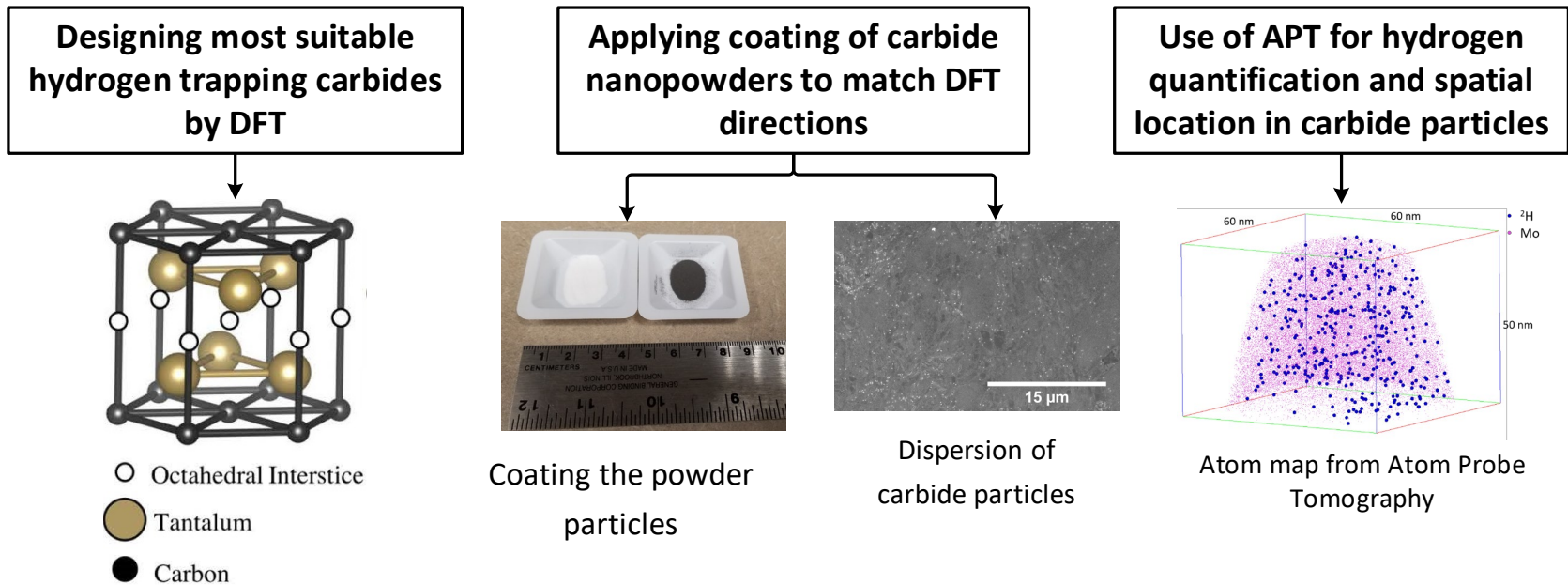

Accomplishments and Progress

Since this is a new project started January 2020, this section is discussed based on Q1 (M1-M3) research and activities

- ✓ Coordination and work distribution among teams and partners initiated
- ✓ Laboratory equipment for the project ordered and being set up
- ✓ Collecting some necessary commercial powders from vendors
- ✓ DFT modeling for TMCs and hemicarbides
- ✓ Initial powder processing/mixing procedures established
- ✓ Small scale CDS synthesis pilot experiments underway to determine dispersion of carbides

Accomplishments and Progress

Current Survey of Hydrogen Defect Energy

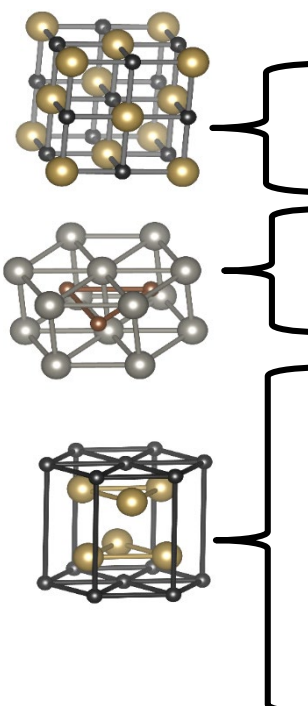

Material	Site	Defect Energy (eV)
TaC	Tetrahedral	-1.0
TiC	Tetrahedral	-2.0
WC	Octahedral	-2.7
WC	Tetrahedral	-1.1
Ta ₂ C	Octahedral	-3.6
Ta ₂ C	Tetrahedral	-3.6
W ₂ C	Octahedral	-2.6
W ₂ C	Tetrahedral	-2.5
Ti ₂ C	Octahedral	-4.2

$$\text{Defect Energy} = E(\text{Me}_x\text{C,H}) - E(\text{Me}_x\text{C})$$

Note: Energies are for comparative purposes only

Accomplishments and Progress

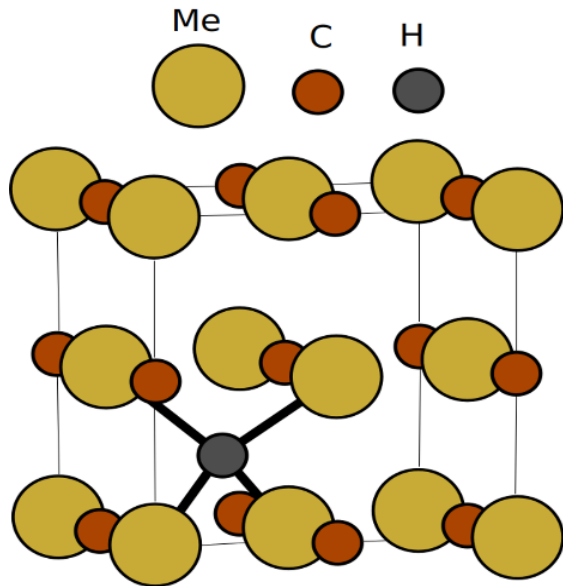

B1 crystal structure of Metal Monocarbide, MeC, with Hydrogen, H, as a defect in the Tetrahedral interstice

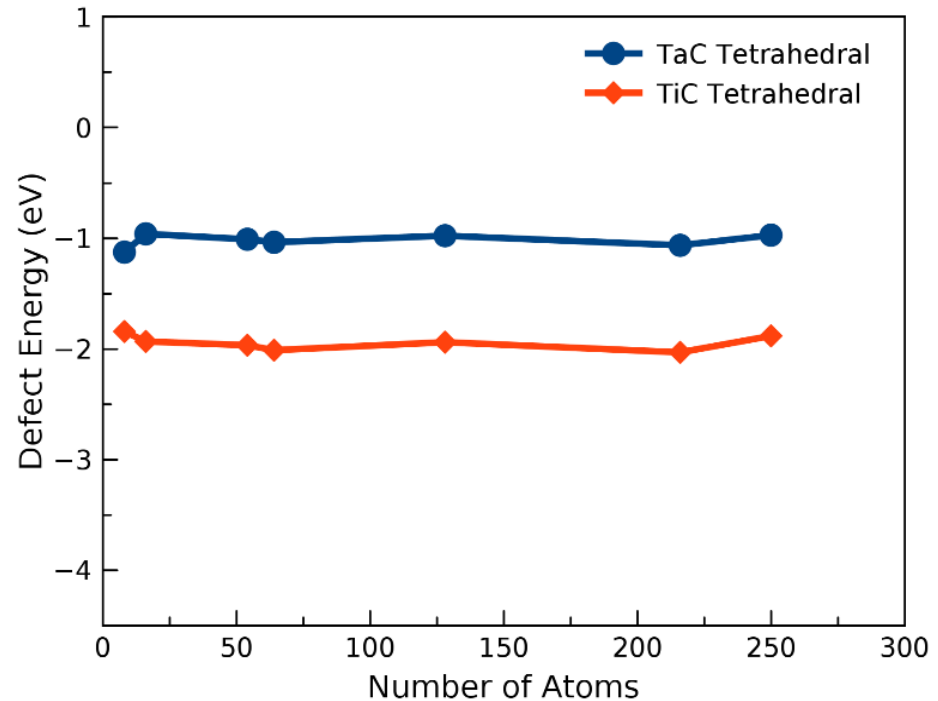

Convergence study of TiC and TaC with Hydrogen in the Tetrahedral interstices for different sized simulation cell of B1 crystal structure.

- Lower defect energy is more favorable hydrogen trapping.

Accomplishments and Progress

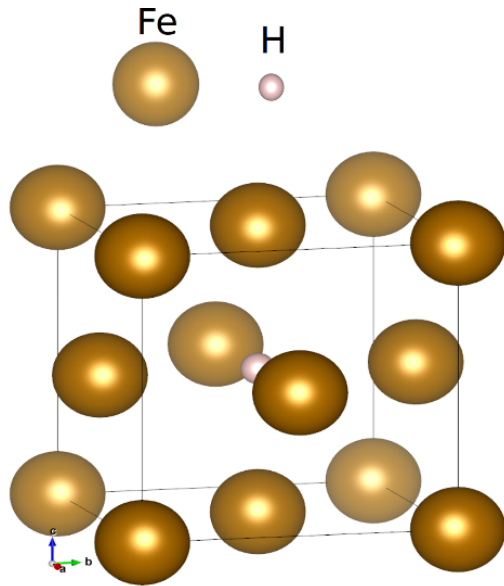

(a)

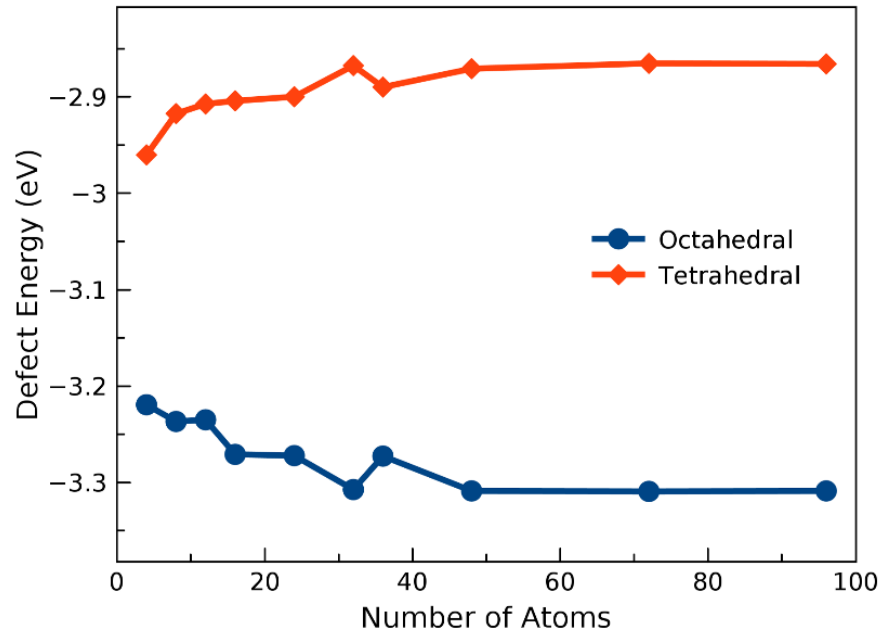

(b)

(a) FCC crystal structure of Iron, Fe, with Hydrogen, H, as a defect in the Octahedral interstice.
(b) Convergence study of Fe with H in the Octahedral and Tetrahedral interstices for different sized simulation cell of FCC crystal structure.

Octahedral interstices with lower defect energy will be more favorable for hydrogen trapping.

Accomplishments and Progress

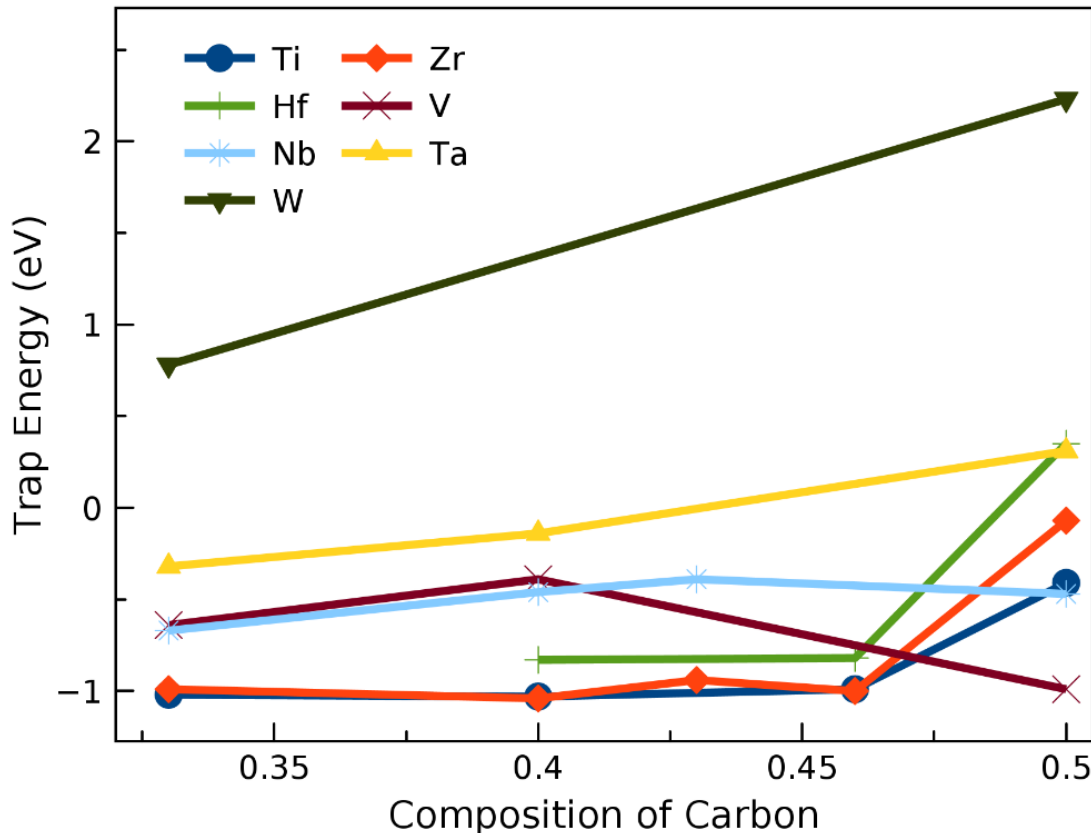

- ✓ Theoretical Trap Energy of Hydrogen in group IVB, VB and VIB carbides with respect to composition of Carbon in different crystal structures
- ✓ Group IV showed lower trap energies
- ✓ But some other TMCs may have lower trap energy at higher carbon composition

Accomplishments and Progress

Trap Energy

- ✓ Trap Energy of Hydrogen in different Metal carbides and their derivatives.
- ✓ This can provide us ideas about what TMCs and their derivative should be targeted.

Nomenclature:

Octa- Hydrogen at Octahedral Interstices.

Tetra- Hydrogen at Tetrahedral Interstices.

Swap C with H- One carbon atom at Octahedral Position is removed and Hydrogen atom is placed there.

Tetra away- Hydrogen is placed at a Tetrahedral where the nearest carbon sublattice is vacant.

Tetra close- Hydrogen is placed at a Tetrahedral where the nearest carbon sublattice is NOT vacant.

E_b Octahedral Fe FCC- Binding Energy/ Trap Energy is calculated from the reference of Hydrogen at the Octahedral interstice of FCC Iron.

Carbide Name	Space Group	Number of atoms in the converged supercell		E_{trap} (eV)
TiC	Fm-3m	64	Swap C with H	-0.41
ZrC	Fm-3m	64	Swap C with H	-0.07
HfC	Fm-3m	64	Swap C with H	0.35
VC	Fm-3m	64	Swap C with H	-0.99
NbC	Fm-3m	64	Swap C with H	-0.47
TaC	Fm-3m	64	Swap C with H	0.31
WC	P-6m2	54	Octa	0.62
Mo2C	Pbcn	72	Tetra	1.19
Ti7C6	R-3	78	Octa	-0.99
Zr7C6	R-3	78	Octa	-1.00
Hf7C6	R-3	78	Octa	-0.82
V2C	P-3m1	150	Octa	-0.64
Nb2C	P-3m1	150	Tetra away	-0.67
Ta2C	P-3m1	150	Tetra away	-0.32
Ti2C	Fd-3m	48	Tetra away	-1.02
Zr2C	Fd-3m	48	Tetra away	-0.99
W2C	P-3m1	108	Octa	0.75
Mo2C	P6 ₃ /mmc	72	Octa	0.07
V2C	Pnma	72	Octa	-0.58
V2C	Pbcn	96	Octa	-0.60
V2C	Pnnm	72	Octa	-0.51
Nb2	Pnma	72	Octa	-0.58
Nb2C	Pbcn	96	Octa	-0.63
Nb2C	Pnnm	72	Octa	-0.51
Ta2C	Pnma	72	Octa	-0.24
Ta2C	Pbcn	96	Octa	-0.41
Ti3C2	C2/m	60	Octa	-1.03
Zr3C2	C2/m	60	Octa	-1.04
Hf3C2	C2/m	60	Octa	-0.83
V3C2	C2/m	80	Tetra away	-0.39
Nb3C2	C2/m	80	Tetra away	-0.46
Ta3C2	C2/m	80	Tetra away	-0.14
Zr4C3	C2/c	84	Octa	-0.94
Nb4C3	C2/c	84	Octa	-0.39

Accomplishments and Progress *continued...*

Preliminary Studies & Results

Spherical Fe particles of 6-10 μm before ball milling

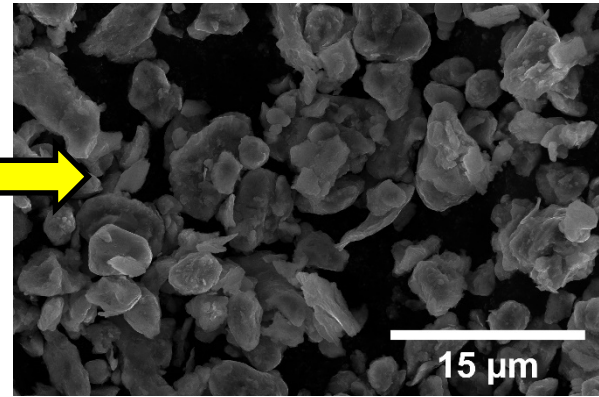
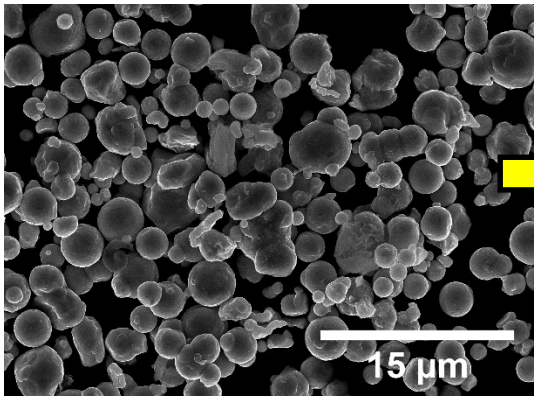

Changes in size and shape after ball milling

- Ball milling for 30', 60' and 90' was able to change the shape and reduce the sizes
- Initial ball milling of ZrC+Fe showed no shifting of Fe peaks

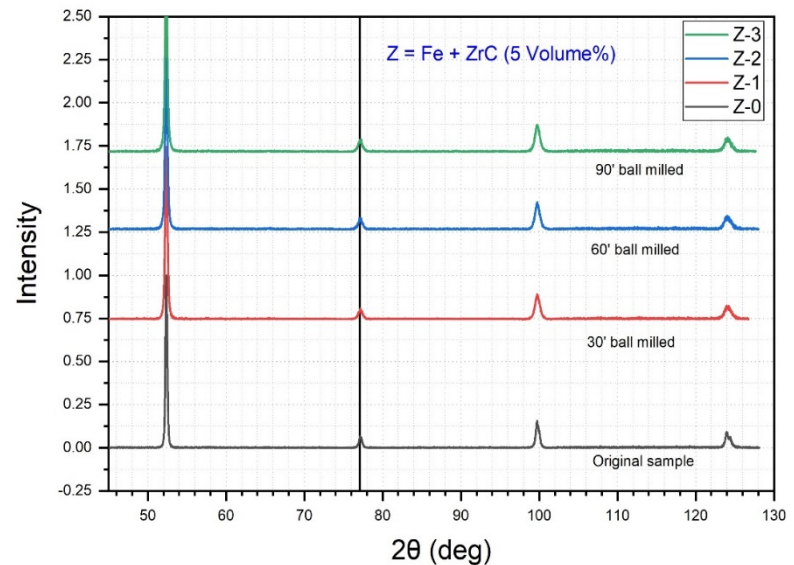

X-ray diffraction patterns

Accomplishments and Progress *continued...*

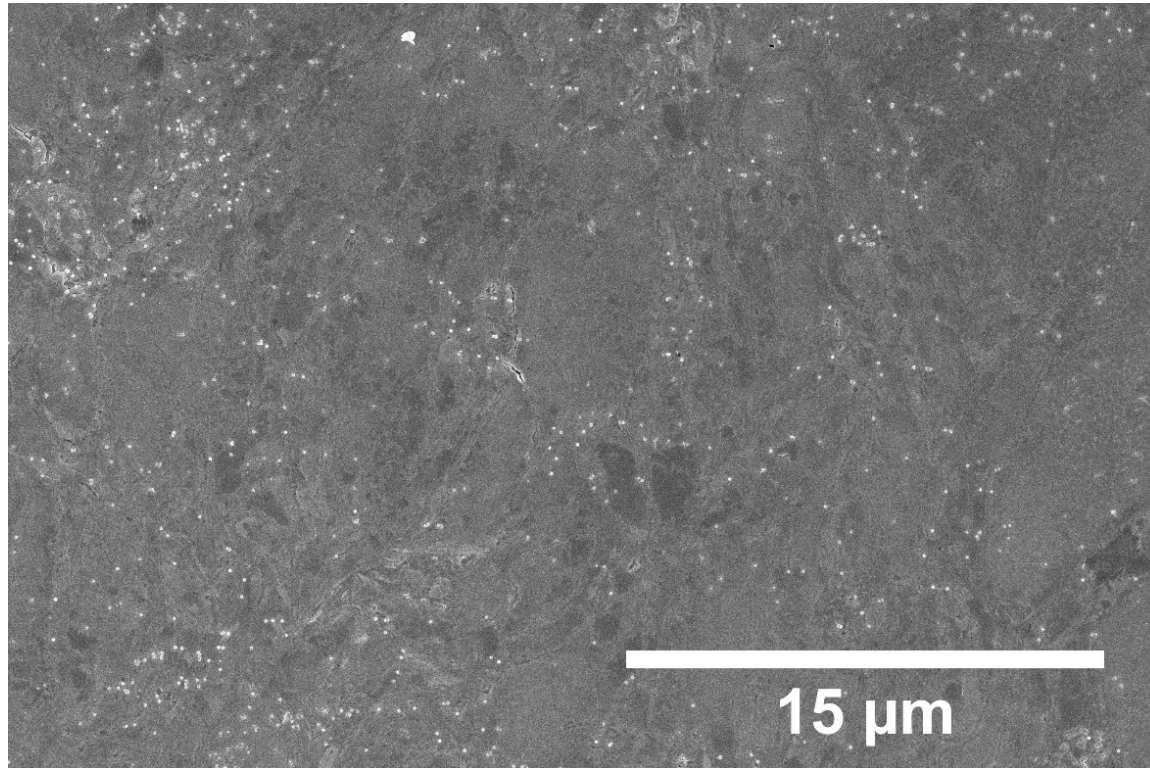

- Sintered under vacuum-glass encapsulation (mitigate oxidation)
- Bright spots reveal the dispersion of ZrC particles in Fe
- Further experiments of sintering under vacuum underway to determine optimal mixing conditions to yield an uniform dispersion of carbides in the matrix

Collaboration and Coordination

Partner	Project Roles
US Department of Energy (DOE)	Project sponsorship and funding
The University of Alabama	20% Cost share Project research activities, management & reporting Experimental fabrication, characterization, and mechanical testing
Colorado State University	20% cost share DFT modeling, reporting
Exothermics, Inc	HIP fabrication
Ames Laboratory	Gas atomization of alloyed powders
Army Research Laboratory	Scaled up powder processing
Sandia National Laboratory (H-MAT)	Hydrogen charging of CDS alloys/mechanical testing

Remaining Challenges and Barriers

Challenges and Barriers

- Issues created by COVID-19 has reduced on-campus laboratory access for both UA and Ames Lab partners
- Determining all the unique octahedral and tetrahedral hydrogen trapping interstices in each crystal structure and locating favorable meta-stable positions.
- There are potential issues where quantum tunneling effects will alter the calculation of the migration energy barrier of the Hydrogen atom in DFT.
- Dispersing carbides inside the grains rather than within the grain boundaries.
- Promoting sub-stoichiometric metal carbides (reduction of carbon content) forming reactions by creating favorable environment and conditions.

Remaining Challenges and Barriers

Planned Solutions

- Employing adequate efforts and research on DFT simulation and modeling.
- Repeating and verifying DFT to avoid or minimize quantum tunneling effect contributions to computed outcomes.
- Increase milling time/milling energy for uniform distribution of carbides/sinter at higher temperatures under vacuum.
- Performing HIP under vacuum or favorable gas mixture to promote intended reactions.

Proposed Future Work

Remainder of FY 2020

- Initial CDS development [Budget Year-1, 2020]
 - Identifying suitable TMCs by estimating theoretical trap efficacy [M1-M6, 65% completed] and migration barriers [M4-M9] with DFT simulation
 - Small scale CDS synthesis by applying DFT guidelines
 - Acquiring powders from AMES lab [M1-M7, 50%]
 - Powder processing with selected TMCs [M1-M4, 25%]
 - Initial CDS sintering and HIP synthesis [M4-M7, 25%]
 - Initial determination of Microstructural characteristics & Micro-mechanical tests [M7-M12]
 - Initial hydrogen charging by H-MAT [M9-M12]
 - Go/No-Go decision at the point of budget year 1

Any proposed future work is subject to change based on funding levels.

Proposed Future Work

FY 2021 [Budget Year 2]

- Develop microstructural relationships between strength, ductility and fatigue strength for the new CDS alloys.
- Determine the method of hydrogen trapping in these materials, either in the carbide particles or in the interface.

FY 2022 [Budget Year 3]

- Optimize the steels for strength and ductility retention in hydrogen environment.
- Benchmark the strength, ductility and fatigue strength properties of these materials before and after hydrogen charging.

Any proposed future work is subject to change based on funding levels.

Technology Transfer Activities

- UA/CSU is engaging multiple industries involved in steel manufacturing (e.g. Timken, Nucor, Arcelor Mittal) sharing outcomes of the program. Recognizing that powder metallurgy process is not directly applicable, the results are lending new concepts to use of tailored carbides in steels.
- UA/CSU is pursuing engagement with end-users (e.g. Exxon, Praxair) for commercial viability of CDS in their product lines.
- UA/CSU is leveraging government laboratories (Sandia National Lab, Army Research Lab) for process development and intellectual transfer opportunities of research outcomes and new commercial contacts.
- UA/CSU will leverage interaction of H-Mat consortium to disseminate findings and engage in partnerships with its members.
- As the program develops, UA will engage the Office for Innovation and Commercialization.

Summary

- ✓ **Goal:** To develop a new type of steel with tailored carbide dispersed strengthened (CDS) components that trap hydrogen.
- ✓ **Relevance:** CDS is proposed to provide stronger and more durable properties against hydrogen exposure.
- ✓ **Approach:** DFT → TMCs synthesis → Powder milling and mixing → Hydrogen/charging trapping → Characterization → Mechanical testing & evaluation.
- ✓ **Accomplishment (Q1):** Identified suitable hydrogen trapping TMCs by DFT modeling (convergence study, trap energy) and initial powder processing procedures for dispersion of TMCs in iron matrix being developed.
- ✓ **Collaborations:** A team with expertise in diverse fields are involved to conduct the project: US DOE, UA, CSU, Exothermics Inc., Ames lab, ARL, and Sandia National Laboratories.

Questions?

Contact us by email:

Gregory B. Thompson

Gthompson@eng.ua.edu