

# SMART TRACK PEDALBOARD

Take care of them with our new fastener system!

Patent Pending



# SMART TRACK PEDALBOARD

*Imagine you could add, remove or relocate your pedals in a quick, clean and easy way.*

This is exactly what the new Fastener attaching system of the Smart Track pedalboard offers. Keep your pedals intact from day one!

With its aluminium structure, Smart Track is a light and tough pedalboard which will be easy to carry around thanks to the soft-cases designed to fit each model. Its modular design is specially designed to adapt to any musician's needs.

Upper side wiring makes configuration changes immediate and its adjustable rear legs will allow you to adapt to uneven stages.

If for some reason you wish to go back to velcro you just have to flip the pedalboard over and that's it!



<https://www.youtube.com/watch?v=XEZfC0gxXNg>

## PEDAL FASTENER SYSTEM

Quick, easy and clean

## EASY SET UP

Attach and configure pedals quickly

## MODULAR DESIGN

Expand or reduce according to user needs

## REVERSIBLE PEDALBOARD

Flip your pedalboard and turn it into Evo Track

## ADJUSTABLE LEGS

Greater stability

## LIGHT WEIGHT

Anodized aluminum structure



# FASTENER SYSTEM

The new fastener system will allow you to keep your pedals fixed and clean like the first day.

A system that will fix your pedals in a quick and easy way, allowing you to place and remove them as many times as necessary with only a screwdriver gesture. Made of plastic, they have been specially designed to adapt the vast majority of pedals in the market, easing any kind of setup.

①

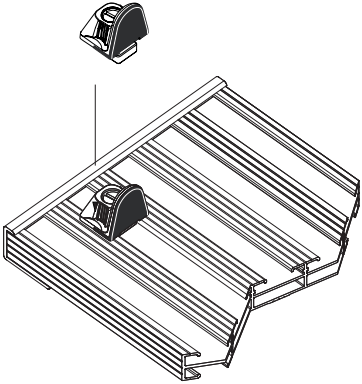

②

**FASTENERS**  
(for regular pedals)

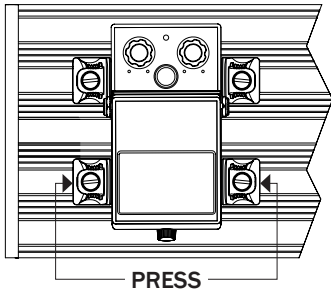

**360° FASTENERS**  
(for any kind of pedals)

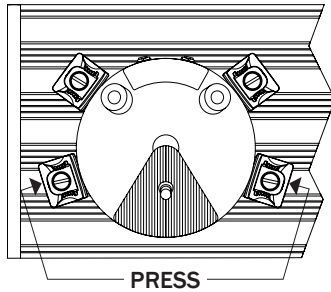

③

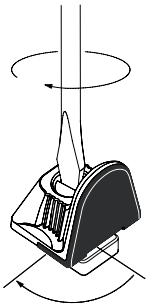

# SMART TRACK MODELS



## XS1

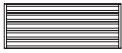

DIMENSIONS  
42 x 15 cm (16.5" x 5.9")

WEIGHT  
0,8 kg (1.8 lbs)

ADJUSTABLE LEGS  
No

PEDALS  
3 - 4

FASTENERS  
x12

COLOR\*  
Black



## XS2

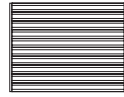

DIMENSIONS  
42 x 30 cm (16.5" x 11.8")

WEIGHT  
1,9 kg (4.2 lbs)

ADJUSTABLE LEGS  
1,5 cm (0.6")

PEDALS  
5 - 7

FASTENERS  
x24

COLOR\*  
Black



## S1

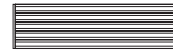

DIMENSIONS  
59 x 15 cm (23.2" x 5.9")

WEIGHT  
1,3 kg (2.9 lbs)

ADJUSTABLE LEGS  
1,5 cm (0.6")

PEDALS  
4 - 5

FASTENERS  
x20

COLOR\*  
Black



## S2

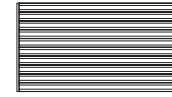

DIMENSIONS  
59 x 30 cm (23.2" x 11.8")

WEIGHT  
2,5 kg (5.5 lbs)

ADJUSTABLE LEGS  
1,5 cm (0.6")

PEDALS  
8 - 10

FASTENERS  
x40

COLOR\*  
Black



## L2

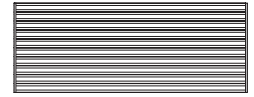

DIMENSIONS  
83 x 30 cm (32.7" x 11.8")

WEIGHT  
3,4 kg (7.5 lbs)

ADJUSTABLE LEGS  
1,5 cm (0.6")

PEDALS  
10 - 14

FASTENERS  
x56

COLOR\*  
Black

# MODULAR DESIGN

Expand or reduce according to user needs

## ST EXTENSION XS

If you need to upgrade your Smart Track XS1 to a Smart Track XS2 because your pedal collection keeps growing, you no longer need to buy a new pedalboard!

Smart Track extension kits will always allow you to adapt the pedalboard to your needs.



## ST EXTENSION S

From Smart Track S1 to Smart Track S2. Increase or reduce your pedalboard depending on the setup you use in each scene!

Smart Track extensions are the ideal solution for those who enjoy improvising and exploring alternatives!



# CUSTOMIZE YOUR PEDALBOARD!

## SMART & EVO TRACK PEDALBOARD ACCESSORIES

*The ultimate modular system pedalboards that, together with their accessories, will open an endless range of combinations and possibilities.*

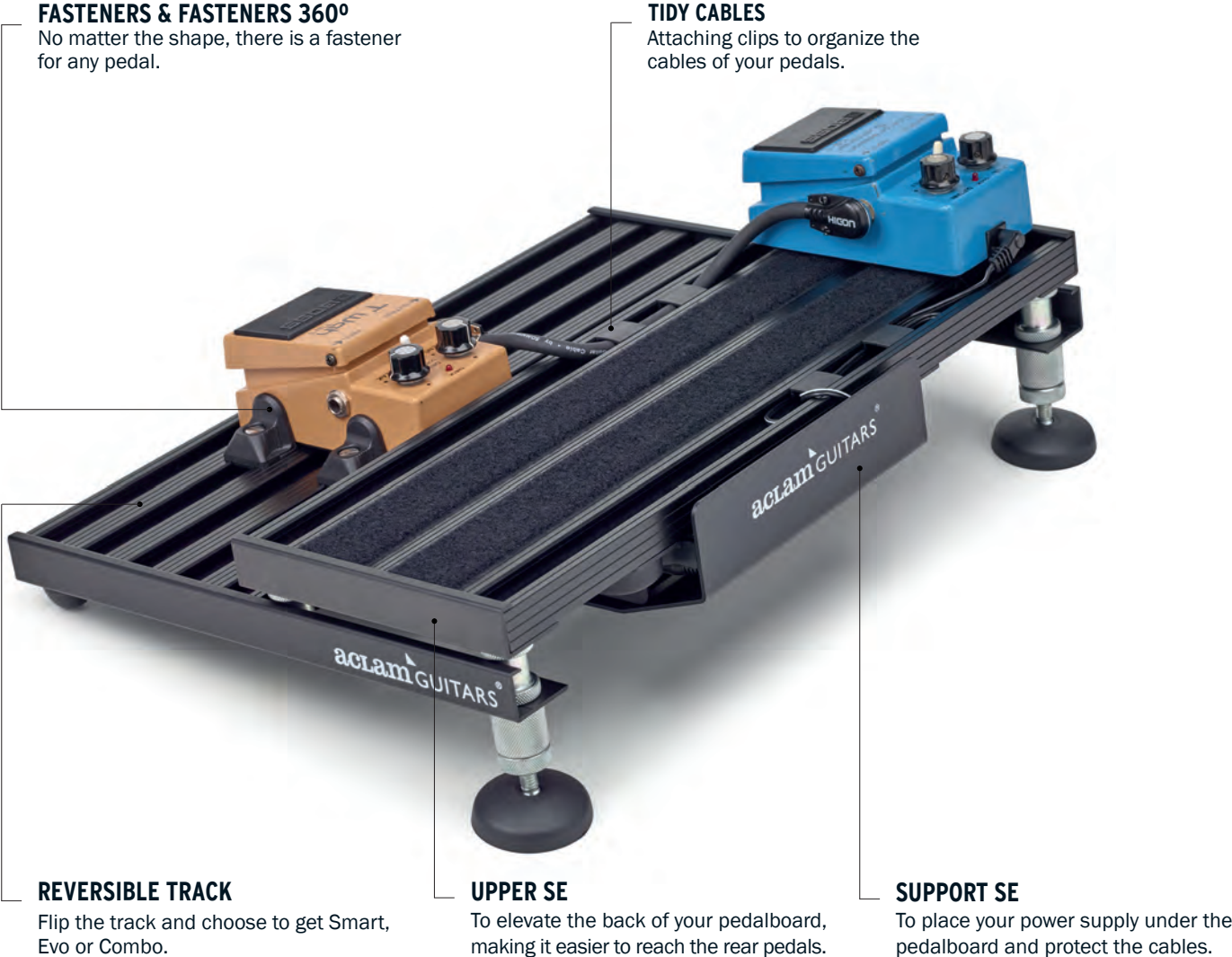

**FASTENERS & FASTENERS 360°**  
No matter the shape, there is a fastener for any pedal.

**TIDY CABLES**  
Attaching clips to organize the cables of your pedals.

**REVERSIBLE TRACK**  
Flip the track and choose to get Smart, Evo or Combo.

**UPPER SE**  
To elevate the back of your pedalboard, making it easier to reach the rear pedals.

**SUPPORT SE**  
To place your power supply under the pedalboard and protect the cables.



FEEL  
THINK  
PLAY

At Aclam Guitars we design and manufacture guitars and accessories for guitars, in our constant quest to reach the highest quality, functionality and innovation in all our products. Our passion for music and innovation, set our goal of constantly rethinking music equipment and accessories.

#### HEADQUARTERS

C/ Consell de Cent, 201  
08011 Barcelona, Spain

#### CONTACT

[guitars@aclam.cat](mailto:guitars@aclam.cat)  
00 34 931 701 767



# EVO TRACK PEDALBOARD

The modular pedalboard that is easy to resize!

Patent Pending





# EVO TRACK PEDALBOARD

*Imagine you could extend or reduce the pedalboard's size without the need of buying a new one.*

This is exactly what our new modular system for Evo Track proposes. An updated design of the classic Velcro® pedalboard!

With its anodized aluminum structure, Evo Track is a light and tough pedalboard which will be easy to carry around thanks to the soft cases designed to fit each model.

Upper side wiring makes configuration changes immediate without the need of flipping the pedalboard over, and its adjustable rear legs will allow you to adapt to uneven stages.

What if you get bored of Velcro® and want to go one step further? Flip the board over and transform it into a fastener pedalboard so you can keep your pedals intact as if they were new!



<https://www.youtube.com/watch?v=YznRDwruN7I>

## MODULAR SYSTEM

Expand or reduce according to user needs

## EASY SET UP

Attach and configure pedals quickly

## LIGHT WEIGHT

Anodized aluminum structure

## REVERSIBLE PEDALBOARD

Flip your pedalboard and turn it into Smart Track

## ADJUSTABLE LEGS

Greater stability



# EVO TRACK MODELS



## XS1



DIMENSIONS  
42 x 15 cm (16.5" x 5.9")

WEIGHT  
0,8 kg (1.8 lbs)

ADJUSTABLE LEGS  
No

PEDALS  
3 - 4

COLOR\*  
Black

## XS2



DIMENSIONS  
42 x 30 cm (16.5" x 11.8")

WEIGHT  
1,9 kg (4.2 lbs)

ADJUSTABLE LEGS  
1,5 cm (0.6")

PEDALS  
5 - 7

COLOR\*  
Black

## S1



DIMENSIONS  
59 x 15 cm (23.2" x 5.9")

WEIGHT  
1,3 kg (2.9 lbs)

ADJUSTABLE LEGS  
1,5 cm (0.6")

PEDALS  
4 - 5

COLOR\*  
Black

## S2



DIMENSIONS  
59 x 30 cm (23.2" x 11.8")

WEIGHT  
2,5 kg (5.5 lbs)

ADJUSTABLE LEGS  
1,5 cm (0.6")

PEDALS  
8 - 10

COLOR\*  
Black

## L2



DIMENSIONS  
83 x 30 cm (32.7" x 11.8")

WEIGHT  
3,4 kg (7.5 lbs)

ADJUSTABLE LEGS  
1,5 cm (0.6")

PEDALS  
10 - 14

COLOR\*  
Black

\*Consult for other colors.

# MODULAR DESIGN

Expand or reduce according to user needs

## ET EXTENSION XS

If you need to upgrade your Evo Track XS1 to a Evo Track XS2 because your pedal collection keeps growing, you no longer need to buy a new pedalboard!

Evo Track extension kits will always allow you to adapt the pedalboard to your needs.

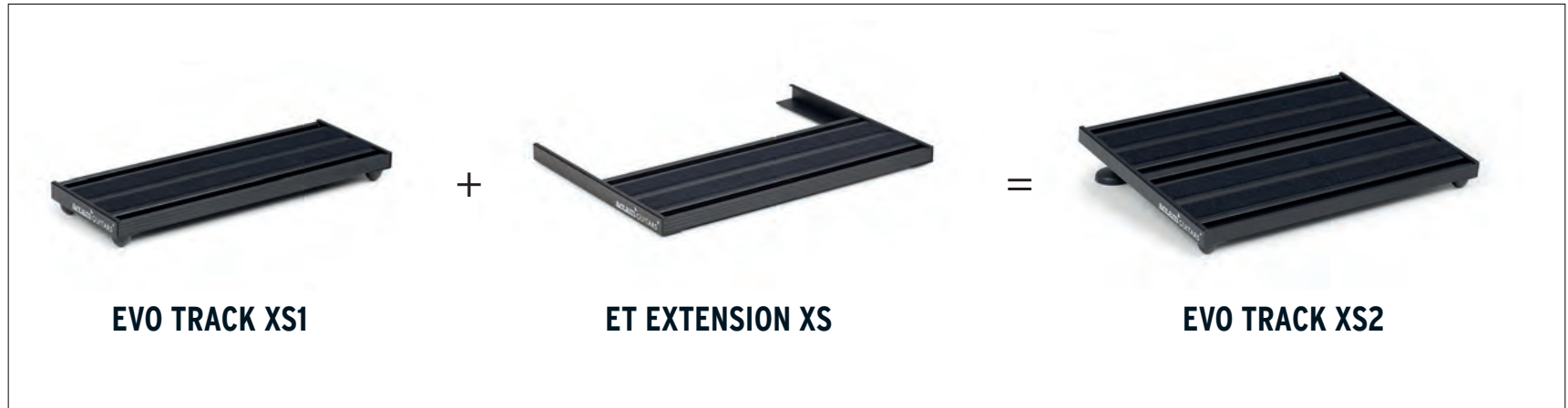

## ET EXTENSION S

From Evo Track S1 to Evo Track S2. Increase or reduce your pedalboard depending on the setup you use in each scene!

Evo Track extensions are the ideal solution for those who enjoy improvising and exploring alternatives!



# CUSTOMIZE YOUR PEDALBOARD!

## EVO & SMART TRACK PEDALBOARD ACCESSORIES

*The ultimate modular system pedalboards that, together with their accessories, will open an endless range of combinations and possibilities.*

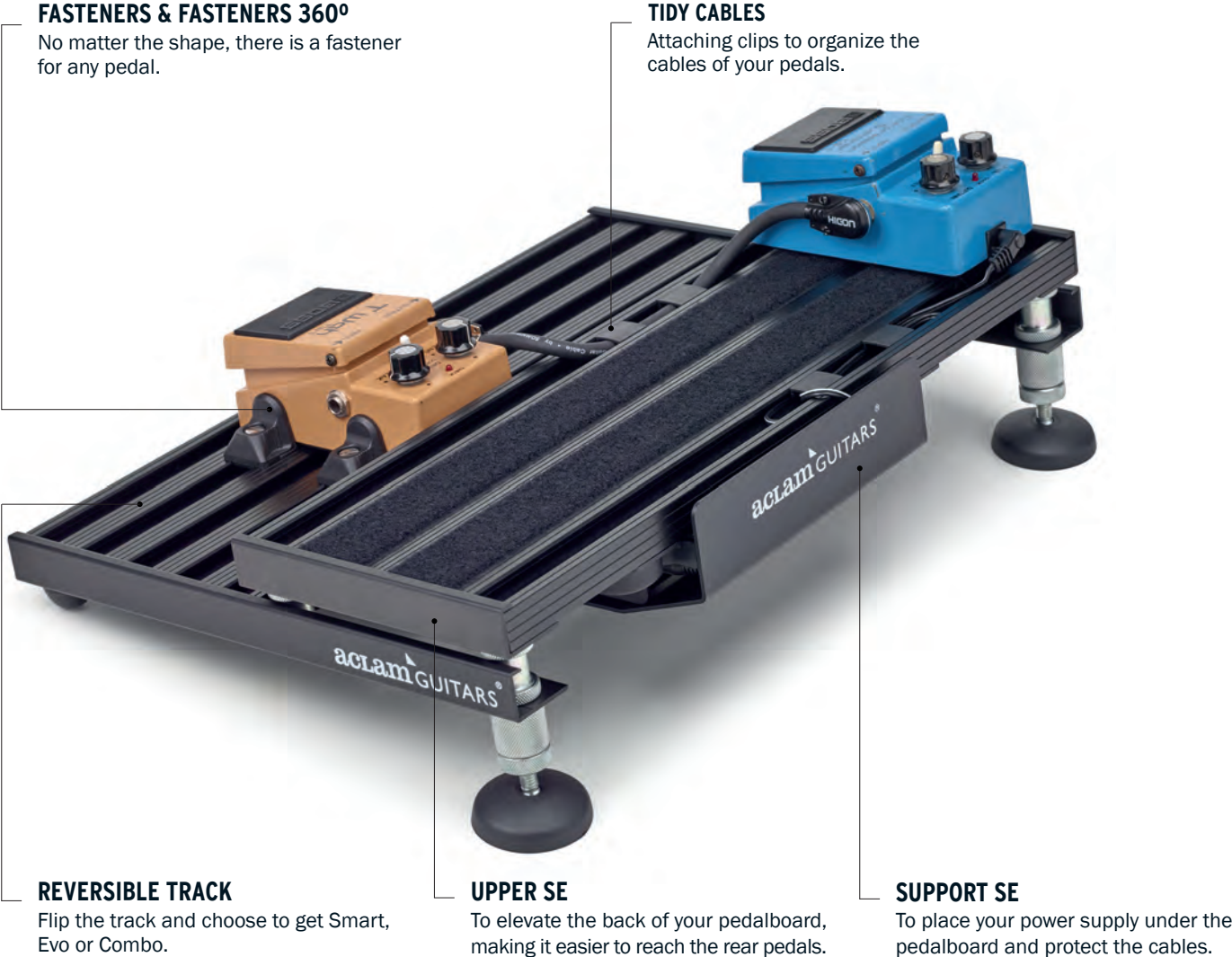

**FASTENERS & FASTENERS 360°**  
No matter the shape, there is a fastener for any pedal.

**TIDY CABLES**  
Attaching clips to organize the cables of your pedals.

**REVERSIBLE TRACK**  
Flip the track and choose to get Smart, Evo or Combo.

**UPPER SE**  
To elevate the back of your pedalboard, making it easier to reach the rear pedals.

**SUPPORT SE**  
To place your power supply under the pedalboard and protect the cables.



FEEL  
THINK  
PLAY

At Aclam Guitars we design and manufacture guitars and accessories for guitars, in our constant quest to reach the highest quality, functionality and innovation in all our products. Our passion for music and innovation, set our goal of constantly rethinking music equipment and accessories.

#### HEADQUARTERS

C/ Consell de Cent, 201  
08011 Barcelona, Spain

#### CONTACT

[guitars@aclam.cat](mailto:guitars@aclam.cat)  
00 34 931 701 767



# 20:14 GUITAR

*A completely customizable guitar*

*Patent Pending*





## THE HISTORY

"In the summer of 2014 I began to draw the story of a guitar. A guitar that wished to be different in the experimental sense of the word. As I was defining the most important features it responded to me, full of personality that i wanted to be like a laboratory, with which musicians could test and research different sounds in a very simple manner,... and it flirtatiously added that it also wanted to change its appearance depending on the mood, place or the company.

Once its personality had been defined, I searched for a team with whom to develop the 20:14. The synergy within the team made possible, in just 3 months, to present the first prototype of the guitar during last NAMM 2015; modifications and necessary improvements to finish up its personality and character."

*Jordi Canivell, Aclam's CEO*

# 20:14 GUITAR

*Made of high quality woods with a finest guitar works, and high end technology!*

Created for restless musicians who want their sound to go a step further and like to experiment. The 20.14 is a guitar born to allow artists to do whatever they please, swapping, arranging and adjusting the components in an easy and quick way, with only a screwdriver.

With a sturdy vintage design, in homage to the great guitar creators of that awesome period, without forgetting that we live in a fully technological age; the 20.14 is a fusion between two distant epochs in time but close in space.

- P.U. cartridge designed to allow quick and easy pickup swapping.
- A ball joint, as a link between the neck and body, allows to modify the distance between the strings and the guitar's body, giving the possibility to experiment with different bridges and soundboards, which are easily interchangeable.
- Two tailpiece to choose from, one internal (Tele style) and an external one (Archtop style).
- Provided with 3 different circuits: magnetic, piezo and midi.

Designed as a hybrid approach between an acoustic and a solid body guitar, it brings the electric guitar sound closer to the one of an acoustic guitar. The combination of all these features open a vast range of creative sonic possibilities for guitarists to explore.

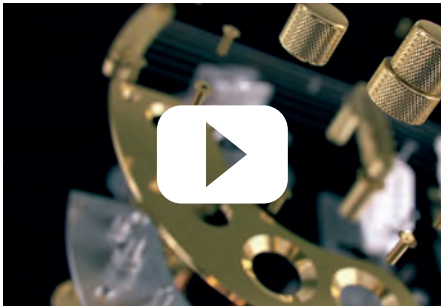

<http://youtu.be/7lqpcBbbcW4>

## **ADJUSTABLE ANGLE NECK**

Different bridge & sound responses.

## **EASY TOP SWITCH OVER**

To get different sounds.

## **EASY & FAST CHANGE OF P.U.**

Different kinds of magnetic sound.

## **TWO DIFFERENT TAILPIECES**

Different sounds.

## **HOLLOW BODY**

To get more acoustic feeling.

## **3 ELECTRONIC CIRCUITS**

Magnetic, piezoelectric & midi.





# CUSTOMIZE YOUR GUITAR WITH ONLY A SCREWDRIVER!

## SPECIFICATIONS

### CONTROLS

---

ON/OFF led buttons:

- Magnetic.
- Piezo.
- M.I.D.I.

### MAGNETIC

- Independent volume & eq for each P.U.
- Independent switch for each P.U. for single, serie and paralel options.
- Switch for P.U. selection.
- Master volume.

### PIEZO

- Volume.
- Frequency cut.

### M.I.D.I.

- Volume.
- Program up & down.
- System selector: Roland - Axon.

### ELECTRONICS

---

Exchangeable pickups system.

- Piezo.
- M.I.D.I.



## EASY & FAST CHANGE OF P.U

*Different kinds of magnetic sound*



## TWO DIFFERENT TAILPIECES

*Different sounds*



## HOLLOW BODY

*To get more acoustic feeling*



## 3 ELECTRONIC CIRCUITS

*Magnetic, piezo & midi*



## ADJUSTABLE ANGLE NECK

*Different bridge & sound responses*



## EASY TOP SWITCH OVER

*To get different sounds*





**01**

**SPECIFICATIONS**

BODY Blue tinted Hard Maple  
TOP European Maple + European Spruce  
NECK Blue tinted Hard Maple  
FRETBOARD Jumbo size. Ebony + Mother-of-pearl  
HEADSTOCK Macasar Ebony + Mother-of-pearl  
HARDWARE Golden  
PICKUPS Seymour Duncan-APH1  
STRINGS Elixir, Light (.011-.046)  
CONTROL PLATES Mahogany  
TUNNING PEGS Gotoh. Ratio: 1:15



**02**

**SPECIFICATIONS**

BODY Hard Maple + Cedar  
TOP Ziricote + European Spruce  
NECK Indian Rosewood  
FRETBOARD Jumbo size. Ebony + Mother-of-pearl  
HEADSTOCK Macasar Ebony + Mother-of-pearl  
HARDWARE Golden  
PICKUPS Seymour Duncan Strato  
STRINGS Elixir, Light (.011-.046)  
CONTROL PLATES Walnut  
TUNNING PEGS Gotoh. Ratio: 1:15



**04**

**SPECIFICATIONS**

BODY Mahogany  
TOP Walnut + European Spruce  
NECK Mahogany  
FRETBOARD Jumbo size. Ebony + Mother-of-pearl  
HEADSTOCK Mahogany + European Curly Maple  
HARDWARE Chrome  
PICKUPS Seymour Duncan-APH1  
STRINGS Elixir, Light (.011-.049)  
CONTROL PLATES Ziricote  
TUNNING PEGS Gotoh. Ratio: 1:15



**05**

**SPECIFICATIONS**

BODY Mahogany  
TOP European Spruce  
NECK Hard Maple  
FRETBOARD Jumbo size. Hard Maple + Ebony  
HEADSTOCK Macasar Ebony + Mother-of-pearl  
HARDWARE Black Nickel  
PICKUPS Seymour Duncan, Jazz Master  
STRINGS Thomastik Jazz Bebop (.012-.050)  
CONTROL PLATES Aluminum  
TUNNING PEGS Gotoh. Ratio: 1:18



**06**

**SPECIFICATIONS**

BODY Mahogany  
TOP Birdseye Maple + European Spruce  
NECK Mahogany  
FRETBOARD Jumbo size. Birdseye Maple + Ebony  
HEADSTOCK Padauk + European Maple  
HARDWARE Golden  
PICKUPS Lollar Imperial  
STRINGS Thomastik Jazz Bebop (.012-.050)  
CONTROL PLATES Wenge  
TUNNING PEGS Gotoh. Ratio: 1:15



**07**

**SPECIFICATIONS**

BODY Mahogany  
TOP Birdseye Maple  
NECK Mahogany  
FRETBOARD Jumbo size. Hard Maple + Ebony  
HEADSTOCK Hard Maple + Ebony  
HARDWARE Chrome  
PICKUPS Lollar P-90  
STRINGS Elixir, Light (.012-.050)  
CONTROL PLATES Aluminum  
TUNNING PEGS Gotoh. Ratio: 1:15



**08**

**SPECIFICATIONS**

BODY Zipo  
TOP Walnut + European Spruce  
NECK Hard Maple  
FRETBOARD Jumbo size. Birdseye Maple + Ebony  
HEADSTOCK Hard Maple + Ebony  
HARDWARE Black Nickel  
PICKUPS Seymour Duncan, Zebra  
STRINGS Elixir, Light (.011-.046)  
CONTROL PLATES Aluminum  
TUNNING PEGS Gotoh. Ebony. Ratio: 1:18



**10**

**SPECIFICATIONS**

BODY Hard Maple + Cedar  
TOP Spalted Maple  
NECK Padauk  
FRETBOARD Jumbo size. Ebony + Mother-of-pearl  
HEADSTOCK Macasar Ebony  
HARDWARE Golden  
PICKUPS Lollar Regal  
STRINGS Elixir, Light (.010-.046)  
CONTROL PLATES Aluminum  
TUNNING PEGS Gotoh. Ratio: 1:15



FEEL  
THINK  
PLAY

At Aclam Guitars we design and manufacture guitars and accessories for guitars, in our constant quest to reach the highest quality, functionality and innovation in all our products. Our passion for music and innovation, set our goal of constantly rethinking music equipment and accessories.

#### HEADQUARTERS

C/ Consell de Cent, 201  
08011 Barcelona, Spain

#### CONTACT

[guitars@aclam.cat](mailto:guitars@aclam.cat)  
00 34 931 701 767





# FLOATING GUITAR SUPPORT

*Turn your guitar into a piece of art*

*Product Patented*



# FLOATING GUITAR SUPPORT

## ADJUSTABLE SUPPORT

Fits onto a wide variety of guitars

## EASY TO FIX & REMOVE

Always ready to play

## DIFFERENT MODELS

For electric & acoustic guitars

## STAND & WALL MOUNT

Different options to display

Floating Guitar is a support specially designed to preserve and highlight the guitar value thanks to its versatile and practical design, which will make your instrument be the focus of any scene, transforming it into a unique piece.

Invisible and light, any kind of guitar can be easily hanged thanks to its adjustable adaptors. The strap button or neck anchoring system eases the process of attaching and detaching the guitar from the support, making it always ready to be played.

Floating Guitar is the ideal solution to exhibit your guitar in any space. It offers several orientation options and can be placed either on the wall or on a floor stand. This flexibility allows covering the needs of guitarists, collectors or luthiers in a clean, restrained, tidy and elegant way.

Made of stainless steel and a special foam for delicate surfaces it is available for different models of acoustic, archtop or classical guitars as well as for Strato, LP, SG or ES335 type electric guitars.



# FLOATING GUITAR SUPPORT

*Choose which movement you want to give to your guitar!*

## FLOATING GUITAR CLASSIC Swivel 360° & tilt

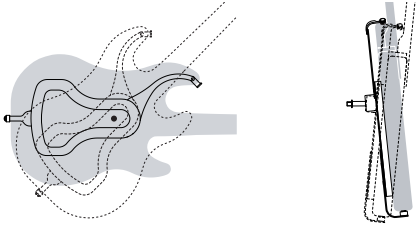

## FLOATING GUITAR LITE Swivel 360°

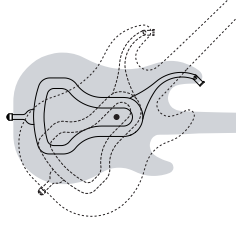

## FOR ELECTRIC GUITARS

*The model depends on the strap button position*

### STRATO & SIMILAR GUITARS



### LP, TELE & SIMILAR GUITARS



## FOR ACOUSTIC GUITARS

*Archtop or classic guitars*



### SG, ES335 & SIMILAR GUITARS



### GUITARS WITH STRAP BUTTON ON THE BACK



# ACCESSORIES

If you don't want to drill holes in the wall, Floating Guitar Stand is the accessory you need to complete your Floating Guitar support, allowing you to place your guitar wherever you want.

Made of glass, stainless steel and high quality wood, this floor or desk stands are the pieces you were missing in order to hang and show off your favourite guitar preserving all the mobility of our support!

**FLOATING GUITAR STAND**



**FLOATING GUITAR MINI STAND**



**FLOATING GUITAR TABLE STAND**



**BASE OPTIONS**



Stainless steel



Wood





FEEL  
THINK  
PLAY

Aclam Guitars designs and manufacture guitars and innovative guitar accessories, in our constant quest to reach the highest possible quality and functionality. Our passion for music and innovation set our goal of constantly rethinking music equipment and accessories.

#### HEADQUARTERS

C/ Consell de Cent, 201  
08011 Barcelona, Spain

#### CONTACT

[guitars@aclam.cat](mailto:guitars@aclam.cat)  
00 34 931 701 767

