

Talend Big Data Solution

Talend, Global Leader in Open Source Integration Solutions

- | Talend Overview
 - Relationship between Talend and Eclipse
 - Talend Product
 - Hadoop ecosystem
 - Talend Big Data
 - Map Reduce
 - SentimentalAnalysis demo

Liu Wu

15311202609

wliu@talend.com

Talend Overview

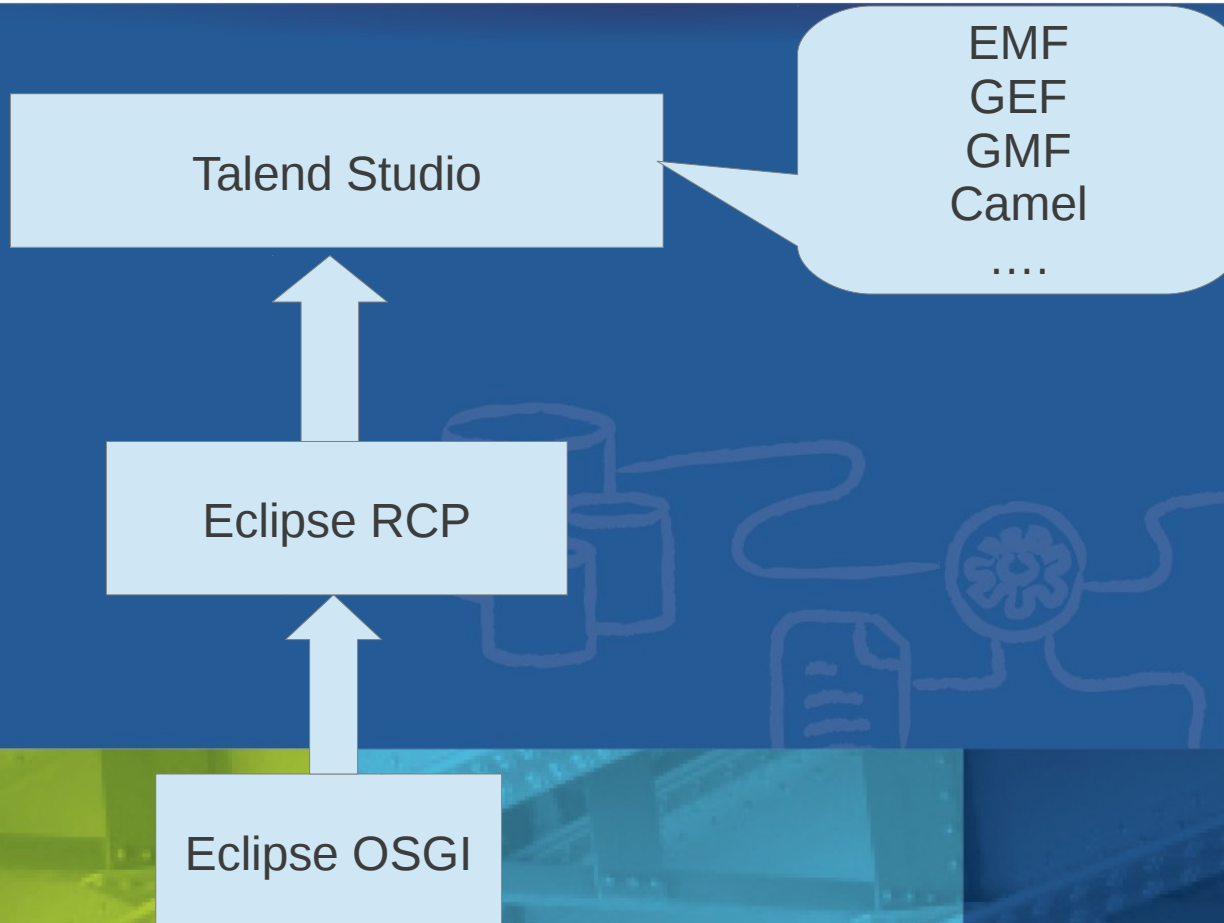

Talend Overview



Growth-Driven Deployment Model

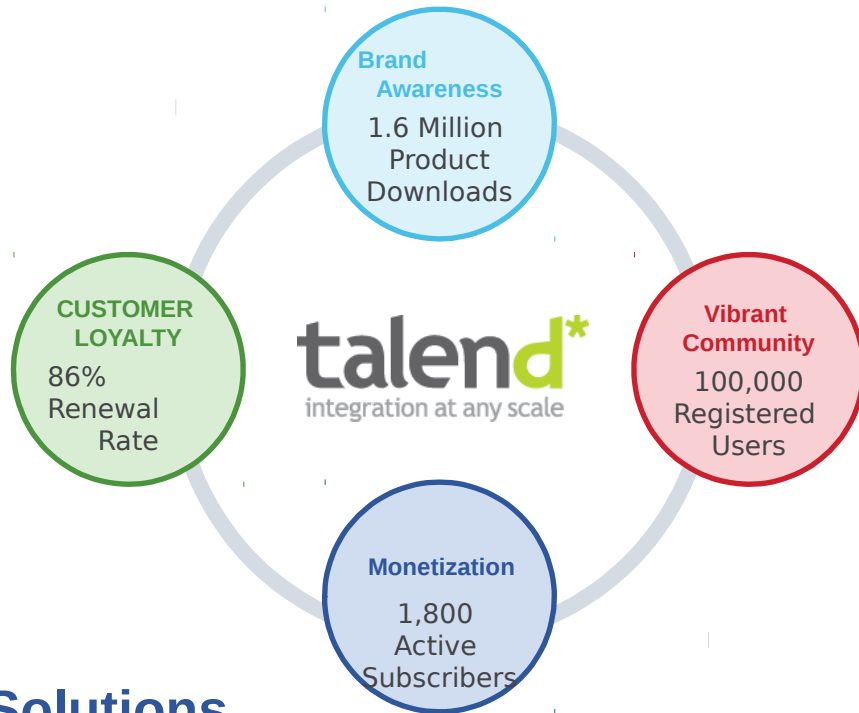

Solutions

- Highly scalable integration solutions addressing Big Data, Application Integration, Data Integration, Data Quality, MDM, BPM
- Recognized as a visionary leader in the integration market by Gartner and Forrester

Key Facts

- Founded in 2006
- 400 employees
- in 7 countries
- Dual HQ in Los Altos, CA
- and Paris, France
- Open Core business model
 - Subscription license
 - Services & training

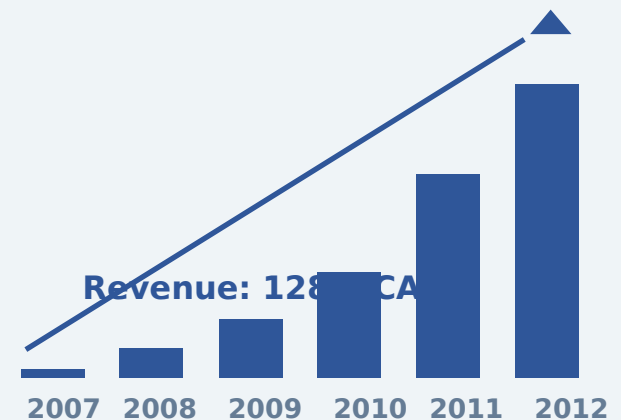

Solutions that Scale

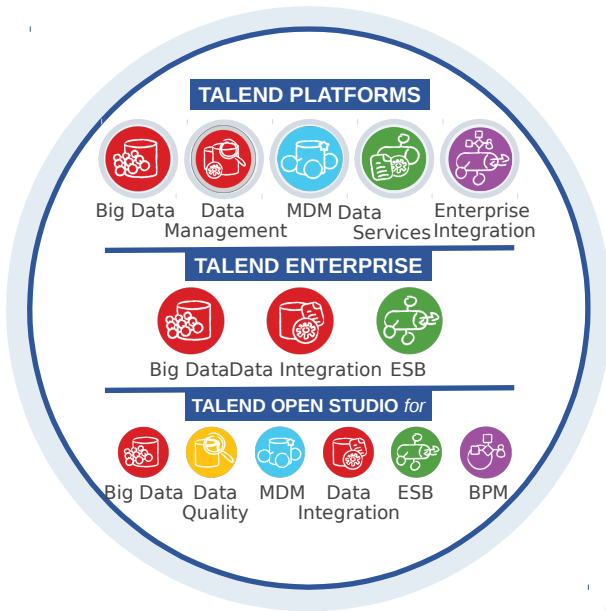

BEST-OF-BREED

Category leading products address all your integration and data management requirements



CONVERGED INTEGRATION

Use for any data, application and process project

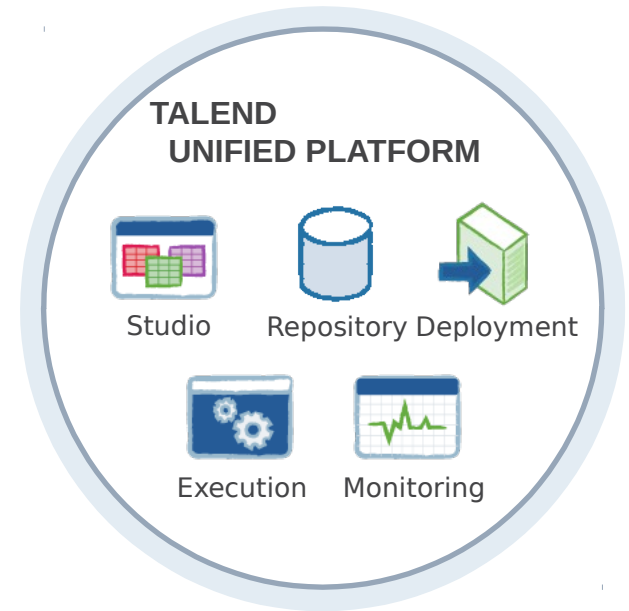

UNIFIED PLATFORM

A shared foundation and toolset increases resource reuse

Technology that Scales

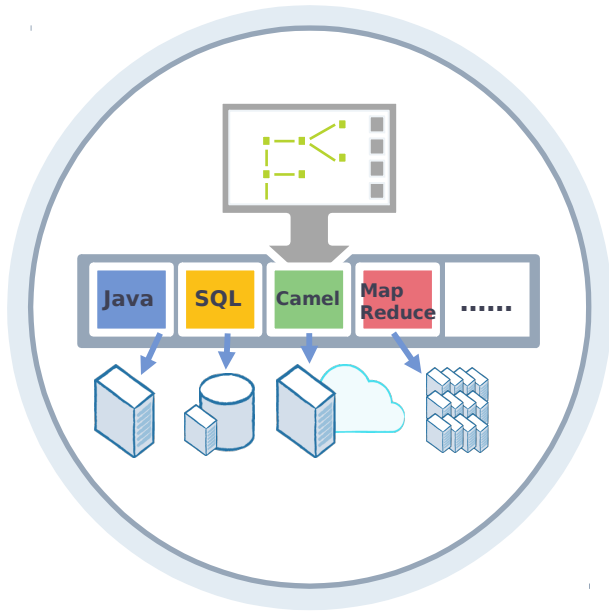

CODE GENERATOR

No black-box engine means faster maintenance and deployment with improved quality

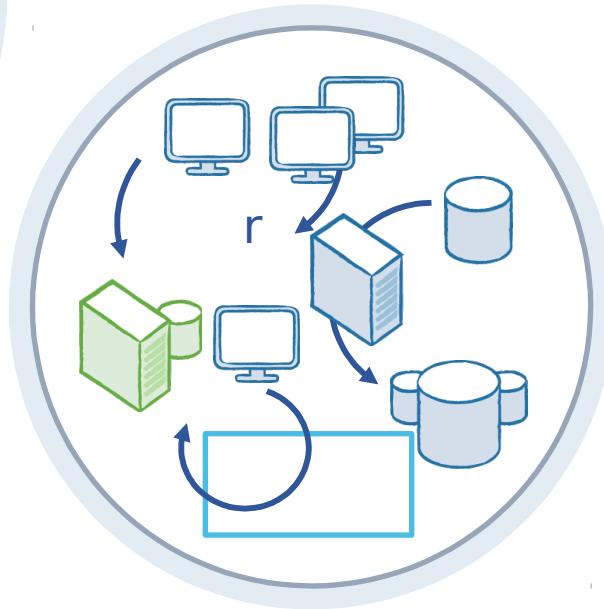

DISTRIBUTED ARCHITECTURE

Lightweight distributed processing and parallelizable run-time means higher performance and resilience



STANDARDS-BASED

Easy to learn, flexible to adopt, reduces vendor lock-in

An Approach that Scales



OPEN SOURCE

Eliminates vendor lock-in using open standards and processes, flexible and customizable



SUBSCRIPTION-BASED PRICING

Unlike large upfront licenses, you pay for what you need, when you need it

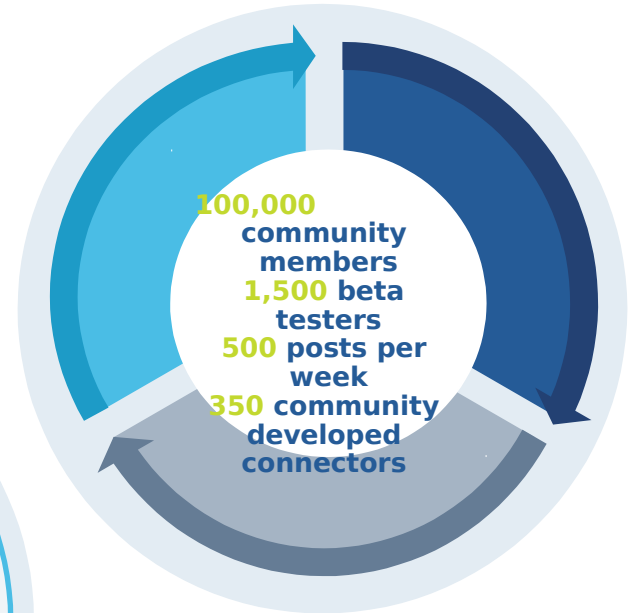

COMMUNITY-BASED DEVELOPMENT

Faster innovation with a large available pool of resources

The Value of Talend

Provides integration solutions that truly scale

- for any type of integration challenge
- for any volume of data
- for any scope of project - no matter how simple or complex

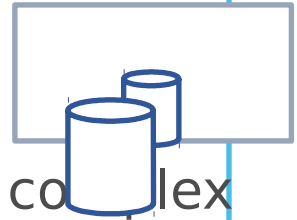

Empowering organizations

- to effectively leverage all of their information assets
- to accelerate the time-to-value of their integration projects



Through a disruptive approach

- an innovative, open source platform
- a predictable and scalable value-based subscription model



Hadoop ecosystem ---> background

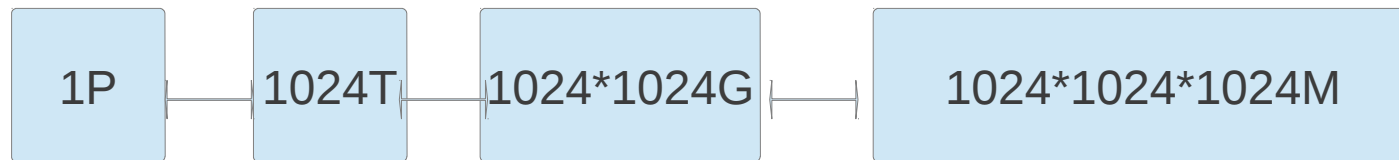

Hadoop ecosystem

The Hadoop Ecosystem

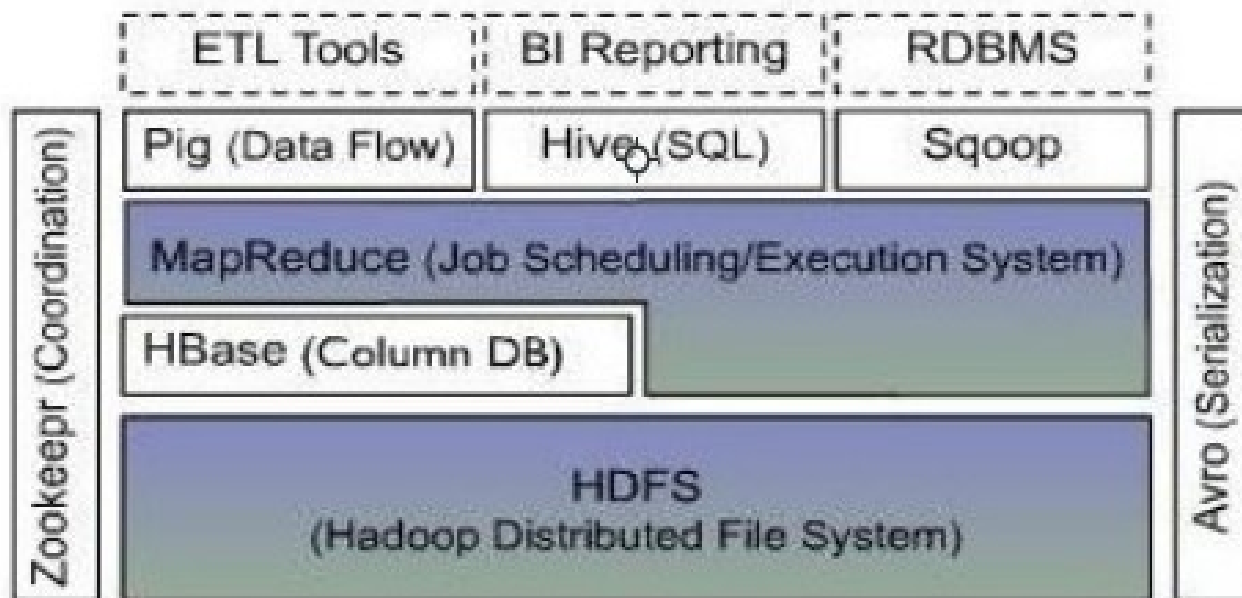

Map Reduce

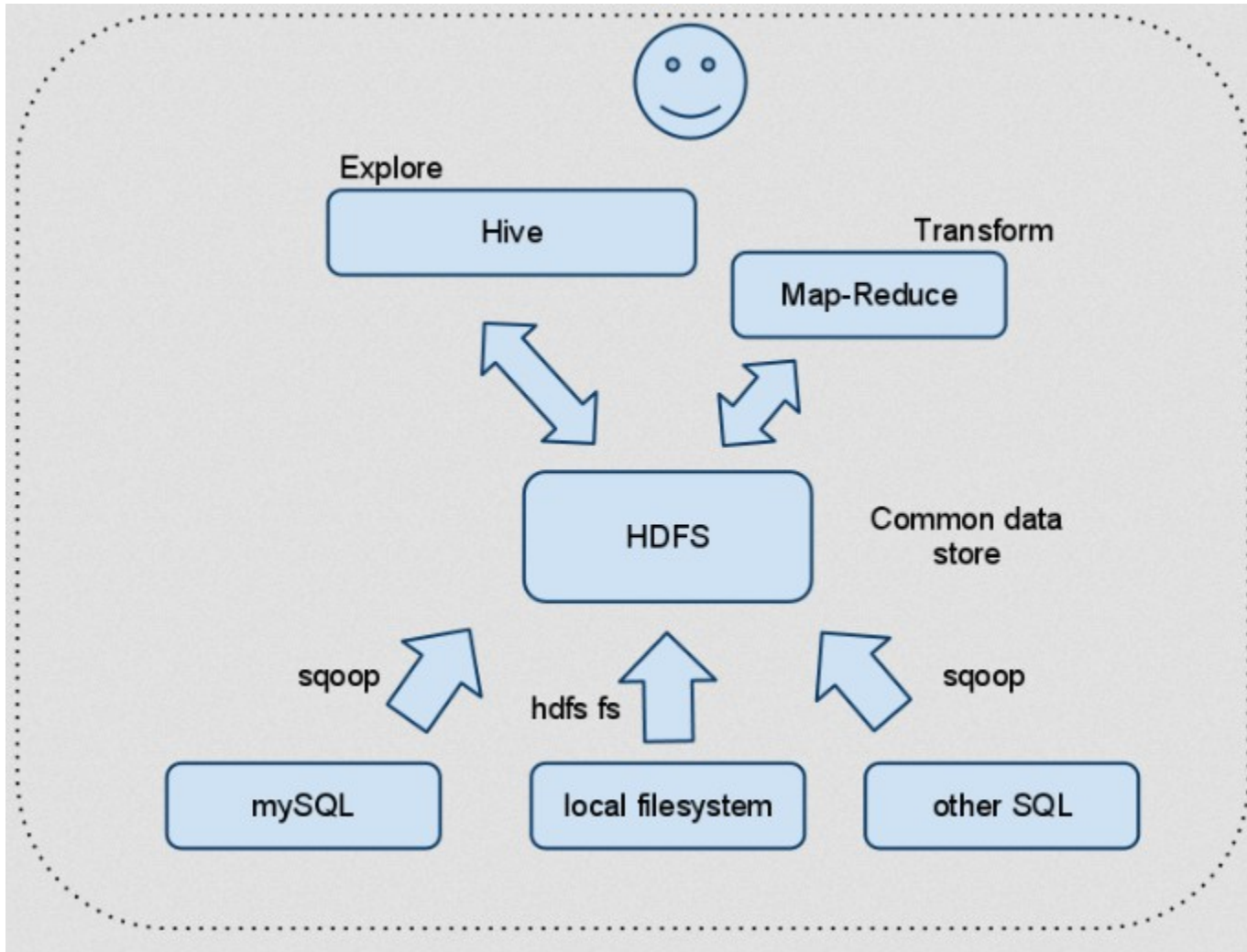

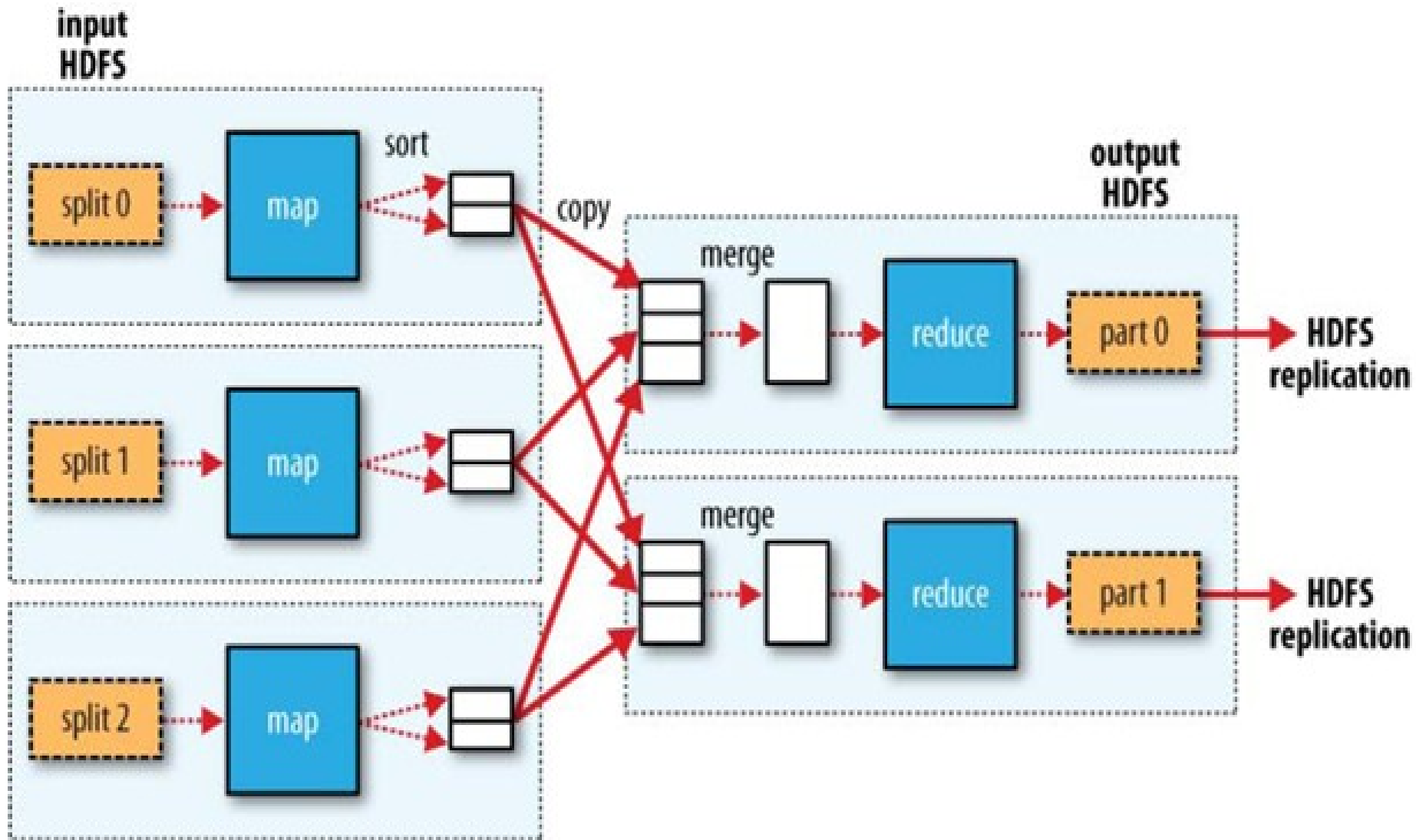

Talend Big Data

1. A famous map reduce sample:

<http://wiki.apache.org/hadoop/WordCount.java>

2. Talend Map Reduce

Talend MapReduce

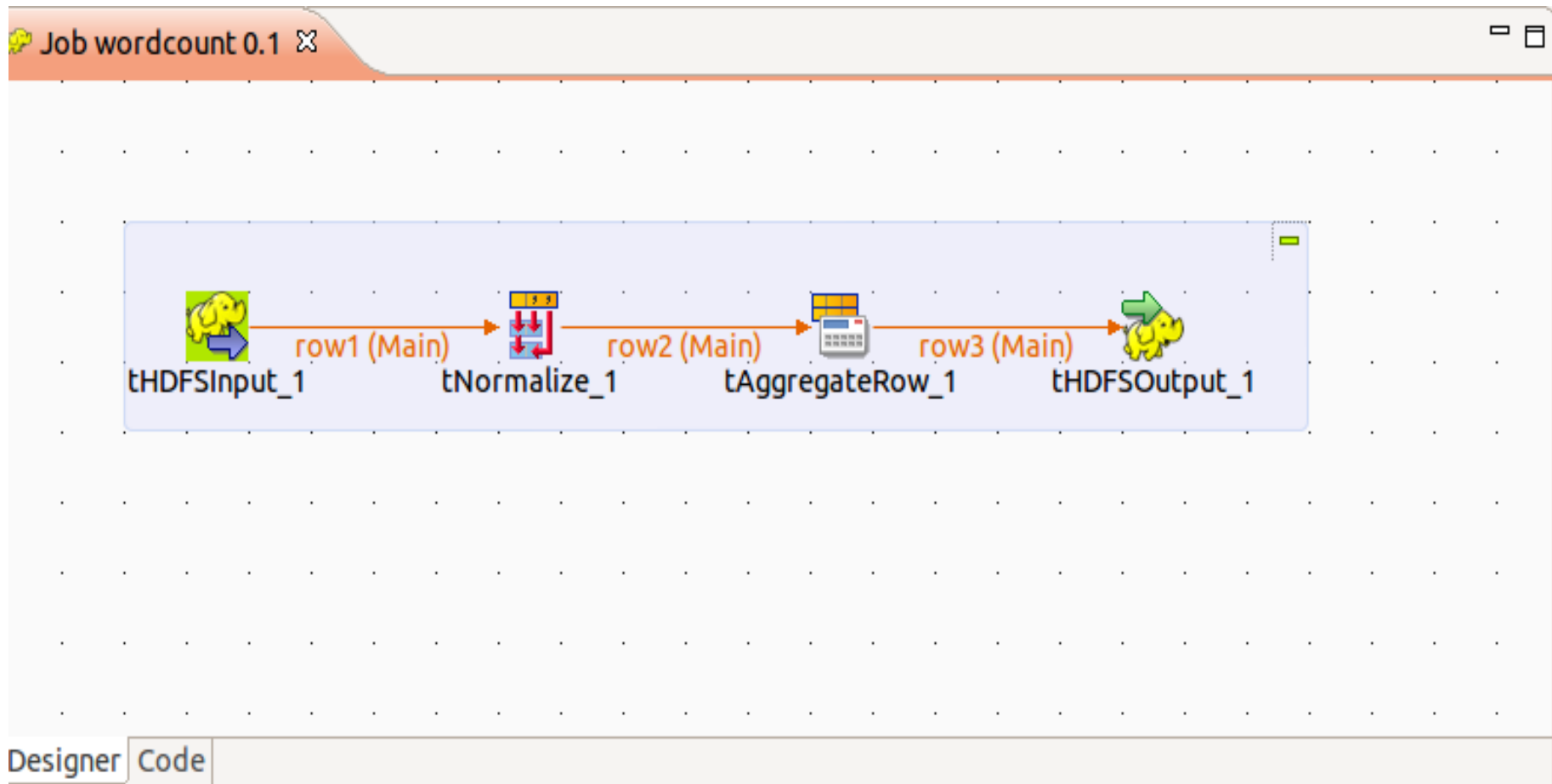

□ Sentimental Analysis demo

Top Twitters Timeline

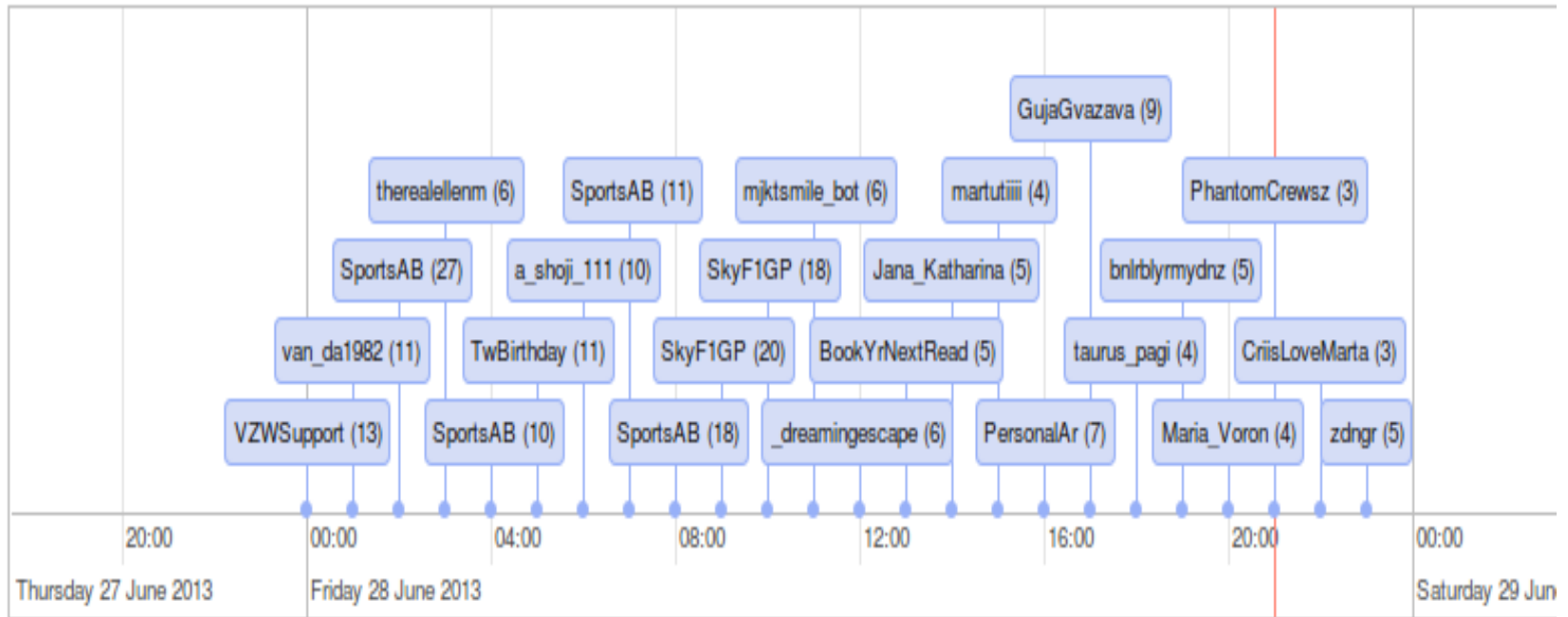

▮ Sentimental Analysis demo

Job Demo time

Product Download

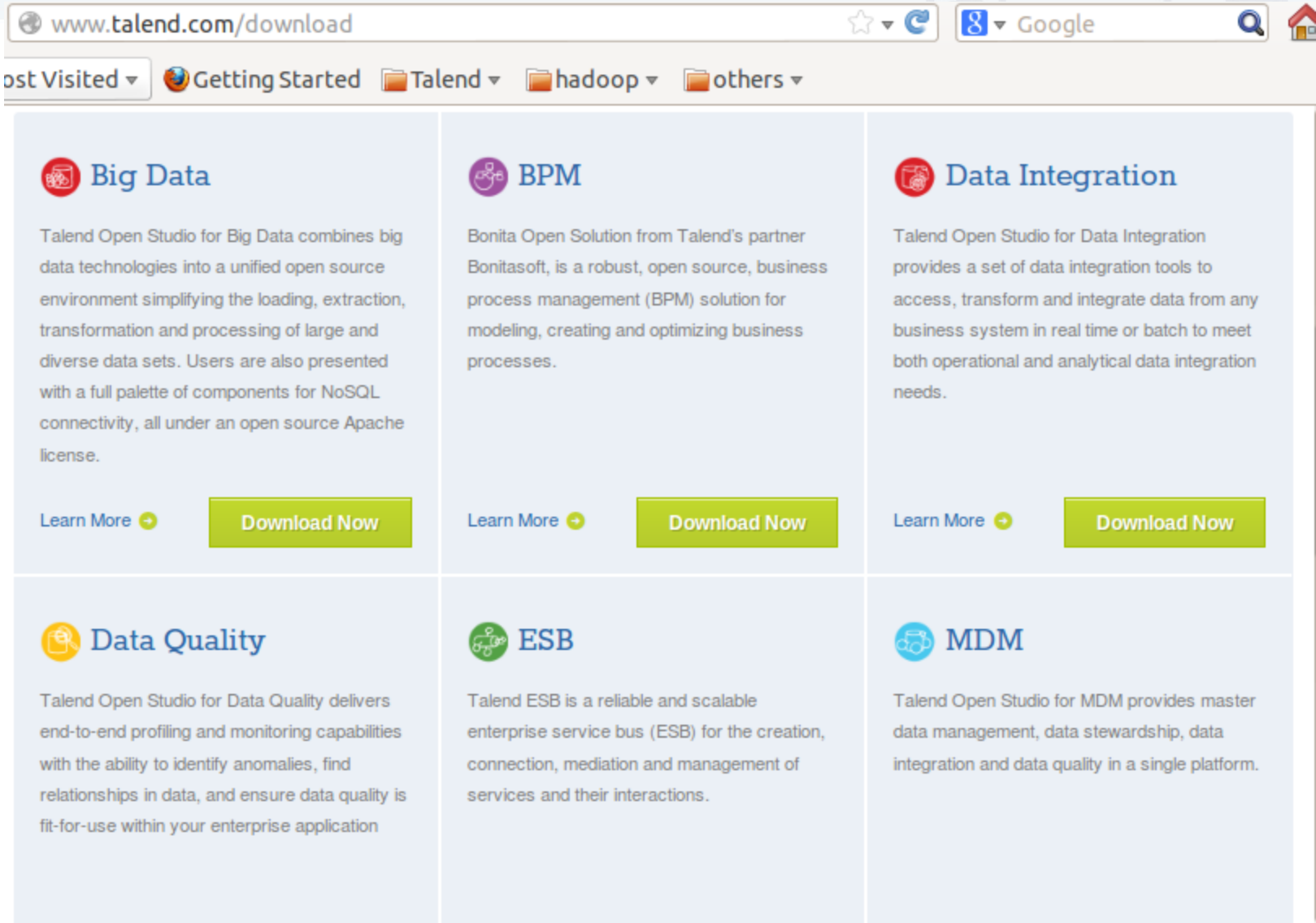

The screenshot shows a web browser window with the address bar displaying "www.talend.com/download". The browser's search bar contains "Google". Below the address bar, there is a navigation menu with "Most Visited" and several categories: "Getting Started", "Talend", "hadoop", and "others". The main content area is a grid of six product tiles, each with an icon, a title, a description, and two buttons: "Learn More" and "Download Now".

Product Category	Description
Big Data	Talend Open Studio for Big Data combines big data technologies into a unified open source environment simplifying the loading, extraction, transformation and processing of large and diverse data sets. Users are also presented with a full palette of components for NoSQL connectivity, all under an open source Apache license.
BPM	Bonita Open Solution from Talend's partner Bonitasoft, is a robust, open source, business process management (BPM) solution for modeling, creating and optimizing business processes.
Data Integration	Talend Open Studio for Data Integration provides a set of data integration tools to access, transform and integrate data from any business system in real time or batch to meet both operational and analytical data integration needs.
Data Quality	Talend Open Studio for Data Quality delivers end-to-end profiling and monitoring capabilities with the ability to identify anomalies, find relationships in data, and ensure data quality is fit-for-use within your enterprise application
ESB	Talend ESB is a reliable and scalable enterprise service bus (ESB) for the creation, connection, mediation and management of services and their interactions.
MDM	Talend Open Studio for MDM provides master data management, data stewardship, data integration and data quality in a single platform.

Thank You!

