

TBS CAIPIRINHA Mini FPV Wing

Small, lightweight, fly anywhere plane

Revision 2016-01-24

The new wing from TBS. Bittersweet, precise and easy to build, just like the cocktail it has been named after. Using airfoils from Ritewing and manufactured by Windrider in cooperation with TBS!

Designed to change the fixed wing FPV experience - again. Its small size and light weight makes it very forgiving for beginners. Its versatility will please professionals, with 10km (and return) flying range, a whopping 35mins flight time and a speed range in the low 20's to high 60 km/h. The lower speed compared to its big brother Zephyr II (ZII) is barely noticeable as you fly closer to the ground, between trees or buildings and into cracks or crevices. This is a take-anywhere, fly-anytime type of plane which doesn't cause a stir in local parks and is absolutely safe to fly.

Built from indestructible molded EPP, it is the smallest wing to date capable of carrying a full-feature HD camera such as the GoPro while keeping the all-up-weight in the 600g (21oz.) range! With the slick, low drag design it flies smooth and efficient. The supplied accessories are of exceptional quality and give the freedom to use the plane with any FPV equipment, powertrain and battery system, while reducing the build time to a minimum when using it with TBS-compatible equipment.



you



Features

- Small, lightweight, fly anywhere design
- Virtually indestructible EPP material
- Pre-cut camera, battery, R/C receiver and video transmitter slots
- Pre-cut, sanded and covered ultra-lightweight elevons & pushrods
- Bunny-ear & symmetrical winglets included
- Laser-cut plywood GoPro protection & motor mount
- 2x spar holes, 3x ribbon slots provides plenty of strength for those that need it
- Negative foam pieces allows you to build the wing according to your rules, not ours



Before we begin

Thank you for buying a TBS product! The TBS CAIPIRINHA is a new FPV wing from Team BlackSheep (TBS) and features the best design practices available on the market to date, providing great flying duration and incredible FPV characteristics.

Please read this manual carefully before assembling and flying your new TBS CAIPIRINHA. Keep this manual for future reference regarding tuning and maintenance.

Disclaimer

Our request to you: the aircraft may not be used to infringe on people's right to privacy. We have designed a toy with mind blowing capabilities. It is your responsibility to use it reasonably and according to your experience level. Use common sense. Fly safe. You are on your own. TBS has no liability for use of this aircraft.

- Locate an appropriate flying location
- Obtain the assistance of an experienced pilot
- Practice safe and responsible operation
- Always be aware of the rotating propeller
- Prevent moisture
- Keep away from heat or excessive amounts of sunlight



Specifications

Type:	Powered medium sized flying wing
Airframe:	Black/White molded EPP (Expanded Polypropylene) foam material
Wingspan:	34in / 865mm
Winglets:	Symmetrical and "bunny-ears", 3mm corrugated plastic
Battery:	2S (7.4V) 3300mAh 30C or 3S (11.1V) 2200mAh 30C LiPo pack, 150-200g
Battery bay:	W46.5xH16xL137.5mm
Motor:	2206, 2208, 2212 class, 1500-2200kv, 50-100W, 25-40g
Speed controller:	12 to 18A Switched (SBEC) ESC
Receiver:	3 channels or more
Propeller:	8x5in (2S battery, 2000kv motor)
Servos:	2x 9g micro-servos, >1.2kg/cm torque, metal gears, cable extensions
Center of gravity:	135mm from front, 130 to 145mm CG range
Pilot camera	Standard 32x32mm board camera
HD camera:	GoPro HD HERO1/2/3 or Xiaomi
Speed range:	20 to 60km/h
Duration:	35min (TBS equipment, max efficiency flight)
Distance:	10km (and return)
Frame weight:	180g (frame 113g, spar tubes 15g, ribbons 7g, elevons 25g, winglets 16 / 20g (symmetrical / "bunny-ears"))
All-up-weight:	22oz. / 620g (incl. GoPro and battery)













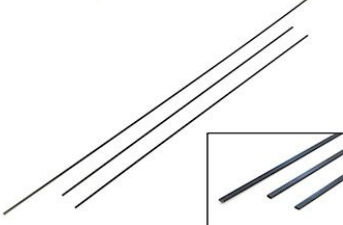

Required tools

- Utility knife
- Storage tape (for hinges)



Part list

Before building your TBS CAIPIRINHA make sure the following items are included in your kit.

 <p>2x Wing halves</p>	 <p>2x Symmetrical winglets</p>	 <p>2x Bunny-ear winglets</p>
 <p>2x Plywood lightweight elevons</p>	 <p>1x Plywood motor mount</p>	 <p>1x Plywood GoPro mount</p>
 <p>2x Glass fiber tube spars</p>	 <p>3x Glass fiber ribbons</p>	 <p>2x Ø1.0mm control links</p>
 <p>1x Battery bay support</p>	 <p>1x Adhesive backed velcro strip (receiver, battery, ESC)</p>	 <p>2x Adhesive backed winglet velcro strips</p>
 <p>1x TBS CAIPIRINHA stickers</p>	 <p>6x Negative foam inserts</p>	 <p>1x Teaspoon of awesomeness (rarely visible but always included)</p>



Required parts

To get in the air the following equipment and parts are needed for assembly.

 <p>1x 1500-2200kV brushless motor (X-mount not needed)</p>	 <p>1x 12-18A Switched speed controller</p>	 <p>1x 2S 3300mAh 35C or 3S 4000mAh 20C LiPo pack</p>
 <p>1x 8x5-inch propeller</p>	 <p>2x 9g metal gear micro-servos</p>	 <p>1x 4-ch or more R/C receiver</p>
 <p>1x 4-ch or more R/C transmitter</p>	 <p>1x LiPo charger</p>	 <p>1x Equipped ground station</p>
 <p>1x Pilot camera (32x32mm)</p>	 <p>1x Video transmitter</p>	 <p>1x HD recording camera</p>
 <p>1x Thick CA glue and kicker (accelerator) and PVA glue</p>	 <p>1x Two part epoxy adhesive or hot glue</p>	 <p>1x Medium thread-lock (purple/blue)</p>



Frequency choice

Frequency choice depends on the ranges you want to fly. Using 5.8GHz video is an ideal frequency if you do not plan on flying far away from yourself or behind objects. It is compatible with 2.4GHz remote controls.

Using 2.4GHz video (TBS video frequency of choice) will give you nearly unlimited range and far superior link quality, but you can not use your 2.4GHz remote control on the same wing because of limited separation (it is no problem for our R/C buddies to fly with 2.4GHz remote controls next to you though!). You will need an EzUHF or any other UHF control system available on the market.

1.2GHz works very well in urban environments where the 2.4GHz band is completely polluted.

By using the same connector type across all transmission frequencies, the TBS eco-system allows quick and effortless switching between the frequencies.

Typical ranges (based on customer feedback) with omnidirectional antennas:

- TBS UNIFY 2G4 500mW or Lawmate 2.4GHz 500mW - 4km
- TBS 5.8GHz 25mW - 400m
- TBS 5.8GHz 200mW - 1.4km
- Boscama/Foxtech/HobbyKing 5.8GHz 500mW - do NOT buy, bad design!
- Boscama/Foxtech/HobbyKing 5.8GHz 400mW - 2.5km
- ImmersionRC 5.8GHz 600mW - 1.5km

More range can be achieved by using higher gain (directional) antennas. With the 11dBi TBS Yagi on 500mW Lawmate 2.4GHz gear, 10km of range is no problem at all.

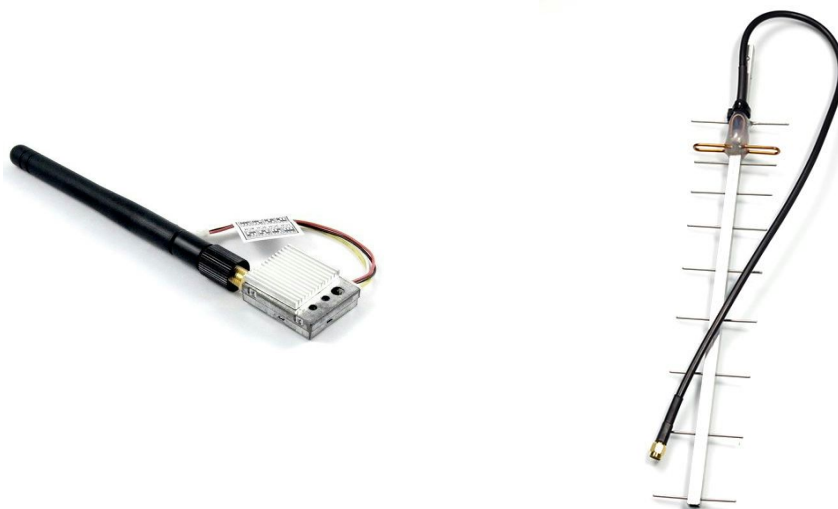

Choosing the right setup

If you are just getting into the hobby and you have absolutely nothing, consider the following components to buy. Use these suggested setups as a “shopping list” if you are just getting started. Any existing gear you already own (e.g. remote controls, chargers, batteries) can be used with the TBS CAIPIRINHA.

These setups, with the exception of the Camera Tripod and the Remote Control, are available from Team BlackSheep. Remote controls can be purchased at your local hobby shop, camera tripods are available from big electronics wholesalers or Ebay.

TBS CAIPIRINHA setup for short range flights

- Expected flight time: 25-40 min
- Approximate cost: US\$ 1'350 - US\$ 1'550
- Experience level: Beginner to Expert
- Ideal for: Parks, R/C clubs, front lawns

R/C transmitter/receiver:	Graupner MX-12 2.4GHz radio with bundled receiver (GR-6) or Futaba 8FG / 7C 2.4GHz radio with included receiver (R6208SB / R617FS)
Wing electronics:	TBS CAIPIRINHA 12A 5V SBEC ESC TBS 9 gram micro-servos TBS CAIPIRINHA 2000kV (2S) or Scorpion SII-1640KV (3S) brushless motor Graupner E-Prop 8x5-inch propeller
Voltage regulator/OSD:	TBS CORE PNP25 with built-in 25A current sensor and wire harness
Battery:	TBS 2S (7.4V) 3300mAh 35C or TBS 3S (11.1V) 4000mAh 20C Lipo pack
Battery charger:	Graupner Ultramat 14S (premium) or TBS B6AC 80W (budget)
FPV transmitter:	TBS ROOKIE BOSCAM 5.8GHz 200mW video transmitter
FPV receiver:	TBS RC508 5.8GHz video receiver or Dominator 5.8GHz module
FPV pilot camera:	TBS 59, TBS 69, TBS CHIPCHIP FPV camera
FPV goggles:	FatShark Dominator video glasses
HD camera:	GoPro HD Hero 3 Black Edition
Ground station accessories:	TBS 3S 5000mAh Ground Station Lipo Camera Tripod to mount your gear (e.g. Cullmann Primax 150)



TBS CAIPIRINHA setup for long range flights

- Expected flight time: 25-40 min
- Cost range: US\$ 1'700 - US\$ 2'000
- Experience level: Expert
- Ideal for: Long, wide open fields, plains, coastlines and valleys or urban flying

R/C transmitter/receiver:	Futaba 8FG / 7C or Graupner MX-12 radio + TBS CROSSFIRE transmitter and receiver module
Wing electronics:	TBS CAIPIRINHA 12A 5V SBEC ESC TBS 9 gram micro-servos TBS CAIPIRINHA 2000kV or Scorpion SII-1640KV (3S) brushless motor Graupner E-Prop 8x5-inch propeller
Voltage regulator/OSD:	TBS CORE PNP25 with built-in 25A current sensor and wire harness
Battery:	TBS 2S (7.4V) 3300mAh 35C or TBS 3S (11.1V) 4000mAh 20C Lipo pack
Battery charger:	Graupner Ultramat 14S (premium) or TBS B6AC 80W (budget)
FPV transmitter:	TBS UNIFY 2G4 500/800mW or Lawmate 2.4GHz 500mW Video Tx (stock or tuned)
FPV receiver:	Lawmate 2.4GHz Video Rx (stock or tuned) with 11dBi Yagi
FPV pilot camera:	TBS 59, TBS 69, TBS CHIPCHIP FPV camera
FPV goggles:	FatShark Dominator video glasses
HD camera:	GoPro HD Hero 3 Black Edition
Ground station accessories:	TBS 3S 5000mAh Ground Station Lipo Camera Tripod to mount your gear (e.g. Cullmann Primax 150)



Wing assembly

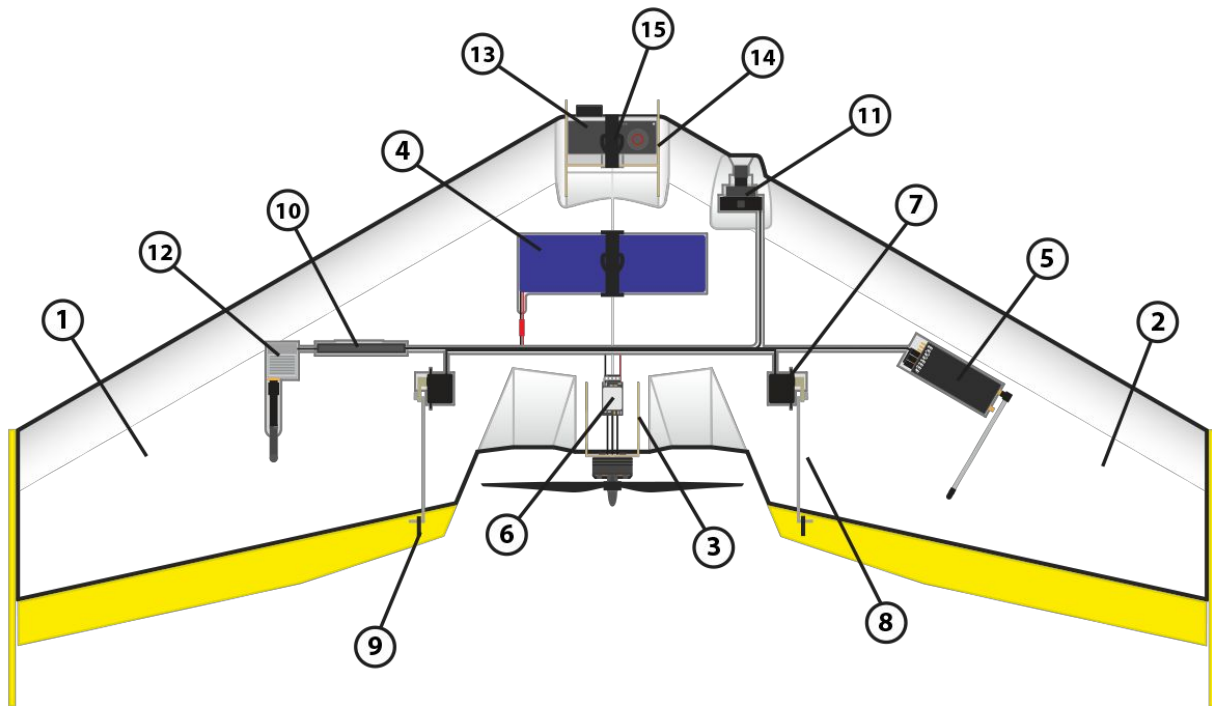

- | | | |
|-------------------|--------------------|-----------------------|
| ① Left wing half | ⑥ Speed controller | ⑪ Pilot camera |
| ② Right wing half | ⑦ Servos | ⑫ Video transmitter |
| ③ Motor mount | ⑧ Control links | ⑬ HD recording camera |
| ④ Lipo battery | ⑨ Control horns | ⑭ HD camera mount |
| ⑤ R/C receiver | ⑩ Electronics bay | ⑮ Support strap |

Negative foam inserts

- All the negative cut-outs has been provided if you want to do a DIY setup and make your own component layout decisions. The cut-outs can also be cut to cover and protect the R/C receiver, pilot camera and video transmitter.
- Use Polyurethane (PU), Cyanoacrylate (CA) or similar foam glue to fasten the cut-outs. Cut out your own shapes and compartments. The excessive foam around the pilot camera "pod" can be removed with a utility knife.

Wing halves

- The wings are made out of virtually indestructible EPP material and requires very little reinforcement. The primary weak points are the centre of the wing and the corners at the trailing edge left and right of the motor section. Keep this in mind when deciding the sparring for your build.



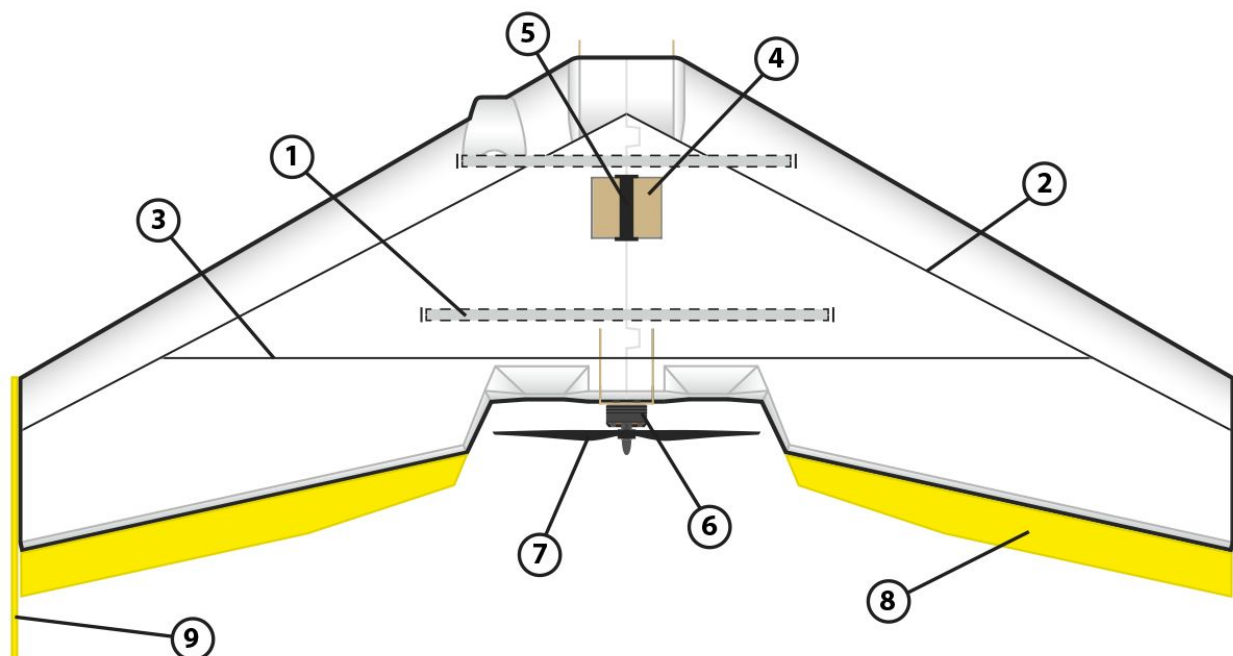

- | | | |
|-----------------------|-------------------|-------------|
| ① Main spars (tube) | ④ Battery support | ⑦ Propeller |
| ② Wing ribbons (flat) | ⑤ Support strap | ⑧ Elevons |
| ③ Cross ribbon (flat) | ⑥ Brushless motor | ⑨ Winglets |

Spars

- The wing can be built for different purposes; ultra lightweight for long flights, strong for all-purpose flying or super strong for speed. Attaining the proper CG depends on your build purpose and the FPV equipment used. The battery bay is used as the most effective means to adjust CG, and is therefore addressed at the very end of the build. Scuff the spars to get a rough surface for the glue to grip on.
- Reinforcing the wing will depend on your own preferences, in the table below is the recommended reinforcement.

Flying style	Main tube spars	Wing ribbons
Ultra lightweight - duration	None	Cross ribbon, ½ length
Strong - all-purpose	Both, ½ length	Cross ribbon, full length
Super strong - speed	Both, full length	Cross and wing ribbons

Main tube spars

- Cut the tubes to the desired length, if needed. Apply a fair amount of PU or CA glue to cover the tubes and holes on the wing. Add water if PU glue is used. Insert longer tube into the hole on the back, close to the motor mount. Rotate the tube while inserting to distribute the glue evenly. Let dry and do the same for the second wing half. Remove excessive PU glue from the exit slots.



Wing ribbons

- Find the longest cross spar, if needed, and align it along the bottom slot of the wing. Apply a good amount of CA glue inside the slot. Take the spar and insert it from one end and press it into the slot. With the spar is flush against the surface, apply CA kicker (accelerator) to finish the install. Perform the same steps for the wing spars (if needed.)

Paint and decals

- The airframe can be painted to give an unique look, but this is only recommended on the white model of the TBS CAIPIRINHA. On the black model consider adhesive decals instead.
- The wing is made of EPP foam material and any regular spray paint will adhere. Use a base cover of spray adhesive, followed by spray paint, another layer of spray paint and lastly laminate film to protect the design.

Motor mount

- Before assembling the motor mount, GoPro box and battery bay support, consider painting the plywood to match the color of the wing for a nice finish.
- Assembly the three pieces and apply CA or PVA glue along the connecting ends. The balsa triangles strengthen the joint between the motor plate and the two forward-facing plates. Glue them into the corners and trim off if necessary. Attach the brushless motor to the mount using the screws provided along with the motor (2x M3x6mm). Add a drop of medium threadlock to secure the motor. Note that the screws will not be easily accessible after the mount is installed and therefore have to be tighten properly.
- On the wing, cut through the two foam beams inside the motor mount slots. Dry-fit the motor mount with the little spar notch facing down to find the right thrust angle. Position the motor mount so that it sits on the ribbon and the top front edge of the motor mount is flush with the wing. The mount should be at a 90 degrees angle if the wing is put on a flat surface. For reference, see the image below.

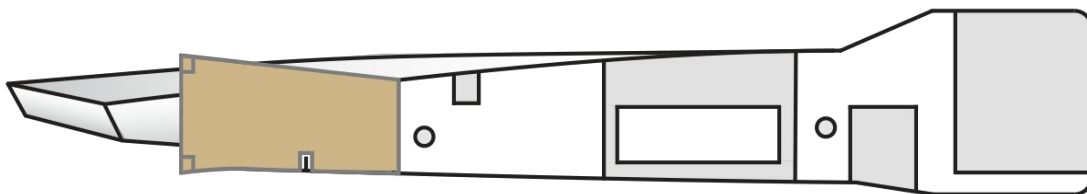

- Apply CA glue to the areas on the mount which will be in contact with the wing. Install it and use kicker to finish the mount. The kit comes with a spare motor mount plate in the event if a crash or cracked mount.



HD camera box

- In the same fashion as with the motor mount; assemble the pieces and use CA or PVA glue to secure the connecting ends. Loop one of the velcro straps around the middle of the box, with the flat side turned inward and end loop facing the top.
- Dry-fit the finished box with the two large balsa wood lobes facing rearward. Apply CA glue around the exposed areas of the box and insert it for permanent fit. Make sure to align the velcro straps properly into the foam groove on the wing. Apply pressure while the glue dries.

Elevons

- Since the lightweight elevons (elevator&aileron control) come pre-tapered and pre-laminated, the only thing left to do is to attach them to the back-top edge on either wing. Use transparent storage tape to make a flexible but sturdy hinge. The elevons should be installed to allow maximum movement (dry-fit them, it will make sense once you compare). The tapered side of the elevon (short side) is facing towards the center of the wing.
- Start by laying out a long strip of tape upside down on a flat surface and placing the elevon over the strip (1). Re-align the tape to remove any bubbles or crevices. Trim excessive tape at either end with a pair of scissors.

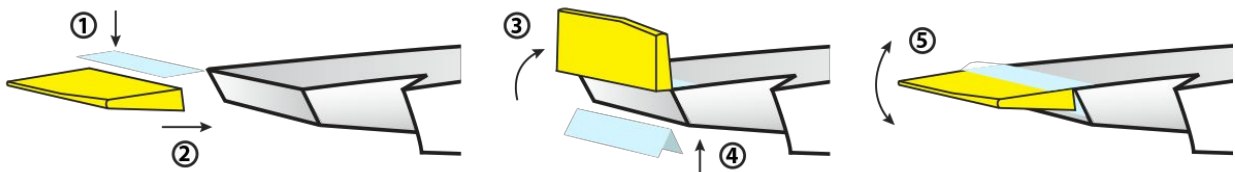

- Now, hold the elevon with a slight down-angle to make it flush with the top-curvature of the wing (2). Align the inner tapered-end of the elevon with the edge close to the motor. Touch the tape with your thumbs to attach the elevon to the wing. Go over the elevon with a cloth to properly adhere the tape to the wing.
- Next, while holding the elevon at a 90 degree angle (3), use another long strip of tape and attach it to the inside of the elevon (4). Ask someone for assisting you in this step, as it is very crucial to get right. Go over the elevon to remove any bubbles and crevices. Flex the elevon up and down a few times to soften the hinge (5). Perform the same steps for the other elevon.

Control links

- The elevons has a pre-routed slots for the control horns. Use a utility knife to cut through the mono-coat and hinge tape to expose the slot. Apply CA glue and position the control horn to be vertical and in-line with the servo arm.



- Connect the Z-shaped end of the control rods to the servo arm. And the other end to the control horn. Use a clevis to hold the L-shaped end in place. For experts only: Instead of the clevis you can also CA glue a thin piece of 2mm shrink tube to the end of the L-shape. This will reduce the weight.

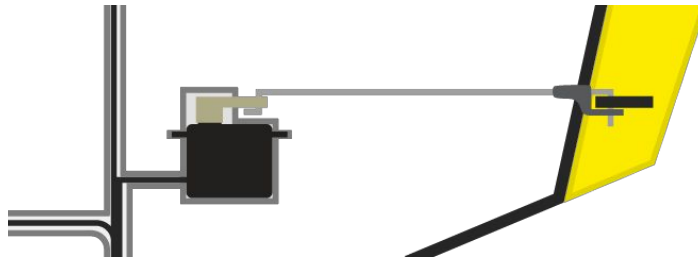

- To get optimal mechanical range (resolution) on the servo throws, use the outermost hole on the elevon control horn and the innermost on the servo arm. In neutral position, the top-side of the wing should flush with top of the elevon. Adjust the rod position to get the throws listed in the “Servos” section below.

Winglets

The kit is supplied with two kinds of winglets to give you the choice of different flight characteristics.

- **Symmetrical winglets** will give you a Zephyr-like flying characteristic, with the yaw wobble being corrected slowly with about 2-3 oscillations.

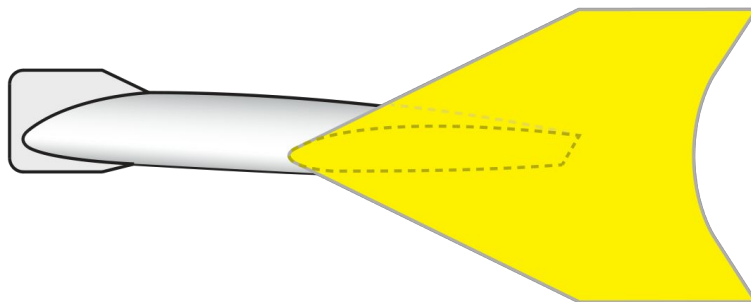

- **“Bunny-ear” winglets** are countering yaw movement more aggressively, which allows you to fly more precise but makes the shots more "nervous".

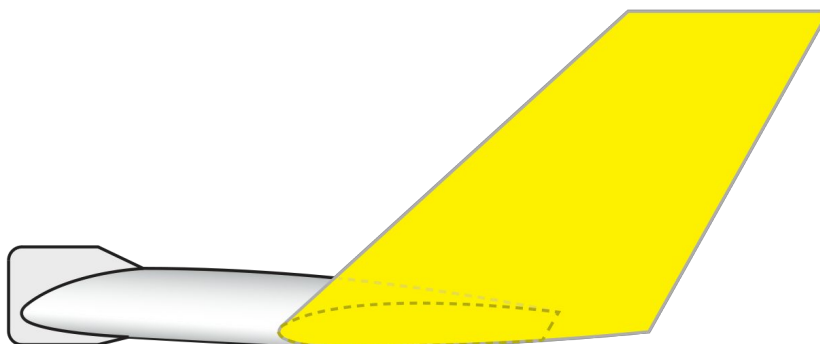

Tips: The less the winglets tips can move and flex, the better the wing will fly.

- Attaching the winglets can be done using the included adhesive back velcro strips for easy removal and transportation, or hot-glue and silicone glue/contact glue around the bead for a more permanent mount.
- The front tip of the winglet should meet the front tip-end of the wings. When using the velcro straps, apply a few drops of CA glue to the back of the adhesive pads for extra strength.

Battery bay

- The bay is designed to take a lot of abuse and prevent foam damage by the relatively huge momentum created by the mass of battery. On impact the battery support plate spreads the forces evenly across the bottom side.
- Cover the surface of the plate with CA glue and press it against the designated area under the wing until the glue dries. Feed the velcro strap with the flat side inward through the two slots. Align the velcro strap and add a small drop of glue between the velcro strap and support plate.

Note: The battery is an effective way of adjusting CG, therefore we suggest to do the following steps at the very end of your build.

Covering film

- A small note about lamination; the airframe has a thin “skin” which protects the foam and to which stickers adhere easily. Lamination is only recommended in extreme cases, in all other cases it adds unnecessary weight. The spars and ribbons will add sufficient reinforcement. Also, applying lamination over black foam can leave visible gaps between the foam faces.
- To use lamination, apply 30micron / 1mil lamination film on both sides of the wing using a hot-iron. If the foam is painted, add a layer of spray glue first.
- An alternative method is to use transparent or colored storage packing tape to cover the wing or just the leading edge of the wings to protect the foam from damage on impact.
- Covering any openings on the top to reduce drag. An even finish on the top side of the wing will ensure smooth airflow over the wing and more efficient flight.



Electronics installation

The TBS CAIPIRINHA is designed to be flown light and with any FPV equipment, powertrain and battery system, while reducing the build time to a minimum when using it with TBS- or TBS-compatible equipment. A central cable tray keeps the wires neatly tucked away. Installing the optional TBS CORE and wire harness is done in a snap.

When picking out suitable equipment, keep lightweight and small size as key factors for a successful build. High-power video transmitters (more than 600mW) are not suggested, as the close proximity of the electrical components is bound to cause interference and the added weight will cause issues attaining ideal CG.

It is worth noting that the R/C receiver and FPV transmitter is located, per design, on opposite sides of the wing to achieve reasonable separation for better RF-conditions. This helps lowering the noise floor and extend the maximum range of the system.

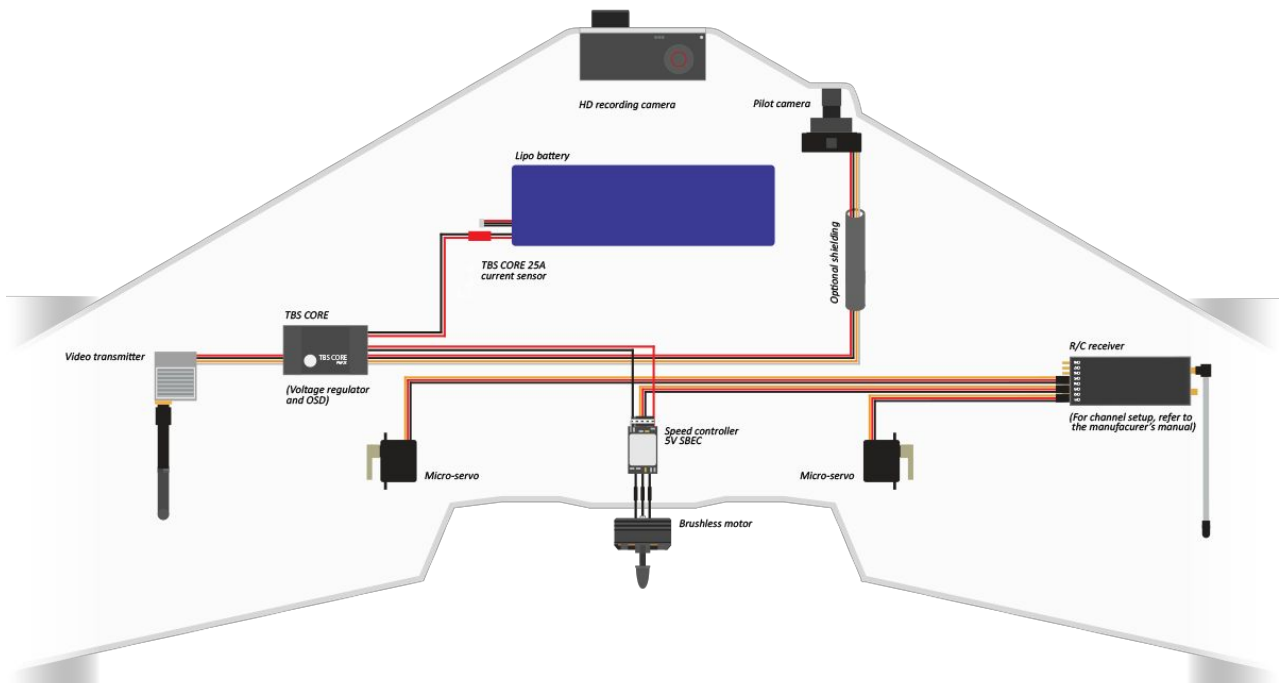

A detailed electronics installation diagram is available as an appendix to this manual.

R/C equipment

Servos

- Begin by centering the servos using a servo tester or R/C receiver with zero-trim. Add a single-armed servo horn and make sure it is positioned perpendicular (vertical) to the side of the servo. Use sub-trim on the transmitter (elevator and aileron channel), if necessary, to center it perfectly.





TBS CAIPIRINHA

mini fpv wing

Electronics installation

by ivc.no/tbscaipirinha - Jan. 2016

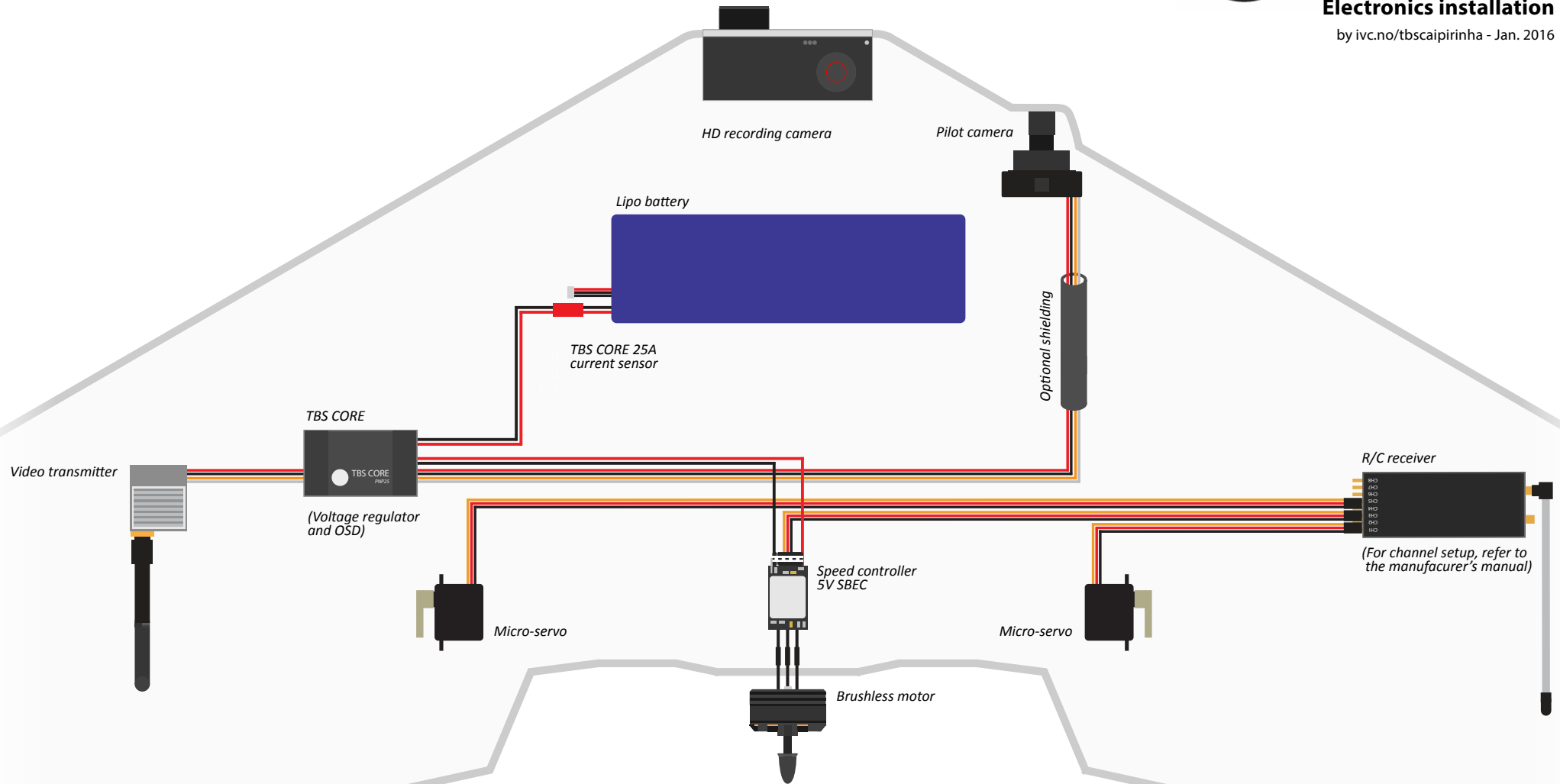

- For precise control it is important to mount the servo securely. Apply either CA glue, hot glue, or Epoxy adhesive to both the compartment and servo housing before installing it. For easy future replacement, consider wrapping the servo body with tape or thin shrink tube before applying glue. Make sure the servo cable exits properly via the slot. Because this is a permanent installation, it is recommended to use quality metal geared servos which can handle abuse and lasts for a long time.
- Program the travel range (deflection) and expo (sensitivity) for the elevator and aileron channels as listed below to ease the flying experience. Too much deflection will introduce too much turbulence and hamper the wing lift. To ease the launch of the wing, trim the elevator a few clicks pitch up from neutral.

Channel	Travel range	Expo (zero being no expo)
Aileron	10 mm down, 10 mm up	60%
Elevator	8 mm down, 8 mm up	40%

Receiver

- Place the R/C receiver over the designated compartment on the right side of the wing. Assess whether any foam has to be removed (e.g. antenna portion of an EzUHF receiver). Use a utility knife to make the necessary cuts.
- Use the supplied adhesive backed velcro strips to mount the receiver for easy access for configuration or firmware upgrades. Cover the receiver and cable slots later on with tape for an aerodynamic finish.

Speed controller

- Install the ESC directly in the middle of where the motor mount slots begins. Use part of the adhesive backed velcro to mount the ESC. Add a drop of CA on the adhesive sides for extra strength. Solder the motor wires directly to the motor or use the provided bullet-connectors (2mm). Connect the signal cable to the R/C receiver and tuck away the cable in the slot. If the signal cable is too short, use an extension servo cable to connect to the receiver.
- The recommended ESC settings are listed in the table below. Please refer to the ESC manual on how to program these settings if it is not already pre-programmed.

Setting	Value	Description
Voltage cut-off:	Low	Keep it flying until the bitter end
Cut-off mode:	Soft	Gradually decrease throttle range
Start mode:	Normal	Quick propeller spin-up
Break:	On	Prevent prop spinning freely (drag)
Timing:	High	Match the motor sync



Motor

- With the motor attached to the motor mount, feed the wires through one of the holes on the side of the mount. If needed, change the bullet-connectors to match the speed controller, or vice versa.
- Plug in the wires to the ESC and remember to swap any two to change the direction of rotation if needed.

Propeller

- Before installing the propeller, balance it to reduce vibrations from propagating to the HD recording camera. TBS offers a prop balancer for this purpose.
- Install the propeller using the following layering: *prop adaptor, propeller, washer* and *bell screw* or *(lock) nut*. Add a drop of threadlock on a non-lock nut. Make sure the top side (with printed logo) is facing the front of the wing and that the propeller is in the right direction. To change the direction of rotation of the motor, switch 2 of the 3 cables going to the speed controller.

Battery

- The battery compartment has a cable exit cut-out for a nice flush finish when using compatible batteries. Properly fasten the battery using the supplied velcro strap.
- It is recommended to use (or change to) 20 AWG rated wires and lightweight JST-, Mini Deans T- or EC2-connectors.



FPV gear

The TBS CAIPIRINHA is a dream to fly FPV and we have made a list of principles which will help you on the way to become a successful pilot. Refer to the section “Good practices” later in the manual.

TBS CORE PNP

- The wing is designed to accommodate a TBS CORE board or TBS CORE PNP to provide a rudimentary OSD and clean power distribution to the camera and video transmitter, regardless of input voltage. An optional 25A current sensor works great to provide voltage and current readout for this wing, keeping the pilot informed at all times about the battery health on his plane.
- If you are planning to fly with UHF, we highly recommend to use a shielded camera cable to isolate the CORE nicely from the rest of the electronics on the wing. The position of the CORE has been optimized to cause the least amount of interference with your UHF receivers.

Power supply

- To eliminate noise from causing problems with sensitive FPV-equipment, use a properly filtered power supply connected directly to the primary battery. Any type will work but the TBS CORE PNP is made to provide selectable 5V and/or 12V to the video transmitter and camera regardless of input voltage (2S to 10S). It can supply video transmitters with up to 1W (with minor airflow at 1W) of emitted power (EIRP) and a standard FPV camera.
- Mount the power supply in the designated area close to the video transmitter. The electronics slot is extra deep to allow for multiple regulators (5V, 12V) and other “in-line” equipment (OSD).

Wiring

- Connectors are a very frequent point of failure in many FPV systems. Plan your wiring (draw it out) and cut your wires to the right length.
- Longer wires translate to less range on a FPV system, but don't overdo it! All cables longer than 10cm should be shielded (e.g. use shielded USB cables for camera and VTx wires) to guarantee optimal long range performance. The wires should not be under tension while installed, leave ~2cm (1 inch) of excess wire just in case.

Video transmitter

- The video transmitter fits nicely on the left side of the wing, next to the electronics slot. If the bay is too small, outline the VTx and use a utility knife to remove the excessive foam. Mount the VTx and support antenna portion of the unit using hot-glue to prevent dislodging the RF connector on impact. Cover the VTx with tape for an aerodynamic finish.



Pilot camera

- On the right side of the wing is a specially designed “pod” which will house the pilot camera. Any standard 32x32mm board camera will fit, like the TBS CHIPCHIP board camera. To fit the TBS69, make small cuts in the back to remove foam or detach the heatsink. When using the stock mold it is recommended to use 28mm or narrower lens for a “no-foam-in-view” experience.
- Note: If you plan to using the 400 mm long TBS CHIPCHIP CAM cable on the CAIPIRINHA, please splice the 3-pin connector of this cable with the 3-pin connector on the original CHIPCHIP pigtail cable (included with every CHIPCHIP V2 purchase).

OSD (On Screen Display)

- You can use an optional (but recommended) OSD add-on to get live readout on screen about the battery voltage (V), current draw (A), total current consumption (mAh), receiver signal strength (%) and flight time (minutes:seconds). This gives an essential overview of the system vitals while in flight. For a basic feature set we recommend the TBS CORE PNP which provide all but the mentioned data points. For full featured GPS-enabled system, see the recommended parts section.



- The built-in 25A current sensor in the CORE PNP can display voltage and current consumption on the video downlink.
- Additionally, the readout of the received signal strength indication (RSSI) from a supported R/C receiver can be displayed (0 to 100%). All major FPV R/C system vendors support either analog or digital (PWM) RSSI output. Please read the TBS CORE documentation to find out how to configure the OSD.



Mounting HD camera

HD camera

TBS CAIPIRINHA is designed to sport a full fledged GoPro HD HERO or Xiaomi action cameras to record wonderful HD footage.

Mount it by sliding it into the GoPro box in the front and securing it by fastening the velcro strap. For the GoPro HD Hero3, you need to pad the back of the camera with a piece of foam (use one of the negative inserts).

Vibration free recordings

To get rid any “jello”-effect, begin by eliminating the root cause of the vibrations. The primary culprit is usually an unbalanced propeller. Fortunately, balancing the propeller is a relatively easy task. TBS offers a Prop Balancer which is ideal for this purpose. More details on how to perform the balancing, see our support forum at fpvlab.com.

Secondly, consider using the GoPro settings in the tables below for high quality and stable video.

GoPro settings

GoPro HD HERO1:

Video format:	NTSC	to get 30fps
Video resolution:	1080p 30fps (medium angle)	high quality video

GoPro HD HERO2:

Video format:	NTSC	to get 30fps
Video resolution:	1080p 30fps	great high quality video
Video angle:	Medium 127 degrees	less of a “fisheye” view

GoPro HD HERO3:

Video format:	NTSC	to get 30/60fps
Video resolution:	1080p 60fps	less chance of “jello”
Video angle:	Medium	less of a “fisheye” view



Center of Gravity optimization

- For perfect Center of Gravity (CG), pick equipment which is compatible with the TBS CAIPIRINHA. The CG is the point where the weight of the aircraft is balanced.
- Use a couple of steel pins or pencils to balance the complete and fully loaded wing at the recommended CG spot. When holding the wing in the air at the CG spot it should ideally be level and not dip to either side.

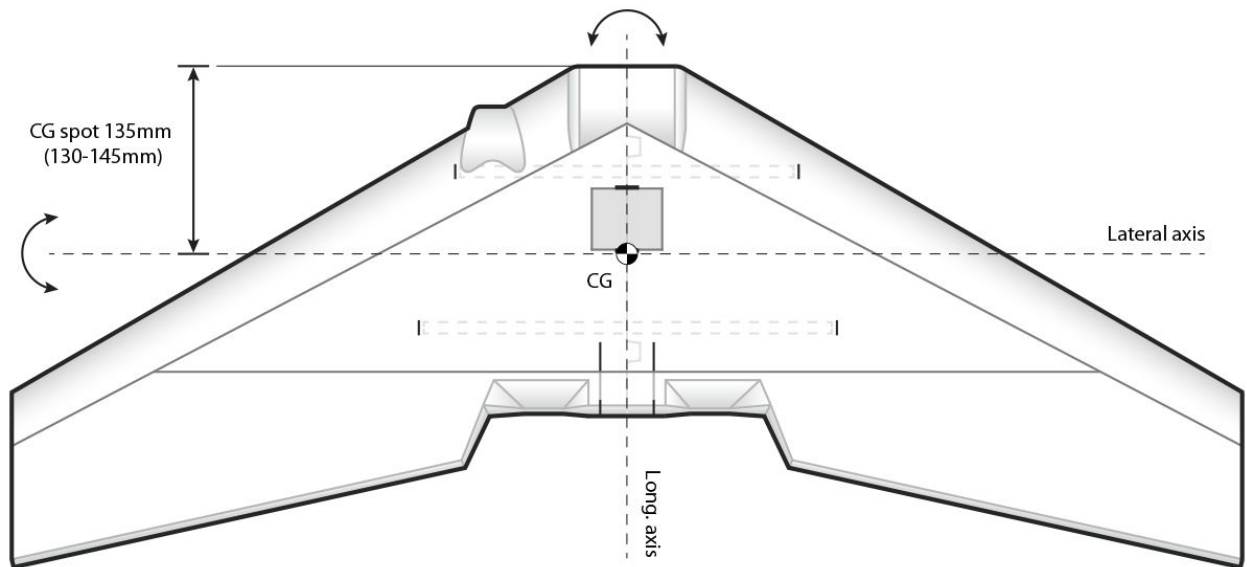

- Balance the lateral (pitch) axis within the recommended 130 to 145mm CG range from the front tip of the GoPro box, with a sweet spot at 135mm. The longitudinal (roll) axis should be balanced straight along the middle of the wing.
- To adjust the CG, move the battery fore- or aft-ward a bit by doing a cut in the foam and attach the foam cut-out to the other side of the compartment. You most likely need to move it forward.

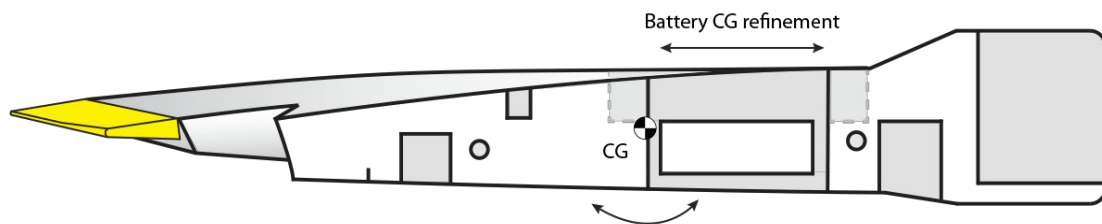

Note: Keep in mind that a slightly front heavy wing will fly, while a tail heavy wing will tend to fly very poorly or not at all.



Flight

First flight

Make sure that the controls are working properly. Check that the trim on the transmitter is centered (zeroed). Pull the elevator control stick back and observe that both elevons move upward. Push the control stick to the right and observe the right elevon moves up and the left elevon moves down. The propeller should turn with the text facing forward and the straight sharp leading-edge cut into the air.

Launch

Hold the wing by the nose with your palm up over your head and your thumb wrapped around to the top. Take a step or two forward and give the wing a good strong throw into the wind. A follow through with a little finger tip will increase the launch speed. Move the throttle stick to the full forward position when the wing is a comfortable distance from the ground.

For the first few flights ask someone to assist you, as this is a crucial step to get the wing off the ground and trimmed out.

Trim

If the wing turns in either direction or pitches with no stick input, compensate by adding 2 or 3 clicks of trim in the opposite direction. If the trim correction is not sufficient, check that the wing is balanced around the CG spot (see the previous section) and that the both elevons are flush/level in neutral position. Repeat the adjustments until the wing flies straight ahead in a glide with a slow sink rate to a sliding landing.

FPV

After the wing has been adjusted to fly straight and properly, turn on the FPV equipment and do a range test to verify that the video link is reliable. Launch the wing as normal, attain reasonable altitude flying while Line-Of-Sight (LOS), and with the video goggles on your head, put them on (or turn to the display) to engage in FPV flight. If the picture gradually weakens (noise blends in) or video suddenly drops, increase altitude and return to home, as this normally indicates that you fly at the edge of the video range or behind obstacles, respectively.



Good practices

We have compiled a list of all of the things that have been tried and tested in countless environments and situations by TBS crew and other experienced FPV pilots.

Follow these simple rules, even if rumors on the internet suggest otherwise, and you will have success in FPV.

- Start with the bare essentials and add equipment one step at a time, after each new equipment was added to proper range- and stress tests.
- Do not fly with a video system that is capable of outperforming your R/C system in terms of range.
- Do not fly with a R/C frequency higher than the video frequency (e.g. 2.4GHz R/C, 900MHz video).
- Monitor the vitals of your plane (R/C link and battery). Flying with a digital R/C link without RSSI is dangerous.
- Do not use 2.4GHz R/C unless you fly well within its range limits, in noise-free environments and always within LOS. Since this is most likely never the case, it is recommended to not use 2.4GHz R/C systems for longer range FPV.
- Do not fly at the limits of video, if you see noise in your picture, turn around and buy a higher-gain receiver antenna before going out further.
- Shielded wires or twisted cables only, anything else picks up RF noise and can cause problems.
- When using powerful R/C transmitters, make sure your ground station equipment is properly shielded.
- Adding RTH to an unreliable system does not increase the chances of getting your plane back. Work on making your system reliable without RTH first, then add RTH as an additional safety measure if you must.
- Avoid powering the VTx directly from battery, step-up or step-down the voltage and provide a constant level of power to your VTx. Make sure your VTx runs until your battery dies.
- Do not power your camera directly unless it works along the complete voltage range of your battery. Step-up or step-down the voltage and provide a constant level of power to your camera. Make sure your camera runs until your battery dies.
- A single battery system is safer than using two dedicated batteries for R/C and FPV. Two batteries in parallel even further mitigate sources of failure.
- For maximum video range and "law compatibility", use 2.4GHz video with high-gain antennas.
- When flying with R/C buddies that fly on 2.4GHz, or when flying in cities, it is perfectly possible to use 2.4GHz video provided you stick to the channels that do not lie in their band (CH5 to CH8 for Lawmate systems, available from TBS).
- Do not use diversity video receivers as a replacement for pointing your antennas, diversity should be used to mitigate polarization issues.
- Improving the antenna gain on the receiver end is better than increasing the output power (except in RF-noisy areas). More tx power causes more issues with RF on your plane. *500mW is plenty of power!*



-
- Try to achieve as much separation of the VTx and R/C receiver as possible to lower the RF noise floor and EMI interference.
 - Do not buy the cheapest equipment unless it is proven to work reliably (e.g. parts falling off, multitudes of bug fix firmware updates, community hacks and mods are a good indicator of poor quality and something you do NOT want to buy for a safe system). Do due diligence and some research before sending your aircraft skyward.



Recommended parts

Individual parts

Motor

- TBS CAIPIRINHA TBS-2206 2000kv 30g brushless motor

Speed controller

- TBS 12A CAIPIRINHA or Tiger Motors 12A ESC
- Turnigy Plush 12A speed controller
- Turnigy Plush 18A speed controller
- Hacker X-12 Pro 12A brushless ESC
- Castle Creations Thunderbird 18A brushless ESC

Servos

- TBS 9 grams micro-servo
- Hitec HS-65HB / HS-5065HB micro-servo

Battery

- TBS 2S 3300mAh 35C 177g or KYPOM KT3300/35-2S Lipo battery
- TBS 3S 2200mAh 35C 183g or KYPOM KT2200/35-3S Lipo battery
- Gens Ace 2S 3300mAh 7.4V 25C 194g Lipo pack
- Thunder Power G6 Pro Lite 2S 3300mAh 25C 168g Lipo pack
- Hyperion G3 CX 2S 3300mAh 25C 189g Lipo pack
- Turnigy nano-tech 2S 3300mah 35C 191g Lipo pack
- Zippy Flightmax 2S 3000mAh 40C 185g Lipo pack
- Turnigy 2S 3300mAh 30C 204g Lipo pack

FPV transmitter

- Lawmate TM-240500-LM 2.4GHz 500mW transmitter
- TBS ROOKIE 5.8GHz 200mW transmitter
- TBS GREENHORN 5.8GHz 25mW transmitter
- BosCam TS-353 5.8GHz 400mW transmitter
- ImmersionRC 5.8ghz 600mW A/V transmitter

FPV camera

- TBS69 or TBS59 FPV camera
- Security Camera 2000 PZ0420 or CMQ1993X (IR blocked) 600TVL camera



Spare parts

You can either get spare parts directly from us (team-blacksheep.com) or from one of our distributors and retailers near you.

Our ever-growing list of retailers is published on the left at team-blacksheep.com/shop.



Appendix

- Electronics installation diagram
- Winglet outline



*Special thanks to RiteWingRC and WindRider for making this wing possible.
Manual written and designed by ivc.no in cooperation with TBS.*



