

YEAR 4

-Textbook Based- English Worksheets

MODULE 10

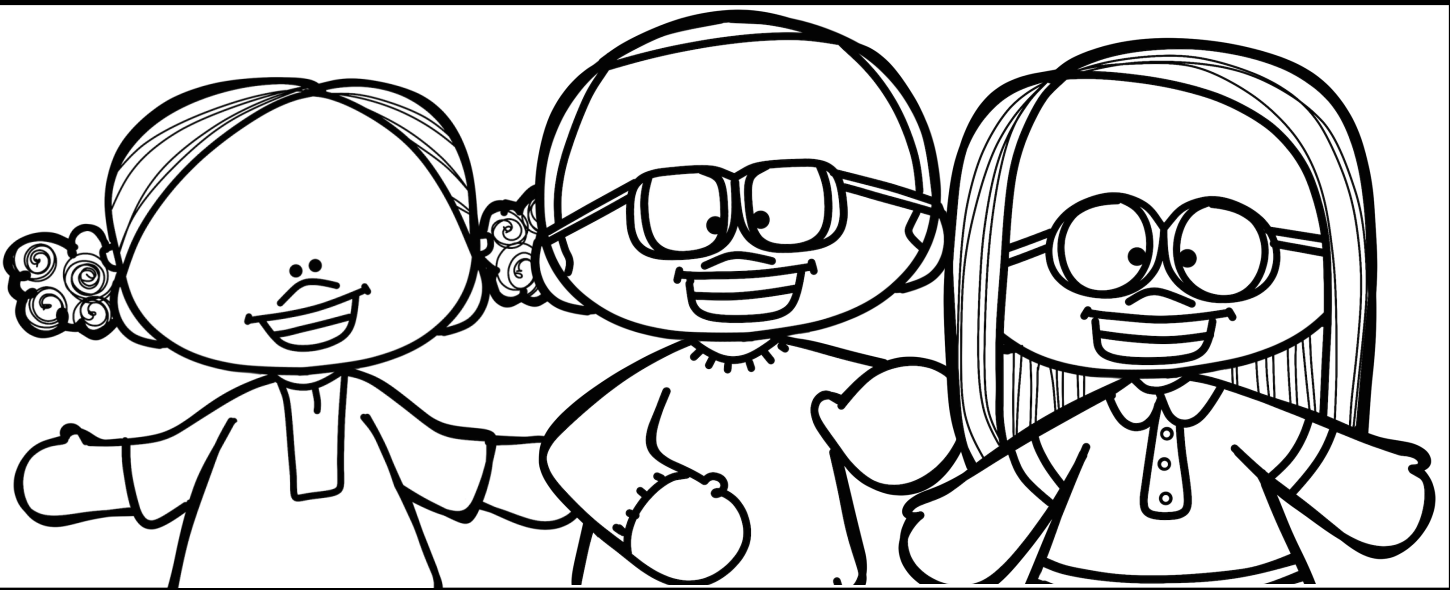

SCHOOL:

NAME:

CLASS:

TEACHER'S NAME:

WHAT'S THE MATTER?

q	w	e	r	t	y	u	i	o	p	a	s	e	d	t
a		s	d	f	g	h	j	k	l	z	x	a	c	o
v	b	n	m	q	e	s	z	r	d	x	t	r	f	o
c	v	b	v	g	y	b	h	u	i	j	n	a	m	t
s	t	o	m	a	c	h		a	c	h	e	c	n	h
m	k	l	p	o	i	u	j	n	b	h	u	h	y	a
i	o	c	o	u	g	h	p	k	j	h	u	e	t	c
h	j	k	b	a	a	s	r	t	y	u	e	w	e	h
q	w	d	f	j	k	l	m	m	n	b	v	c	c	e
s	o	r	e		t	h	r	o	a	t	e	r		t
a	s	a	d	f	g	h	h	e	a	d	a	c	h	e



headache



stomach ache



earache



toothache



sore throat



cough

Listen and sing. Then match. (page 103)

WHAT'S THE MATTER?

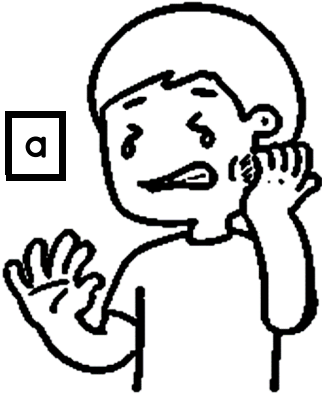

Hey, what's the matter?
I've got a stomach ache.
Why? Why? Why?
Because I ate ten pancakes!

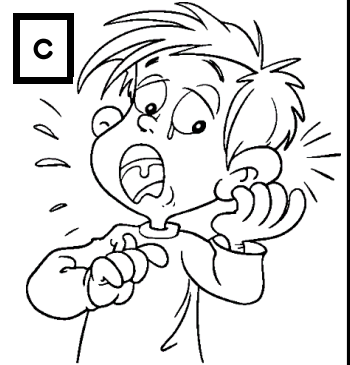

Hey, what's the matter?
I've got earache.
Why? Why? Why?
Because I swam in a cold lake!

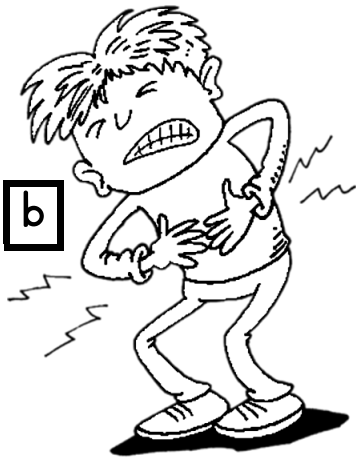

Hey, what's the matter?
I've got toothache.
Why? Why? Why?
Because I ate chocolate cake.



Hey, what's the matter?
I've got headache.
Why? Why? Why?

I don't know! But it aches, aches, aches!

Colour your answer.

Have you ever got



a stomach ache?	YES	NO
earache?	YES	NO
toothache?	YES	NO
a headache?	YES	NO
a sore throat?	YES	NO
a cough?	YES	NO
a fever?	YES	NO

Read page 104 and complete the sentences. (page 105)



should change
should clean

should sleep
should take

cast
should go

- 1 Anna broke her leg. Her leg is in a _____ .
- 2 The nurse says that Anna _____ .
- 3 Greg has got a cough and a fever. He _____ to the hospital.
- 4 Sandy hurt her leg. She _____ the cut.
- 5 The doctor says Greg _____ some medicine.
- 6 The doctor says Sandy _____ the plaster.

Listen and match. There are two extra people. (page 105)

1. Steve 2. Kelly 3. Tommy 4. Brad 5. Lisa

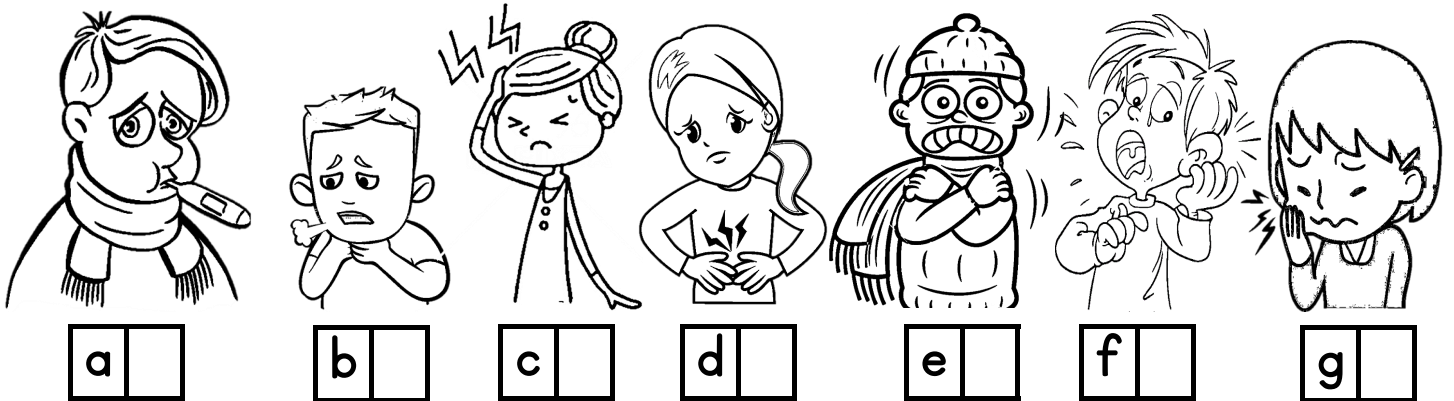

Write the suitable advice.

take some medicine sleep eat a light dinner drink lots of water and hot tea

FEVER

STOMACHACHE

HEADACHE

What should you do to stay safe at home? Listen and read. Then match the rules (1-7) to the pictures (a-g). (page 106)

SAFETY AT HOME

Stay safe at home by following these easy rules.

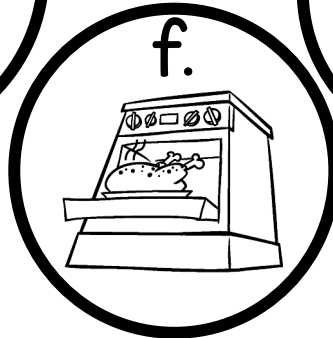
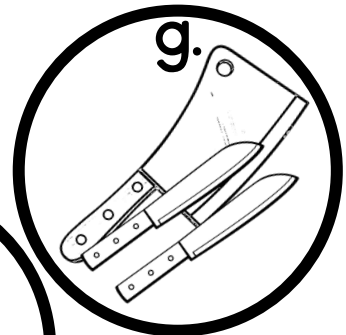
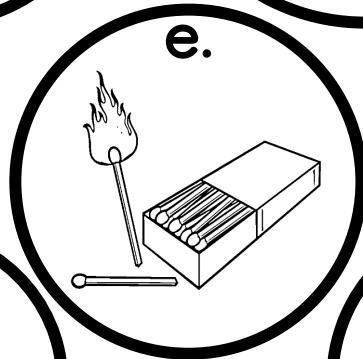
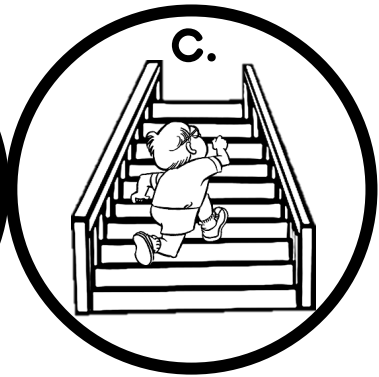
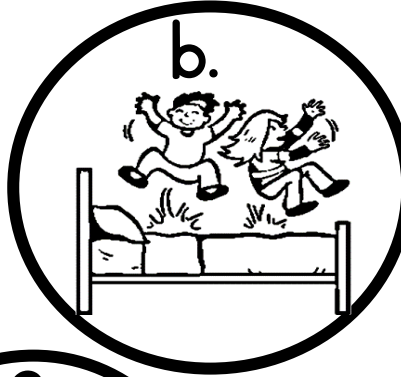
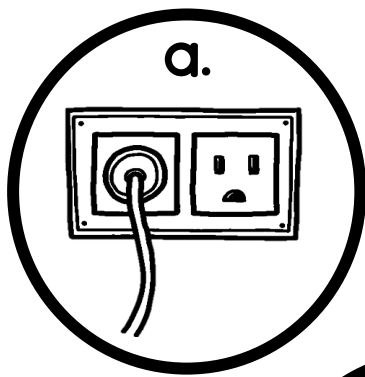

1	You shouldn't play with knives.	
2	You shouldn't touch cleaning products.	
3	You shouldn't play with matches.	
4	You shouldn't touch the oven when it's hot.	
5	You shouldn't run up and down the stairs.	
6	You shouldn't jump on your bed.	
7	You shouldn't play with sockets.	



Read page 106 and circle the correct answer.

Then write the whole sentences (page 107)

1 You should/shouldn't touch the oven when it's hot.

2 You should/shouldn't touch the cleaning products.

3 You should/shouldn't walk up and down the stairs.

4 You should/shouldn't play with matches.

5 You should/shouldn't be careful with knives.

6 You should/shouldn't play with sockets.

1

2

3

4

5

6

.....
Listen and number (1-4). (page 107)

a.



b.

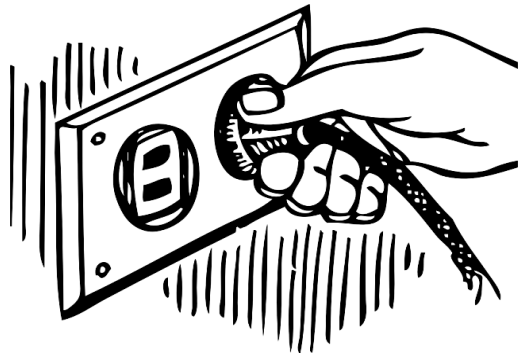

c.



d.

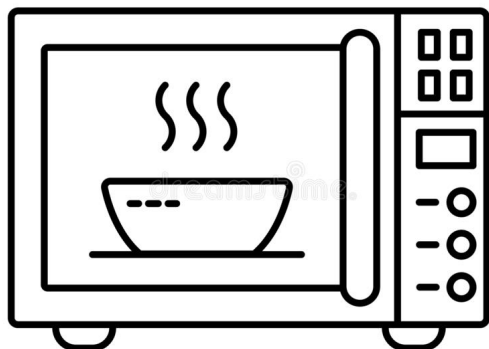



QUESTIONS			ANSWERS		
Should	I	eat more sweets?	Yes No	I	should. shouldn't.
	you			you	
	he			he	
	she			she	
	we			we	
	they			they	

No	QUESTIONS	ANSWERS
Eg:	Should I eat more sweets?	No, you shouldn't.
1		
2		
3		
4		
5		

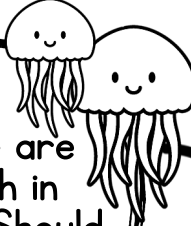

1. There are jellyfish in the sea. Should you swim?

Start

2. What's this?

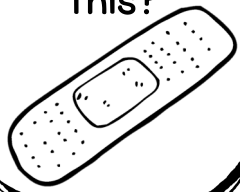

3. What are these?



4. You have got a bad cut. Go to 2 and get a plaster!

5. Should Sam eat before swimming?



6. What's this?



7. You are going to get sunburn. Go back one space and get sunscreen.

10. Paul has got a headache. What should he do?



11. What should Frank take for his sore throat?



9. What should Bill do?



12. Is this a plaster?

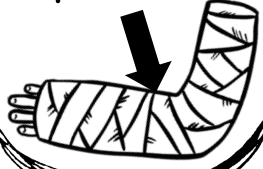

8. Should Mandy eat more sweets?



13. What's the matter with Bobby?



Finish

Think about what people should and shouldn't do at the beach.
Then make a beach safety poster. (page 109)

BEACH SAFETY

WHAT ARE GERMS?

They 1)_____ in you, on you and around you, but you 2)_____ see them. What are they? They're 3)_____. Germs are 4)_____ living things. You can see them only through a 5)_____. Some germs can make you 6)_____, so doctors work hard to 7)_____ more about them.

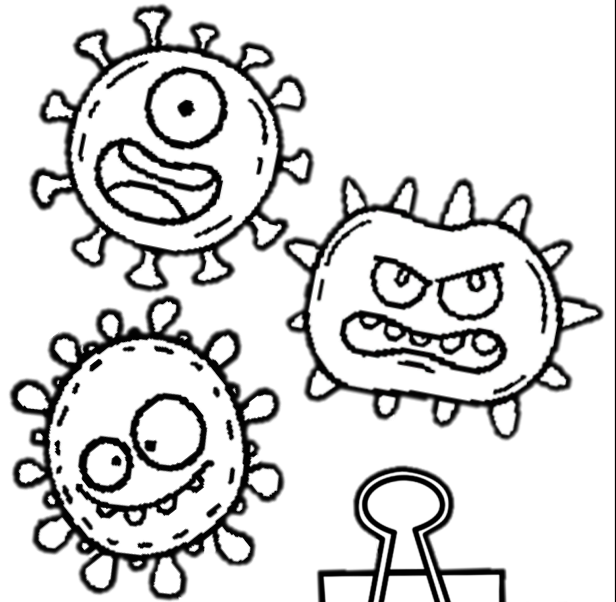

Germs like to live in 8)_____, 9)_____ and dark places. They get inside your 10)_____ through your eyes, 11)_____ and nose, and when you 12)_____ yourself.

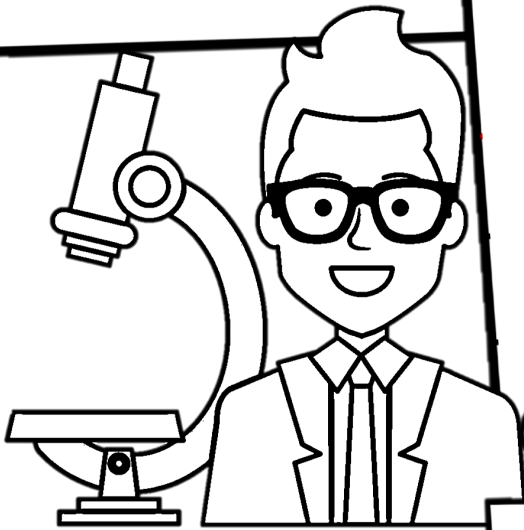

There is something we can do to 12)_____ germs. Don't 13)_____ your eyes, mouth or nose with your 14)_____. Germs hate 15)_____ and 16)_____, so you should always 17)_____ your hands 18)_____ you eat.



1 Can you see germs?

2 Why do doctors want to learn more about germs?

3 What places do germs like?

4 How can we stop germs?

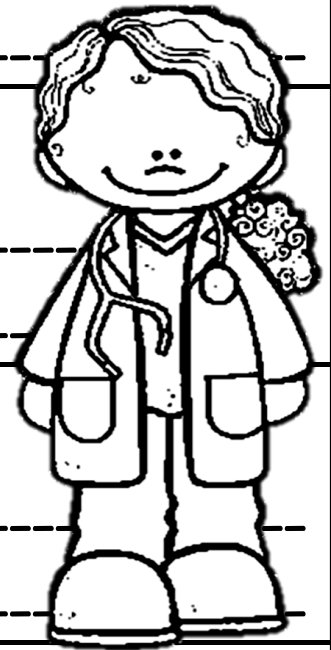

Search the words and colour.

- | | | | | |
|-------|------------|------|------|-------|
| germs | microscope | soap | wet | dark |
| ill | doctors | warm | wash | hands |

w	a	r	m	q	w	e	r	t	y	u	d	i	o	p	a	s
d	f	g	h	j	h	a	n	d	s	d	o	x	s	o	a	p
w	f	w	g	h	j	i	l	l	k	l	c	z	x	c	v	b
e	n	a	m	k	l	j	g	h	f	d	t	s	a	e	r	d
t	r	s	y	u	g	e	r	m	s	i	o	p	a	s	r	a
a	z	h	x	c	v	b	t	g	h	j	r	q	e	r	u	r
m	i	c	r	o	s	c	o	p	e	o	s	p	j	h	g	k

ALI BABA & THE 40 THIEVES

Read page 112 and match the pictures with what happened in the story. (page 113)



1



3



2



4

a. Ali Baba told his wife and brother about the treasure.

c. Ali Baba learnt about a cave where some thieves kept their treasure.

b. Cassim was happy because he was very rich.

d. Cassim forgot the words to say to open the door.

Read page 112 and circle A or B.

What did Ali Baba go into the forest to get?

- 1 A. wood
B. food

What did the thieves do in the cave?

- 2 A. They put their treasure in it.
B. They took the treasure from it.

How much of the treasure did Ali Baba take?

- 3 A. many bags
B. only a few bags

Cassim _____

- 4 A. had lots of money
B. didn't have much money

What did Cassim forget?

- 5 A. where the door was
B. how to open the door.

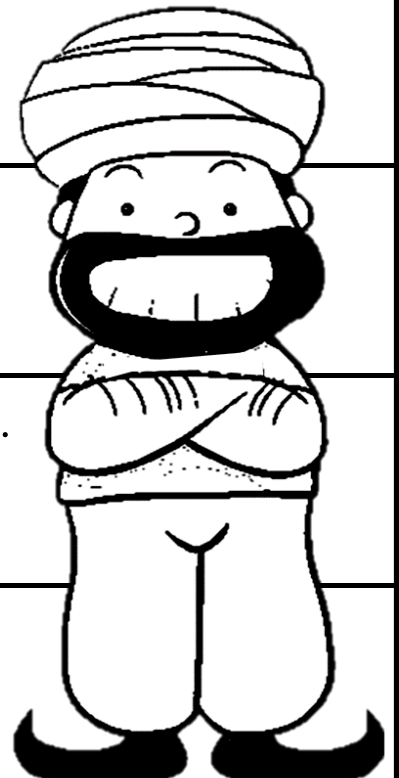

Revision 10

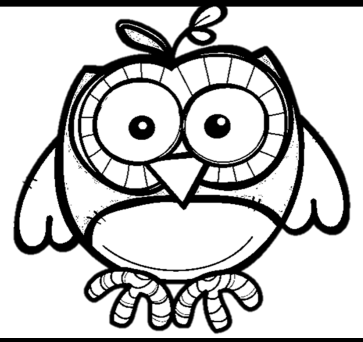
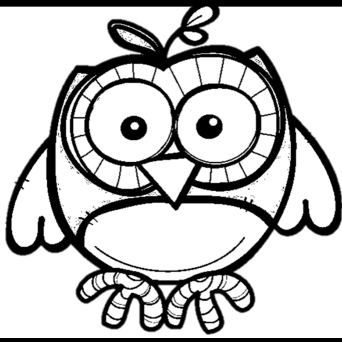

Write the correct answer. (page 114)

should

shouldn't

1 You _____ eat before you swim.

2 You _____ always put on sunscreen when you are at the beach.

3 You _____ touch the oven when it's hot.

4 You _____ clean the cut and put a plaster on it.

5 You _____ touch cleaning products.

Listen and number (1-4). (page 114)

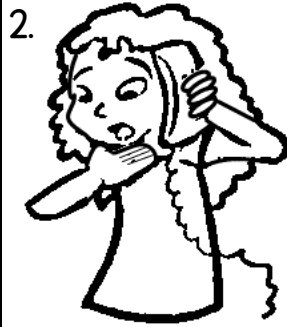

Write the correct advice. Use should or shouldn't and the ideas below.

go to the dentist's

eat sweets

sleep more

eat fruit and vegetables

take medicine

stay up late

brush your teeth

eat ice cream and cold drinks

drink some hot tea

I'm very tired.

I have toothache.

I have a sore throat.

TEETH FACTS!

Translate the words. (page 133)

1	grow	
2	bite	
3	chew	
4	soft	
5	hard	
6	bright	
7	enamel	
8	saliva	
9	gums	
10	germs	

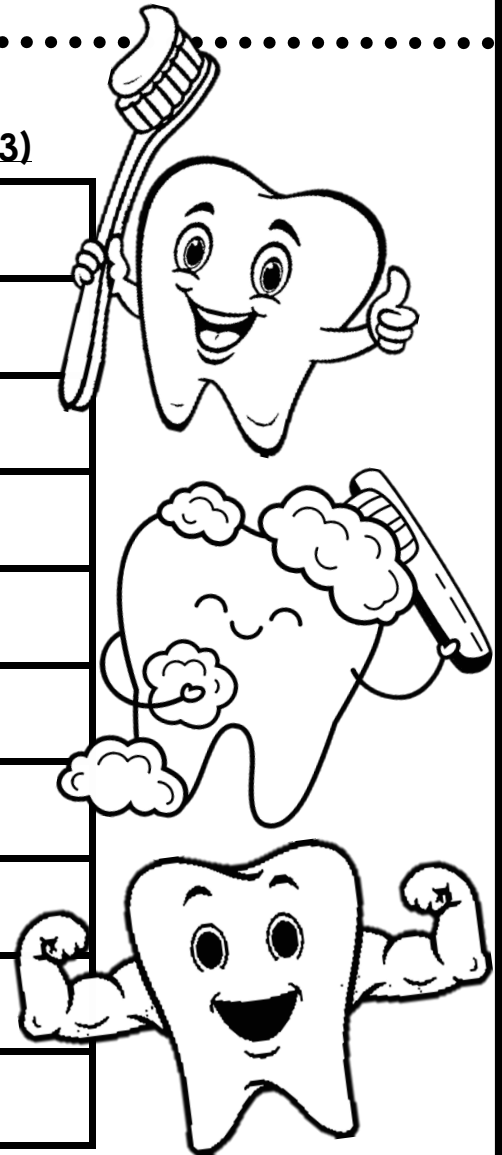

Read the text on page 133 and complete the sentence.

1 People have got _____ baby teeth.

2 We start losing our milk teeth when we are about _____ years old.

3 Saliva protects your teeth from _____.

4 To keep your teeth clean and healthy, you have to brush them two or _____ times every day.

Life Values 2

Read page 136 and colour the best title for the story.

a. A smart teacher

b. Dylan learns a lesson

c. A helping hand

Read page 136 again and put the pictures in the correct order.

Write (1-4). (page 137)

a.



b.



c.



d.



Read page 136 again and write T for True and F for False. (page 137)

1 Dylan thought that his first project was interesting.

2 Vincent wanted to do the project for his brother.

3 Dylan didn't know a lot about Dilong.

4 In the end, Dylan was sorry that he didn't do the project himself.

5 Dylan wanted his brother's help with the second project.

Complete the sentences to show cause. (page 137)

1 Dylan wasn't excited about his project because _____

2 Dylan didn't do his project because _____

3 Dylan couldn't present his project to the class because _____

4 Dylan said he was sorry because _____

5 Dylan didn't want his brother's help because _____

VIDEO WORKSHEET (EPISODE 10)

What's the matter?

..... Warm-up

Look and complete. (page 156)

1
F

2
S

3
M

4
D

5
S

6
S

7
S

8
H

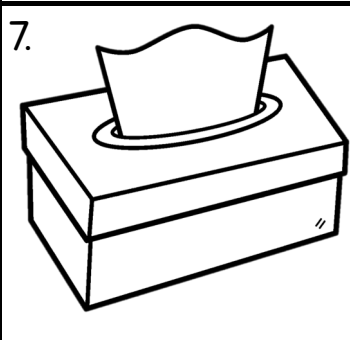
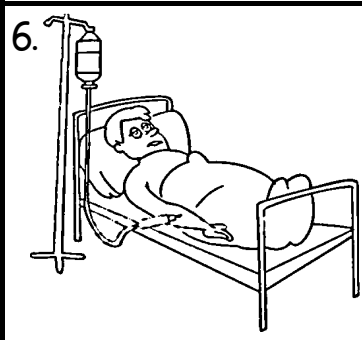
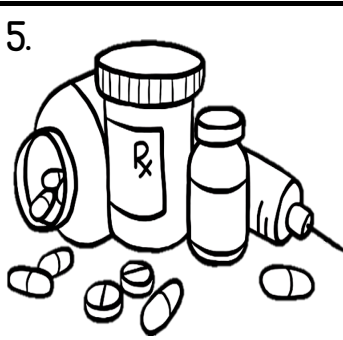
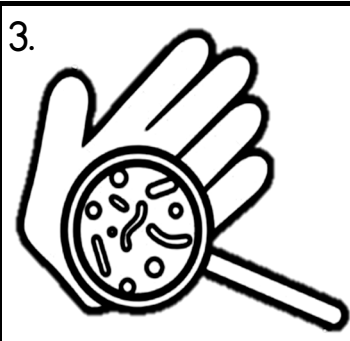
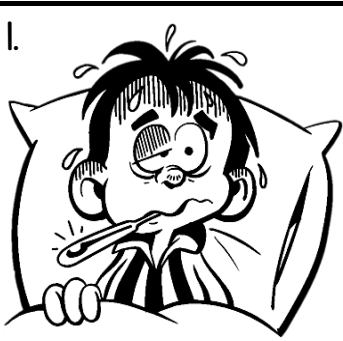

VIDEO WORKSHEET (EPISODE 10)

What's the matter?

While Watching

Watch part 2 and tick (✓) the correct answer. (page 157)

1	Anna has a _____ .	A. runny nose	B. headache
2	Anna is also _____ a lot.	A. coughing	B. sneezing
3	Anna's _____ is going to make her some tea.	A. grandmother	B. mum

Watch part 2 again and complete. (page 157)

drink tea
watch tv
get some rest

Anna should	She shouldn't

Watch part 3. Tick (✓) what you see in the video.

1. 	2. 	3. 
4. 	5. 	6. 

Watch part 3 again and complete.

1	Maybe you're catching a _____ .
2	You should stay at home and get lots of _____ .
3	You should go to the doctor and get some _____ .
4	Remember to wash your hands with and _____ water.
5	Germs can get inside your body through your eyes, mouth and _____ .
6	You should always use a _____ .