



technical data

Concealed Ceiling Unit
FXMQ-P7

air conditioning systems

R-410A



technical data

Concealed Ceiling Unit
FXMQ-P7

air conditioning systems

R-410A

TABLE OF CONTENTS

FXMQ-P7

1	Specifications	2
	Technical Specifications	2
	Electrical Specifications (50Hz)	4
	Electrical Specifications (60Hz)	4
2	Safety device settings	5
3	Control systems	5
4	Capacity tables	6
	Cooling capacity tables	6
	Heating capacity tables	8
	Capacity correction for high sensible	10
5	Dimensional drawing & centre of gravity	11
	Dimensional drawing	11
	Centre of gravity	14
6	Piping diagram	15
7	Wiring diagram	16
	Wiring diagram	16
8	Sound data	17
	Sound pressure spectrum	17
	Sound power spectrum	19
9	Fan characteristics	21
10	Installation	25
	Installation method	25
	Filter installation method	26
	Switch box connection	27

1 Specifications

1-1 Technical Specifications				FXMQ20P7	FXMQ25P7	FXMQ32P7	FXMQ40P7	FXMQ50P7	FXMQ63P7	FXMQ80P7	FXMQ100P7	FXMQ125P7
Capacity	Cooling	kW	2.2	2.8	3.6	4.5	5.6	7.1	9.0	11.2	14.0	
	Heating	kW	2.5	3.2	4.0	5.0	6.3	8.0	10.0	12.5	16.0	
Power Input (50Hz)	Cooling	kW	0.049	0.049	0.053	0.151	0.110	0.120	1.171	0.176	0.241	
	Heating	kW	0.037	0.037	0.041	0.139	0.098	0.108	0.159	0.164	0.229	
Power Input (60Hz)	Cooling	kW	0.049	0.049	0.053	0.151	0.110	0.120	1.171	0.176	0.241	
	Heating	kW	0.037	0.037	0.041	0.139	0.098	0.108	0.159	0.164	0.229	
Casing	Colour	Unpainted										
Casing	Material	Galvanised steel plate										
Dimensions	Unit	Height	mm	300								
		Width	mm	550	550	550	700	1,000	1,000	1,000	1,400	1,400
		Depth	mm	700								
Dimensions	Packed unit	Height	mm	355								
		Width	mm	770	770	770	920	1,220	1,220	1,220	1,620	1,620
		Depth	mm	900								
Weight	Unit	kg	23	23	23	26	35	35	35	46	46	
Weight	Packed unit	kg	28	28	28	32	42	42	42	54	54	
Required ceiling void		mm	350									
Heat Exchanger	Length	mm	290	290	290	440	740	740	740	1,140	1,140	
	Rows	Quantity	3									
	Fin pitch	mm	1.75									
	Passes	Quantity	3	3	3	4	7	7	7	11	11	
	Face area	m ²	0.097	0.097	0.097	0.148	0.249	0.249	0.249	0.383	0.383	
	Stages	Quantity	16									
	Empty tube hole	Quantity	12	0								
	Tube type		Hi-XSS (7)									
	Fin	Type	Symmetric waffle louvre									
		Treatment	Hydrophilic									
Fan	Type	Sirocco fan										
	Quantity		1	1	1	1	2	2	2	3	3	
	Air flow rate - 50Hz	Cooling - High	m ³ /min	9	9	9.5	16	18	19.5	25	32	39
		Cooling - Low	m ³ /min	6.5	6.5	7	11	15	16	20	23	28
		Heating - High	m ³ /min	9	9	9.5	16	18	19.5	25	32	39
		Heating - Low	m ³ /min	6.5	6.5	7	11	15	16	20	23	28
	Air flow rate - 60Hz	Cooling - High	m ³ /min	9	9	9.5	16	18	19.5	25	32	39
		Cooling - Low	m ³ /min	6.5	6.5	7	11	15	16	20	23	28
		Heating - High	m ³ /min	9	9	9.5	16	18	19.5	25	32	39
		Heating - Low	m ³ /min	6.5	6.5	7	11	15	16	20	23	28
	External static pressure - 50Hz	High	Pa	100	100	100	160	200	200	200	200	200
		Nominal	Pa	50	50	50	100					
	External static pressure - 60Hz	High	Pa	100	100	100	160	200	200	200	200	200
Nominal		Pa	50	50	50	100						
Fan motor	Model	Brushless DC motor										
	Speed	Steps	7	7	7	13	14	14	14	14	14	
	Output	High	W	90	90	90	140	350	350	350	350	
	Drive		Direct drive									
Refrigerant	Type	R-410A										
Refrigerant	Control	Electronic expansion valve										
Sound power level	Cooling	High	dBA	56	56	57	65	61	64	67	65	70
Sound pressure level	Cooling	High	dBA	33	33	34	39	41	42	43	43	44
		Nominal	dBA	31	31	32	37	39	40	41	41	42
		Low	dBA	29	29	30	35	37	38	39	39	40
	Heating	High	dBA	33	33	34	39	41	42	43	43	44
		Nominal	dBA	31	31	32	37	39	40	41	41	42
		Low	dBA	29	29	30	35	37	38	39	39	40

1 Specifications

1-1 Technical Specifications			FXMQ20P7	FXMQ25P7	FXMQ32P7	FXMQ40P7	FXMQ50P7	FXMQ63P7	FXMQ80P7	FXMQ100P7	FXMQ125P7		
Piping connections	Liquid	Type	Flare connection										
		OD	mm	6.35	6.35	6.35	6.35	6.35	9.52	9.52	9.52	9.52	
	Gas	Type	Flare connection										
		OD	mm	12.7	12.7	12.7	12.7	12.7	15.9	15.9	15.9	15.9	
	Drain	VP25 (I.D. 25/O.D. 32)											
Heat insulation	Both liquid and gas pipes												
Decoration panel	Model		BYBS32DJW1			BYBS45 DJW1		BYBS71DJW1			BYBS125DJW1		
	Colour		White (10Y9/0.5)										
	Dimensions	Height	mm	55									
		Width	mm	650	650	650	800	1,100	1,100	1,100	1,500	1,500	
		Depth	mm	500									
Weight		kg	3.0	3.0	3.0	3.5	4.5	4.5	4.5	6.5	6.5		
Drain-up height		mm	625										
Air filter		Resin net with mold resistance											
Safety devices		PC board fuse											
		PC board fuse (fan driver)											
		Drain pump fuse											
Notes		Nominal cooling capacities are based on: indoor temperature: 27°CDB/19°CWB, outdoor temperature: 35°CDB, equivalent refrigerant piping 7.5m, level difference: 0m											
		Nominal heating capacities are based on: indoor temperature: 20°CDB, outdoor temperature: 7°CDB/6°CWB, equivalent refrigerant piping 7.5m, level difference: 0m											
		Capacities are net, including a deduction for cooling (an addition for heating) for indoor fan motor heat.											
		The sound pressure values are mentioned for a unit unstalled with rear suction											

1 Specifications

1-2 Electrical Specifications (50Hz)			FXMQ20P7	FXMQ25P7	FXMQ32P7	FXMQ40P7	FXMQ50P7	FXMQ63P7	FXMQ80P7	FXMQ100P7	FXMQ125P7	
Power Supply	Name	VE										
	Phase	1~										
	Frequency	Hz	50									
	Voltage	V	220 - 240									
Current	Minimum circuit amps (MCA)	A	0.6	0.6	0.6	1.6	1.4	1.4	1.7	2.3	2.9	
	Maximum fuse amps (MFA)	A	16									
Voltage range	Minimum	V	-10%									
	Maximum	V	+10%									
Notes		Voltage range: units are suitable for use on electrical systems where voltage supplied to unit terminals is not below or above listed range limits.										
		Maximum allowable voltage range variation between phases is 2%.										

1-3 Electrical Specifications (60Hz)			FXMQ20P7	FXMQ25P7	FXMQ32P7	FXMQ40P7	FXMQ50P7	FXMQ63P7	FXMQ80P7	FXMQ100P7	FXMQ125P7	
Power Supply	Name	VE										
	Phase	1~										
	Frequency	Hz	60									
	Voltage	V	220									
Current	Minimum circuit amps (MCA)	A	0.6	0.6	0.6	1.6	1.4	1.4	1.7	2.3	2.9	
	Maximum fuse amps (MFA)	A	16									
Voltage range	Minimum	V	-10%									
	Maximum	V	+10%									
Notes		Voltage range: units are suitable for use on electrical systems where voltage supplied to unit terminals is not below or above listed range limits.										
		Maximum allowable voltage range variation between phases is 2%.										

2 Safety device settings

FXMQ-P7										
Safety devices		20	25	32	40	50	63	80	100	125
FXMQ	PC board fuse	250V 3,15A	250V 3,15A	250V 3,15A	250V 3,15A	250V 3,15A	250V 3,15A	250V 3,15A	250V 3,15A	250V 3,15A
	PC board fuse (fan driver)	250V 5A	250V 5A	250V 5A	250V 5A	250V 6,3A	250V 6,3A	250V 6,3A	250V 6,3A	250V 6,3A
	Fan motor thermal protector	°C	-	-	-	-	-	-	-	-
	Drain pump fuse	°C	145	145	145	145	145	145	145	145

3TW32659-2

3 Control systems

FXMQ-P7											
OPERATION CONTROL											
Item		Type									
Panel related	Decoration panel (*5)										
Air inlet and air discharge outlet related	Air discharge adapter for round duct										
Panel related	Decoration panel option										
		FXMQ20,25,32		FXMQ40		FXMQ50,63,80		FXMQ100,125			
		BYBS32D		BYBS45D		BYBS71D		BYBS125D			
		KDAJ25K36A		KDAJ25K56A		KDAJ25K71A		KDAJ25K140A			
		EKBYBSD									
OPERATION CONTROL											
Item		Type									
Remote control	Wired type										
	Wireless type	HP CO									
Simplified remote control											
Remote control for hotel use											
Option PCB for external el. heater, humidifier and/or hour meter (*1),(*)2,(*)3,(*)4											
Adaptor for wiring (interlock for fresh air intake fan) (*4)											
Wiring adapter for electrical appendices (1),(*)2,(*)4											
Wiring adapter for electrical appendices (2),(*)4											
Remote sensor											
Central remote control											
Residential remote control											
Electrical box with earth terminal (3 blocks)											
Unified ON/OFF control											
Electrical box with earth terminal (2 blocks)											
Schedule timer											
External adaptor for outdoor unit (installation on indoor unit) (*4)											
PCB for multi tenant (*4)											
Mounting plate for adaptor PCB											
		FXMQ20,25,32		FXMQ40		FXMQ50,63,80		FXMQ100,125			
		BRC1D52 / BRC1E51A / BRC1C62 (*6)									
		BRC4C65									
		BRC4C66									
		BRC2C51									
		BRC3A61									
		EKRP1B2A									
		KRP1C64									
		KRP2A51									
		KRP4A51									
		KRCS01-4B									
		DCS302C51 / DCS302CA61 (*6)									
		DCS303A51 (*6,7)									
		KJB311A									
		DCS301B51 / DCS301BA61 (*6)									
		KJB212A									
		DST301B51 / DST301BA61 (*6)									
		DTA104A61									
		DTA114A61									
		KRP4A96									
CONTENTS OF ACCESSORY BAG											
Description		Quantity									
Hexagon tapping screw (M5x16)		FXMQ20,25,32,40,50,63,80,100,125									
Round plain washer for wood		16									
Installation and operation manual		8									
Hose band		1									
Insulation for joint (GAS)		1									
Insulation for joint (LIQUID)		1									
Drain hose		1									
Drain hose sealing material		1									
Sealing material		2									
3TW32659-3											
NOTES											
(*1): Electrical heater and humidifier are field supply. These parts should not be installed inside the equipment (refer to installation manual EKRP1B2A).											
(*2): If installing an electrical heater, an option PCB for external electrical heater (EKRP1B2) for each indoor unit is required.											
(*3): An electrical heater can not be used for VRV system cooling only.											
(*4): Mounting plate KRP4A96 is required for these options. Maximum 2 option PCB's can be mounted.											
(*5): Decoration panel option EKBYBSD is required for direct mounting of the decoration panel on the unit.											
(*6): BRC1C62, DCS302CA61, DCS303A51, DCS301BA61 and DST301BA61: only for the Middle East region.											
(*7): For residential use only. Cannot be used with other centralised control equipment.											

4 Capacity tables

4 - 1 Cooling capacity tables

FXMQ-P7		TC: Total Capacity; kW - SHC: Sensible heat capacity; kW													
Unit size	Outdoor air temp. °CDB	14.0WB		16.0WB		18.0WB		19.0WB		20.0WB		22.0WB		24.0WB	
		20.0DB	SHC	23.0DB	SHC	26.0DB	SHC	27.0DB	SHC	28.0DB	SHC	30.0DB	SHC	32.0DB	SHC
20	10.0	1.5	1.5	1.8	1.8	2.1	1.9	2.2	1.9	2.3	1.9	2.6	2.0	2.8	2.1
	12.0	1.5	1.5	1.8	1.8	2.1	1.9	2.2	1.9	2.3	1.9	2.6	2.0	2.7	2.0
	14.0	1.5	1.5	1.8	1.8	2.1	1.9	2.2	1.9	2.3	1.9	2.6	2.0	2.7	2.0
	16.0	1.5	1.5	1.8	1.8	2.1	1.9	2.2	1.9	2.3	1.9	2.6	2.0	2.7	2.0
	18.0	1.5	1.5	1.8	1.8	2.1	1.9	2.2	1.9	2.3	1.9	2.6	2.0	2.6	2.0
	20.0	1.5	1.5	1.8	1.8	2.1	1.9	2.2	1.9	2.3	1.9	2.5	1.9	2.6	2.0
	21.0	1.5	1.5	1.8	1.8	2.1	1.9	2.2	1.9	2.3	1.9	2.5	1.9	2.6	2.0
	23.0	1.5	1.5	1.8	1.8	2.1	1.9	2.2	1.9	2.3	1.9	2.5	1.9	2.5	1.9
	25.0	1.5	1.5	1.8	1.8	2.1	1.9	2.2	1.9	2.3	1.9	2.5	1.9	2.5	1.9
	27.0	1.5	1.5	1.8	1.8	2.1	1.9	2.2	1.9	2.3	1.9	2.4	1.9	2.5	1.9
	29.0	1.5	1.5	1.8	1.8	2.1	1.9	2.2	1.9	2.3	1.9	2.4	1.8	2.4	1.9
	31.0	1.5	1.5	1.8	1.8	2.1	1.9	2.2	1.9	2.3	1.9	2.4	1.8	2.4	1.8
	33.0	1.5	1.5	1.8	1.8	2.1	1.9	2.2	1.9	2.3	1.9	2.3	1.8	2.4	1.8
	35.0	1.5	1.5	1.8	1.8	2.1	1.9	2.2	1.9	2.2	1.9	2.3	1.8	2.3	1.8
	37.0	1.5	1.5	1.8	1.8	2.1	1.9	2.2	1.9	2.2	1.8	2.2	1.7	2.3	1.8
	39.0	1.5	1.5	1.8	1.8	2.1	1.9	2.1	1.9	2.2	1.8	2.2	1.7	2.3	1.8
	25	10.0	1.9	1.8	2.3	2.0	2.6	2.3	2.8	2.3	3.0	2.3	3.3	2.4	3.5
12.0		1.9	1.8	2.3	2.0	2.6	2.3	2.8	2.3	3.0	2.3	3.3	2.4	3.5	2.4
14.0		1.9	1.8	2.3	2.0	2.6	2.3	2.8	2.3	3.0	2.3	3.3	2.4	3.4	2.4
16.0		1.9	1.8	2.3	2.0	2.6	2.3	2.8	2.3	3.0	2.3	3.3	2.4	3.4	2.4
18.0		1.9	1.8	2.3	2.0	2.6	2.3	2.8	2.3	3.0	2.3	3.3	2.4	3.4	2.4
20.0		1.9	1.8	2.3	2.0	2.6	2.3	2.8	2.3	3.0	2.3	3.2	2.3	3.3	2.3
21.0		1.9	1.8	2.3	2.0	2.6	2.3	2.8	2.3	3.0	2.3	3.2	2.3	3.3	2.3
23.0		1.9	1.8	2.3	2.0	2.6	2.3	2.8	2.3	3.0	2.3	3.2	2.3	3.2	2.3
25.0		1.9	1.8	2.3	2.0	2.6	2.3	2.8	2.3	3.0	2.3	3.1	2.3	3.2	2.3
27.0		1.9	1.8	2.3	2.0	2.6	2.3	2.8	2.3	3.0	2.3	3.1	2.2	3.2	2.3
29.0		1.9	1.8	2.3	2.0	2.6	2.3	2.8	2.3	3.0	2.3	3.0	2.2	3.1	2.2
31.0		1.9	1.8	2.3	2.0	2.6	2.3	2.8	2.3	2.9	2.3	3.0	2.2	3.1	2.2
33.0		1.9	1.8	2.3	2.0	2.6	2.3	2.8	2.3	2.9	2.3	2.9	2.2	3.0	2.2
35.0		1.9	1.8	2.3	2.0	2.6	2.3	2.8	2.3	2.8	2.2	2.9	2.1	3.0	2.2
37.0		1.9	1.8	2.3	2.0	2.6	2.3	2.8	2.3	2.8	2.2	2.9	2.1	2.9	2.1
39.0		1.9	1.8	2.3	2.0	2.6	2.3	2.7	2.2	2.7	2.2	2.8	2.1	2.9	2.1
32		10.0	2.4	2.2	2.9	2.5	3.4	2.8	3.6	2.9	3.8	2.9	4.3	3.0	4.6
	12.0	2.4	2.2	2.9	2.5	3.4	2.8	3.6	2.9	3.8	2.9	4.3	3.0	4.5	3.0
	14.0	2.4	2.2	2.9	2.5	3.4	2.8	3.6	2.9	3.8	2.9	4.3	3.0	4.4	3.0
	16.0	2.4	2.2	2.9	2.5	3.4	2.8	3.6	2.9	3.8	2.9	4.3	3.0	4.4	3.0
	18.0	2.4	2.2	2.9	2.5	3.4	2.8	3.6	2.9	3.8	2.9	4.2	3.0	4.3	2.9
	20.0	2.4	2.2	2.9	2.5	3.4	2.8	3.6	2.9	3.8	2.9	4.2	2.9	4.3	2.9
	21.0	2.4	2.2	2.9	2.5	3.4	2.8	3.6	2.9	3.8	2.9	4.1	2.9	4.2	2.9
	23.0	2.4	2.2	2.9	2.5	3.4	2.8	3.6	2.9	3.8	2.9	4.1	2.9	4.2	2.9
	25.0	2.4	2.2	2.9	2.5	3.4	2.8	3.6	2.9	3.8	2.9	4.0	2.9	4.1	2.8
	27.0	2.4	2.2	2.9	2.5	3.4	2.8	3.6	2.9	3.8	2.9	4.0	2.8	4.1	2.8
	29.0	2.4	2.2	2.9	2.5	3.4	2.8	3.6	2.9	3.8	2.9	3.9	2.8	4.0	2.8
	31.0	2.4	2.2	2.9	2.5	3.4	2.8	3.6	2.9	3.8	2.9	3.8	2.8	3.9	2.7
	33.0	2.4	2.2	2.9	2.5	3.4	2.8	3.6	2.9	3.7	2.8	3.8	2.7	3.9	2.7
	35.0	2.4	2.2	2.9	2.5	3.4	2.8	3.6	2.9	3.6	2.8	3.7	2.7	3.8	2.7
	37.0	2.4	2.2	2.9	2.5	3.4	2.8	3.5	2.8	3.6	2.8	3.7	2.7	3.8	2.7
	39.0	2.4	2.2	2.9	2.5	3.4	2.8	3.5	2.8	3.5	2.7	3.6	2.6	3.7	2.6
	40	10.0	3.0	2.9	3.6	3.4	4.2	3.8	4.5	3.8	4.8	3.8	5.4	3.9	5.7
12.0		3.0	2.9	3.6	3.4	4.2	3.8	4.5	3.8	4.8	3.8	5.4	3.9	5.6	4.0
14.0		3.0	2.9	3.6	3.4	4.2	3.8	4.5	3.8	4.8	3.8	5.4	3.9	5.5	4.0
16.0		3.0	2.9	3.6	3.4	4.2	3.8	4.5	3.8	4.8	3.8	5.4	3.9	5.5	3.9
18.0		3.0	2.9	3.6	3.4	4.2	3.8	4.5	3.8	4.8	3.8	5.3	3.9	5.4	3.9
20.0		3.0	2.9	3.6	3.4	4.2	3.8	4.5	3.8	4.8	3.8	5.2	3.8	5.3	3.9
21.0		3.0	2.9	3.6	3.4	4.2	3.8	4.5	3.8	4.8	3.8	5.2	3.8	5.3	3.8
23.0		3.0	2.9	3.6	3.4	4.2	3.8	4.5	3.8	4.8	3.8	5.1	3.8	5.2	3.8
25.0		3.0	2.9	3.6	3.4	4.2	3.8	4.5	3.8	4.8	3.8	5.0	3.7	5.1	3.8
27.0		3.0	2.9	3.6	3.4	4.2	3.8	4.5	3.8	4.8	3.8	5.0	3.7	5.1	3.7
29.0		3.0	2.9	3.6	3.4	4.2	3.8	4.5	3.8	4.8	3.8	4.9	3.7	5.0	3.7
31.0		3.0	2.9	3.6	3.4	4.2	3.8	4.5	3.8	4.7	3.8	4.8	3.6	4.9	3.6
33.0		3.0	2.9	3.6	3.4	4.2	3.8	4.5	3.8	4.6	3.7	4.7	3.6	4.8	3.6
35.0		3.0	2.9	3.6	3.4	4.2	3.8	4.5	3.8	4.6	3.7	4.7	3.5	4.8	3.6
37.0		3.0	2.9	3.6	3.4	4.2	3.8	4.4	3.8	4.5	3.6	4.6	3.5	4.7	3.5
39.0		3.0	2.9	3.6	3.4	4.2	3.8	4.4	3.7	4.4	3.6	4.5	3.4	4.6	3.5
50		10.0	3.8	3.6	4.5	4.1	5.2	4.5	5.6	4.6	6.0	4.6	6.7	4.8	7.1
	12.0	3.8	3.6	4.5	4.1	5.2	4.5	5.6	4.6	6.0	4.6	6.7	4.8	7.0	4.3
	14.0	3.8	3.6	4.5	4.1	5.2	4.5	5.6	4.6	6.0	4.6	6.7	4.8	6.9	4.2
	16.0	3.8	3.6	4.5	4.1	5.2	4.5	5.6	4.6	6.0	4.6	6.7	4.8	6.8	4.1
	18.0	3.8	3.6	4.5	4.1	5.2	4.5	5.6	4.6	6.0	4.6	6.6	4.7	6.7	4.1
	20.0	3.8	3.6	4.5	4.1	5.2	4.5	5.6	4.6	6.0	4.6	6.5	4.7	6.6	4.0
	21.0	3.8	3.6	4.5	4.1	5.2	4.5	5.6	4.6	6.0	4.6	6.4	4.6	6.6	4.0
	23.0	3.8	3.6	4.5	4.1	5.2	4.5	5.6	4.6	6.0	4.6	6.4	4.6	6.5	4.0
	25.0	3.8	3.6	4.5	4.1	5.2	4.5	5.6	4.6	6.0	4.6	6.3	4.5	6.4	3.9
	27.0	3.8	3.6	4.5	4.1	5.2	4.5	5.6	4.6	6.0	4.6	6.2	4.5	6.3	3.8
	29.0	3.8	3.6	4.5	4.1	5.2	4.5	5.6	4.6	5.9	4.6	6.1	4.4	6.2	3.8
	31.0	3.8	3.6	4.5	4.1	5.2	4.5	5.6	4.6	5.9	4.6	6.0	4.4	6.1	3.7
	33.0	3.8	3.6	4.5	4.1	5.2	4.5	5.6	4.6	5.8	4.5	5.9	4.3	6.0	3.7
	35.0	3.8	3.6	4.5	4.1	5.2	4.5	5.6	4.6	5.7	4.5	5.8	4.3	5.9	3.6
	37.0	3.8	3.6	4.5	4.1	5.2	4.5	5.5	4.6	5.6	4.4	5.7	4.2	5.8	3.6
	39.0	3.8	3.6	4.5	4.1	5.2	4.5	5.4	4.5	5.5	4.4	5.6	4.2	5.8	3.5

4 Capacity tables

4 - 1 Cooling capacity tables

FXMQ-P7		TC: Total Capacity; kW - SHC: Sensible heat capacity; kW													
Unit size	Outdoor air temp.	14.0WB		16.0WB		18.0WB		19.0WB		20.0WB		22.0WB		24.0WB	
		20.0DB		23.0DB		26.0DB		27.0DB		28.0DB		30.0DB		32.0DB	
	°CDB	TC	SHC	TC	SHC	TC	SHC	TC	SHC	TC	SHC	TC	SHC	TC	SHC
63	10.0	4.8	4.2	5.7	4.9	6.6	5.4	7.1	5.5	7.6	5.6	8.5	5.8	9.0	6.4
	12.0	4.8	4.2	5.7	4.9	6.6	5.4	7.1	5.5	7.6	5.6	8.5	5.8	8.9	6.3
	14.0	4.8	4.2	5.7	4.9	6.6	5.4	7.1	5.5	7.6	5.6	8.5	5.8	8.7	6.3
	16.0	4.8	4.2	5.7	4.9	6.6	5.4	7.1	5.5	7.6	5.6	8.5	5.8	8.6	6.3
	18.0	4.8	4.2	5.7	4.9	6.6	5.4	7.1	5.5	7.6	5.6	8.3	5.8	8.5	6.2
	20.0	4.8	4.2	5.7	4.9	6.6	5.4	7.1	5.5	7.6	5.6	8.2	5.7	8.4	6.2
	21.0	4.8	4.2	5.7	4.9	6.6	5.4	7.1	5.5	7.6	5.6	8.2	5.7	8.3	6.2
	23.0	4.8	4.2	5.7	4.9	6.6	5.4	7.1	5.5	7.6	5.6	8.1	5.6	8.2	6.1
	25.0	4.8	4.2	5.7	4.9	6.6	5.4	7.1	5.5	7.6	5.6	7.9	5.6	8.1	6.1
	27.0	4.8	4.2	5.7	4.9	6.6	5.4	7.1	5.5	7.6	5.6	7.8	5.5	8.0	6.1
	29.0	4.8	4.2	5.7	4.9	6.6	5.4	7.1	5.5	7.5	5.6	7.7	5.4	7.9	6.0
	31.0	4.8	4.2	5.7	4.9	6.6	5.4	7.1	5.5	7.4	5.5	7.6	5.4	7.8	6.0
	33.0	4.8	4.2	5.7	4.9	6.6	5.4	7.1	5.5	7.3	5.5	7.5	5.3	7.6	5.9
	35.0	4.8	4.2	5.7	4.9	6.6	5.4	7.1	5.5	7.2	5.4	7.4	5.3	7.5	5.9
	37.0	4.8	4.2	5.7	4.9	6.6	5.4	7.0	5.5	7.1	5.4	7.2	5.2	7.4	5.9
	39.0	4.8	4.2	5.7	4.9	6.6	5.4	6.9	5.4	7.0	5.3	7.1	5.1	7.3	5.8
80	10.0	6.1	5.3	7.2	6.1	8.4	6.9	9.0	7.0	9.6	7.1	10.8	7.4	11.4	7.4
	12.0	6.1	5.3	7.2	6.1	8.4	6.9	9.0	7.0	9.6	7.1	10.8	7.4	11.2	7.4
	14.0	6.1	5.3	7.2	6.1	8.4	6.9	9.0	7.0	9.6	7.1	10.8	7.4	11.1	7.3
	16.0	6.1	5.3	7.2	6.1	8.4	6.9	9.0	7.0	9.6	7.1	10.7	7.4	10.9	7.2
	18.0	6.1	5.3	7.2	6.1	8.4	6.9	9.0	7.0	9.6	7.1	10.6	7.3	10.8	7.2
	20.0	6.1	5.3	7.2	6.1	8.4	6.9	9.0	7.0	9.6	7.1	10.4	7.2	10.6	7.1
	21.0	6.1	5.3	7.2	6.1	8.4	6.9	9.0	7.0	9.6	7.1	10.4	7.2	10.6	7.1
	23.0	6.1	5.3	7.2	6.1	8.4	6.9	9.0	7.0	9.6	7.1	10.2	7.1	10.4	7.0
	25.0	6.1	5.3	7.2	6.1	8.4	6.9	9.0	7.0	9.6	7.1	10.1	7.0	10.3	6.9
	27.0	6.1	5.3	7.2	6.1	8.4	6.9	9.0	7.0	9.6	7.1	9.9	7.0	10.1	6.9
	29.0	6.1	5.3	7.2	6.1	8.4	6.9	9.0	7.0	9.5	7.1	9.8	6.9	10.0	6.8
	31.0	6.1	5.3	7.2	6.1	8.4	6.9	9.0	7.0	9.4	7.0	9.6	6.8	9.8	6.7
	33.0	6.1	5.3	7.2	6.1	8.4	6.9	9.0	7.0	9.3	7.0	9.5	6.7	9.7	6.7
	35.0	6.1	5.3	7.2	6.1	8.4	6.9	9.0	7.0	9.1	6.9	9.3	6.6	9.5	6.6
	37.0	6.1	5.3	7.2	6.1	8.4	6.9	8.9	6.9	9.0	6.8	9.2	6.6	9.4	6.5
	39.0	6.1	5.3	7.2	6.1	8.4	6.9	8.7	6.8	8.8	6.7	9.0	6.5	9.3	6.5
100	10.0	7.6	6.4	9.0	7.3	10.5	8.3	11.2	8.5	11.9	8.7	13.4	9.0	14.2	8.9
	12.0	7.6	6.4	9.0	7.3	10.5	8.3	11.2	8.5	11.9	8.7	13.4	9.0	14.0	8.9
	14.0	7.6	6.4	9.0	7.3	10.5	8.3	11.2	8.5	11.9	8.7	13.4	9.0	13.8	8.8
	16.0	7.6	6.4	9.0	7.3	10.5	8.3	11.2	8.5	11.9	8.7	13.3	9.0	13.6	8.7
	18.0	7.6	6.4	9.0	7.3	10.5	8.3	11.2	8.5	11.9	8.7	13.2	8.9	13.4	8.6
	20.0	7.6	6.4	9.0	7.3	10.5	8.3	11.2	8.5	11.9	8.7	13.0	8.8	13.2	8.5
	21.0	7.6	6.4	9.0	7.3	10.5	8.3	11.2	8.5	11.9	8.7	12.9	8.8	13.2	8.5
	23.0	7.6	6.4	9.0	7.3	10.5	8.3	11.2	8.5	11.9	8.7	12.7	8.7	13.0	8.4
	25.0	7.6	6.4	9.0	7.3	10.5	8.3	11.2	8.5	11.9	8.7	12.5	8.6	12.8	8.3
	27.0	7.6	6.4	9.0	7.3	10.5	8.3	11.2	8.5	11.9	8.7	12.3	8.5	12.6	8.2
	29.0	7.6	6.4	9.0	7.3	10.5	8.3	11.2	8.5	11.9	8.6	12.2	8.4	12.4	8.1
	31.0	7.6	6.4	9.0	7.3	10.5	8.3	11.2	8.5	11.7	8.5	12.0	8.3	12.2	8.0
	33.0	7.6	6.4	9.0	7.3	10.5	8.3	11.2	8.5	11.5	8.5	11.8	8.2	12.1	7.9
	35.0	7.6	6.4	9.0	7.3	10.5	8.3	11.2	8.5	11.3	8.4	11.6	8.1	11.9	7.8
	37.0	7.6	6.4	9.0	7.3	10.5	8.3	11.0	8.4	11.2	8.3	11.4	8.0	11.7	7.7
	39.0	7.6	6.4	9.0	7.3	10.5	8.3	10.8	8.3	11.0	8.2	11.2	7.9	11.5	7.6
125	10.0	9.4	8.0	11.3	9.2	13.1	10.3	14.0	10.5	14.9	10.8	16.7	11.1	17.7	11.1
	12.0	9.4	8.0	11.3	9.2	13.1	10.3	14.0	10.5	14.9	10.8	16.7	11.1	17.5	11.0
	14.0	9.4	8.0	11.3	9.2	13.1	10.3	14.0	10.5	14.9	10.8	16.7	11.1	17.2	10.9
	16.0	9.4	8.0	11.3	9.2	13.1	10.3	14.0	10.5	14.9	10.8	16.7	11.1	17.0	10.8
	18.0	9.4	8.0	11.3	9.2	13.1	10.3	14.0	10.5	14.9	10.8	16.4	11.0	16.8	10.7
	20.0	9.4	8.0	11.3	9.2	13.1	10.3	14.0	10.5	14.9	10.8	16.2	10.9	16.6	10.6
	21.0	9.4	8.0	11.3	9.2	13.1	10.3	14.0	10.5	14.9	10.8	16.1	10.9	16.4	10.5
	23.0	9.4	8.0	11.3	9.2	13.1	10.3	14.0	10.5	14.9	10.8	15.9	10.8	16.2	10.4
	25.0	9.4	8.0	11.3	9.2	13.1	10.3	14.0	10.5	14.9	10.8	15.6	10.6	16.0	10.3
	27.0	9.4	8.0	11.3	9.2	13.1	10.3	14.0	10.5	14.9	10.8	15.4	10.5	15.8	10.2
	29.0	9.4	8.0	11.3	9.2	13.1	10.3	14.0	10.5	14.9	10.7	15.2	10.4	15.5	10.1
	31.0	9.4	8.0	11.3	9.2	13.1	10.3	14.0	10.5	14.6	10.6	15.0	10.3	15.3	10.0
	33.0	9.4	8.0	11.3	9.2	13.1	10.3	14.0	10.5	14.4	10.5	14.7	10.2	15.1	9.8
	35.0	9.4	8.0	11.3	9.2	13.1	10.3	14.0	10.5	14.2	10.4	14.5	10.1	14.9	9.7
	37.0	9.4	8.0	11.3	9.2	13.1	10.3	13.8	10.4	13.9	10.3	14.3	10.0	14.6	9.6
	39.0	9.4	8.0	11.3	9.2	13.1	10.3	13.5	10.3	13.7	10.2	14.1	9.9	14.4	9.5

4 Capacity tables

4 - 2 Heating capacity tables

FXMQ-P7								
Unit size	Outdoor air temp.		Indoor air temperature: °CDB					
	°CDB	°CWB	16.0	18.0	20.0	21.0	22.0	24.0
			kW	kW	kW	kW	kW	kW
20	-19.8	-20.0	1.5	1.5	1.5	1.5	1.5	1.5
	-18.8	-19.0	1.5	1.5	1.5	1.5	1.5	1.5
	-16.7	-17.0	1.6	1.6	1.6	1.6	1.6	1.6
	-14.7	-15.0	1.7	1.7	1.7	1.7	1.7	1.7
	-12.6	-13.0	1.8	1.8	1.8	1.8	1.8	1.8
	-10.5	-11.0	1.9	1.9	1.9	1.9	1.9	1.9
	-9.5	-10.0	1.9	1.9	1.9	1.9	1.9	1.9
	-8.5	-9.1	2.0	2.0	1.9	1.9	1.9	1.9
	-7.0	-7.6	2.0	2.0	2.0	2.0	2.0	2.0
	-5.0	-5.6	2.1	2.1	2.1	2.1	2.1	2.1
	-3.0	-3.7	2.2	2.2	2.2	2.2	2.2	2.2
	0.0	-0.7	2.3	2.3	2.3	2.3	2.3	2.2
	3.0	2.2	2.5	2.5	2.4	2.4	2.3	2.2
	5.0	4.1	2.5	2.5	2.5	2.4	2.3	2.2
	7.0	6.0	2.6	2.6	2.5	2.4	2.3	2.2
	9.0	7.9	2.7	2.7	2.5	2.4	2.3	2.2
11.0	9.8	2.8	2.7	2.5	2.4	2.3	2.2	
13.0	11.8	2.8	2.7	2.5	2.4	2.3	2.2	
15.0	13.7	2.8	2.7	2.5	2.4	2.3	2.2	
25	-19.8	-20.0	1.9	1.9	1.9	1.9	1.9	1.9
	-18.8	-19.0	1.9	1.9	1.9	1.9	1.9	1.9
	-16.7	-17.0	2.1	2.1	2.0	2.0	2.0	2.0
	-14.7	-15.0	2.2	2.2	2.2	2.2	2.1	2.1
	-12.6	-13.0	2.3	2.3	2.3	2.3	2.3	2.3
	-10.5	-11.0	2.4	2.4	2.4	2.4	2.4	2.4
	-9.5	-10.0	2.5	2.4	2.4	2.4	2.4	2.4
	-8.5	-9.1	2.5	2.5	2.5	2.5	2.5	2.5
	-7.0	-7.6	2.6	2.6	2.6	2.6	2.6	2.6
	-5.0	-5.6	2.7	2.7	2.7	2.7	2.7	2.7
	-3.0	-3.7	2.8	2.8	2.8	2.8	2.8	2.8
	0.0	-0.7	3.0	3.0	3.0	3.0	3.0	2.8
	3.0	2.2	3.1	3.1	3.1	3.1	3.0	2.8
	5.0	4.1	3.3	3.2	3.2	3.1	3.0	2.8
	7.0	6.0	3.4	3.4	3.2	3.1	3.0	2.8
	9.0	7.9	3.5	3.4	3.2	3.1	3.0	2.8
11.0	9.8	3.6	3.4	3.2	3.1	3.0	2.8	
13.0	11.8	3.6	3.4	3.2	3.1	3.0	2.8	
15.0	13.7	3.6	3.4	3.2	3.1	3.0	2.8	
32	-19.8	-20.0	2.4	2.4	2.3	2.3	2.3	2.3
	-18.8	-19.0	2.4	2.4	2.4	2.4	2.4	2.4
	-16.7	-17.0	2.6	2.6	2.6	2.6	2.6	2.5
	-14.7	-15.0	2.7	2.7	2.7	2.7	2.7	2.7
	-12.6	-13.0	2.9	2.8	2.8	2.8	2.8	2.8
	-10.5	-11.0	3.0	3.0	3.0	3.0	3.0	3.0
	-9.5	-10.0	3.1	3.1	3.1	3.1	3.0	3.0
	-8.5	-9.1	3.1	3.1	3.1	3.1	3.1	3.1
	-7.0	-7.6	3.2	3.2	3.2	3.2	3.2	3.2
	-5.0	-5.6	3.4	3.4	3.4	3.4	3.4	3.4
	-3.0	-3.7	3.5	3.5	3.5	3.5	3.5	3.5
	0.0	-0.7	3.7	3.7	3.7	3.7	3.7	3.5
	3.0	2.2	3.9	3.9	3.9	3.9	3.7	3.5
	5.0	4.1	4.1	4.1	4.0	3.9	3.7	3.5
	7.0	6.0	4.2	4.2	4.0	3.9	3.7	3.5
	9.0	7.9	4.3	4.3	4.0	3.9	3.7	3.5
11.0	9.8	4.5	4.3	4.0	3.9	3.7	3.5	
13.0	11.8	4.5	4.3	4.0	3.9	3.7	3.5	
15.0	13.7	4.5	4.3	4.0	3.9	3.7	3.5	
40	-19.8	-20.0	3.0	2.9	2.9	2.9	2.9	2.9
	-18.8	-19.0	3.0	3.0	3.0	3.0	3.0	3.0
	-16.7	-17.0	3.2	3.2	3.2	3.2	3.2	3.2
	-14.7	-15.0	3.4	3.4	3.4	3.4	3.4	3.4
	-12.6	-13.0	3.6	3.6	3.6	3.5	3.5	3.5
	-10.5	-11.0	3.7	3.7	3.7	3.7	3.7	3.7
	-9.5	-10.0	3.8	3.8	3.8	3.8	3.8	3.8
	-8.5	-9.1	3.9	3.9	3.9	3.9	3.9	3.9
	-7.0	-7.6	4.0	4.0	4.0	4.0	4.0	4.0
	-5.0	-5.6	4.2	4.2	4.2	4.2	4.2	4.2
	-3.0	-3.7	4.4	4.4	4.4	4.4	4.4	4.4
	0.0	-0.7	4.7	4.6	4.6	4.6	4.6	4.4
	3.0	2.2	4.9	4.9	4.9	4.8	4.7	4.4
	5.0	4.1	5.1	5.1	5.0	4.8	4.7	4.4
	7.0	6.0	5.2	5.2	5.0	4.8	4.7	4.4
	9.0	7.9	5.4	5.3	5.0	4.8	4.7	4.4
11.0	9.8	5.6	5.3	5.0	4.8	4.7	4.4	
13.0	11.8	5.6	5.3	5.0	4.8	4.7	4.4	
15.0	13.7	5.6	5.3	5.0	4.8	4.7	4.4	
50	-19.8	-20.0	3.7	3.7	3.7	3.7	3.7	3.7
	-18.8	-19.0	3.8	3.8	3.8	3.8	3.8	3.8
	-16.7	-17.0	4.1	4.0	4.0	4.0	4.0	4.0
	-14.7	-15.0	4.3	4.3	4.3	4.2	4.2	4.2
	-12.6	-13.0	4.5	4.5	4.5	4.5	4.5	4.5
	-10.5	-11.0	4.7	4.7	4.7	4.7	4.7	4.7
	-9.5	-10.0	4.8	4.8	4.8	4.8	4.8	4.8
	-8.5	-9.1	4.9	4.9	4.9	4.9	4.9	4.9
	-7.0	-7.6	5.1	5.1	5.1	5.1	5.1	5.1
	-5.0	-5.6	5.3	5.3	5.3	5.3	5.3	5.3
	-3.0	-3.7	5.5	5.5	5.5	5.5	5.5	5.5
	0.0	-0.7	5.9	5.9	5.8	5.8	5.8	5.5
	3.0	2.2	6.2	6.2	6.2	6.1	5.9	5.5
	5.0	4.1	6.4	6.4	6.3	6.1	5.9	5.5
	7.0	6.0	6.6	6.6	6.3	6.1	5.9	5.5
	9.0	7.9	6.8	6.7	6.3	6.1	5.9	5.5
11.0	9.8	7.0	6.7	6.3	6.1	5.9	5.5	
13.0	11.8	7.1	6.7	6.3	6.1	5.9	5.5	
15.0	13.7	7.1	6.7	6.3	6.1	5.9	5.5	

3TW25512-2

4 Capacity tables

4 - 2 Heating capacity tables

FXMQ-P7								
Unit size	Outdoor air temp.		Indoor air temperature: °CDB					
	°CDB	°CWB	16.0	18.0	20.0	21.0	22.0	24.0
			kW	kW	kW	kW	kW	kW
63	-19,8	-20,0	4,7	4,7	4,7	4,7	4,7	4,7
	-18,8	-19,0	4,9	4,9	4,8	4,8	4,8	4,8
	-16,7	-17,0	5,1	5,1	5,1	5,1	5,1	5,1
	-14,7	-15,0	5,4	5,4	5,4	5,4	5,4	5,4
	-12,6	-13,0	5,7	5,7	5,7	5,7	5,7	5,7
	-10,5	-11,0	6,0	6,0	6,0	6,0	6,0	5,9
	-9,5	-10,0	6,1	6,1	6,1	6,1	6,1	6,1
	-8,5	-9,1	6,3	6,3	6,2	6,2	6,2	6,2
	-7,0	-7,6	6,5	6,5	6,4	6,4	6,4	6,4
	-5,0	-5,6	6,8	6,7	6,7	6,7	6,7	6,7
	-3,0	-3,7	7,0	7,0	7,0	7,0	7,0	7,0
	0,0	-0,7	7,5	7,4	7,4	7,4	7,4	7,0
	3,0	2,2	7,9	7,8	7,8	7,7	7,5	7,0
	5,0	4,1	8,1	8,1	8,0	7,7	7,5	7,0
	7,0	6,0	8,4	8,4	8,0	7,7	7,5	7,0
	9,0	7,9	8,7	8,5	8,0	7,7	7,5	7,0
	11,0	9,8	8,9	8,5	8,0	7,7	7,5	7,0
13,0	11,8	9,0	8,5	8,0	7,7	7,5	7,0	
15,0	13,7	9,0	8,5	8,0	7,7	7,5	7,0	
80	-19,8	-20,0	5,9	5,9	5,9	5,9	5,9	5,8
	-18,8	-19,0	6,1	6,1	6,0	6,0	6,0	6,0
	-16,7	-17,0	6,4	6,4	6,4	6,4	6,4	6,4
	-14,7	-15,0	6,8	6,8	6,8	6,7	6,7	6,7
	-12,6	-13,0	7,1	7,1	7,1	7,1	7,1	7,1
	-10,5	-11,0	7,5	7,5	7,5	7,5	7,4	7,4
	-9,5	-10,0	7,7	7,7	7,6	7,6	7,6	7,6
	-8,5	-9,1	7,8	7,8	7,8	7,8	7,8	7,8
	-7,0	-7,6	8,1	8,1	8,1	8,1	8,0	8,0
	-5,0	-5,6	8,4	8,4	8,4	8,4	8,4	8,4
	-3,0	-3,7	8,8	8,8	8,7	8,7	8,7	8,7
	0,0	-0,7	9,3	9,3	9,3	9,3	9,3	8,7
	3,0	2,2	9,8	9,8	9,8	9,7	9,4	8,7
	5,0	4,1	10,2	10,1	10,0	9,7	9,4	8,7
	7,0	6,0	10,5	10,5	10,0	9,7	9,4	8,7
	9,0	7,9	10,8	10,6	10,0	9,7	9,4	8,7
	11,0	9,8	11,2	10,6	10,0	9,7	9,4	8,7
13,0	11,8	11,3	10,6	10,0	9,7	9,4	8,7	
15,0	13,7	11,3	10,6	10,0	9,7	9,4	8,7	
100	-19,8	-20,0	7,4	7,4	7,3	7,3	7,3	7,3
	-18,8	-19,0	7,6	7,6	7,6	7,5	7,5	7,5
	-16,7	-17,0	8,0	8,0	8,0	8,0	8,0	8,0
	-14,7	-15,0	8,5	8,5	8,4	8,4	8,4	8,4
	-12,6	-13,0	8,9	8,9	8,9	8,9	8,9	8,8
	-10,5	-11,0	9,4	9,3	9,3	9,3	9,3	9,3
	-9,5	-10,0	9,6	9,6	9,5	9,5	9,5	9,5
	-8,5	-9,1	9,8	9,8	9,7	9,7	9,7	9,7
	-7,0	-7,6	10,1	10,1	10,1	10,1	10,1	10,0
	-5,0	-5,6	10,6	10,5	10,5	10,5	10,5	10,5
	-3,0	-3,7	11,0	11,0	10,9	10,9	10,9	10,9
	0,0	-0,7	11,6	11,6	11,6	11,6	11,6	10,9
	3,0	2,2	12,3	12,3	12,2	12,1	11,7	10,9
	5,0	4,1	12,7	12,7	12,5	12,1	11,7	10,9
	7,0	6,0	13,1	13,1	12,5	12,1	11,7	10,9
	9,0	7,9	13,5	13,3	12,5	12,1	11,7	10,9
	11,0	9,8	14,0	13,3	12,5	12,1	11,7	10,9
13,0	11,8	14,1	13,3	12,5	12,1	11,7	10,9	
15,0	13,7	14,1	13,3	12,5	12,1	11,7	10,9	
125	-19,8	-20,0	9,4	9,4	9,4	9,4	9,4	9,3
	-18,8	-19,0	9,7	9,7	9,7	9,7	9,6	9,6
	-16,7	-17,0	10,3	10,3	10,2	10,2	10,2	10,2
	-14,7	-15,0	10,9	10,8	10,8	10,8	10,8	10,7
	-12,6	-13,0	11,4	11,4	11,4	11,4	11,3	11,3
	-10,5	-11,0	12,0	12,0	11,9	11,9	11,9	11,9
	-9,5	-10,0	12,3	12,2	12,2	12,2	12,2	12,2
	-8,5	-9,1	12,5	12,5	12,5	12,5	12,4	12,4
	-7,0	-7,6	13,0	12,9	12,9	12,9	12,9	12,8
	-5,0	-5,6	13,5	13,5	13,5	13,4	13,4	13,4
	-3,0	-3,7	14,1	14,0	14,0	14,0	14,0	13,9
	0,0	-0,7	14,9	14,9	14,8	14,8	14,8	13,9
	3,0	2,2	15,7	15,7	15,7	15,5	15,0	13,9
	5,0	4,1	16,3	16,2	16,0	15,5	15,0	13,9
	7,0	6,0	16,8	16,8	16,0	15,5	15,0	13,9
	9,0	7,9	17,3	17,0	16,0	15,5	15,0	13,9
	11,0	9,8	17,9	17,0	16,0	15,5	15,0	13,9
13,0	11,8	18,1	17,0	16,0	15,5	15,0	13,9	
15,0	13,7	18,1	17,0	16,0	15,5	15,0	13,9	

4 Capacity tables

4 - 3 Capacity correction for high sensible

Data not available at time of publication

5 Dimensional drawing & centre of gravity

5 - 1 Dimensional drawing

FXMQ20-32P7

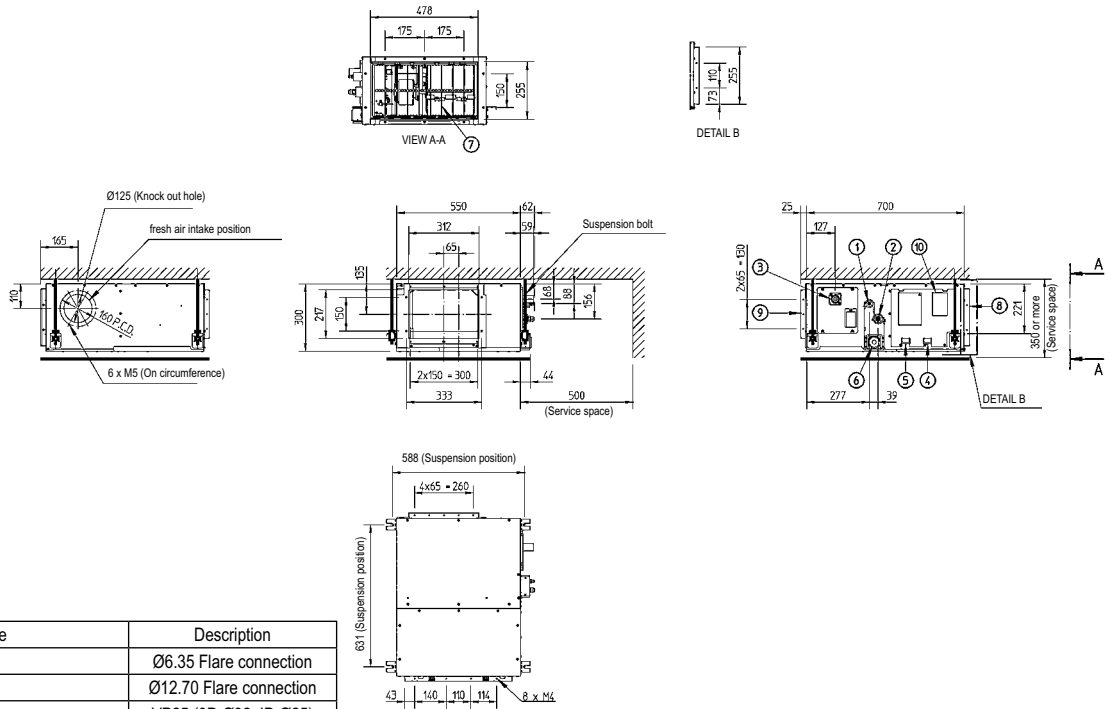

Item	Name	Description
1	Liquid pipe connection	Ø6.35 Flare connection
2	Gas pipe connection	Ø12.70 Flare connection
3	Drain pipe connection	VP25 (OD Ø32, ID Ø25)
4	Remote control wiring connection	-
5	Power supply connection	-
6	Drain hole	VP20 (OD Ø32, ID Ø25)
7	Air filter	-
8	Air suction side	-
9	Air discharge side	-
10	Nameplate	-

3TW31184-1A

NOTES

- 1 Refer to 'outlook drawing for installing optional accessories' when installing optional accessories.
- 2 The required ceiling depth varies according to the configuration of the specific system.
- 3 For maintenance of the air filter, it is necessary to provide a service access panel. Refer to the 'filter installation method' drawing.

FXMQ40P7

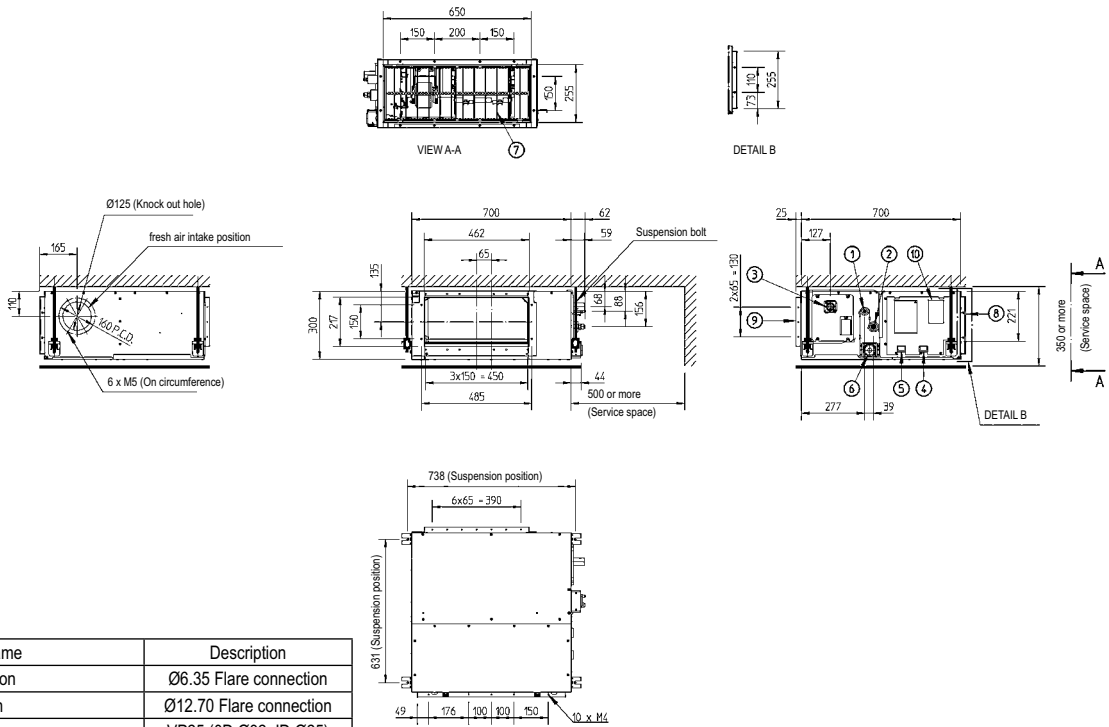

Item	Name	Description
1	Liquid pipe connection	Ø6.35 Flare connection
2	Gas pipe connection	Ø12.70 Flare connection
3	Drain pipe connection	VP25 (OD Ø32, ID Ø25)
4	Remote control wiring connection	-
5	Power supply connection	-
6	Drain hole	VP20 (OD Ø32, ID Ø25)
7	Air filter	-
8	Air suction side	-
9	Air discharge side	-
10	Nameplate	-

3TW31214-1A

NOTES

- 1 Refer to 'outlook drawing for installing optional accessories' when installing optional accessories.
- 2 The required ceiling depth varies according to the configuration of the specific system.
- 3 For maintenance of the air filter, it is necessary to provide a service access panel. Refer to the 'filter installation method' drawing.

5 Dimensional drawing & centre of gravity

5 - 1 Dimensional drawing

FXMQ50P7

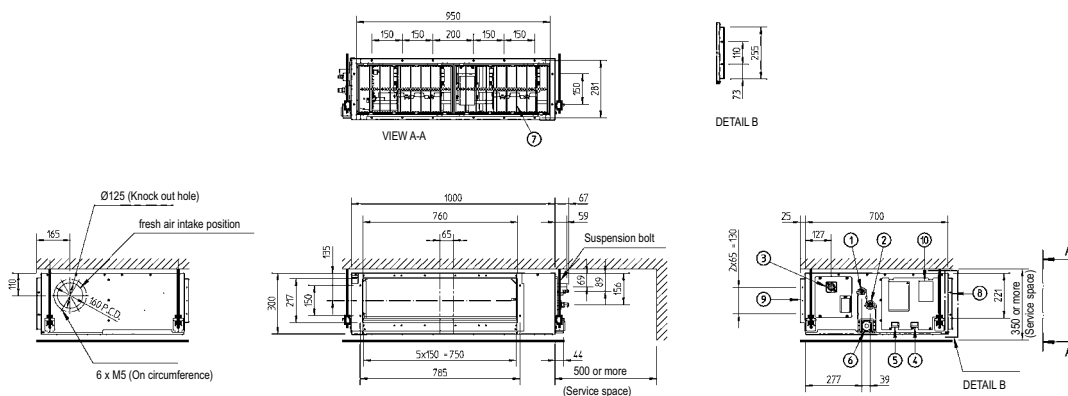

Item	Name	Description
1	Liquid pipe connection	Ø6.35 Flare connection
2	Gas pipe connection	Ø12.70 Flare connection
3	Drain pipe connection	VP25 (OD Ø32, ID Ø25)
4	Remote control wiring connection	-
5	Power supply connection	-
6	Drain hole	VP20 (OD Ø32, ID Ø25)
7	Air filter	-
8	Air suction side	-
9	Air discharge side	-
10	Nameplate	-

NOTES

- 1 Refer to 'outlook drawing for installing optional accessories' when installing optional accessories.
- 2 The required ceiling depth varies according to the configuration of the specific system.
- 3 For maintenance of the air filter, it is necessary to provide a service access panel. Refer to the 'filter installation method' drawing.

3TW32694-1

FXMQ63-80P7

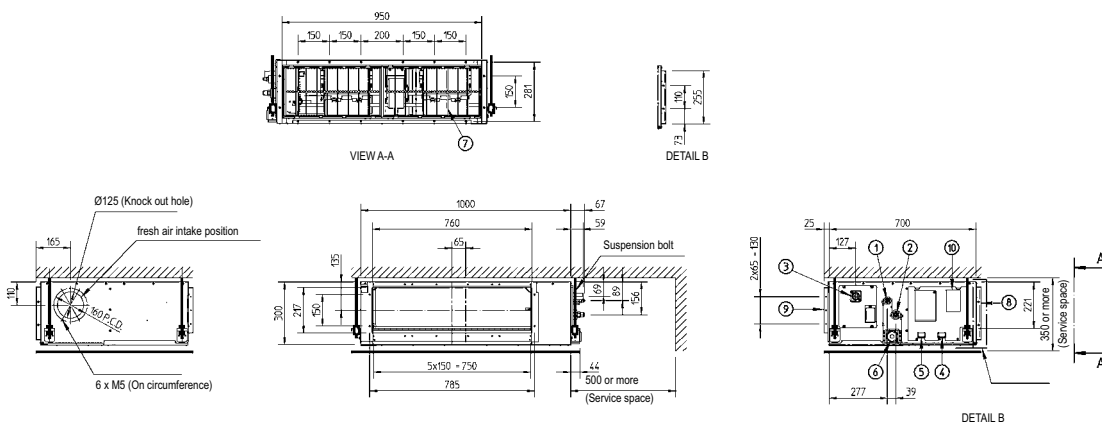

Item	Name	Description
1	Liquid pipe connection	Ø9.52 Flare connection
2	Gas pipe connection	Ø15.90 Flare connection
3	Drain pipe connection	VP25 (OD Ø32, ID Ø25)
4	Remote control wiring connection	-
5	Power supply connection	-
6	Drain hole	VP20 (OD Ø32, ID Ø25)
7	Air filter	-
8	Air suction side	-
9	Air discharge side	-
10	Nameplate	-

NOTES

- 1 Refer to 'outlook drawing for installing optional accessories' when installing optional accessories.
- 2 The required ceiling depth varies according to the configuration of the specific system.
- 3 For maintenance of the air filter, it is necessary to provide a service access panel. Refer to the 'filter installation method' drawing.

3TW31234-1A

5 Dimensional drawing & centre of gravity

5 - 1 Dimensional drawing

FXMQ100-125P7

Item	Name	Description
1	Liquid pipe connection	Ø9.52 Flare connection
2	Gas pipe connection	Ø15.90 Flare connection
3	Drain pipe connection	VP25 (OD Ø32, ID Ø25)
4	Remote control wiring connection	-
5	Power supply connection	-
6	Drain hole	VP20 (OD Ø32, ID Ø25)
7	Air filter	-
8	Air suction side	-
9	Air discharge side	-
10	Nameplate	-

3TW31254-1A

NOTES

- 1 Refer to 'outlook drawing for installing optional accessories' when installing optional accessories.
- 2 The required ceiling depth varies according to the configuration of the specific system.
- 3 For maintenance of the air filter, it is necessary to provide a service access panel. Refer to the 'filter installation method' drawing.

5 Dimensional drawing & centre of gravity

5 - 2 Centre of gravity

FXMQ-P7

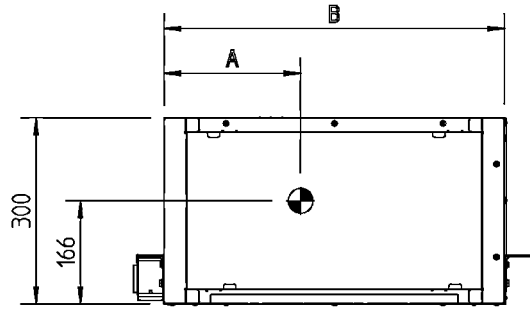
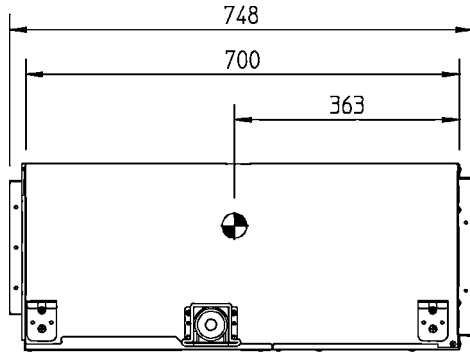

Model	A	B
FXMQ20~32	220	550
FXMQ40	283	700
FXMQ50,63,80	441	1000
FXMQ100,125	619	1400

4TW31189-1B

6 Piping diagram

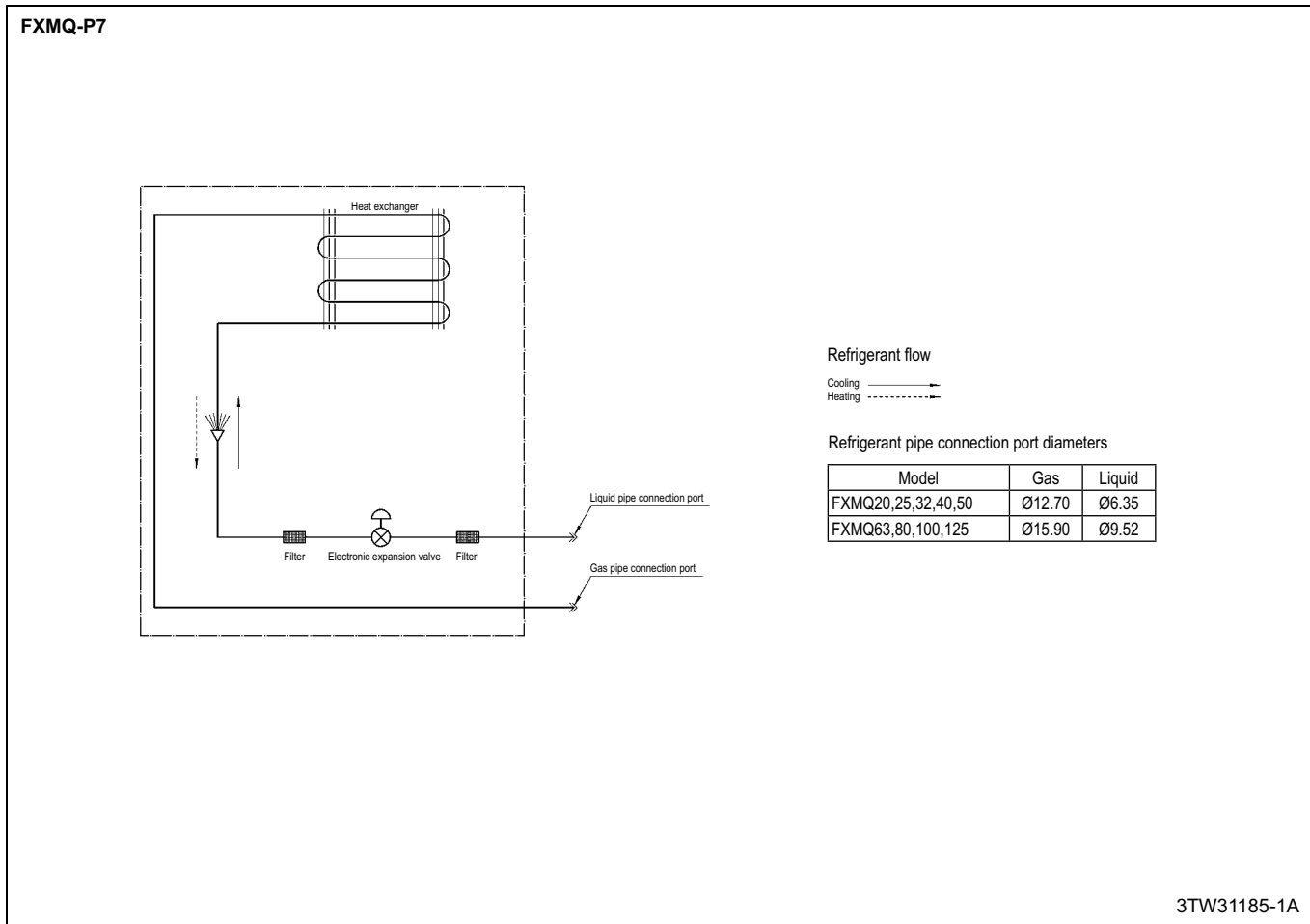

7 Wiring diagram

7 - 1 Wiring diagram

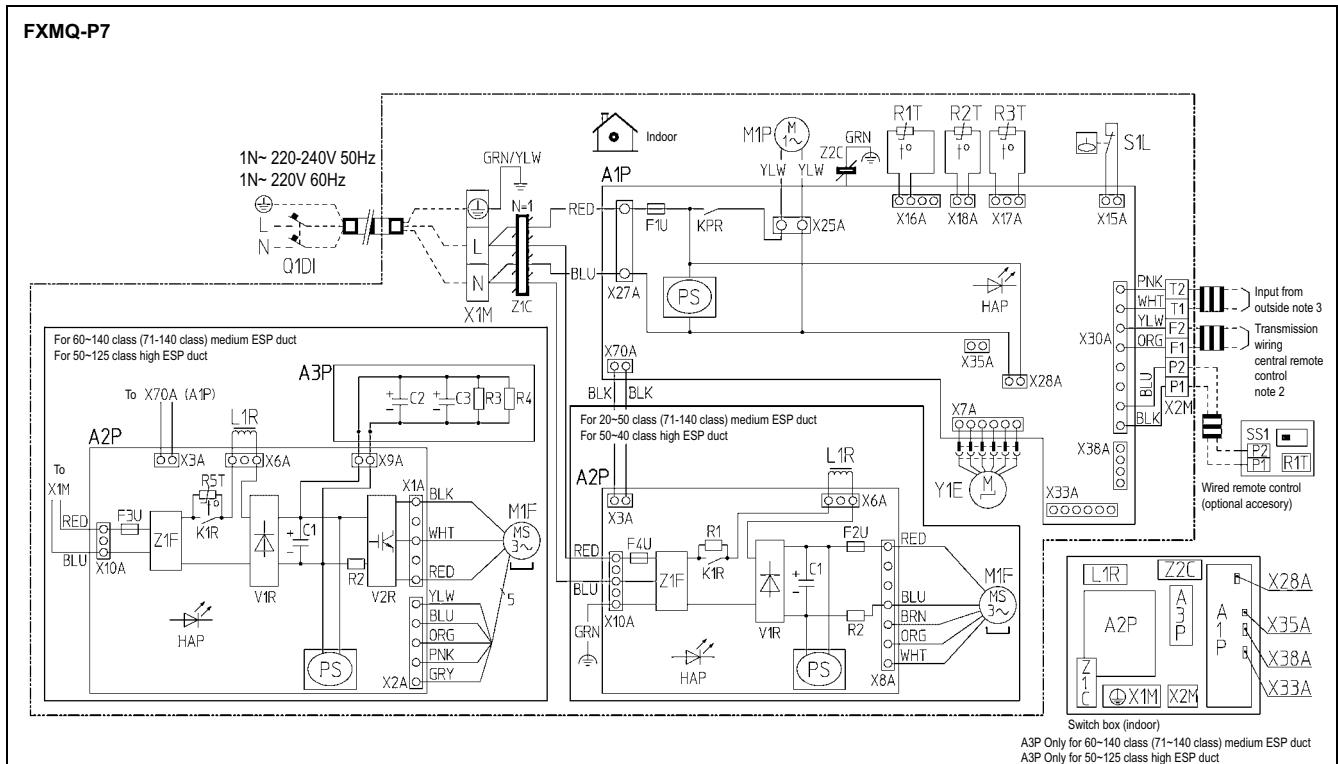

Switch box (indoor)
 A3P Only for 60-140 class (71-140 class) medium ESP duct
 A3P Only for 50-125 class high ESP duct

- Field wiring
- L : Live
- N : Neutral
- Connector
- Wire clamp
- Protective earth (screw)
- Colors: BLK : black, ORG : orange, YLW : yellow, BLU : blue, PNK : pink, GRN : green, BRN : brown, RED : red, GRY : grey, WHT : white

Indoor unit		R2T	Thermistor (Liquid)
A1P	Printed circuit board	R3T	Thermistor (Gas)
A2P	Printed circuit board (fan)	R5T	Thermistor NTC (Current limiting)
A3P	Printed circuit board (capacitor)	S1L	Float switch
C1, C2, C3	Capacitor	V1R	Diode bridge
F1U	Fuse (T, 3.15A, 250V)	V2R	Power module
F2U	Fuse (T, 5A, 250V)	X1M	Terminal strip (Power supply)
F3U	Fuse (T, 6.3A, 250V)	X2M	Terminal strip (Control)
F4U	Fuse (T, 6.3A, 250V)	Y1E	Electronic expansion valve
HAP	Light emitting diode (service monitor-green)	Z1C, Z2C	Noise filter (Ferrite core)
KRP, K1R	Magnetic relay	Z1F	Noise filter
L1R	Reactor	X28A	Connector optional accessory
M1F	Motor (Fan)	X28A	Connector (power supply for wiring)
M1P	Motor (Drain pump)	X33A	Connector (For wiring)
PS	Switching power supply	X35A	Connector (Adapter)
Q1DI	Earth leak detector	X38A	Connector (For wiring)
R1	Resistor (Current limiting)		Wired remote control
R2	Current sensing device	R1T	Thermistor (Air)
R3, R4	Resistor (Electric discharge)	SS1	Selector switch (Main/sub)
R1T	Thermistor (Suction air)		

2TW32656-1

- NOTES**
- Use copper conductors only.
 - When using the central remote control, see manual for connection to the unit.
 - When connecting the input wires from outside, forced 'OFF' or 'ON/OFF' operation can be selected by the remote control. See installation manual for more details.

8 Sound data

8 - 1 Sound pressure spectrum

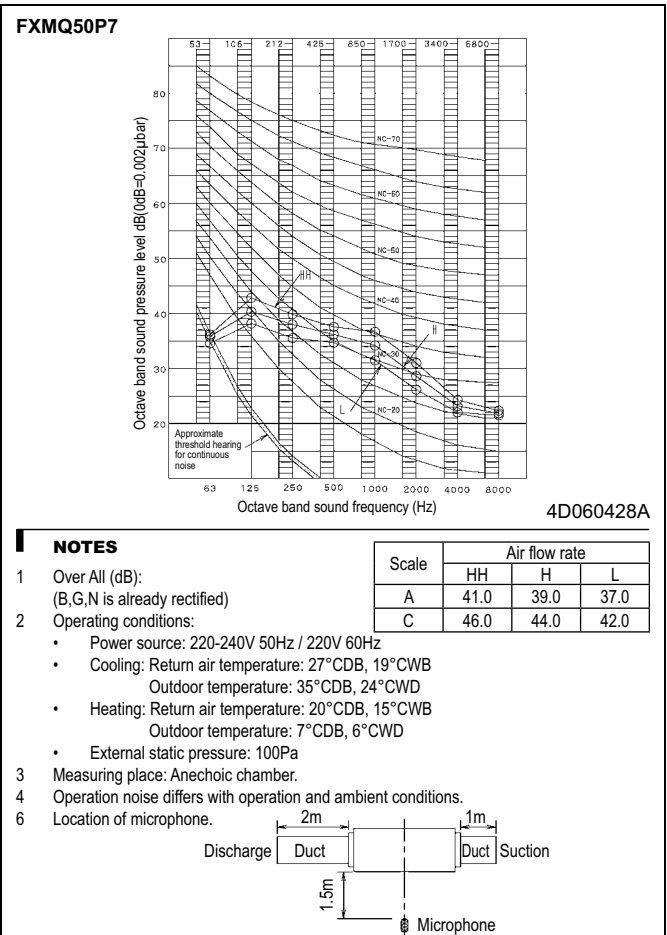
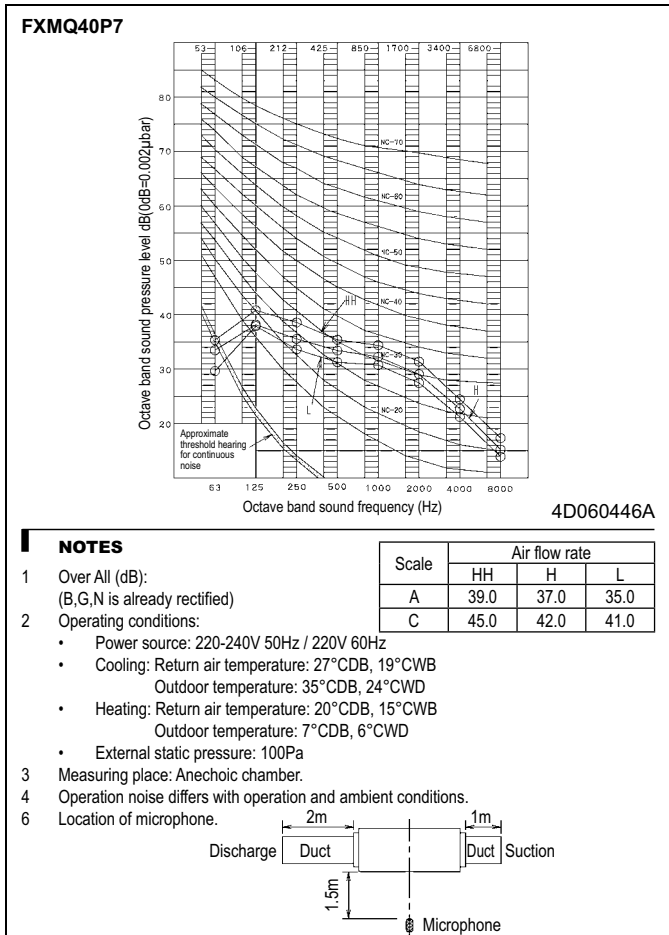
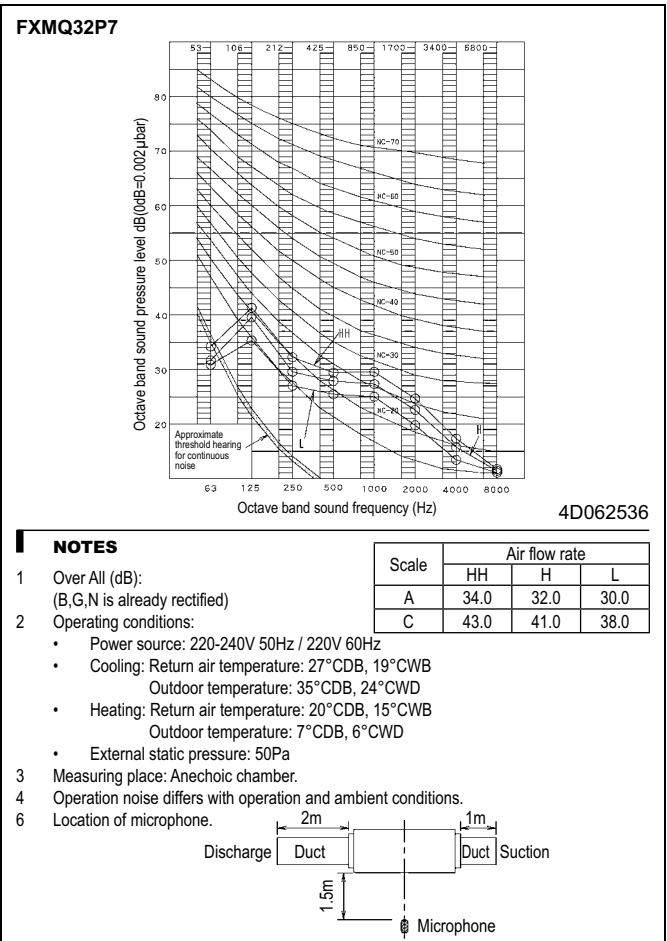
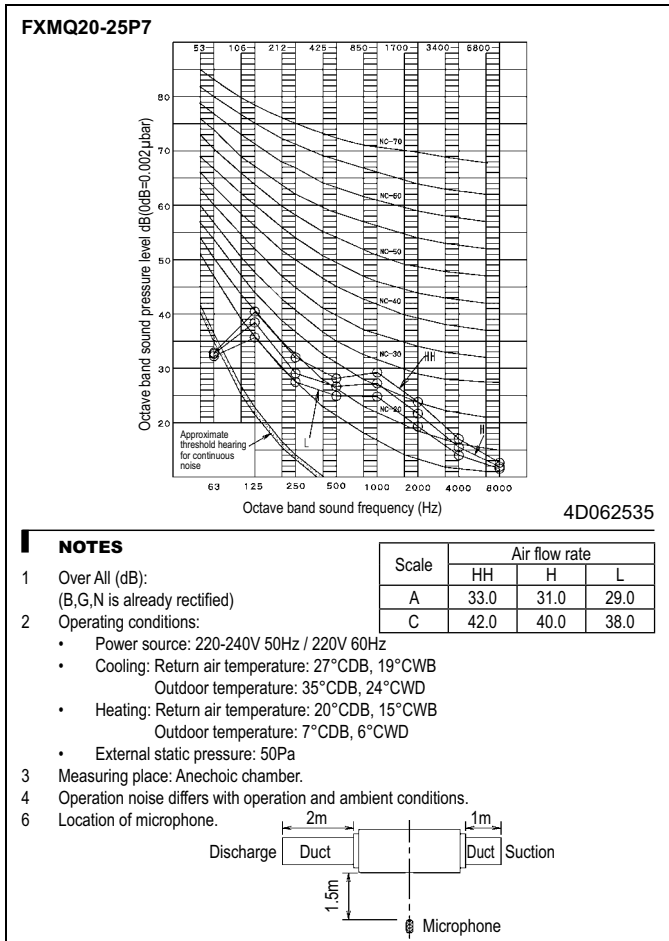

8 Sound data

8 - 1 Sound pressure spectrum

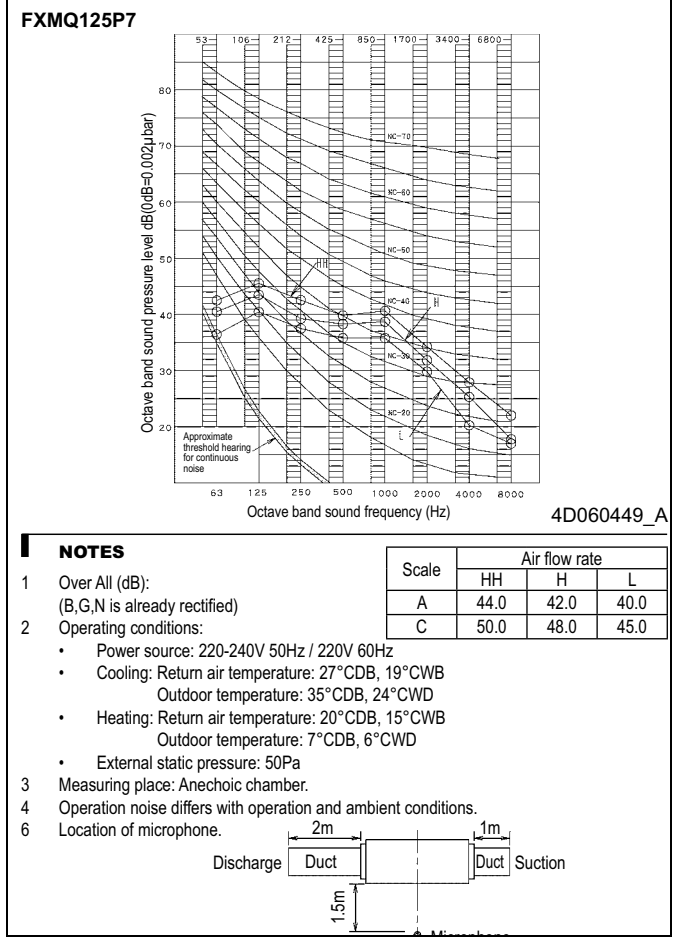
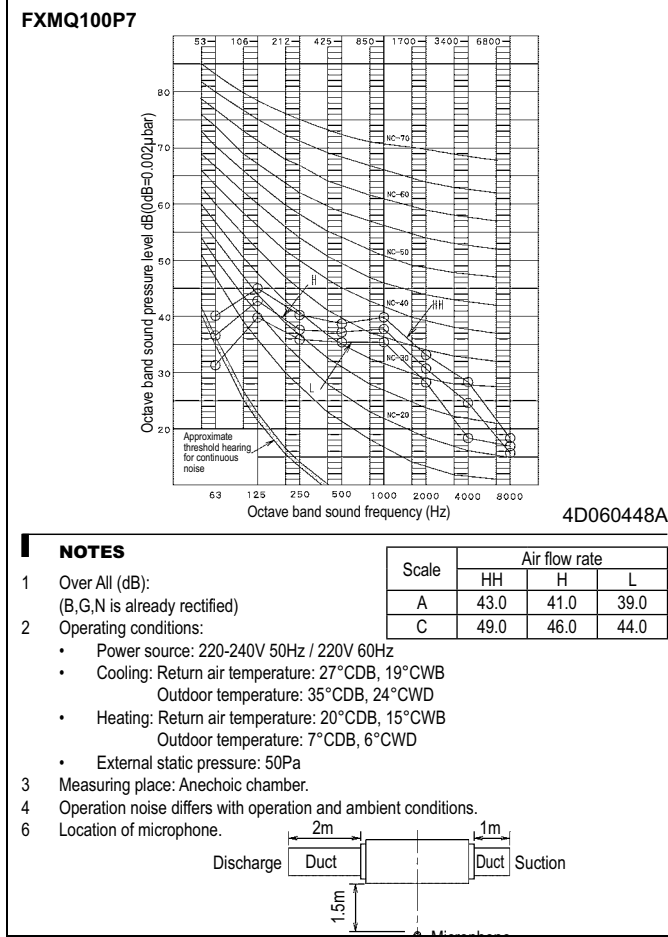
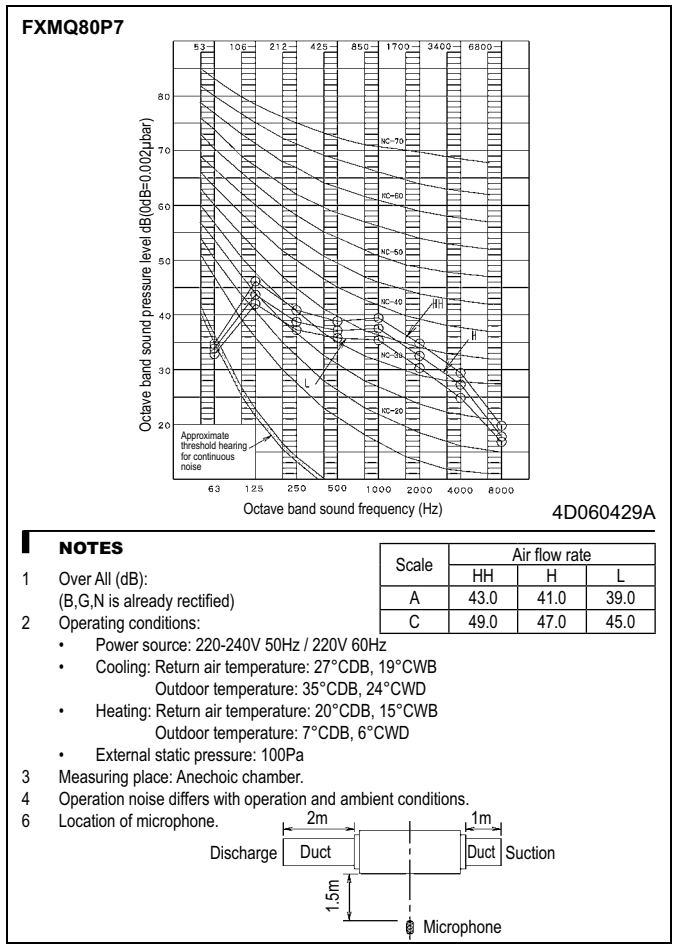
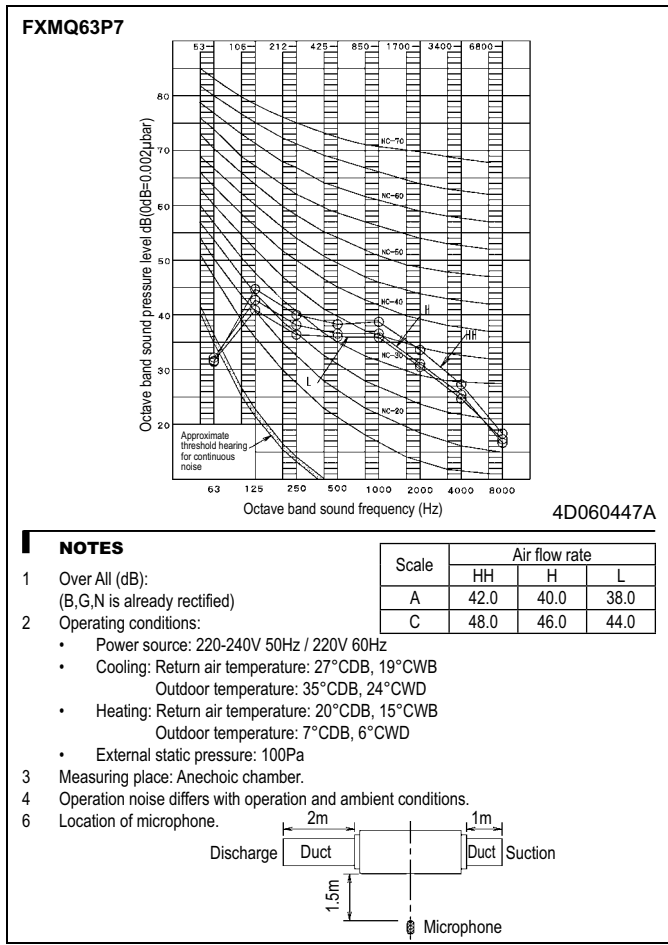

8 Sound data

8 - 2 Sound power spectrum

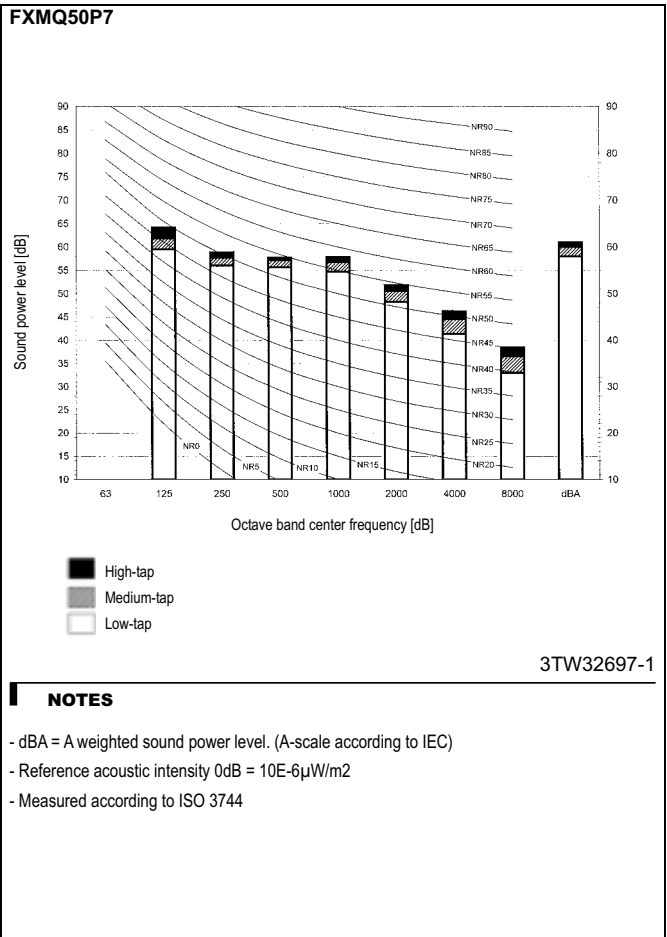
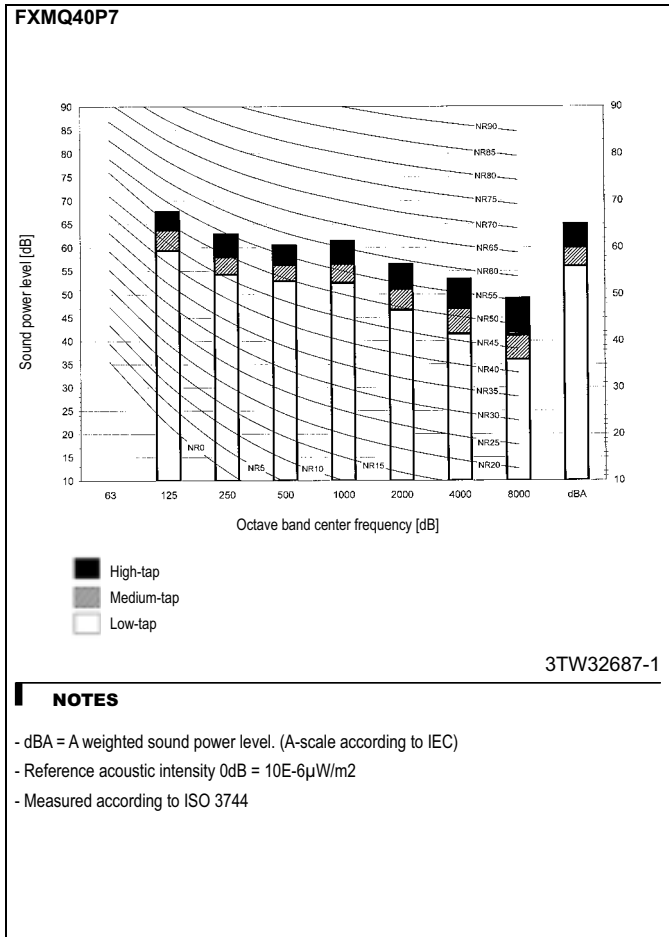
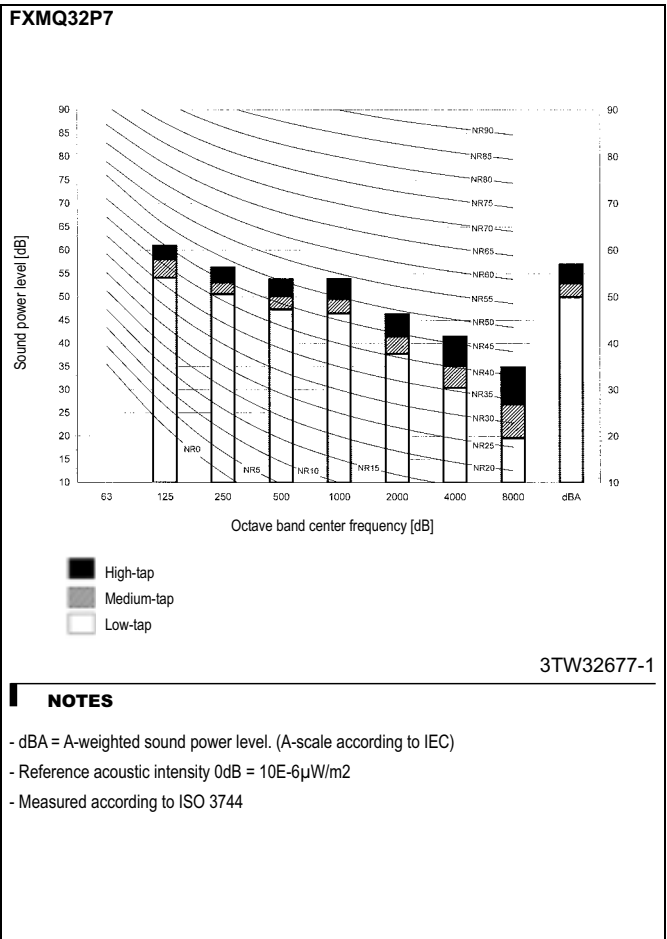
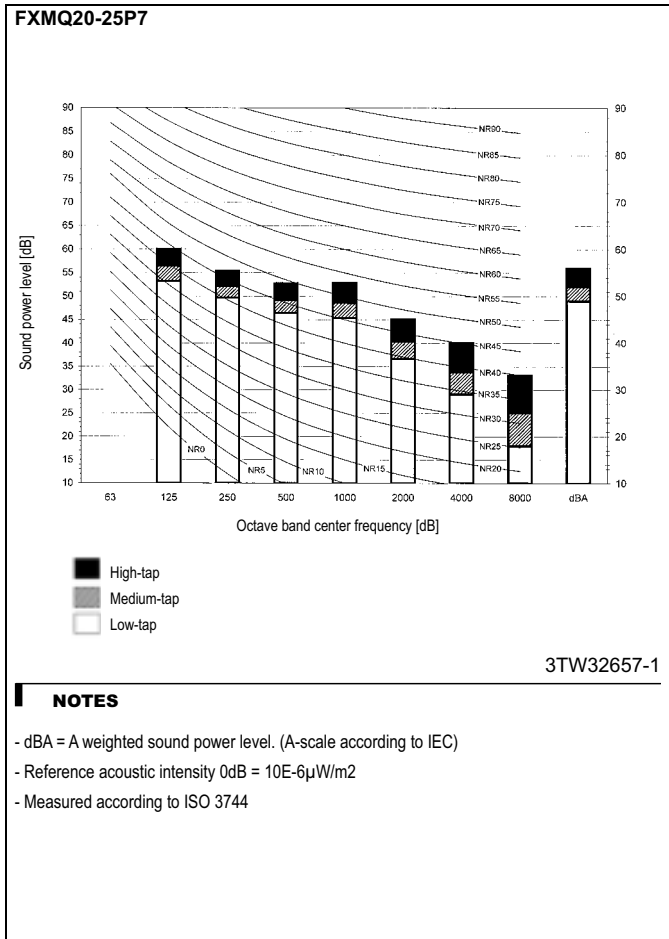

8 Sound data

8 - 2 Sound power spectrum

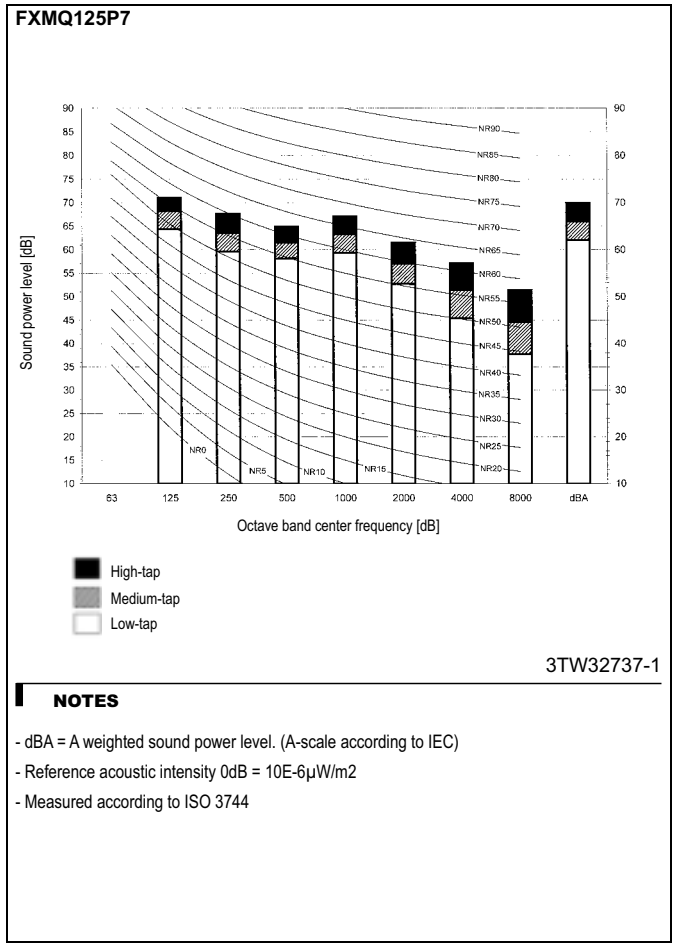
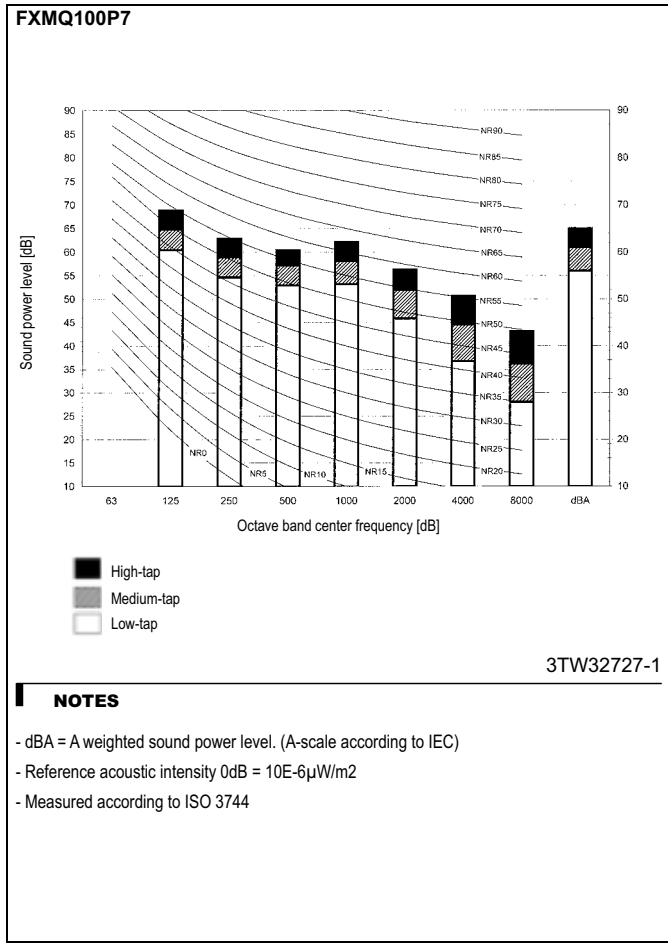
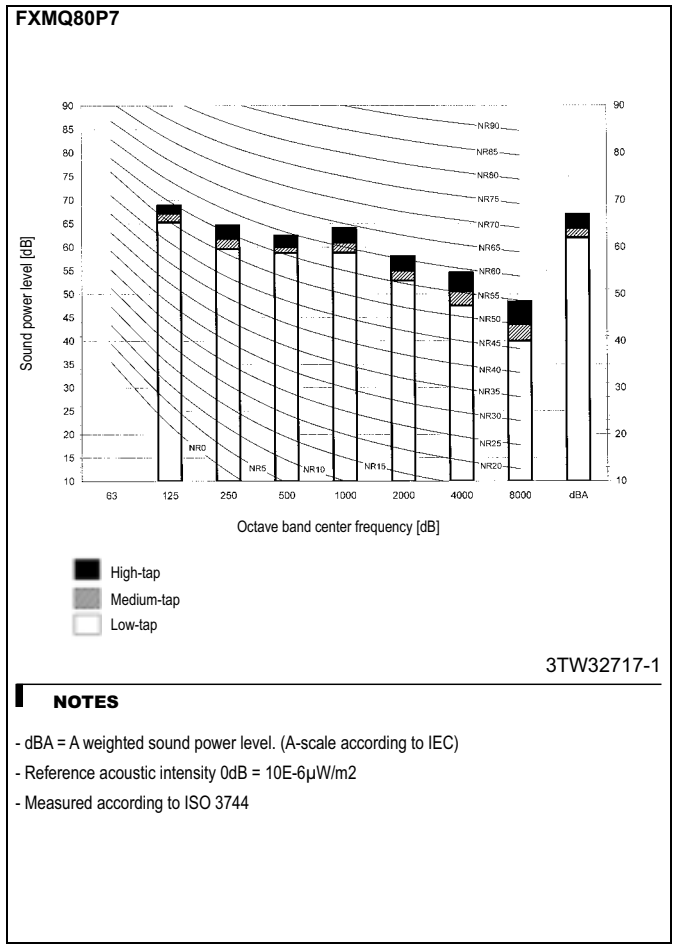
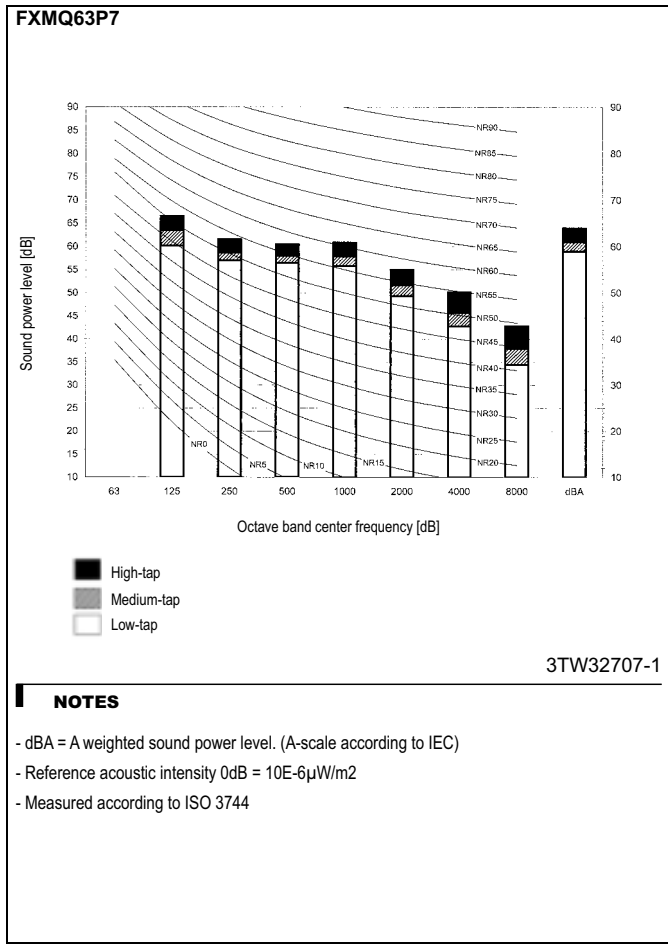

9 Fan characteristics

FXMQ20-25P7

Fan characteristics (1)

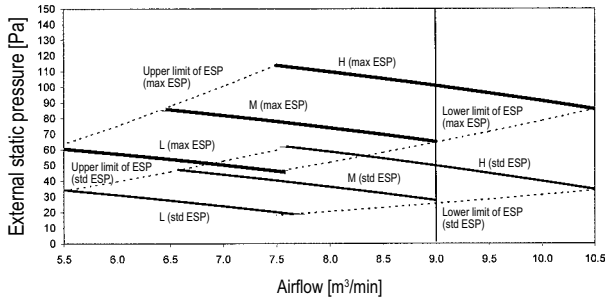

Fan characteristics (3)
(airflow auto adjustment)

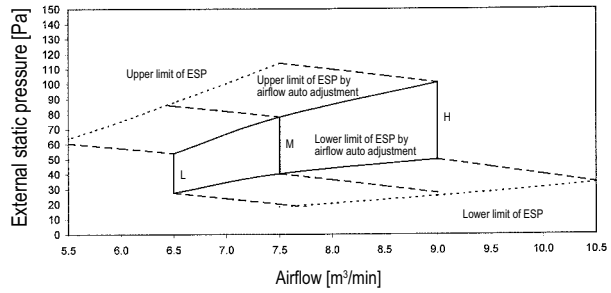

Fan characteristics (2)
(Field setting with remote control)

Range of available air flow rate (H)

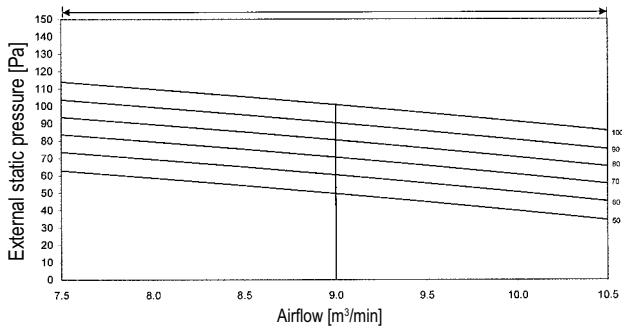

3TW32658-1

NOTES

1. Fan characteristics as shown are in "fan only" mode.
2. ESP: External static pressure

FXMQ32P7

Fan characteristics (1)

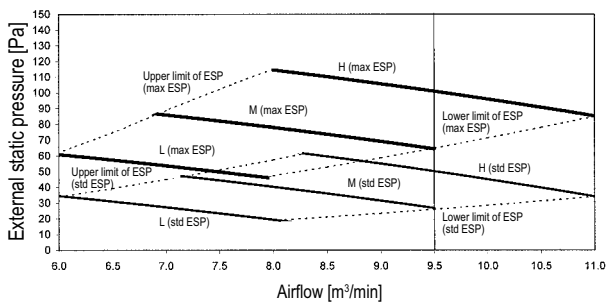

Fan characteristics (3)
(airflow auto adjustment)

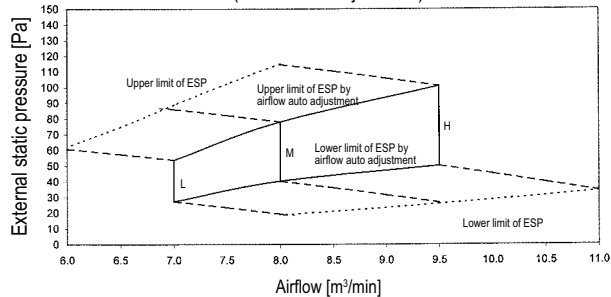

Fan characteristics (2)
(Field setting with remote control)

Range of available air flow rate (H)

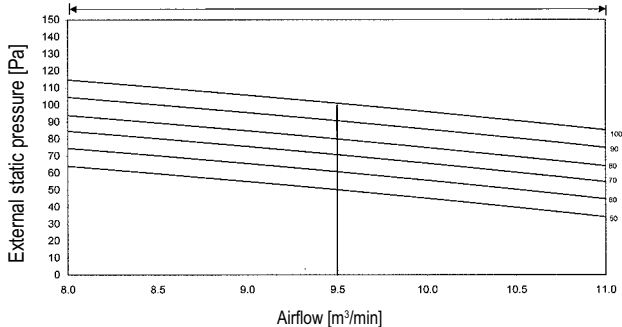

3TW32678-1

NOTES

1. Fan characteristics as shown are in "fan only" mode.
2. ESP: External static pressure

9 Fan characteristics

FXMQ40P7

Fan characteristics (1)

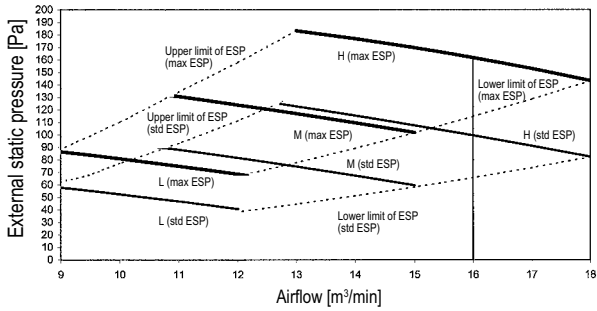

Fan characteristics (3)
(airflow auto adjustment)

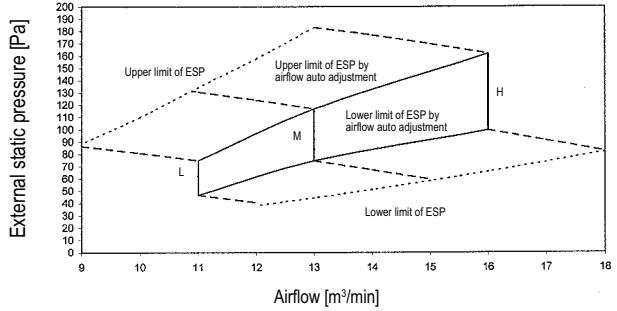

Fan characteristics (2)
(Field setting with remote control)

Range of available air flow rate (H)

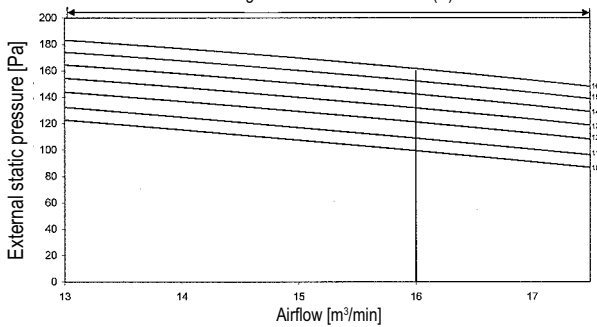

3TW32688-1

NOTES

1. Fan characteristics as shown are in "fan only" mode.
2. ESP: External static pressure

FXMQ50P7

Fan characteristics (1)

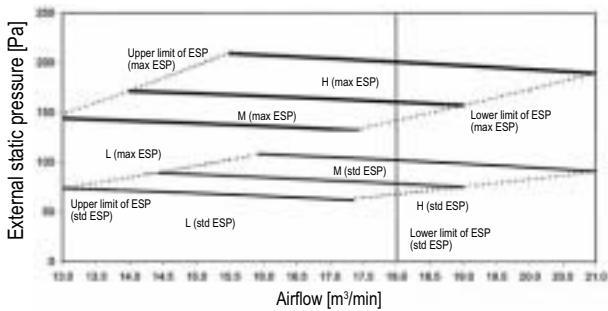

Fan characteristics (3)
(airflow auto adjustment)

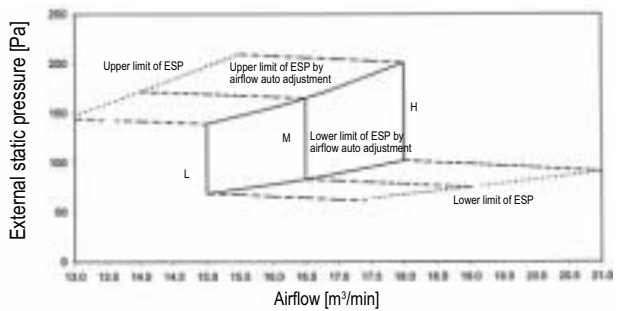

Fan characteristics (2)
(Field setting with remote control)

Range of available air flow rate (H)

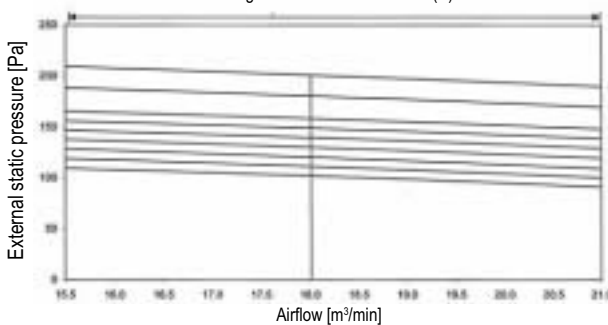

3TW32698-1

NOTES

1. Fan characteristics as shown are in "fan only" mode.
2. ESP: External static pressure

9 Fan characteristics

FXMQ63P7

Fan characteristics (1)

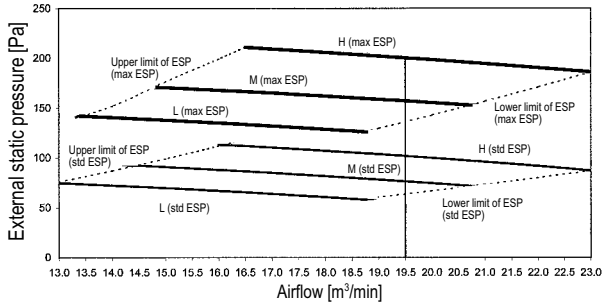

Fan characteristics (3)
(airflow auto adjustment)

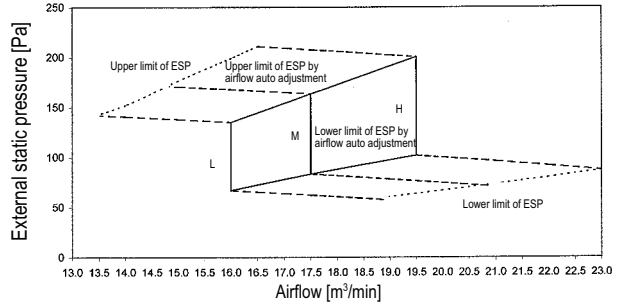

Fan characteristics (2)
(Field setting with remote control)

Range of available air flow rate (H)

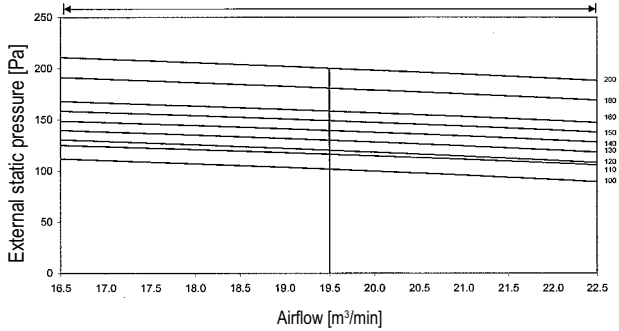

3TW32708-1

NOTES

1. Fan characteristics as shown are in "fan only" mode.
2. ESP: External static pressure

FXMQ80P7

Fan characteristics (1)

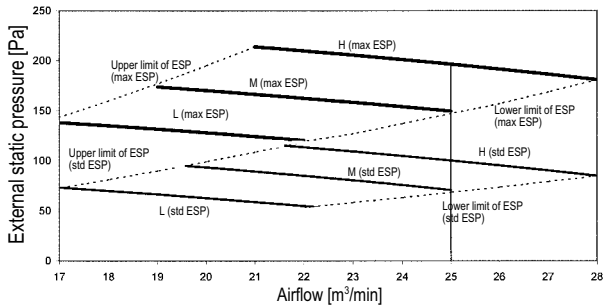

Fan characteristics (3)
(airflow auto adjustment)

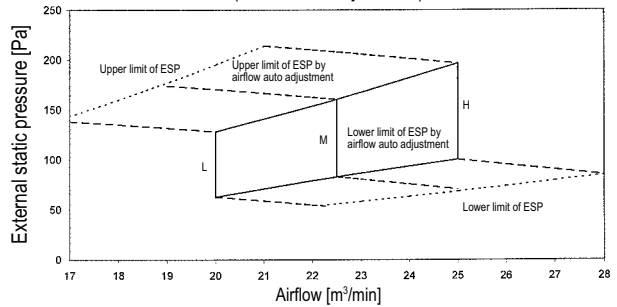

Fan characteristics (2)
(Field setting with remote control)

Range of available air flow rate (H)

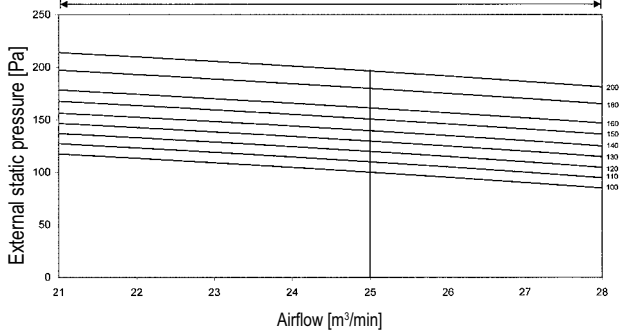

3TW32718-1

NOTES

1. Fan characteristics as shown are in "fan only" mode.
2. ESP: External static pressure

9 Fan characteristics

FXMQ100P7

Fan characteristics (1)

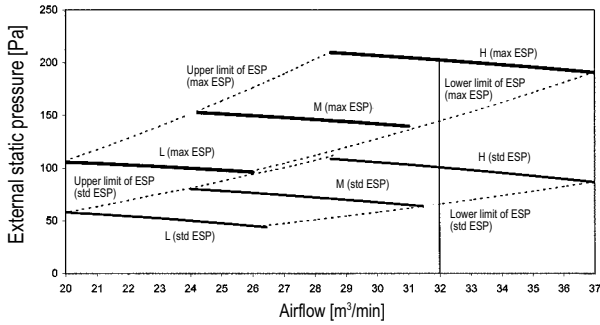

Fan characteristics (3)
(airflow auto adjustment)

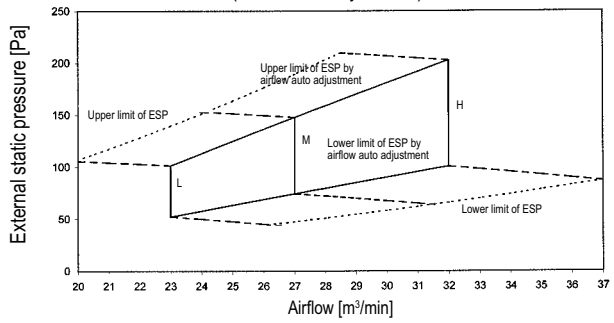

Fan characteristics (2)
(Field setting with remote control)

Range of available air flow rate (H)

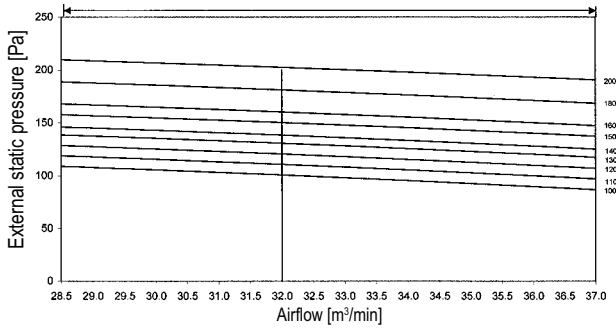

3TW32728-1

NOTES

1. Fan characteristics as shown are in "fan only" mode.
2. ESP: External static pressure.

FXMQ125P7

Fan characteristics (1)

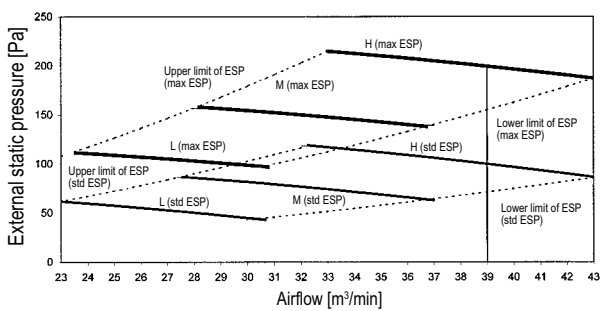

Fan characteristics (3)
(airflow auto adjustment)

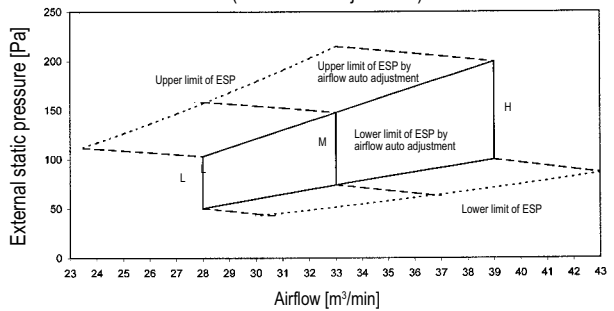

Fan characteristics (2)
(Field setting with remote control)

Range of available air flow rate (H)

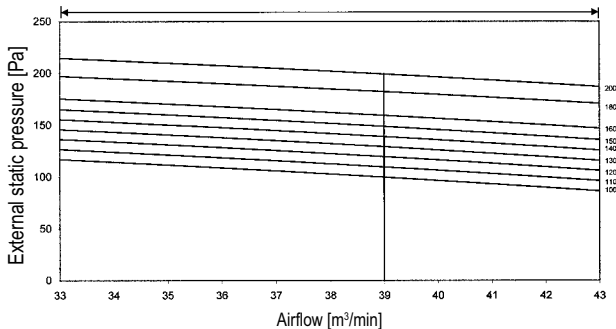

3TW32738-1

NOTES

1. Fan characteristics as shown are in "fan only" mode.
2. ESP: External static pressure

10 Installation

10 - 1 Installation method

FXMQ-P7

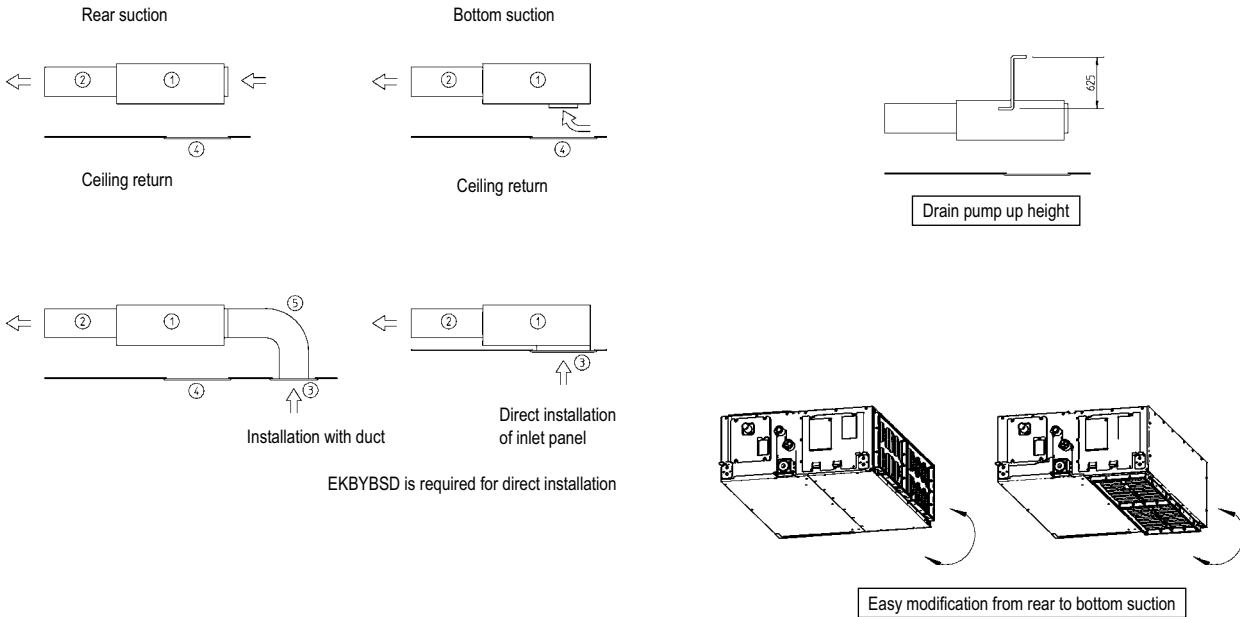

Wide variety of installation methods

Number	Description	
1	Main body	
2	Air outlet duct	Field supply
3	Inlet panel	Optional accessory
4	Access panel	Optional accessory
5	Air inlet duct	Field supply

3TW31183-1A

10 Installation

10 - 2 Filter installation method

FXMQ-P7

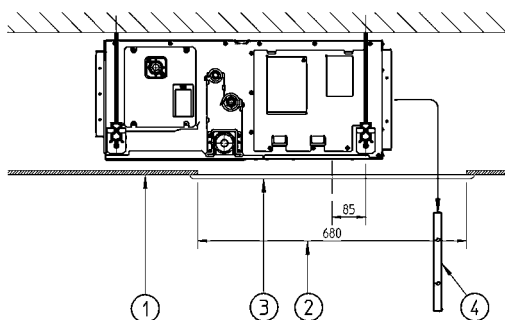

Installation without air inlet duct

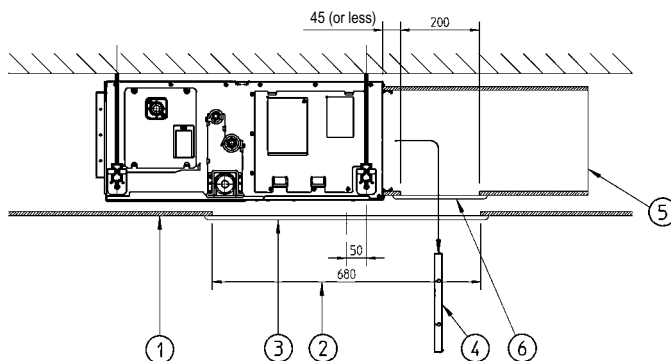

Installation with air inlet duct

Number	Description
1	Suspended ceiling
2	Ceiling opening
3	Service access panel (optional)
4	Air Filter
5	Air inlet duct
6	Duct service opening

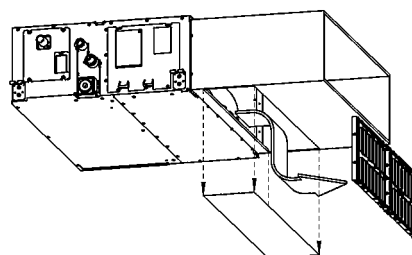

3TW31184-4

NOTES

1. When installing the unit with rear suction, a service opening is necessary for the maintenance of the air filters.
2. When installing the unit with a suction duct, a service opening must be provided in the duct.

10 Installation

10 - 3 Switch box connection

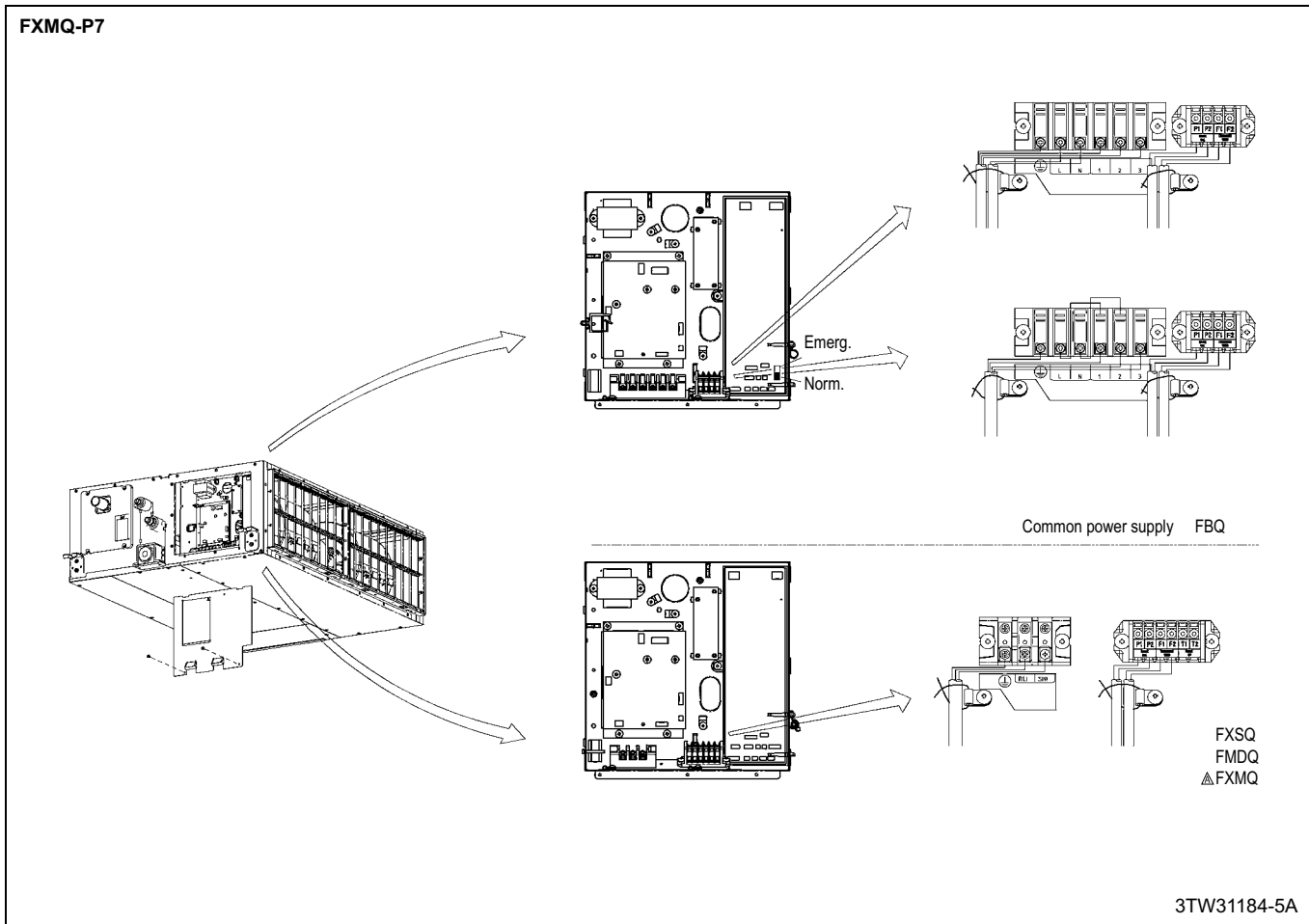



Daikin's unique position as a manufacturer of air conditioning equipment, compressors and refrigerants has led to its close involvement in environmental issues. For several years Daikin has had the intension to become a leader in the provision of products that have limited impact on the environment. This challenge demands the eco design and development of a wide range of products and an energy management system, resulting in energy conservation and a reduction of waste.



Daikin Europe N.V. is approved by LRQA for its Quality Management System in accordance with the ISO9001 standard. ISO9001 pertains to quality assurance regarding design, development, manufacturing as well as to services related to the product.



ISO14001 assures an effective environmental management system in order to help protect human health and the environment from the potential impact of our activities, products and services and to assist in maintaining and improving the quality of the environment.



Daikin units comply with the European regulations that guarantee the safety of the product.

VRV® products are not within the scope of the Eurovent certification programme.

The present publication is drawn up by way of information only and does not constitute an offer binding upon Daikin Europe N.V.. Daikin Europe N.V. has compiled the content of this publication to the best of its knowledge. No express or implied warranty is given for the completeness, accuracy, reliability or fitness for particular purpose of its content and the products and services presented therein. Specifications are subject to change without prior notice. Daikin Europe N.V. explicitly rejects any liability for any direct or indirect damage, in the broadest sense, arising from or related to the use and/or interpretation of this publication. All content is copyrighted by Daikin Europe N.V..

DAIKIN EUROPE N.V.

Naamloze Vennoetschap
Zandvoordestraat 300
B-8400 Oostende, Belgium
www.daikin.eu
BE 0412 120 336
RPR Oostende

