

**TECHNICAL INSTRUCTIONS**  
**FOR**  
**SAFETY RECALL GLG**  
**FRONT PASSENGER AIRBAG MODULE**  
**CERTAIN 2007 – 2010 MY ES 350**  
**UPDATED JUNE 15, 2017**

**6-15-2017**

- 2010 MY added.

The repair quality of covered vehicles is extremely important to Lexus. All dealership technicians performing this recall are required to successfully complete the most current version of the E-Learning course "Safety Recall and Service Campaign Essentials". To ensure that all vehicles have the repair performed correctly:

- **MASTER SERVICE TECHNICIANS**
- **MASTER DIAGNOSTIC SPECIALISTS**

It is the dealership's responsibility to select technicians with the above certification level or greater to perform this recall repair. Carefully review your resources, the technician skill level, and ability before assigning technicians to this repair. It is important to consider technician days off and vacation schedules to ensure there are properly trained technicians available to perform this repair at all times.

**NOTE:** To support additional service capacity, Lexus Certified and Senior Service Technicians, with at least 36 months Lexus experience AND L652 course credit, may also perform this repair following successful completion of course LSC13B.

## I. OPERATION FLOW CHART

The flow chart is for reference only. **DO NOT** use it in place of the full technical instructions. Follow **ALL** steps as outlined in the full technical instructions to confirm the campaign is completed correctly.

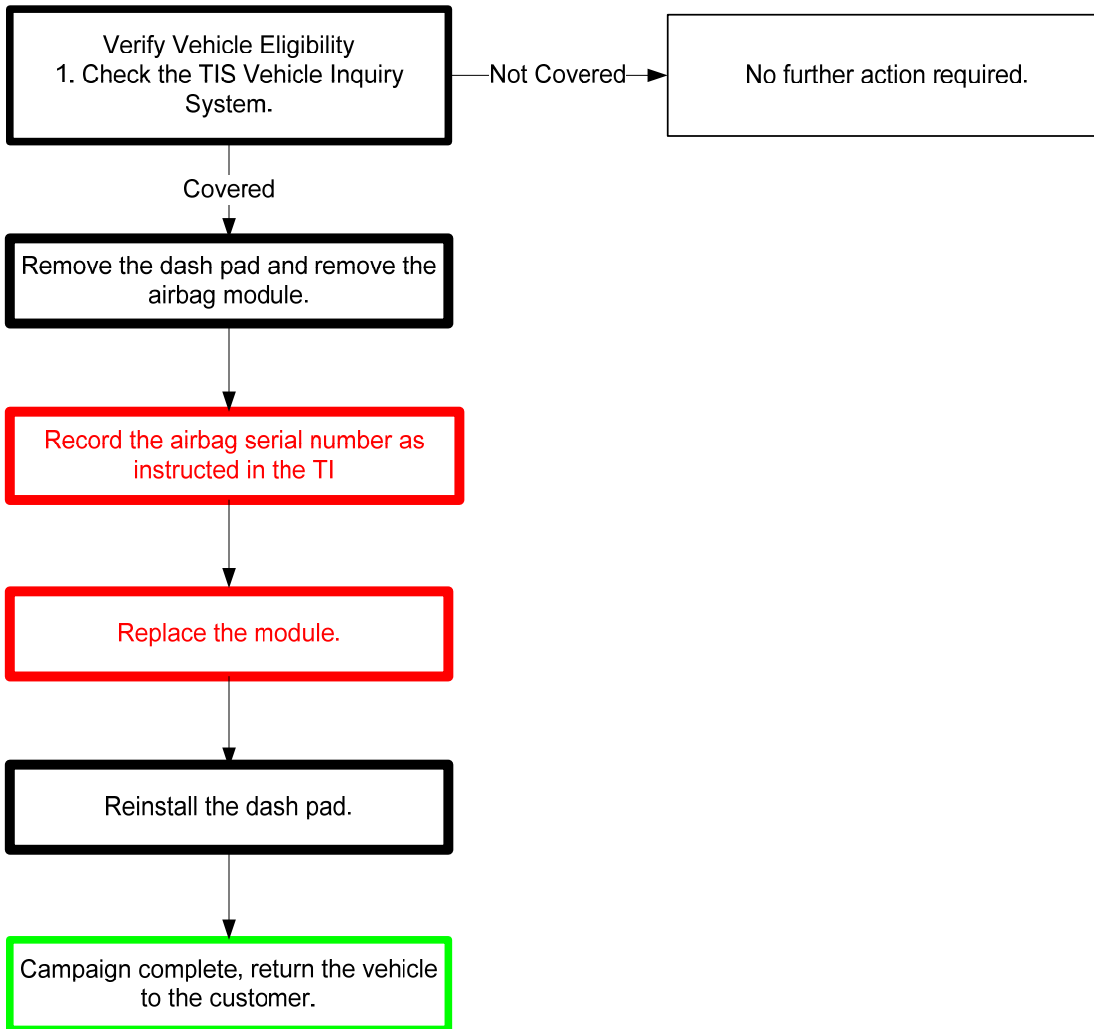

## II. BACKGROUND

The subject vehicles are equipped with front passenger airbag inflators produced by Takata. The propellant in these inflators may degrade after prolonged exposure to high absolute humidity and fluctuating high temperatures. Degraded propellant can cause inflator rupture during airbag deployment. In the event of an inflator rupture, metal fragments could pass through the airbag cushion material, striking the vehicle occupants, and result in serious injury or death.

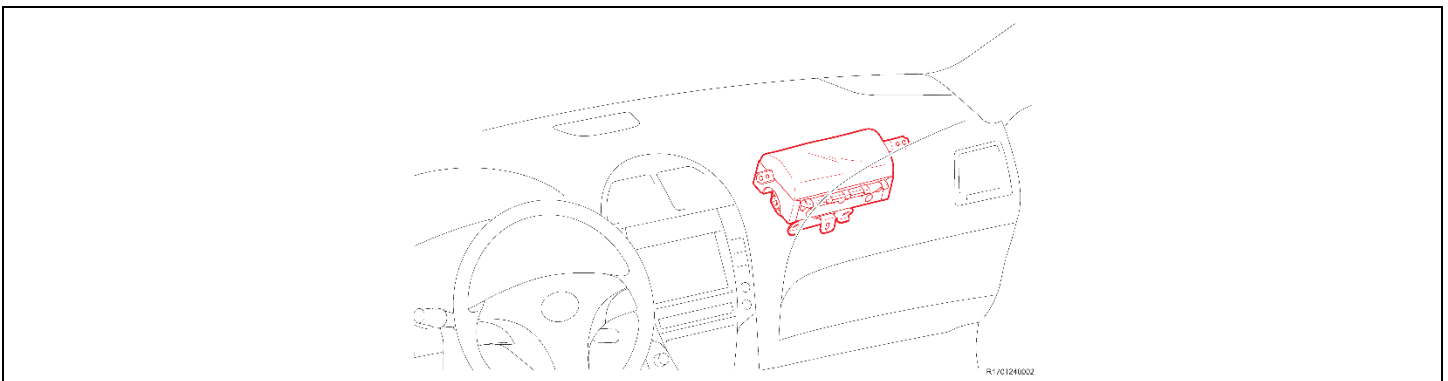

### III. IDENTIFICATION OF AFFECTED VEHICLES

#### A. COVERED VIN RANGE

- Check the TIS Vehicle Inquiry System to confirm the VIN is involved in this Safety Recall, and that the campaign has not already been completed prior to dealer shipment or by another dealer.
- **TMS warranty will not reimburse dealers for repairs conducted on vehicles that are not affected or were completed by another dealer.**

### IV. PREPARATION

#### A. PARTS

Part Number	Part Description	Quantity
04006-49233	Instrument Panel Passenger Airbag	1
04006-66108*	Front Pillar Garnish Kit	1

\*The kit contains 2 clips

#### B. TOOLS & EQUIPMENT

- Standard hand tools
- Torque wrench
- Techstream
- Molding remover set

**GLG/GLH CAMPAIGN TOOLS** – These tools were previously provided to the dealership for campaign DLC and will be used for this campaign. These tools are required when performing this repair.

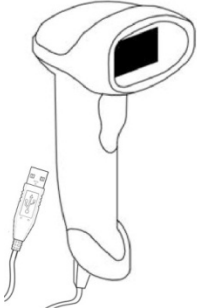
Image	Name	Quantity
	Barcode Scanner	1

**NOTE:** This tool **CANNOT** be ordered through the parts or tools system. If additional tools are needed, they can be sourced locally.

**SST** –These are essential service tools that the dealership should have.

Part Number	Part Name	Quantity
09950-50013	Puller C Set *	1
* The set above includes the following tools.		
Part Number	Part Name	Quantity
09951-05010	Hanger 150	1
09952-05010	Slide Arm	2
09953-05020	Center Bolt 150	1
09954-05021	Claw No. 2	2

## V. SAFETY PRECAUTIONS



### CRITICAL INFORMATION – READ THOROUGHLY



Failure to follow these procedures correctly could cause the SRS to unexpectedly deploy during servicing or the SRS may fail to operate correctly when required after reassembly. Confirm all work is performed as described in these instructions.

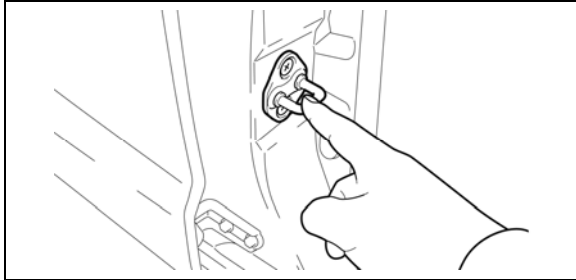

#### 1. ELIMINATE STATIC ELECTRICITY

- a) Before starting work and periodically while working on the vehicle, touch a metallic part of the vehicle to discharge static electricity in the body.



#### 2. DO NOT MEASURE RESISTANCE

- a) **NEVER** measure the resistance of an airbag, this may cause accidental activation.



#### 3. HANDLE THE AIRBAG CAREFULLY

- a) If the airbag is dropped, replace it with a **NEW** one.

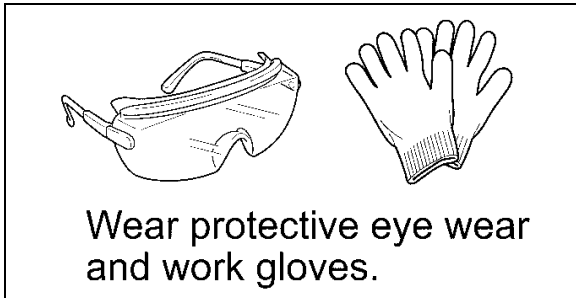

#### 4. WEAR PROTECTIVE EQUIPMENT

- a) Always wear appropriate protective equipment when working on the SRS.

## VI. SRS SYSTEM HEALTH CHECK

Confirm the Information and press Next

Required Information:

Division: TOYOTA

Model: < Select >

Model Year:

Engine:

Option:

Optional Information:

VIN:

Memo:

Manual Help <Back Next> Cancel

### 1. PERFORM A HEALTH CHECK

- Confirm the Techstream is connected to the dealership's internet.
- When launching the Techstream software the VIN may auto populate if not then it **MUST** be entered manually.

**NOTE: All letters of the VIN MUST be entered in ALL CAPS, or the VIN will need to be reentered when running the diagnostic report.**

- Perform a health check.

**Note: The VIN may auto populate on the later model year vehicles, if this happens DO NOT change the VIN.**

### 2. RUN A DIAGNOSTIC REPORT

- After the health check has completed, run a diagnostic report by clicking on the link on the health check screen.

Monitor Status	DTC	Curr	Pend	Hist	Perm	SB	Calibration	Update

Default User DLC 3

**NOTE: If the VIN was not entered in ALL CAPS when Techstream was launched, an error will be displayed and there will be a prompt to reenter the VIN**



Lexus Diagnostic Report

Vehicle Information

Mileage:

Repair Order:

Report

- Enter the vehicle mileage and repair order information, then click the 'report' button.



- A health check and diagnostic report with the VIN MUST be performed within the last 36 hours, and recorded by TMS. If the diagnostic report is not run, the healthcheck will not be recognized by TMS.**
- The serial number recording application will be disabled and the repair cannot be completed if a health check and diagnostic report is not performed and recorded by TMS.**
- This campaign only covers replacement of the passenger dash airbag. If other SRS repairs are needed they are NOT covered under this campaign.**

# VII. FRONT PASSENGER AIRBAG REMOVAL COMPONENTS



UPPER CONSOLE PANEL ASSEMBLY WITH FRONT ASH RECEPTACLE

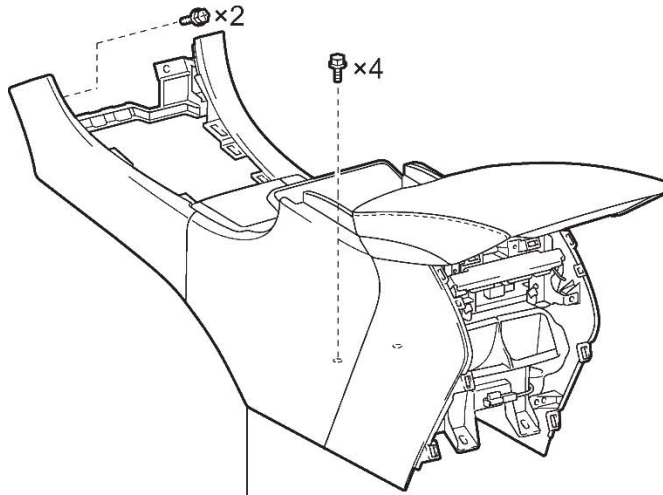
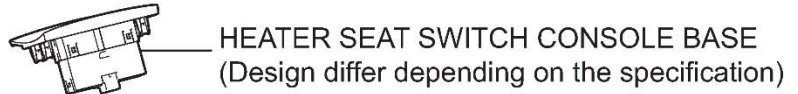
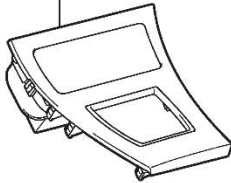

REAR CONSOLE BOX ASSEMBLY  
(Design differ depending on the specification)

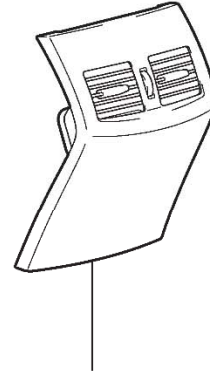

CONSOLE REAR END PANEL SUB-ASSEMBLY

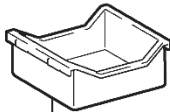

CONSOLE BOX POCKET  
(Design differ depending on the specification)

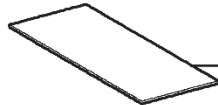

CONSOLE BOX CARPET

R1701240004

TURN SIGNAL SWITCH ASSEMBLY WITH SPIRAL CABLE SUB-ASSEMBLY

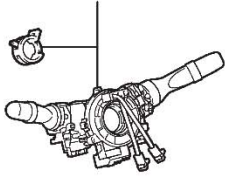

TILT AND TELESCOPIC SWITCH

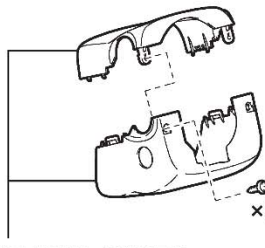

STEERING COLUMN COVER

2.0 (20, 18 in.\*lbf)

x2

COMBINATION METER ASSEMBLY

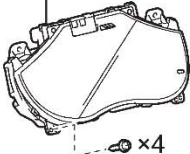

x4

STEERING WHEEL ASSEMBLY

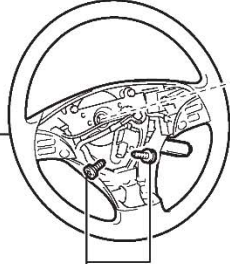

50 (510, 37)

LOWER No. 3 STEERING WHEEL COVER



8.8 (90, 78 in.\*lbf)

LOWER No. 2 STEERING WHEEL COVER



INSTRUMENT CLUSTER FINISH PANEL SUB-ASSEMBLY

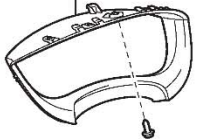

LOWER INSTRUMENT PANEL RH

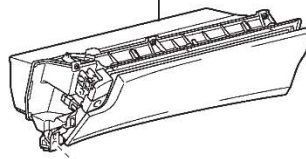

x6

STEERING PAD



SIDE INSTRUMENT PANEL LH



FRONT PASSENGER SIDE KNEE AIRBAG ASSEMBLY

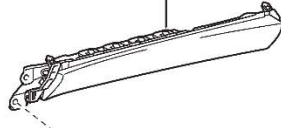

x3

10 (102, 7)

SIDE INSTRUMENT PANEL RH



No. 1 SWITCH HOLE BASE

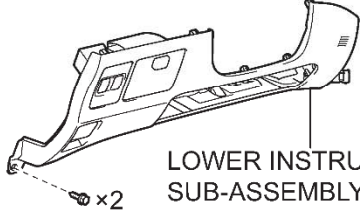
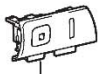

LOWER INSTRUMENT PANEL SUB-ASSEMBLY

FRONT DOOR OPENING TRIM COVER RH



FRONT DOOR OPENING TRIM COVER LH



INSTRUMENT PANEL FINISH PANEL END RH

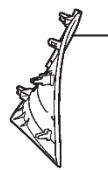

INSTRUMENT PANEL FINISH PANEL END LH



FRONT DOOR SCUFF PLATE RH

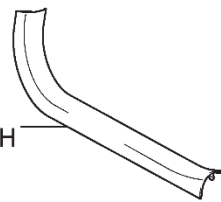

FRONT DOOR SCUFF PLATE LH

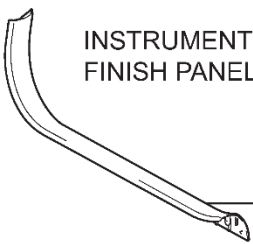

No.2 INSTRUMENT PANEL UNDER COVER SUB-ASSEMBLY

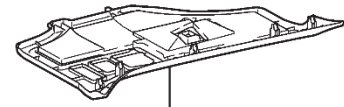

N\*m (kgf\*cm, ft\*lbf) : Specified torque

R1701240005

● FRONT PILLAR GARNISH CLIP

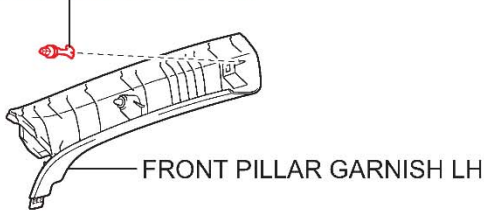

● FRONT PILLAR GARNISH CLIP

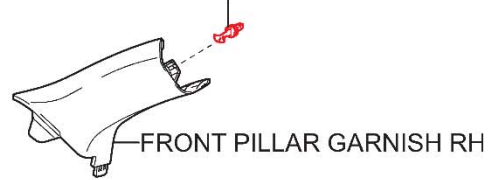

No. 1 INSTRUMENT PANEL SPEAKER  
PANEL SUB-ASSEMBLY



INSTRUMENT PANEL  
SAFETY PAD ASSEMBLY



No. 1 SPEAKER HOLE COVER



No. 2 INSTRUMENT PANEL SPEAKER  
PANEL SUB-ASSEMBLY

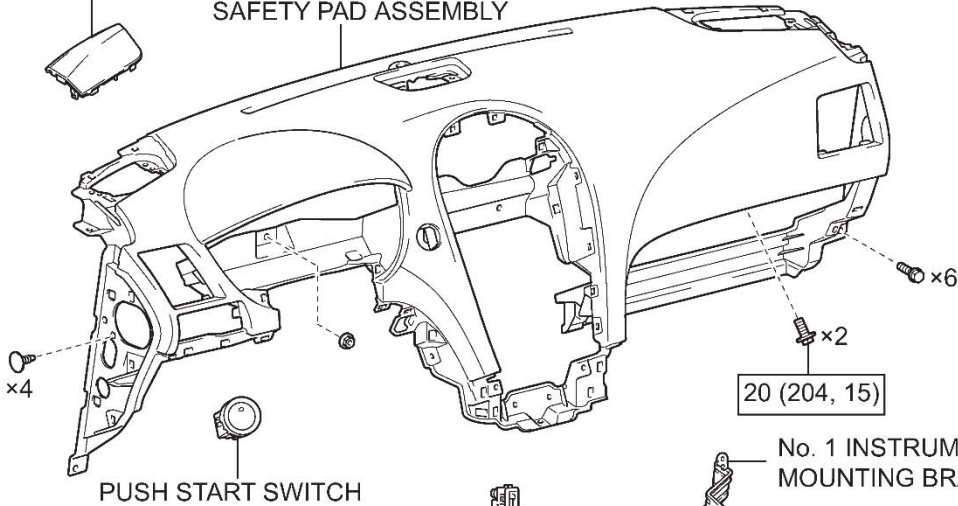

x4

PUSH START SWITCH

ROOM TEMPERATURE SENSOR

20 (204, 15)

No. 1 INSTRUMENT PANEL  
MOUNTING BRACKET

FRONT STEREO COMPONENT  
SPEAKER ASSEMBLY  
(Design differ depending on the specification)



FRONT No. 2 SPEAKER ASSEMBLY  
(Design differ depending on the specification)

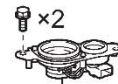

FRONT No. 2 SPEAKER ASSEMBLY  
(Design differ depending on the specification)



No. 2 INSTRUMENT PANEL  
REGISTER ASSEMBLY

No. 1 INSTRUMENT PANEL  
REGISTER ASSEMBLY

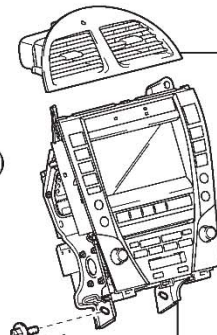

INTEGRATION CONTROL PANEL or  
MULTI-DISPLAY or  
DISPLAY AND NAVIGATION MODULE DISPLAY  
WITH RADIO RECEIVER ASSEMBLY

No. 3 INSTRUMENT PANEL  
REGISTER ASSEMBLY

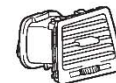

● Replacement part

N\*m (kgf\*cm, ft\*lb) : Specified torque

R1701240006



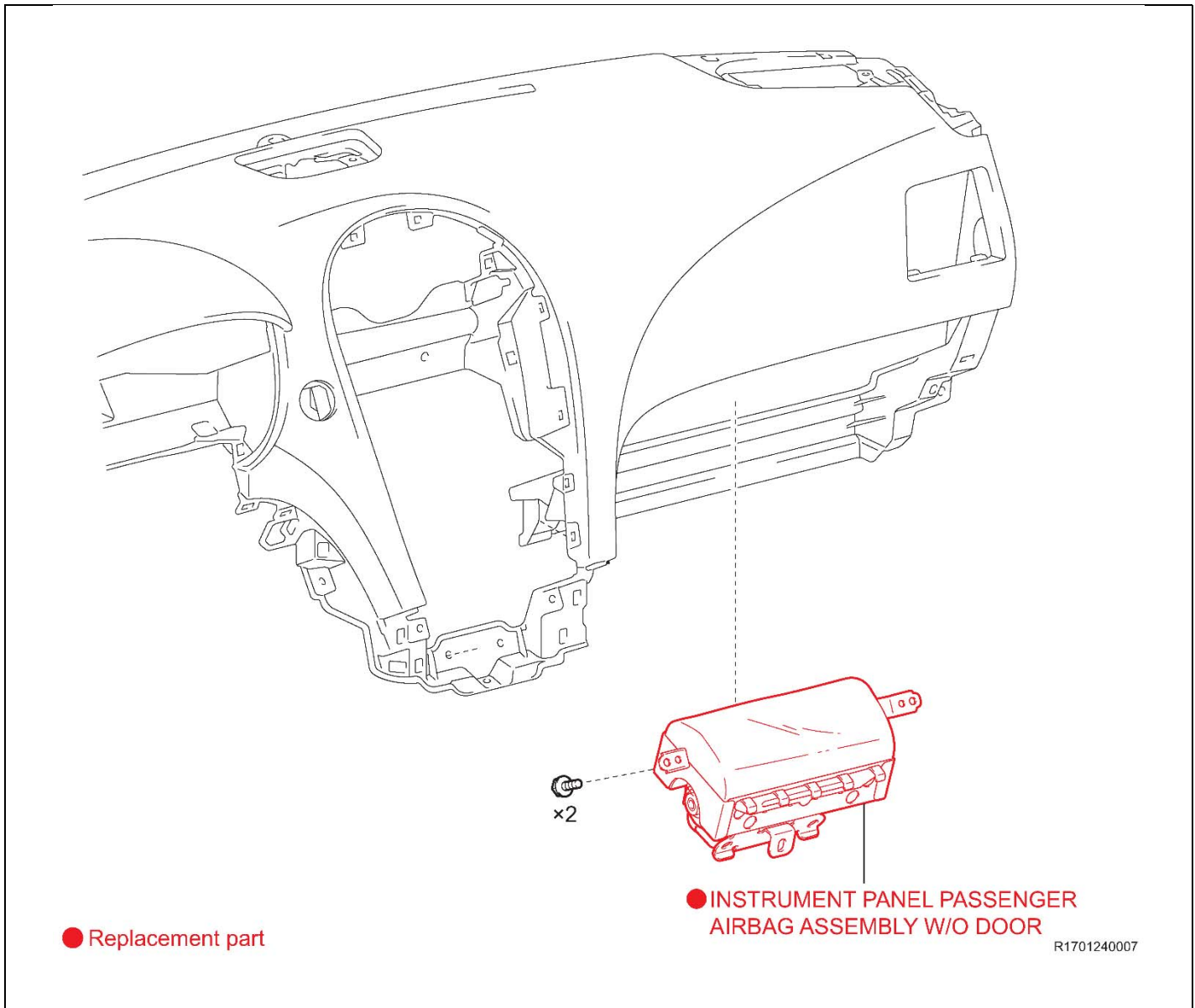

## 1. REMOVE THE AIRBAG MODULE



- Wait at least 90 seconds after disconnecting the cable from the negative battery terminal to prevent airbag and seat belt pre-tensioner deployment.
- Follow all precautions as outlined on TIS before servicing the SRS system.

a) Refer to TIS for removal instructions.

<a href="#">2007 MY</a>	<a href="#">2008 MY</a>	<a href="#">2009 MY</a>	<a href="#">2010 MY</a>
-------------------------	-------------------------	-------------------------	-------------------------

## VIII. AIRBAG RECORDING

### 1. LAUNCH THE SERIAL NUMBER RECORDING APPLICATION

**Note:** The Serial Number Recording Application is the same application used for a prior campaign.



- The AIRBAG ASSEMBLY serial numbers **MUST** be recorded using a barcode scanner (provided at the launch of SSC DLC).
- The barcode scanner application **MUST** be completed on every vehicle. These numbers **MUST** be included on every warranty claim that is submitted for airbag module replacement or the claim may be subject to debit.
- The technician performing the work **MUST** have valid TIS login credentials and an internet connection to perform the inspection and scanning process.

- Log in to TIS and input the VIN of the vehicle in the Vehicle Inquiry tab.
- Confirm the VIN is applicable and that the campaign has not been completed.
- Click on the link to launch the serial number recording application.

**Vehicle Identification Number Search**  
Enter a 17 Digit VIN below to search for applicable information:  
VIN: 1NX BR32E 000000000

**Vehicle Information**

Division: TOYOTA	Model: Corolla	Grade: CE	Model Year: 2003
Drive Type: 2WD	Body Type: 4Dr. Sedan	Engine Family: 4-cylinder - 1ZZ	Transmission:
Date of First Use:	Production Date: 01/18/2002	Plant Code: Z - FREMONT PLANT - NUMMI	
VIN: 1NX -BR32E-000000000	Standard Equipment: <a href="#">Click here to display</a>		
Exterior Color: 03M5, SANDRIFT METALLIC	Interior Color: FA41, FA41	Interior Trim Color: FA, *	Interior Fabric: F, *

Vehicle accessories are not currently available. Try your query again later.

**Service Campaign**

**Campaign Description:** Safety Recall D0F Remedy Notice - 2003-2004 Model Year Corolla, Corolla Matrix, Sequoia, and Tundra Vehicles, 2002-2003 Model Year Vehicle Front Passenger Airbag Inflator Module

**Completion Status:** Not Completed [\(Check applicability for VIN\)](#)

[Show Documents]

- Reenter TIS password in the serial number recording application.

**NOTE:** The person logged-in to TIS **MUST** be the person performing the repair.

Front Passenger Airbag Inflator Module - Safety Recall  
SSC - DSF

User ID: SuzukiR Technician Name: Russell Suzuki  
Dealer Code: Dealer Name:  
Time: 06/10/2014 02:07 PM PDT Airbag Serial #:  
Original Inflator Serial #: Replacement Inflator Serial #:

VIN: STD 8T44... REIFE H, H, J  
Mileage\*

Task	Dealer	User	Time	Status
Airbag # Record				Not Started
Inflator # Record				Not Started
Terms & Conditions				Not Started
New Airbag #				Not Started

- Record the vehicle mileage into the serial number recording application.

**NOTE:**

- A task status screen will populate next and at other intervals during the repair. This screen will indicate if the airbag was replaced. Click 'next' to proceed to the next step. This information will be used for record keeping by TMS.
- If this screen indicates that the campaign has already been completed on this VIN, there is no need to perform the campaign again.

## 2. CONNECT THE BARCODE SCANNER

- Connect the barcode scanner to the USB port on the Techstream.
- The scanner will automatically connect and a beep will be heard when the scanner is ready.

### NOTE:

- The scanner was provided for SSC DLC.
- The barcode scanner works best in low light conditions.
- Always hold the scanner directly in front of and parallel to the barcode label.

## 3. SCAN THE AIRBAG SERIAL NUMBER

# ATTENTION: This information is **CRITICAL**

- Scan the **AIRBAG ASSEMBLY** serial number 2 times.
  - Confirm that the cursor is in the first serial number box and scan the bar code.
  - Position the cursor in the second serial number box and rescan the bar code.
- Click next.

### NOTE:

- If the serial numbers do not match, confirm and reenter.
- If the serial number barcode will not scan, it can be entered manually.

### AIRBAG SERIAL NUMBER IDENTIFICATION

- The airbag serial number is **ALWAYS** the **12 DIGITS** located between the asterisks.
- The **3 digits** before the asterisk **ARE NOT** part of the serial number, and **SHOULD NOT** be entered or an inaccurate response may be returned.

#### Airbag Serial Number Label Example



The **AIRBAG ASSEMBLY** serial number **MUST** be recorded prior to replacement.

### Front Passenger Airbag Inflator Module - Safety Recall

#### SSC DSC

1 2 3 4 5

User ID:

Technician Name:

Dealer Code:

Dealer Name:

Time: 03/30/2015 05:15 AM PDT

VIN: 1NX BR32E 14Z308698 [2004 Corolla SUPER WHITE]

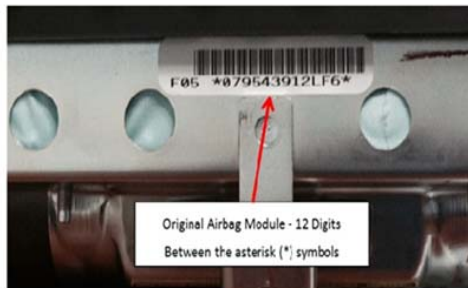

Original Airbag Module - 12 Digits  
Between the asterisk (\*) symbols

Record Airbag Serial Number

How to identify an Airbag module Assembly number?

The Airbag module Assembly serial number is a **12 digit code**. It can be found along with a bar code on opening the Airbag assembly unit. To manually enter these details into the application, the technician has to identify the 12 digit code between two Asterisks (\*) inside the Airbag assembly unit. The first seven characters of this 12 digit code are numbers and the 10<sup>th</sup> digit is either 'K' or 'L' always.

Use of a barcode scanner is strongly recommended when entering Airbag Assembly Serial Number.

If manually typing serial number, you **MUST** include all leading zeros. (If applicable)

\* Airbag Assembly Serial Number:

\* Reconfirm Airbag Assembly Serial Number:

If original Airbag Assembly serial number is not visible or missing, check this box

Clear Next

(\*) - Indicates Required Field(s)

- c) Check the box that states that the inflator serial number is not visible or missing.  
**(DO NOT SCAN THE INFLATORS)**  
**(this will allow the program to advance to the next screen)**

Front Passenger Airbag Inflator Module - Safety Recall  
SSC - E04

User ID: \_\_\_\_\_  
Dealer Code: \_\_\_\_\_  
Time: 03/30/2015 05:17 AM PDT

1 2 3 4 5

Technician Name: \_\_\_\_\_  
Dealer Name: \_\_\_\_\_  
Airbag Serial #: \*\*\*\*\*12

VIN: 1NX BR32E 14Z308698 [2004 Corolla SUPER WHITE]

**Original Inflator**



How to identify the inflator serial code on the Original and Replacement Inflator can?

The Inflator serial code is an **11 digit code** on the Inflator can. It can be found with a bar code on removing the Inflator can from the Airbag Assembly unit.

The first two characters of the **Original Inflator Serial code** will be from [AA, AB, AJ, FD or JD].

The first two characters of the **Replacement Inflator Serial code** will be either 'LT' or 'LR'.

**Replacement Inflator**



Inflator Module replacement IS REQUIRED on all vehicles under the Safety Recall. Follow the technical instructions and acknowledge the following statements.

**If manually typing serial number, you MUST include all leading zeros. (If applicable)**

Original Inflator Serial #:

If old inflator serial number is not visible or missing, check this box

\* Replacement Inflator Serial #:

**If you have a concern with the inflator serial numbers, please email [quality\\_compliance@toyota.com](mailto:quality_compliance@toyota.com) with details.**

I agree to complete the safety recall's remaining technical instructions.

I agree to perform a vehicle Health Check with Techstream upon completion of the safety recall's technical instructions.

(\*) - Indicates Required Field(s)

Back Clear

- d) Confirm agreement by checking the two boxes and press submit.

**NOTE: The NEW AIRBAG ASSEMBLY serial number MUST be scanned prior to reinstallation to track the airbag to the vehicle (refer to page 13).**

e) Scan the **NEW** Airbag barcode in the Serial Number Recording Application.

## Front Passenger Airbag Inflator Module - Safety Recall

### SSC DSC

1 2 3 4 5

User ID: \_\_\_\_\_ Technician Name: \_\_\_\_\_  
Dealer Code: \_\_\_\_\_ Dealer Name: \_\_\_\_\_  
Time: 03/30/2015 05:15 AM PDT VIN: 1NX BR32E 14Z308698 [2004 Corolla SUPER WHITE]



Original Airbag Module - 12 Digits  
Between the asterisk (\*) symbols

[How to Identify an Airbag module Assembly number?](#)

The Airbag module Assembly serial number is a **12 digit code**. It can be found along with a bar code on opening the Airbag assembly unit. To manually enter these details into the application, the technician has to identify the 12 digit code between two Asterisks (\*) inside the Airbag assembly unit. The first seven characters of this 12 digit code are numbers and the 10<sup>th</sup> digit is either 'K' or 'L' always.

**Record Airbag Serial Number**

Use of a barcode scanner is strongly recommended when entering Airbag Assembly Serial Number.

If manually typing serial number, you **MUST** include all leading zeros. (If applicable)

\*New Airbag Assembly Serial Number:

I agree to complete the safety recall's remaining technical instructions.

I agree to perform a vehicle Health Check with Techstream upon completion of the safety recall's technical instructions.

(\*) - Indicates Required Field(s)

Next

f) Confirm agreement by checking the two boxes and press next.



The new **AIRBAG ASSEMBLY** serial number **MUST** be recorded prior to reinstallation to track the airbag to the vehicle.

g) Record the Warranty Authorization # to be included in the warranty claim.

T3 :: SuzukiR - Google Chrome  
t3qa.tms.toyota.com/t3Portal/portlets/tis/airBag/AirBagController.portlet?\_nfpb=true&\_windowLabel=Standal

## Front Passenger Airbag Inflator Module - Safety Recall

### SSC - DSF

1 2 3 4 5

**User ID:** SuzukiR      **Technician Name:** Russell Suzuki  
**Dealer Code:**      **Dealer Name:**  
**Time:** 06/10/2014 05:13 PM PDT      **Airbag Serial #:** \*\*\*\*\*96  
**Original Inflator Serial #:** AAEL5110212      **Replacement Inflator Serial #:** AAEL5110213

SuzukiR has agreed to the following terms and conditions on 06/10/2014 05:13 PM PDT

- \* I agree to complete the safety recall's remaining technical instructions.
- \* I agree to perform a vehicle Health Check with Techstream upon completion of the safety recall's technical instructions.

**Russell Suzuki** has successfully confirmed completion of Airbag Inflator Module Safety Recall for  
**VIN - 5TD BT44A 33S157291 [2003 Sequoia BEIGE M. M.]**  
**Warranty Authorization #: b5511e9f**  
Airbag inflator module was replaced under this safety recall.  
Print this page for your records and then click 'Close' to resume working.

Close

h) Confirm agreement by checking the two boxes.

i) Place the old airbag in the parts box and return it to the parts department.

**NOTE:**

- **Keep all shipping paperwork with the box that it came in.**
- **Confirm the cursor is in the correct serial number input box before scanning.**
- **If the serial number barcode will not scan, it can be entered manually.**
- **If there are any difficulties or concerns with this process, email [quality\\_compliance@toyota.com](mailto:quality_compliance@toyota.com) with details.**

## AIRBAG SERIAL NUMBER IS MISSING OR IS UNREADABLE



If the airbag serial number and barcode are not legible or are not present, check the box in the application indicating the serial number is not legible.

a) If the airbag serial number cannot be scanned or is not present check the box as shown below.

Front Passenger Airbag Inflator Module - Safety Recall  
SSC DSC

(1) (2) (3) (4) (5)

User ID: \_\_\_\_\_ Technician Name: \_\_\_\_\_  
Dealer Code: \_\_\_\_\_ Dealer Name: \_\_\_\_\_  
Time: 03/30/2015 05:15 AM PDT VIN: 1NX BR32E 14Z308698 [2004 Corolla SUPER WHITE]

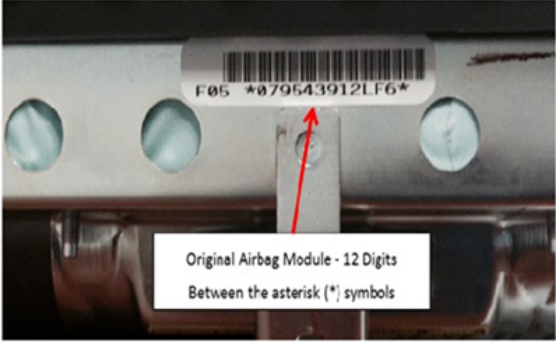

Record Airbag Serial Number

[How to Identify an Airbag module Assembly number?](#)

The Airbag module Assembly serial number is a **12 digit code**. It can be found along with a bar code on opening the Airbag assembly unit. To manually enter these details into the application, the technician has to identify the 12 digit code between two Asterisks (\*) inside the Airbag assembly unit. The first seven characters of this 12 digit code are numbers and the 10<sup>th</sup> digit is either 'K' or 'L' always.

Use of a barcode scanner is strongly recommended when entering Airbag Assembly Serial Number.  
If manually typing serial number, you MUST include all leading zeros. (If applicable)

\* Airbag Assembly Serial Number:   
\* Reconfirm Airbag Assembly Serial Number:

If original Airbag Assembly serial number is not visible or missing, check this box

Clear Next

(\*) - Indicates Required Field(s)

Check this box if the label is damaged or missing

b) Return to Page 13 and continue.

## IX. VEHICLE REASSEMBLY

### 1. INSTALL THE NEW AIRBAG ASSEMBLY INTO THE INSTRUMENT PANEL

### 2. REINSTALL THE DASH

a) Refer to TIS for reinstallation instructions

<a href="#">2007 MY</a>	<a href="#">2008 MY</a>	<a href="#">2009 MY</a>	<a href="#">2010 MY</a>
-------------------------	-------------------------	-------------------------	-------------------------

### 3. RECONNECT THE NEGATIVE BATTERY CABLE

### 4. PERFORM A HEALTH CHECK AND DIAGNOSTIC REPORT

### 5. PERFORM ANY NEEDED SYSTEM INITIALIZATIONS

## ◀ VERIFY REPAIR QUALITY ▶

- Confirm all precautions are followed to ensure safety during the repair
  - Confirm the entire serial number checker application is completed and the warranty authorization # is recorded on *EVERY* vehicle
  - Confirm the old airbag is handled safely and given to the appropriate parts professional for shipment
- If you have any questions regarding this update, please contact your area representative.

## X. APPENDIX

### A. CAMPAIGN DESIGNATION DECODER

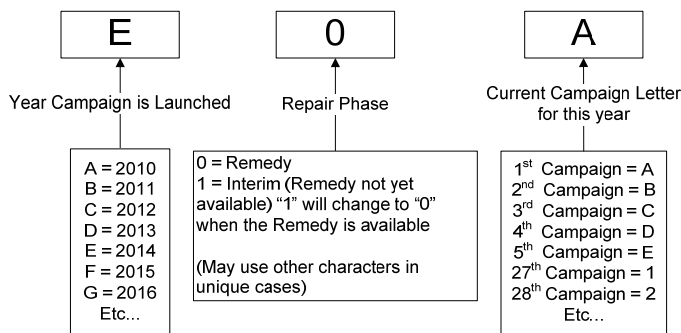

Examples:

A0D = Launched in 2010, Remedy Phase, 4<sup>th</sup> Campaign Launched in 2010

B1E = Launched in 2011, Interim Phase, 5<sup>th</sup> Campaign Launched in 2011

C1C = Launched in 2012, Interim Phase, 3<sup>rd</sup> Campaign Launched in 2012

### B. CAMPAIGN PARTS DISPOSAL

**ALL** airbags that are removed from vehicles under this campaign **MUST** be packaged and shipped back to the manufacturer following the manufacturer's instructions. The instructions can be found in the following locations:

- Attached to the dealer letter
- Included in the parts box