

Technical Support

Thank you for selecting NETGEAR products.

After installing your device, locate the serial number on the label of your product and use it to register your product at www.NETGEAR.com/register. Registration is required before you can use our telephone support service. Registration through our website is strongly recommended.

Go to <http://support.netgear.com> for product updates and web support.

NETGEAR, Inc.
350 East Plumeria Drive
San Jose, CA 95134 USA



201-15224-04

November 2012

NETGEAR®

Connect with Innovation™

Dual Band 11ac WiFi Router R6300 Installation Guide



Package Contents

The box should contain the following items. If any items are incorrect, missing, or damaged, contact your NETGEAR dealer.



Dual Band WiFi Router

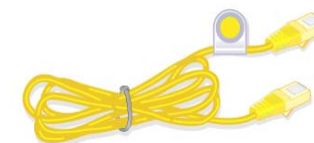

Ethernet cable

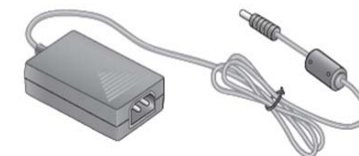

Power adapter



Power cord

Note: In some regions, a Resource CD is included with your product.

Important: Be sure to remove the plastic film from the router before using it.

You can use this diagram to connect your router or follow the detailed instructions in this booklet.

1. Prepare your modem.

Unplug your modem. If it has a battery backup, remove the battery.

2. Connect your modem.

Plug in your modem. Put the battery back in. Then cable the modem to the router Internet port.

3. Power on the router.

4. Connect a computer.

5. Launch a browser.

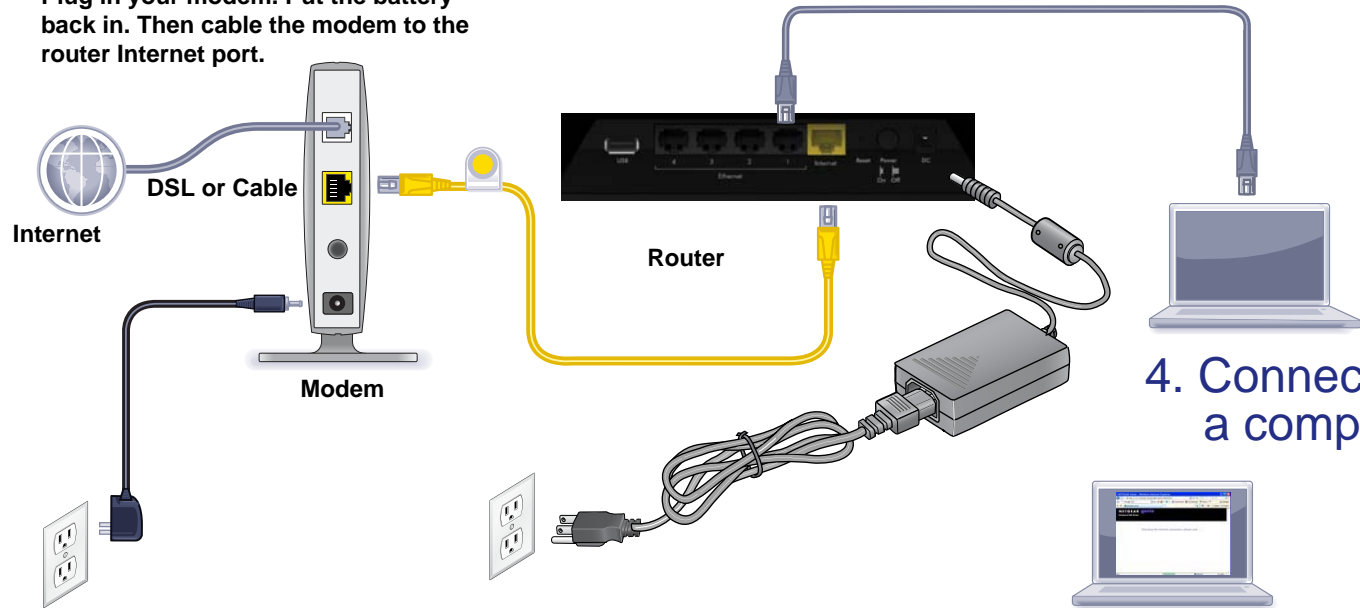

Compliance

Declarations of Conformity

For complete DoC please visit the NETGEAR EU Declarations of Conformity website at: http://support.netgear.com/app/answers/detail/a_id/11621/.
For GNU General Public License (GPL) related information, please visit http://support.netgear.com/app/answers/detail/a_id/2649



This symbol is placed in accordance with the European Union Directive 2002/96 on the Waste Electrical and Electronic Equipment (the WEEE Directive). If disposed of within the European Union, this product should be treated and recycled in accordance with the laws of your jurisdiction implementing the WEEE Directive.

Contents

Install Your Router	2
Prepare your modem	2
Connect your modem	2
Power on the router	3
Connect a computer	3
Launch a browser	4
Preset Wireless Security	4
Wireless Network Settings	5
Add Wireless Devices to the Network	6
WPS Method	6
Manual Method	6
Access the Router to Make More Changes.	7
Troubleshooting.	9
ReadySHARE Access	9
ReadySHARE Printer	10
Other Features	15

Install Your Router

Make sure that your Internet service is active before you install the router. Follow steps 1 through 5.

1. Prepare your modem.

- Unplug your modem's power.
- If the modem has a battery backup, remove its batteries.
- If your modem was already connected to another router, disconnect the cable between your modem and that router.

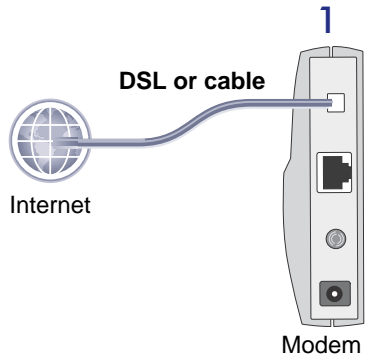

Now your modem should be completely turned off, and cabled only to the wall jack for your Internet service.

2. Connect your modem.

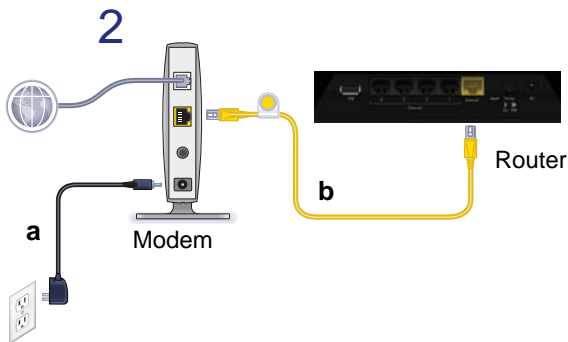

- Plug in, then turn on your modem. (Replace the batteries if you removed them previously.)
- With the yellow Ethernet cable that came with the router, connect your modem to the Internet port of your router.

3. Power on the router.

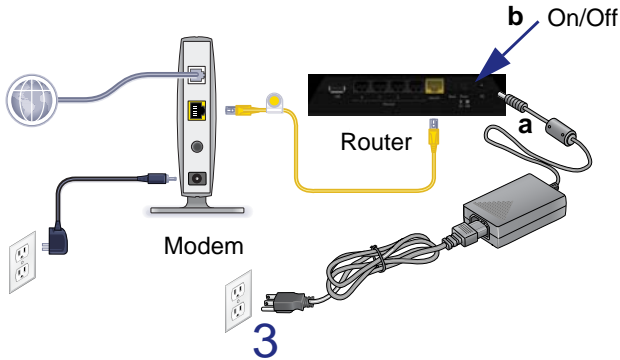

- a. Connect the power adapter to the router and plug the power adapter into an outlet.
- b. Before going to Step 4, wait for the wireless LED on the front panel of the router to turn on. If none of the LEDs on the front panel are on, press the **Power On/Off** button on the rear panel of the router.

4. Connect a computer.

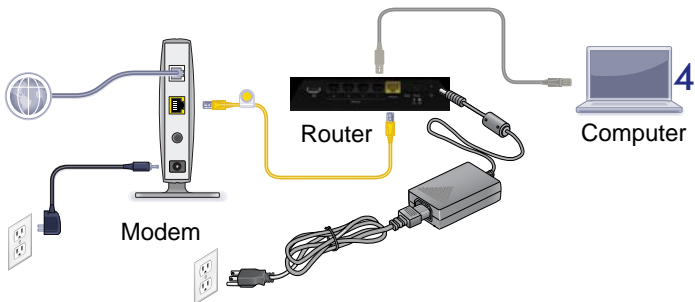

You can use an Ethernet cable (not included) or connect wirelessly.

- Use the Ethernet cable to connect your computer to an Ethernet port on your router.
- Or, connect wirelessly by using the preset wireless security settings located on the label on the bottom of the router.

5. Launch a browser.

If a web page does not open, close and reopen the browser and type **http://routerlogin.net** in the address bar, or see *Troubleshooting* on page 9.

5



Preset Wireless Security

This product has a *unique* WiFi network name (SSID) and network key (password). The default SSID and network key (password) are uniquely generated for every device, like a serial number, to protect and maximize your wireless security. This information is located on the label on the bottom of the product.

NETGEAR recommends that you do not change the preset WiFi network name (SSID) and network key (password). If you do change the settings, the security SSID and password on the bottom of the product no longer apply.

NETGEAR
R6300 WiFi Router
Model: **R6300**

Power Internet WiFi USB
On/Off

ReadySHARE Access on Windows:
Start -> RUN -> \\readyshare (type \\readyshare)

This device complies with Part 15 of the FCC Rules. Operation is subject to the following two conditions: (1) this device may not cause harmful interference, and (2) this device must accept any interference received, including interference that may cause undesired operation.

This Class [B] digital apparatus complies with Canadian ICES-003. Cet appareil numérique de la classe [B] est conforme à la norme NMB-003 du Canada.

FCC ID: PY312100188
IC: 4054A-12100188

ROUTER LOGIN <http://www.routerlogin.net>
user name: admin password: password

2PU1157WFFFFF
SERIAL
123456789ABC
MAC
NETGEARXX
WiFi Network Name (SSID)
asdfgjklloppqwerty345fsdk
Network Key (Password)

Designed by NETGEAR in California: 272-11413-01

Wireless Network Settings

Record the default preset wireless settings that are printed on the label in the space below for easy reference.

WiFi Network Name (SSID): _____

Network Key (Password): _____

If you change the default settings, record them here for easy reference, and then store this booklet in a safe place:

WiFi Network Name (SSID): _____

Network Key (Password): _____

To retrieve or update your wireless password, type **www.routerlogin.net** in a web browser and log in using the default user name (admin) and password (password).

Select **Wireless Settings** to locate your wireless password.

Add Wireless Devices to the Network

Choose either the manual or Wi-Fi Protected Setup (WPS) method to add wireless computers and other devices to your wireless network.

WPS Method

If your wireless device supports WPS—NETGEAR calls this method Push 'N' Connect—you might be prompted to press the WPS button on the router instead of entering a password. If this happens:

1. Press the **WPS** button  on the router.
2. Within 2 minutes, press the **WPS** button on the client device, or follow the WPS instructions that came with your wireless device to complete the WPS process. Then the device connects to the router.
3. Repeat this process to add other WPS wireless devices.

Note: WPS does not support WEP security. If you try to connect a WEP client to your network using WPS, it does not work.

Manual Method

1. On the wireless device that you want to connect to your router (iPhone, laptop, computer, gaming device), open the software utility that manages its wireless connections. This utility scans for all wireless networks in your area.
2. Look for the preset NETGEAR WiFi network name (SSID) and select it. The SSID is located on the product label on the bottom of the router.

Note: If you changed the name of your network during the setup process, look for that network name.

3. Enter the preset password (or your custom password if you changed it), and click **Connect**.

Repeat steps 1–3 to add other wireless devices.

Access the Router to Make More Changes

After you use NETGEAR Genie to set up the router, you can log in to the router to view its settings or make changes.

➤ **To log in to the router:**

1. Launch a web browser from a computer or wireless devices that is connected to the router.
2. Type **www.routerlogin.net** or **www.routerlogin.com** in the address field of the browser. A login screen displays:



The screenshot shows a login form with the following elements:

- User name:** A dropdown menu with 'admin' selected.
- Password:** A text input field containing '*****'.
- Remember my password:** An unchecked checkbox.
- Buttons:** 'OK' and 'Cancel' buttons at the bottom.

3. Enter **admin** for the user name and **password** for the password. The router Basic Home screen displays:



See the User Manual for more information about the router screens.

- **To change the password for the router user name:**
 1. Log in to the router.
 2. Select **Administration > Set Password** to display the Set Password screen:

The screenshot shows a web browser window with the title "Set Password". At the top right, there are two buttons: "Cancel" (with a close icon) and "Apply" (with a right arrow icon). Below the buttons, there are three text input fields. The first is labeled "Old Password", the second "Set Password", and the third "Repeat New Password". Below the input fields, there is a checkbox labeled "Enable Password Recovery".

3. Type your old password, and type the new password twice. NETGEAR recommends that you use the password recovery feature when you change your password.
4. Select the **Enable Password Recovery** check box.
5. Click **Apply**.
6. You are prompted to answer questions, which are saved.

- **To use password recovery to retrieve a forgotten password:**

You need to enable password recovery as described in the previous section in order to use this feature.

1. Launch a web browser from a computer or wireless devices that is connected to the router.
2. Type **www.routerlogin.net** or **www.routerlogin.com** in the address field of the browser.
3. When the login screen displays, click **Cancel**.

You are prompted to enter your saved answers so that you can log in to the router.

Troubleshooting

If the browser does not display the web page:

- Make sure that the PC is connected to one of the four LAN Ethernet ports, or wirelessly to the router.
- Make sure that the router is fully up and running. Its WiFi LED should turn on.
- Close and reopen the browser to make sure that the browser does not cache the previous page.
- Type **http://routerlogin.net**.
- If the PC is set to a static or fixed IP address (this is uncommon), change it to obtain an IP address automatically from the router.

ReadySHARE Access

After installation and set up, you can insert a USB storage device into the USB port on the router and share the contents with other network users. (If your USB device has special drivers, it is not compatible.)

Note: If your USB device requires a power supply, you must use it when connecting your USB device to a NETGEAR router or gateway. It may take up to 2 minutes before the USB drive is ready for sharing after it is connected to the router.

To access your USB device:

On Windows systems, use any of these methods:

- Select **Start > Run** and enter **\\readystore** in the dialog box. Click **OK**.
- Open Explorer or Safari and enter **\\readystore** in the address bar.
- Open My Network Places and enter **\\readystore** in the address bar.

On Mac systems, do this:

1. Select **Go > Connect to Server**.
2. Enter **smb://readyshare** as the Server Address.
3. Click **Connect**.

The readyshareconnect.exe file (for Windows) is available to download here: www.netgear.com/readyshare

ReadySHARE Printer

ReadySHARE Printer lets you connect a USB printer to the router's USB port, and access it wirelessly.

To set up ReadySHARE Printer:

Step 1: Connect the USB printer to the router's USB port with a USB printer cable.

Step 2: Install the USB printer driver software *on each computer* that will share the printer. If you do not have the printer driver, contact the printer manufacturer to find and download the most recent printer driver software.

Step 3: On each computer that will share the printer, download the NETGEAR USB Control Center utility. The NETGEAR USB utility has a Mac version and a Windows version, which you can access in two different ways:

- From the ReadySHARE Printer area of this URL:
www.netgear.com/readyshare

ReadySHARE® Printer

Wirelessly print from your home network to a connected USB printer

- » **Easy to Set-up: Instructions**
- » PC Utility
- » MAC Utility

Supported Routers: WNDR4500, WNDR3800, WNDRMAC



- From the ReadySHARE tab of the Desktop NETGEAR Genie.

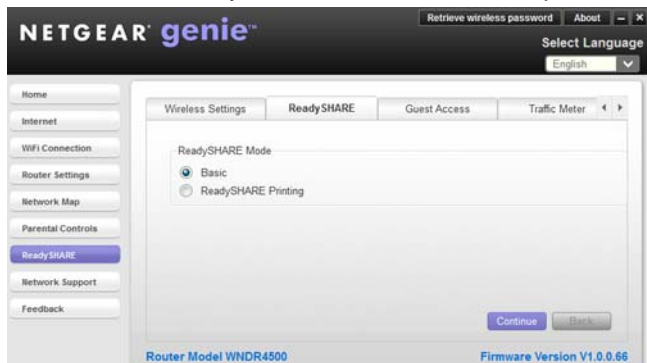

NOTE:

- You *must* install this utility before you can use the ReadySHARE Printer feature.
- For the ReadySHARE Printer feature to work, this utility must be run in the background.

Step 4: Follow the instructions to install the NETGEAR USB Control Center utility.



Step 5: After you have installed the utility, select the language.



Step 6: If this is the first time you are accessing the utility, you are asked to select the printer and click the **Connect** button.

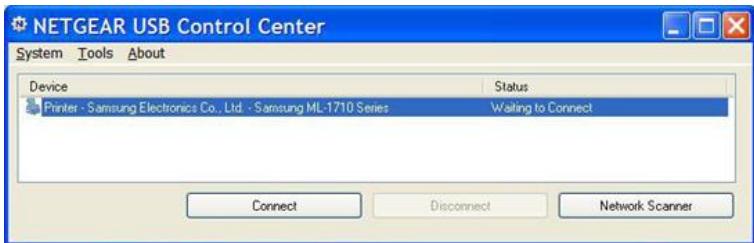

Once the connection is established, the status changes to Manually connected by xxx..

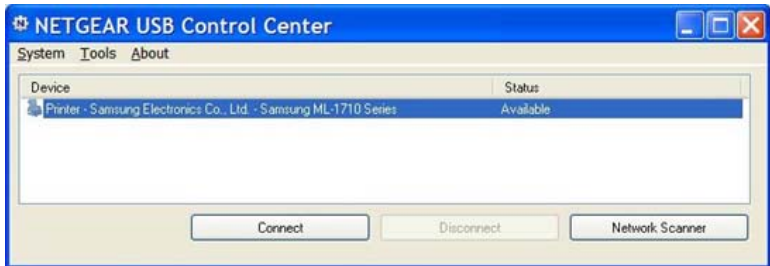

Step 7: Click the **Disconnect** button at any time to release the connection. The status then changes to Available.

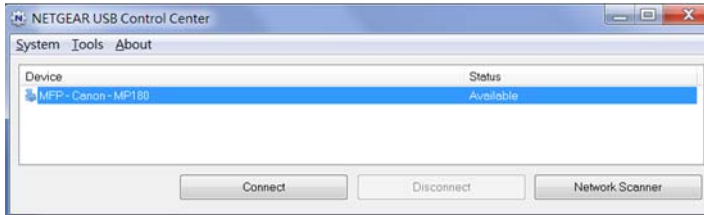

Once the Connect button has been clicked once on all computers in the network, the utility on each of them automatically handles the printing queue and handling. The status of the printer should appear as Available on all of the computers.

NOTE:

- When the status is Available, you can use the USB printer.
- When the status is Manually connected by xxx, only the xxx computer can use the printer. Other network devices must wait until the xxx computer has released the connection, or until the connection times out (the default time-out value is 30 seconds).
- You can set the value for the default time-out time from the Tools > Configuration screen.

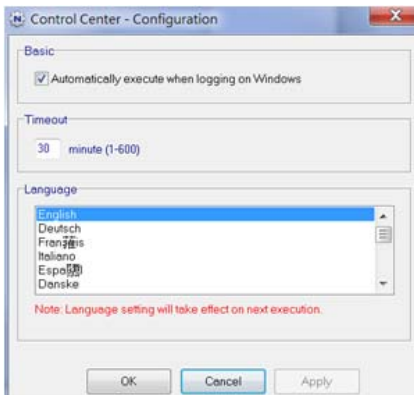

- The USB Control Center utility must be running for the computer to be able to print to the USB printer attached to the router. If you exit the utility, printing does not work.
- Some firewall software, such as Comodo, blocks the ReadySHARE Print utility from accessing the USB printer. If you do not see the printer in the utility, you can disable the firewall temporarily to allow the utility to work.

Step 8: If your printer supports scanning, make sure that the printer is in the Available state, and click the **Network Scanner** button. This activates the Scanner window so you can use the printer for scanning.

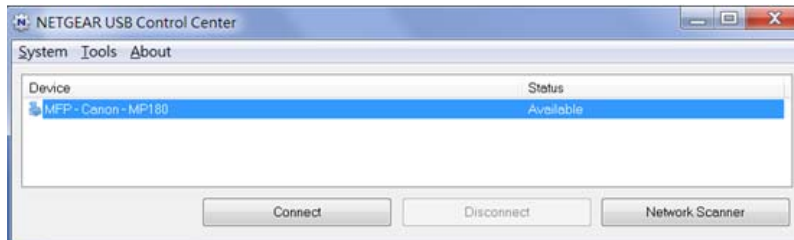

For more detailed information about ReadySHARE Printer, see the *User Manual* by clicking the **Documentation** link in the router management interface or on the R6300 product page on the Support website (<http://support.netgear.com>).

Other Features

For additional features, including Live Parental Controls, Traffic Metering, ReadySHARE, Guest Access, and more, please log into your router at <http://routerlogin.net>.

Download the free Desktop NETGEAR Genie from www.NETGEAR.com/genie.



Automatically fix common network problems and easily manage your home network connections.

© 2012 NETGEAR, Inc. All rights reserved.

No part of this publication may be reproduced, transmitted, transcribed, stored in a retrieval system, or translated into any language in any form or by any means without the written permission of NETGEAR, Inc.

DO NOT stack equipment, or place equipment in tight spaces or in drawers. Be sure your equipment is surrounded by at least 2 inches of air space.

Trademarks

NETGEAR, the NETGEAR logo, and Connect with Innovation are trademarks and/or registered trademarks of NETGEAR, Inc. and/or its subsidiaries in the United States and/or other countries. Information is subject to change without notice. Other brand and product names are registered trademarks or trademarks of their respective holders. © 2012 NETGEAR, Inc. All rights reserved.

Statement of Conditions

In the interest of improving internal design, operational function, and/or reliability, NETGEAR reserves the right to make changes to the products described in this document without notice. NETGEAR does not assume any liability that may occur due to the use or application of the product(s) or circuit layout(s) described herein.