

Technique Exterior

EDITION MARCH 2020

exterior

for
people
who
create

| | |
|----|--------------------------------|
| 4 | Products |
| 8 | Sustainability and Environment |
| 10 | Cleaning Max Compact Exterior |
| 11 | Processing Recommendations |
| 21 | Facades |
| 55 | Soffits |
| 59 | Outdoor-furniture |
| 61 | Balconies and Railings |
| 75 | Balcony Floor Panel |
| 81 | Roof Claddings |
| 85 | Sunblinds |
| 89 | Lattice Blinds |
| 90 | Suppliers/Accessories |

NOTE

PLEASE CHECK ADDITIONAL AT WWW.FUNDERMAX.AT FOR THE LATEST VERSION OF THIS BROCHURE.

THE DIAGRAMS IN THIS TECHNICAL INFORMATION ARE SCHEMATICAL REPRESENTATIONS AND ARE NOT TRUE TO SCALE.
THIS ISSUE REPLACES ALL OTHER ISSUES OF EXTERIOR TECHNIQUES BROCHURES OF FUNDERMAX WHICH WERE PUBLISHED BEFORE.



Create New Worlds

Shape, colour and material all convey emotions, tell stories and inspire new ideas. And they all lend our buildings character. Therefore, with this brochure we want provide you an overview of the creative and technical components of the Max Compact Exterior panels for outdoor use.

If you have any questions that are not answered in this brochure, please contact our sales department or application engineering department at support@fundermax.biz. We are happy to help!

What Max Compact Exterior Can Do

Max Compact Exterior panels are duromer high-pressure laminates (HPL) in accordance with EN 438-6 Type EDF that are produced in lamination presses under great pressure and high temperature. Double-hardened acrylic PUR resins provide extremely effective weather protection that is particularly suitable for longlasting balconies and facade claddings.

PROPERTIES*:

- Weather resistant to EN ISO 4892-2
- Lightfast acc. to EN ISO 4892-3
- Double hardened
- Scratch resistant
- Solvent resistant
- Hail resistant
- Easy to clean
- Impact resistant EN ISO 178
- Suitable for all exterior applications
- Decorative
- Bending resistant EN ISO 178
- Frost and heat resistant
- Constant temperature load
-80 °C to 80 °C
- Easy to install

*STANDARD- AND ACTUAL-VALUES YOU WILL FIND ON OUR WEBSITE WWW.FUNDERMAX.AT.

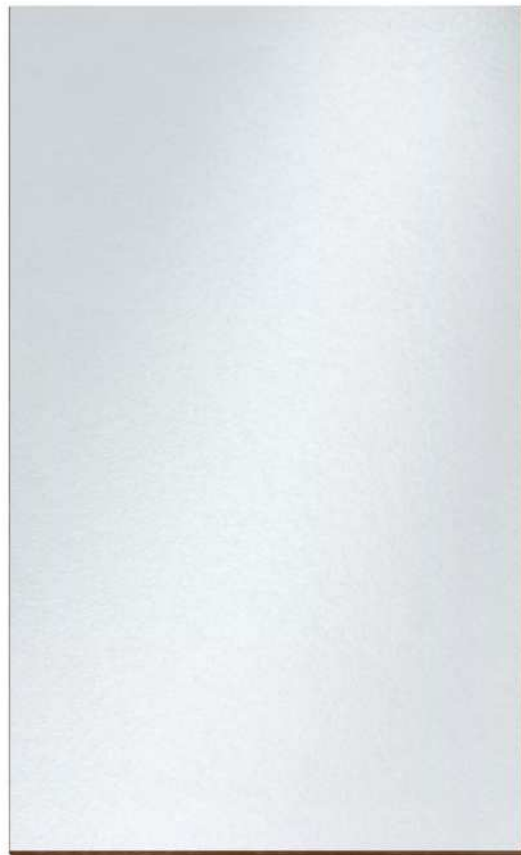
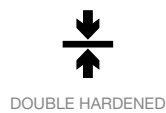



Max Compact Exterior F-Quality

As a standard, Max Compact Exterior panels come printed on both sides. The core is flame-retardant and the surface is light-fast. Thanks to the double-hardened resin, it is also extremely weather resistant. (Fire Test EN 13501-1, B-s2,d0)

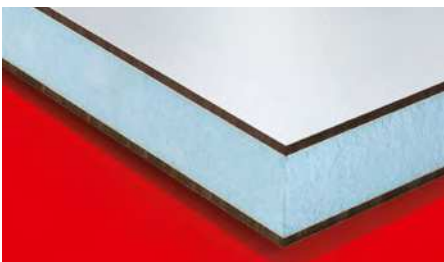

Sandwich-Elements

The Max Compact Exterior panels in F-Quality also come polished on just one side for use in sandwich elements.



Processing (Compact Elements)

FunderMax offers CNC controlled processing and panel cutting. With state-of-the-art devices, it is possible to produce everything: from simple cutouts for mounting the facade panels, to intricate milling for balcony elements. We can make just about anything you can dream up.



Professional Consulting

With our services you can use our products even more effectively. For example, take advantage of our free architect consulting and comprehensive system solutions. The same is of course also true if you have any questions about the content of this brochure or the designs and technology.

Max Compact Exterior F-Quality

Max Compact Exterior is a high-quality construction product which is used especially for long-lasting balcony and facade claddings. Max Compact Exterior panels are duromer high-pressure laminates (HPL) in accordance with EN 438-6 Type EDF with extremely effective weather protection. This weather protection consists of double-hardened acrylic polyurethane resins. They are produced in lamination presses under great pressure and at high temperatures. Max Compact Exterior panels are, of course, labelled with the CE-Mark necessary for their use in building applications.

SURFACES

NT
 NH (Hexa)/NT (format 4100 x 1854 mm only)
 NG* (Gloss)/NG (Gloss) (format 4100 x 1300 mm only)
 NY (Sky)/NT (format 4100 x 1300 mm only thicknesses 6 and 8 mm; limited decor range)

FORMATS (aprox)

9'2 1/4" x 4' 3" = 39.25 sf (2800 x 1300 mm)
 13' 5 1/8" x 4' 3" = 57.44 sf (4100 x 1300 mm)
 9'2 1/4" x 6' 5/8" = 55.79 sf (2800 x 1854 mm)
 13' 5 1/8" x 6' 5/8" = 81.65 sf (4100 x 1854 mm)

CORE

F-Quality, flame-retardant, colour brown

THICKNESSES

Panels with double-sided decor:
 Thicknesses Tolerances (EN 438-6, 5.3)
 2.0 - 2.9 mm ± 0.2 mm
 3.0 - 4.9 mm ± 0.3 mm
 5.0 - 7.9 mm ± 0.4 mm
 8.0 - 11.9 mm ± 0.5 mm
 12.0 - 13.0 mm ± 0.6 mm

Panels with the Hexa surface:
 Thicknesses Tolerances (EN 438-6, 5.3)
 6.0 - 7.9 mm ± 0.4 mm
 8.0 - 11.9 mm ± 0.5 mm
 12.0 - 15.9 mm ± 0.6 mm
 16.0 - 20.0 mm ± 0.7 mm

Panels with sanded-reverse side:
 For symmetrically structured sandwich elements.
 Thicknesses Tolerances (EN 438-6, 5.3)
 2.0 - 2.9 mm ± 0.2 mm
 3.0 - 4.0 mm ± 0.3 mm

In order to be able to design the inner sides of balconies with a uniformly light look, it is also possible to produce Max Compact Exterior panels with a white (rear) side using decor 0890 NT – Balcony white. As a result of the differing decor structure, the fastening spacings given in our Technical Information brochures should be reduced by about 15 %.

* TO GET A PERFECT DESIGN OF THE FACADE CLADDING WITH NG SURFACE IT IS RECOMMENDED TO GLUE THE PANELS ON AN ALUMINIUM-SUBCONSTRUCTION. SUBCONSTRUCTION LIKE WOOD DO NOT HAVE THE RIGHT PROPERTIES TO AVOID A WAVY APPEARANCE OF THE CLADDING.

Formats (production-sizes)

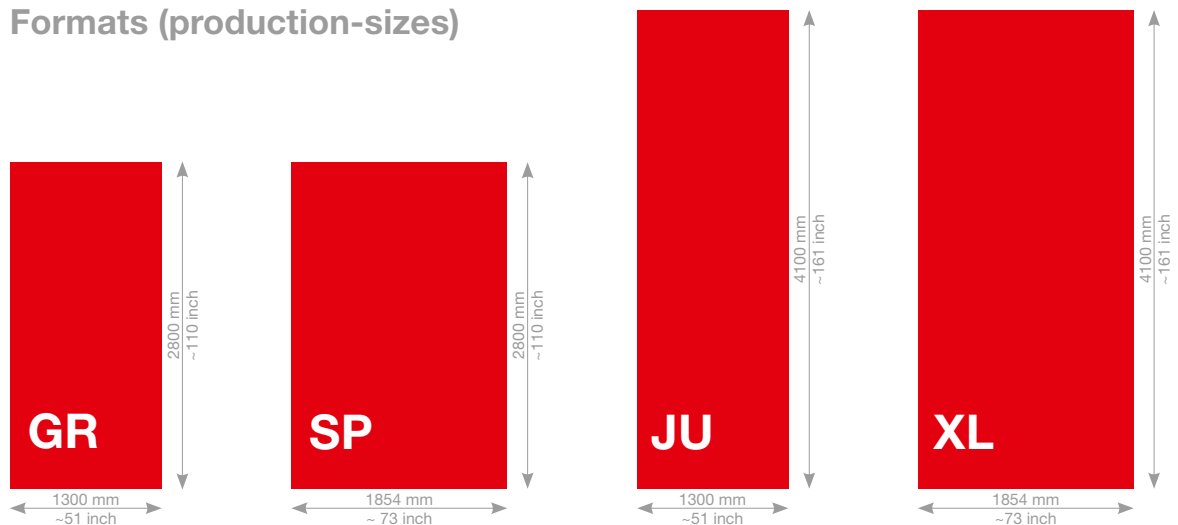

TOLERANCES +10 - 0 mm (EN 438-6, 5.3)
 PANEL FORMATS ARE PRODUCTION FORMATS. IF EXACT DIMENSIONS AND ANGLES ARE NECESSARY, WE RECOMMEND AN ALL-SIDED BLANK. DEPENDING ON THE METHOD OF TRIMMING, NET SIZE IS REDUCED BY CA. 10 mm.

STRUCTURE MAX COMPACT EXTERIOR PANEL

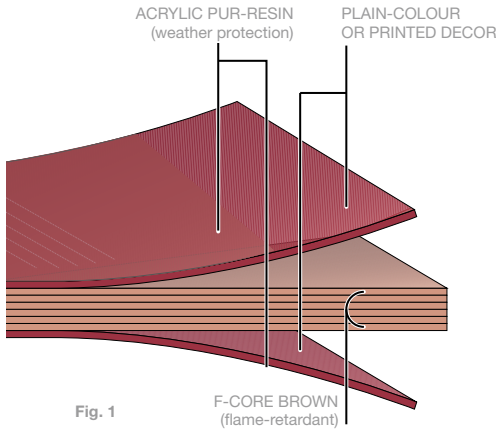

PHYSICAL DATA

| PROPERTIES | TEST METHOD | ASSESSMENT | STANDARD VALUE | ACTUAL VALUE |
|--|-------------------------|--------------------------------|---|-----------------------|
| LIGHT-FASTNESS AND WEATHER RESISTANCE (SURFACE NT) | | | | |
| Artificial weathering* | EN ISO 4892-2 3000 h | EN 20105-A02 greyscale | ≥ 3 | 4-5 |
| PROPERTIES | TEST METHOD | UNIT OF MEASUREMENT | STANDARD VALUE | ACTUAL VALUE |
| MECHANICAL PROPERTIES | | | | |
| Apparent density | DIN 52328 / EN ISO 1183 | g/cm ³ | ≥ 1.35 | ≥ 1.35 |
| Flexural strength | EN ISO 178 | MPa | ≥ 80 | ≥ 80 |
| Modulus of elasticity | EN ISO 178 | MPa | ≥ 9.000 | ≥ 9.000 |
| Coefficient of thermal expansion | DIN 52328 | 1/K | | 18 x 10 ⁻⁶ |
| Thermal conductivity | | W/mK | | 0.3 |
| Water vapour diffusion resistance | | | | ca. 17.200 μ |
| FIRE BEHAVIOUR | | | | |
| Europe | EN 13501-1 | MA39-VFA Vienna | Euroclass B-s2, d0 for 6 - 13 mm** | |
| Fire behaviour of facades in Austria | ÖNORM B 3800-5 | MA39-VFA Vienna | Approved thicknesses 8 - 13 mm | |
| Switzerland | EN 13501-1 | MA39-VFA Vienna | Euroclass B-s2, d0 for 6 - 13 mm** | |
| France | NFP 92501 | LNE | M1 for 2 - 10 mm | |
| Spain | UNE 23727-90 | LICOF | M1 for 6 - 10 mm | |
| PERMITS | | | | |
| Facade permit Germany | | Institut für Bautechnik Berlin | 6, 8, 10 mm, Approval-No. Z-10.3-712 | |
| ETB guidelines for building components which safeguard against falls, June 1985. Balcony railings. | | TU Hannover | Passed (depending on building regulation and railing construction 6, 8 or 10 or 13 mm panel thickness) | |
| Avis technique Frankreich | | CSTB | 6, 8, 10 and 13 mm, wood- and metal subconstruction Avis Technique n° 2/16-1749 Avis Technique n° 2/14-1623 Avis Technique n° 2/13-1565* V1 Avis Technique n° 2/16-1716 Avis Technique n° 2/16-1753 Avis Technique n° 2/12-1505* V1 | |
| BBA | | Wintech | A10114 | |

Table 1

FOR THE SURFACE NT APPLIES A GLOSS DEGREE TOLERANCE OF +/- 5 GE MEASURED AT 60°. THE TOLERANCES INFORMATION SHEET (VERSION 2017-1-16) FROM THE ÖFHF (WWW.OEFHF.AT) SHALL APPLY WITH REGARD TO COLOR TOLERANCE

*DECOR AUTN: ARTIFICIAL WEATHERING EN ISO 4892-2: 1500H; ASSESSMENT ACCORDING GREYSCALE EN 20105-A02: 2
 *DECOR INDIVIDUALDECOR: ARTIFICIAL WEATHERING EN ISO 4892-2: 3000H; ASSESSMENT ACCORDING GREYSCALE EN 20105-A02: 3

ALL THE RESPECTIVE CURRENT CERTIFICATES AND APPROVALS ARE AVAILABLE IN THE DOWNLOAD SECTION AT WWW.FUNDERMAX.AT. PLEASE OBSERVE ALL VALID BUILDING REGULATIONS. WE WILL ASSUME NO RESPONSIBILITY IN THIS REGARD. PLEASE CHECK WHETHER YOUR CONSTRUCTION PROJECT MEETS THE REQUIREMENTS FOR THE EFFECTIVE RESTRICTION OF FIRE PROPAGATION (E.G. AT: OIB RL 2, DE SAMPLE MANAGEMENT REGULATIONS FOR TECHNICAL BUILDING REGULATIONS MVV TB,...). THIS BROCHURE IS INTENDED FOR PROFESSIONALS WHO ARE FAMILIAR WITH THE RELEVANT STANDARDS, TECHNICAL REGULATIONS, LEGAL REQUIREMENTS AND RELEVANT GUIDELINES FOR BUILDING PRODUCTS. THESE GUIDELINES HAVE BEEN PREPARED WITH GREAT CARE, BUT WE WOULD LIKE TO POINT OUT THAT THE RESPONSIBILITY FOR THE CORRECT PLANNING ALWAYS LIES WITH THE PLANNER AND THE RESPONSIBILITY FOR CORRECT INSTALLATION ALWAYS LIES WITH THE INSTALLER.

**EXCEPTION IS PODIO-BALCONY FLOOR PANEL; EUROCLASS B-s2,d0 FOR 6 - 20 MM

Resource and Environmentally Friendly Facade Panels

We are specialists in the processing of renewable raw materials – and have been for over 100 years. Our production cycles are closed, production waste is either recycled back into the production process or used to generate energy in our green energy district heating plants. This works so well, that today as a private company we provide district heating to over 8,500 households.



QUALITY MANAGEMENT SYSTEMS

FunderMax has oriented its production facilities and processes on internationally recognized standards such as ISO 9001, ISO 14001, ISO 5001 and ISO 45001. This fact gives all customers the assurance that they have in their hands a high-quality construction product. And in its procurement of raw materials and intermediate products, FunderMax orients itself on up-to-date standards such as FSC® and PEFC*.

SUSTAINABLE PRODUCTION

Max Compact Exterior is made from natural fibre panels – around 65%, by weight – consisting largely of wood that has been processed into “kraft papers”. This wood is a by-product of sawn lumber production or of sawmills. We source these raw materials from vendors certified according to the standards FSC® or PEFC. These standards ensure that the wood is produced in compliance with internationally applicable rules for sustainable forestry.

The kraft papers are impregnated with synthetic resins in impregnation facilities, dried, and pressed into durable, moisture-resistant panels under high pressure and heat. These panels do not contain organic halogen (or chlorine, fluorine, bromine, etc.) compounds such as are found in greenhouse gases or PVC. They contain neither asbestos nor wood protection agents (fungicides, pesticides, etc.) and are free of sulphur, mercury and cadmium.

The exhaust air removed from the drying process is treated using a process of regenerative thermal oxidation, with the resulting heat being fed back into said drying process. For its installation of this efficient exhaust air treatment, FunderMax was awarded the “Klima:aktiv” award for best practices by the Austrian Energy Agency and the Austrian Federal Ministry of the Environment. This avoids CO₂ emissions of ca. 10,000 tons annually at the production site.

*PLEASE FIND FURTHER INFORMATION AT WWW.FUNDERMAX.AT.



WASTE DISPOSAL

Chips and shavings produced by processing (cutting and milling) are not hazardous to human health. This also means that waste can even be disposed of thermally without the emission of environmental toxins such as hydrochloric acid, organic chlorine compounds or dioxins, assuming modern heating systems. At appropriately high temperatures, and assuming both sufficiently long retention of the combustion gas in the combustion space and a sufficient oxygen supply, Max Compact Exterior decomposes into carbon dioxide, nitrogen, water and ash. The energy emitted via this process can be put to use. Disposal in properly managed commercial waste disposal sites is unproblematic. As a matter of principle, country-specific laws and regulations with regard to disposal must be adhered to.

Cleaning order for Max Compact Exterior

FIRST CLEANING STEP

Clean the surface just with pure hot water and use a soft sponge – (DO NOT use the abrasive „green“ side of the sponge), use a soft cloth or a soft brush (e.g. nylon brush).

SECOND CLEANING STEP

If stains cannot be removed common household cleaners without abrasives e.g. dish detergent (Palmolive, Fairy), window cleaner (Ajax, Frosch) may be used. Subsequently do the final cleaning.

THIRD CLEANING STEP

If the contamination is not removable, you can use a solution of soft soap - water (1:3). Depending on the degree of pollution leave it on the surface for a couple of minutes. Subsequently do the final cleaning.

FOURTH CLEANING STEP

Same as cleaning step 1, but additionally you may use organic solvents (e.g. acetone, alcohol, turpentine, thinner). For persistent stains, try to clean mechanically Caution: Avoid scratching, use plastic or wooden spatula. Subsequently do the final cleaning.

FIFTH CLEANING STEP

(for adhesives, varnish, sealants, silicone residues) Rub off the surface with a soft cloth or a soft sponge dry. If contaminants cannot be removed, use silicone remover (for example from Molto) or ask the adhesive manufacturer for the ideal cleaning agents.

Caution: Cured 2K adhesives, coatings, foams and ealing means **cannot** be removed.

SIXTH CLEANING STEP

Same as cleaning step 1, but additionally liquid cleaner with polishing chalk (Cif, ATA) may be used. Do this procedure only occasionally! For persistent limescale acidic cleaning agents may be used (for example, 10% acetic acid or citric acid). Subsequently do the final cleaning.

FINAL CLEANING

Remove all traces of detergent to avoid streaking. Finally, wash with pure water. Wipe the surface dry with an absorbent cloth or paper towel.

When cleaning with solvent: Observe the accident prevention regulations! Open windows! No open flame!



Fig. 2

Guidelines for handling Max Compact Exterior panels

TRANSPORT AND HANDLING

Handle Max Compact Exterior panels with care in order not to damage the edges and surfaces of the high-quality material. In spite of the excellent surface hardness and the installation protection film, the stack weight of Max Compact Exterior panels is a possible cause of damage. Therefore, any form of dirt or dust between the panels must definitely be avoided.

Max Compact Exterior panels must be secured against slippage during transport. When loading or unloading, the panels must be lifted. Do not push or pull them over the edge (see Fig. 3)

Transport protection films must always be removed from both sides at the same time.

Maybe there is a stronger adhesion of the foils on the surface because of the storage. Therefore there might be a higher effort to remove the foil. That does not have any effect to the quality of the product and does not result into a complaint. The transport protection film must not be exposed to heat or direct sunshine.

MOUNTING

During the handling and installation of the Max Compact Exterior panels you have to use your individual protection equipment – especially gloves and helmet – adapted to the working process. Please always use clean gloves with a non-abrasive, non-slip coating to prevent soiling or damaging of the panel surface.

STORAGE AND AIR CONDITIONING

Max Compact Exterior should always be left in the original packaging. The panels should be stacked horizontally on a flat, stable and padded raised surface. If this is not possible, the panels can be temporarily stored as shown in Fig. 5. The panels must lie completely flat. After removing the panels, the original packaging should be closed again.

Cover plates must always be left on the stack (see Fig. 4). The top cover should be weighted down. The same applies, in principle, for cut-panel stacks.

Incorrect storage can lead to permanent deformation of the panels.

Max Compact Exterior panels should to be stored in closed rooms under normal climatic conditions, temperature about 15°C - 25°C and relative humidity at about 40% - 60%. Climate differences on the two surfaces of a panel are to be avoided.

With pre-installed fastening elements, therefore, care is to be taken that the climatic effect is uniform on all sides. Use intermediate layers of wood or plastic (see Fig. 6).

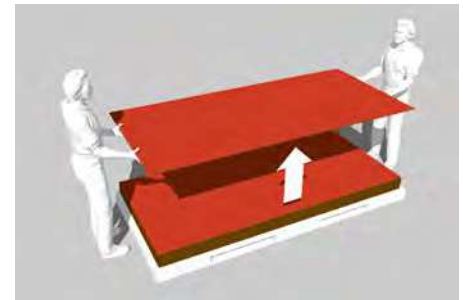

Fig. 3



Fig. 4

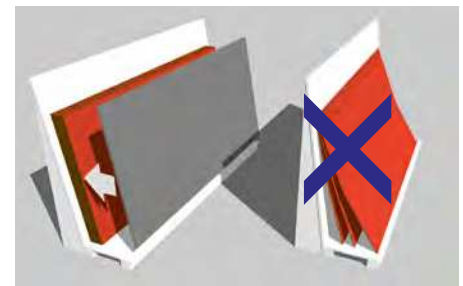

Fig. 5

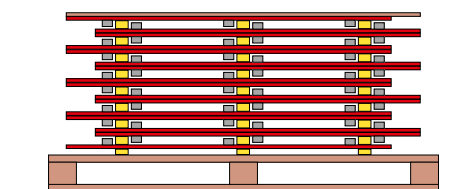

Fig. 6

Hint for final cleaning

Please ensure that foreign substances (e.g. drilling and machine oils, greases, adhesive residues, etc.) that soil the surface of the Max Compact Exterior panels during storage, installation and use are removed immediately without leaving any residue.

We recommend using non-greasy sunscreens (e.g. Physioderm Physio UV 50 Spray), as soiling with conventional sunscreens is often impossible to remove completely even when cleaned immediately.

No responsibility will be accepted for any complaints regarding color, gloss and surface of the panels should these recommendations fail to be observed.

For details on how to properly clean Max Compact Exterior panels, see page 10.



Fig. 7

The processing of Max Compact Exterior panels

General

The surface area of Max Compact Exterior panels is highly resistant. The processing properties of the Max Compact Exterior panels are similar to those for the processing of hard-wood. Hard metal cutting tools have been tested and are indispensable when working with Max Compact Exterior panels. If a long tool life is required, diamond-tipped (DP) tools should be used. Sharp blades and smooth functioning are both necessary elements to ensure a faultless processing of the material. Breaking-off, splintering and chipping of the decorative side is a result of incorrect handling or unsuitable tools. Machine tables should be as flat and smooth as possible, so that no chips collect – which can damage the surface area. The same also applies for work surfaces and the controlling of hand-held machines.



Fig. 8

Safety measures

This is simply a list of the recommended personal protective equipment. The standard required protective equipment for the given field of work should be used (work clothes, safety boots, hairnets,...).

| EN 388 | | Mechanical risks | |
|---|-------|------------------|-------|
| The higher the digit, the better the test result. | | | |
| Test resistance | Digit | Test resistance | Digit |
| Abrasion | 0 - 4 | Abrasion | 0 - 4 |
| Blade cut | 0 - 5 | Blade cut | 0 - 5 |
| Tear | 0 - 4 | Tear | 0 - 4 |
| Puncture | 0 - 4 | Puncture | 0 - 4 |

GLOVES

Non-bevelled cut edges are sharp and pose a risk of injury. To protect against the handling of freshly cut Max Compact Exterior panels, gloves of protection category II with a minimum cut resistance of 2 should be used.



DUST PROTECTION

As with the manufacturing of any other wood, the processing of Max Compact Exterior panels can create dust. For sufficient respiratory protection, dust mask filters for e.g. should work.



PROTECTIVE GOGGLES

As with the manufacturing of any other wood, tightly sealed eye protectors must be worn when working with Max Compact Exterior panels.



HEARING PROTECTION

During the mechanical treatment of Max Compact Exterior panels the sound level can rise to above 80dBA. Please ensure that you have adequate ear protection at all times when working with these materials.



General processing guidelines

When working with Max Compact Exterior panels the ratio between the number of teeth (z), the cutting speed (v_C) and the feed rate (v_f) must be observed.

| | v_C m/s | f_z mm |
|-------|--------------|-------------|
| Saw | 40 – 60 | 0.02 – 0.1 |
| Mill | 30 – 50 | 0.3 – 0.5 |
| Drill | 0.5 – 2.0 | 0.1 – 0.6 |

Table 2

CALCULATION OF CUTTING SPEED

$$v_C = D \cdot \pi \cdot n / 60$$

v_C – cutting speed

D – tool diameter [m]

n – tool rotational speed [min⁻¹]

CALCULATION OF FEED SPEED

$$v_f = f_z \cdot n \cdot z / 1000$$

v_f – feed rate [m/min]

f_z – tooth feed

n – tool rotational speed [min⁻¹]

z – number of teeth

CUTTING MATERIAL

Tools with hard blades (e.g. HW-Leitz) can be used. In order to extend tool life, the use of DP-tipped tools (DP polycrystalline diamond) is recommended.

GENERAL ADVICE

If chip removal is not carried out regularly, this can quickly lead to damage of the blade. As a result the required engine power is increased and the tool life will be shortened. If the shavings are too small they will then scrape and eventually blunt the tool, therefore leading to a short tool life.

For single cuts, it is imperative that the vibration of the panels is prevented using used panels. Stack height is in compliance with machine capacity.

Tooth forms



Fig. 9

TR/TR (Trapezoid tooth/Trapezoid tooth)

Preferred tooth forms for the cutting of hard abrasive laminates.



Fig. 10

FZ/TR (Flat tooth/Trapezoid tooth)

Tooth form for the processing of laminates and Max Compact Exterior panels.



Fig. 12

HZ/DZ (Pendulum tooth/Concave tooth)

Tooth forms for excellent and below on machines without scoring units.



Fig. 11

WZ/FA (variable tooth with bevel)

An alternative to FZ/TR tooth.



Fig. 13

HZ/FA (Concave tooth with bevel)

Similar use to HZ/DZ only with longer machine life without scoring units.

Cutting

Vertical panel splitting, table and sliding table saws without scoring unit

For circular saw blades with a positive rake angle and saw shaft under the work piece. Due to the positive rake angle, the cutting pressure takes effect using the stable table support.

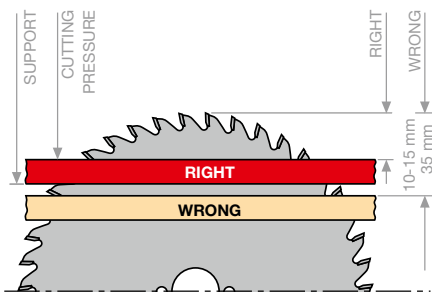

Fig. 14

For circular saw blades with a negative rake angle and saw shaft above the work piece. Through the negative rake angle, the cutting pressure takes effect using the stable table support.

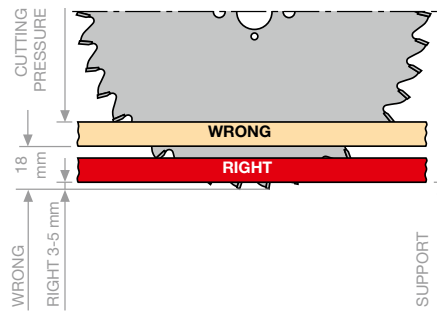

Fig. 15

ADJUSTMENT

- Visible side upwards;
- very narrow saw guide;
- smooth alignment of the Max Compact Exterior panels on the workbench with the saw blade;
- correct blade protrusion.

Depending on the blade protrusion, the entrance and exit angles and therefore the quality of the cutting edges will change. If the upper cutting edges are unclear, the saw blade will need to be adjusted to a higher level. The saw blade must be adjusted to a lower level for an unclear cut of the underside. This is how the best height adjustment is determined.

Sliding table saws and panel splitting machines with scoring unit and pressure beams.

SCORING CIRCULAR SAW BLADE

In order to achieve a good cutting edge quality on the saw exit side, the use of a scoring unit is recommended. The cutting width of the scoring circular saw blade is slightly bigger than that of the main circular saw blade so that the exiting teeth of the main saw no longer touch the cutting edge. As a secure and smooth circulation of the work pieces can only be guaranteed using a pressure device, divided scoring circular saw blades are used on the table and sliding table machines.

Panel splitting unit with scoring aggregate and pressure device.

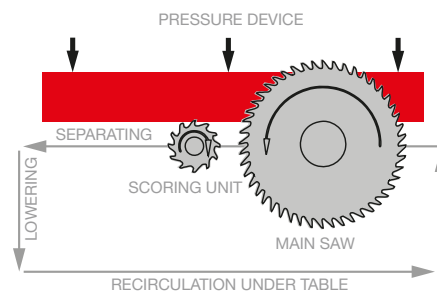

Fig. 16

Operating diagram of the conical scoring circular saw. For the maintenance of tools (always step-by-step), the cutting widths must be aligned with one another.

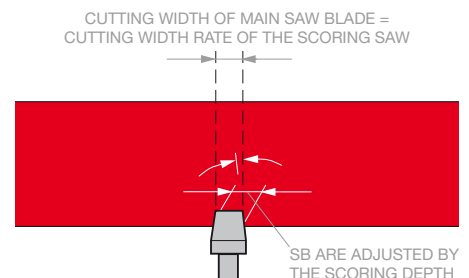

Fig. 17

Cutting with handheld tools

Finely toothed handheld saws are suitable for single cuts. Low set teeth are preferable. The sawing should be done from the panel surface area, where the saw is at an angle of approximately 30° relative to the surface area.

For straight cuts with handheld circular saws, a stop bar or guide rail should be used. Saw blades suitable for hard metal use should be used. The sawing takes place from the panel underside using the following tooth forms: Variable tooth for coarse cuttings, flat tooth/trapezoid tooth for clean cuts of Max Compact Exterior panels and panels which are bonded on both sides.

Milling machines – edge processing

EDGE PROCESSING BY HAND

For the finishing of edges, files are suitable. The file direction moves from the decorative side to the core. For broken edges, fine files, plane files, sand paper (100-150 grain) or scrapers can successfully be used.

EDGE PROCESSING WITH HANDHELD MACHINES

To mill bevels electric hand planes with bevel or bevel grooves can be used. Hand routers are used along with hard metal tools for special tasks (e.g. wash basin recess, Trax-coupling etc.). In order to protect the Max Compact Exterior panel surface areas, the supporting surface of the hand routers should be covered with for e.g. panel parts, no felt! Milling shavings should be carefully removed.

Milling cutter diameter 10-25 mm
Cutting speed v_c 1 30-50 m/sec.

We recommend hard metal tipped milling cutters, which are also available with indexable inserts. For a better functioning of your tools, height-adjustable milling cutters are preferable. The sharp edges will be broken down afterwards.



Drilling

Solid hard metal twist or dowel drills are used for drilling. In machining centres, the use of the main spindle instead of the drilling beams for a rpm of 2000 – 4000 min⁻¹ and a feed rate of 1.5 – 3 m/min, is recommended. The exit speed of the drill must be carefully selected so that the melamine surfaces of the Max Compact Exterior panels are not damaged. Shortly before the drill exits the work piece in full diameter, the feed rate must be reduced by 50%. When drilling through-holes, the counter-pressure should be built up using hardwood or equivalent material to prevent break-offs of the melamine surface.



Fig. 18

For the screwing of blind holes perpendicular to the panel levels, please ensure:

- Tap drill diameter (D) = screw diameter minus approx. 1 screw channel depth.
- Drilling depth (a) = Panel thickness minus 1-1.5 mm
- Screw-in depth = Drilling depth minus 1 mm

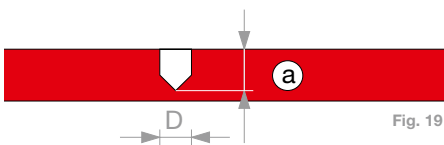

Fig. 19

For screw fittings parallel to the panel level, please ensure:

- The residual thickness (b) of the Max Compact Exterior panels must be at least 3 mm.
- The hole diameter of the drillings parallel to the panel surface must be selected in such a way to avoid any splitting of the compact panels when tightening the screws.
- For screw fittings parallel to the panel surface, metal sheet and chip board screws are suitable.
- In order to ensure respective stability, a minimum depth of engagement of 25 mm is necessary.



Fig. 20

For the drilling of Max Compact Exterior panels, drills for plastics are best suited. This means twist drills with a point angle of $\leq 90^\circ$. They have a large gradient and chip space. The sharp drill bits mean that these drills are also very suitable for the drilling of through-holes as they cut cleanly through the underside of the material.

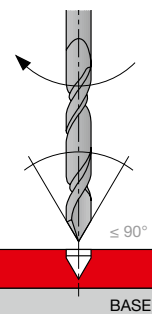

Fig. 21



LEITZ-DRILL SHAFT 10 mm

Fig. 22



LEITZ-DRILL HW-SOLID, Z2

Fig. 23



MBE VHM FACADE DRILL

Fig. 24

UNIVERSAL DRILLING OF BLIND AND THROUGH-HOLES.

The following machines are used:

Point-to-Point drilling machines, through feed drilling machines, CNC machining centres, box column drill, inlet-fitting drilling machine, drilling units, hand drills.

Information on the drills:

Flat roof drill bits. Shaft diameter identical to blade diameter. Adaptable for shaft-D 10 mm with reducing bush TB 110-0 or PM 320-0-25.

DRILLING OF BLIND HOLES

In particular dowel holes in cabinetry. Particularly suitable for the tear-free drilling of blind holes in visible quality as well as the processing of panel materials. Not suitable for through-holes!

The following machines are used:

Point-to-Point drilling machines, through feed drilling machines, inlet fitting drilling machines, drilling units, CNC machining centres.

Information on the drill:

Roughing geometry with extremely clean cut. Model HW-solid with highly wear-resistant HW varieties. High stability and long service life. Polished chip space for minimal friction and feed force.

Pre-punching ensures better control for hand drilling. **Diamond-tipped drills are not suitable for Max Compact Exterior panels.**

MBE VHM FACADE DRILL

MBE-ARTICLE NO.: 1360702 – 8 mm
 MBE-ARTICLE NO.: 1360703 – 8.5 mm
 MBE-ARTICLE NO.: 1360704 – 10 mm

HELP FOR CENTRING DRILL

Helps at primary drilling in the substructure
 SFS Article No.: 1320658



HELP FOR CENTRING DRILL

Fig. 25

Cutting and Milling of Compact Panels - Recommendations for Processing Problems

FIXING PANELS ON A MACHINE TABLE

There are basically two ways to fix or tension Max Compact Exterior panels on machine tables depending on the type of processing to be performed:

a.) Fixing by means of suction cups

When milling to size or edging both sides of a panel section, it is recommended to fix the panel in place using suction cups at specific points.

NOTICE: The proper distance between the suction cups must be observed!

b.) Fixing by means of MDF protective boards

When milling to size, edging one side, making perforations or free-form milling a panel section, it is recommended to fix the panel in place using MDF protective boards (protective boards can be used several times).

The following applies for both options: It must be ensured that the suction cups provide sufficient holding power for the work to be performed. If the suction cups do not provide sufficient fixing or tensioning power, the suction cup seals (e.g. the sealing rings) must be checked.

SPACING OF THE SUCTION CUPS

As a rule, the material being processed should not be subjected to any vibrations. Therefore, it is important that the suction cups are placed at an appropriate distance from the freely protruding panel edge based on the thickness of the panel.

The following applies: the more suction cups and the smaller the distance from the free protruding edge of the panel, the cleaner the milling pattern. As a rule of thumb, suction cups should be placed in the area to be processed in a

grid of max. 300 mm with a maximum distance from the free protruding edge of the panel of no more than 30 mm. The best results are achieved by using an MDF protective board (e.g. 19 mm thick), as this enables a full-surface fixing of the Max Compact Exterior panel on the machine table with suction cups.

CHOICE OF MACHINING TOOL

Generally speaking, Max Compact Exterior panels can be machined with solid carbide (VHM) and diamond (PCD) milling tools. The basic prerequisites for a clean milling pattern and a long service life are vibration-free tool holders and spindles. NOTE: The ball bearings must be properly maintained!

Diamond tools have proven particularly suitable for processing a large amount of panels or a high number of running meters. Smooth-running milling cutters with a shank diameter of min. 10 mm in combination with straight continuous DIA cutting edges (2+1 knife) are especially suitable for format milling.

It is essential that the feed rate and the cutting speed be adjusted for the specific job and cutter based on the material being processed. We recommend always consulting the tool supplier first.

CLAMPING SYSTEM OF THE MILLING TOOL

It is essential that the spindle be centered in the chuck to ensure the smooth running of the milling cutter. The more centered and play-free the milling cutter can be clamped in place, the better the result. Most machines are equipped with common tool holders such as collets, hydro grips or shrink chucks.

For the professional CNC machining of larger jobs, a Hydro Grip tool holder or shrink chuck is recommended as they guarantee the best tool clamping. It is important to ensure the proper main-

tenance of all moving parts such as plain or ball bearings in order to avoid vibrations in every direction!

EXTRACTION

The extraction or the extraction power must be adjusted accordingly for the material being processed to ensure that all the shavings are optimally removed.

If the extraction is not strong enough, there is a risk of heat development. This is due to shavings that remain between the cutter and the panel edge. High friction occurs at this point because the cutter can not eject the material any further. This can lead to burn marks on the panel edge.

CNC MACHINING BY FUNDERMAX

FunderMax has their own machining center - Compact Elements. We are happy to machine Max Compact Interior, Max Compact Exterior, Max HPL and m.look panels to your specifications. Simply contact our customer service center for more information.

Compact Elements

FunderMax also offers trimming and processing services on its modern CNC-controlled equipment. We would be happy to receive your request.



Fig. 26



- 22 Qualifications
- 23 Function and advantages of a nonbearing, rear-ventilated facade
- 24 Material Characteristics
- 25 Mounting of Max Compact Exterior panels with rivets on an aluminium-substructure
- 35 Secret glued fastening with gluing systems
- 41 Concealed Mechanical Fastening Brackets with Panel Anchors
- 45 Important information on rear-ventilated facades supported by wooden substructures.
- 47 Error avoidance in wooden substructures
- 49 Standards for Building with Wood
- 50 Design possibilities with Max Compact Exterior panels
- 51 Mounting of Max Compact Exterior panels with screws on a wooden substructure

NOTE

PLEASE CHECK ADDITIONAL AT WWW.FUNDERMAX.AT FOR THE LATEST VERSION OF THIS BROCHURE.

THE DIAGRAMS IN THIS TECHNICAL INFORMATION ARE SCHEMATICAL REPRESENTATIONS AND ARE NOT TRUE TO SCALE. THIS ISSUE REPLACES ALL OTHER ISSUES OF EXTERIOR TECHNIQUES BROCHURES OF FUNDERMAX WHICH WERE PUBLISHED BEFORE.



Qualifications

FunderMax GmbH
A-2355 Wiener Neudorf

Z-10.3-712



A

Max Compact Exterior panels in thicknesses of 6-13 mm are EUROCLASS B – s2, d0 in accordance with EN 13501-1 and meet the requirements of ÖNORM B3800-5 in thicknesses of 8-13 mm.

CH

Max Compact Exterior panels in thicknesses of 6-13 mm are EUROCLASS B-s2, d0 in accordance with EN 13501-1.

D

Max Compact Exterior panels in thicknesses of 6-10 mm are B-s2,d0 in accordance with EN 13501-1 and have the General Building Construction Supervision Permit of the „Institut für Bautechnik“, Berlin. Permit Number: Z-10.3-712

F

Max Compact Exterior panels in thicknesses 2-10 mm are M1 in accordance with NFP 92501. The Avis technique for wooden substructures and metal substructures can be found on page 7.

Actual and more extensive documentation to all test methods and permits according Max Compact Exterior panels you will find at our website:
www.fundermax.at/en/downloads/



Function and advantages of a nonbearing, rear-ventilated facade

INSULATION

The non-bearing, rear-ventilated facade (VHF) system can be designed for different energy requirements with an individually calculated insulation. Insulation material of any desired thickness can be used. This means insulation values can easily be achieved that are typical of low-energy houses and comply with the current energy savings regulations. Based on the energy needs, the insulation maximizes the heat retention of the building. High summer temperatures in the interior of the building are regulated. By reducing the amount of energy needed for heating, the non-bearing facade minimizes the carbon dioxide emissions of the heating system.

PROTECTION AGAINST CONDENSATION WATER

The construction of the non-bearing, rear-ventilated facade (VHF) decreases the vapor diffusion resistance from the interior to the exterior of the building: Moisture from the construction or use of the building is removed through the rear-ventilation space. Thus the lasting function of the insulation can be ensured and makes a significant contribution to a pleasant and healthy indoor climate.

PROTECTION AGAINST RAIN

The VHF meets the standards for stress group III according to DIN 4108-3 and is driving-rain proof. The rear-ventilation space between insulation and panel (weather protection) quickly dissipates moisture.

PROTECTION AGAINST NOISE

Depending on the thickness of the insulation layer, measurements of the panels and the proportion of open joints, noise protection can be increased by up to 14 dB.

ECOLOGY

Minimization of CO₂ emissions. Environmental objectives are fulfilled both for new buildings, as well as for renovation of existing buildings, through the use of rear-ventilated facades: The measurable reduction in energy required for heating minimizes the carbon dioxide emissions, one of the greatest causes of environmental pollution. State and regional subsidy programs are still available for energy-saving facade renovations.

ECONOMY

The economic aspects can also be found again in the requirements of sustainable construction: Long service life, long maintenance intervals and the subsequent return of the components to their resource cycle are the essential points.

COST CERTAINTY

The cost estimation for a non-bearing, rear-ventilated facade, even in the case of renovations, is basically an exact cost planning.

ADVANTAGES OF THE NON-BEARING, REAR-VENTILATED FACADE

- Exact cost estimation of the facade
- Installation under any weather conditions
- Savings through the shorter scaffolding times
- No disposal costs during the installation phase
- Long maintenance intervals and low follow-up costs
- Long-term value retention and appreciation of the building

BASICS OF CONSTRUCTION

During construction and installation, care is to be taken that the material is not exposed to standing water. This means that the panels must always be able to dry out. Connections of Max Compact Exterior panels to one another always have to be made in the same panel direction. Max Compact Exterior can show deviations from being flat (see EN 438-6, 5.3), and this is to be compensated for by the subconstruction being executed so that it is stable and flat. All connections to other components or to the background must be executed firmly. Elastic intermediate spacers to the subconstruction elements and also between subconstruction elements which permit a greater tolerance than ± 0.5 mm must definitely be avoided. Please also see the Tolerances Information Sheet (version 2017-1-16) from the ÖFHF.

Please observe always all valid building regulations.

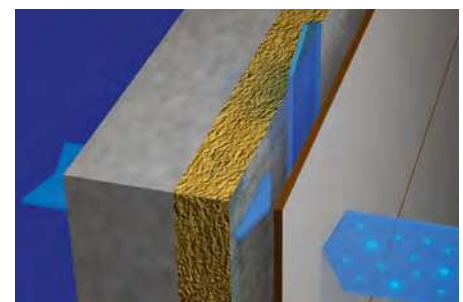

DIFFUSION PERMEABLE

Fig. 27

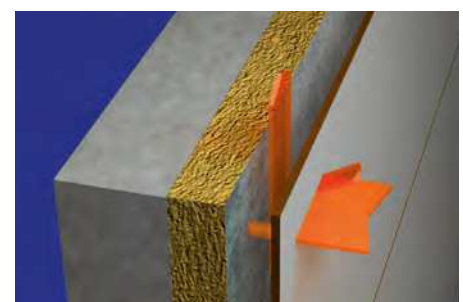

HEAT INSULATING

Fig. 28

Material Characteristics

Max Compact Exterior shrinks when it loses moisture! Max Compact Exterior expands when it absorbs moisture! When working and constructing with the panels, thought must be given to this possible dimensional change.

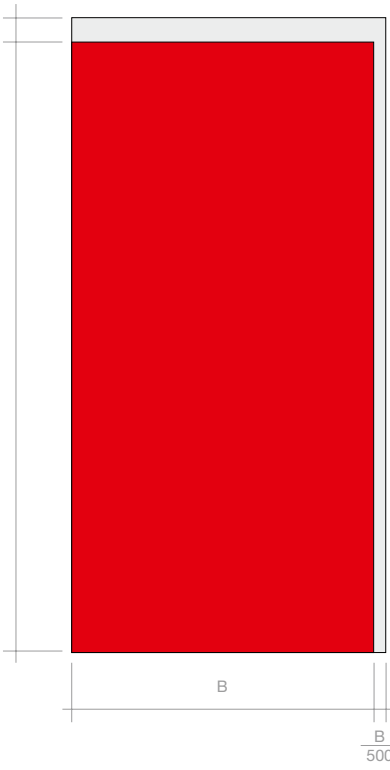

FOR MAX COMPACT EXTERIOR IT IS BASICALLY HALF AS MUCH LENGTHWAYS AS WIDTHWAYS (SEE PROPERTIES ON PAGE 7; LENGTHWAYS IS RELATIVE TO THE NOMINAL PANEL FORMAT!)

ELEMENT LENGTH = A
ELEMENT WIDTH = B

$\frac{A \text{ OR } B \text{ (IN mm)}}{500} = \text{EXPANSION CLEARANCE}$

Fig. 29



Mounting of Max Compact Exterior panels with rivets on an aluminium-substructure

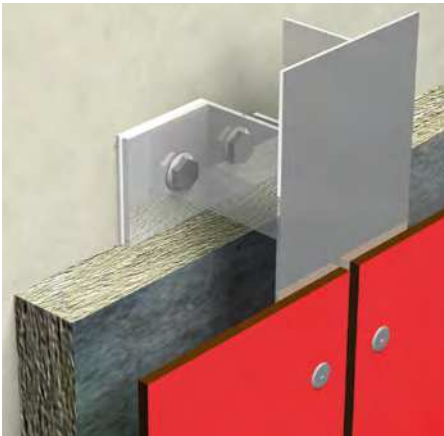

Fig. 30

FASTENINGS

Alu-Blind rivet with big head colour lacquered on aluminium-substructures.
 Rivet sleeve: material-no. EN AW-5019 acc. DIN EN 755-2
 Rivet pin: steel material-no. 1.4541
 Pull-off strength of rivet pin: ≤ 5.6 KN
 Diameter of drill hole in Max Compact Exterior panels: Sliding points: 8.5 mm or as required
 Fixed points: 5.1 mm
 Diameter of drill hole in the aluminium substructure: 5.1 mm

SUPPLIERS OF FASTENING AND SUBSTRUCTURES YOU WILL FIND ON PAGE 90/91 OR AT „WWW.FUNDERMAX.AT“.

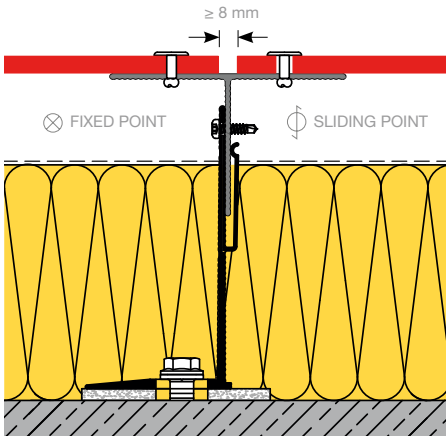

Fig. 31

SUBSTRUCTURE

The aluminum substructure has to observe the requirements of the national standards and has to be installed in accordance with the manufacturer specifications for the substructure. Due to the material properties of Max Compact Exterior panels, fixed points and sliding points need to be made to fix the panels (Fig. 38, p. 29 and Fig. 39, p. 30). Metal subconstructions change their dimensions with differences in temperature. The dimensions of Max Compact Exterior, however, alter under the influence of changing relative humidity. These changes in size of subconstruction and cladding material can be opposite to each other. When installing, attention must be paid to the expansion clearance.

REAR VENTILATION REGULATION

In order to avoid the prolonged formation of condensation in the rear ventilated facade, it is necessary to ensure a constantly functioning ventilation. The free vertical ventilation gap must be at least 200 cm²/m and for aluminum substructures a free minimum cross section of 150 cm²/m is required for inlet and outlet openings (see ÖNORM B8110-2: 2003).

To enable a vertical flow, the support profiles must always be aligned vertically.

JOINT FORMATION

To ensure a tension-free movement of the Max Compact Exterior panels, the joint formation must be at least 8 mm. In Germany, the joint formation is defined in accordance with building inspectorate approval Z-10.3-712 with 8 mm.

FIXED POINTS

Fixed points are used for uniform distribution (halving) of the expansion and shrinkage movements. The diameter of the drill hole in Max Compact Exterior has to be made with 5.1 mm. Instead of the fix point drill you can use also a fix point socket.

MBE ART. NO. 1240201 Ø 8.5 mm
 MBE ART. NO. 1240205 Ø 10 mm
 SFS ART. NO. 1343279 Ø 8.5 mm



Fig. 32

LOOSE POINT

The loose point is in addition to the fixed point able to hold the weight of the panel. And is placed in the same level. Expansion and shrinking are not constrained (Fig. 38, p. 29 and Fig. 39, p. 30).

MBE FIXED-POINT SLEEVE SET PLUS ART.NR. 1240405 INCLUDING
 100 PCS. FIXED-POINT SLEEVE Ø 10MM
 100 PCS. FLOATING-POINT SLEEVE Ø 10 MM, SLOTTED HOLE 5.2 X 7.7 MM
 (DRILL HOLE TOLERANCE: 10.0 - 10.03 MM)



Fig. 33

NOTE

PLEASE NOTE, WHEN USING A FIXED-POINT SLEEVE WITH A DIAMETER OF 10 MM FOR FLOATING-POINT FIXING, THE RIVET HEAD MUST HAVE A DIAMETER OF AT LEAST 16 MM.



SLIDING POINT

The diameter of the drill hole in Max Compact Exterior must be drilled larger than the diameter of the fastening, depending on the required expansion clearance. This is the shaft diameter of the fastening plus 2 mm for every meter of cladding material starting from the fixed point. The head of the fastening must be big enough so that the drill hole in Max Compact Exterior is always covered. The fastening is placed in such a way that the panel can move. Rivets are put in place with flexible mouthpieces. The defined clearance of the rivet head to the surface of the panel (0.3 mm) allows movement of the element in the drill hole (Fig. 35). The centre point of the drill hole in the subconstruction must coincide with the centre point of the drill hole in the Max Compact Exterior panels. Drill with a centring piece. The fastenings should be put in place starting from the middle of panel outwards.

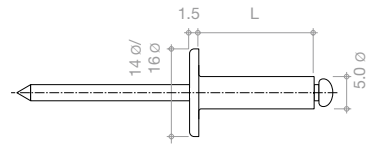

Fig. 34

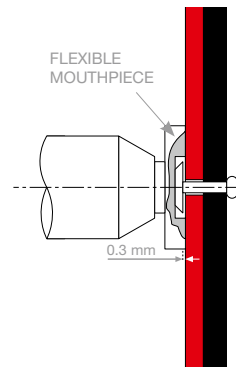
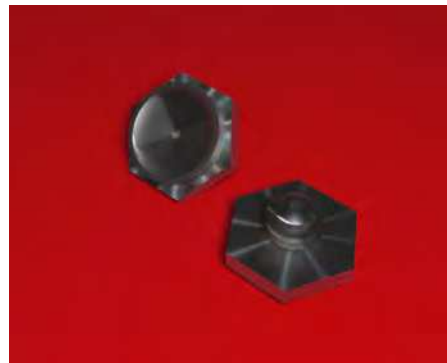

Fig. 35

The rivets must be put in place with a flexible mouthpiece, clearance 0.3 mm.



Fig. 36



FLEXIBLE MOUTHPIECES

Fig. 37

CURVED FORMS

Curved forms are a special challenge for material and installer and require an accurate installation. Max Compact Exterior panels can be formed “cold” with application of force.

Possible bending radius are depending directly on the thickness of panels. The thinner the panel, the minor the radii are possible.

Fastening:

In general the fastening has to be made mechanical. The fastening spacings have to be chosen according to the needs of the structural analysis. The panels have to be born on the curved substructure exactly. An accurate processing is mandatory. The regional building regulations and our brochure Technique Exterior must be observed. To achieve a perfect final result you need a sufficient amount of fastenings!

MINIMUM POSSIBLE BEND RADII WITHOUT WINDLOAD

| PANEL THICKNESSES | RADIUS |
|-------------------|---------|
| 6 mm | 2500 mm |
| 8 mm | 3500 mm |
| 10 mm | 4500 mm |

Table 3



TABLE FOR LOAD ON SINGLE SPAN/WIND LOAD*
MAX COMPACT EXTERIOR PANELS RIVETED ON ALUMINIUM SUBSTRUCTURE

| PANEL THICKNESS | 6 mm | | 8 mm | | 10 mm | | |
|-----------------|----------------|------------|------------|------------|------------|------------|------------|
| | LOAD q (kN/m²) | max b (mm) | max a (mm) | max b (mm) | max a (mm) | max b (mm) | max a (mm) |
| GERMANY | | | | | | | |
| 0.50 | 600 | 600 | 700 | 700 | 800 | 800 | |
| 1.00 | 600 | 431 | 700 | 539 | 800 | 551 | |
| 1.50 | 600 | 311 | 700 | 373 | 800 | 455 | |
| 2.00 | 537 | 261 | 700 | 280 | 800 | 337 | |

Values acc. to DIN 1055-T4 or DIN 18516 and permit Z-10.3-712

AUSTRIA*

| | | | | | | | |
|------|-----|-----|-----|-----|------|-----|--|
| 0.50 | 781 | 662 | 970 | 649 | 1146 | 769 | |
| 1.00 | 657 | 394 | 815 | 463 | 964 | 457 | |
| 1.50 | 594 | 314 | 737 | 354 | 871 | 417 | |
| 2.00 | 537 | 261 | 686 | 286 | 811 | 332 | |

Values acc. to ÖNORM B 4014-1,2 or EN 1991-1-4 and permit Z-10.3-712

SWITZERLAND*

| | | | | | | | |
|------|-----|-----|-----|-----|------|-----|--|
| 0.50 | 781 | 662 | 970 | 649 | 1429 | 470 | |
| 1.00 | 657 | 394 | 815 | 463 | 1201 | 279 | |
| 1.50 | 594 | 314 | 737 | 354 | 1033 | 217 | |
| 2.00 | 537 | 261 | 686 | 286 | 894 | 188 | |

Values acc. to SIA-Standard 261 or Z-10.3-712

FASTENING SPACINGS FOR AUSTRIA AND SWITZERLAND

If the specified axis dimension „b“ is not fully utilized, then the allowable mounting distance „a“ can be calculated as follows (source: Typenstatik Max Exterior Fassadenplatten Dipl.-Ing. Gerald Segeth, Dobel 18. 04. 11):

When installing a 8 mm single span panel with a wind load of 0.5 kN, the following applies: max b = 970 mm and max. a = 649.

If a value of 900 mm is used for „b“ for example, then the maximum allowable „a“ is calculated as follows:

$$\text{allow } a = \frac{\text{max } b}{\text{for given } b} * \text{max } a$$

Example:

$$\text{allow } a = \frac{970 \text{ mm}}{900 \text{ mm}} * 649 \text{ mm} = 699 \text{ mm}$$

Table 4

*AN INTERPOLATION IS POSSIBLE ON BASE OF THIS VALUES.
EXAMPLE: IF YOU DONT USE MAX B IN TOTAL IT APPLIES: PERMITTED A = (MAX B/EXISTING B) * MAX A
NOTE: PERMITTED A < MAX B

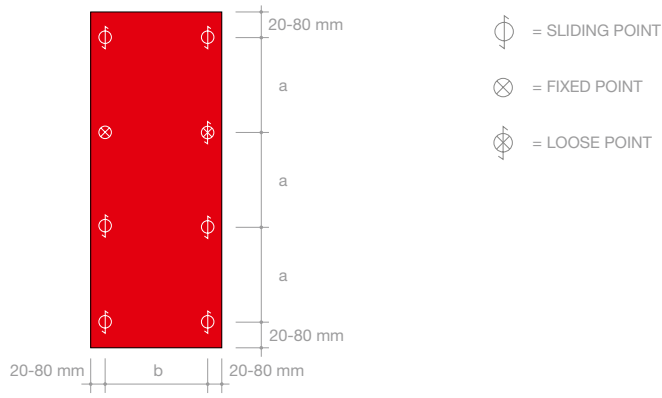

Fig. 38

*THE VALUES IN THE MEASUREMENT TABLES ARE CHARACTERISTIC VALUES.
DIMENSION TABLES FOR THE WIND LOAD RANGE FROM 0.3 KN/M² TO 2.6 KN/M² ARE AVAILABLE UPON REQUEST FROM THE FUNDERMAX SUPPORT TEAM.

TABLE FOR LOAD ON DOUBLE SPAN/WIND LOAD*
MAX COMPACT EXTERIOR PANELS RIVETED ON ALUMINIUM SUBSTRUCTURE

| PANEL THICKNESS LOAD q (kN/m ²) | 6 mm | | 8 mm | | 10 mm | |
|---|---------------|---------------|---------------|---------------|---------------|---------------|
| | max b (mm) | max a (mm) | max b (mm) | max a (mm) | max b (mm) | max a (mm) |
| GERMANY | | | | | | |
| 0.50 | 600 | 600 | 700 | 700 | 800 | 800 |
| 1.00 | 600 | 373 | 700 | 400 | 800 | 420 |
| 1.50 | 600 | 249 | 700 | 320 | 800 | 280 |
| 2.00 | 537 | 208 | 700 | 240 | 800 | 210 |

Values acc. to DIN 1055-T4 or DIN 18516 and permit Z-10.3-712

AUSTRIA*

| | | | | | | |
|------|-----|-----|------|-----|------|-----|
| 0.50 | 974 | 425 | 1209 | 417 | 1429 | 470 |
| 1.00 | 759 | 295 | 1012 | 276 | 1201 | 279 |
| 1.50 | 620 | 241 | 826 | 271 | 1033 | 217 |
| 2.00 | 537 | 208 | 716 | 235 | 894 | 188 |

Values acc. to ÖNORM B 4014-1,2 or EN 1991-1-4 and permit Z-10.3-712

SWITZERLAND*

| | | | | | | |
|------|-----|-----|------|-----|------|-----|
| 0.50 | 974 | 425 | 1209 | 417 | 1429 | 290 |
| 1.00 | 759 | 295 | 1012 | 276 | 1201 | 172 |
| 1.50 | 620 | 241 | 826 | 271 | 1033 | 134 |
| 2.00 | 537 | 208 | 716 | 235 | 894 | 116 |

Values acc. to SIA-Norm 261 or Z-10.3-712

Table 5

*AN INTERPOLATION IS POSSIBLE ON BASE OF THIS VALUES.
EXAMPLE: IF YOU DONT USE MAX B IN TOTAL IT APPLIES: PERMITTED A = (MAX B/EXISTING B) * MAX A
NOTE: PERMITTED A < MAX B

EDGE SPACINGS

For reasons of stability and flatness, the edge spacings must be kept to without fail. The joints must be made at least 8 mm wide so that changes in size can take place without hindrance (Fig. 31, p. 25).

FASTENING SPACINGS

These are to be chosen in accordance with the structural engineering requirements (calculations) or, if this is not necessary due to the local regulations, according to Table 4 or Table 5. In the edge region of the construction, the spacings of the fastenings are to be chosen smaller than in the central region (pressure, suction).

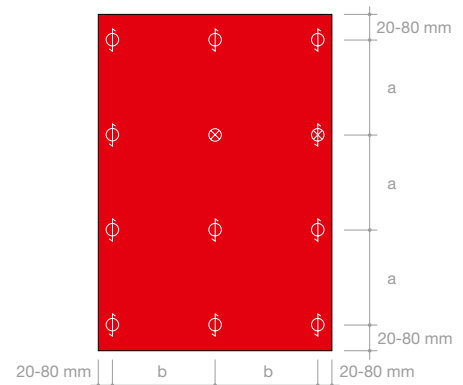

DOUBLE SPAN PANEL

Fig. 39

- ⊖ = SLIDING POINT
- ⊗ = FIXED POINT
- ⊘ = LOOSE POINT

*THE VALUES IN THE MEASUREMENT TABLES ARE CHARACTERISTIC VALUES.
DIMENSION TABLES FOR THE WIND LOAD RANGE FROM 0.3 KN/M² TO 2.6 KN/M² ARE AVAILABLE UPON REQUEST FROM THE FUNDERMAX SUPPORT TEAM.



Construction-details horizontal sections Alu-substructure riveted

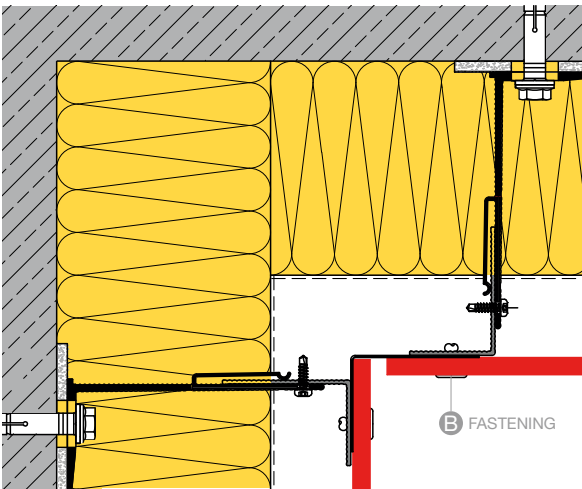

INTERNAL CORNER A106

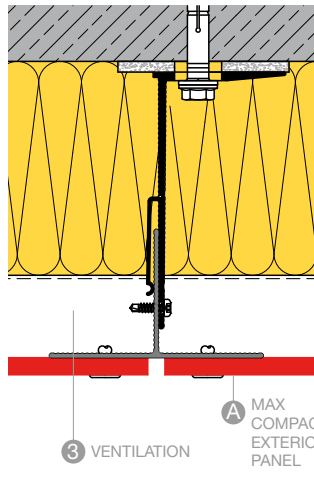

VERTICAL JOINT A107

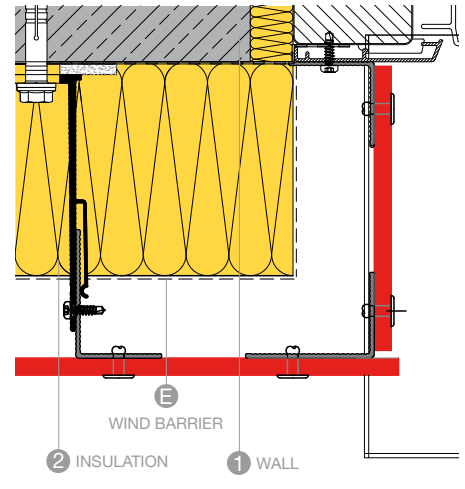

WINDOW REVEAL A104

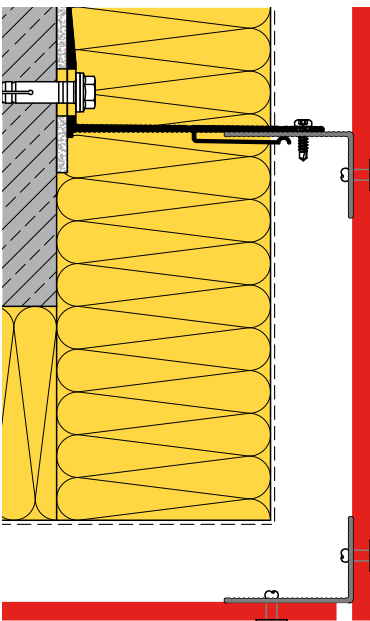

EXTERNAL CORNER A105



NOTE
SUPPLIERS:
SEE PAGES 90/91 AT
THE END OF THE
BROCHURE.

ALL PROFILES AND FASTENINGS ARE SHOWN IN THIS BROCHURE ARE PLANNING-SUGGESTIONS AND NOT PART OF THE FUNDERMAX DELIVERY PROGRAMME!
ALL DRAWINGS IN THIS BROCHURE ARE **NOT** TRUE TO SCALE!

Construction-details vertical sections Alu-substructure riveted

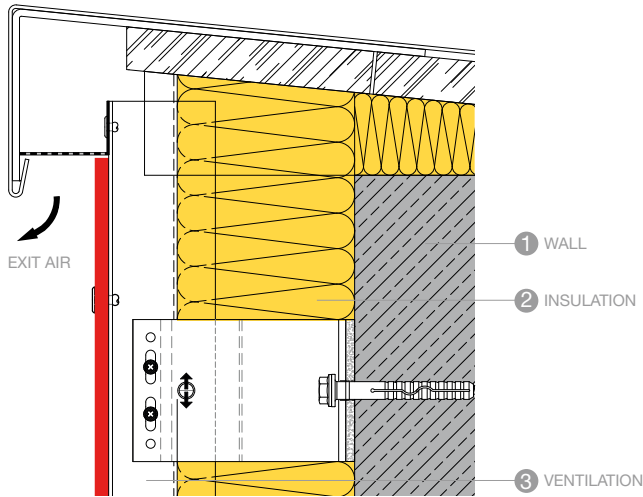

ATTIC CONNECTION A109

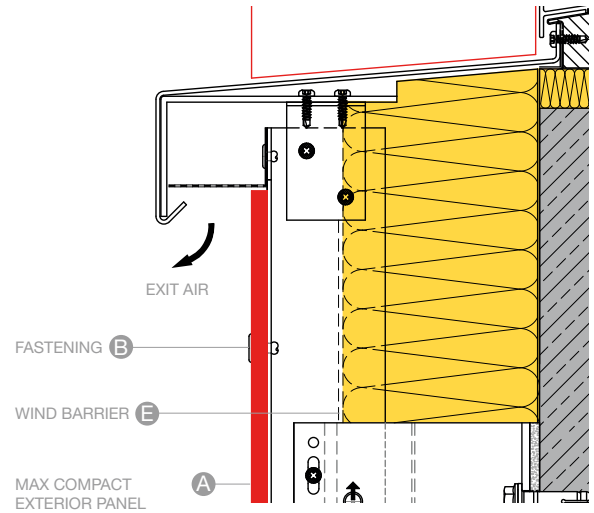

WINDOW SILL CONNECTION A102

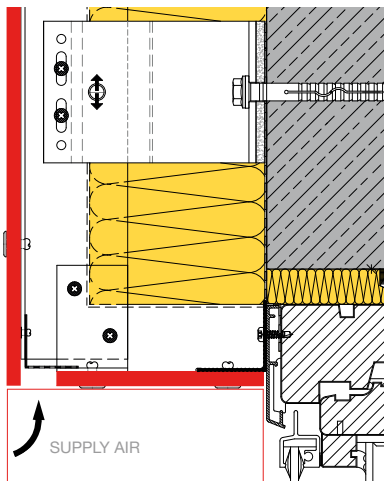

WINDOW LINTEL A101

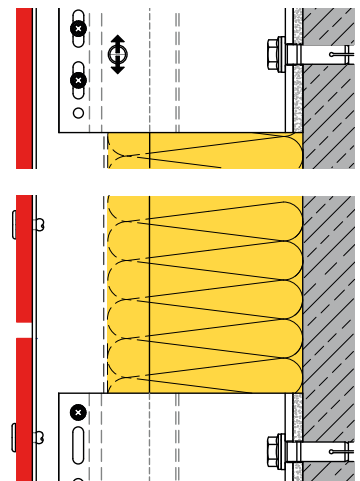

HORIZONTAL JOINT A110

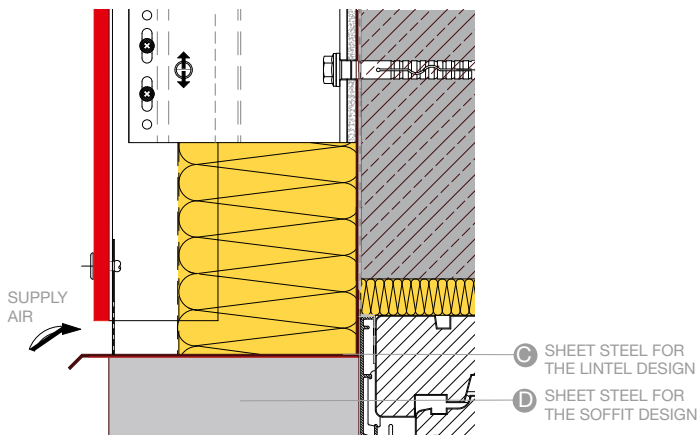

WINDOW LINTEL A101.2*

*THE WINDOW LINTEL A101.2 WAS PROVED ACC. ONORM B3800-5 AND CONFORMS TO THE OIB RL2 GUIDELINES OF BUILDING CLASSIFICATIONS 4 AND 5.

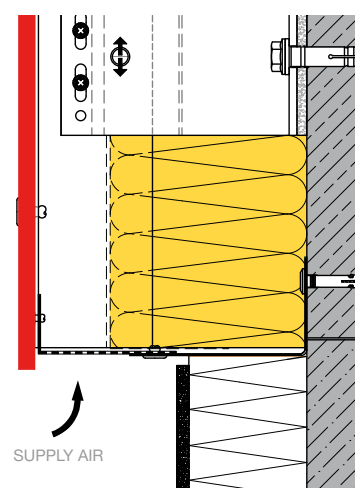

BASE CONNECTION A103

Construction-details horizontal sections Alu-substructure with Z-/Omega-profiles riveted

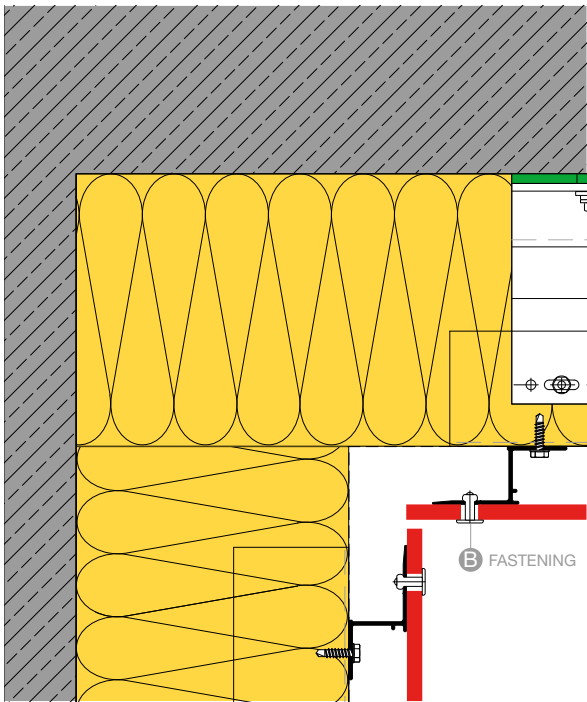

INTERNAL CORNER A106

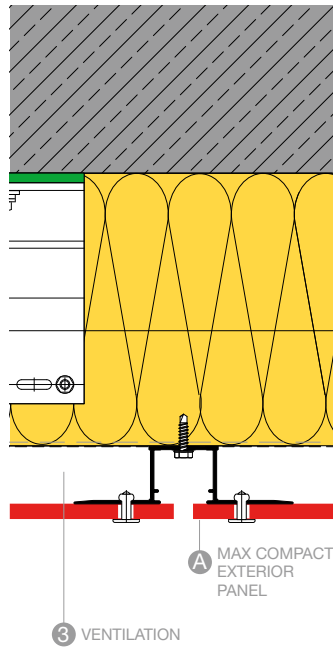

VERTICAL JOINT A107

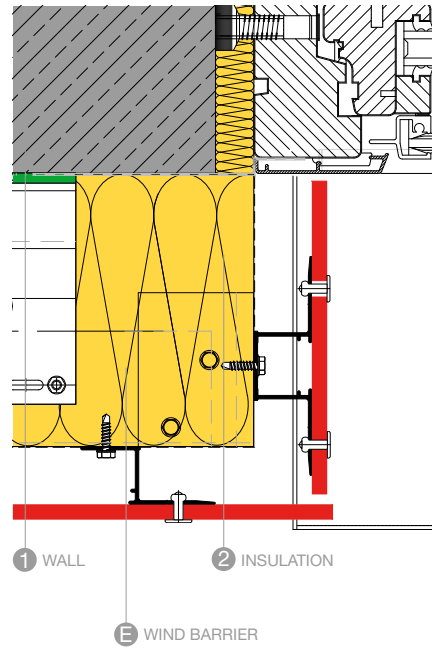

WINDOW REVEAL A104

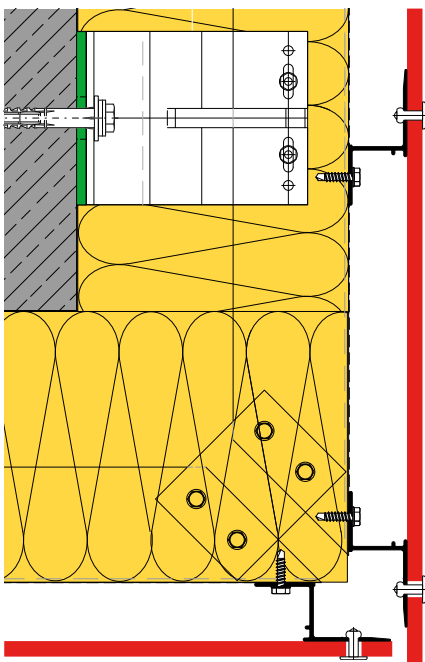

EXTERNAL CORNER A105



NOTE
SUPPLIERS:
SEE PAGES 90/91 AT
THE END OF THE
BROCHURE.

ALL PROFILES AND
FASTENINGS ARE SHOWN
IN THIS BROCHURE ARE
PLANNING-SUGGESTIONS
AND NOT PART OF THE
FUNDERMAX DELIVERY
PROGRAMME!
ALL DRAWINGS IN THIS
BROCHURE ARE NOT
TRUE TO SCALE!

Construction-details vertical sections Alu-substructure with Z-/Omega-profiles riveted

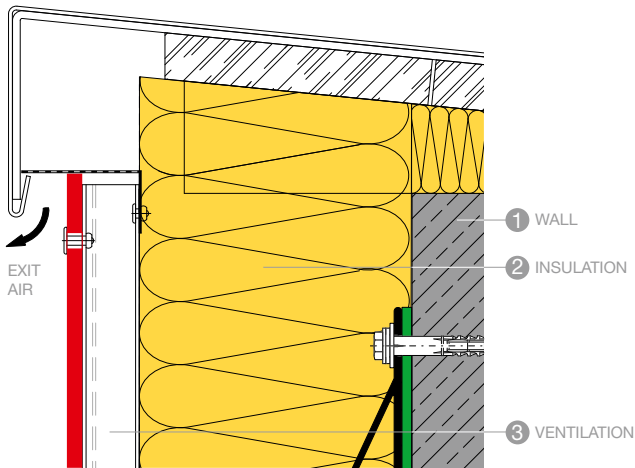

ATTIC CONNECTION A109

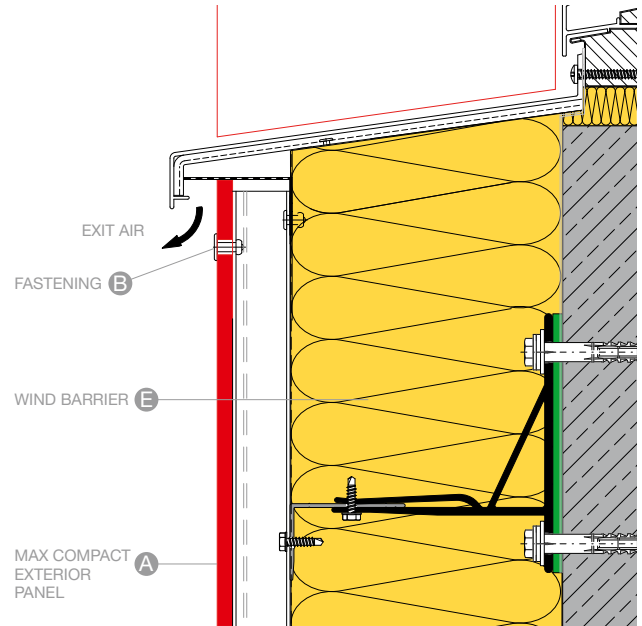

WINDOW SILL CONNECTION A102

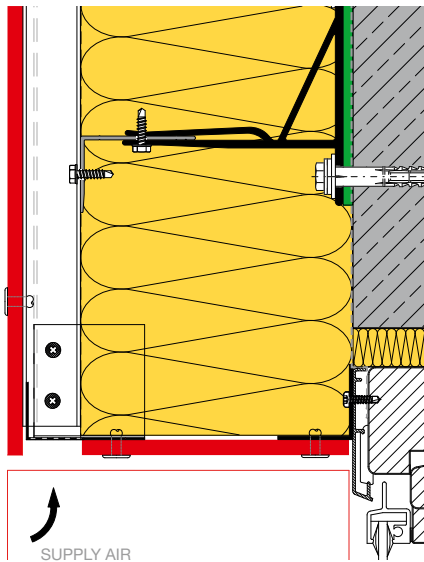

WINDOW LINTEL A101

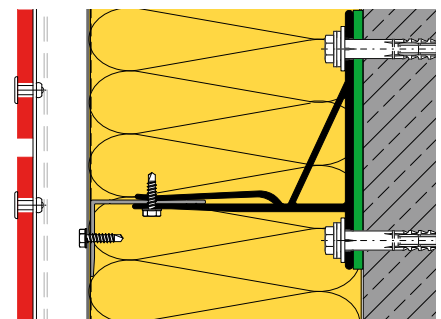

HORIZONTAL JOINT A110

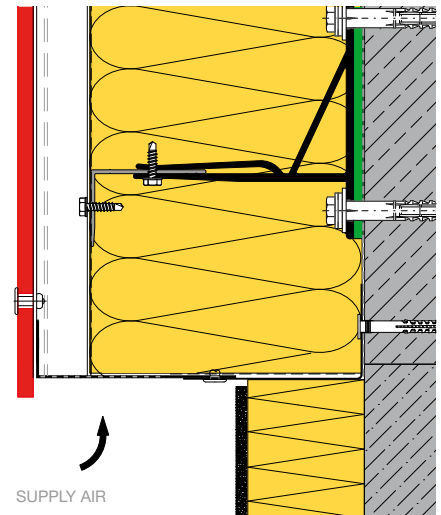

BASE CONNECTION A103

Secret glued fastening with gluing systems

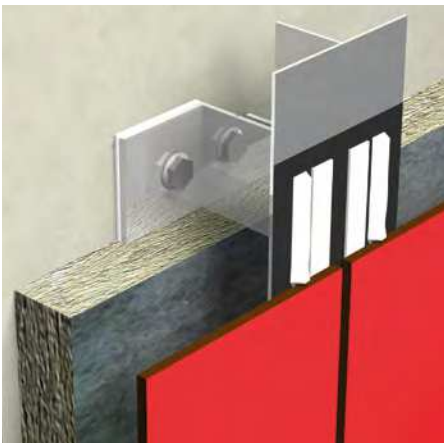

Fig. 40

GLUING

An alternative to secret mechanical fixing with plugs is gluing the Max Compact Exterior facade panels with gluing systems which were specially developed for this. It works on normal planed wood or aluminium subconstructions. Gluing is a clean and simple solution for rear-ventilated facades, attics, visible roof underfaces, reveals and much more. It is important that the responsible building officials of the region or the country give permission. These gluing systems in connection with Max Compact Exterior panels are permitted generally by building authorities in Germany.

- Sika Tack Panel Z-10.8-408
- MBE Panel-loc Gluing-System Z-10.8-350
- PRO PART Klebedicht KD385 Z-10.8-453
- Innotec Project System Z-10.8-483
- Sika Tack Panel-50 ETA-19/0511

CONSTRUCTION

for the required profile width see the permit.

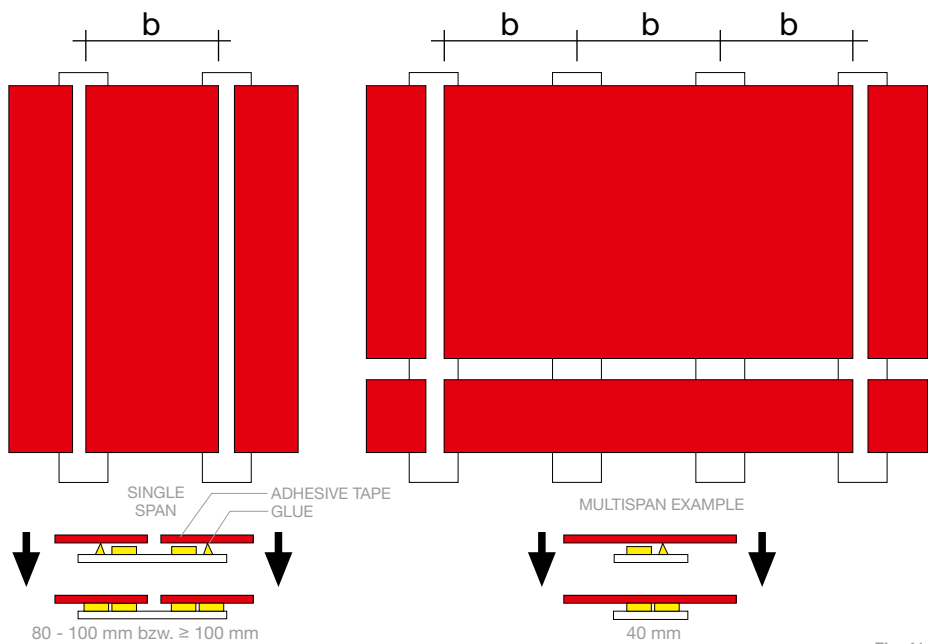

Fig. 41

The local building regulations are to be followed without fail!

| FOR GLUED INSTALLATION WITH SIKA TACK PANEL (SPACING OF THE VERTICAL SUPPORT CONSTRUCTION) | | |
|---|-----------------------------|-----------------------------|
| PANEL THICKNESS | SINGLE SPAN PANEL MAX. b | DOUBLE SPAN PANEL MAX. b |
| 6 mm* | 450 mm | 500 mm |
| 8 - 10 mm | 600 mm | 650 mm |

* PANEL THICKNESS 6 mm IS NOT PERMITTED IN GERMANY!

Table 6

GLUING WITH INNOTEK PROJECT SYSTEM*

| | SINGLE SPAN | | DOUBLE SPAN | |
|-----------------------|-------------------------------------|-------|-------------------------------------|-------|
| | AUSTRIA, GERMANY, SWITZERLAND | max b | AUSTRIA, GERMANY, SWITZERLAND | max b |
| 0.5 kN/m ² | 8 mm | 1048 | 8 mm | 1406 |
| 1.0 kN/m ² | 8 mm | 832 | 8 mm | 1116 |
| 1.5 kN/m ² | 8 mm | 727 | 8 mm | 975 |
| 2.0 kN/m ² | 8 mm | 660 | 8 mm | 738 |

Table 7

Table 8

* IDENTIFIED VALUES ON BASE OF THE INNOTEK PERMISSION. COUNTRY AND GLUE SPECIFIC STATICS CAN BE ORDERED AT THE MANUFACTURERS OF GLUES. THE GLUING OF 6 MM THICK PANELS ARE GENERALLY POSSIBLE BUT NOT PERMITTED IN GERMANY.

Working sequence

BASICS

- It is necessary to keep the work protected from the weather and dust (gluing work can be done on the construction site).
- Air temperature not below 5°C and not over 35°C.
- Relative air humidity not higher than 75%.
- Temperature of the construction elements which are to be glued at least 3°C higher than the dew point temperature of the air.
- Joints in the subconstruction profiles must not be glued if covered with Max Compact Exterior panels.
- The subconstruction must always be arranged vertically.
- The general building authority permit, as well as the manufacturer's working instructions, must be present during the gluing work at every construction site.
- The gluing must only be done by companies with proof of training (for Germany, proof of qualification is necessary in accordance with the building authority permit).
- A construction site log is to be made.

PRE-TREATMENT OF THE ALUMINUM SUBSTRUCTURE

- Sanding with a suitable sanding fleece in accordance with the adhesive manufacturer's recommendation
- Cleaning with a suitable cleaning agent in accordance with the adhesive manufacturer's recommendation¹⁾
- Apply primer in accordance with the adhesive manufacturer's recommendation
- Observe the drying time for the cleaning agent and the primer in accordance with the adhesive manufacturer's instructions

PRE-TREATMENT OF THE MAX COMPACT EXTERIOR PANEL

- Sanding with a suitable sanding fleece in accordance with the adhesive manufacturer's recommendation
- Cleaning with a suitable cleaning agent in accordance with the adhesive manufacturer's recommendation¹⁾
- Apply primer in accordance with the adhesive manufacturer's recommendation
- Observe the drying time for the cleaning agent and the primer in accordance with the adhesive manufacturer's instructions

All surfaces to be glued must be kept clean, dry and free of grease.

GLUING

- Apply installation tape over the entire length of the vertical profiles (do not remove the protective film yet).
- Apply glue: The adhesive is applied as a triangular bead according to the system recommendations of the adhesive manufacturer.
- Panel installation: Remove the protective film of the installation tape. Align the panels accurately (mounting bracket) until they come into contact with the installation tape.

Information must be obtained without fail from the manufacturer of the gluing system.

SUPPLIERS OF FASTENING AND SUBSTRUCTURES YOU WILL FIND ON PAGES 90/91 OR AT „WWW.FUNDERMAX.AT“.

¹⁾SIKA ACTIVATOR 205 ACTIVATES THE MATERIAL SURFACE AND LEAVES A GREY SHEEN. DO NOT APPLY TO THE FRONT SIDE OF THE PANELS. REMOVE ANY SPLASHES IMMEDIATELY.



Construction-details horizontal sections Alu-substructure glued

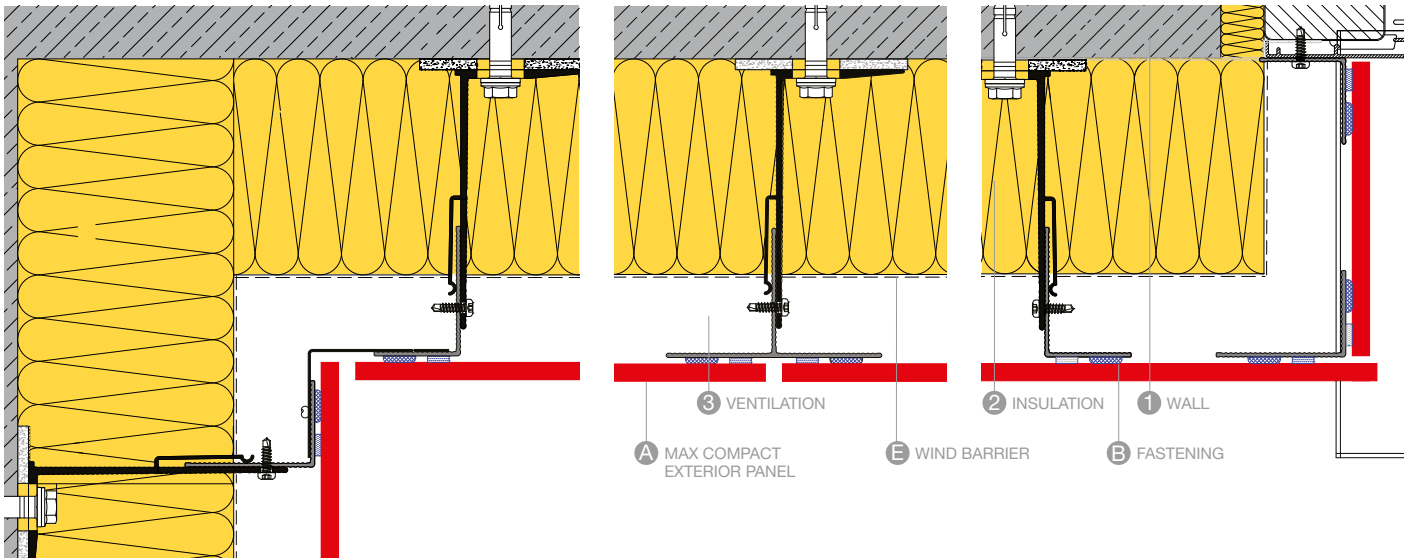

INTERNAL CORNER A106

VERTICAL JOINT A107

WINDOW REVEAL A104

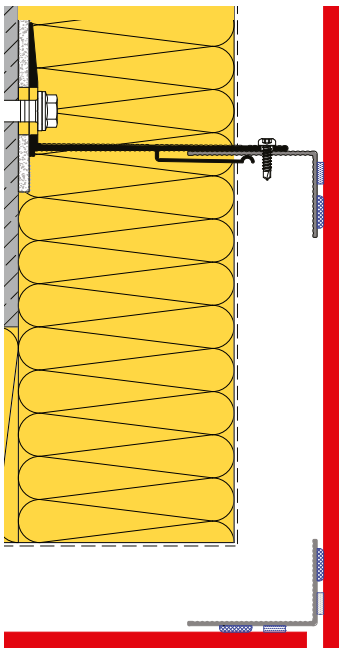

EXTERNAL CORNER A105



NOTE
SUPPLIERS: SEE
PAGES 90/91 AT THE
END OF THE BROCHURE.

ALL PROFILES AND FASTENINGS ARE SHOWN IN THIS BROCHURE ARE PLANNING-
SUGGESTIONS AND NOT PART OF THE FUNDERMAX DELIVERY PROGRAMME!
ALL DRAWINGS IN THIS BROCHURE ARE **NOT** TRUE TO SCALE!

Construction-details vertical sections Alu-substructure glued

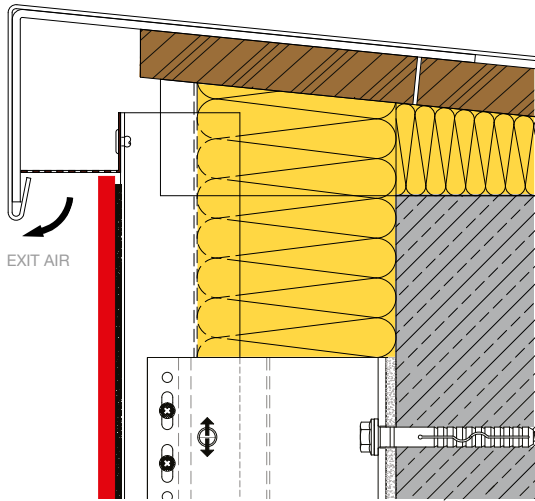

ATTIC CONNECTION A109

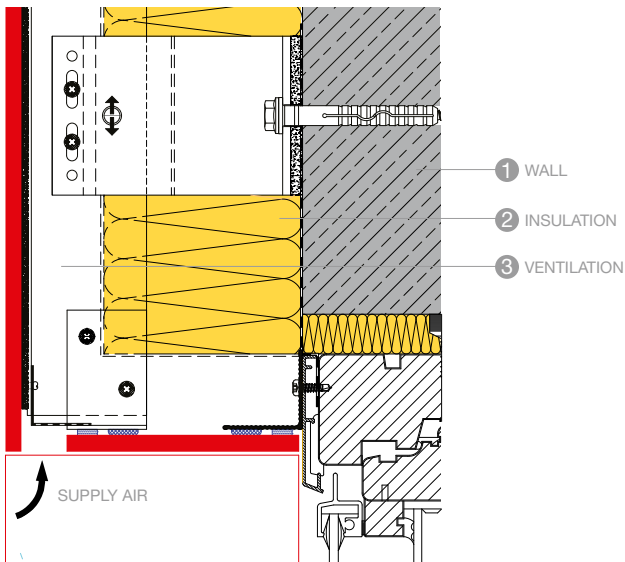

WINDOW LINTEL A101

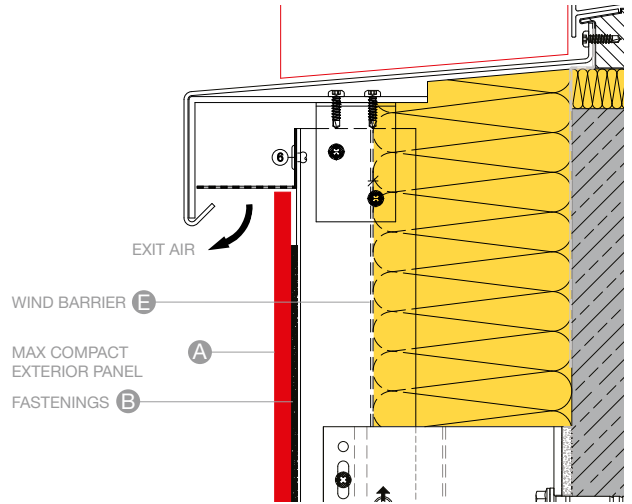

WINDOW SILL CONNECTION A102

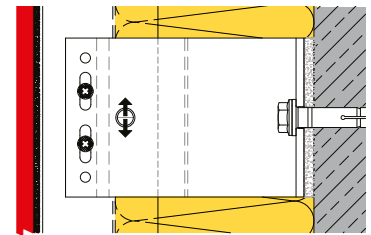

HORIZONTAL JOINT A110

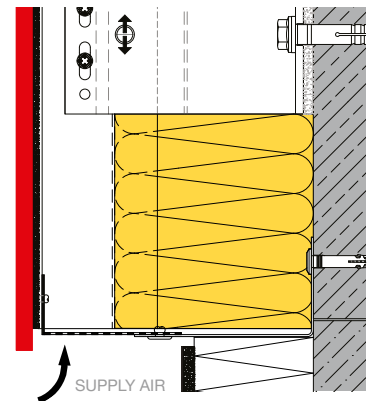

BASE CONNECTION A103

Construction-details horizontal sections Alu-substructure with Z-/Omega-profiles glued

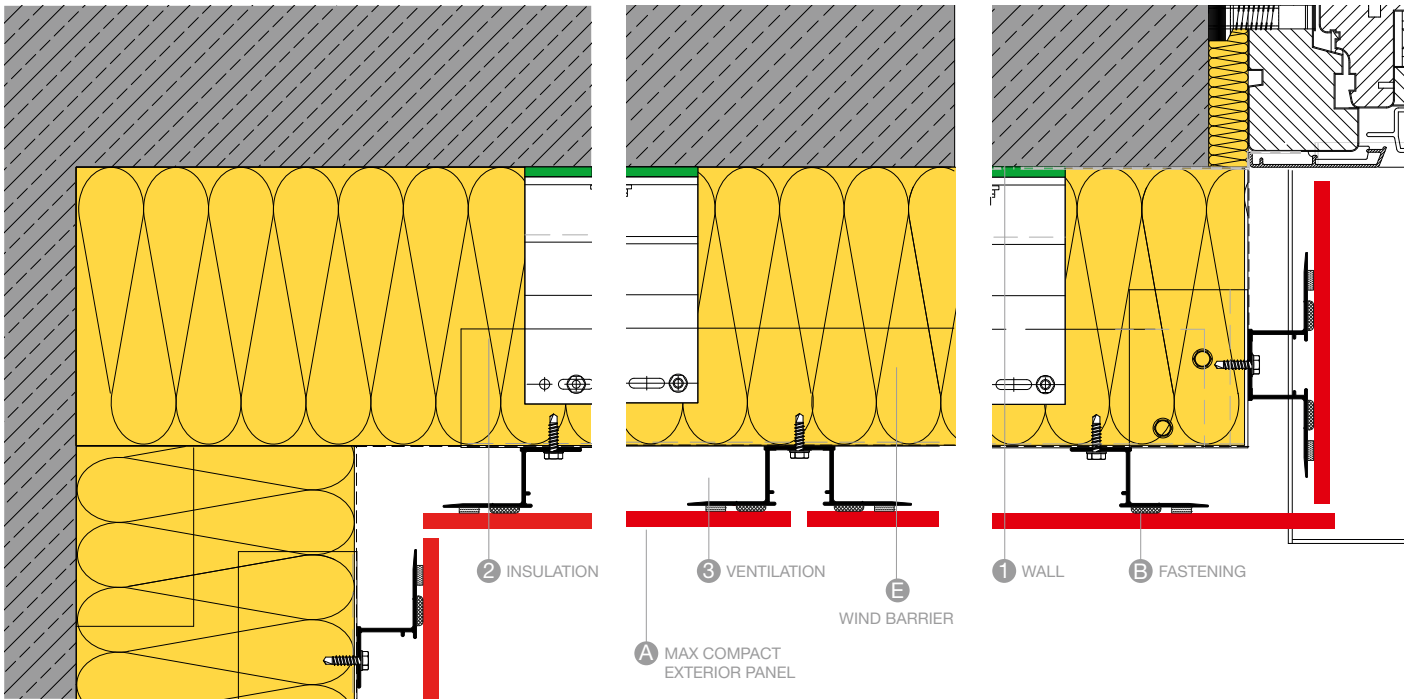

INTERNAL CORNER A106

VERTICAL JOINT A107

WINDOW REVEAL A104

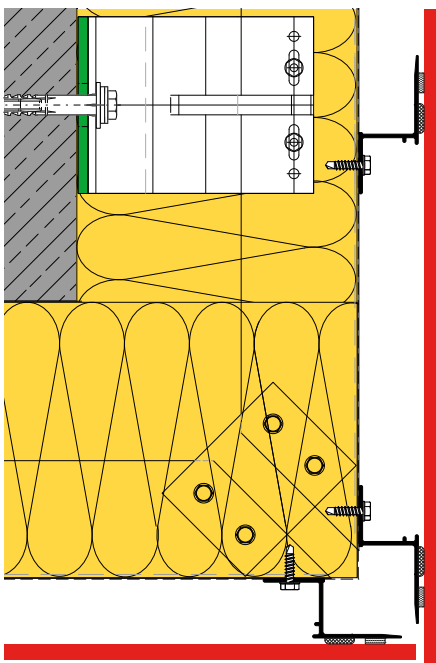

EXTERNAL CORNER A105



NOTE
SUPPLIERS: SEE PAGES 90/91 AT THE END OF THE BROCHURE.

ALL PROFILES AND FASTENINGS ARE SHOWN IN THIS BROCHURE ARE PLANNING-SUGGESTIONS AND NOT PART OF THE FUNDERMAX DELIVERY PROGRAMME! ALL DRAWINGS IN THIS BROCHURE ARE NOT TRUE TO SCALE!

Construction-details vertical sections Alu-substructure with Z-/Omega-profiles glued

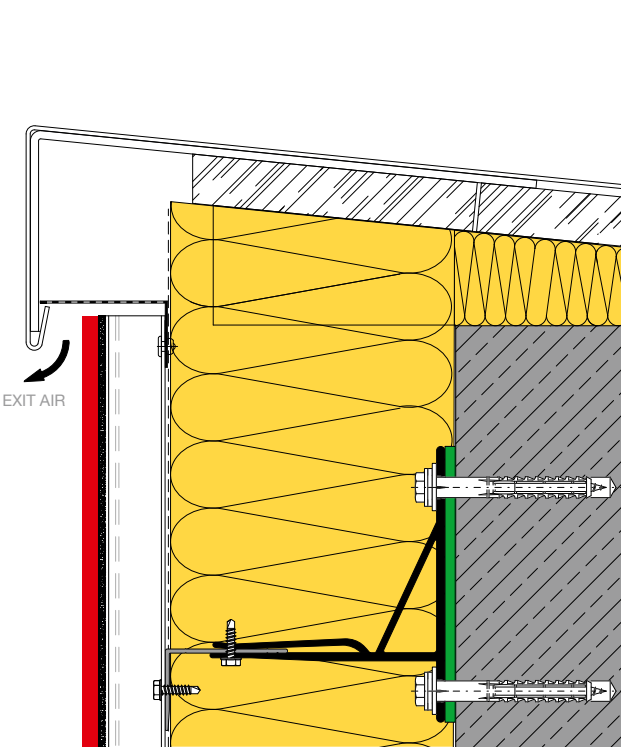

ATTIC CONNECTION A109

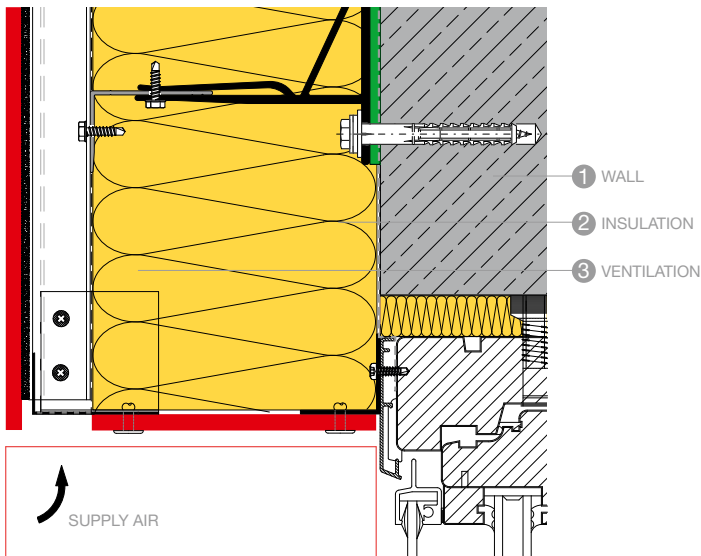

WINDOW LINTE A101

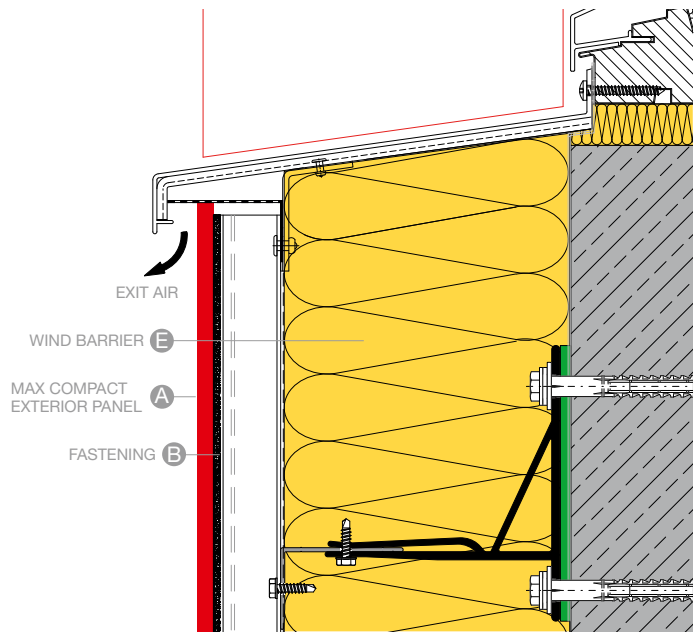

WINDOW SILL CONNECTION A102

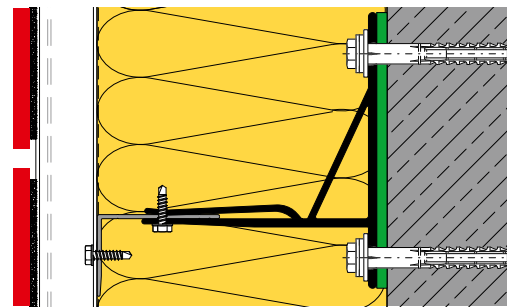

HORIZONTAL JOINT A110

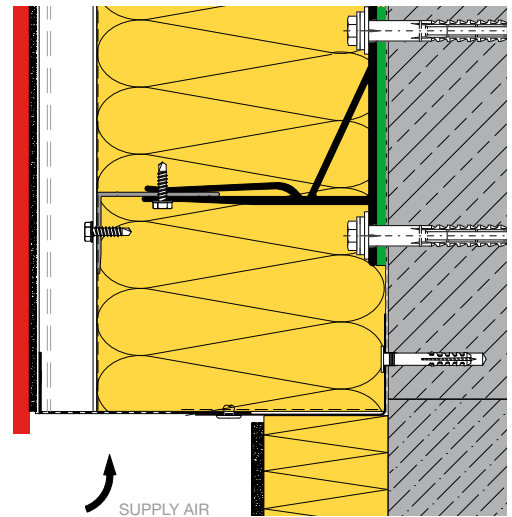

BASE CONNECTION A103

Concealed Mechanical Fastening Brackets with Panel Anchors

Installation of Max Compact Exterior panels using concealed, mechanical fastening brackets on an aluminum sub-construction. The system components (Max Compact Exterior panel, bracket, panel anchor and support profile), are designed for optimum compatibility.



Fig. 42

FASTENING BRACKET

EU:

SFS blind fastener TUF-S
Inspectorate Approval ETA-15/0476

France:

SFS TU-S 50 Avis Technique
(2/16-1749).

For countries in which the fastening means do not require an approval from the building authorities, we recommend using one of the aforementioned approvals. The local building regulations must be observed.



Fig. 43

SYSTEM ADVANTAGES

- Can be used for both horizontal or vertical panel/joint formats
- Only one support profile required for horizontal panel joint
- Experienced system partners
- No visible mounting brackets
- Can be installed under any weather conditions
- Low installation costs
- The fastening means have been approved by the building authorities
- Usable panel thicknesses 8 mm, 10 mm, and 12 mm, taking into account a residual wall thickness of at least 2 mm after deduction of all tolerances.
- Quick installation with standard tools. Drilling with a cordless screwdriver possible on site
- High pull-out values
- Secure against backing out
- Disassembly by hexagon head

SYSTEM DESCRIPTION

The brackets are mounted on the rear side of the Max Compact Exterior facade panels with special blind fasteners into the prepared mounting drill holes. The determination of the number of anchors and the placement of the drill holes must be made in accordance with the relevant approvals.

Please note that the residual wall thickness between the drill hole and the front of the panel must be at least 2 mm after deducting all tolerances.

The panels provided with brackets are hung in the suspension profiles mounted on the substructure, their height is adjusted, and they are secured against lateral movement. The substructure must be designed so that a tension-free fastening of the Max Compact Exterior panels is ensured. Support profile joints of the substructure must not be covered by panels.

After the detailed planning for the facade has been completed (mounting distances according to the building authorities), we or a partner will cut the Max Compact Exterior facade panels to size and provide them with the drill holes. The basis for this is a CAD drawing for each part.

The brackets can be attached quickly and easily at the facade builder's or on the construction site using a commercial riveting machine.

The inspection of the installation work shall be carried out in accordance with the relevant approvals.

NOTICE: FUNDERMAX CAN ALSO PROVIDE PRE-DRILLED PANELS IN COMPLIANCE WITH THE APPROVALS. PLEASE CONTACT US IF YOU ARE INTERESTED IN PRE-DRILLED PANELS.

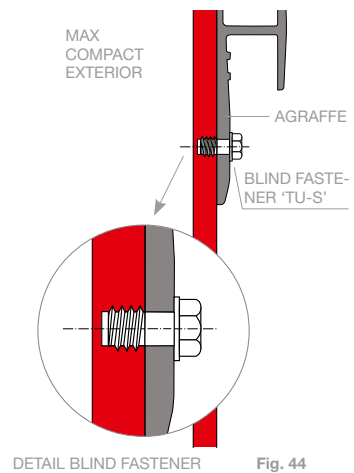
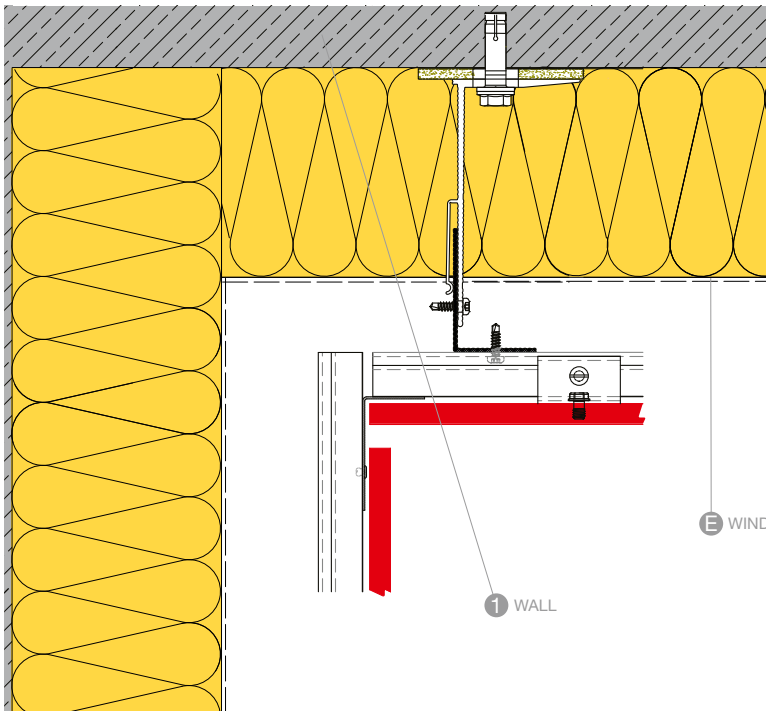
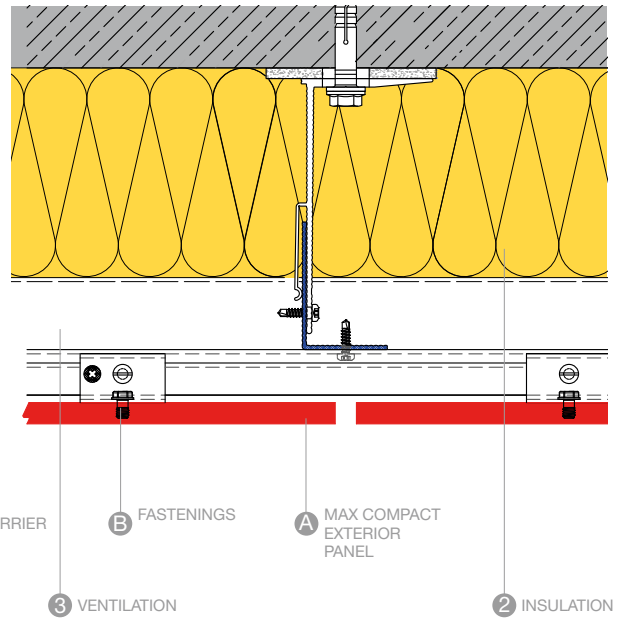

Fig. 44

Construction-details horizontal sections Concealed Mechanical Fastening Brackets with Panel Anchors



INTERNAL CORNER A106



VERTICAL JOINT A107

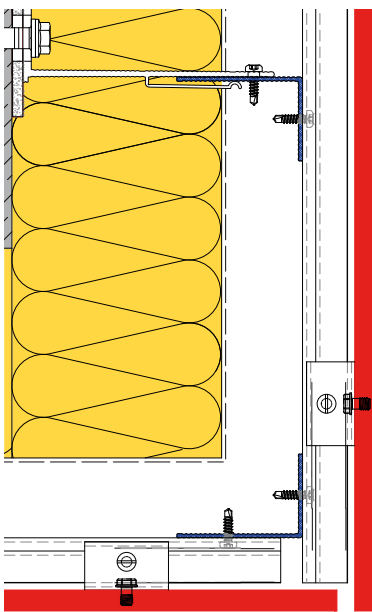

EXTERNAL CORNER A105



NOTE
SUPPLIERS: SEE PAGES
90/91 AT THE END OF
THE BROCHURE.

ALL PROFILES AND FASTENINGS ARE SHOWN IN THIS BROCHURE ARE PLANNING-SUGGESTIONS AND NOT PART OF THE FUNDERMAX DELIVERY PROGRAMME!
ALL DRAWINGS IN THIS BROCHURE ARE NOT TRUE TO SCALE!

Construction-details vertical sections Concealed Mechanical Fastening Brackets with Panel Anchors

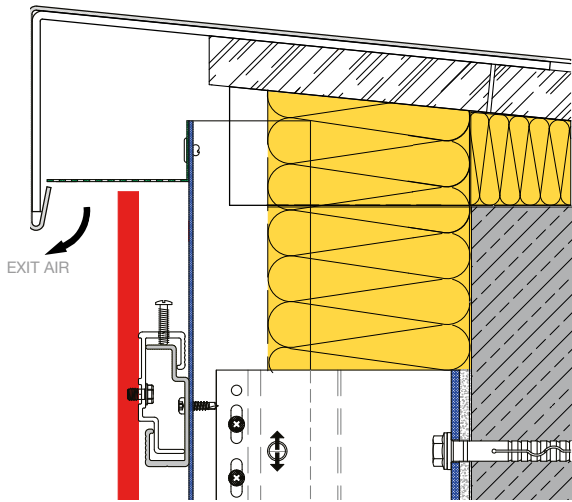

ATTIC CONNECTION A109

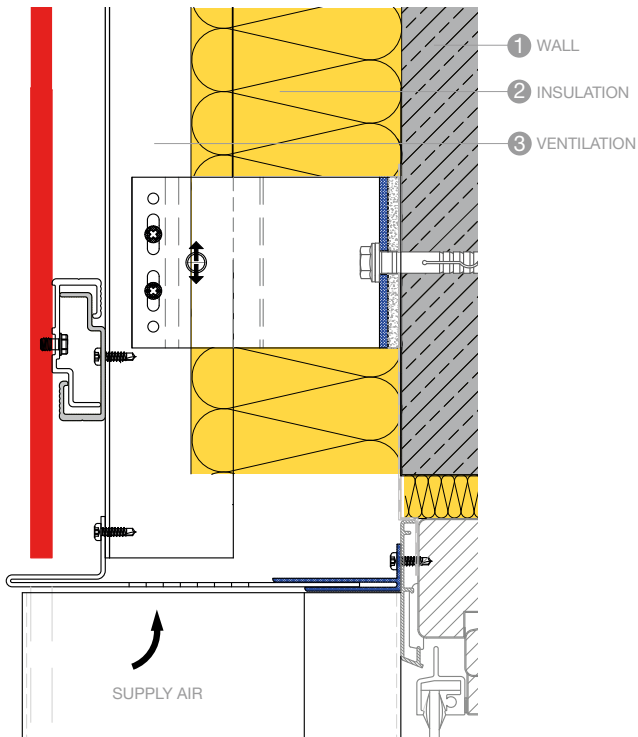

WINDOW LINTEL A101

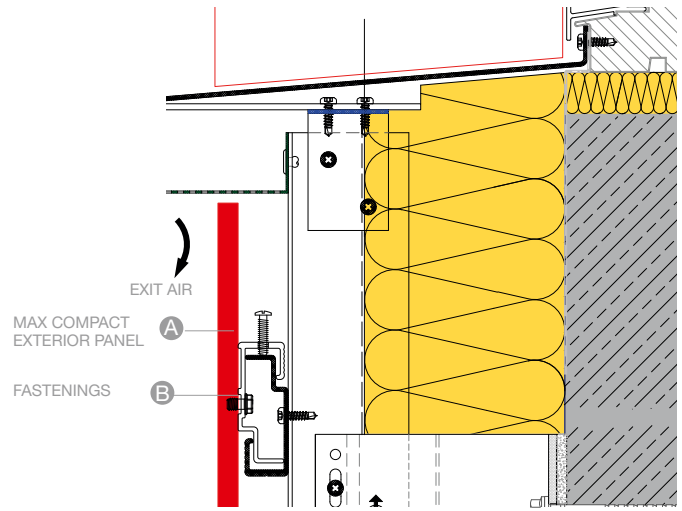

WINDOW SILL CONNECTION A102

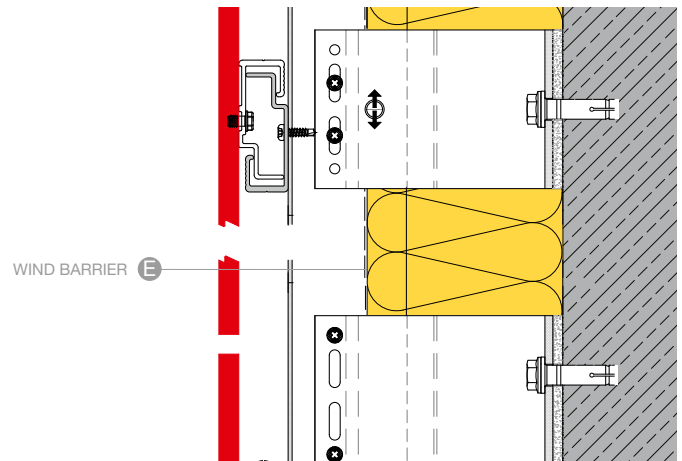

HORIZONTAL JOINT A110

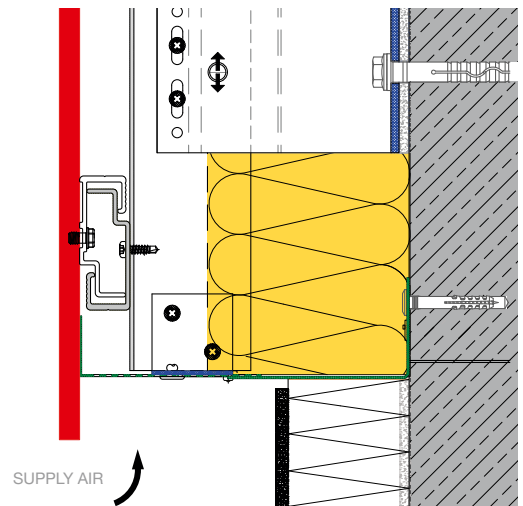

BASE CONNECTION A103

Important information on rear-ventilated facades supported by wooden substructures.

Wooden substructures for facades have been proven solutions for centuries. Their most obvious advantages are low heat conductivity and a low rate of horizontal expansion, as well as the fact that wood is a renewable resource. In order to ensure their longevity, it is imperative that wooden substructures be given effective, reliable protection from moisture. Depending on the conditions at hand, constructional wood protection or additional chemical-based wood protection may be necessary. Only in hazard class 0 (DE) or service class 0 (AT)—that is, in facades that are protected by eaves and feature closed joints—is chemical wood protection unnecessary.

Battens must be planed on all sides, pre-dried (wood moisture of 15% ±3) and made of woods such as spruce, fir, pine or larch, and there must also be a backing strip made of EPDM rubber with a minimum thickness of 1.2 mm in order to prevent the penetration of moisture via screws in the substructure. (See Fig., longitudinal cross-section, p. 53.) It is essential that the penetration of moisture behind the EPDM strip near parapets and window edges be prevented.

Note: According to DIN 1052, predrilling of spruce (in battens) is no longer permissible. If the wood is denser than 500 kg/m³, DIN 1502-12.6(4) requires predrilling to be done with a hole diameter of less than the screw shaft's diameter, adhering to the formulas "0.6 x ø" or "0.8 x ø".

Detailed requirements are specified by those standards and guidelines that apply (see standard list on p. 49). Since wood, as a natural building material, expands and shrinks, it is necessary to conduct regular visual checks of the facade. Screws should be tightened as needed. Assembling a facade made of Max Compact Exterior panels on a wooden substructure must be done with customshaped panels (cut, drilled and, if necessary, chamfered).

CONSTRUCTIONAL WOOD PROTECTION

According to the applicable standards, constructional wood protection measures include precautionary design, construction, working and processing measures to ensure that wood and wooden building materials remain serviceable. Such measures help to avoid both fungal infestation and excessive expansion and shrinkage. They are not, however, capable of preventing infestation with insects. Taking the following points and/or measures into account will have a strong influence on the functionality and longevity of the substructure. In order to provide clear descriptions of how they can be put into practice for the facade, the following section will look at each point individually. Building wooden substructures for facades is subject to the processing guidelines for wooden construction techniques in effect at the site where they are to be installed, and/or to other rules that represent the state of the art. Adherence to such guidelines is the responsibility of those who process the materials.

For this reason, it is particularly important to define "constructional and chemical wood protection" measures as early as the planning phase.

EFFECTIVE MEASURES INCLUDE, MOST IMPORTANTLY, PROTECTION FROM

a) penetration of moisture into the battens

by using EPDM rubber backing strips with a thickness of at least 1.2 mm. Only an EPDM tape with a minimum thickness of 1.2 mm will seal the drill hole completely and prevent moisture from entering the wooden substructure via the fastening screw. Such backing strips must be used on all battens and be at least 20 mm wider than the battens themselves (see Fig. 74, p. 53). This measure helps to avoid the formation of wood-destroying moulds that appear when wood moisture exceeds 20% (DIN EN 335-1, appendix A,2.19).

b) precipitation

(e.g. by roofing, weather-protectant covers for parapets, windowsill joints, etc.). Roof overhangs prevent the facade from constant penetration by moisture whenever it rains. The necessary dimensions for such an overhang are determined by the height of the facade and by how the building is situated.

c) spraying water

(e.g. by maintaining 300 mm distance from the ground) Wooden substructures are very sensitive to constant penetration by moisture. Therefore, it is essential to ensure that the wooden substructure is at least 300 mm above the level of water saturation (in the case of a gravel surface adjacent to the foundation). In cases of smooth ground and frequent, strong rainfall, the area within which water sprays becomes commensurately larger.

d) rising moisture

(e.g. through insulating strips) In buildings affected by rising moisture, insulating strips must be placed between the masonry/concrete and the wooden substructure. This effectively prevents moisture from constantly penetrating the wooden construction elements.

e) condensation

(e.g. with a vapour retarder, rear-ventilation for shuttering, insulation of pipes carrying cold water).

In order to avoid the prolonged formation of condensation in the rear ventilated facade, it is necessary to ensure a con-

stantly functioning ventilation. The free vertical ventilation gap must be at least 200 cm²/m and for aluminum substructures a free minimum cross section of 150 cm²/m is required for inlet and outlet openings (see ÖNORM B8110-2: 2003).

To enable a vertical flow, the support profiles must always be aligned vertically.

ALSO SEE OUR MEASURES FOR AVOIDING ERRORS, DESCRIBED ON PAGES 46 AND 47

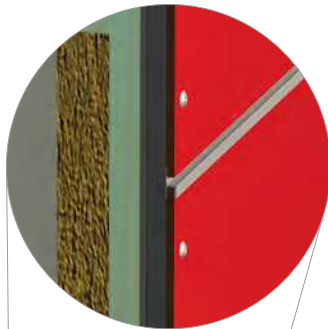

H-PROFILE (E.G. PROTEKTOR)

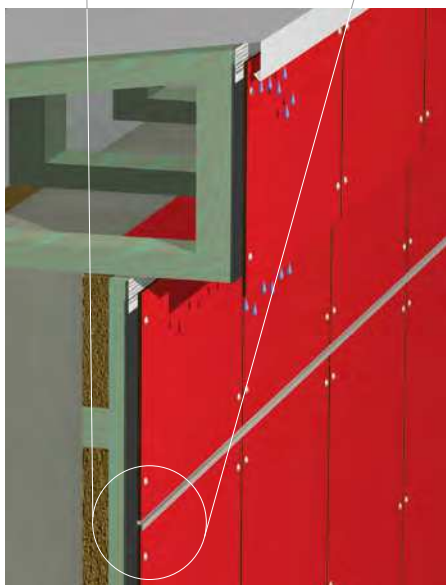
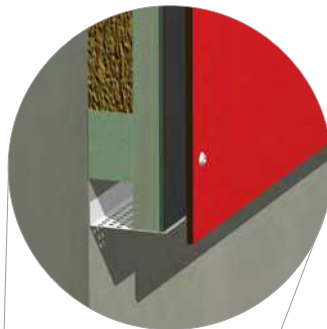

PROTECTION FROM RAIN AROUND PARAPETS / ROOF EDGES

Fig. 45

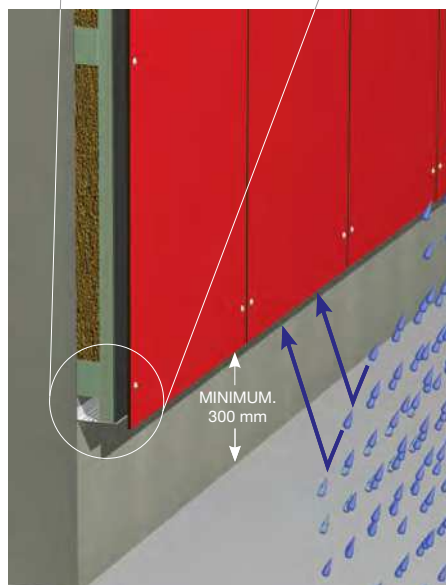

SPRAY WATER NEAR SKIRTING

Fig. 46

Error avoidance in wooden substructures

We recommend based on the latest technical expertises in practise and on current hands-on experience the following approach for wooden-substructures. In order to avoid making errors when building wooden substructures, a few important points must receive attention. The following pages show the most important potentially problematic areas according to a “correct”/ “incorrect” scheme.

CORRECTLY DONE BATTENS / CORRECT EPDM STRIP OF 1.2 mm THICKNESS AND AN OVERHANG OF 10 mm ON EACH SIDE (page 52 Fig. 2)

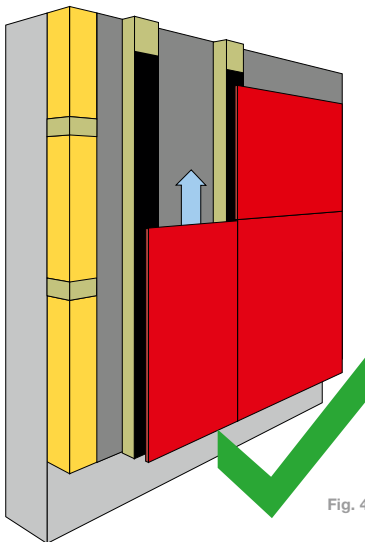

Fig. 47

FAILURE TO USE EPDM TAPE OR USING EPDM TAPES WITH A WIDTH OF LESS THAN 1.2 mm AND THE USE OF METAL OR SHEET METAL SPACE- RS ARE PROVEN TO BE UNSUITABLE.

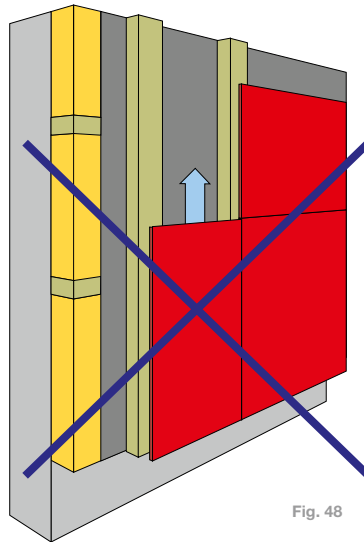

Fig. 48

INCORRECTLY DONE BATTENS

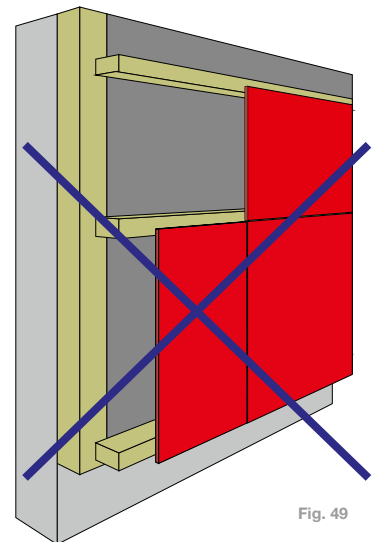
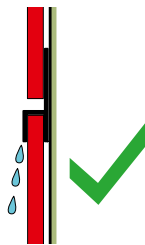

Fig. 49

PLEASE NOTE

- Battens must be pre-dried (15%±3*) and planed on all sides.
- Ensure constructional and/or chemical wood protection!
- Use an EPDM protective tape of at least 1.2 mm thickness and with an overhang of 10 mm per side on all battens.
- Adapt skirting to suit the adjacent terrain.
- A wooden substructure is only permissible in combination with adequate constructional wood protection (roof overhang).
- All horizontal joints must be connected using appropriate profiles (see Fig. 50 - Fig. 52)

DRAINAGE OF RAINWATER



VERTICAL SECTION Fig. 50

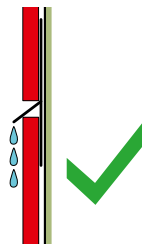

VERTICAL SECTION Fig. 51

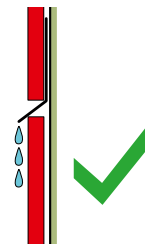

VERTICAL SECTION Fig. 52

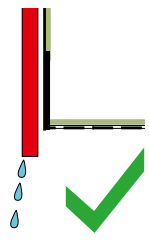

VERTICAL SECTION Fig. 53

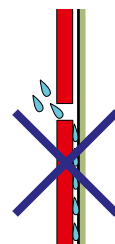

VERTICAL SECTION Fig. 54



VERTICAL SECTION Fig. 55

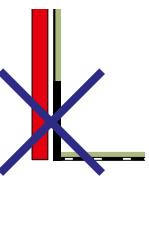

VERTICAL SECTION Fig. 56

*WOOD MOISTURE = $\frac{\text{WATER CONTENT}}{\text{DRY WEIGHT}} \times 100$ IN %

DRILLED HOLE FOR FIXED POINTS D = 6.0 mm/DO NOT USE A COUNTER-SUNK HEAD

DRILLED HOLE FOR SLIDING POINTS D = 8.0 mm/DO NOT USE A COUNTER-SUNK HEAD

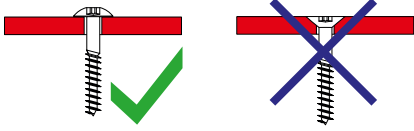

VERTICAL SECTION

Fig. 57

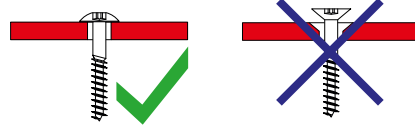

VERTICAL SECTION

Fig. 58

CAPILLARY ACTION/AVOIDANCE OF NARROW JOINTS

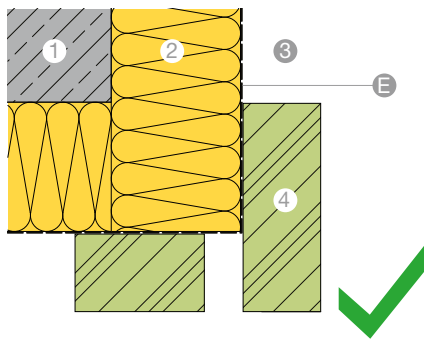

HORIZONTAL SECTION

Fig. 59

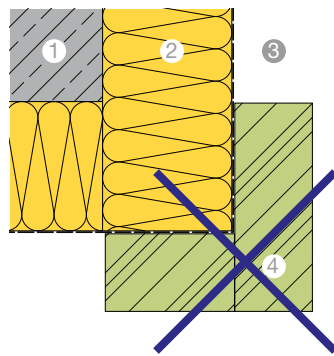

HORIZONTAL SECTION

Fig. 60

VARIANT WITH EXTERNAL CORNER PROFILE

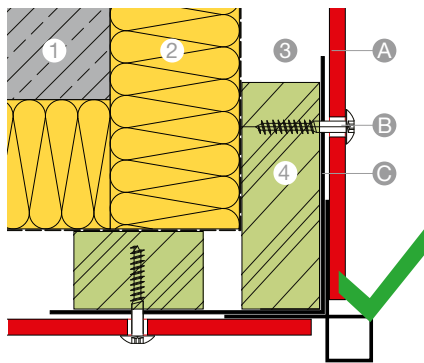

HORIZONTAL SECTION

Fig. 61

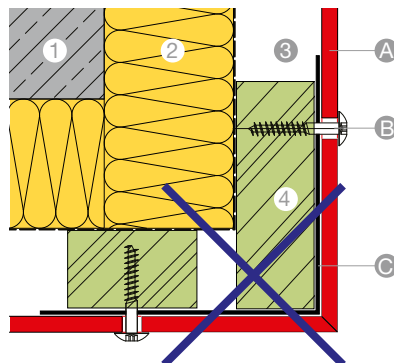

HORIZONTAL SECTION

Fig. 62

VARIANT WITH OPEN JOINT AND OVERHANG OF THE MAX COMPACT EXTERIOR PANEL

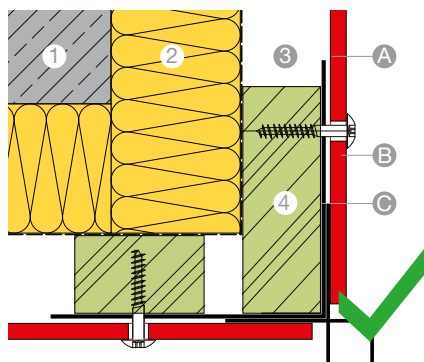

HORIZONTAL SECTION

Fig. 63

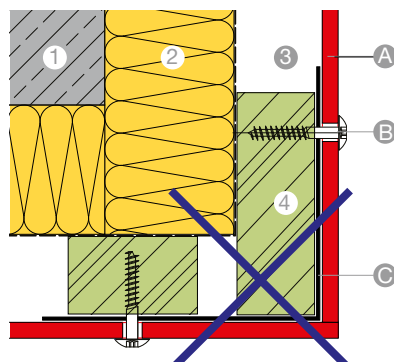

HORIZONTAL SECTION

Fig. 64

LEGENDE

- 1 WALL
- 2 INSULATION
- 3 VENTILATION
- 4 CHEMICAL TREATED WOODEN BATTENS
- A MAX COMPACT EXTERIOR PANEL
- B FASTENING
- C EPDM -PROTECTIVE TAPE MIN. 1.2 mm THICK
- E WIND BARRIER

Standards for Building with Wood

ÖNORM B 2215

Wood working

ÖNORM B 3801

Wood protection in building and construction – Fundamentals and definitions

ÖNORM B 3802-1

Wood Protection in Construction – General

ÖNORM B 3802-2

Wood Protection in Construction – Structural protection of the wood

ÖNORM B 3802-3

Wood Protection in Construction – Chemical protection of the wood

ÖNORM B 3802-4

Wood Protection in Construction – Chemical protection of the wood

ÖNORM B 3803

Protection of timber used in buildings – Coatings of dimensionally stable wooden outdoor building components - Minimum Requirements and Certifications

ÖNORM EN 1995-1-1

Design of timber structures - Part 1-1: General – Common rules and rules for buildings

ÖNORM B 8110-2

Thermal insulation in building construction - water vapor diffusion and condensation protection - form for the temperature and water vapor diffusion calculation

DIN EN 350

Durability of wood and wood products - testing and classification of the durability of wood and wood products against biological effects

DIN 1052-10

Design and production of timber structures – Part 10 Additional rules

DIN 4108-3

Thermal protection and energy economy in buildings – Part 3: Protection against moisture subject to climate conditions – Requirements and directions for design and construction

DIN 18516-1

Cladding for external walls, ventilated at rear – Part 1: Requirements, principles of testing

DIN 68800-1

Wood preservation – Part 1: General

DIN 68800-2

Wood preservation – Part 2: Preventive constructional measures in buildings

DIN 68800-3

Wood preservation – Part 3: Preventive protection of wood with wood preservatives

DIN 68800-4

Wood preservation – Part 4: Curative treatment of wood destroying fungi and insects and refurbishment

DIN 4074-1

Strength grading of wood – Part 1: Coniferous sawn timber

DIN 4074-5

Strength grading of wood – Part 5: Sawn hard wood

DIN EN 335

Durability of wood and wood based product – Use classes: Definitions, application in solid wood and wood products

DIN EN 336

Structural timber – Sizes, permitted deviations

DIN EN 338

Structural timber – Strength classes

EN 14081

Timber structures – Strength graded structural timber with rectangular cross section
Part 1: General requirements: - Visual strength grading – Machine strength grading – Evaluation of conformity – Marking
Part 2: Machine grading: additional requirements for factory production control
Part 3: Machine grading: additional requirements for factory production control

ÖFHF

Association rule of the ÖFHF (2014)
Bulletin for rearventilated facades with wooden substructures (as at: 2014-03-10)

NOTE

PLEASE SEE THE RESPECTIVE AND CURRENT ISSUES OF THE STANDARDS MENTIONED ABOVE!

Design possibilities with Max Compact Exterior panels



Fig. 65



Fig. 66



Fig. 67



PHOTO: THOMAS PENNETIER

Fig. 68



Mounting of Max Compact Exterior panels with screws on a wooden substructure

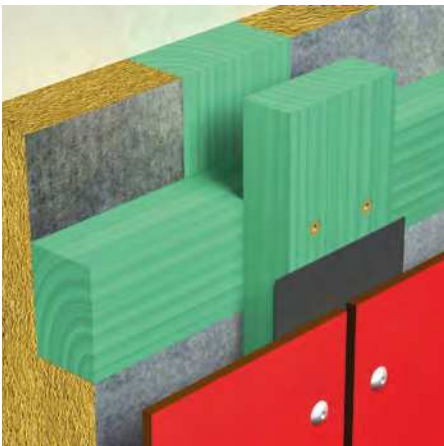

Fig. 69

SUBSTRUCTURE

Please note the hints on pages 45 up to 48. For applications that do not require structural analysis, the dimensions should be at least 60 x 40 mm for the underlying horizontal base or counter battens, at least 50 x 30 mm for the vertical support battens, and 100 x 30 mm in the joint areas. Due to the material properties of Max Compact Exterior, fixed points and sliding points need to be made to mount the panels (Fig. 73 and Fig. 74). For using higher insulation thicknesses you have to build a counterbatten (Fig. 69).

NOTE

TO GET A PERFECT DESIGN OF THE FACADE CLADDING WITH NG SURFACE IT IS RECOMMENDED TO GLUE THE PANELS ON AN ALUMINIUM-SUBCONSTRUCTION. SUBCONSTRUCTION LIKE WOOD DO NOT HAVE THE RIGHT PROPERTIES TO AVOID A WAVY APPEARANCE OF THE CLADDING.

FIXED POINTS

Fixed points are used for uniform distribution (halving) of the expansion and shrinkage movements. The diameter of the drill hole in Max Compact Exterior has to be made with 6.0 mm.

SLIDING POINT

The diameter of the drill hole in Max Compact Exterior must be drilled larger than the diameter of the fastening, depending on the required expansion clearance. This is the shaft diameter of the fastening plus 2 mm for every meter of cladding material starting from the fixed point. The head of the fastening must be big enough so that the drill hole in Max Compact Exterior is always covered. The fastening is placed in such a way that the panel can move. Screws must not be over-tightened. Do not use any countersunk screws. The centre point of the drill hole in the subconstruction must coincide with the centre point of the drill hole in the Max Compact Exterior panels. Drill with a centring piece. The fastenings should be put in place starting from the middle of panel outwards.

JOINT FORMATION

To ensure a tension-free movement of the Max Compact Exterior panels, the joint formation must be at least 8 mm. In Germany, the joint formation is defined in accordance with building inspectorate approval Z-10.3-712 as 8 mm.

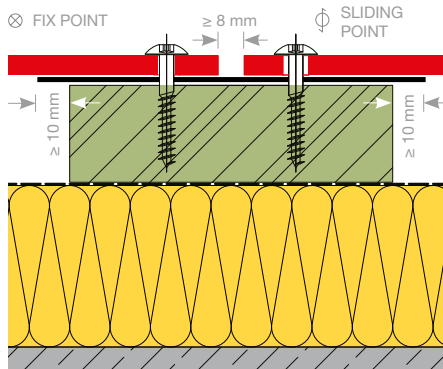

EXAMPLE VERTICAL JOINT

Fig. 70

FASTENINGS

It is essential that fastenings are made from non-corrosive materials.

Max Compact Exterior Installation screw (Fig. 71) with torx wrench 20 made of stainless steel CrNiMo 17122 Material no. 1.4401 V4A. Lacquered head on request.

Diameter of drill hole in Max Compact Exterior

Sliding points: 8 mm or as required

Fixed points: 6.0 mm

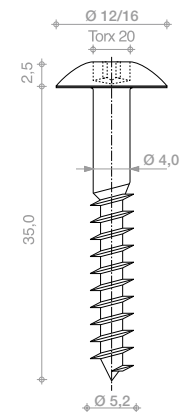

Fig. 71

EDGE SPACINGS

For reasons of stability and flatness, the edge spacings must be kept to without fail. The joints must be made at least 8 mm wide so that changes in size can take place without hindrance (Fig. 70).

FASTENING SPACINGS

These are to be chosen in accordance with the structural engineering requirements (calculations) or, if this is not necessary due to the local regulations, according to Table 9 or Table 10.

TABLE FOR LOAD ON SINGLE SPAN/WIND LOAD*
MAX COMPACT EXTERIOR PANELS SCREWED ON WOODEN SUBSTRUCTURE

| PANEL THICKNESS | 6 mm | | 8 mm | | 10 mm | | |
|-----------------|----------------|------------|------------|------------|------------|------------|------------|
| | LOAD q (kN/m²) | max b (mm) | max a (mm) | max b (mm) | max a (mm) | max b (mm) | max a (mm) |
| GERMANY* | | | | | | | |
| 0.50 | | 600 | 600 | 700 | 700 | 800 | 800 |
| 1.00 | | 600 | 431 | 700 | 539 | 800 | 551 |
| 1.50 | | 600 | 311 | 700 | 373 | 800 | 431 |
| 2.00 | | 537 | 261 | 700 | 280 | 800 | 323 |

Values acc. to DIN 1055-T4 bzw. DIN 18516 and permit Z-10.3-712

AUSTRIA*

| | | | | | | |
|------|-----|-----|-----|-----|------|-----|
| 0.50 | 781 | 662 | 970 | 649 | 1146 | 769 |
| 1.00 | 657 | 394 | 815 | 463 | 964 | 457 |
| 1.50 | 594 | 314 | 737 | 354 | 871 | 396 |
| 2.00 | 537 | 261 | 686 | 286 | 811 | 319 |

Values acc. to ÖNORM B 4014-1,2 or EN 1991-1-4 and permit Z-10.3-712

SWITZERLAND*

| | | | | | | |
|------|-----|-----|-----|-----|------|-----|
| 0.50 | 781 | 662 | 970 | 649 | 1146 | 769 |
| 1.00 | 657 | 394 | 815 | 463 | 964 | 457 |
| 1.50 | 594 | 314 | 737 | 354 | 871 | 396 |
| 2.00 | 537 | 261 | 686 | 286 | 811 | 319 |

Values acc. to SIA-Standard 261 or Z-10.3-712

Table 9

TABLE FOR LOAD ON DOUBLE SPAN/WIND LOAD*
MAX COMPACT EXTERIOR PANELS SCREWED ON WOODEN SUBSTRUCTURE

| PANEL THICKNESS | 6 mm | | 8 mm | | 10 mm | | |
|-----------------|----------------|------------|------------|------------|------------|------------|------------|
| | LOAD q (kN/m²) | max b (mm) | max a (mm) | max b (mm) | max a (mm) | max b (mm) | max a (mm) |
| GERMANY* | | | | | | | |
| 0.50 | | 600 | 600 | 700 | 591 | 800 | 517 |
| 1.00 | | 600 | 345 | 700 | 296 | 800 | 259 |
| 1.50 | | 600 | 230 | 700 | 197 | 800 | 172 |
| 2.00 | | 537 | 193 | 700 | 148 | 800 | 129 |

Values acc. to DIN 1055-T4 bzw. DIN 18516 and permit Z-10.3-712

AUSTRIA*

| | | | | | | |
|------|-----|-----|------|-----|------|-----|
| 0.50 | 974 | 425 | 1209 | 343 | 1429 | 290 |
| 1.00 | 759 | 273 | 1012 | 205 | 1201 | 172 |
| 1.50 | 620 | 223 | 826 | 167 | 1033 | 134 |
| 2.00 | 537 | 193 | 716 | 145 | 894 | 116 |

Values acc. to ÖNORM B 4014-1,2 or EN 1991-1-4 and permit Z-10.3-712

SWITZERLAND*

| | | | | | | |
|------|-----|-----|------|-----|------|-----|
| 0.50 | 974 | 425 | 1209 | 343 | 1429 | 290 |
| 1.00 | 759 | 273 | 1012 | 205 | 1201 | 172 |
| 1.50 | 620 | 223 | 826 | 167 | 1033 | 134 |
| 2.00 | 537 | 193 | 716 | 145 | 894 | 116 |

Values acc. to SIA-Standard 261 or Z-10.3-712

*AN INTERPOLATION IS POSSIBLE ON BASE OF THIS VALUES.
EXAMPLE: IF YOU DONT USE MAX B IN TOTAL IT APPLIES: PERMITTED A = (MAX B/EXISTING B) * MAX A
NOTE: PERMITTED A < MAX B

Table 10

THE VALUES IN THE MEASUREMENT TABLES ARE CHARACTERISTIC VALUES.
DIMENSION TABLES FOR THE WIND LOAD RANGE FROM 0.3 KN/M² TO 2.6 KN/M² ARE AVAILABLE UPON REQUEST FROM THE FUNDERMAX SUPPORT TEAM.

FASTENING SPACINGS FOR AUSTRIA AND SWITZERLAND

If the specified axis dimension „b“ is not fully utilized, then the allowable mounting distance „a“ can be calculated as follows (source: Typenstatik Max Compact Exterior Fassadenplatten Dipl.-Ing. Gerald Segeth, Dobel 18. 04. 11):

When installing a 8 mm double span panel with a wind load of 0.5 kN, the following applies: max b = 1209 mm and max. a = 343.

If a value of 1000 mm is used for „b“ for example, then the maximum allowable „a“ is calculated as follows:

$$\text{allow } a = \frac{\text{max } b}{\text{for given } b} * \text{max } a$$

Example:

$$\text{allow } a = \frac{1209 \text{ mm}}{1000 \text{ mm}} * 343 \text{ mm} = 414 \text{ mm}$$

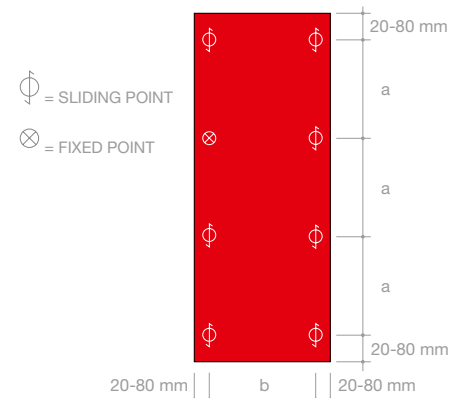

SINGLE SPAN PANEL

Fig. 72

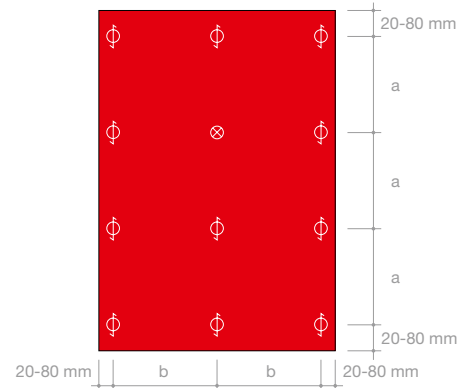

DOUBLE SPAN PANEL

Fig. 73

Construction-details wooden substructure horizontal sections

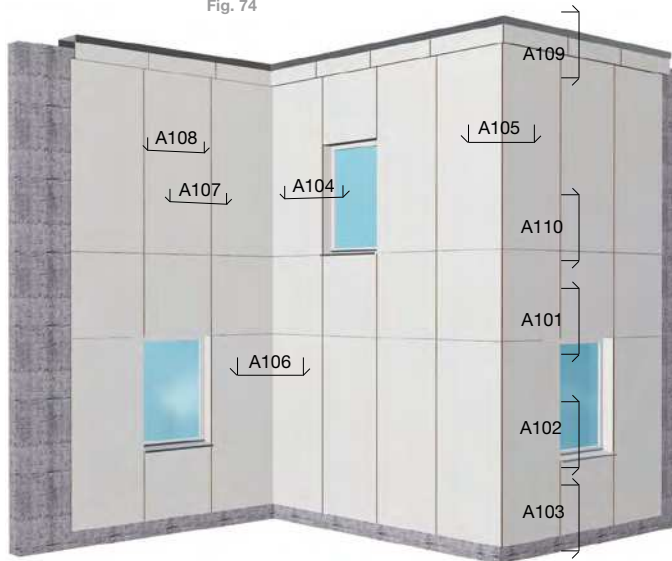
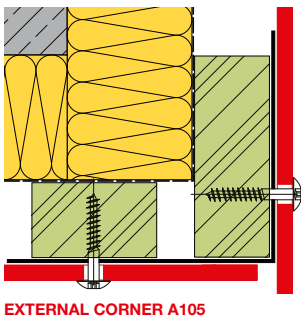
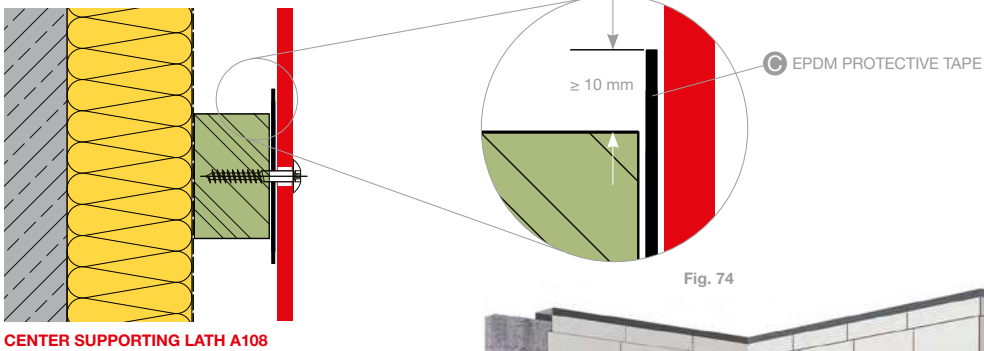
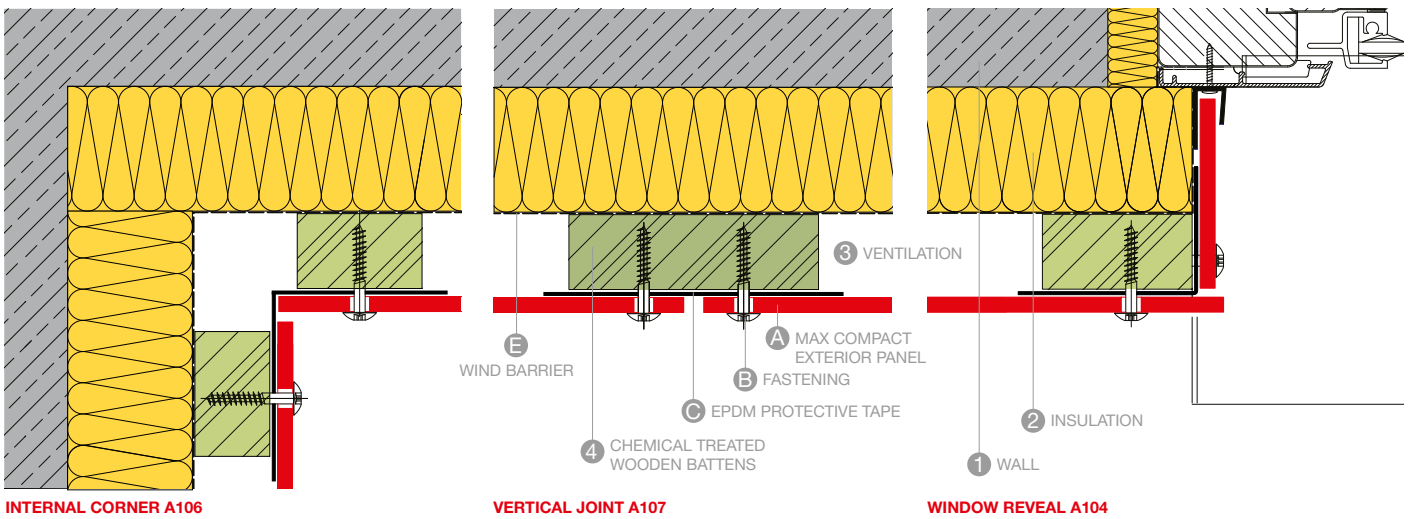

NOTE
SUPPLIERS: SEE PAGES 90/91 AT THE END OF THE BROCHURE.

ALL PROFILES AND FASTENINGS ARE SHOWN IN THIS BROCHURE ARE PLANNING-SUGGESTIONS AND NOT PART OF THE FUNDERMAX DELIVERY PROGRAMME! ALL DRAWINGS IN THIS BROCHURE ARE NOT TRUE TO SCALE!

Construction-details wooden substructure vertical sections

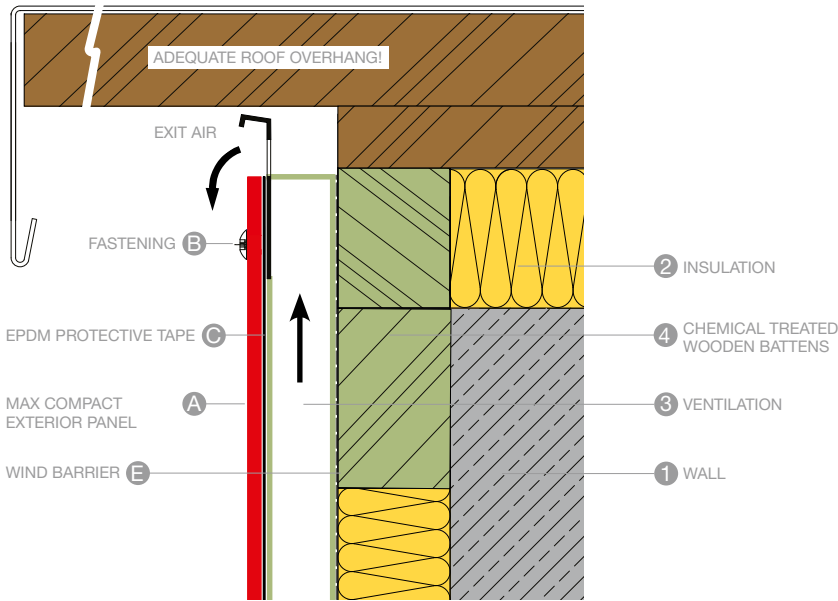

ATTIC CONNECTION A109

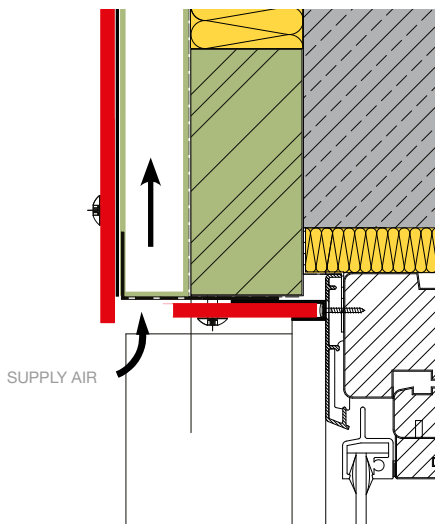

WINDOW LINTEL A101

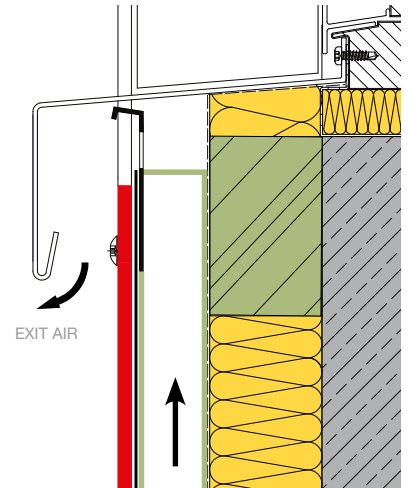

WINDOW SILL CONNECTION A102

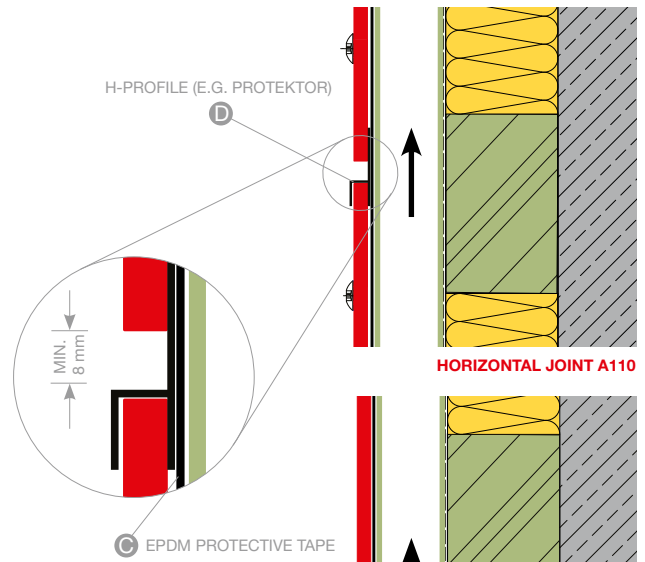

HORIZONTAL JOINT A110

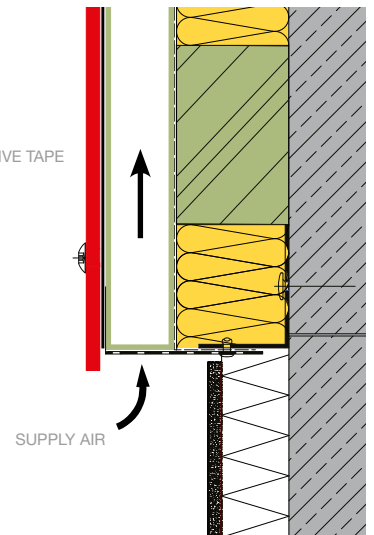

BASE CONNECTION A103

Visible mechanical fastenings with rivets or screws



Fig. 75



Fig. 76

Max Compact Exterior panels can be mounted using rivets on an aluminium substructure, or with screws on a wood framework. Pay attention to the hints on pages 45 - 48. The wooden substructure has to be constructed according to the national normes (wood moisture $15\% \pm 3$). **Pay attention to chemical or constructive wood preservation!**

There always has to be put a protection tape (thickness 1.2 mm) between the Max Compact Exterior panel and the wooden batten. An overhang of ≥ 10 mm on each edge is essential. The lathe-work has always built in parallel to the airstream. Openings for supply and exit-air have to be done with ≥ 20 mm free cross-section. The exit-air always leaves over the rear-ventilated section of the rear-ventilated facade. Connection with EIFS facades are allowed only if these have an exit-air section also.

Due to the material properties of Max Compact Exterior, fixed point and sliding points need to be made to mount the panels.

FIXED POINTS

Fixed points are used for uniform distribution (halving) of the expansion and shrinkage movements. The diameter of the drill hole in Max Compact Exterior has to be same of the diameter of the fastener.

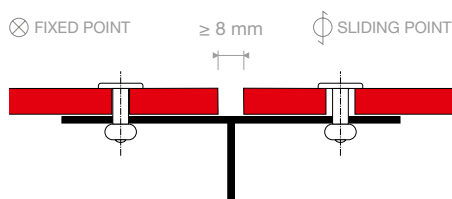

EXAMPLE OF VERTICAL JOINT

Fig. 77

NOTE

TO GET A PERFECT DESIGN OF THE FACADE CLADDING WITH NG SURFACE IT IS RECOMMENDED TO GLUE THE PANELS ON AN ALUMINIUM-SUBCONSTRUCTION. SUBCONSTRUCTION LIKE WOOD DO NOT HAVE THE RIGHT PROPERTIES TO AVOID A WAVY APPEARANCE OF THE CLADDING.

SLIDING POINTS

The diameter of the drill hole in Max Compact Exterior must be drilled larger than the diameter of the fastening, depending on the required expansion clearance. This is the shaft diameter of the fastening plus 2 mm for every meter of cladding material starting from the fixed point. The head of the fastening must be big enough so that the drill hole in Max Compact Exterior is always covered. The fastening is placed in such a way that the panel can move. Screws must not be over-tightened. Do not use any countersunk screws. The centre point of the drill hole in the subconstruction must coincide with the centre point of the drill hole in the Max Compact Exterior panels. Drill with a centring piece. The fastenings should be put in place starting from the middle of panel outwards.

EDGE SPACINGS

For reasons of stability and flatness, the edge spacings must be kept to without fail. The joints must be made at least 8 mm wide so that changes in size can take place without hindrance (Fig. 77).

FASTENING SPACINGS

These are to be chosen in accordance with the structural engineering requirements (calculations) or, if this is not necessary due to the local regulations, according to Table 11.

FASTENINGS

It is essential that fastenings are made from non-corrosive materials.

Max Compact Exterior Installation on screw (Fig. 71, p. 51) with Torx wrench 20 made of stainless steel X5CrNiMo 17122 Material no. 1.4401 V4A. Lacquered head on request.

Diameter of drill hole in Max Compact Exterior for installation with screw
 Sliding points: 8 mm or as required
 Fixed points: 6.0 mm

Alu-Blind rivet

(Fig. 34, p. 27) with big head colour lacquered for outdoor applications with Max Compact Exterior panels on aluminium-substructures. Rivet sleeve: material-no. EN AW-5019 acc. DIN EN 755-2

Rivet pin: steel material-no. 1.4541
 Pull-off strength of rivet pin: ≤ 5.6 KN
 Diameter of drill hole in Max Compact Exterior for installation with rivets
 Sliding points: 8.5 mm or as required
 Fixed points: 5.1 mm

Diameter of drill hole in aluminium substructure: 5.1 mm The rivets must be put in place with a flexible mouthpiece, clearance 0.3 mm. The rivet, flexible mouthpiece and riveting tool must be suited to each other.

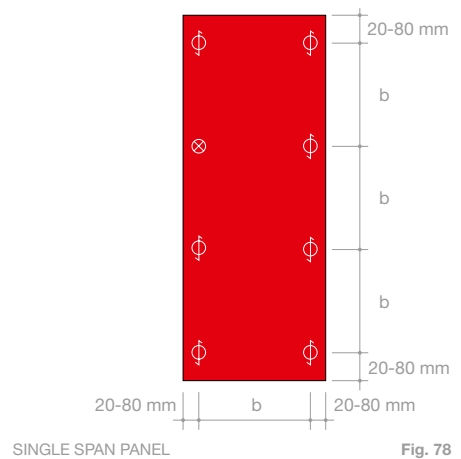

Fig. 78

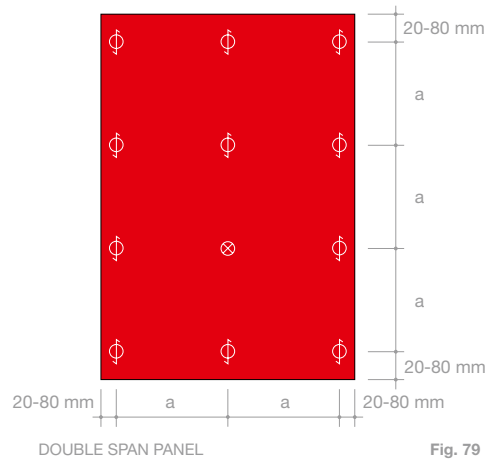

Fig. 79

⊕ = SLIDING POINT
 ⊗ = FIXED POINT

FOR INSTALLATION WITH MECHANICAL FASTENINGS

| PANEL THICKNESS | MAXIMUM FASTENING SPACING „b“ SINGLE SPAN PANEL | MAXIMUM FASTENING SPACING „a“ DOUBLE SPAN PANEL |
|-----------------|---|---|
| 6 mm | 350 mm | 400 mm |
| 8 mm | 400 mm | 450 mm |
| 10 mm | 450 mm | 500 mm |

Table 11



Construction-details horizontal sections - Soffits riveted

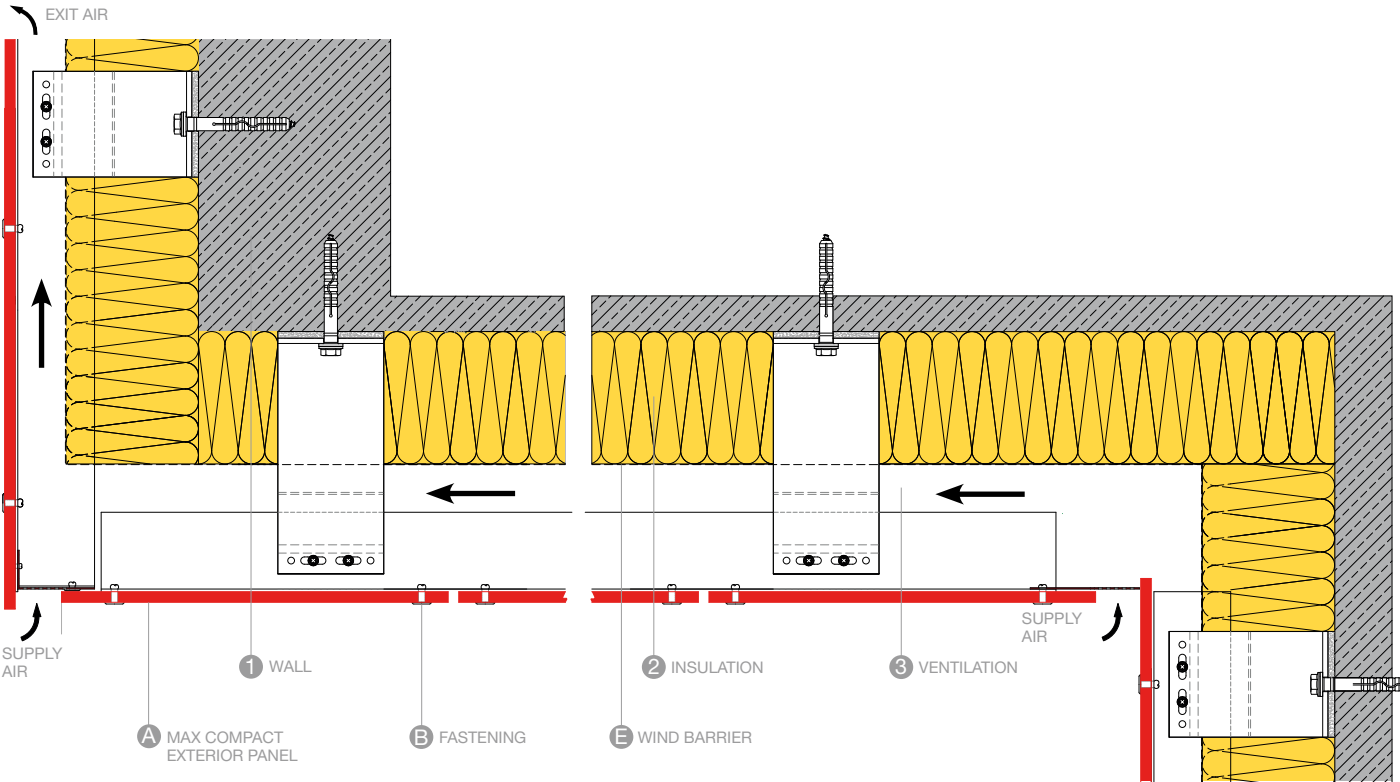

Fig. 80

Concealed mounting with gluing system

SUPPLIERS OF GLUES

Sika Tack Panel
Z-10.8-408
MBE Panel-loc glue system
Z-10.8-350
PROPART Klebedicht KD385
Z-10.8-453
Innotec Project System
Z-10.8-483

As an alternative to installation with visible mounting means, Max Compact Exterior panels can be installed with gluing systems on aluminum substructures.

A structural analysis must be performed to verify the stability of each object.

It is important that necessary approvals are obtained from the relevant competent municipal or federal building authorities. Due to the different building regulations in different regions, it could be that the building authorities require additional mechanical securing means such as rivets, screws, or the like.

The gluing process is to be performed in accordance with the manufacturer guidelines for the glue.

FunderMax recommends using gluing systems that are approved by the responsible building authorities for the installation of non-bearing, rear-ventilated facades.

In principle, the following points should be considered during the work process:

PRETREATMENT OF ALUMINIUM SUBCONSTRUCTIONS

- Sanding with a suitable sanding fleece in accordance with the adhesive manufacturer's recommendation
- Cleaning with a suitable cleaning agent in accordance with the adhesive manufacturer's recommendation¹⁾
- Apply primer in accordance with the adhesive manufacturer's recommendation
- Observe the drying time for the cleaning agent and the primer in accordance with the adhesive manufacturer's instructions

PRE-TREATMENT OF THE MAX COMPACT EXTERIOR PANEL

- Sanding with a suitable sanding fleece in accordance with the adhesive manufacturer's recommendation
- Cleaning with a suitable cleaning agent in accordance with the adhesive manufacturer's recommendation¹⁾
- Apply primer in accordance with the adhesive manufacturer's recommendation
- Observe the drying time for the cleaning agent and the primer in accordance with the adhesive manufacturer's instructions

All surfaces to be glued must be kept clean, dry and free of grease.

GLUING

- Apply installation tape over the entire length of the vertical profiles (do not remove the protective film yet).
- Apply glue: The adhesive is applied as a triangular bead according to the system recommendations of the adhesive manufacturer.
- Panel installation: Remove the protective film of the installation tape. Align the panels accurately (mounting bracket) until they come into contact with the installation tape.

Information must be obtained without fail from the manufacturer of the gluing system.

¹⁾SIKA ACTIVATOR 205 ACTIVATES THE MATERIAL SURFACE AND LEAVES A GREY SHEEN. DO NOT APPLY TO THE FRONT SIDE OF THE PANELS. REMOVE ANY SPLASHES IMMEDIATELY.

Recommondations for producing outdoor-furniture



Fig. 81

APPLICATION

Max Compact Exterior panels are often used as table tops, benches or furniture in outdoor applications.

RESISTANCE

Due to their pore-free surfaces and excellent chemical resistance, Max Compact Exterior panels are very easy to clean. Further advantages of these panels include their high scratch, tear and impact resistance.

STORAGE

Neither tables nor table panels should be stacked as the heavy stack weight can lead to damage. Further the outdoor-furniture should not be exposed to standing water.

PANEL THICKNESS

The thickness of Max Compact Exterior (table) panels should either be 12 mm, or at least 10 mm, in order to allow enough depth for screwing. Both panel thickness and mounting distances as well as expected load platforms, are directly linked and must be measured correspondingly.

FASTENING

The fastening of Max Compact Exterior panels can be carried out in a number of different ways, however, due to the material characteristics, a linear free expansion must be considered during the mounting process. The panels can be mounted mechanically using screws or using glues. The screws can either be directly screwed into the panels or inserted using sleeve screws with internal and external threads (e.g. Rampa inserts). For this, the panels must be pre-drilled for to establish a thread. Fastening the panels using screws takes place from the underside of the material. Therefore, metric thread and flat-head screws are suitable. Washers can be used if required.

Due to Max Compact Exterior panels material characteristics, the fixing points must be sliding points.

SLIDING POINT

The drill diameter in the substructure must be bigger than that of the mounting material depending on the corresponding Compact expansion room. The screw head should always cover the borehole. The mounting material will be attached in such a way that the panels are free to move. Screws should not be too tightly fastened. The middle point of the drilling in the substructure should correspond with the middle point of the drilling in the Max Compact Exterior F-quality panel.

Drill with centering sleeve! The fastening material should be attached from the middle of the panel outwards.

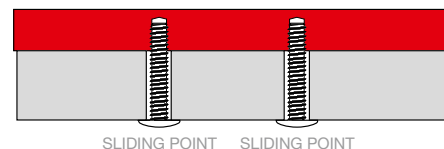

Fig. 82

FASTENING SPACINGS

| MAX COMPACT EXTERIOR PANELS | | |
|-----------------------------|------------------------|-----------------|
| THICKNESS (mm) | FASTENING SPACING (mm) | PROJECTION (mm) |
| 10 | 320 | 180 |
| 12 | 400 | 250 |

Table 12

Examples when using Max Compact Exterior in 12 mm

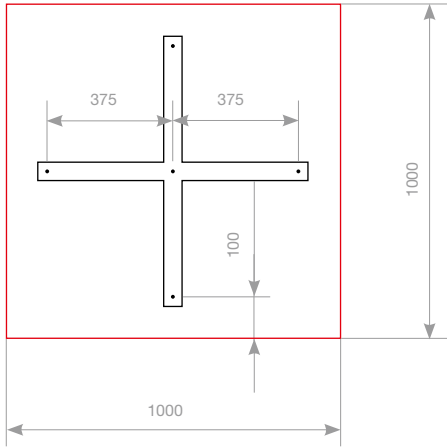

EXAMPLE FOR TABLE APPLICATION

Fig. 83

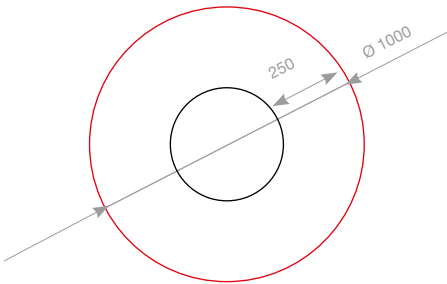

EXAMPLE FOR TABLE APPLICATION

Fig. 84

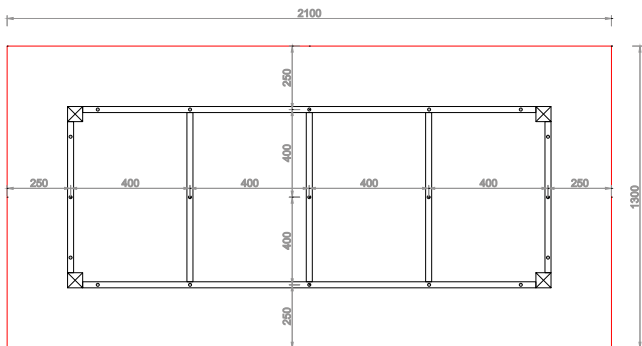
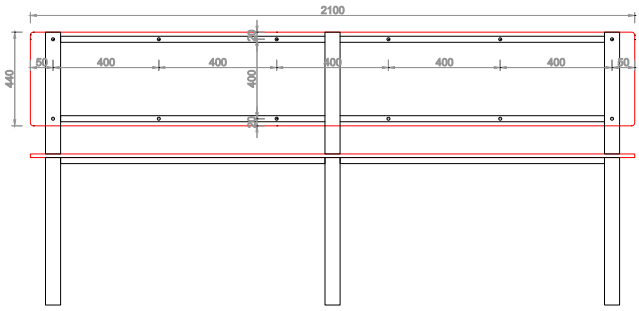

TABLE APPLICATION

Fig. 85



BENCH WITH BACKREST

Fig. 86

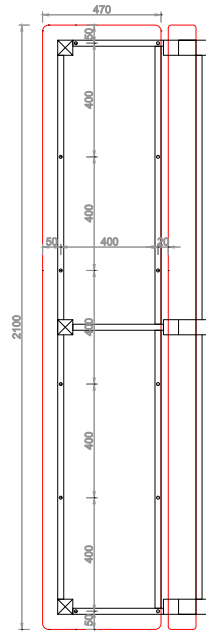

BENCH WITH BACKREST

Fig. 87

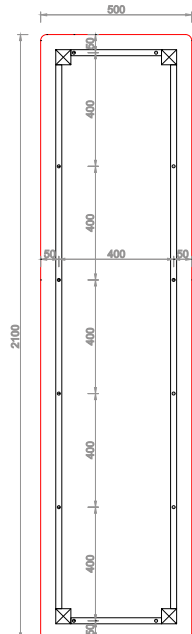

BENCH

Fig. 88

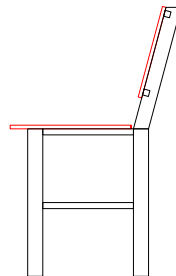

- 62 General
- 64 Fastenings for balconies
- 65 Principle of fastening the railingstructure
- 66 Fastening and Edge Spacing - Variants
- 73 Balcony partition wall

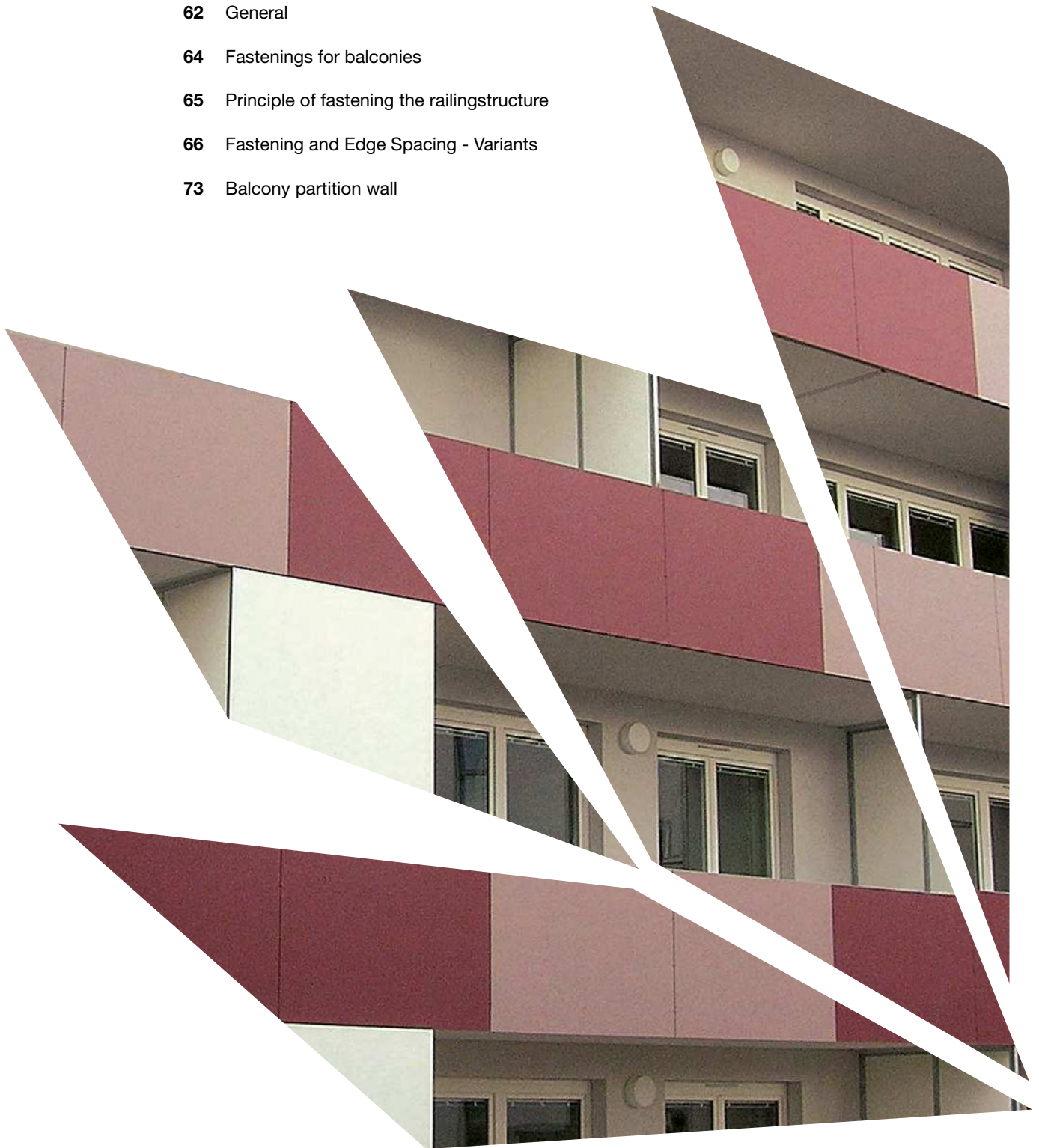
**NOTE**

PLEASE CHECK ADDITIONAL AT WWW.FUNDERMAX.AT FOR THE LATEST VERSION OF THIS BROCHURE.

THE DIAGRAMS IN THIS TECHNICAL INFORMATION ARE SCHEMATICAL REPRESENTATIONS AND ARE NOT TRUE TO SCALE.
THIS ISSUE REPLACES ALL OTHER ISSUES OF EXTERIOR TECHNIQUES BROCHURES OF FUNDERMAX WHICH WERE PUBLISHED BEFORE.

General

Max Compact Exterior panels can be mounted in a variety of different designs as panels for balconies, railings or fencing.

BASICS

During construction and installation, care is to be taken that the material is not exposed to standing water. This means that the panels must always be able to dry out.

Connections of Max Compact Exterior panels to one another always have to be made in the same panel direction. Max Compact Exterior can show deviations from being flat (see EN 438-6, 5.3), and this is to be compensated for by the sub-construction being executed so that it is stable and flat. All connections to other components or to the background must be executed firmly. Elastic intermediate spacers to the sub-construction elements and also between sub-construction elements which permit a greater tolerance than ± 0.5 mm must definitely be avoided. Max Compact Exterior panels can be mounted with rivets or screws. Due to the material properties of Max Compact Exterior panels, fixed point and sliding points need to be made to mount the panels (Fig. 91, p. 63).

TECHNICAL NOTES

The substructure is to be protected against corrosion regardless of the material or system used. Likewise, when selecting the materials to be used, attention must be paid to the prevention of possible contact corrosion.

Anchoring elements for installation on walls or for installation of the panels must be suitably dimensioned to withstand the local wind loads and meet the local structural requirements. Verifications are to be submitted to the client. The necessary space for expansion according to the manufacturer's recommendations must be taken into account when installing Max Compact Exterior panels.

SLIDING POINT

The diameter of the drill hole in Max Compact Exterior must be drilled larger than the diameter of the fastening, depending on the required expansion clearance. This is the shaft diameter of the fastening plus 2 mm for every meter of cladding material starting from the fixed point. The head of the fastening must be big enough so that the drill hole in Max Compact Exterior is always covered. The fastening is placed in such a way that the panel can move. Rivets are put in place with flexible mouth-pieces. The defined clearance of the rivet head, allows movement of the elements in the drill hole. Clearance + 0.3 mm (Fig. 97, p. 64). Screws must not be over-tightened. Do not use any countersunk screws - use washers if necessary. The centre point of the drill hole in the subconstruction must coincide with the centre point of the drill hole in Max Compact Exterior panel. Drill with a centring piece! The fastenings should be put in place starting from the middle of panel outwards.

FIXED POINT

Fixed points are used for uniform distribution (halving) of the expansion and shrinkage movements. The diameter of the drill hole in Max Compact Exterior is the same size as the diameter of the fastening.

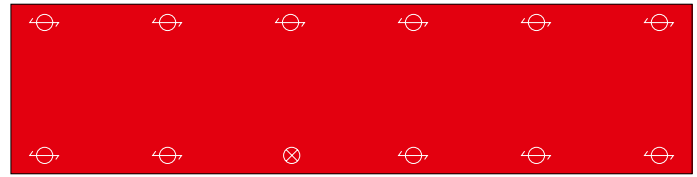

SINGLE SPAN PANEL

Fig. 89

⊖ = SLIDING POINT
 ⊗ = FIXED POINT

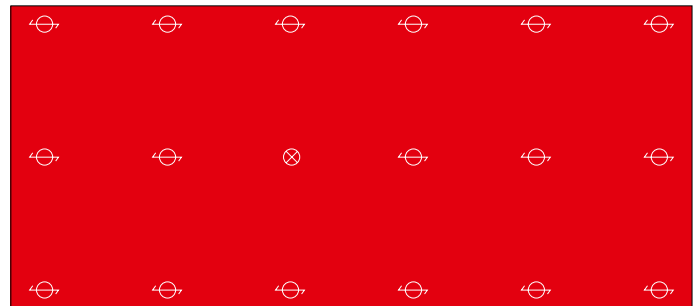

DOUBLE SPAN PANEL

Fig. 90

PANEL JOINTS

The joints must be made at least 8 mm wide so that changes in size can take place without hindrance.

DECOR COMBINATION

In order to be able to design the inner sides of balconies so that they are uniformly sight, it is possible to produce Max Compact Exterior panels with a white (rear) side decor 0890 NT balcony white. Due to the asymmetric composition the fixing distances should be reduced by 15%.

BALCONY CORNERS

Especially, in some circumstances, when refurbishing with very uneven subconstructions, it is important to have the front panel protrude about 10 mm in front of the side panel. In this way, inaccuracies can be concealed from the main viewing side.

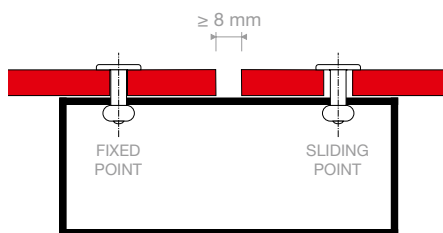

Fig. 91

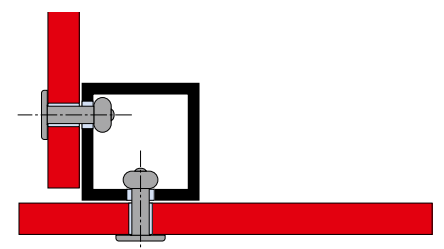

Fig. 92

Fastenings for balconies

It is essential that fastenings are made from non-corrosive materials.

MAX COMPACT EXTERIOR BALCONY SCREW (A2)

With bare head, can be lacquered.
 Washer between Max Compact Exterior panel and subconstruction made of polyamide.
 Diameter of drill hole in Max Compact Exterior panel:
 Sliding points: 8,5 mm or as required
 Fixed points: 6 mm
 Diameter of drill hole in substructure:
 Drill hole for mounting: 6 mm or according to the dimension of fix-point-socket.

Screw length =
 Clamping thickness + ≥ 9 mm

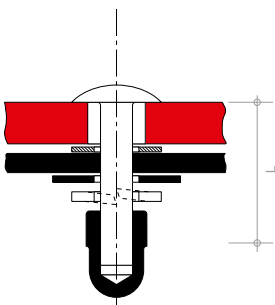

Fig. 96

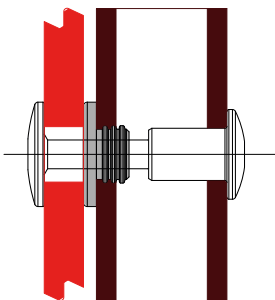

Fig. 97

ALUMINIUM BLIND RIVET

with big head colour lacquered for Aluminium-subconstructions.
 Rivet sleeve: material-no. EN AW-5019 acc. DIN EN 755-2
 Rivet pin: steel material-no. 1.4541
 Pull-off strength of rivet pin: ≤ 5.6 KN

NIRO/NIRO BLIND RIVET

with big head colour lacquered for steel subconstructions.
 Rivet sleeve: material-no. 1.4567 (A2)
 Rivet pin: steel material-no. 1.4541 (A2)
 Pull-off strength of rivet pin: ≤ 5.8 KN

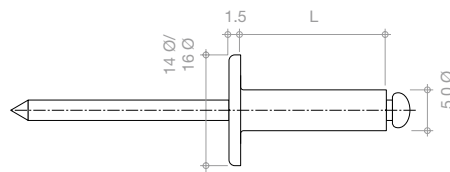

Fig. 93

Diameter of the drill hole in the Max Compact Exterior panel.
 Sliding points: 8.5 mm or as required.
 Fixed points: 5.1 mm

Diameter of drill hole in the metal subconstruction: 5.1 mm
 Stainless steel/stainless steel blind rivets must be used for steel or stainless steel substructures.

GLASS MOUNTING BRACKETS

may be used for fixing Max Compact Exterior panels also. Clamping jaws should have securing pins which prevent the filler elements from falling if the clamp should slacken.

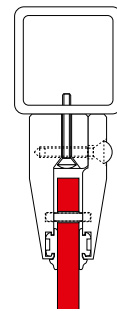

Fig. 95

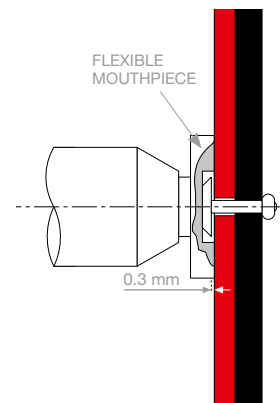

Fig. 94

The rivets must be put in place with a flexible mouthpiece, clearance 0.3 mm.

APPROVALS FROM THE BUILDING AUTHORITIES FOR SCREWS AND RIVETS CAN BE OBTAINED FROM THE RESPECTIVE SUPPLIERS.

SUPPLIERS OF FASTENING AND SUBSTRUCTURES YOU WILL FIND ON PAGES 90/91 OR AT „WWW.FUNDERMAX.AT“.

Principle of fastening the railingstructure

FASTENING BELOW THE CONCRETE BASE

x = Fastening screw according to the static needs.

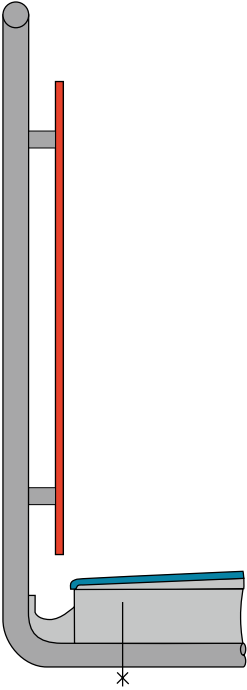

Fig. 98

FASTENING ON THE CONCRETE BASE

x = Fastening screw according to the static needs.

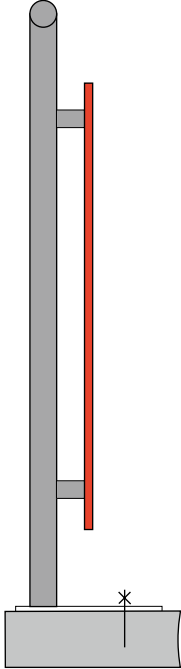

Fig. 99

FASTENING ON THE FRONTSIDE OF THE CONCRETE BASE

x = Fastening screw according to the static needs.

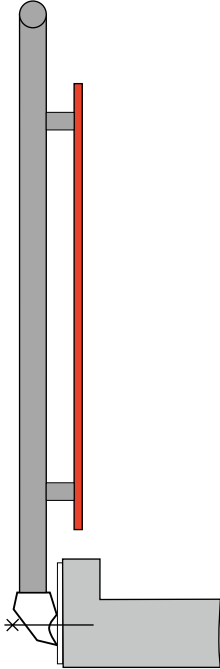

Fig. 100

THE RAILING HEIGHT IS CALCULATED FROM THE UPPER EDGE OF THE CONCRETE UPSTAND AS THIS IS TO BE REGARDED AS THE STEP SURFACE.

Fastening and Edge Spacing - Variants

**MAX COMPACT EXTERIOR RIVETED PANELS.
RIVETING DONE AS DESCRIBED ON PAGE 64.**



Fig. 101

The railing installation variants shown here have been tested at the University of Technology, Hanover in accordance with the ETB guidelines for „Building Components which Safeguard against Falls, June 1985“ and passed.

- $F1 \leq 120 \text{ mm}$
- $F2 \leq 40 \text{ mm}$
- Projecting ends E
- for 6 mm panels: $20 \text{ mm} \leq E \leq 120 \text{ mm}$
- for 8 mm panels: $20 \text{ mm} \leq E \leq 200 \text{ mm}$
- for 10 mm panels: $20 \text{ mm} \leq E \leq 250 \text{ mm}$

| Panel thickness in mm | | Height of railing* |
|-----------------------|---|--|
| | | H = 900-1100 mm = maximum fastening spacing |
| 6 mm | A | $\leq 350 \text{ mm}$ |
| | L | $\leq 800 \text{ mm}$ |
| 8 mm | A | $\leq 350 \text{ mm}$ |
| | L | $\leq 950 \text{ mm}$ |
| 10 mm | A | $\leq 400 \text{ mm}$ |
| | L | $\leq 1000 \text{ mm}$ |

Table 13

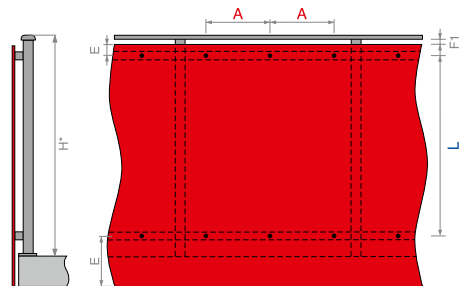

Fig. 102

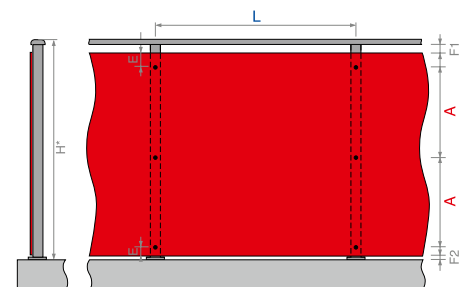

Fig. 103

* THE HEIGHT OF THE RAILING MUST COMPLY WITH THE LOCAL BUILDING REGULATIONS. E.G. OIB DIRECTIVE 4 - USE AND ACCESSIBILITY. THE HEIGHT OF THE RAILING MUST BE AT LEAST 1000 mm; STARTING FROM A HEIGHT OF FALL WITH MORE THAN 12 m, MEASURED FROM THE BASE, MUST BE MINIMUM 110 cm.

**MAX COMPACT EXTERIOR SCREWED PANELS.
BALCONY SCREWS AS DESCRIBED ON PAGE 64.**



Fig. 106

- $F1 \leq 120 \text{ mm}$
 $F2 \leq 40 \text{ mm}$
 Projecting ends E
 - for 6 mm panels: $20 \text{ mm} \leq E \leq 120 \text{ mm}$
 - for 8 mm panels: $20 \text{ mm} \leq E \leq 200 \text{ mm}$
 - for 10 mm panels: $20 \text{ mm} \leq E \leq 250 \text{ mm}$

| Panel thickness mm | | Height of railing* H = 900 - 1100 mm = maximum fastening spacing |
|--------------------|---|---|
| 6 mm | A | $\leq 450 \text{ mm}$ |
| | L | $\leq 850 \text{ mm}$ |
| 8 mm | A | $\leq 500 \text{ mm}$ |
| | L | $\leq 1000 \text{ mm}$ |
| 10 mm | A | $\leq 550 \text{ mm}$ |
| | L | $\leq 1100 \text{ mm}$ |

Table 14

* THE HEIGHT OF THE RAILING MUST COMPLY WITH THE LOCAL BUILDING REGULATIONS. E.G. OIB DIRECTIVE 4 - USE AND ACCESSIBILITY. THE HEIGHT OF THE RAILING MUST BE AT LEAST 1000 mm; STARTING FROM A HEIGHT OF FALL WITH MORE THAN 12 m, MEASURED FROM THE BASE, MUST BE MINIMUM 110 cm.

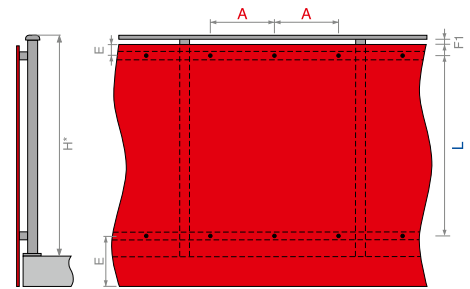

Fig. 104

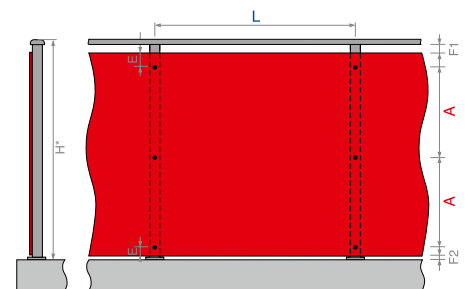

Fig. 105

MAX COMPACT EXTERIOR PANELS WITH ALUMINIUM EDGE STRIPS FIXED. DIMENSIONING ACCORDING TO STRUCTURAL ENGINEERING REQUIREMENTS.



Fig. 107

- F1 ≤ 120 mm
- F2 ≤ 40 mm
- B ≥ 1300 mm = Length of element
- P ≥ 28 mm Depth of profile
- D ≥ 8 mm Expansion gap

Attention must be paid to the drainage of the bottom profile!

| Panel thickness in mm | | Height of railings* H = 900-1100 mm = maximum fastening spacing |
|-----------------------|---|---|
| 6 mm | A | ≤ 950 mm |
| 8 mm | A | ≤ 1150 mm |

Table 15

* THE HEIGHT OF THE RAILING MUST COMPLY WITH THE LOCAL BUILDING REGULATIONS. E.G. OIB DIRECTIVE 4 - USE AND ACCESSIBILITY. THE HEIGHT OF THE RAILING MUST BE AT LEAST 1000 mm; STARTING FROM A HEIGHT OF FALL WITH MORE THAN 12 m, MEASURED FROM THE BASE, MUST BE MINIMUM 110 cm.

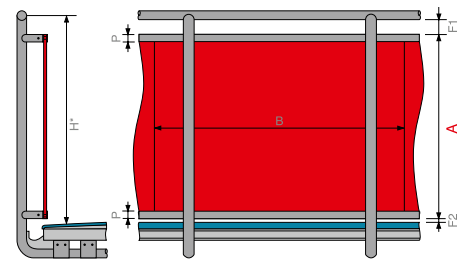

Fig. 108

**MAX COMPACT EXTERIOR PERFORATED AND RIVETED.
BALCONY RIVETED AS DESCRIBED ON PAGE 64.**



Fig. 109

Centre distances have to be built linear and squarebased (see Fig. 111, p. 70).

$F1 \leq 120 \text{ mm}$

$F2 \leq 40 \text{ mm}$

Projecting ends E

- for 10 mm panels: $20 \text{ mm} \leq E \leq 250 \text{ mm}$

| Panel thickness in mm | | Height of railing* |
|-----------------------|---|-----------------------|
| 10 mm | A | $\leq 350 \text{ mm}$ |
| | L | $\leq 840 \text{ mm}$ |

Table 16

* THE HEIGHT OF THE RAILING MUST COMPLY WITH THE LOCAL BUILDING REGULATIONS. E.G. OIB DIRECTIVE 4 - USE AND ACCESSIBILITY. THE HEIGHT OF THE RAILING MUST BE AT LEAST 1000 mm; STARTING FROM A HEIGHT OF FALL WITH MORE THAN 12 m, MEASURED FROM THE BASE, MUST BE MINIMUM 110 cm.

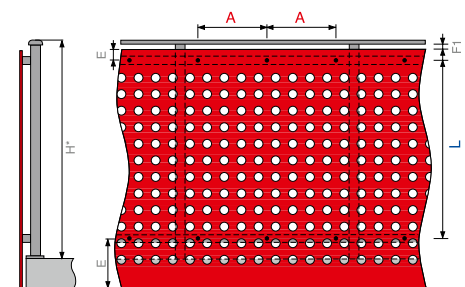

Fig. 110

RECOMMENDED HOLE PATTERN

| | | |
|---|------------------|----------------------|
| D | Diameter of hole | $\leq 40 \text{ mm}$ |
| G | Hole distance | 30 mm |
| H | Centre distance | 70 mm |

Table 17

Fundamentals of Breast-work Constructions

In buildings where, as a rule, children are expected to be present, these must be functional and prevent being climbed over. Designs that feature openings must adhere to local building regulations.

AUSTRIA

OIB RL 4.1.3/ÖNORM B5371 Point. 12

Maximum horizontal opening size: 12 cm

Maximal vertical opening size: 2 cm

GERMANY

DIN 18065:

2001-01/State Building Codes

Maximum horizontal opening sizes

In constructions using bars: 12 cm

Maximal vertical opening size: 2 cm

Diagonal size in constructions using horizontal boards or bars, as well as in lattice constructions: 4 cm

SWITZERLAND

SIA-Standard 358/Specialist brochure of the bfu – Swiss Council for Accident Prevention

In Risk Situation (GF) 1, the diameter of openings in the protective elements up to 75 cm in height may not exceed 12 cm. Climbing should be prevented or impeded by suitable measures such as:

Horizontal traverses (openings) should be 1–3 cm max. in size

Lattice-like patterns of holes:

opening size of max. 4 cm

Round drilled holes: opening size of max. 5 cm

When considering project-specific deviations, please consult with the relevant building authority.

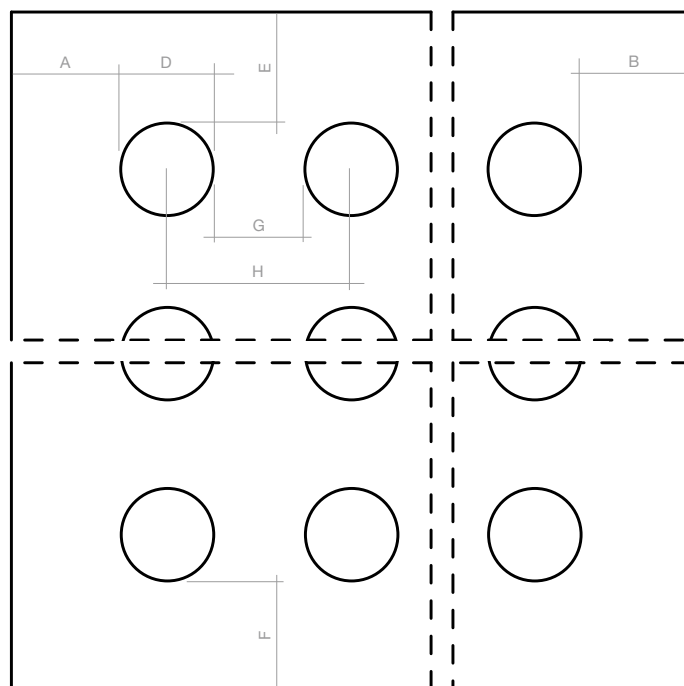

Fig. 111

LEGEND

- A EDGE DISTANCE HORIZONTAL
- B EDGE DISTANCE HORIZONTAL
- D DIAMETER OF HOLE
- E EDGE DISTANCE VERTICAL
- F EDGE DISTANCE VERTICAL
- G HOLE DISTANCE HORIZONTAL AND VERTICAL
- H CENTRE DISTANCE HORIZONTAL AND VERTICAL

MAX COMPACT EXTERIOR PANELS PANELS WITH CLAMPING. SECTIONS FIXED (glass mounting brackets).



Fig. 112

- $F1 \leq 120 \text{ mm}$
- $F2 \leq 40 \text{ mm}$
- $20 \text{ mm} \leq E \leq 20 \times \text{Panel thickness}$
- $G \geq 35 \text{ mm}$

At least 3 fastening points must be positioned per side. For each panel element a bracket with safety pin has to be used.

| Panel thickness in mm | | Height of railing* | |
|-----------------------|---|---|--|
| | | H = 900-1100 mm = maximum fastening spacing | |
| 8 mm | A | $\leq 450 \text{ mm}$ | |
| | L | $\leq 950 \text{ mm}$ | |
| 10 mm | A | $\leq 500 \text{ mm}$ | |
| | L | $\leq 1100 \text{ mm}$ | |
| 13 mm | A | $\leq 550 \text{ mm}$ | |
| | L | $\leq 1150 \text{ mm}$ | |

Table 18

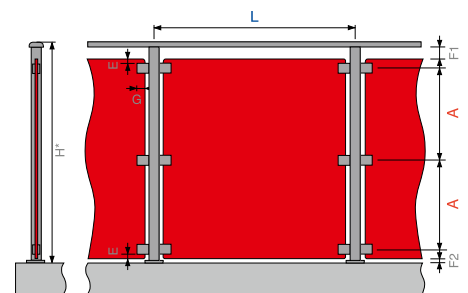

Fig. 113

* THE HEIGHT OF THE RAILING MUST COMPLY WITH THE LOCAL BUILDING REGULATIONS. E.G. OIB DIRECTIVE 4 - USE AND ACCESSIBILITY. THE HEIGHT OF THE RAILING MUST BE AT LEAST 1000 mm; STARTING FROM A HEIGHT OF FALL WITH MORE THAN 12 m, MEASURED FROM THE BASE, MUST BE MINIMUM 110 cm.

CURVED BALCONY WITH MAX COMPACT EXTERIOR PANELS AND METAL EDGE STRIPS. DIMENSIONING ACCORDING TO STRUCTURAL ENGINEERING REQUIREMENTS.



Fig. 114

The top and bottom edge profiles (2 mm thick) must be pre-bent. Only sliding line fastenings are allowed (no point fastenings). The straight ends and joints of the exterior panels must likewise be edged. (U-profile, H-profile).

RADIUS AT LEAST 3 m

$F1 \leq 120 \text{ mm}$

$F2 \leq 40 \text{ mm}$

$B \geq 1300 \text{ mm} = \text{Length of element}$

$P \geq 28 \text{ mm Depth of profile}$

Attention must be paid to the drainage of the bottom profile!

| Panel thickness mm | Height of railing* |
|--------------------|--|
| 6 mm | $H = 900-1100 \text{ mm} = \text{maximum fastening spacing}$ |
| A | $\leq 1000 \text{ mm}$ |

Table 19

*THE HEIGHT OF THE RAILING MUST COMPLY WITH THE LOCAL BUILDING REGULATIONS. E.G. OIB DIRECTIVE 4 - USE AND ACCESSIBILITY. THE HEIGHT OF THE RAILING MUST BE AT LEAST 1000 mm; STARTING FROM A HEIGHT OF FALL WITH MORE THAN 12 m, MEASURED FROM THE BASE, MUST BE MINIMUM 110 cm.

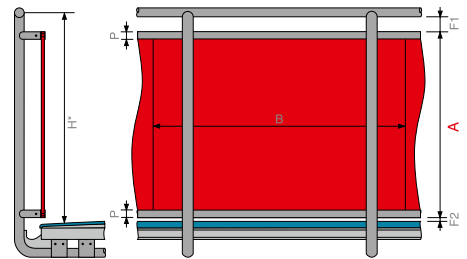

Fig. 115

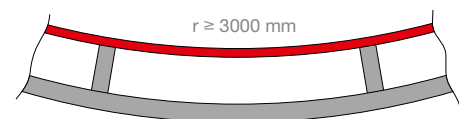

Fig. 116

Balcony partition wall

GENERAL INFORMATION

Dividing walls made from Max Compact Exterior F-quality panels are used to protect individual areas in long balcony-complexes or in access-balcony. The screens are standing vertically to the Building walls and are mounted in several ways like balcony claddings.

The height is maximum from the top of the balcony floor to the ceiling of the next level. Like for the railing-subconstruction there is a difference between the fixing:

- Fixing on end-to-end profiles
- Fixing on brackets

The substructure made from hollow-profile has to be realized according to the structural analysis and to be fixed on the reinforced-concrete plates with per-

mitted dowels or with other mounting-parts. The profiles have to function as a statically line-bearing. The fixing of the Max Compact Exterior F-quality panels has to be done with the same fastenings like on railing-panels. The screens have to be fixed with minimum 3 fastening points on each side.

$F \geq 8 \text{ mm}$
 $20 \text{ mm} \leq G \leq 30 \text{ mm}$

Projecting ends E:
 for 6 mm panels $20 \text{ mm} \leq E \leq 120 \text{ mm}$
 for 8 mm panels $20 \text{ mm} \leq E \leq 200 \text{ mm}$
 for 10 mm panels $20 \text{ mm} \leq E \leq 250 \text{ mm}$

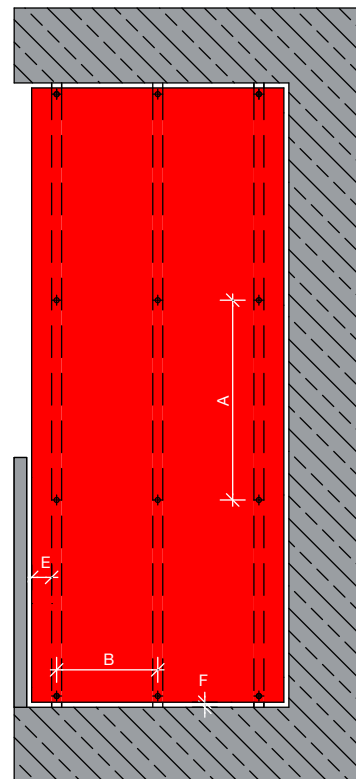

VARIANT 1

Fig. 117

TABLE FOR LOAD ON SINGLE SPAN/WIND LOAD*
 MAX COMPACT EXTERIOR PANELS RIVETED ON ALUMINIUM SUBSTRUCTURE

| PANEL THICKNESS | 6 mm | | 8 mm | | 10 mm | |
|-----------------|----------------|------------|------------|------------|------------|------------|
| | LOAD q (kN/m²) | MAX B (mm) | MAX A (mm) | MAX B (mm) | MAX A (mm) | MAX B (mm) |

GERMANY/AUSTRIA/SWITZERLAND

| | | | | | | |
|------|-----|-----|-----|-----|-----|-----|
| 0.50 | 600 | 600 | 700 | 700 | 800 | 800 |
| 1.00 | 600 | 431 | 700 | 539 | 800 | 551 |
| 1.50 | 600 | 311 | 700 | 373 | 800 | 455 |
| 2.00 | 537 | 261 | 700 | 280 | 800 | 337 |

Values acc. to DIN 1055-T4 or DIN 18516 or ÖNORM B 4014-1,2 or EN 1991-1-4 or SIA-Norm 261 and permit Z 10.3-712

Table 20

TABLE FOR LOAD ON DOUBLE SPAN/WIND LOAD*
 MAX COMPACT EXTERIOR PANELS RIVETED ON ALUMINIUM SUBSTRUCTURE

| PANEL THICKNESS | 6 mm | | 8 mm | | 10 mm | |
|-----------------|----------------|------------|------------|------------|------------|------------|
| | LOAD q (kN/m²) | MAX B (mm) | MAX A (mm) | MAX B (mm) | MAX A (mm) | MAX B (mm) |

GERMANY/AUSTRIA/SWITZERLAND

| | | | | | | |
|------|-----|-----|-----|-----|-----|-----|
| 0.50 | 600 | 600 | 700 | 700 | 800 | 800 |
| 1.00 | 600 | 373 | 700 | 400 | 800 | 420 |
| 1.50 | 600 | 249 | 700 | 320 | 800 | 280 |
| 2.00 | 537 | 208 | 700 | 240 | 800 | 210 |

Values acc. to DIN 1055-T4 or DIN 18516 or ÖNORM B 4014-1,2 or EN 1991-1-4 or SIA-Norm 261 and permit Z 10.3-712

Table 21

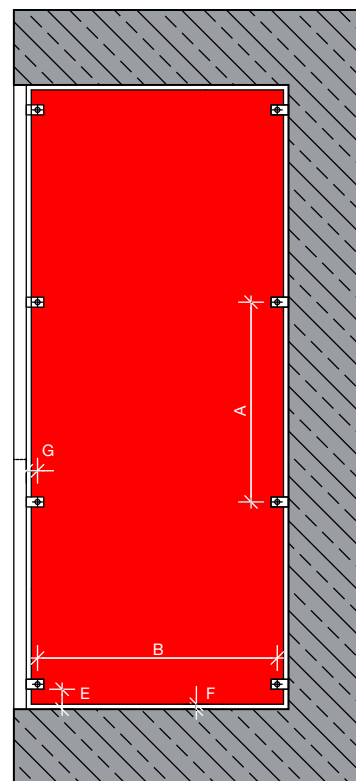

VARIANT 2

Fig. 118

* DIMENSION TABLES FOR THE WIND LOAD RANGE FROM 0.3 KN/M² TO 2.6 KN/M² ARE AVAILABLE UPON REQUEST FROM THE FUNDERMAX SUPPORT TEAM.



Fig. 119



Fig. 120



Fig. 121



Fig. 122



Fig. 123



Podio (Max Compact Exterior) Balcony Floor Panel

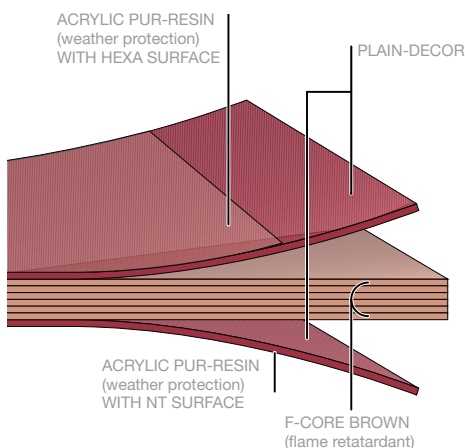

Fig. 124



SURFACE HEXA

Fig. 125



STRUCTURE OF BALCONY FLOOR PANEL

Fig. 126

MATERIAL DESCRIPTION

The Podio (Max Compact Exterior) balcony floor panel is a high-quality construction product that is perfect for permanent use on balconies, loggias, staircases, landings and the like because of its anti-slip hexagon surface among other things.

Max Compact Exterior panels are duromer high-pressure laminates (HPL) conforming to EN 438-6 Type EDF with additional, extremely effective, weather protection. This weather protection is made from double hardened Acrylic-Polyurethan-resins. They are produced in lamination presses at great pressure and high temperature Max Compact Exterior panels carry the necessary CE label for applications in the construction sector.

SURFACE

Front side: NH - Hexa
Rear side: NT

DECORS

two-sided; see our valid Max Compact Exterior range of decors or at www.fundermax.at

ANTI-SLIP CLASS

R10 in accordance with DIN 51130

FORMAT

on request or on our website - www.fundermax.at - you may find the up-to-date information.

XL = 4100 x 1854 mm = 7.6 m²
Tolerances +10 - 0 mm (EN 438-6, 5.3)

Panel formats are production formats. If exact dimensions and angles are necessary, we recommend an all-sided blank. Depending on the method of trimming, net size is reduced by ca. 10 mm.

CORE

F-Quality, flame-retardant, colour brown

THICKNESS

6.0 - 20.0 mm
(depending on the static requirement)

| Thicknesses | Tolerances (EN 438-6.5.3) |
|----------------|------------------------------|
| 6.0 - 7.9 mm | ±0.4 mm |
| 8.0 - 11.9 mm | ±0.5 mm |
| 12.0 - 15.9 mm | ±0.6 mm |
| 16.0 - 20.0 mm | ±0.7 mm |

NOTE

FOR HORIZONTAL USE ONLY.

BASICS

Podio (Max Compact Exterior) balcony floor panels can be screwed or glued to a variety of suitable substructures with an incline.

The substrate and substructure must be sufficiently load-bearing. A functioning rear ventilation with a minimum distance of 25 mm from the substrate must be ensured. Grass, ballast, gravel or other moisture-storing surfaces are unsuitable! Ensure sufficient drainage of the substrate.

During construction and installation it is important to ensure that the material is not subjected to accumulating moisture. This means that the panels must always be able to dry off. Generally, balconies should be provided with an incline of 1.5 - 2%.

Due to the material properties of Max Compact Exterior balcony floor panels, suitable room for expansion must be taken into account. The joints between panels must be at least 8 mm wide. For substructures that run parallel to joints,

the gaps between the panels must always be placed above a substructure, and can additionally be held at the same height by suitable joints, such as tongue and groove joints for example, that allow the appropriate room for expansion. Elastic intermediate layers between the panel and the substructure, as well as between parts of the subconstruction, that allow a tolerance of greater than ± 0.5 mm are absolutely to be avoided. When installing Max Compact Exterior balcony floor panels on a wooden substructure with screws, fixed and sliding points must be formed. Pay attention to the advises on pages 50/51. The wood-substructure has to be constructed according to the national standard specifications (wood moisture $15\% \pm 3$). **Pay attention to a qualified structural or chemical wood preservation!** Suitable rear-ventilation is to be ensured so that the panels can be conditioned on both sides. The panels should not be allowed to rest fully on the ground below. The substructure is to be protected against corrosion regardless of the material or system used.

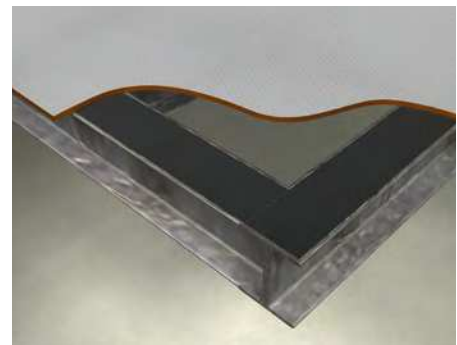
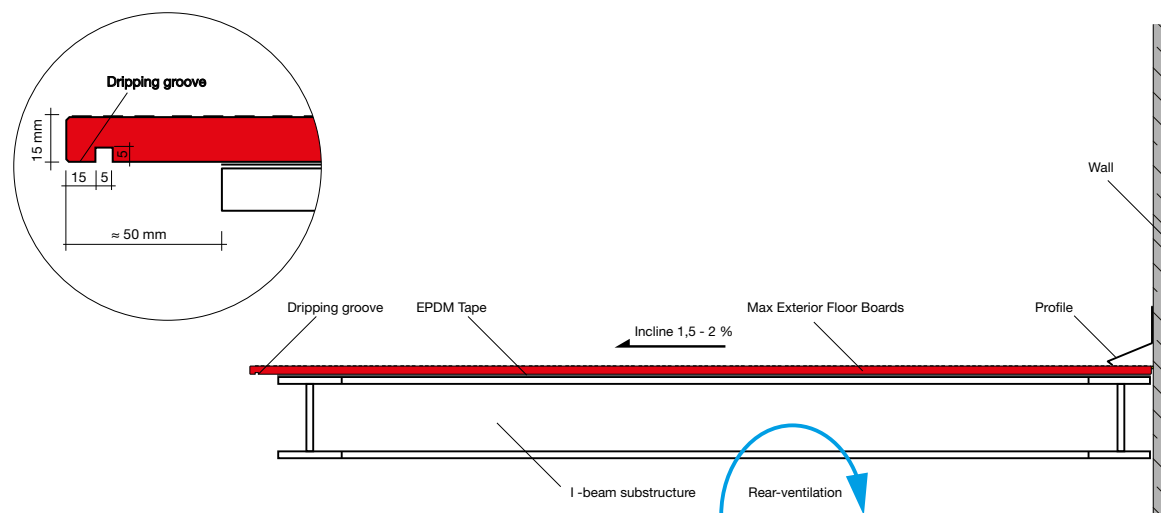

Fig. 127



VERTICAL SECTION: PRINCIPLE OF VENTILATION AND INCLINE

Fig. 128

Guidelines for laying the Podio floor panels

FIXING DISTANCES

The substructure battens must have a width of ≥ 60 mm, in the joint area ≥ 100 mm.

EDGE DISTANCES

For installation with screws, the edge distance can be 20 - 100 mm.

PANEL JOINTS AND JOINT FORMATION

The joints must be at least 8 mm wide so that changes in size can take place without hindrance. The joints are filled with a permanently elastic sealant. A permanently elastic rubber band can also be placed in the groove (marked yellow in the drawings and 3D animation).

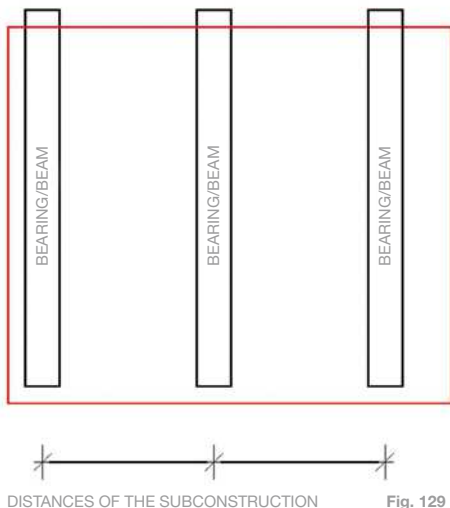

| MAX. ALLOWABLE DEFLECTION OF 1/300 | TRAFFIC LOAD kN/m ² | | |
|------------------------------------|--------------------------------|-----|-----|
| | 3.0 | 4.0 | 5.0 |
| PANEL THICKNESS | SUPPORT SPACING IN mm | | |
| | A \leq 500 | | |
| 12 mm | X | - | - |
| 16 mm | X | X | X |
| 18 mm | X | X | X |
| 20 mm | X | X | X |
| | A \leq 600 | | |
| 16 mm | X | X | - |
| 18 mm | X | X | X |
| 20 mm | X | X | X |
| | A \leq 800 | | |
| 20 mm | X | X | - |

X = ALLOWABLE

Table 22

PLEASE NOTE THE MAXIMUM SUPPORT SPACING IN ACCORDANCE WITH THE GENERAL BUILDING INSPECTORATE APPROVAL Z-50.4-377 FOR APPLICATIONS REQUIRING APPROVAL IN GERMANY.

THE CURRENT VERSION OF THE APPROVAL CAN BE FOUND ON THE INTERNET AT WWW.FUNDERMAX.AT.



BALCONY FLOOR PANEL SITE IN ST. VEIT/GLAN, AUSTRIA

Fig. 130



SUBSTRUCTURE/BEAMS

Fig. 131



INCLINE AND PANEL JOINTS

Fig. 132



EXTERNAL CORNER AND EDGES

Fig. 133



INCLINE

Fig. 134



Mounting of Podio (Max Compact Exterior) balcony floor panels mechanical non visible fixed

FIXED POINT

Fixed points serve the uniform distribution (halving) of the swelling and shrinkage movements. The drill hole diameter of the Max Compact Exterior panel has to be made approx. one flight depth lower than the screw diameter.

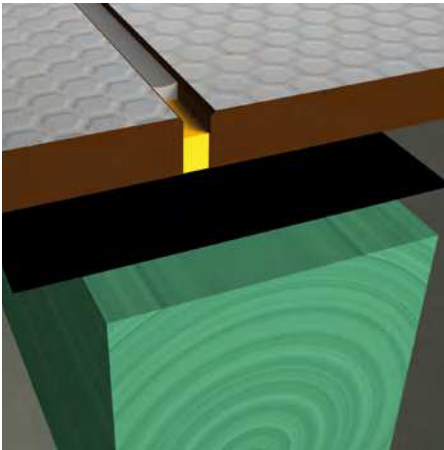
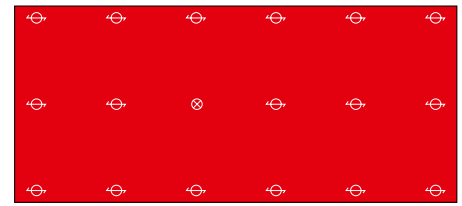

Fig. 135

SLIDING POINT

Based on how much space is needed for expansion, the diameter of the drill hole in the substructure should be that much larger than the diameter of the fastening means. The diameter of the shank of the fastening means plus 2 mm per meter of paneling from the fixed point. The fastening means is set such that the panel can move. Screws must not be overtightened. Do not use counter sunk screws. The center of the drill hole in the substructure must coincide with the center of the drill hole in the Max Compact Exterior panel. Suitable drilling aids (drilling equipment) should be used. The fastenings should be put in place starting from the middle of the panel outwards.



DOUBLE SPAN PANEL

Fig. 136

⊗ FIXED POINT ⊕ SLIDING POINT



SINGLE SPAN PANEL

Fig. 137

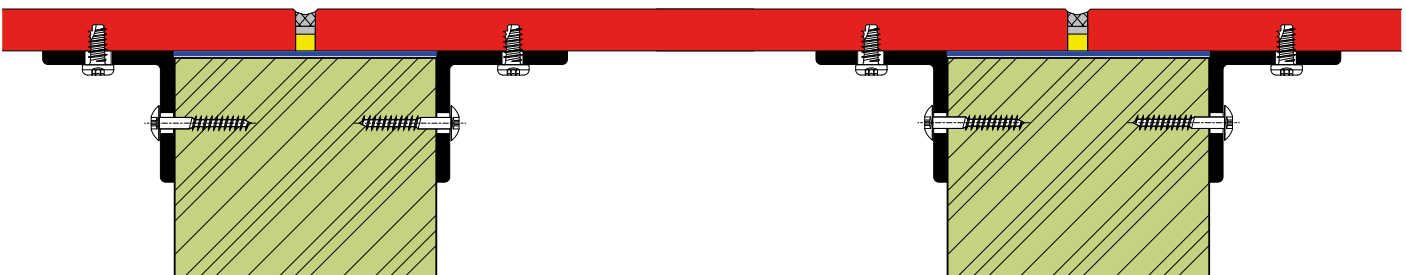

BALCONY FLOOR PANEL INVISIBLE FIXED (SCREWED) ON WOODEN BEAM

Fig. 138

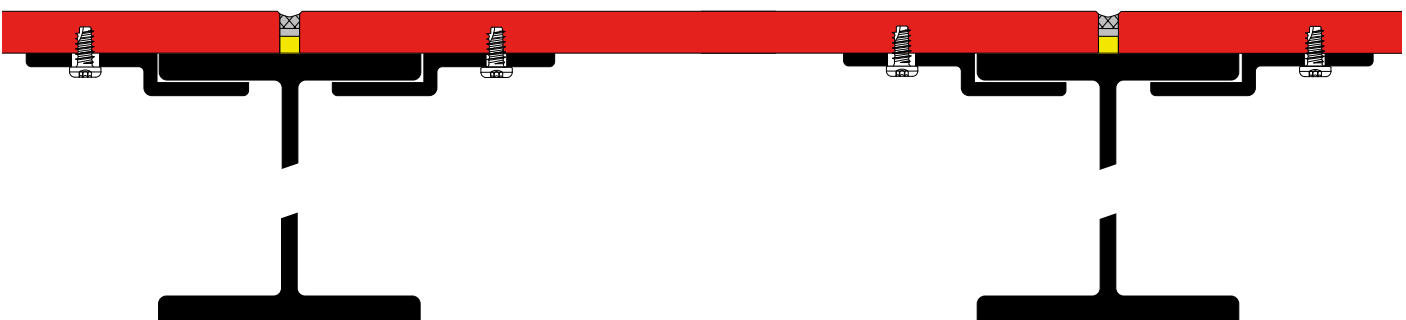

BALCONY FLOOR PANEL INVISIBLE FIXED (SCREWED) ON STEEL BEAM

Fig. 139

Mounting of Podio (Max Compact Exterior) balcony floor panels with gluing system

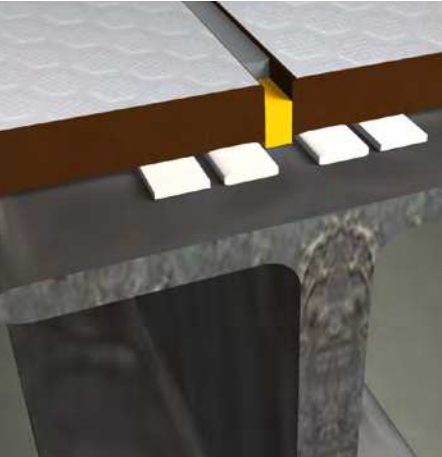

Fig. 140

GLUING

An alternative to mechanical fastening is gluing the Max Compact Exterior balcony floor panel with the gluing system Propart or Innotec which were specially developed for this purpose. This works on conventional planed metal substructures.

Note:

Ensure that the Max Compact Exterior (balcony floor-) panel is not subjected stress when gluing it into place. When installing the Max Compact Exterior panel, be sure to take the expansion and shrinkage behavior into account.

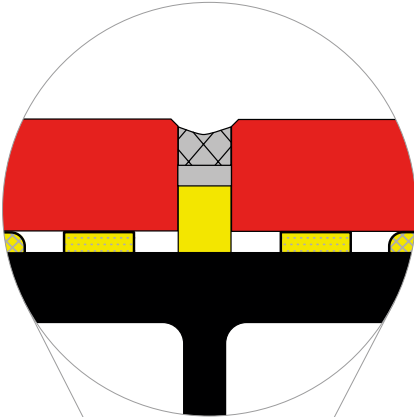

BALCONY FLOOR PANEL WITH SECRET FIXING (GLUED) ON STEEL BEAM

Fig. 141



General information



Fig. 142

In order to meet the current architectural demands, trend-setting design variations allow the use of a product for both the facade as well as the roof. Design and planning for these constructions is to be carried out with the utmost care, particularly regarding the detail connections. Supporting structures in conjunction with decorative panel materials allow both the architect as well as the builders to provide the object with a special, independent character. By reducing the external shell to the essential optical fields, the gaze of the viewer is consciously directed by the shape and colour. Of course nearly all the advantages of the non-bearing, rear-ventilated facade can be applied to the roof: design, engineering, and cost-efficiency.

CONSTRUCTION DESIGN

Max Compact Exterior can be used for ventilated roof structures taking into account the following points: Minimum roof pitch 6°.

FIRE REQUIREMENTS

Please note that the fire requirements for the project must be determined and adhered to taking the regional building regulations into consideration.

VERIFICATION OF STABILITY

This must be determined for all applications in the facade and roof areas for each project and must be performed under consideration of the regional building regulations.

WIND LOAD

Snow and wind loads are to be taken into account when determining the proper fasteners and spacing of the substructure.

For Austria:

Eurocode ÖNORM EN 1991-1-4

For Germany: DIN EN 1991-1-4

VENTILATION

Ventilation between the subroof and the panel (height of the counter battens) depends on the rafter length and roof pitch.

SUBROOF

The subroof must be designed and constructed as a seamless water transport layer for all roof pitches and structural variations. The drainage takes place in the substructure of the facade.

SUBSTRUCTURE

Depending on the design, the construction consists of horizontal or vertical support profiles and counter battens sufficiently fixed mechanically to the counter battens. It is not allowed to use wood-substructures for roof-claddings.

SUPPORT BATTENS (-profiles)

Vertical or horizontal metal support profiles serve as support battens; single profiles serve as middle supports, and in the joint areas double profiles are used which also serve a drainage function.

COMPONENT CONNECTIONS

For example such as skylights, ventilation and exhaust pipes, etc. are to be made with the appropriate sheet metal flashing. Panel material - technical data: Product classification B-s2, d0 according to EN 13501-1

PANEL INSTALLATION

The roof panels are fastened to the support profiles with stainless steel blind rivets. The fastening distances are to be determined for each object individually.

FIXED POINT, SLIDING POINTS

The fastening of the Max Compact Exterior panel to the support profiles requires sliding and fixed point installation.

DRILL HOLES IN THE PANEL

The drill hole diameter for the fixed point has to be 5.1 mm, and for the sliding point 8.5 mm or as required. The rivets must be centered and put in place with a flexible mouthpiece.

DRILL HOLES IN THE SUPPORT PROFILE

The drill holes in the support profile should be 5.1 mm in diameter and aligned with the drill holes in the panel.

FIXING THE SUPPORT PROFILE

Depending on the design of the counter battens, the support profile is fixed in place with suitable screws or rivets.

SOILING

Avoid soiling though:

- Construction measures
- Higher elevated roof surfaces
- separate drainage.

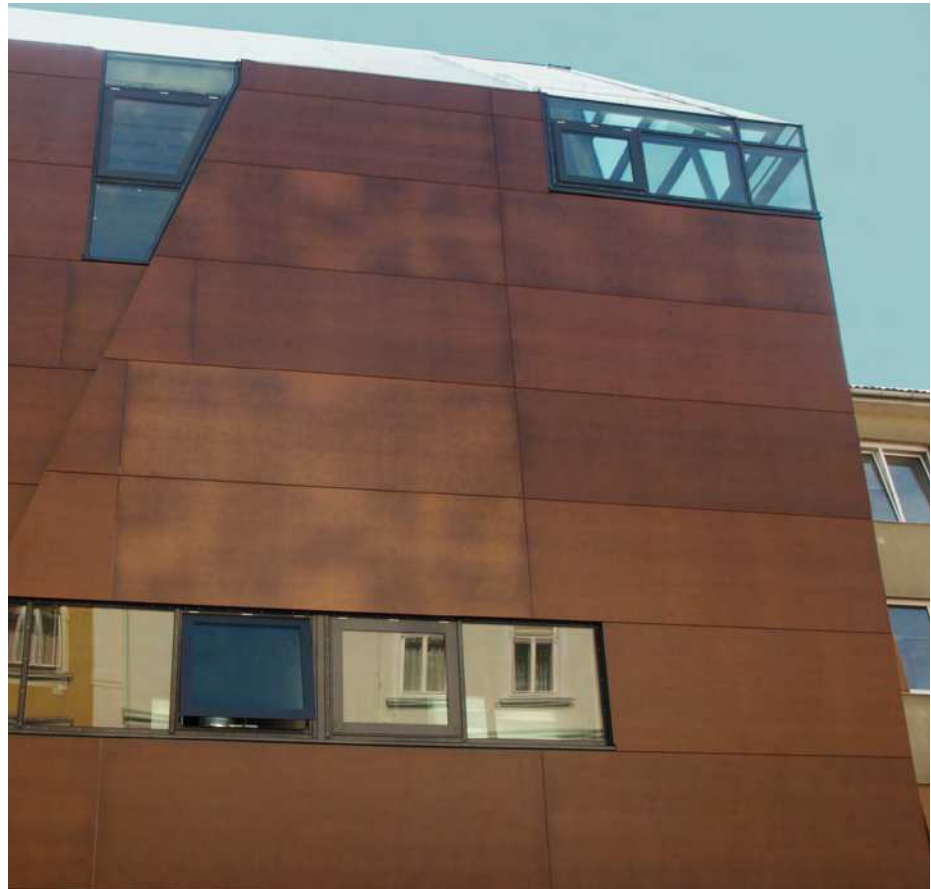
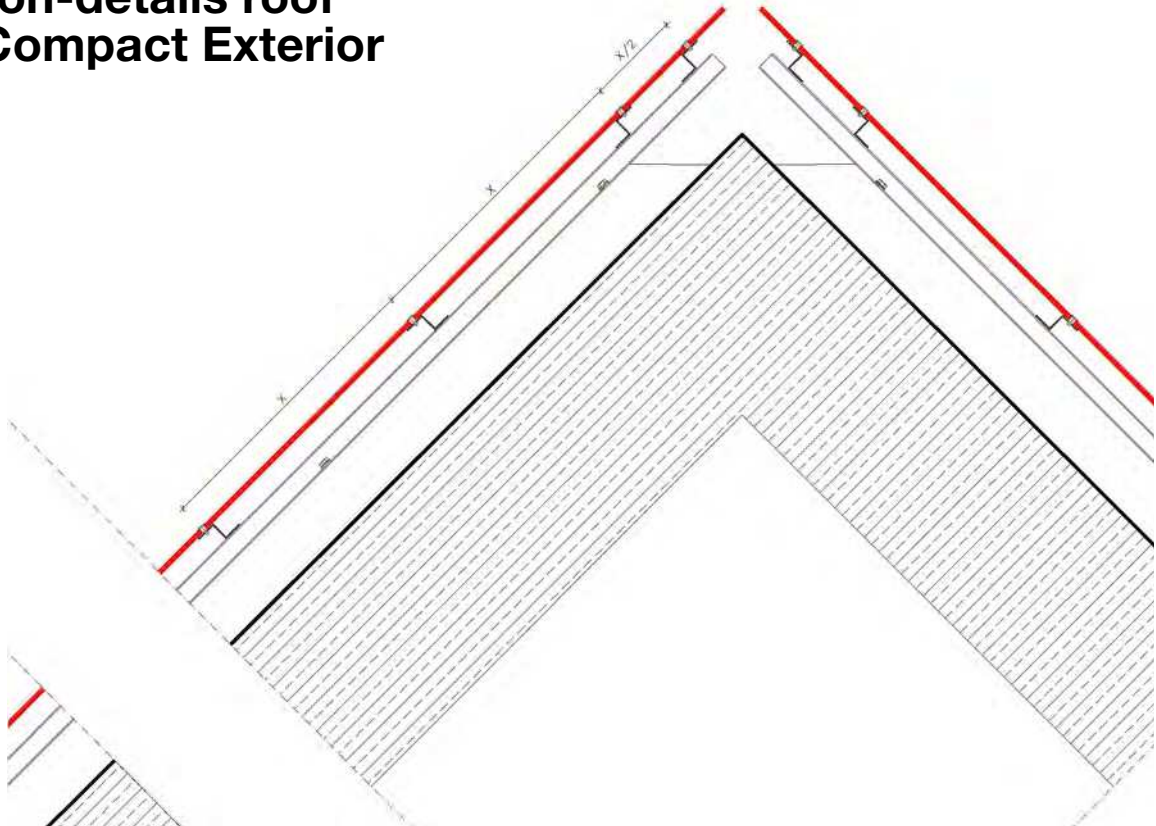

Fig. 143

Construction-details roof with Max Compact Exterior Panels



VERTICAL SECTION OF THE APEX OF THE ROOF-STRUCTURE

Fig. 144

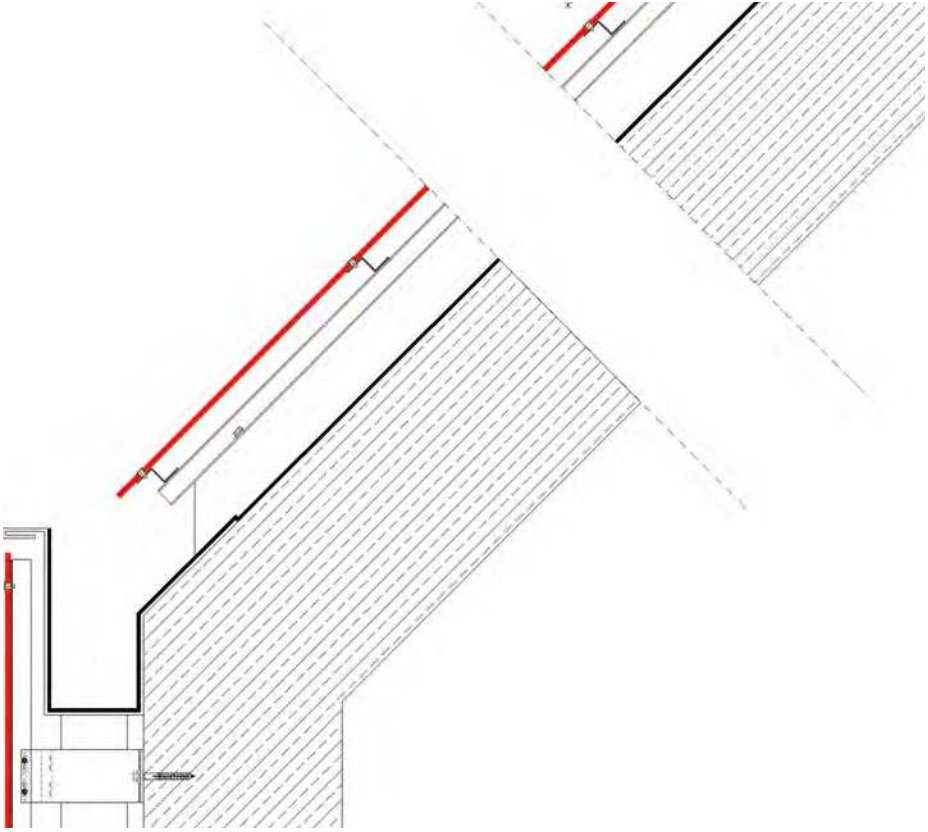

VERTICAL SECTION OF THE EAVE OF THE ROOF-STRUCTURE

Fig. 145

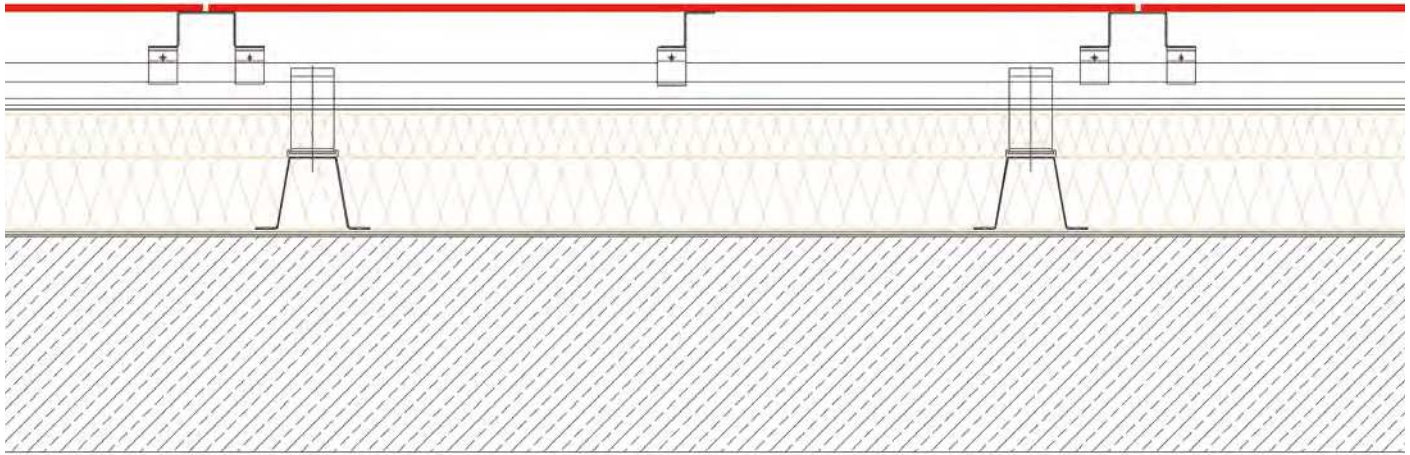

VERTICAL SECTION OF THE STRUCTURE OF THE ROOF

Fig. 146

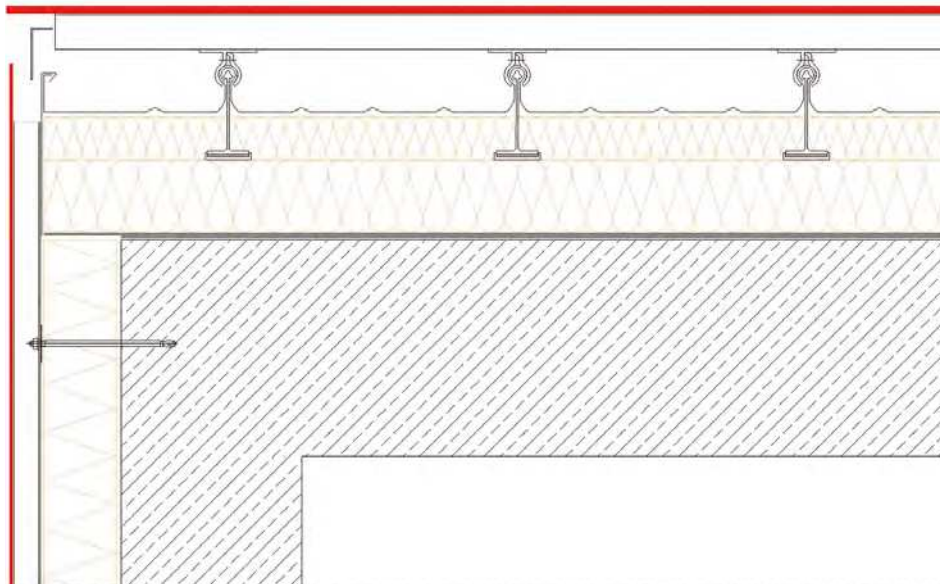

VERTICAL SECTION OF BARGEBOARD

Fig. 147





Fig. 148

| MAX COMPACT EXTERIOR | | |
|--------------------------|-----------------------|-----------------------|
| PANEL THICKNESS IN mm | PANEL LENGTH IN mm | STRAIN L/300 IN mm |
| 8 | ≤ 1000 | 3.0 |
| 10 | ≤ 1100 | 3.6 |
| 12 | ≤ 1200 | 3.6 |
| 15 | ≤ 1300 | 3.2 |

Table 23

GENERAL POLICIES

Max Compact Exterior panels can be used externally for sun shade applications at a materials strength of 8 to 15 mm.

The following recommendations should be observed.

The minimum width of the element should not go under a limit of 100 mm. Every element should be secured on at least 2 sides with 2 fasteners per side. Edge distances of the fasteners >20 mm. Installation of the elements must occur in a stress-free manner using fixed and floating points.

The elements must be mounted to adjacent component parts using an expansion joint of >8 mm.

Ventilation of the elements must be guaranteed at all times. Full-surface overlays or adhesion is damaging to the material.

The most common application of Max Compact Exterior panels as sun shades is the horizontal, mostly slightly angled assembly of elements in front of windows. The maximum number of fastener locations depends on the panel thickness, wind load and the fastener angle.

Suppliers of the following design possibilities you will find on page 91.

MAX. FASTENER DISTANCES FOR SUN SHADES

These fastener distances are valid for low wind loads. In case of greater wind loads, the fastener distances must be determined from the specific application and materials. In case the panels are framed or have edgewise or rearward metal profiles, the fastener distances specified below may be increased in accordance with the additional rigidity desired.

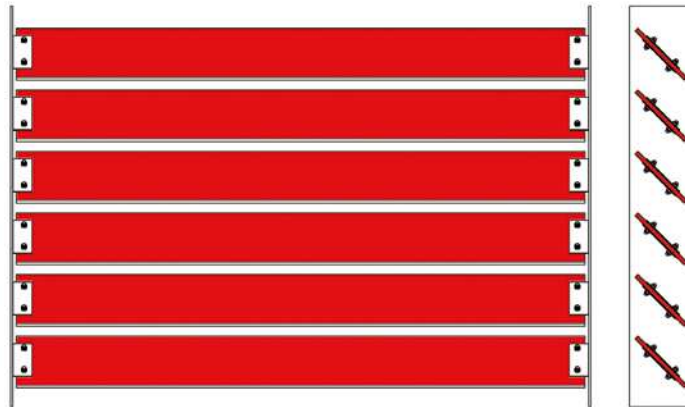

Fig. 149



Fig. 150



Fig. 151



Sunblinds
span width ≤ 1300 mm

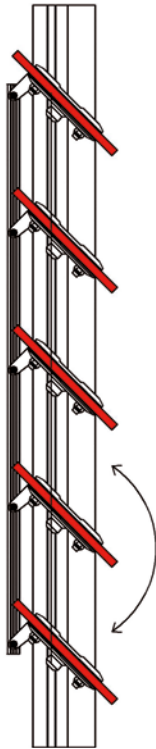

Fig. 152

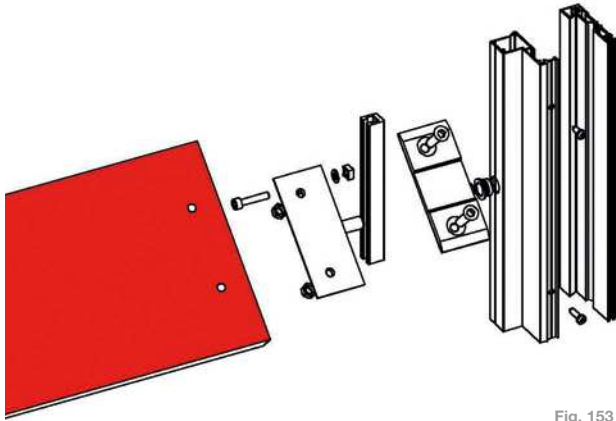

Fig. 153

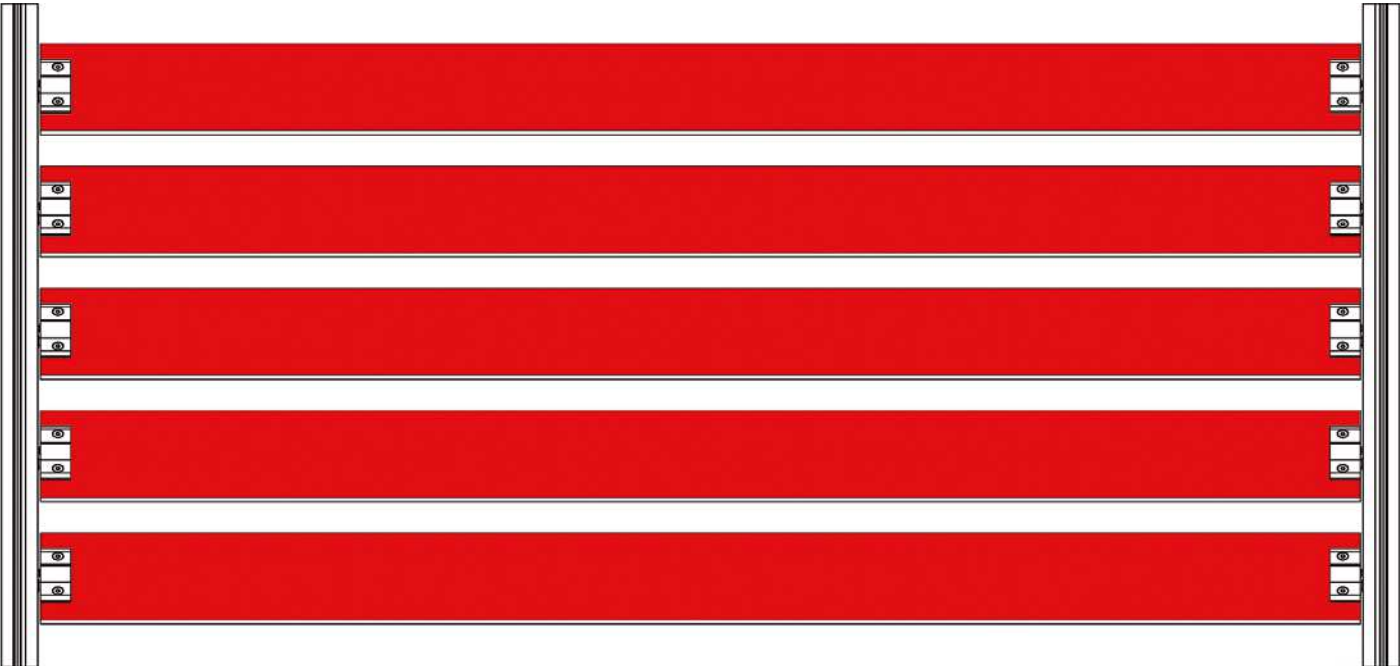

Fig. 154

Supported sunblinds span width ≥ 1300 mm

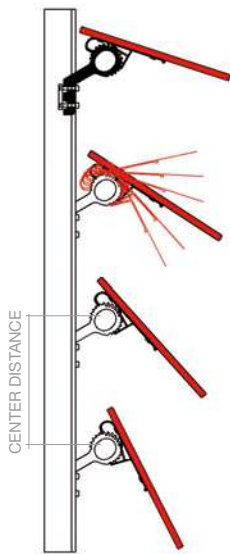

Fig. 155

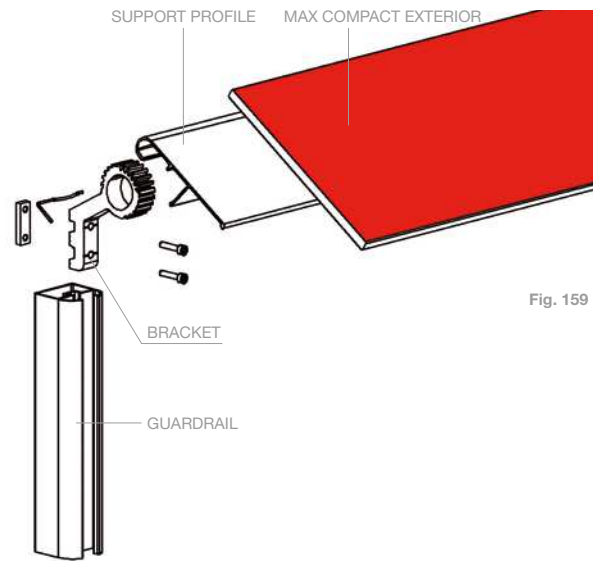

Fig. 159

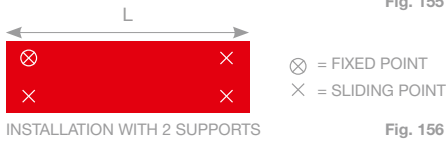

Fig. 156



Fig. 157

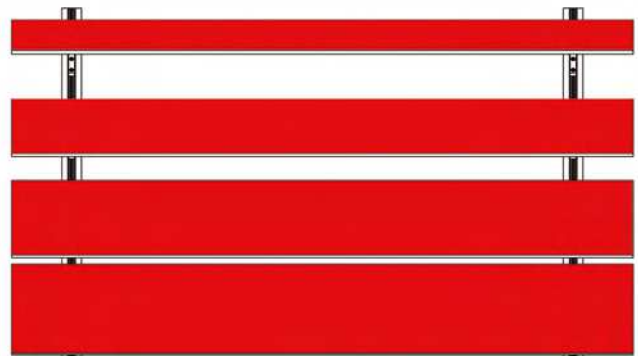

Fig. 158

Mounting details

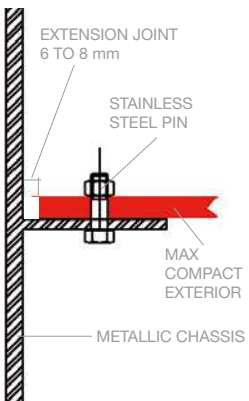

Fig. 160

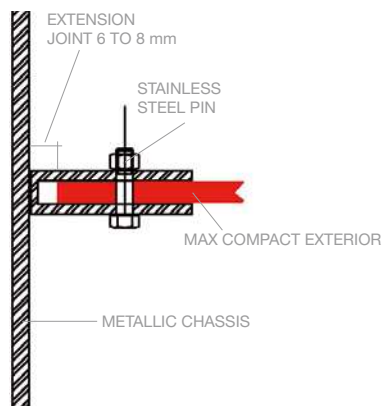

Fig. 161

Window shutters



Fig. 162



Fig. 163

FASTENING HINGE JOINTS

When fastening hinge joints, the Max Compact Exterior panels should always be mounted on a metal frame. Using a minimum of three hinge joints per element is recommended. Aluminium profile systems or powder-coated steel frame profiles can be used as a metal frame, assuming the frame has sufficient load bearing capacity. The Max Compact

Exterior panel must be mounted with a sufficient tolerance of at least 4 mm per side. UV and weatherproof sealing bands (e.g., EPDM) are to be incorporated between the profile and the panel to avoid noise generated by the panel hitting the building facade. Using adhesives to fasten the Max Compact Exterior panels is not permitted. To drain the frame, boreholing in the lower horizontal frame profile must be provided.

For **sliding elements**, the panels are likewise to be mounted on a metal frame. Mounting of the sliding elements occurs via rollers that must be mounted to the profile frame. The sliding metal fittings must have sufficient load bearing capacity. Please note the maximum fastening distances in the following tables.

MOUNTING IN A RACK. FASTENING SPACINGS.

| MAX COMPACT EXTERIOR | | |
|-----------------------|------------------|------------------|
| PANEL THICKNESS IN mm | L = LENGTH IN mm | H = HEIGHT IN mm |
| 6 | ≤ 500 | ≤ 500 |
| 8 | ≤ 600 | ≤ 600 |
| 10 | ≤ 600 | ≤ 600 |
| 12 | ≤ 600 | ≤ 600 |

Table 24

SUBCONSTRUCTION

Austria

ALLFACE Befestigungstechnologie GmbH & Co KG
Aredstraße 29/Büro 222,
A-2544 Leobersdorf
Tel.: +43 2256/625 18
Fax: +43 2256/625 18 18
E-mail: office@allface.com
www.allface.com

Hilti EUROFOX GmbH
Gewerbepark 10
A-2810 Lanzenkirchen
Tel.: +43 2627 42400-0
Fax: +43 2627 42400-40
www.eurofox.com

Slavonia Baubedarf GmbH
Hauffgasse 3-5
A-1110 Wien
Tel.: +43 1 / 769 69 29
Fax: +43 1 / 769 69 27
www.slavonia.com

Germany

BWM
Dübel und Montagetechnik GmbH
Ernst-Mey-Str. 1
D-70771 Leinfelden-Echterdingen
Tel.: +49 711 / 90 313-0
Fax: +49 711 / 90 313-20
www.bwm.de

Systea DWS Pohl GmbH
Margarete-Steiff-Str. 6
D-24558 Henstedt-Ulzburg
Tel.: +49 4193 / 99 11-40
Fax: +49 4193 / 99 11-49
www.pohl.net

NAUTH SL Fassadentechnik GmbH
Weinstr. 68 b
D-76887 Bad Bergzabern
Tel.: +49 6343 7003-0
Fax: +49 6343 7003-20
www.nauth.de

France

L.R ETANCO
38/40 Rue des Cormiers – BP 21
78401 CHATOU CEDEX (France)
Phone: +33 1 3480 5288
Fax: +33 1 3480 5240
www.etanco.fr

USA

ECCOCLADDING
420 N Cedros Avenue, Suite 103
US-Solana Beach, CA 92075
+1 888 826 8453
www.ecocladding.com

NVELOPE,
BRAND OF SFS GROUP USA
1045 Spring Street
US-Wyomissing PA 19610
+1 800 234 4533
www.nvelope.us

Q-VENT AMERICA
US-4828 S 16-th St |
AZ 85040 PHOENIX
+1 651 447 6521
www.q-vent.eu

MONARCH METAL FABRICATION
1700 Ocean Ave Ste 2
US-Ronkonkoma, NY 11779
+1 631 750 3000
www.monarchmetal.com

**FASTENINGS
(mechanical)**

Austria

EJOT AUSTRIA GmbH
Grazer Vorstadt 146
A-8570 Voitsberg
phone +43 3142 2 76 00-0
fax +43 3142 2 76 00-30
E-mail: info@ejot.at, www.ejot.at

Germany

MBE GmbH
Siemensstraße 1
D-58706 Menden
Tel.: +49 2373 17430-0
Fax: +49 2373 17430-11
www.mbe-gmbh.de

SFS intec GmbH, Division
Construction
In den Schwarzwiesen 2
D-61440 Oberursel
Tel.: +49 6171 7002-0
Fax: +49 6171 7002-55
www.sfsintec.de

KEIL Werkzeugfabrik
Karl Eischeid GmbH
Postfach 1158
D-51751 Engelskirchen-Loope
Im Auel 42
D-51766 Engelskirchen-Loope
Tel.: +49 2263 8070
Fax: +49 2263 807333
www.keil-werkzeuge.com

Switzerland

SFS intec AG (Headquarters)
Rosenbergsaustasse 10
CH-9435 Heerbrugg
Tel.: +41 71 727 62 62
Fax: +41 71 727 53 07
E-Mail: gmi.heerbrugg@sfsintec.biz
www.sfsintec.biz

Koenig Verbindungstechnik AG
Lagerstrasse 8
CH-8953 Dietikon
Tel.: +41 1 743 33 33
Fax: +41 1 740 65 66
www.kvt.ch

**FASTENINGS
(glueing)**

Austria

Fassadenklebetechnik Klug GmbH
Zentrale
Julius-Tandler-Platz 6/15
A-1090 Wien
Tel.: +43 676 7271724
E-mail:
r.klug@fassadenklebetechnik.at
office@fassadenklebetechnik.at
www.fassadenklebetechnik.at

PROPART Handels GmbH
Lauchenholz 28
A-9123 St. Primus
Tel.: +43 4239 40 300
Fax: +43 4239 40 300-20
www.fassaden-kleben.at

Innotec Industries Vertriebs GmbH
Lofererstrasse 83
A-6322 Kirchbichl
Tel.: +43 53 32 70 800
Fax: +43 53 32 70 8000-809
E-mail: info@innotec.at
www.fassadenverklebung.at

Germany

Innotec GmbH & Co. KG
Kamper Strasse 54
D-47445 Moers
Tel.: +49 28 41-78670
Fax: +49 28 41 -78680
E-mail: verkauf@innotec-online.de
Technische Fragen:
support@innotec-online.de

MBE GmbH Siemensstraße 1
D-58706 Menden
Tel.: +49 2373 17430-0 Fax:
+49 2373 17430-11
www.mbe-gmbh.de

SIKA Deutschland GmbH
Stuttgarter Straße 117
D-72574 Bad Urach
Tel.: +49 711 80090

Switzerland

SIKA Chemie GmbH
Tüffenwies 16-22
CH-8048 Zürich
Tel.: +41 (0) 58 / 436 40 40
Fax: +41 (0) 58 / 270 52 39

Further suppliers of glues

(There is no official certificate available for these suppliers of glues in Germany. You must clear technical certificates and processing recommendations with the supplier before mounting!)

PROFILES/ACCESSORIES
Austria

Protektor Bauprofile GmbH
Hosnedlgasse 12
A-1220 Wien
Tel.: +43 1 259 45 00-0
Fax: +43 1 259 45 00-19
www.protektor.com

Germany

Protektorwerk
Florenz Maisch GmbH & Co.KG
Viktoriastraße 58
D-76571 Gaggenau
Tel.: +49 7225 977-0
Fax: +49 7225 977-111
www.protektor.com

France

PROTEKTOR S.A. BATI-PROFIL
Rue Pasteur Prolongée
F-94400 Vitry sur Seine
Tel.: +33 1 55 53 17 50
Fax: +33 1 55 53 17 40

GLASS MOUNTING BRACKETS
Austria

Fa. Längle, A-6840 Götzis,
www.langleglas.com

Fa. Schmidtschläger, A-1070 Wien,
www.schmidtschlaeger.at

Fa. Hueck, A-1230 Wien,
www.hueck.at

Germany

Fa. Pauli, D-51545 Waldbröl,
www.pauli.de

Fa. SWS, D-51545 Waldbröl,
www.sws-gmbh.de

Fa. QTEC, D-06749 Bitterfeld,
www.qtec-gmbh.de

SUNBLIND-ELEMENTS
France

SAB International
19 ZA Saint Mathieu
F-28320 Gallardon
Tel.: +33 2 37 90 46 46
Fax: +33 2 37 90 20 10
E-Mail: contact@sab-inter.com
www.sab-inter.com

EPDM BANDS
Austria

Euphalt Handels-GesmbH
Pummererstraße 17
4020 Linz
Tel.: +43 732 77 31 68 0
Fax: +43 732 77 31 68 3939
office@euphalt.at
www.euphalt.at

Germany

MBE GmbH
Siemensstraße 1
D-58706 Menden
Tel.: +49 2373 17430-0
Fax: +43 2373 17430-11
www.mbe-gmbh.de

SFS Intec GmbH
In den Schwarzwiesen 2
D-61440 Oberursel
E-Mail:
de.oberursel@sfsintec.biz
www.sfsintec.de

BOSIG Baukunststoffe GmbH
Roland-Schmidt-Straße 1
D-04910 Elsterwerda
Tel.: +49 (0) 3533 700-0
Fax: +49 (0) 3533 700-200
E-Mail: elsterwerda@bosig.de
www.bosig.de

REPAIR-MARKERS (lacquer-pen)
Austria

VOTTELER Lacktechnik GmbH
Malvenstrase 7
A-4600 Wels
Tel.: +43 7242 759-0
Fax: +43 7242 759-113
at.info@votteler.com
www.votteler.com

Germany

Heinrich König & Co. KG
An der Rosenhelle 5
D-61138 Niederdorfelden
Tel.: +49 6101 53 60-0
Fax: +49 6101 53 60-11
info@heinrich-koenig.de
www.heinrich-koenig.de

MBE GmbH
Siemensstrase 1
D-58706 Menden
Tel.: +49 2373 17430-0
Fax: +49 2373 17430-11
www.mbe-gmbh.de

FunderMax assumes no liability for the products of the companies listed regarding the quality and suitability for specific applications.

Exclusion of Liability

The information made available in this document are exclusively for purposes of general information. Not all of the systems mentioned and shown in this document are appropriate or suitable for all areas of application. All customers and third parties are obligated to inform themselves thoroughly about FunderMax products, including their suitability for certain purposes. We explicitly recommend that you and other users of this document seek out independent expert advice on adherence to local planning and use requirements, applicable laws, regulations, standards, guidelines and testing standards. FunderMax accepts no liability in connection with the use of this document.

COPYRIGHT

ALL TEXTS, PHOTOGRAPHS, GRAPHICS, AND AUDIO AND VIDEO FILES ARE PROTECTED BY COPYRIGHT LAW AS WELL AS BY FURTHER INTELLECTUAL PROPERTY LAWS AND MAY NOT BE DUPLICATED, ALTERED OR USED ON OTHER WEBSITES FOR PURPOSES OF BUSINESS, ETC.

FunderMax Deutschland GmbH
Industriestrasse 1
D-92442 Wackersdorf
infogermany@fundermax.biz
www.fundermax.de

FunderMax France SARL
3 Cours Albert Thomas
F-69003 Lyon
Tel.: +33(0)4 78 68 28 31
Fax: +33(0)4 78 85 18 56
infofrance@fundermax.biz
www.fundermax.fr

FunderMax India Pvt. Ltd.
No. 13, 1st Floor, 13th Cross
Wilson Garden
IND-560027 Bangalore
Tel.: +91 80 4112 7053
Fax: +91 80 4112 7053
officeindia@fundermax.biz
www.fundermax.at

FunderMax Italia S.R.L.
Viale Venezia 22
I-33052 Cervignano del Friuli
infoitaly@fundermax.biz
www.fundermax.it

FunderMax North America, Inc.
2015 Ayrslay Town Blvd. Suite 202
US-Charlotte, NC 28273
Tel.: +1 980 299 0035
Fax: +1 704 280 8301
office.america@fundermax.biz
www.fundermax.at

FunderMax Polska Sp. z o.o.
ul. Rybitwy 12
PL-30722 Kraków
Tel.: +48-12-65 34 528
Fax: +48-12-65 70 545
infopoland@fundermax.biz

FunderMax Swiss AG
Industriestrasse 38
CH-5314 Kleindöttingen
Tel.: +41 (0)56-268 83 11
Fax: +41 (0)56-268 83 10
infoswiss@fundermax.biz
www.fundermax.ch

FunderMax GmbH
Klagenfurter Straße 87-89, A-9300 St. Veit/Glan
T +43 (0) 5/9494-0, F +43 (0) 5/9494-4200
office@fundermax.at, www.fundermax.at