



Terex Calibration and Troubleshooting Manual



TABLE OF CONTENTS

Introduction.....	3
1.1 Overview and Preparation.....	3
2.1 System Self-Test	4
2.2 Display Console Problems	5
2.3 Fault Reporting and Fault Codes	6
2.3.1 Group “A” Fault Codes	7
2.3.2 Group “B” Fault Codes	7
2.3.3 Group “C” Fault Codes	8
2.3.4 Group “D” Fault Codes	8
2.4 “No Fault Code” Problems	9
2.4.1 Anti-Two-Block Alarm (ATB).....	9
2.4.2 Displayed Load or Radius Errors.....	9
3.1 Computer Unit Overview	12
3.2 Computer Unit Layout	12
3.3 Internal Status Indicators.....	13
3.4 Function Kickout Fuse (FUS1)	14
3.5 Replacing the Computer Unit	14
4.1 Display Console Overview	15
4.2 Checking the Display Console.....	15
4.3 Unresponsive Buttons	15
4.4 Connectors.....	16
4.5 Horn.....	16
4.6 Moisture	16
4.7 Replacing the Display Console.....	17
5.1 Calibration Mode.....	18
5.2 Entering the Calibration Mode	19
5.3 Calibration Menus	20
5.4 Calibrating the Extension Zero	22
5.5 Calibrating the Angle Sensor Zero	23
5.6 Calibrating Span of Extension and Angle	24
5.7 Calibrating the Swing Potentiometer	26
5.7.1 Calibrating Swing Direction.....	26
5.7.2 Cranes with Swing Switches.....	27
5.8 Calibrating the Outrigger Position Sensor	28
5.9 After the Calibration Routine	30
6.1 Reeling Drum Overview	31
6.2 Checking the Reeling Drum Cable Layering.....	32
6.3 Sensor Baseplate Assembly	33
6.4 Anti-Two-Block Function Overview.....	35
6.5 Checking the Reeling Drum Cable	35
6.6 Checking the Anti-Two-Block Circuit	35
7.1 WAD/ISS	37
7.2 WAD/ISS Troubleshooting Table.....	38
7.3 Replacing the Swing Sensor	39
7.4 Replacing the Conditioning Box	40

Introduction

The Greer Insight system is an aid to crane operation. The operator must be knowledgeable in safety guidelines, crane capacity information, and the crane manufacturer's specifications.

This manual describes the setup, operation, and maintenance of the system. Read the instructions in this manual.

1.1 Overview and Preparation

This manual provides general information and methods for isolating problems that may happen during operation. Service personnel should have previous training and experience in the procedure for setup and operation of this system. Some problems may require replacing or returning parts to the factory for servicing.

Tools necessary:

- Tool kit consisting of wrenches and screwdrivers (flat and Phillips')
- Digital level accurate to 0.1°
- 150-200 ft tape measure graduated in tenths of a foot
- Digital multimeter

NOTE: Low-cost analog multimeters are not appropriate; their input impedance may give inaccurate readings.

2.1 System Self-Test

When the power is turned on, the system performs a self-test. This verifies the computer, display console, cable, and sensors are working properly. During the self-test, the display will show the expected crane model, load chart number and units of measurement.

When the display shows the following message, press the “PRESS TO CONTINUE” button.

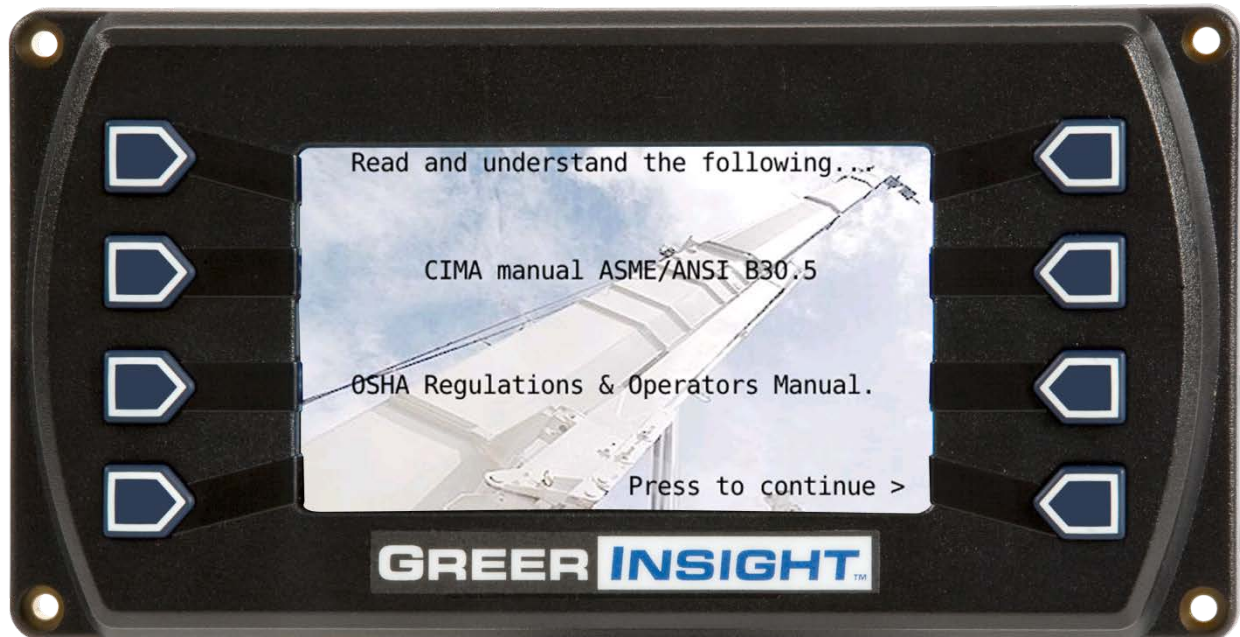

If the above does not occur, refer to **Display Console Problems**.

2.2 Display Console Problems

Display console problems can be difficult to isolate due to the interaction between the display and the computer unit. Failure of either unit or the cabling connecting the units can cause a malfunction.

To solve problems using the display indications, observe the display at power up and through the self-test. Use the following chart to help with the diagnosis:

Problem	Action
There are no display indications in any of the windows when the power is turned on. Or a "No Communications" message appears.	Refer to Internal Status Indicators .
The display unit does not cycle through the self-test. The data in the display windows appears jumbled with missing segments.	Replace the display unit.

2.3 Fault Reporting and Fault Codes

System fault codes provide ways to locate and assess problems within the Insight system. Each time the system is turned on, it performs a self-test that lasts approximately 6 seconds. Faults detected during the self-test are indicated on the display console:

- “WARNING SYSTEM FAULT!” will display at the bottom of the text window.

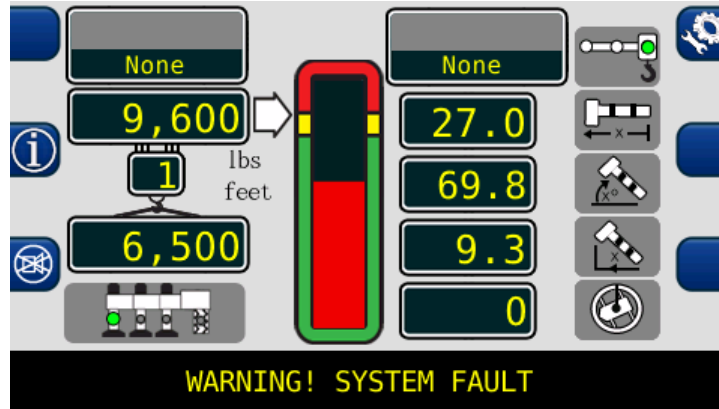

To view the fault codes, press and hold the (i) button as shown.

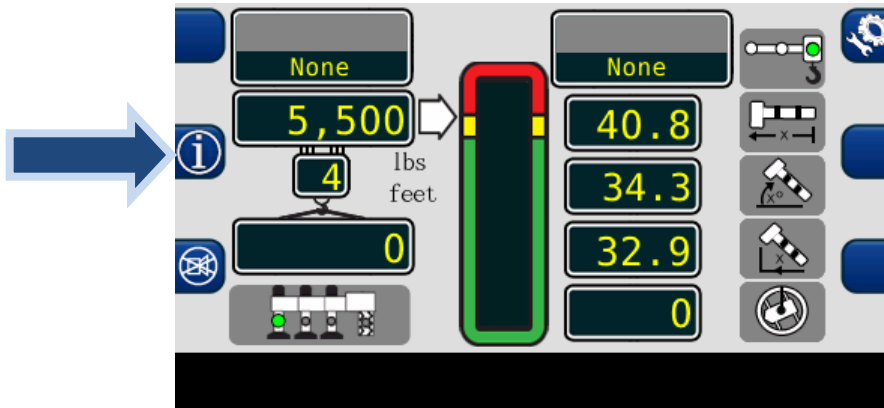

The faults will be listed across the bottom of the text window.

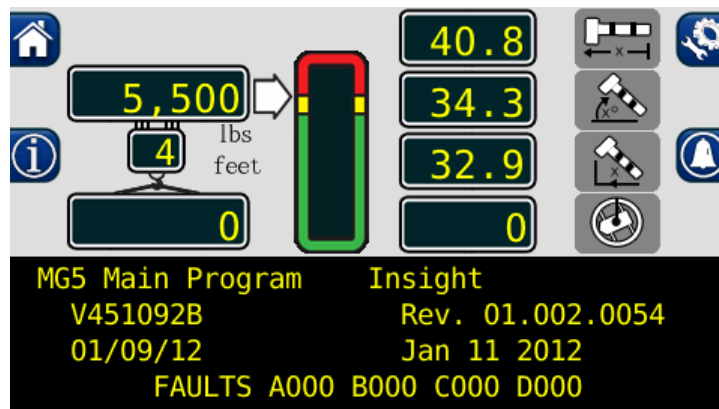

2.3.1 Group “A” Fault Codes

Group “A” fault codes represent faults detected for analog sensors.

NOTE: Check and repair “B” and “C” group faults before investigating group “A” faults.

The following chart details all the available codes in the left column and the actions to take in the right column.

FAULT CODE	SWING SENSOR	BOOM ANGLE SENSOR	EXTENSION SENSOR	TDX 1 ROD PRESSURE	TDX 0 PISTON PRESSURE	ACTION
000	No Fault Found					None
001					X	Refer to Replacing the Computer
002				X		
003				X	X	
004			X			Refer to Calibrating the Extension Sensor Zero, Calibrating Span of Extension and Angle, and Reeling Drum Voltage Checks.
008		X				Refer to Calibrating the Angle Sensor Zero, Calibrating Span of Extension and Angle, and Reeling Drum Voltage Checks.
012		X	X			Refer to Calibrating the Angle Sensor Zero, Calibrating the Extension Sensor Zero, Calibrating Span of Extension and Angle, and Reeling Drum Voltage Checks.
016	X					Refer to Calibrating the Swing Potentiometer, and Reeling Drum Voltage Checks.

2.3.2 Group “B” Fault Codes

Group “B” fault codes represent faults detected for internal analog functions and power feeds to the function kickout and anti-two block switches.

FAULT CODE	FKO POWER FEED	A2B POWER FEED	DISPLAY CONSOLE	ADC 2 INTERNAL FAULT	ADC 1 INTERNAL FAULT	ACTION
000	No Fault Found					
008		X				Refer to sections 6.5 and 6.6 for Troubleshooting Information.
016	X					Check Crane Circuit Breakers

2.3.3 Group “C” Fault Codes

NOTE: Group “C” fault codes represent faults detected for internal computer memories.

The following chart details all the available codes in the left column and the actions to take in the right column.

FAULT CODE	SERIAL EEPROM	CRANE DATA	RAM	DUTY DATA	PROGRAM	ACTION
000	No Fault Found					NONE
001					X	Reprogram the MG5 computer.
008		X				Erase Crane Data
016	X					Replace Computer

2.3.4 Group “D” Fault Codes

NOTE: Group “D” fault codes represent faults detected for capacity chart selection.

The following chart details all the available codes in the left column and the actions to take in the right column.

FAULT CODE	WRONG SWING AREA	WRONG BOOM LENGTH	CHART NOT FOUND	ACTION
000	No Fault Found			NONE
001			X	Check other sensor faults first, Reselect CRANE SETUP
002		X		Boom length is out of range for selected chart. Check crane setup, boom length and extension.
003		X	X	Check other sensor faults first, Reselect CRANE SETUP
004	X			Swing to correct working area to select chart. Check swing sensor zero position.
005	X		X	Swing to correct working area to select chart. Check swing sensor zero position.
006	X	X		Check other sensor faults first, Reselect CRANE SETUP
007	X	X	X	Check other sensor faults first, Reselect CRANE SETUP

2.4 “No Fault Code” Problems

This section addresses problems not reported by the computer fault code system.

2.4.1 Anti-Two-Block Alarm (ATB)

This section gives aids diagnosing ATB alarm problems. For detailed information, schematic, and voltages, refer to **ANTI-TWO-BLOCK FUNCTION OVERVIEW**.

PROBLEM:

- *The Anti-Two-Block alarm is continuously ON. Operating the switch at the boom head does not deactivate the alarm.*

This problem suggests an open circuit between the computer ATB input and the ATB switch, or an open circuit between the computer ATB feed and the ATB switch. Check the reeling drum cable for damage. Ensure the two-block switches are correctly connected. Check the slip-ring and wiring inside the extension reel. Check the reel-to-computer cable. Check the connectors.

PROBLEM:

- *The Anti-Two-Block alarm is continuously OFF (safe). Opening the switch at the boom head, by lifting the A2B weight does not activate the alarm.*

This problem suggests a short circuit between the computer ATB input and the computer ATB feed somewhere between the computer and the ATB switch. Check the reeling drum cable for damage. Ensure the two-block switches are correctly connected. Check the slip-ring and wiring inside the extension reel. Check the reel-to-computer cable. Check the connectors.

2.4.2 Displayed Load or Radius Errors

This section gives direction to fault diagnosis of load and radius errors. Load or radius errors can cause early or late tripping of overload alarms. Accuracy of load is governed by the radius accuracy, and the extension, angle, and pressure sensors. Accuracy of radius (unloaded) is governed by the extension and angle sensors.

Ensure there are no system faults before continuing.

2.4.2.1 Check Boom Extension

1. Ensure the boom is fully retracted.
2. Ensure the reeling drum cable is correctly layered as a single layer across the extension reel surface. Any stacking of the cable will cause extension errors. This will cause the System to exceed the 0.5 ft tolerance allowed by the computer for boom mode selection. If the reeling drum cable is stacking on the reel, refer to **CHECKING THE REELING DRUM CABLE LAYERING**.

3. Check the zero of the extension sensor with the boom fully retracted. Enter the Calibration Mode and use the "SPAN" command. Select sensor No. 2 to view the extension value in feet. The value of extension must be between -0.2 and +0.2, with the boom fully retracted. If the extension value is incorrect, refer to **ENTERING THE CALIBRATION MODE**. Fully telescope the boom and ensure the displayed boom length value matches the maximum length of the boom. If the length value is incorrect, follow the EXTENSION SPAN procedure in **CALIBRATING SPAN OF EXTENSION AND ANGLE**.

2.4.2.2 Check Main Boom Radius

NOTE: The required accuracy of taped radius measurements is within 0.1 feet. When taking radius measurements use a good quality tape that does not stretch. The tape should be graduated in feet and tenths of a foot. Always measure between the swing center of the crane and the hook line, using a single part of line with the crane centered over front (rough terrain) or centered over rear (truck crane).

1. Fully retract the boom and ensure the crane configuration is correctly set up.
2. Raise the boom to about 45° and measure the radius. The measured radius must match the displayed radius within + 0.5 ft. If it does not match, refer to **CALIBRATING THE ANGLE SENSOR ZERO**.
3. Raise the boom to a high angle (at least 70°) and measure the angle with the inclinometer. Ensure the displayed angle matches the inclinometer reading within 0.2°. If the displayed angle is incorrect, follow the angle span calibration procedure in **CALIBRATING SPAN OF EXTENSION AND ANGLE**.

2.4.2.3 Check Boom Angle

NOTE: The required accuracy of measured angles is within 0.2°. When taking boom angle measurements use a good quality inclinometer. Many inclinometers are only accurate at 0° (level). Ensure the digital inclinometer is securely mounted to the boom.

1. Fully retract the boom.
2. Using an inclinometer, set the boom to 0° (zero) and ensure the displayed boom angle value is 0.0°. If the angle value is not 0.0°, refer to **CALIBRATING THE ANGLE SENSOR ZERO**.
3. Raise the boom to a high angle (at least 70°) and measure the angle with the inclinometer. Ensure the displayed angle matches the inclinometer reading within 0.2°. If the displayed angle is incorrect, refer to **CALIBRATING SPAN OF EXTENSION AND ANGLE**.

2.4.2.4 Check Pressure Sensors

There are two pressure sensors installed as part of the system. Both pressure sensors are mounted within the computer unit. One is connected to the piston side of the boom hoist cylinder via flexible hose; the other is connected to the rod side of the boom hoist cylinder via flexible hose. Both hoses are protected by velocity fuses within the boom hoist cylinder valve block on the end of the cylinder.

The pressure sensor located on the piston side, is subject to the hydraulic pressure needed to support the weight of the boom, any attachments, and the load. The pressure sensor on the rod side monitors the pressure necessary to control the down motion of the boom. The computer unit uses this information (along with other sensors such as extension, length, and angle), to compute the weight of the suspended load. The maximum continuous working pressure for the sensors is 250 bar (3625 PSI).

The pressure sensing system is calibrated at the factory. Pressure sensors may not be individually replaced. Any serious problem will necessitate changing the entire computer unit.

1. Lower the boom until the boom hoist cylinder is fully retracted and on its stop.
2. Loosen the hydraulic connections to the pressure sensors to ensure zero pressure is present on the sensors.
3. Enter the calibration mode and press “Menu Up” to access “14 PRESSURE MONITOR” to view both sensor pressures and net pressure.
4. Check the pressure values of both sensors. The pressure values should be between -75 and +75 PSI. If not, replace the computer unit.
5. Check the nett pressure values of both sensors. This should be between -35 and +35 psi. If not, replace the computer unit.

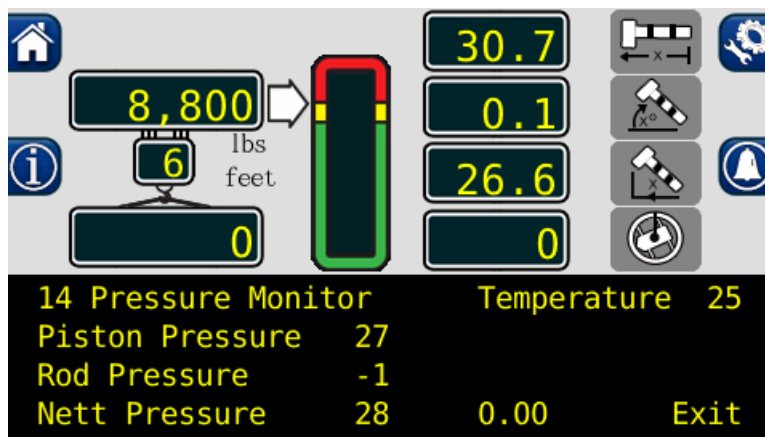

WARNING!

BOTH PRESSURE SENSORS ARE PRE-CALIBRATED FROM THE FACTORY AND SUPPLIED AS PART OF THE COMPUTER. THE PRESSURE SENSORS MAY NOT BE REPLACED. REMOVAL OR REPLACEMENT OF THE PRESSURE SENSORS FROM THE COMPUTER INVALIDATES THE WARRANTY AND WILL ADVERSELY AFFECT THE PRESSURE CALIBRATION.

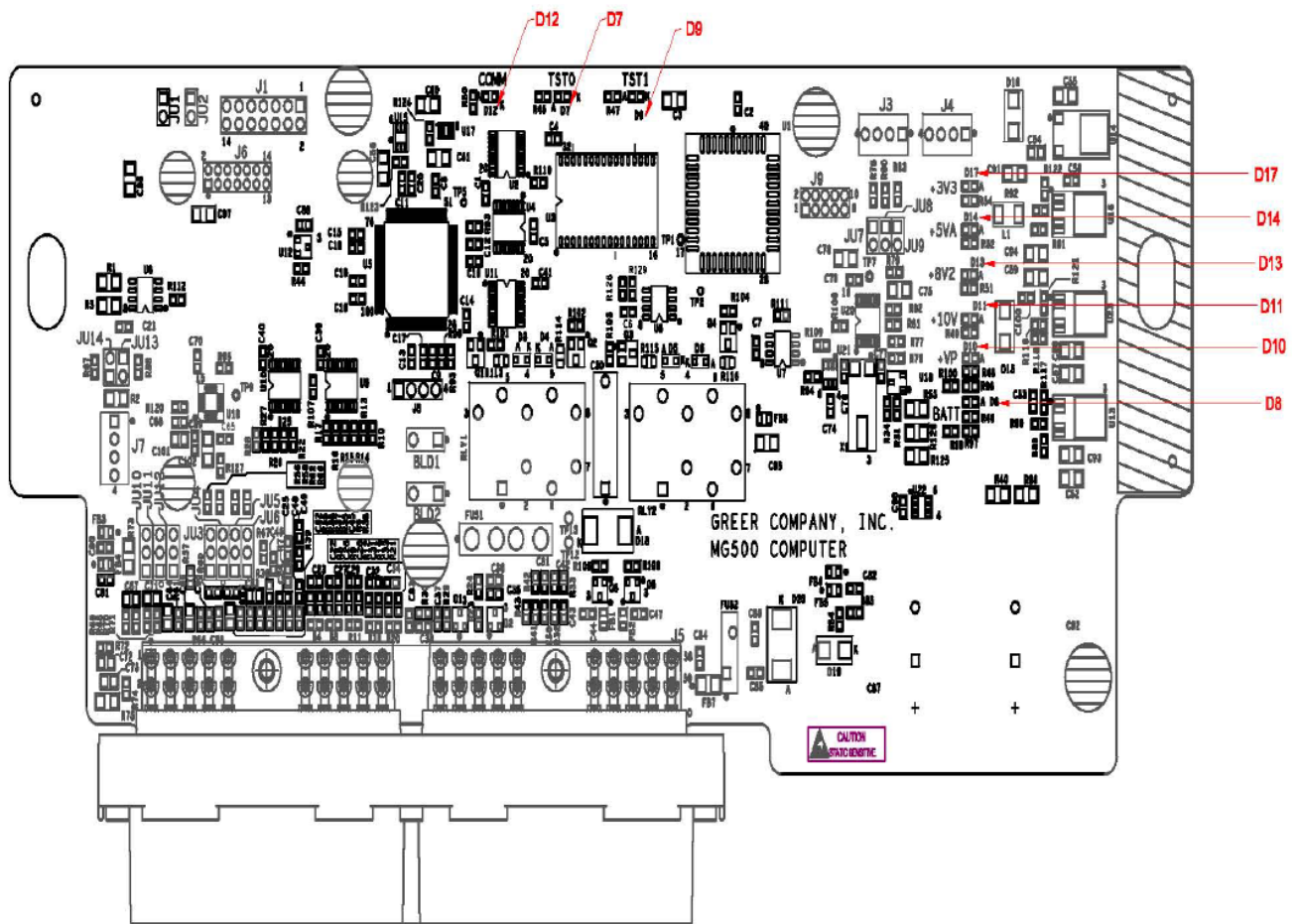

Metri-Pack Style Computer

3.3 Internal Status Indicators

The computer unit contains a row of LED indicators for checking computer operation. During normal operation, all LEDs will be illuminated with the COMM indicator blinking. If not, please contact Technical Support for assistance. Use the following chart and preceding images for LED location.

LED Indicator	Function
D7	Communication Indicator TST0
D8	Battery Power_POS
D9	Communication Indicator TST1
D10	+VP
D11	+10V
D12	COMM (Communication Indicator)
D13	+8V2
D14	+5V
D17	+3V3

3.4 Function Kickout Fuse (Fus1)

The computer unit contains a standard 10 amp replaceable fuse. The fuse protects the function kickout circuit and relay contacts, if a short circuit occurs across the crane kickout solenoids. Replace the fuse, if the system error codes indicate that the function kickout power feed is missing. Ensure the crane circuit breaker is closed and power from the crane is present.

NOTE: Prior to replacing the fuse, ensure any electrical shorts which may have caused the failure of the original fuse have been removed.

3.5 Replacing the Computer Unit

COMPUTER REMOVAL

1. Lower the boom until the boom hoist cylinder is completely retracted and on its stop or the boom is firmly in the boom rest.
2. Disconnect the hydraulic connections at the computer unit.
3. Disconnect both electrical connectors at the computer unit.
4. Remove the hardware securing the computer to the cab wall.

COMPUTER INSTALLATION

1. Secure the computer unit to the cab wall with the mounting hardware.
2. Ensure the electrical connections face downward.
3. Connect the electrical connectors.
4. Remove the protective caps from the hydraulic ports.
5. Connect the base-side pressure (green band) hose to the piston pressure port.
6. Connect the rod-side pressure (red band) hose to the rod pressure port.

4.1 Display Console Overview

The Display Console allows the user to see the crane values and crane configuration selection. The display also provides calibration functions used for testing and fault diagnosis.

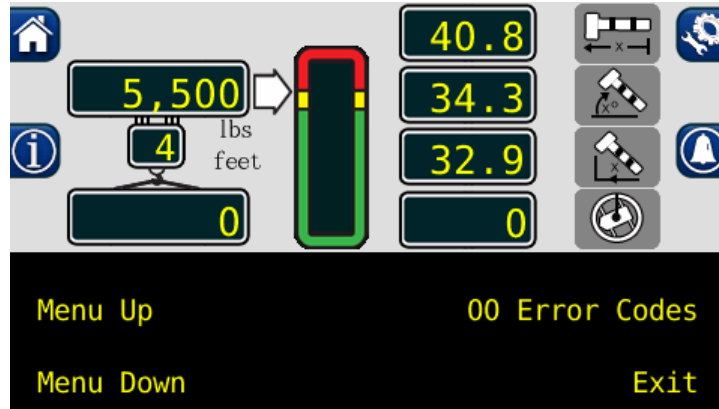

4.2 Checking the Display Console

When operated under extreme conditions the console can become damaged. The damage is not always apparent. To help identify subtle faults that are sometimes difficult to find, please review the Sections 4.3 through 4.6.

4.3 Unresponsive Buttons

All button options are not available for use at all times. It is important to verify that the non-responsive button:

- Is programmed to respond during the operation of the system.
- Being pressed in the center, pressing the printed symbol 'at one end' may not activate the switch underneath.
- Is not damaged or has a surface that is worn which may cause the switch underneath to operate improperly. In this case, refer to **REPLACING THE DISPLAY CONSOLE**.

4.4 Connectors

There are four, 6-pin Deutsch connectors on the rear of the Insight.

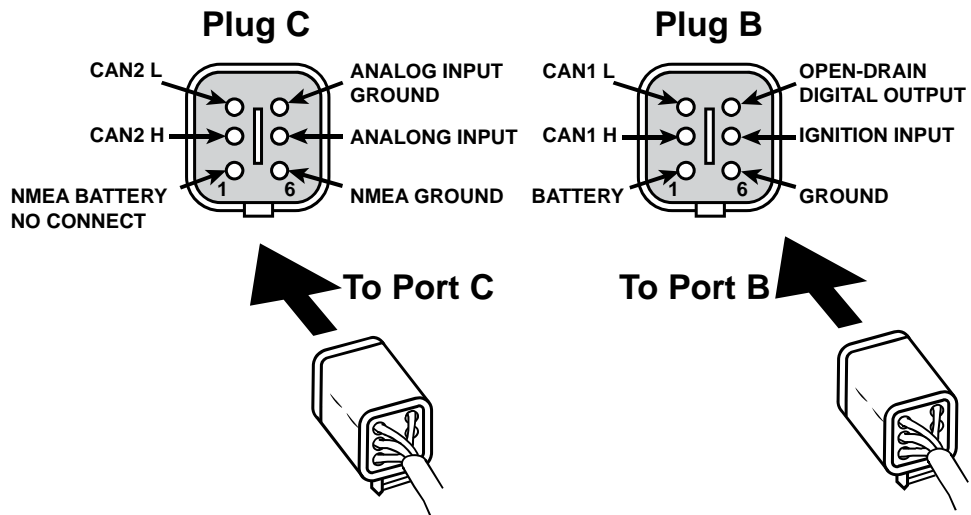

4.5 Horn

Ensure the horn is connected to the wiring harness via the two-pin Deutsch connector.

4.6 Moisture

The display console conforms to IP67 in protection against dust and water, when correctly installed.

4.7 Replacing the Display Console

REMOVAL

1. Disconnect the electrical cable from the rear of the Operator's Display Console.
2. Remove the knob on each side of the console and retain for future use.
3. Remove the defective display console from the bracket in the cab.

INSTALLATION

1. Put the Operator's Display Console on the bracket located in the cab, by positioning it between the bracket legs.
2. Insert and tighten the knob on each side of the console.
3. Connect the electrical cable to the rear of the console.

5.1 Calibration Mode

The Greer Insight system is an aid to crane operation. Use this system with an operator trained in safety guidelines, crane capacity information, and the crane manufacturer's specifications.

When the computer is new, it has no zero or span calibrations. It is necessary to enter zero and span settings for accurate length and angle calculations.

TOOLS NEEDED:

- Digital level accurate to 0.1°
- 150-200ft. tape measure graduated in tenths of a foot
- Digital multimeter

PRE-REQUISITES FOR CALIBRATION

- The crane must be properly set on level ground per the manufacturer's specifications.
- Maximum boom height will be needed. It is necessary the area is free of overhead obstructions.
- All options such as jibs, fly's, and auxiliary heads must be configured in the computer.

5.2 Entering the Calibration Mode

Follow these steps to ensure proper calibration. The actual crane setup must be reflected on the display. Check the **Greer Insight Operator's Manual** for proper setup of the display unit.

1. To enter Calibration Mode, the display must be in "Normal Operating" mode.
2. Press and hold the buttons shown simultaneously until the display prompts the user for the security code.



3. Enter the Security Code within 5 seconds, or the system will revert to the "Normal Operating" mode. The numbers in parenthesis indicate the proper order to press the buttons.



5.3 Calibration Menus

After entering the calibration menu, press the “Menu Up” button until “02 Zero Sensors” is reached.

Scroll through the menu options by pressing the “Menu Up” or “Menu Down” buttons. To select an item, press the button adjacent to the menu listing as shown in the example.

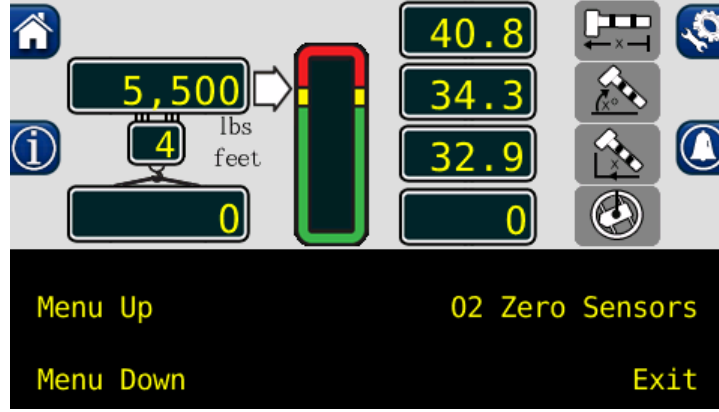

The main menu items used to calibrate the system are:

- 02 Zero Sensors
- 03 Span Sensors
- 04 Swing Potentiometer

The only calibrations needed are for the boom extension function and the boom angle function. They must be properly set to zero. On machines with string potentiometer style outrigger position sensors, if a sensor is replaced, it will need to be calibrated. Refer to **CALIBRATING THE OUTRIGGER POSITION SENSOR**.

The system is also equipped with a swing potentiometer. This is designed to track the turret in relation to the chassis.

Boom extension and angle readings are dependent on the correct span values to be entered into the system. These span values are determined by using a digital level on the boom angle, and measuring the span of boom extension.

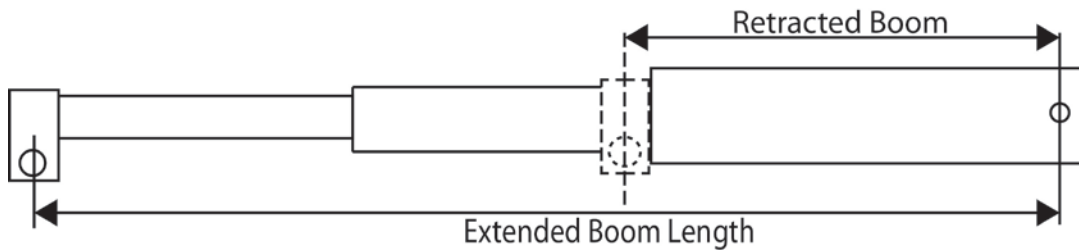

$$\text{Extended Length} - \text{Retracted Length} = \text{Span}$$

Inactive Buttons During Calibration Mode

Please note the following buttons are inactive when in the Calibration Mode. The functionality of the buttons will return when the display is no longer in the Calibration Mode.

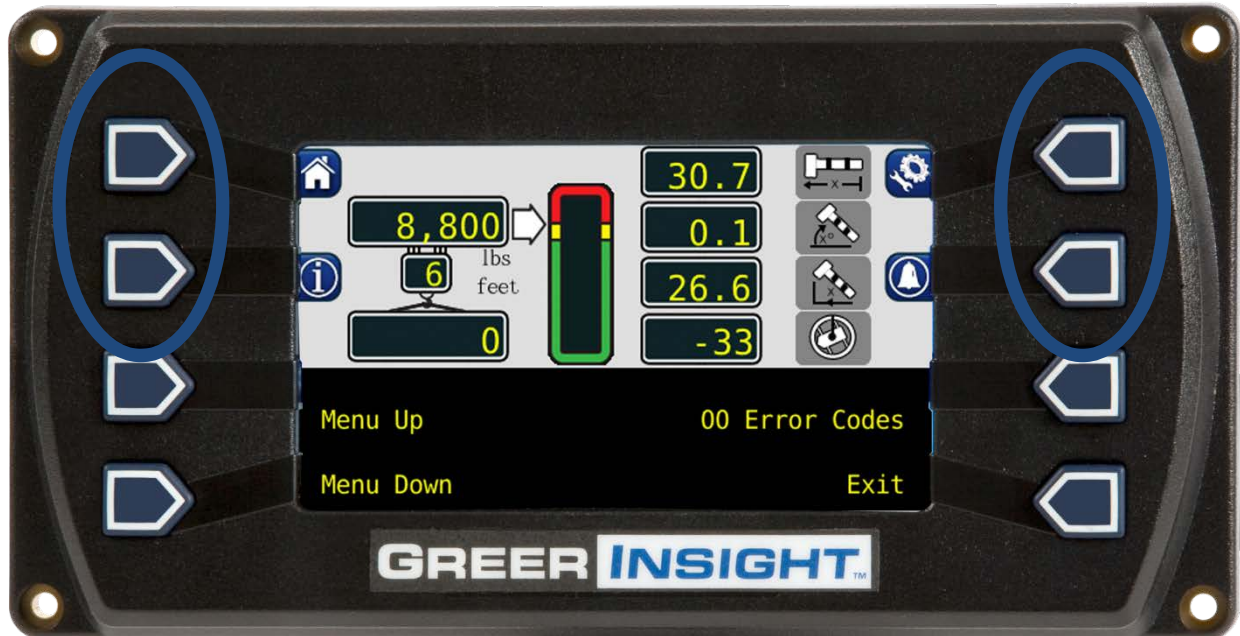

5.4 Calibrating the Extension Sensor Zero

1. Fully retract and lower the boom to 0.0. Verify using a digital level.
2. Remove the reeling drum cover to expose the baseplate sensory assembly.
3. Rotate the extension sensor gear clockwise until the clutch drags/clicks, and rotate a ½ turn counterclockwise.
4. The voltage reading between the blue wire TB1-1 and the white wire TB1-3 on the terminal block should measure 0.15 to 0.35 volts. If outside this voltage, rotate the gear to attain proper voltage with the boom fully retracted.

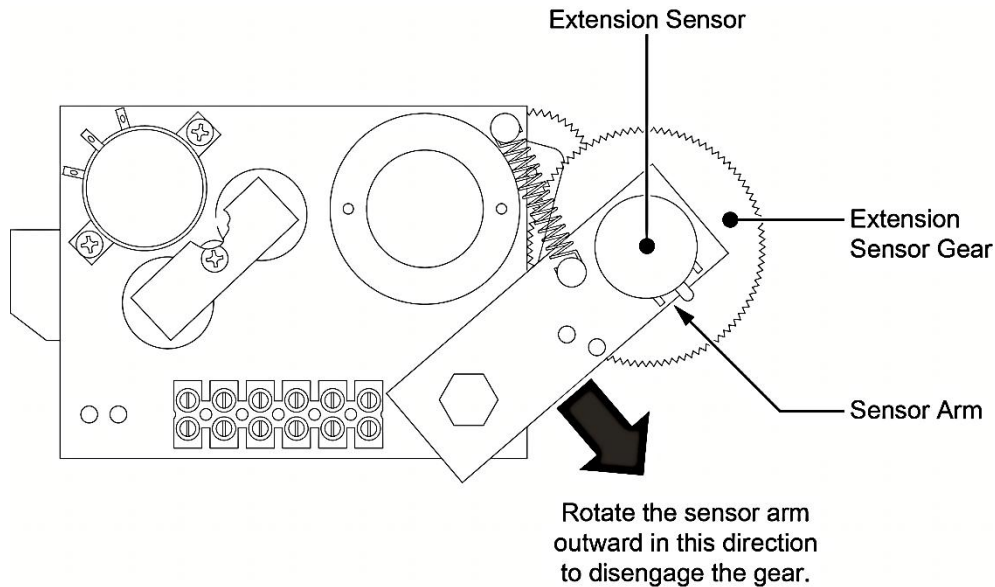

5. Press the "Menu Up" button until "02 Zero Sensors" is reached.
6. Press the "02 Zero Sensors" button.
7. Press the "Zero No. 2 =" and you will be prompted with "Yes! Calibrate!" Press the button a second time to calibrate the Zero.



8. The display will then read "Zero No. 2 = 0". The retracted boom length will be displayed in the boom length window. Extension sensor zero calibration is complete.

5.5 Calibrating the Angle Sensor Zero

The angle sensors are preset to zero on the potentiometer before leaving the factory. If the potentiometer is disturbed, the zero setting can be affected. If this happens, the angle sensor will be inaccurate.

If the factory setting has been disturbed, reestablish it by loosening the attaching screws, and rotating the pot until the desired voltage reading is attained.

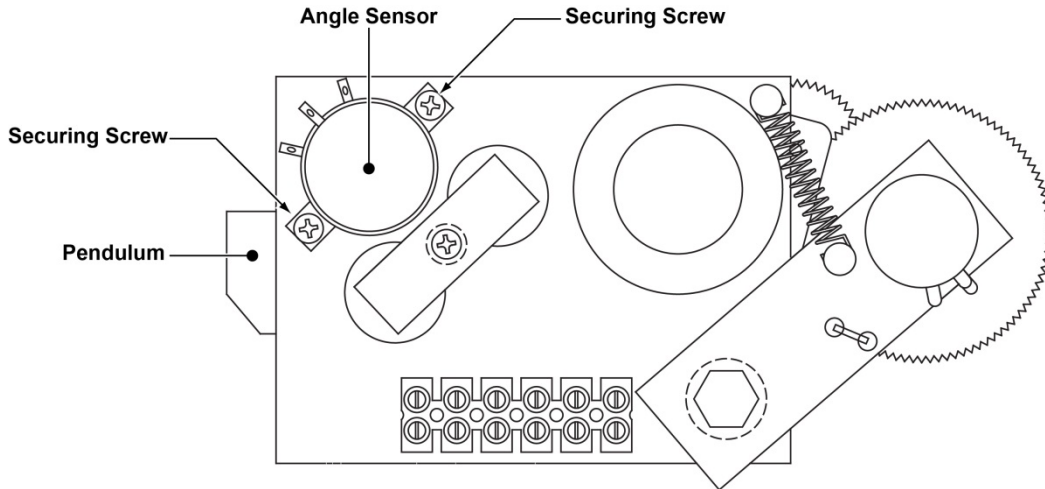

1. Place the boom at 0.0 degrees. Verify using a digital level.
2. Check the voltage between TB1-1 and TB1-2. It should measure between 0.400 and 0.600.
3. Enter the "02 Zero Sensors" menu.
4. Press the "Menu Up" button to display "Zero No. 3 = 0." The calibration screen and boom angle window should read "0".

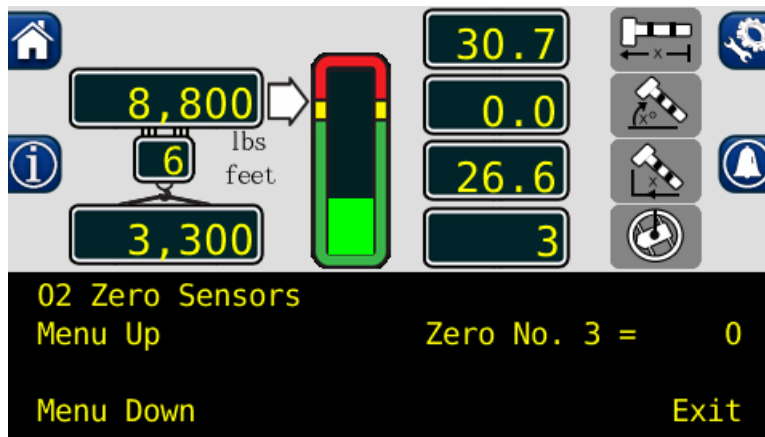

5. Press the "Zero No. 3 =" and you will be prompted with "Yes! Calibrate!" Press the button a second time to calibrate the zero. The angle sensor zero routine is complete.

5.6 Calibrating Span of Extension and Angle

WARNING!

THE AREA OVERHEAD ABOVE THE CRANE MUST BE CLEAR OF OBSTRUCTIONS PRIOR TO CALIBRATING SPAN OF EXTENSION AND ANGLE!

In order for the system to properly calculate the boom length and the boom angle, the "Span Number" must be entered into the system. Obtain the span number with the following steps:

1. Measure the boom from the base foot pin to the center of the head sheave pin. Record this measurement.

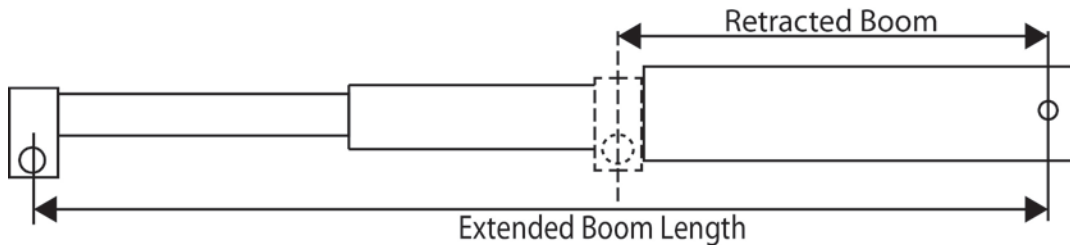

$$\text{Extended Length} - \text{Retracted Length} = \text{Span}$$

2. Raise the boom to between 60-65° and fully extend the boom. Record the measurement from the digital level, for entry into the system later in this procedure.
3. From the main screen, press the "Menu Up" button until "03 Span Sensors" and press the button.
4. Press the "Span No. 2 = X.X" button.
5. Press the button again to be prompted with "Yes Calibrate" or "No, Exit/Abort". Press the "Yes! Calibrate!" button.
6. Use this screen to enter the span (Extended Length – Retracted Length = Span).

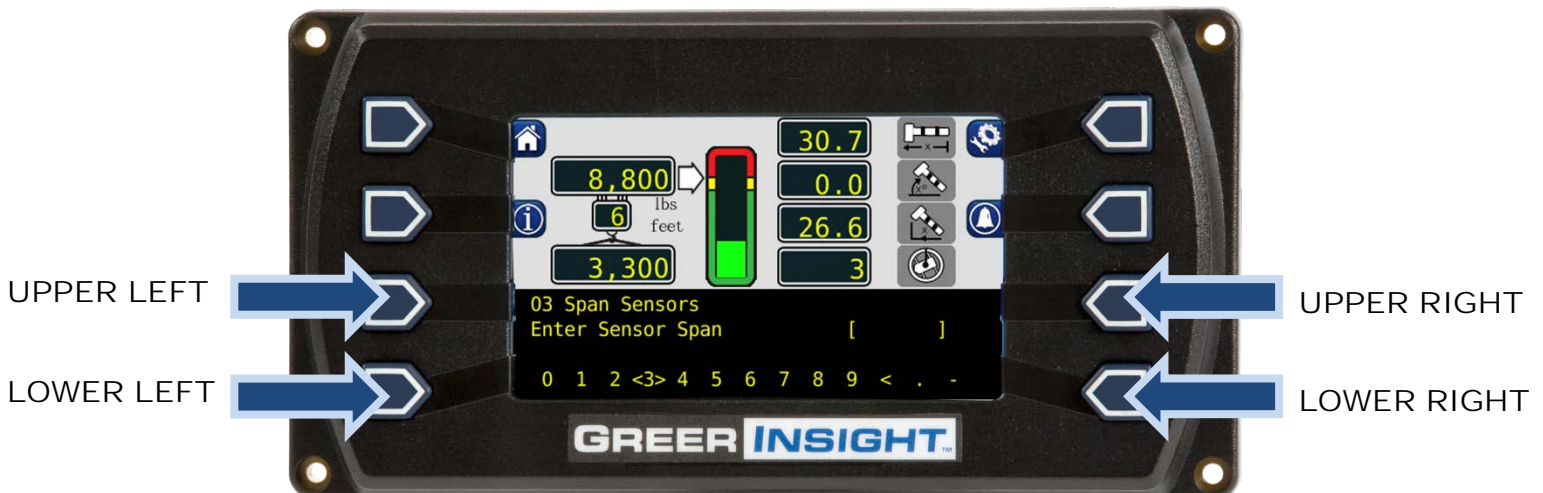

7. The lower left and lower right buttons are used to select the number. The number inside the brackets is the current selection, in the above image, the number 3 is between the brackets.
8. Use the upper left button to enter the numbers, one at a time.
9. When the number is entered, press the upper right button to enter the number into the system memory. Span of extension is now complete.
10. Press the “Menu Down” button to display “Span No. 3 = xx.xx”.

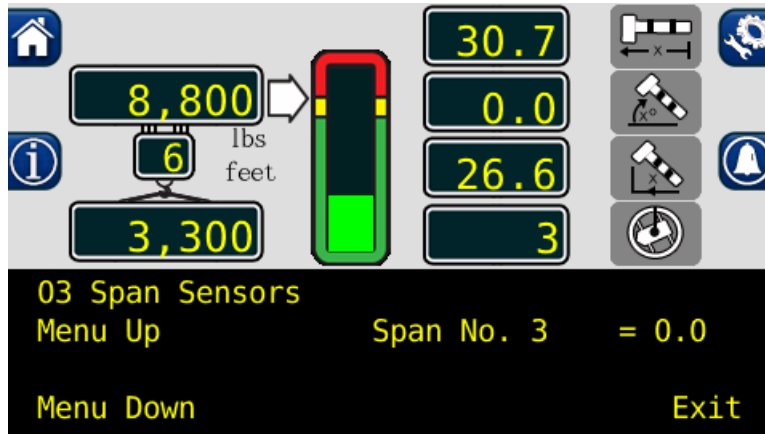

11. Press the “Span No. 3 = xx.xx” button.
12. Press the “Yes! Calibrate!” button.



13. You will be prompted with the same screen from step 6. Use this screen to enter the span of angle measurement from the digital level.
14. This calibration routine is now complete. Press the “Exit” button to return to the calibration menu.

5.7 Calibrating the Swing Potentiometer

After completing the extension and angle span, exit back to the main calibration screen. Press the “Menu Up” button until “04 Swing Potentiometer” is reached. This menu will allow a 0.0 point to be set on the swing circle and a direction for the system to track the rotation angle.

1. The swing must be in the stowed position and the house lock engaged.

NOTE: Inaccuracy in the swing zero setting may result in the loss of load chart for pick and carry.

2. Press the “Zero” button to zero the swing potentiometer.

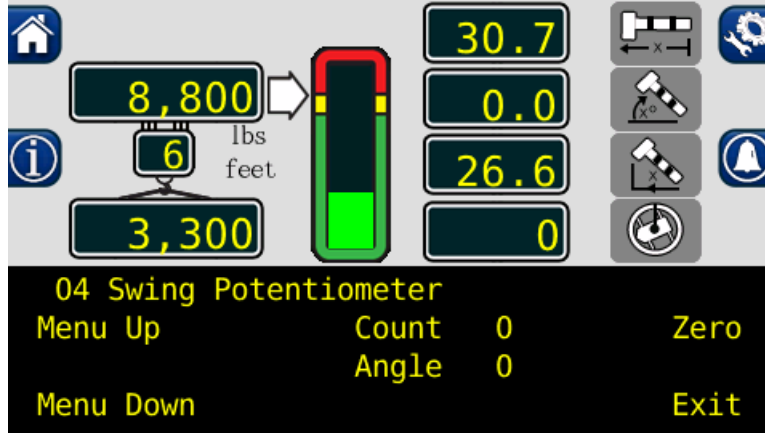

3. The swing sensor is now zeroed.

5.7.1 Calibrating Swing Direction

The swing potentiometer supplies data for either direction. For consistency, the swing should count upwards (0, 1, 2, 3, etc.) when rotating clockwise. The direction of the swing can be changed while using the Greer Insight display.

When the zero is calibrated and the swing direction is wrong, press the “Menu Up” button twice. Press the “Direction = ‘-’” button to reverse the direction.

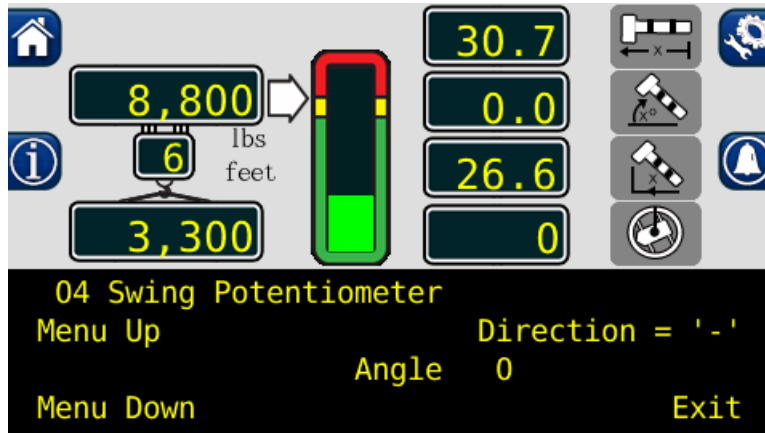

5.7.2 Cranes with Swing Switches

1. Enter the Calibration Mode and press the “Menu Up” button to “04 Swing Potentiometer”.
2. Enter the “04 Swing Potentiometer” menu and press the “Menu Up” button until the “Remove Swingpot?” option is displayed.

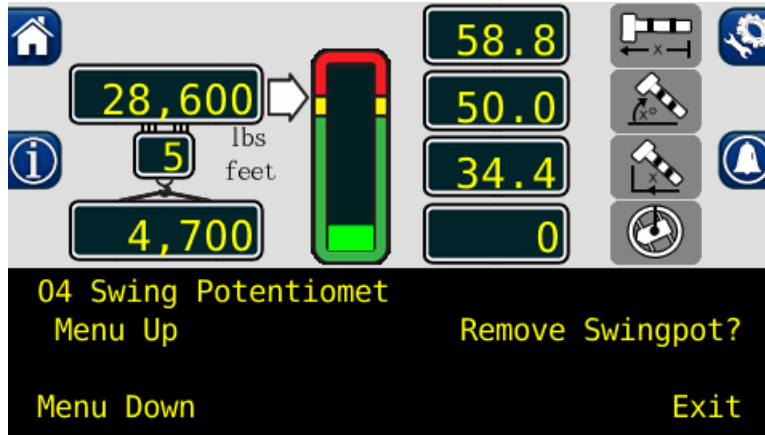

3. Press the “Remove Swingpot?” button.
4. The crane will now use the swing switches.

5.8 Calibrating the Outrigger Position Sensor

If an error code is displayed for a particular outrigger sensor, contact service for assistance.

For cranes with digital switch outrigger position sensors, contact service for assistance. No calibration is needed.

When directed by service to replace the string potentiometer outrigger position sensors, calibration is needed.

1. Enter the outrigger sensor calibration menu.
2. In the lower left portion of the screen, “Current Sensor: = CAN String Pots” will be displayed. If this is not correct, press the button once to toggle to “Current Sensor: = CAN String Pots”.

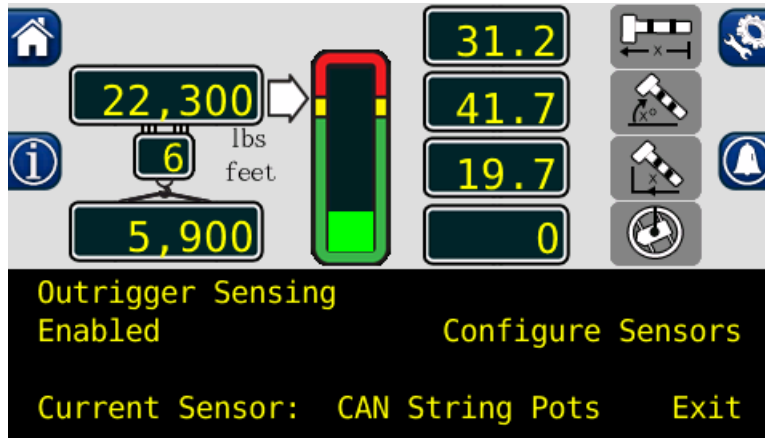

3. Press the “Configure Sensors” button.
4. Install the outrigger position sensors one at a time.
 - a. Install the front left string potentiometer. “New device found” will appear on the display.

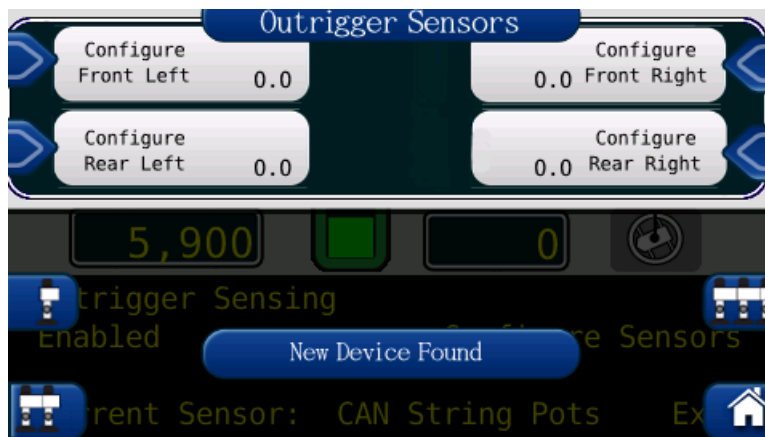

- b. Press the “Configure Front Left” button to identify the new sensor location in the computer.
- c. Repeat this for the three remaining sensors, pressing the configure button that corresponds to the sensors location.
- d. The message will change from “Configure” to “Reset” when calibration is finished.

5. With all sensors installed, ensure the outriggers are in the fully retracted position. Press the fully retracted position button to set the retracted position in the computer.

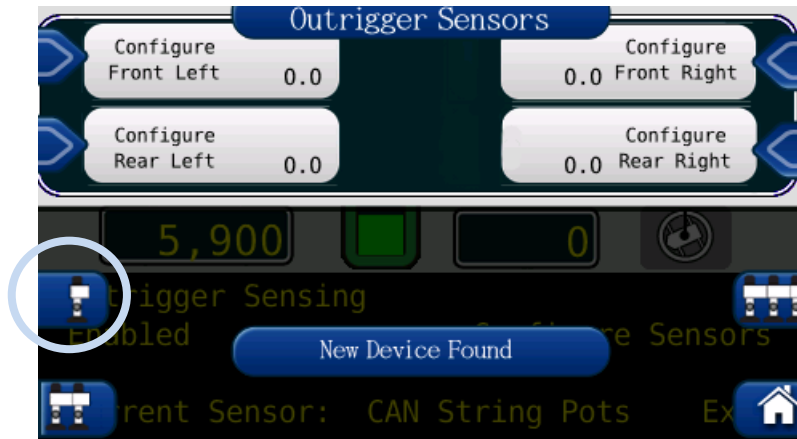

6. Move the outriggers to intermediate position and press the corresponding button to set the intermediate outrigger position.

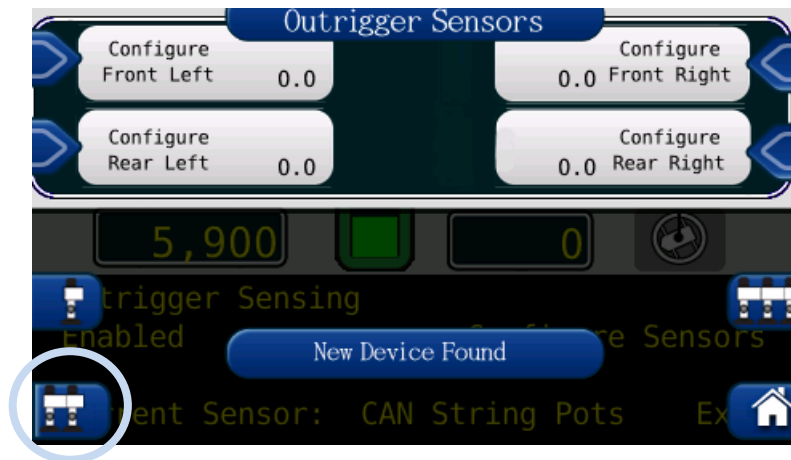

7. Move the outriggers to fully extended position and press the corresponding button to set the fully extended outrigger position.

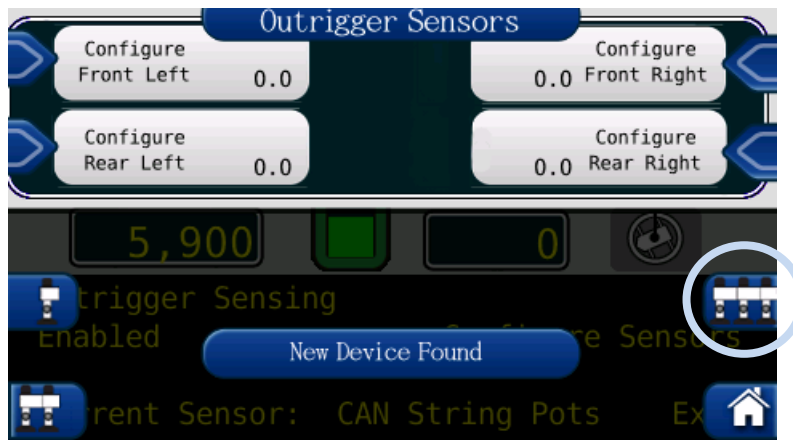

8. The outrigger position sensors are now calibrated.

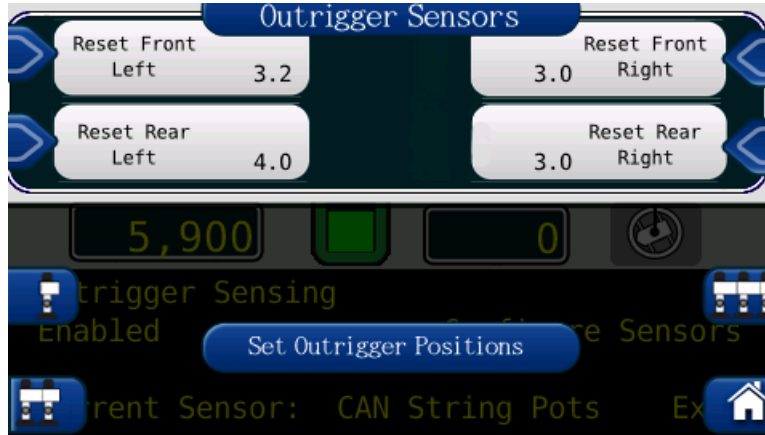

5.9 After the Calibration Routine

When the calibration routine is complete, thoroughly test the unit to ensure the radius on the unit is accurate to + .5 of a foot.

In order to perform load testing, a known weight is necessary. Perform testing from 2-3 different boom angles, as well as extensions.

The load shown must be within +10% when testing. If the load is outside these limits, the calibration should be rechecked for accuracy.

6.1 Reeling Drum Overview

The primary operation of the reeling drum is to measure the extension of the telescoping sections of the main boom. The reeling drum also includes an angle sensor to measure the main boom angle along with an electrical slip-ring which transfers the two-block signal from the reeling drum cable to the system computer. It is important the setup these devices is performed correctly. Incorrect maintenance can result in system calculation errors.

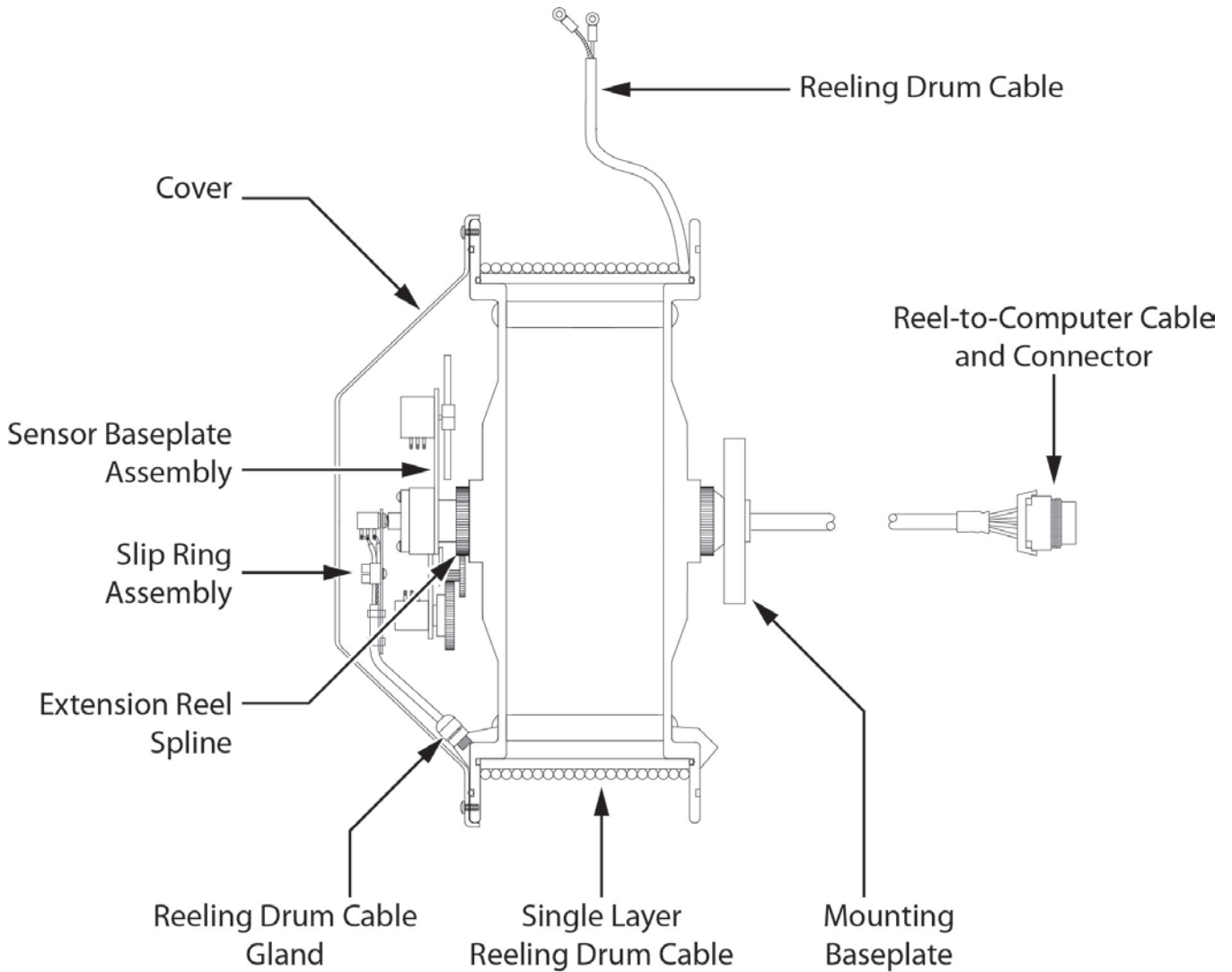

6.2 Checking the Reeling Drum Cable Layering

The extension reel is designed to provide accurate measurement of boom extension. To provide accurate measurement, the reeling drum cable must form a single flat layer across the surface of the extension reel as the boom is telescoped in and out. Any stacking of the cable will cause extension errors as the boom retracts.

1. Telescope the boom fully out and then fully in.
2. Ensure the reeling drum cable forms a flat single layer across the surface of the extension reel, with each successive turn of cable lying next to the last.

NOTE: If any stacking or build up of the cable occurs, ensure the first cable guide at the top of the boom root section is correctly aligned with the outside edge of the extension reel. Clean the reeling drum cable and lubricate it with a silicone spray.

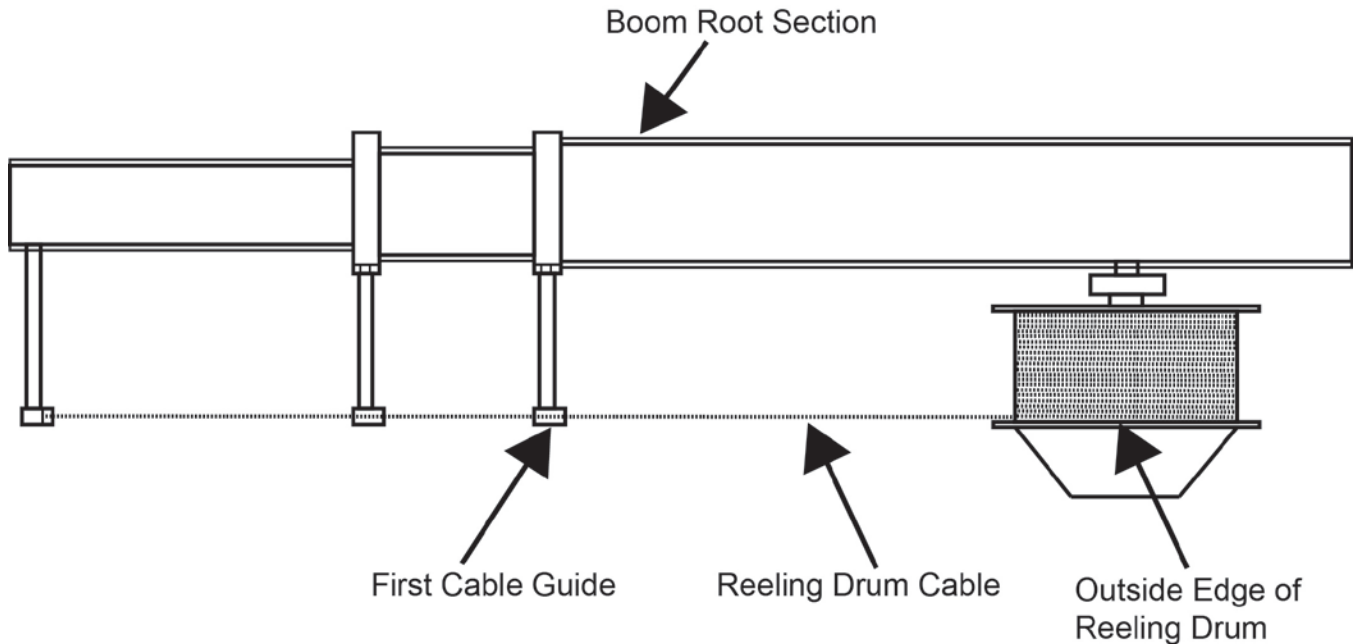

6.3 Sensor Baseplate Assembly

The sensor baseplate assembly supports and connects the extension and angles sensors. It also supports the two-block switch signal and signal cable to the computer.

Electrical or mechanical failure of either the angle sensor or the extension sensor potentiometers cannot be repaired in the field. The angle sensor pendulum is factory set on the potentiometer shaft and the extension potentiometer gear contains a protection clutch which is difficult to replace in the field. In the event of failure of either item, replace the entire sensor baseplate assembly.

The terminal block (TB1) mounted on the assembly provides wiring connection for all internal parts of the reeling drum and Reel-to-Computer cable. Most electrical diagnoses of the boom sensors can be made at this terminal block.

If problems occur with the two-block alarm operation, angle, or extension sensor, refer to the following chart. Follow the Boom Position/Action column before performing any voltage checks. Measure all voltages with a digital voltmeter set to DC volts range.

SIGNAL	BOOM POSITION/ ACTION	VOLTAGE		VOLTMETER CONNECTION	
		MIN	MAX	RED (+)	BLACK (-)
SENSOR DRIVE	-	+4.7V	+5.3V	RED	BLUE
ANGLE SENSOR OUTPUT	0 degrees	0.4V	0.6V	GREEN	BLUE
EXTENSION SENSOR OUTPUT	0 ft. FULL RETRACTED	0.15V	0.35V	WHITE	BLUE
TWO-BLOCK DRIVE	A2B WEIGHT DOWN	5.5V	7.5V	BLACK	BLUE
	A2B WEIGHT UP	9.5V	10.5V	BLACK	BLUE
TWO-BLOCK SIGNAL	A2B WEIGHT DOWN	5.5V	7.5V	BROWN	BLUE
	A2B WEIGHT UP	0V	2V	BROWN	BLUE

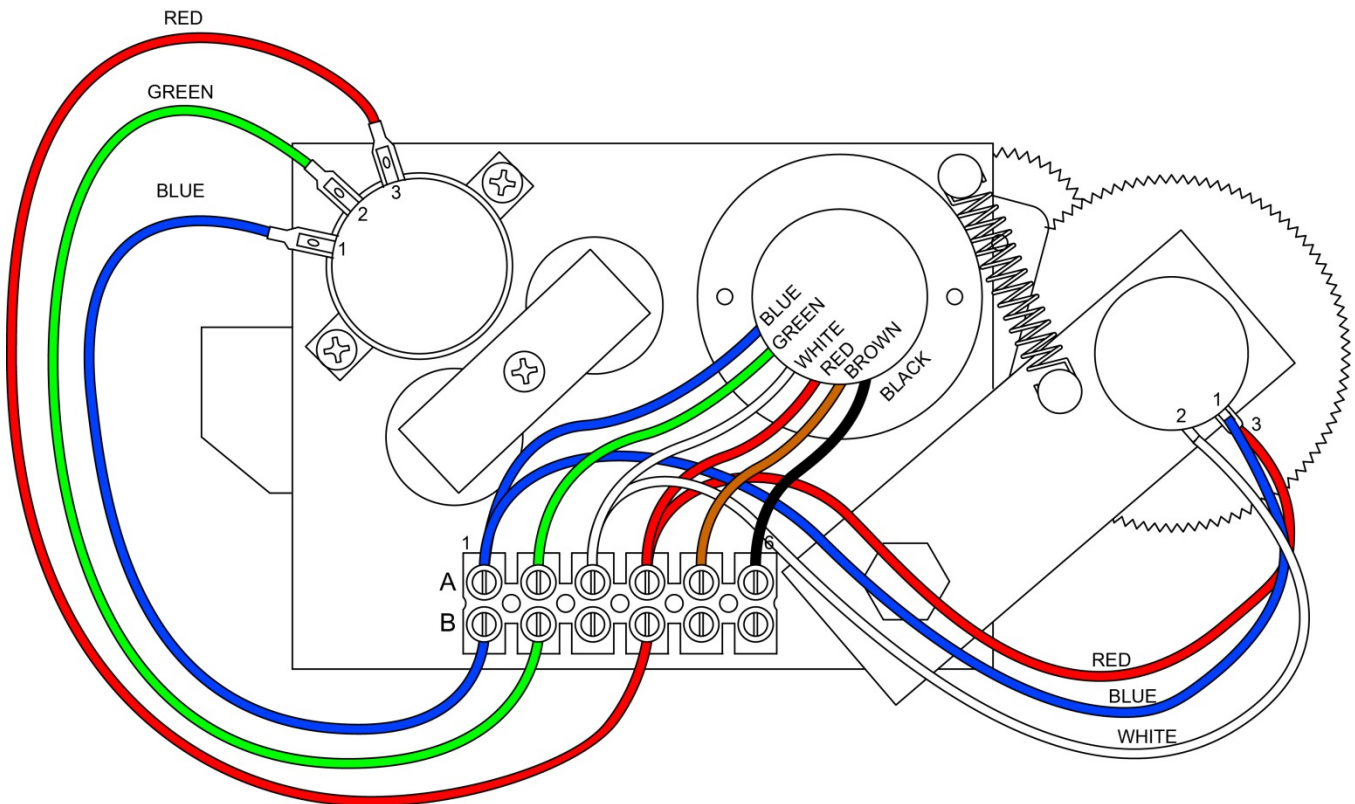

6.4 Anti-Two-Block Function Overview

The computer supplies a protected positive feed to the Anti-Two-Block switches at the boom/jib head via the extension reel signal cable, slip-ring, and reeling drum cable. With the Anti-Two-Block weight hanging freely on the switch, the switch contact is closed and the signal return to the computer is high. When the weight is lifted by the hook block, the switch contact is opened, and the computer will sense a low signal input from the A2B signal return.

Since the computer checks the protected feed voltage internally, the system is capable of detecting a short circuit of the feed (or the ATB signal return when the switch is closed) to the crane chassis. Fault codes are defined in **FAULT REPORTING AND FAULT CODES**.

Most problems with the ATB circuit may be identified through inspection of cables, switches, and the reeling drum. Damage to these parts may result in continuous or intermittent A2B alarms.

6.5 Checking the Reeling Drum Cable

The outer braid of the cable carries the Anti Two-Block feed to the switches. If the cable sheath is damaged, this may cause a short circuit to the boom/chassis and indicate a fault code of “B008” (Refer to **GROUP “B” FAULT CODES**). The same fault code will be indicated if the A2B switch is closed and the inner core of the cable is shorted to the chassis at some point in the wiring.

1. Carefully inspect the reeling drum cable for wear.
2. Check for signs of damage to the outer sheath of the cable.
3. Check for any signs of severe “kinking” or crushing of the cable.

6.6 Checking the Anti-Two-Block Circuit

Before continuing, ensure the connectors are correctly connected to the A2B switches at the boom head/jib. This procedure checks the ATB circuit when no power is applied to the circuit, use the diagram on the following page.

1. Remove the extension reel cover.
2. Disconnect the slip-ring arm from the plug by pulling it away from the center of the reel.
3. Close the A2B switch at the boom head by suspending the weight from it or pulling on the chain.
4. Measure the resistance between TB2-1 & TB2-2 terminal connections on the sensor arm.
5. With the A2B switch closed, the resistance should be less than 300 ohms. If not, inspect the reel-off cable, A2B switch, and the boom head connectors for an open circuit.
6. Open the A2B switch at the boom head by lifting the weight.
7. Measure the resistance between TB2-1 & TB2-2 terminal connections on the sensor arm.
8. With the A2B switch open, the resistance should be greater than 10,000 ohms. If not, inspect the reel-off cable, A2B switch, and the boom head connectors for a short circuit.

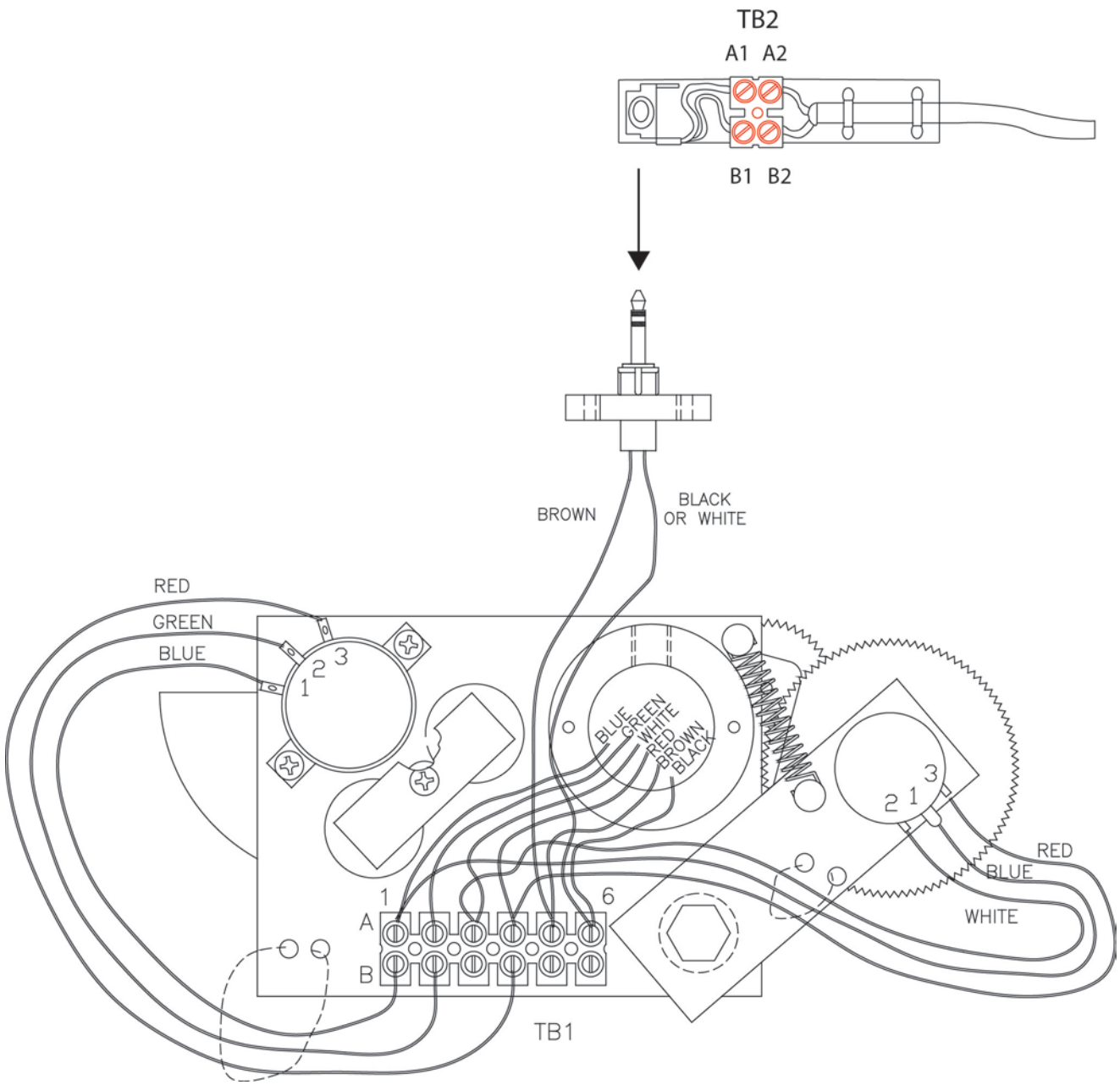

7.1 WAD/ISS

Overview

The WAD/ISS (Work Area Definition/Integrated Swing Sensor) incorporates a sensor housed in the swing drive of the crane that measures the angle of the upper structure of the crane relative to its carrier. The sensor measures the angle by counting electronic pulses on the target gear relative from the zero point (set by the operator) in either a positive or negative direction. The conditioning box translates the signal so it can be processed by the computer and shown in the information window of the display console.



WAD/ISS Conditioning Box

The advantage of the WAD/ISS over a typical swing potentiometer is the swing potentiometer is housed in the collector column and maintenance and/or removal is difficult. The WAD/ISS is a small unit mounted directly onto the swing drive and is easily accessible.

During normal operation, faults detected with the WAD/ISS will be shown on the display unit. During such fault conditions the red “Overload” LED will flash accompanied by an intermittent audible beep. Additionally, the swing angle window will display “ERROR” as well as the information window showing an error condition message. All swing related operator alarms, work area alarms, etc, will be displayed.

7.2 WAD/ISS Troubleshooting Table

Error Message / Problem	Cause	Correction
<p>“SWING SENSOR SIGNAL 1 ERROR!”</p> <p>“SWING SENSOR SIGNAL 2 ERROR!”</p> <p>“SWING SENSOR ERROR!”</p> <p>“SWING SENSOR LOGIC REPORT!”</p>	<p>Cable from sensor to condition box disconnected.</p> <p>Cable from sensor to conditioning box grounded.</p>	<p>Replace sensor.</p>
<p>“SWING SENSOR COMMS ERROR!”</p>	<p>Cable from conditioning box to computer disconnected at computer or conditioning box.</p> <p>Cable from condition box to computer grounded.</p>	<p>Check cable.</p> <p>Check connection at conditioning box and computer.</p> <p>Replace cable.</p> <p>If display shows load, angle, radius, etc, replace the conditioning box.</p>
<p>Intermittent, inaccurate, or no output activity</p>	<p>WAD/ISS too far from target within swing drive.</p> <p>WAD/ISS sensor too close to target within swing drive.</p> <p>WAD/ISS not responding normally but drawing normal current and providing normal outputs.</p> <p>WAD/ISS disconnected from computer.</p>	<p>Check sensor and sensor connection.</p>

7.3 Replacing the Swing Sensor



Swing Sensor Removal

1. Place the boom in the rest (stowed position).
2. Turn off the power to the crane.
3. Disconnect the sensor cable from the conditioning box.
4. Loosen the sensor retaining nut.
5. Remove the sensor from the swing drive housing.

Swing Sensor Installation

1. Insert the threaded end of the sensor into the sensor port of the swing drive and screw it in until the end of the sensor contacts the gear inside the swing drive housing. Do not force the sensor any farther past this point.
2. Note the location of the index notch on the sensor. Rotate the sensor counterclockwise a $\frac{1}{2}$ turn. (Illustrations on next page.)
3. Note the position of the index notch on the sensor and continue to rotate counterclockwise until the index notch reaches the 'three o'clock' or 'nine o'clock' position.
4. If the initial 180° turn puts the index notch on the 'three o'clock' or 'nine o'clock' position, continue to rotate counterclockwise until the next 'three o'clock' or 'nine o'clock' position is reached.
5. For calibration instructions, refer to **Swing Sensor Setup**.

7.4 Replacing the Conditioning Box

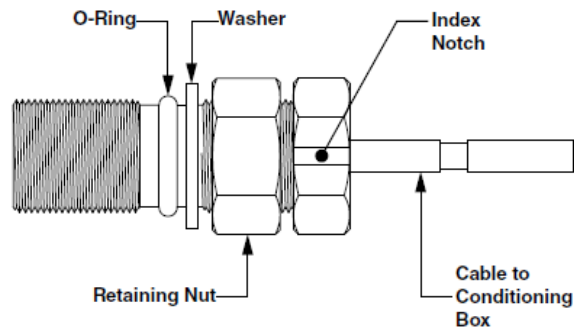
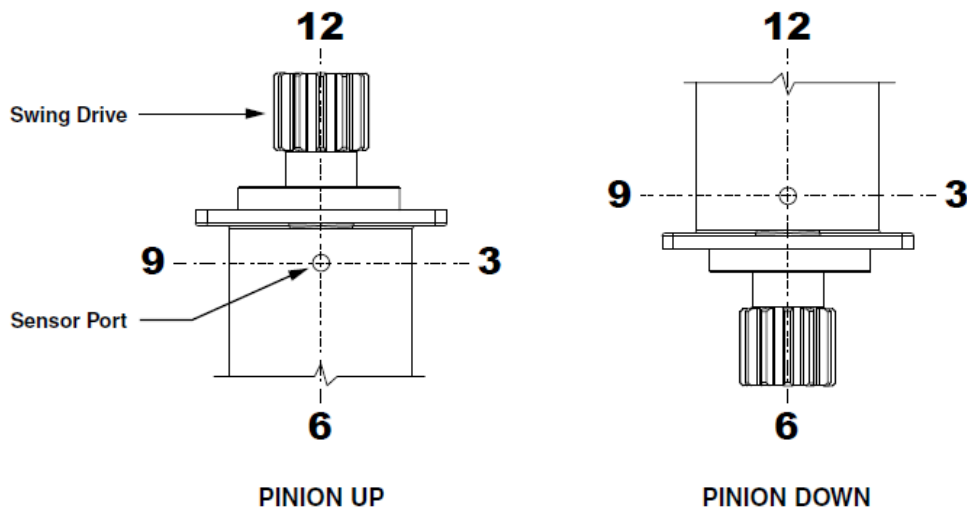
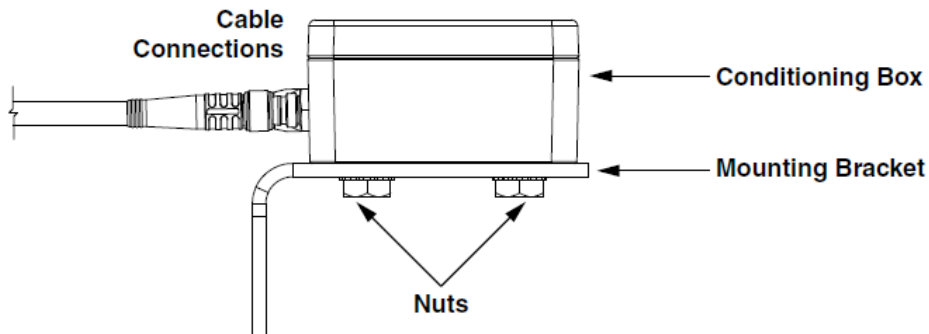

Figure 33 - Swing Sensor Diagram



Replacing the Conditioning Box

1. Place the boom in the rest (stowed position).
2. Turn off power to the crane.
3. Disconnect the cables from the conditioning box.
4. Remove the two nuts attaching the conditioning box to the mounting bracket.
5. Install the new conditioning box onto the mounting bracket.
6. Reconnect the cables to the new conditioning box.





POWER to Move the World™

A **DOVER** COMPANY

11135 South James • Jenks, OK 74037

Phone: (918) 298-8300

Fax: (918) 298-8301

www.team-twg.com

Greer Company is a part of TWG.

As a leader in product innovation, Greer Company is committed to the ongoing improvement of its equipment.
We reserve the right to make changes to our products without notice.

©2013 TWG. All rights reserved.