

**Terrain FUZE HDPE pipe work systems expand and contract with changes in temperature, both ambient temperature and from the temperature of the waste discharge through the pipework. This guide describes the principles of thermal movement allowance and provides advice covering assembly and jointing techniques.**

The advice and guidance is based on typical situations only. For further information refer to the Terrain Soil and Waste installation guide or contact the Terrain Technical Services Department.

Terrain FUZE HDPE offers substantial durability against the flow of hot water. A waste pipe with no mechanical load will tolerate temperatures of up to 80°C and up to 95°C is permissible for a maximum of two minutes.

Thermal movement **MUST** always be accounted for in both locked and expansion systems (explained in the next set of pages).

### Calculating thermal movement

Terrain FUZE HDPE has a coefficient of expansion of 0.2 (mm/m/°C), the design and installation of above ground drainage systems must be able to accommodate for this. Calculate the thermal movement on straight lengths **between anchors** using:

$$\Delta L = \alpha L \Delta T$$

#### Where:

$\Delta L$  = expansion (mm) OR contraction (-mm)

$\alpha$  = co-efficient of linear expansion (mm/m/°C)  
Terrain FUZE HDPE, 0.2

$L$  = Total length of the pipe between anchor points (m)

$\Delta T$  = Temperature difference (°C)

NB. For waste discharges  $\Delta T$  should always be calculated from 0°C, so if the temperature of the water in the pipe is to be 60°C, then  $\Delta T$  is 60°C.

### Example 1 - Typical vertical stack

A 10 storey foul drainage stack will collect and convey domestic waste (assumed temperature 60°C) and connect directly to drain. Each storey is 3m high.

$$\Delta L = \alpha L \Delta T$$

$$\Delta L = 0.2 \times 3.0 \times 60 = 36\text{mm thermal movement per floor.}$$

### Example 2 - Typical suspended pipe run

A 20 metre, high-level lateral run has been designed in an open car park area. The maximum length between anchor points should be 5m. The assumed temperature of the waste fluid is 50°C.

$$\Delta L = \alpha L \Delta T$$

$$\Delta L = 0.2 \times 5.0 \times 50 = 50\text{mm thermal movement between anchor points.}$$

### Vertical expansion system

#### Expansion system anchored below slab

Rail system rules apply as per page 4.

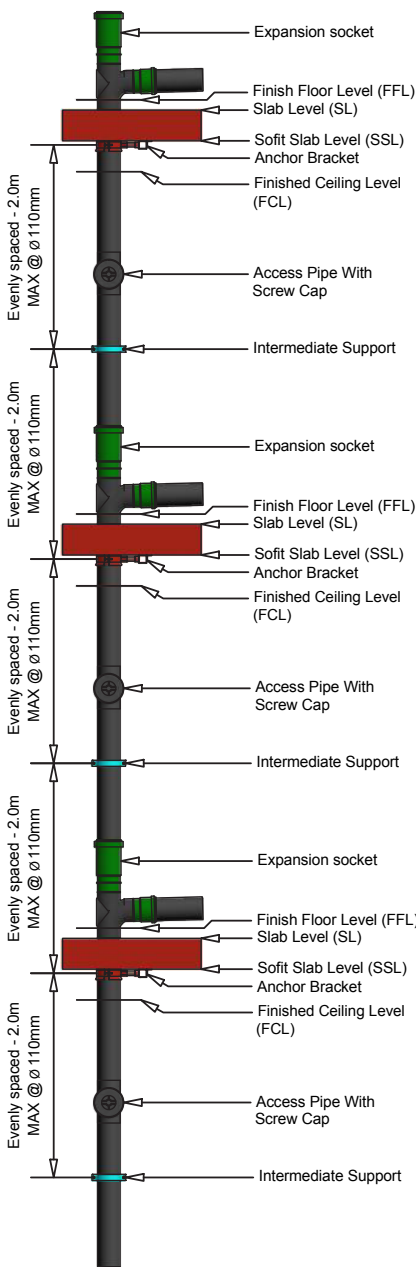

#### Expansion system anchored above slab

Rail system rules apply as per page 4.

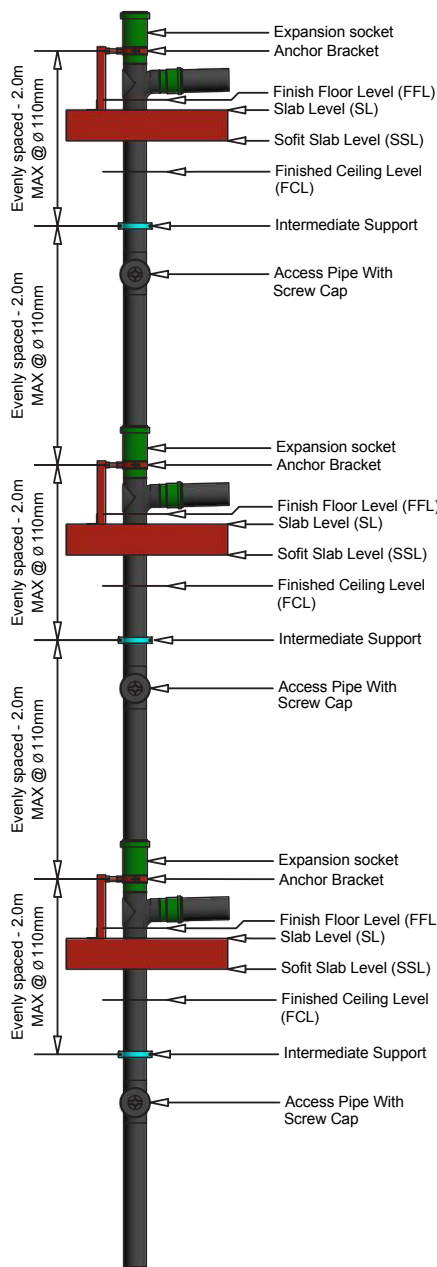

#### Expansion system anchored to a structural wall

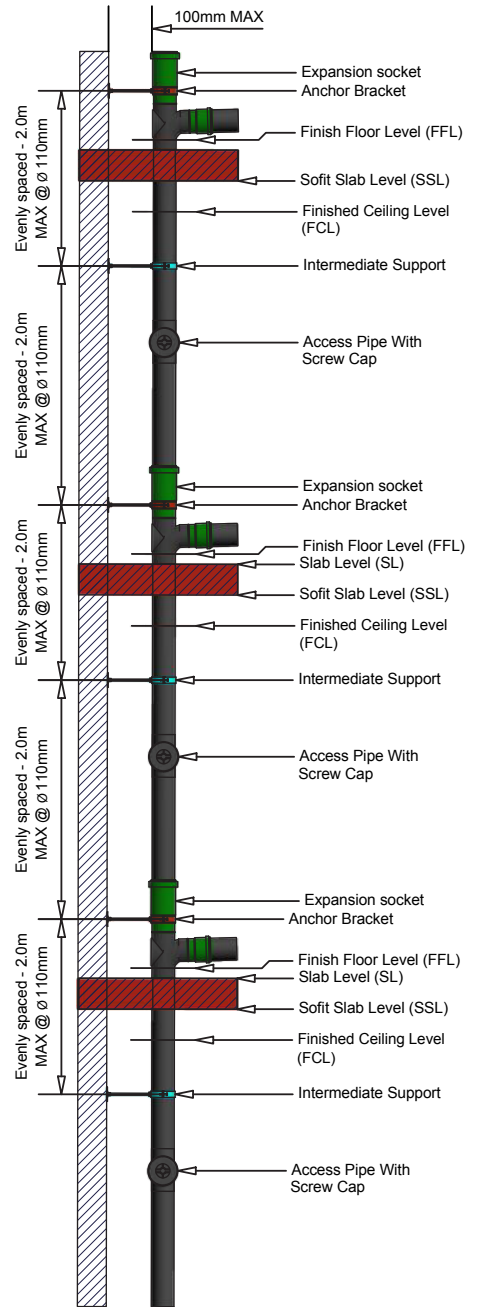

### Horizontal expansion system

#### Support and expansion socket distances

Unless there is an alternative provision for thermal movement, pipework should be fitted with expansion sockets in the following locations:

- At spacing's no greater than 5m for pipework OD Ø75mm and above
- At spacing's no greater than 2m for pipework OD 63mm and below
- Where the maximum distance between fixed points exceeds 2m
- At changes of direction or branch runs greater than 1m in length
- Any point where pipework passes through a floor or wall and is made good or fire-stopped must be treated as an anchor point when determining positions of expansion sockets
- Low Level WC Manifolds incorporate ring seal adaptors at each branch connection to compensate for thermal movement and also allow the branch to be 'turned' to the correct angle to allow connection to the WC

HORIZONTAL EXPANSION SYSTEM		
Pipe size diameter (OD mm)	Maximum distance between expansion sockets (m)	Intermediate support at any change of direction and at below maximum centres (mm)
40	2.0	400
50	2.0	500
56	2.0	560
63	2.0	630
75	5.0	750
90	5.0	900
110	5.0	1100
125	5.0	1250
160	5.0	1600
200	5.0	2000
250	5.0	2500
315	5.0	3000

\* See table on page 9 for pipe weights (empty and full).

#### Example - Ø160mm Pipe

##### Key

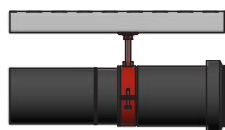

Anchor bracket & Expansion socket

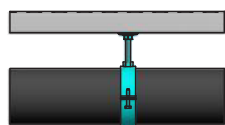

Intermediate support

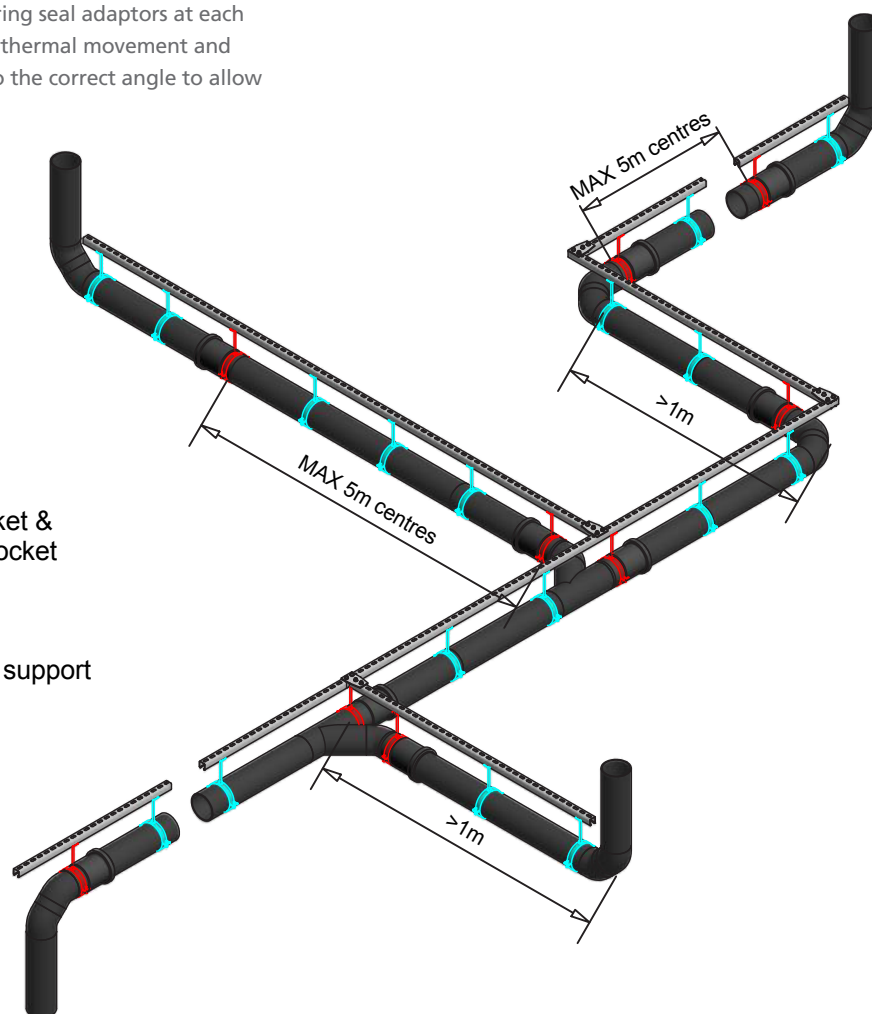

### Bracketing an expansion system

- Terrain FUZE HDPE can be anchored from the slab or off a rail system
- Cross bracing must be used for drop rods longer than figures shown below
- Rails are not supplied by Polypipe Terrain

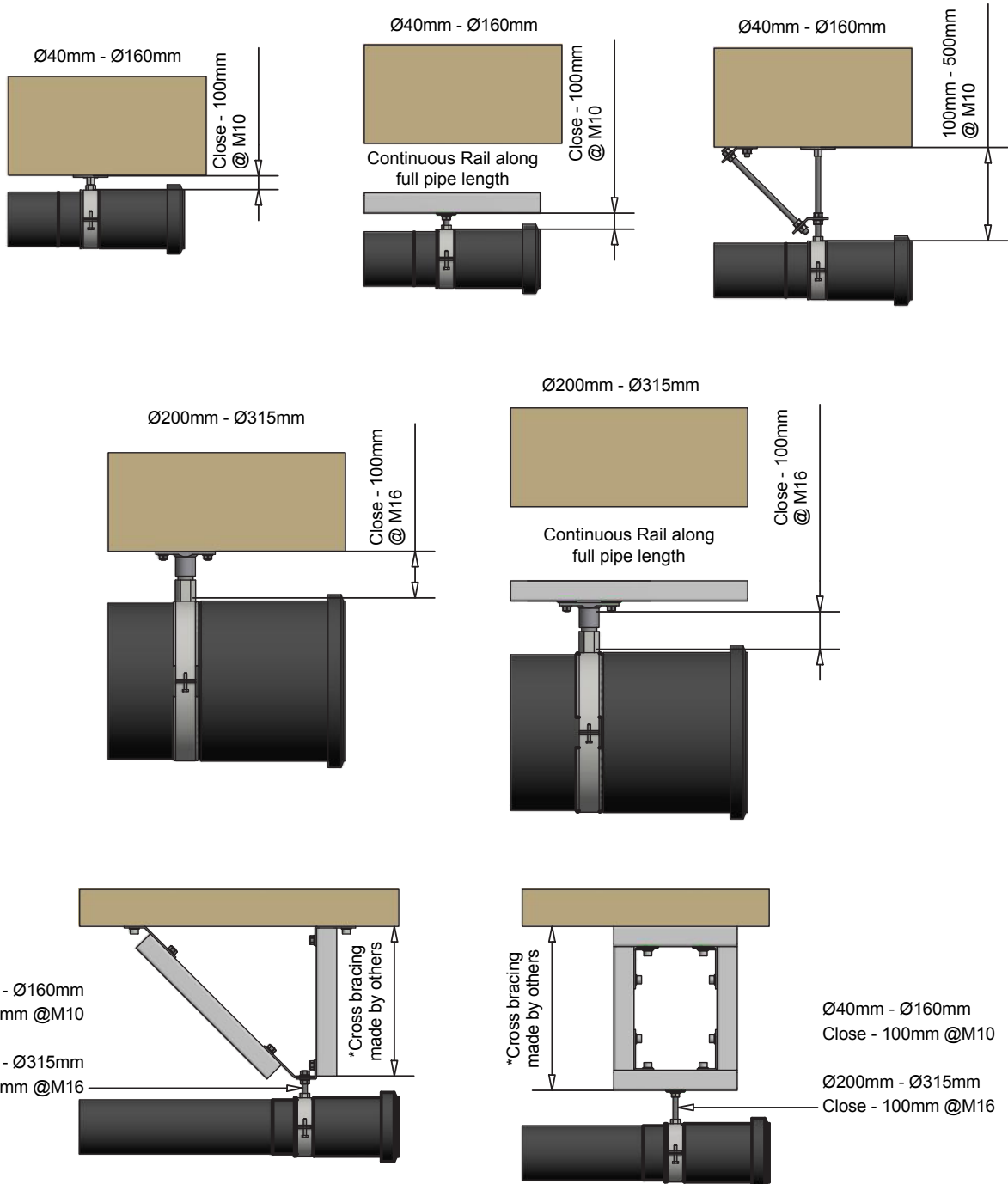

### Example of an expansion system

Expansion sockets may be omitted if alternative provision is created in one of the following ways.

- Above the highest branch connection to a foul and/or waste stack is free to move through a weatherproof sleeve

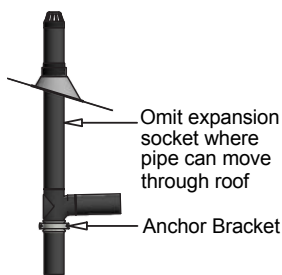

- At the base of an external drainage stack that is connected to a drainage connection that allows movement through an EPDM seal

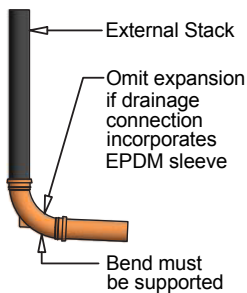

Suspended Pipe in Basement detail:

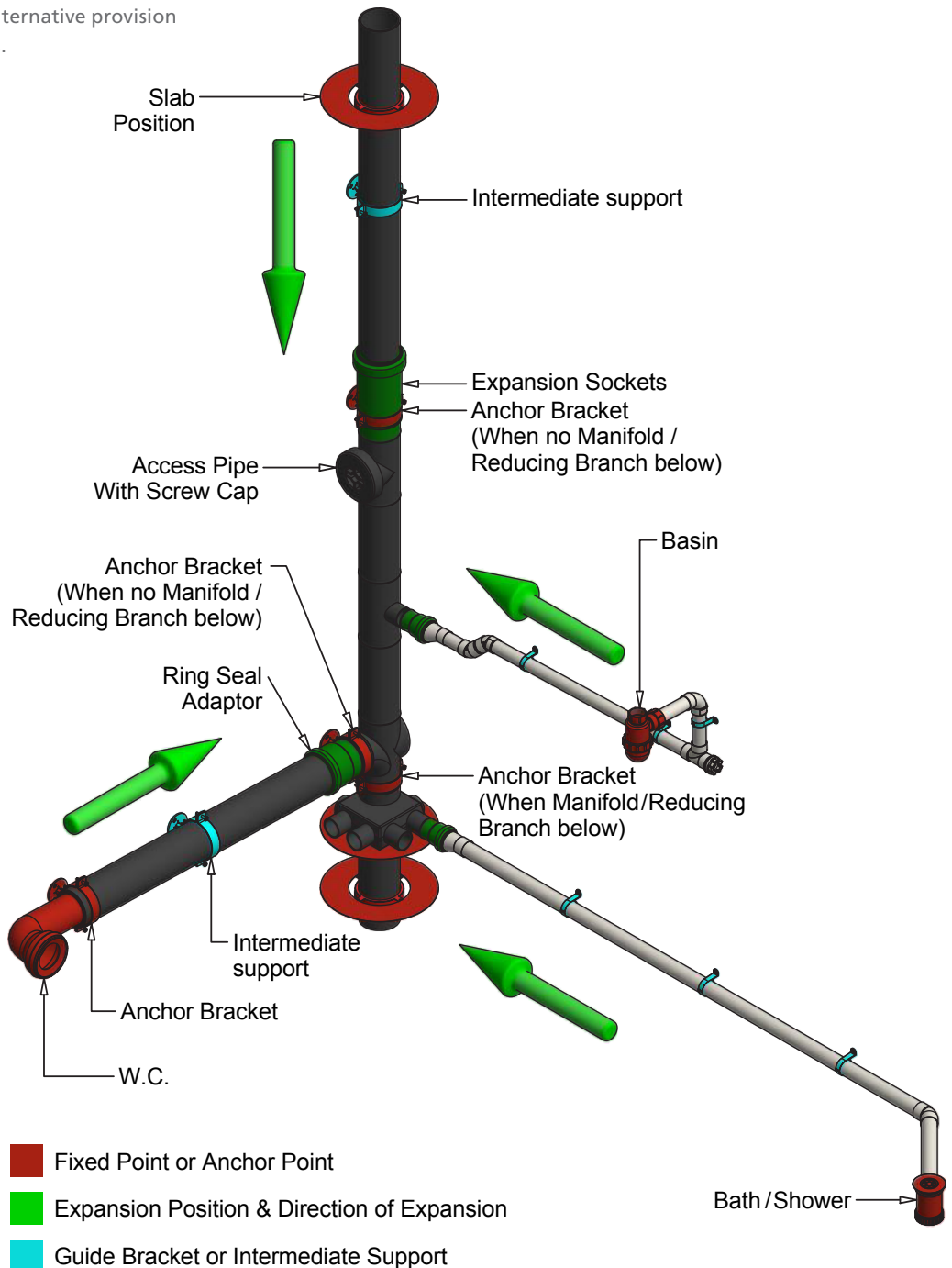
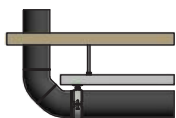

### Vertical locked system

#### Locked system anchored below slab

Rail system rules apply as per page 8.

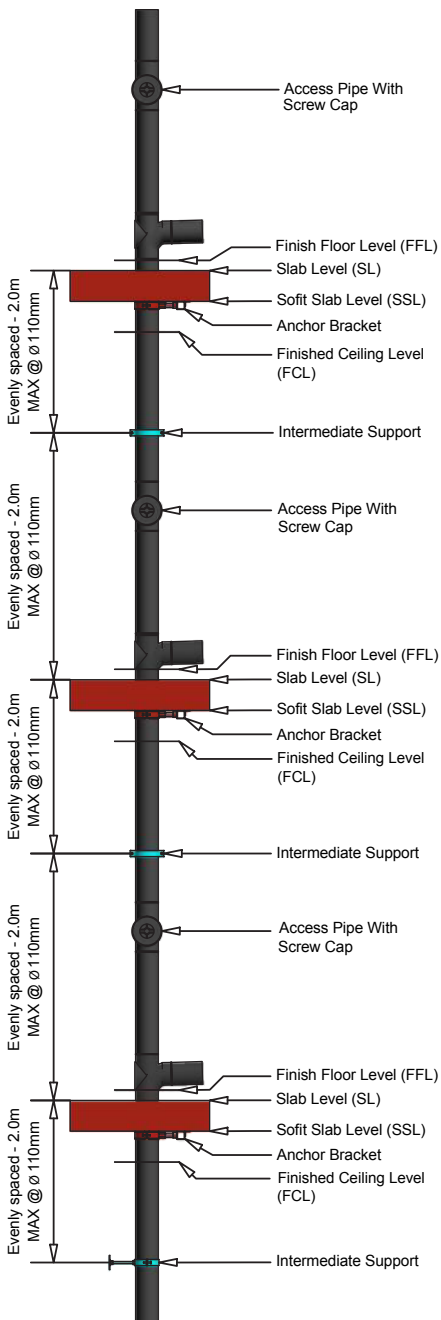

#### Locked system anchored above slab

Rail system rules apply as per page 8.

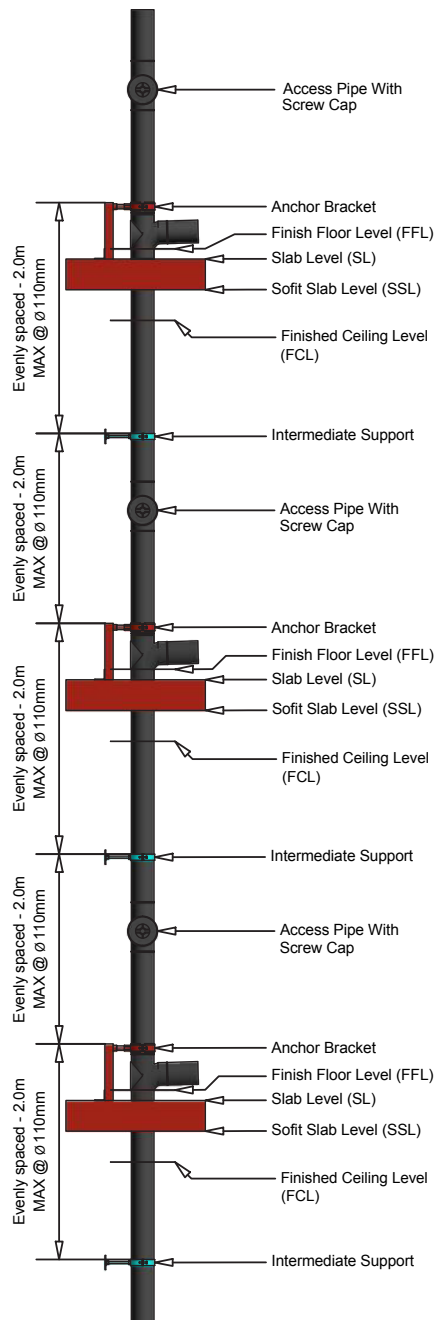

#### Locked system anchored to a structural wall

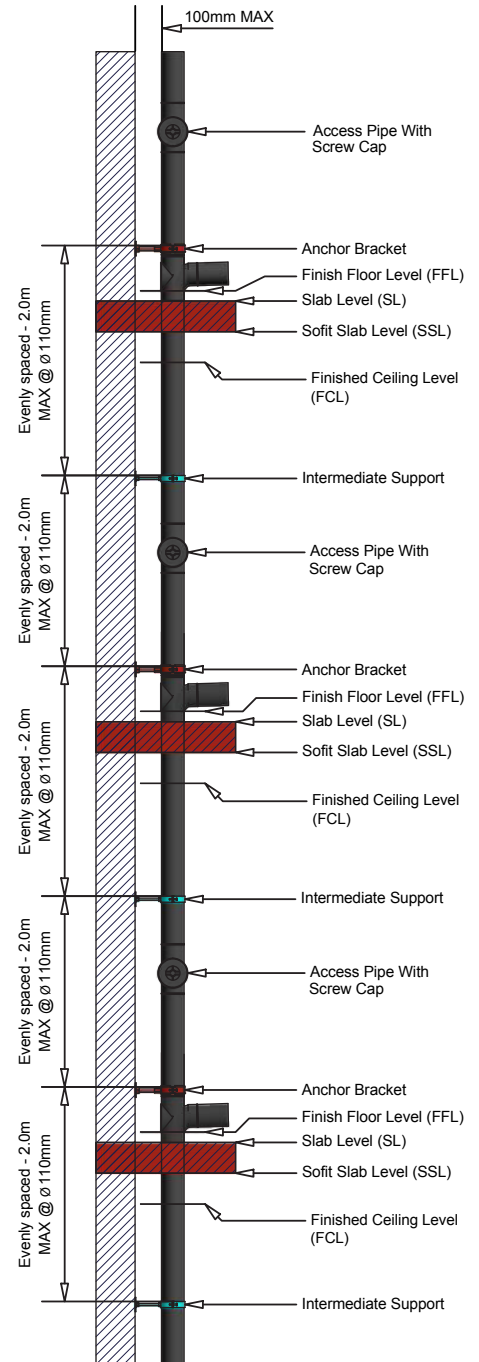

### Horizontal locked system

#### Support and anchor brackets

Unless there is an alternative provision for thermal movement, pipework should be fitted with anchor brackets in the following locations:

- At spacing's no greater than 5m for pipework OD Ø75mm and above
- At spacing's no greater than 2m for pipework OD 63mm and below
- Where the maximum distance between fixed points exceeds 2m
- At changes of direction or branch runs greater than 1m in length
- Any point where pipework passes through a floor or wall and is made good or fire-stopped must be treated as a fixed point when determining positions of anchor brackets

Pipe will still expand and contract into itself in a locked system. Even in a locked system, thermal movement needs to be accounted for.

#### Example - Ø160mm Pipe

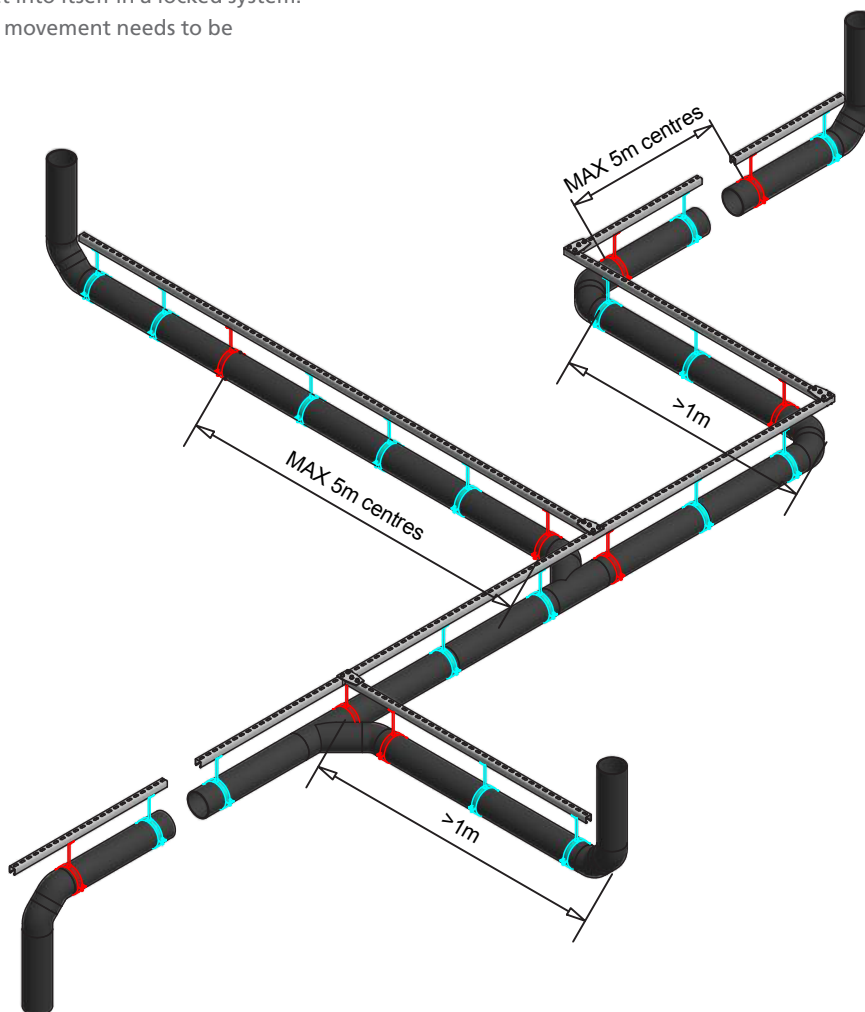
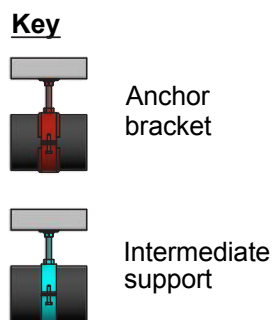

HORIZONTAL LOCKED SYSTEM		
Pipe size (OD mm)	Maximum distance between anchor brackets on straight pipe run (m)	Maximum distance between intermediate supports (mm)
40	2.0	400
50	2.0	500
56	2.0	560
63	2.0	630
75	5.0	750
90	5.0	900
110	5.0	1100
125	5.0	1250
160	5.0	1600
200	5.0	2000
250	5.0	2500
315	5.0	3000

\* See table on page 9 for pipe weights (empty and full).



### Bracketing a locked system

Types of Anchor Brackets on locked rail system.

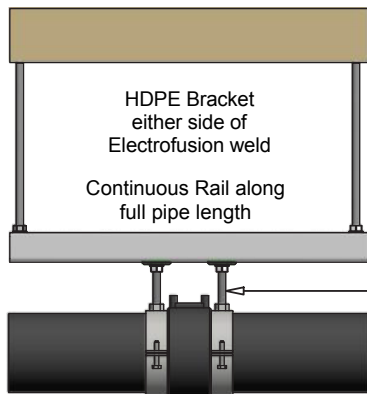

Ø 40 - Ø 160 M10  
Close - 100mm

Ø 200 - Ø 315 M16  
Close - 100mm

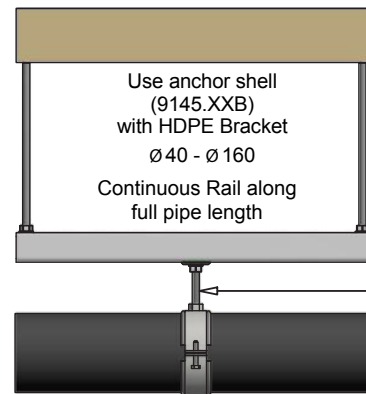

Ø 40 - Ø 160 M10  
Close - 100mm

Ø 200 - Ø 315 M16  
Close - 100mm

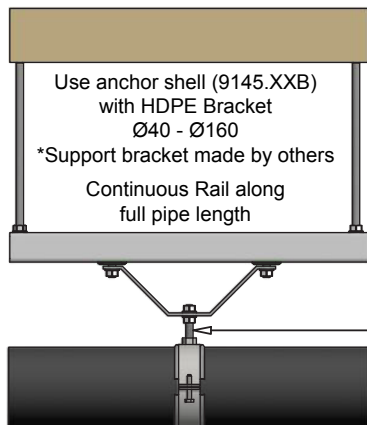

Ø 40 - Ø 160 M10  
Close - 100mm

Ø 200 - Ø 315 M16  
Close - 100mm

Use anchor shell  
(9145.XXB)  
with HDPE Bracket

Ø 40 - Ø 160

\*Support bracket  
made by others

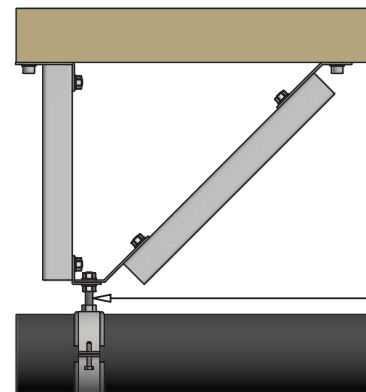

Ø 40 - Ø 160 M10  
Close - 100mm

Ø 200 - Ø 315 M16  
Close - 100mm

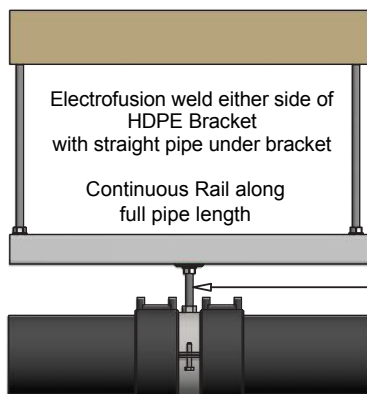

Ø 40 - Ø 160 M10  
Close - 100mm

Ø 200 - Ø 315 M16  
Close - 100mm

Use anchor shell  
(9145.XXB)  
with HDPE Bracket

Ø 40 - Ø 160

\*Support bracket  
made by others

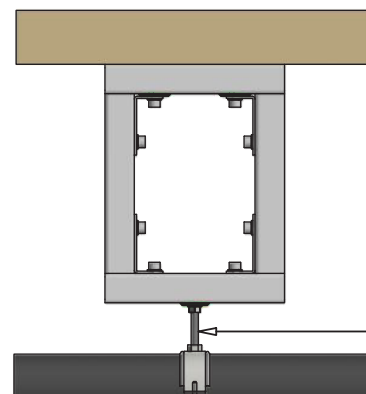

Ø 40 - Ø 160 M10  
Close - 100mm

Ø 200 - Ø 315 M16  
Close - 100mm



### Summary of expansion & locked systems

#### Expansion systems

Rulings for anchor brackets in an **expansion** system:

- Pipe diameters up to 160mm - M10 drop rods up to 100mm below slab or rail
- Pipe diameters up to 160mm - M10 drop rods with M10 cross brace up to 500mm below slab or rail
- Pipe diameters up to 160mm where the vertical drop is greater than listed above use either the rail system or use Unistrut as a drop rod with a cross brace and an M10 connection to the bracket
- Pipe diameters 200-315mm - M16 drop rods up to 100mm below slab or rail
- Pipe diameters 200-315mm where the vertical drop is greater than listed above use either the rail system or use Unistrut as a drop rod with a cross brace and an M16 connection to the bracket

#### Locked systems

Rulings for anchor brackets in a **locked** system:

- In no circumstances should drop rods alone be used to support a locked anchor point
- Close coupled rail system up to 160mm diameter - M10 connection between bracket and rail
- Close coupled rail system 200-315mm diameter - M16 connection between bracket and rail
- Pipe diameters 200-315mm - M16 drop rods up to 100mm below slab or rail
- If the rail is not being used a suitable drop support needs to be created using Unistrut and a cross brace with the same size connections to brackets as listed above for a rail system

Terrain FUZE HDPE Pipe weights:

FUZE HDPE pipe diameter (OD mm)	Pipe weight full of water (Kg/m)	Pipe weight empty (Kg/m)
40	1.278	0.370
50	1.986	0.460
56	2.493	0.530
63	3.147	0.595
75	4.479	0.740
90	6.391	0.980
110	9.525	1.450
125	12.283	1.860
160	20.190	3.080
200	31.741	4.100
250	49.252	6.100
315	78.045	9.510

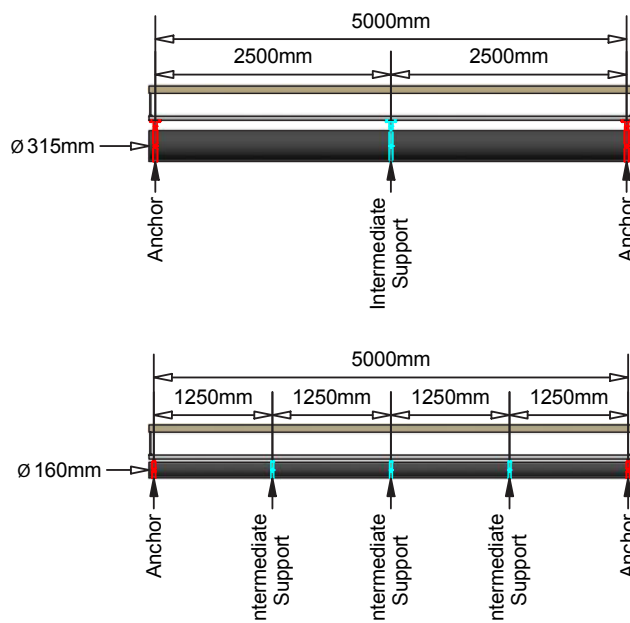

### WC connections

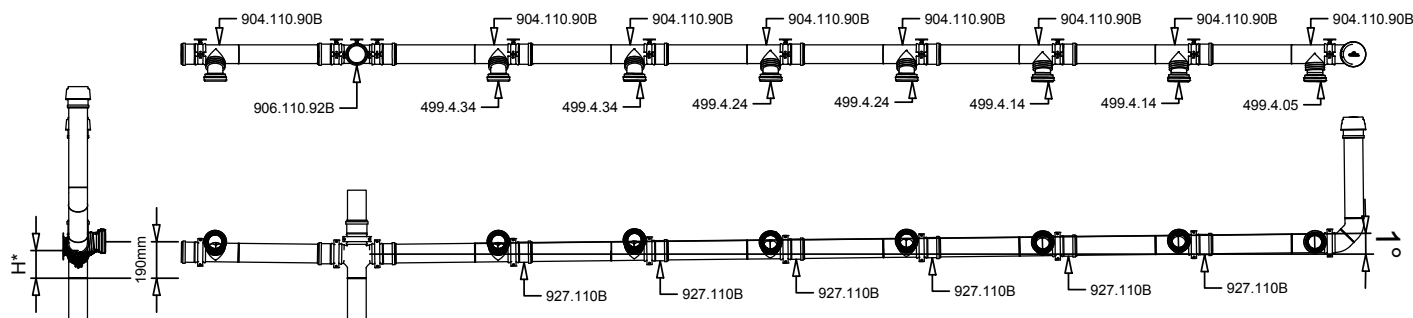

Float laid to a Fall of 1° (17mm drop/1metre run)

Note: If a secondary ventilation system is being installed then expansion must be provided to both the soil and waste stack and the secondary ventilation stack.

Note: It is important to lubricate the ring seal adaptor with silicone grease.(9136.250).

WC position (height H* from FFL)							
H*	1	2	3	4	5	6	7
mm	170	156	142	128	114	100	86

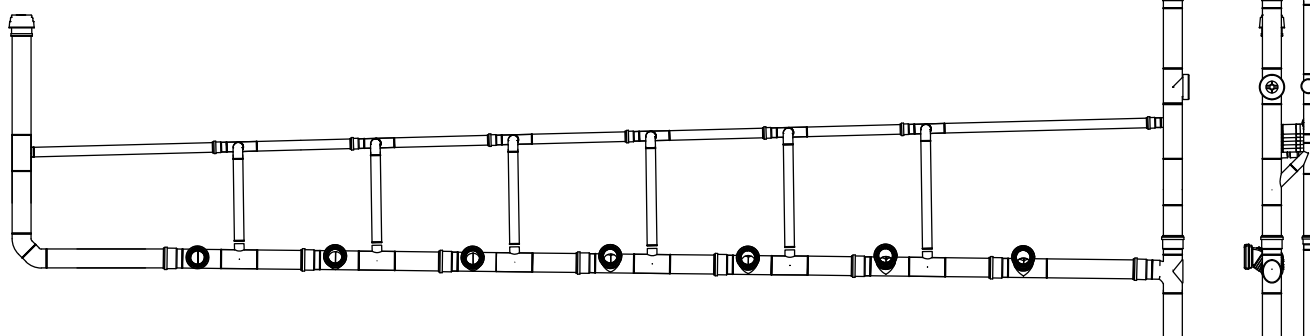

### Risers and Branches

It is recommended that an expansion socket is incorporated at each floor level when designing and installing FUZE HDPE stacks in multi-storey buildings. Where a branch is taken off a main run, the thermal movement of the main run is going to affect the branch.

- Establish the distance between the branch and the nearest anchor
- Calculate the movement at the point where the branch joins the run

- Establish the hole size through the wall and ensure that there is enough space for the branch to naturally flex, taking into account that the movement of the branch will be limited where it passes through a wall
- If there is not enough room for the required offset, think about adding expansion sockets and anchor points to the main run to reduce the amount of movement experienced by the branch



### Contact Us

to find out about our Technical Workshop

Look out  
for our next issue  
- Controlling  
expansion in  
pressure systems