

Terrain FUZE



High performance HDPE system for non-pressure drainage

Technical Manual



At Polypipe, conceiving, designing, manufacturing and delivering the most advanced products and systems isn't merely an occupation. It's a passion. One that's based around a few simple beliefs. Expertise isn't an option. Quality always beats quantity. Products are nothing without service and support. Sustainability isn't just a 'green' word. And working with our customers is much better than simply supplying them.

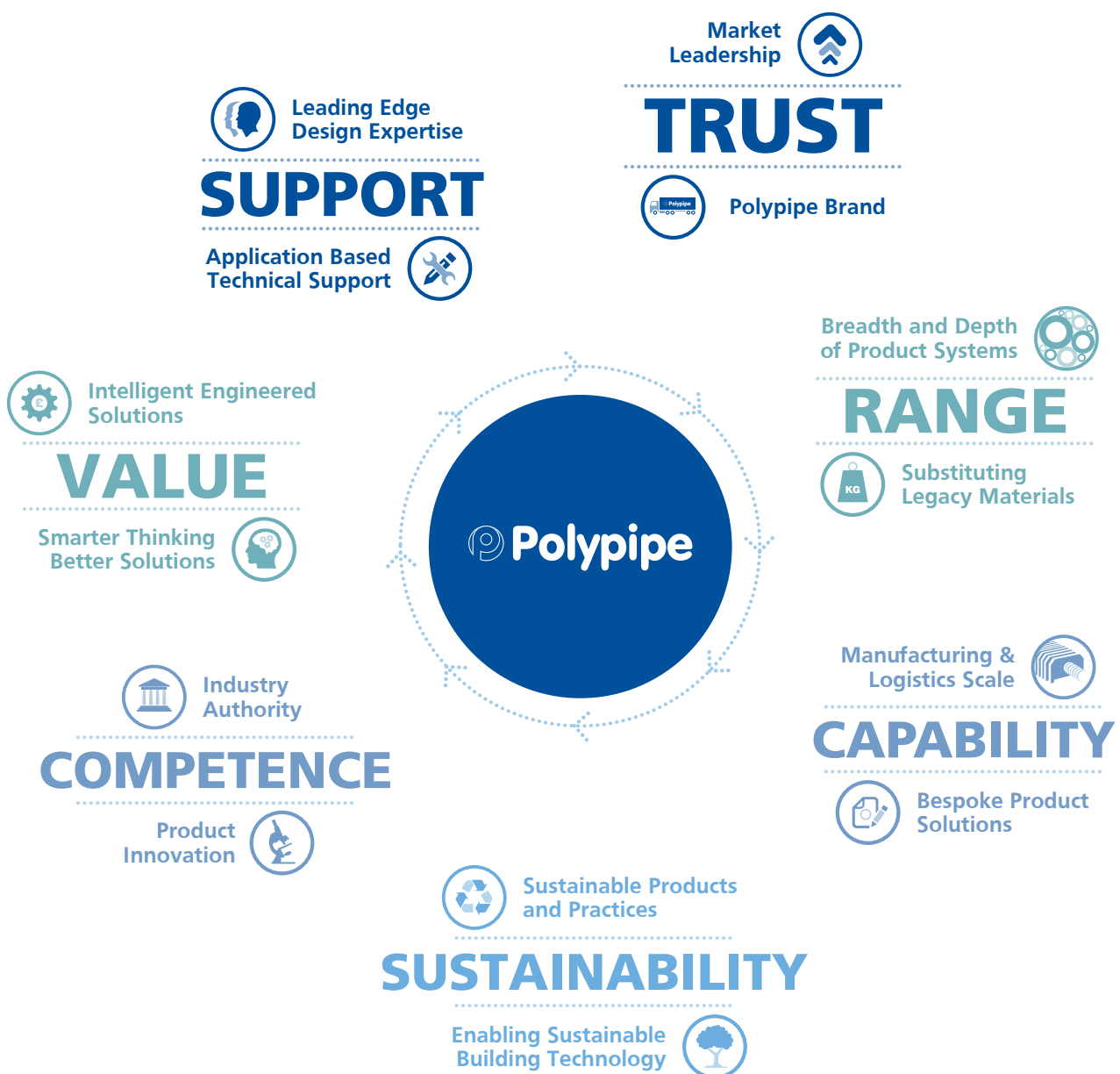



Contents

Terrain FUZE

Standards & Qualities	04 - 05
Features and benefits	06 - 07
Soil and Waste Drainage	08 - 18
Rainwater Drainage	19 - 21
Chemical Drainage	22 - 26
Fabrication	27 - 31
Jointing Methods	32 - 42
Adapting to Other Materials	43 - 44
Installation	45 - 56
Firetrap Sleeves and Collars	57 - 59
System Testing	60 - 61
Soil Pipes and Fittings	62 - 95
FUZE Tooling	96 - 97

Terrain FUZE



A modern high density polyethylene system with many advantages over cast iron and other traditional systems. Terrain FUZE is a top-to-bottom solution for all above and below ground drainage and many chemical waste applications.

It allows specifiers and installers to benefit, by providing them maximum flexibility in their design process. Utilising the intrinsic properties of high-

density polyethylene, Terrain FUZE offers greater benefits above and beyond more traditional materials and performs significantly better when tested for impact and abrasion resistance, chemical corrosion and extreme temperatures. The lightweight nature of Terrain FUZE allows the product to be installed quickly and efficiently, giving direct, resource-saving benefits to specifiers and installers.

For further information see contact details on the back cover of this brochure.

Standards and Quality

Polypipe Quality Assurance

Our Terrain products are accredited to the following Quality Management Systems:

BS EN ISO 9001:2000

BS EN ISO 14001:2004

OHSAS 18001

PASS 99

BES 6001

Terrain FUZE Quality Assurance

Terrain FUZE is manufactured to the standards set out within BS EN 1519:2000 and has achieved third part approval from the British Board of Agrément (BBA) certificate number 07/4479.

Terrain Siphonic Roof Drainage

Terrain Siphonic System complies with BS EN 12056-3:2000 and designs in accordance with BS 8490:2007.

Further information and assistance

Terrain products are backed by a comprehensive technical advisory service, available to provide advice and design guidance on all aspects of above and below ground drainage.

Technical services include:

- On site advice and problem solving.
- Terrain fabrication and fabrication design service.
- For prompt assistance, please contact the Terrain Technical Services Department:

Tel: 01622 795200

Fax: 01622 795263

www.polypipe.com/commercial-property-public-buildings



Terrain FUZE



Terrain High Density Polyethylene HDPE: Density 945 - 965 kg/m³

Polyethylene density varies between 945 – 965 kg/m³. Terrain FUZE retains exceptional quality and durability at up to 965 kg/m³ giving great confidence to specifiers and installers. HDPE is a lighter material than water, offering direct benefits in handling, transportation and installation.



Resistance to cold

Terrain FUZE pipes are resistant to freezing within the pipeline. When tested, the pipes simply expand with the ice and then return to their original dimensions without any damage.



Flexibility

Flexibility of a pipeline can be a major factor on certain building projects where concern must be given to the route of the pipeline through expansion joints or areas subject to vibrations.



Resistance to abrasion

HDPE offers greater abrasion resistance through increased strength within the walls of the pipeline. This additional protection of the pipe makes HDPE an effective material for branch pipes, soil stacks and ground pipes.



Heat expansion 0.2mm/m – K

Expansion of the HDPE pipeline should be anticipated when put under heat stress. As a general rule, an expansion rate of 10mm per linear metre for every 50°C should be allowed.



Resistance to hot water

Terrain FUZE offers substantial durability against the flow of hot water. A waste pipe with no mechanical load will tolerate temperatures of up to 80°C and up to 95°C is permissible for a maximum of two minutes.



Resistance to impact

Terrain FUZE ensures maximum strength against impact stresses and is unbreakable at room temperature. It still maintains a high impact resistance at temperatures as low as -40°C thus meets the requirements for outlet pipes.



Condensate

Terrain FUZE is a poor heat conductor thus preventing condensation from forming as the pipeline undergoes short periods of intense undercooling.



Behaviour in fire

HDPE in open construction is a flammable material. However, the material has been installed throughout Europe for over 40 years and poses no greater risk to fire spread than other similar plastic based systems when installed in accordance with local fire regulations. For further prevention, Terrain FUZE should be fitted with Terrain fire collars (See Polypipe Terrain Trade Price List) and these should be installed in strict accordance with instructions provided.

Features and Benefits



Noise

HDPE has a low E-modulus and limits solid-borne conduction along the pipeline. Airborne noise should be insulated by utilising a duct wall.



Resistance to chemicals

Terrain FUZE offers high resistance against chemical corrosion and is insoluble in all inorganic and organic solutions at 20°C. Terrain FUZE is only susceptible to aliphatic and aromatic carbons and relative chlorination products over 90°C. The material is also vulnerable to attack by heavily oxidised media conc. HNO_3 (chemical equation), conc. H_2SO_4 (chemical equation) when exposed over long periods at room temperature.



Non-conductive

HDPE like most plastics has an exceptional reputation as an insulator.



Protection against blockages

Terrain FUZE enables the continual flow of waste through the pipe, reducing the possibility of blockages along the pipeline.



Sealing material

The rubber ring on the seal is installed under compression on all sides and is protected from expansion so, although the chemical resistance of the seal does not equate to that of HDPE, there is no risk of the seal being destroyed.



Welding temperature

With a much lower welding temperature of 210°C, HDPE is a much safer and easier material to work with compared to metal. This enables processing of the material using simple tools and in a more energy efficient manner.



Non-toxic

Terrain FUZE pipes are non-toxic, ensuring safe handling during installation. With no risk of contamination to the flow through the pipeline, HDPE is even suitable for use in the food or liquid transportation industries.



Scope of use

Terrain FUZE offers exceptional performance as a drainage system. A maximum load of 15m Water Column (1.5 bar) temperature of 30°C (10years) should be considered when utilising the pipes in a low-pressure environment.

Terrain FUZE

A waste system should be installed on a project to facilitate:

- Ease of access and maintenance to all parts of the system
- Flexible expansion of the system and integration with other pipe systems

Straight sections of horizontal pipe must be installed in perfect alignment with the pipe's axis and parallel to the wall. Vertical sections of the pipeline should be fixed in perfect alignment with the axis. Right angle bends must only be used to connect horizontal and vertical pipes and not within horizontal pipe networks.

Branches in the soil stack must be created using fittings with an angle less than 90°. Eccentric reductions must be used, when the pipe diameter varies in the horizontal branch pipes, to ensure a centred connection of the pipes at the axis line. To minimise reductions in speed and other negative effects variances in the direction of the horizontal and vertical pipe system must be kept to a minimum and use large radius bends. The stack vent should protrude by 2m above the roof structure where possible, and never less than 0.3m. Ventilating pipes to the outside air should finish at least 900mm above any opening into the building within 3m.

The access pipes must have the same opening as all pipes up to diameter 110mm, where the diameter is greater than 110mm the access pipe must be at least 110mm.

Access pipes should be installed in the following cases:

- At the beginning of the main manifolds in the waste system and at the base of every internal soil stack
- Access pipes should be installed every 15m for a linear stretch of pipe with a diameter equal to or less than 110mm and every 30m for larger diameter pipes
- Wherever two or more branches connect

Access pipes must be within easy reach throughout the system and must offer sufficient space for the use of utensils to clean the pipes.

The use of HDPE soil & waste pipe and fittings

The elements of the HDPE total pipe system offer direct benefits to the specifier and installer over more traditional materials. These benefits cover:

- HDPE is easier than more traditional materials to transport and handle safely due to its light weight.
- HDPE is installed quicker and easier than more traditional materials, offering increased time and labour savings on-site
- HDPE is resistant to impact shock
- Due to its composition, HDPE is highly resistant to chemical attack and will not erode, ensuring a long life for the system
- Terrain FUZE offers system flexibility, where alterations can be made easily to a completed system
- A smooth inner surface of the pipe minimises the risk of build-up or scaling
- HDPE welded joints will not deteriorate over time as no other materials or solvents are used
- HDPE can be used in close proximity to electrical installations or systems as it is not subject to electrolytic action
- Terrain FUZE offers a broad range of bespoke and fabricated items to be used in conjunction with the product ranges

Terrain FUZE offers a wide range of additional drains, traps, hoses and adaptors to be used with the standard catalogue of pipes and fittings, enabling HDPE products to be connected to other materials such as PVC, cast iron and cement pipes. This enables Terrain FUZE products to be used in an extensive range of applications, for example, in below ground applications when waste pipes with butt welded or electrofusion welded joints are utilised.

Soil and Waste Drainage

Table A: Discharge units (DU) Values

Appliance	System III DU l/s
Wash basin, bidet	0.3
Shower without plug	0.4
Shower with plug	1.3
Single urinal with cistern	0.4
Urinal with flushing valve	-
Slab urinal	0.2*
Bath	1.3
Kitchen sink	1.3
Dishwasher (household)	0.2
Washing machine up to 6kg	0.6
Washing machine up to 12Kg	1.2
WC with 4.0L cistern	**
WC with 6.0L cistern	1.2 to 1.7***
WC with 7.5L cistern	1.4 to 1.8***
WC with 9.0L cistern	1.6 to 2.0***
Floor gully DN 50	-
Floor gully DN 70	-
Floor gully DN 100	-

* Per person.

** Not permitted.

*** Depending upon type (valid for WC's with siphon flush cistern only).

- Not used or no data.

Example:

10 storey building with

2 WC	} On each floor
4 WHB	
2 Baths	
2 Sinks	
2 W/MC	

$$2 \times 1.5 = 3.0$$

$$4 \times 0.3 = 1.2$$

$$2 \times 1.3 = 2.6$$

$$2 \times 1.3 = 2.6$$

$$2 \times 0.6 = 1.2$$

$$10.6 \times 9 = 95.4 \text{ DU}$$

Domestic Building Use $K = 0.7$

$$0.7 \sqrt{95.4} = 6.84 \text{ l/s}$$

See Table C and D for capacities of pipes.

Table B: Typical frequency factors (K)

Usage of appliances	K
Intermittent use, e.g. in dwelling, guest-house, office	0.5
Frequent use, e.g. in hospital, school, restaurant, hotel	0.7
Congested use, e.g. in toilets and/or showers open to public	1.0
Special use, e.g. laboratory	1.2

Frequency factor (K)

Typical frequency factors associated with different usage of appliances Table B.

Calculation of flowrate

Waste water flowrate (Q_{ww})

Q_{ww} is the expected flowrate of waste water in a part or in the whole drainage system where only domestic sanitary appliances are connected to the system

$$Q_{ww} = K \sqrt{\sum DU}$$

where:

$$Q_{ww} = \text{Waste water flowrate (L/s)}$$

$$K = \text{Frequency factor}$$

$$\sum DU = \text{Sum of discharge units.}$$

NB: Under no circumstances should pipe of a larger diameter be connected to pipe of a smaller diameter in the direction of flow.

Terrain FUZE

Table C: Stack with only Primary Vent

Stack & Stack Vent	System I, II, III, IV Q max (L/s)	
	DN	Square # entries Swept entries
60	0.5	0.7
70	1.5	2.0
80*	2.0	2.6
90*	2.7	3.5
100**	4.0	5.2
125	5.8	7.6
150	9.5	12.4
200	16.0	21.0

* Minimum size where WC's are connected in system II.

** Minimum size where WC's are connected in system I, III, IV. # Equal branch junctions that are more than 45°, or has a centre line radius less than the internal pipe diameter.

Table D: Stack with Secondary Venting

Stack & Stack Vent	Secondary Vent	System I, II, III, IV Q max (L/s)	
		DN	Square # entries Swept entries
60	50	0.7	0.9
70	50	2.0	2.6
80*	50	2.6	3.4
90*	50	3.5	4.6
100**	50	5.6	7.3
125	70	7.6	10.0
150	80	12.4	18.3
200	100	21.0	27.3

* Minimum size where WC's are connected in system II.

** Minimum size where WC's are connected in system I, III, IV. # Equal branch junctions that are more than 45°, or has a centre line radius less than the internal pipe diameter.

For branch pipe sizing based on System III the following sizing charts should be used.

Appliance	Dia. DN	Min. trap seal depth (mm)	Max. length (L) of pipe from trap outlet to stack (m)	Pipe gradient	Max. no. of bends	Max. drop (H) (m)
Limitations for unventilated branch discharge pipes, system III						
Washbasin, bidet (30mm diameter trap)	30	75	1.7	2.2 ¹⁾	0	0
Washbasin, bidet (30mm diameter trap)	30	75	1.1	4.4 ¹⁾	0	0
Washbasin, bidet (30mm diameter trap)	30	75	0.7	8.7 ¹⁾	0	0
Washbasin, bidet (30mm diameter trap)	40	75	3.0	1.8 to 4.4	2	0
Shower, bath	40	50	No Limit ²⁾	1.8 to 9.0	No Limit	1.5
Bowl urinal	40	75	3.0 ³⁾	1.8 to 9.0	No Limit ⁴⁾	1.5
Trough urinal	50	75	3.0 ³⁾	1.8 to 9.0	No Limit ⁴⁾	1.5
Slab urinal ³⁾	60	50	3.0 ³⁾	1.8 to 9.0	No Limit ⁴⁾	1.5
Kitchen sink (40mm diameter trap)	40	75	No Limit ²⁾	1.8 to 9.0	No Limit	1.5
Household dishwasher or washing machine	40	75	3.0	1.8 to 4.4	No Limit	1.5
WC with outlet up to 80mm ⁶⁾	75	50	No Limit	1.8 min	No Limit ⁴⁾	1.5
WC with outlet greater than 80mm ⁶⁾	100	50	No Limit	1.8 min	No Limit ⁴⁾	1.5
Food waste disposal ⁷⁾	40 min	75 ⁸⁾	3.0 ³⁾	13.5 min	No Limit ⁴⁾	1.5
Sanitary towel disposal unit	40 min	75 ⁸⁾	3.0 ³⁾	5.4 min	No Limit ⁴⁾	1.5
Floor drain	50	50	No Limit ³⁾	1.8 min	No Limit	1.5
Floor drain	50	50	No Limit ³⁾	1.8 min	No Limit	1.5
Floor drain	100	50	No Limit ³⁾	1.8 min	No Limit	1.5
4 basins	50	75	4.0	1.8 to 4.4	0	0
Bowl urinals ³⁾	50	75	No Limit ³⁾	1.8 to 1.9	No Limit ⁴⁾	1.5
Maximum of 8 WC's ⁶⁾	100	50	15.0	0.9 to 9.0	2	1.5
Up to 5 spray tap basins ⁹⁾	30 max	50	4.5 ³⁾	1.8 to 4.4	No Limit ⁴⁾	0

- 1) Steeper gradient permitted if pipe is less than maximum permitted length.
- 2) If length is greater than 3m noisy discharge may result with an increased risk of blockage.
- 3) Should be as short as possible to limit problems with deposition.
- 4) Sharp throated bends should be avoided.
- 5) For slab urinal for up to 7 persons. Longer slabs to have more than one outlet.
- 6) Swept-entry branches serving WC's.
- 7) Includes small potato-peeling machines.
- 8) Tubular not bottle or resealing traps.
- 9) Spray tap basins shall have flush-grated wastes without plugs.

Ventilated discharge branches: Sizes and limitations upon the use of ventilated discharge branches are given in the tables above. Limitations given in the second table are simplifications, for further information see national and local regulations and practice.

Appliance	Dia. DN	Min. trap seal depth mm	Max. length (L) of pipe from trap outlet to stack m	Pipe gradient	Max. no. of bends	Max. drop (H) m
Limitations for ventilated branch discharge pipes, system III						
Washbasin, bidet (30mm diameter trap)	30	75	3.0	1.8 min	2	3.0
Washbasin, bidet (30mm diameter trap)	40	75	3.0	1.8 min	No Limit	0
Shower, bath	40	50	No Limit ²⁾	1.8 min	No Limit	No Limit
Bowl urinal	40	75	3.0 ³⁾	1.8 min	No Limit ⁴⁾	3.0
Trough urinal	50	75	3.0 ³⁾	1.8 min	No Limit ⁴⁾	3.0
Slab urinal ³⁾	60	50	3.0 ³⁾	1.8 min	No Limit ⁴⁾	3.0
Kitchen sink (40mm diameter trap)	40	75	No Limit ²⁾	1.8 min	No Limit	No Limit
Household dishwasher or washing machine	40	75	No Limit ³⁾	1.8 min	No Limit	No Limit
WC with outlet up to 80mm ⁶⁾ & 14)	75	50	No Limit	1.8 min	No Limit ⁴⁾	1.5
WC with outlet greater than 80mm ⁶⁾ & 14)	100	50	No Limit	1.8 min	No Limit ⁴⁾	1.5
Food waste disposal ⁷⁾	40 min	75 ⁸⁾	3.0 ³⁾	13.5 min	No Limit ⁴⁾	3.0
Sanitary towel disposal unit	40 min	75 ⁸⁾	3.0 ³⁾	5.4 min	No Limit ⁴⁾	3.0
Bath drain, floor drain	50	50	No Limit ³⁾	1.8 min	No Limit	No Limit
Floor drain	70	50	No Limit ³⁾	1.8 min	No Limit	No Limit
Floor drain	100	50	No Limit ³⁾	1.8 min	No Limit	No Limit
5 basins ⁹⁾	50	75	7.0	1.8 to 4.4	2)	0
10 basins ^{9) & 10)}	50	75	10.0	1.8 to 1.9	No Limit	0
Bowl urinals ^{9) & 11)}	50	70	No Limit ³⁾	1.8 min	No Limit ⁴⁾	No Limit
More than 8 WC's ⁶⁾	100	50	No Limit	0.9 min	No Limit	No Limit
Up to 5 spray tap basins ⁹⁾	30 max	50	No Limit ³⁾	1.8 to 4.4	No Limit ⁴⁾	0

- 1) For maximum distances from trap to vent (see Figure 8 of BS EN 1205-2:2000).
- 2) If length is greater than 3m noisy discharge may result with an increased risk of blockage.
- 3) Should be as short as possible to limit problems with deposition.
- 4) Sharp throated bends should be avoided.
- 5) For slab urinal for up to 7 persons. Longer slabs to have more than one outlet.
- 6) Swept-entry branches serving WC's.
- 7) Includes small potato-peeling machines.
- 8) Tubular not bottle or resealing traps.
- 9) See Figure 9 of BS EN 12056-2:2000.
- 10) Every basin shall be individually ventilated.
- 11) Any number.
- 12) Spray tap basins shall have flush-grated wastes without plugs.
- 13) The size of ventilating pipes to branches from appliances can be DN 25 but, if they are longer than 15m or contain more than five bends, a DN 30 pipe shall be used.
- 14) If the connection of the ventilating pipe is liable to blockage due to repeated splashing or submergence, it should be DN 50, up to 50mm above the spill-over of the appliance.

Soil and Waste Drainage

Terrain Drainage Ventilation System

Terrain soil & waste products represent the industry benchmark for quality, installation, flexibility and product innovation, backed by the highest levels of customer service. Terrain systems comprise of an extensive range of soil & waste drainage products, including the Terrain Pleura system, a unique alternative engineered ventilation solution for high-rise buildings.

- Unique products offering unrivalled installation options
- High quality finish
- Suitable for all types of commercial and residential high-rise buildings
- Extensive technical experience to support and advise on all aspects of design and installation
- Fully accredited product systems

As you would expect from a market leader our products come with all relevant standards including:

Manufacturing Standards

BS EN 12380 A1 Air Admittance Valve (Pleura System)

Quality Management Systems Standards

EN ISO 9001:2008 Management System

EN ISO14001:2004 Management System

BS OHSAS 18001:2007 Management System

PASS 99:2006 Integrated Management Registration



Terrain FUZE

Ventilation Drainage Pipework Systems

The design of modern building drainage and ventilation systems has been developing since the 19th century.



A minimum of 50mm of water is all that protects the occupants of a building from potentially harmful sewer gases and 'particulates'. Therefore, a good design must consider the integrity of the trap seal and protect it from being lost. One way of doing this is to consider the air flow within the system, as this is the primary reason for trap seal breach. The flow of air within the drainage pipework system is equally as important as the flow of

water in maintaining a safe and hygienic drainage system. This is because the flow of water creates both positive and negative air fluctuations which can compromise water trap seals and upset the equilibrium in the system. Installation of a secondary stack is traditionally the answer to help alleviate the pressure within the system, however, this modern method of drainage ventilation saves cost, time, floor space and is a more efficient solution.

Soil and Waste Drainage

Terrain P.A.P.A[®] and Pleura Drainage Ventilation System

The smarter air pressure and drainage ventilation system for high-rise buildings.

Following several years of theoretical and practical research into both positive and negative transient pressure fluctuations in drainage systems, the Terrain Pleura system provides both an intelligent and integrated solution for balancing the ambient air pressure within a drainage system.

Terrain P.A.P.A[®] and Pleura drainage ventilation system; how it works:

Terrain Pleura regulators balance negative air pressure fluctuations whilst a positive pressure reduction device (P.A.P.A) balances positive pressures. Together, they protect the water trap seal from damage by forming a highly effective alternative solution for maintaining ambient air pressure within the drainage pipework system – whilst trapping foul air and introducing fresh air into the built environment.

Terrain P.A.P.A can be installed with all of our fabricated soil and waste drainage stacks.

To find out more, visit
www.polypipe.com/terrain-drainage-stacks

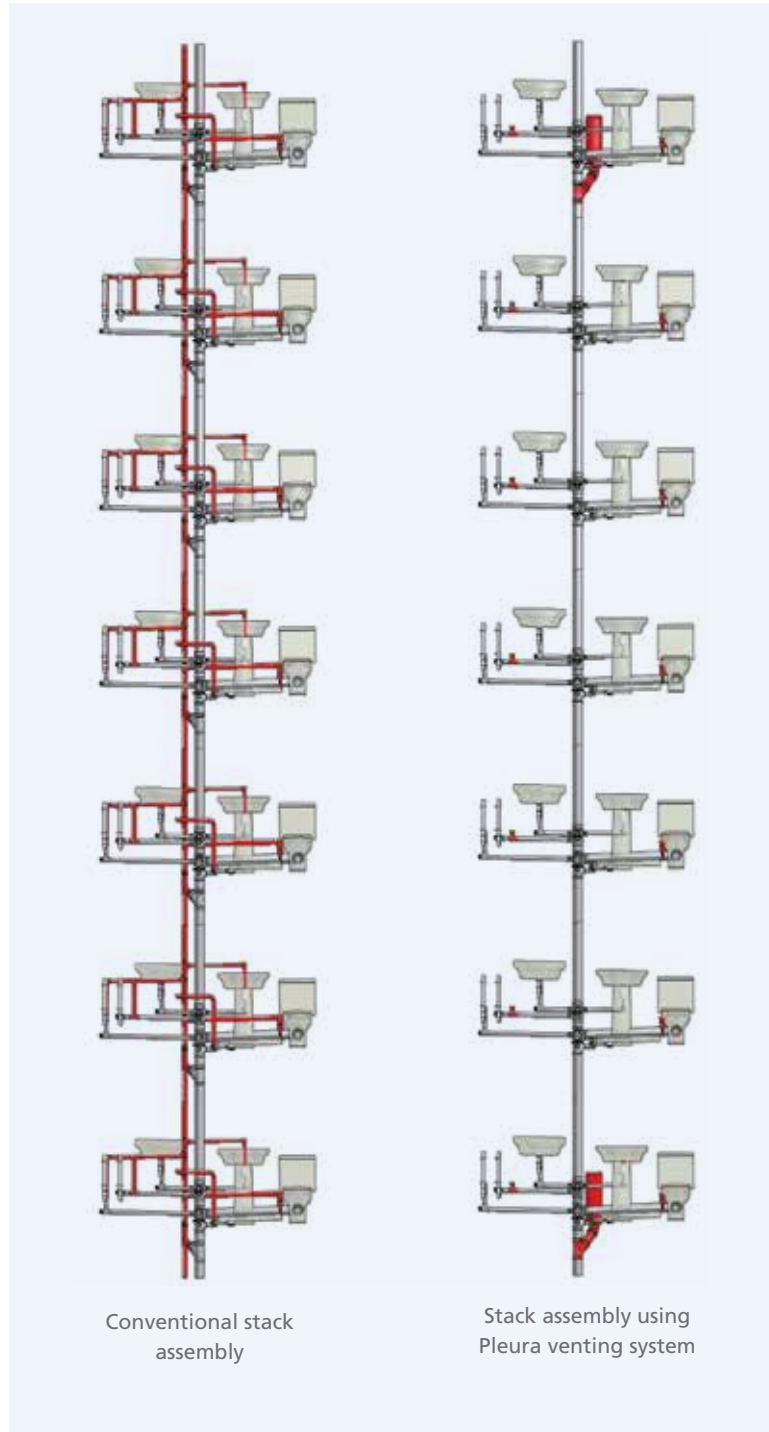

Terrain FUZE

Terrain Pleura 50

The Terrain Pleura 50 air regulator provides ventilation to branch pipework. It is generally installed on the pipe behind the appliance trap.

The Terrain Pleura 50 opens and admits fresh air into the branch pipe when the negative (suction) pressure occurs from an appliance discharging into the pipework system. This equalises the ambient air pressure within the pipework and protects the trap seal.

When the flow stops and the internal ambient air pressure in the pipework balances, the Terrain Pleura 50 closes by gravity and prevents foul air entering the built environment.

Terrain Pleura 100

The Terrain Pleura 100 air regulator can be fitted on to the top of a foul or waste stack or at the end of long low gradient branch drains to provide ventilation.

The Terrain Pleura 100 opens and admits fresh air under condition of reduced pressure in the discharge pipes and prevents trapped water seals being drawn. As the internal ambient air pressure in the pipework balances, the Terrain Pleura 100 closes by gravity and prevents foul air entering the built environment.

Terrain P.A.P.A.[®]

The Terrain P.A.P.A. is a positive pressure reduction device, designed to mitigate the affects of positive air fluctuations in the drainage pipework system. As water descends down the drainage stack it creates a negative pressure; if that flow is interrupted or is approaching a change of direction, the negative pressure changes to a positive pressure and moves up the pipe. This low amplitude air wave typically travels at 320m/s, the speed of sound.

As the positive air fluctuation approaches the branch-off point for the Terrain P.A.P.A, the bladder within the unit reacts very quickly, within 0.2 seconds, and starts to expand; this creates a pressure differential at the branch-off point. The branch to the Terrain P.A.P.A then becomes the path of least resistance and the majority of the positive air pressure is absorbed within the unit.

As the ambient air pressure within the pipework starts to equalise, the bladder slowly releases the small volume of air into the pipework system at only 12m/s, which will have no effect on the trap seals.



Pleura 50
9301.253



Pleura 100
9301.34



Terrain P.A.P.A.
9300.4

Soil and Waste Drainage



Owen Street Towers, Manchester, UK

A range of Terrain's drainage ventilation and soil and waste systems are installed at Owen Street Towers – one of Manchester's most prestigious residential developments. The 1,508-apartment luxury development has been fitted with a Terrain P.A.P.A and Pleura Vent System, eliminating the need for a secondary vent system, while Terrain FUZE HDPE drainage stacks and Terrain PVC piping systems helped meet the project's drainage and soil and waste requirements.



InterContinental London O² Hotel, London, UK

A Terrain FUZE HDPE system has been installed in the InterContinental London O2 Hotel, providing an innovative drainage solution for the 19-storey luxury property.



Fenchurch Avenue, London, UK

The landmark Fenchurch Avenue in London benefits from an extensive range of Terrain FUZE drainage products. FUZE is made of high-density polyethylene and is manufactured in a wide range of lengths, this along with the support of a market leading fabrication department makes FUZE an ideal drainage solution for tall buildings.



D1 Tower, Dubai, UAE

Terrain P.A.P.A is installed in D1 Tower, an 80 floor luxury residential building, providing a simplified, but efficient drainage ventilation system.

Terrain FUZE

Base Stack/Transition Areas

As the waste water discharge in a drainage stack reaches the base of the stack, it will need to change direction to flow horizontally into either a high-level collector drain or into the below-ground drainage system.

The flow velocity in the horizontal drainage pipework will be controlled by the installed gradient and pipe diameter; this will be appreciably less than the velocity of the vertical drainage stack. At the base of the drainage stack the waste water discharge undergoes a rapid deceleration in velocity, creating an increase in the depth of the flow at the change of direction. This increase in depth is generally sufficient to fill the cross section area of the pipe.

This phenomenon is known as the 'hydraulic jump'.

The distance at which the hydraulic jump occurs varies from immediately at the stack change of direction, up to 10 times the diameter of the stack downstream.

This is dependent upon:

- The entrance velocity
- Depth of water that may already exist within the horizontal drainage pipe
- Roughness co-efficient of the pipe
- Pipe diameter
- Pipe gradient
- Bend formation at the base of the stack

The surged flow condition will extend until the frictional resistance of the pipe reduces the velocity to the designed flow condition.

To mitigate the air fluctuation problems associated at the base of the drainage stack, Building Regulations Approved Document H, states that the following design details are incorporated.

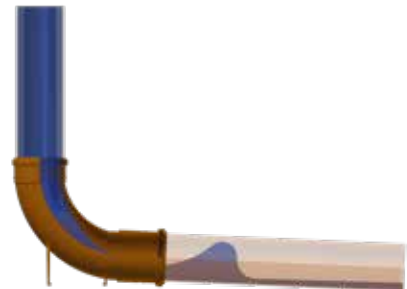

Soil and Waste Drainage

Base of Stack Requirements

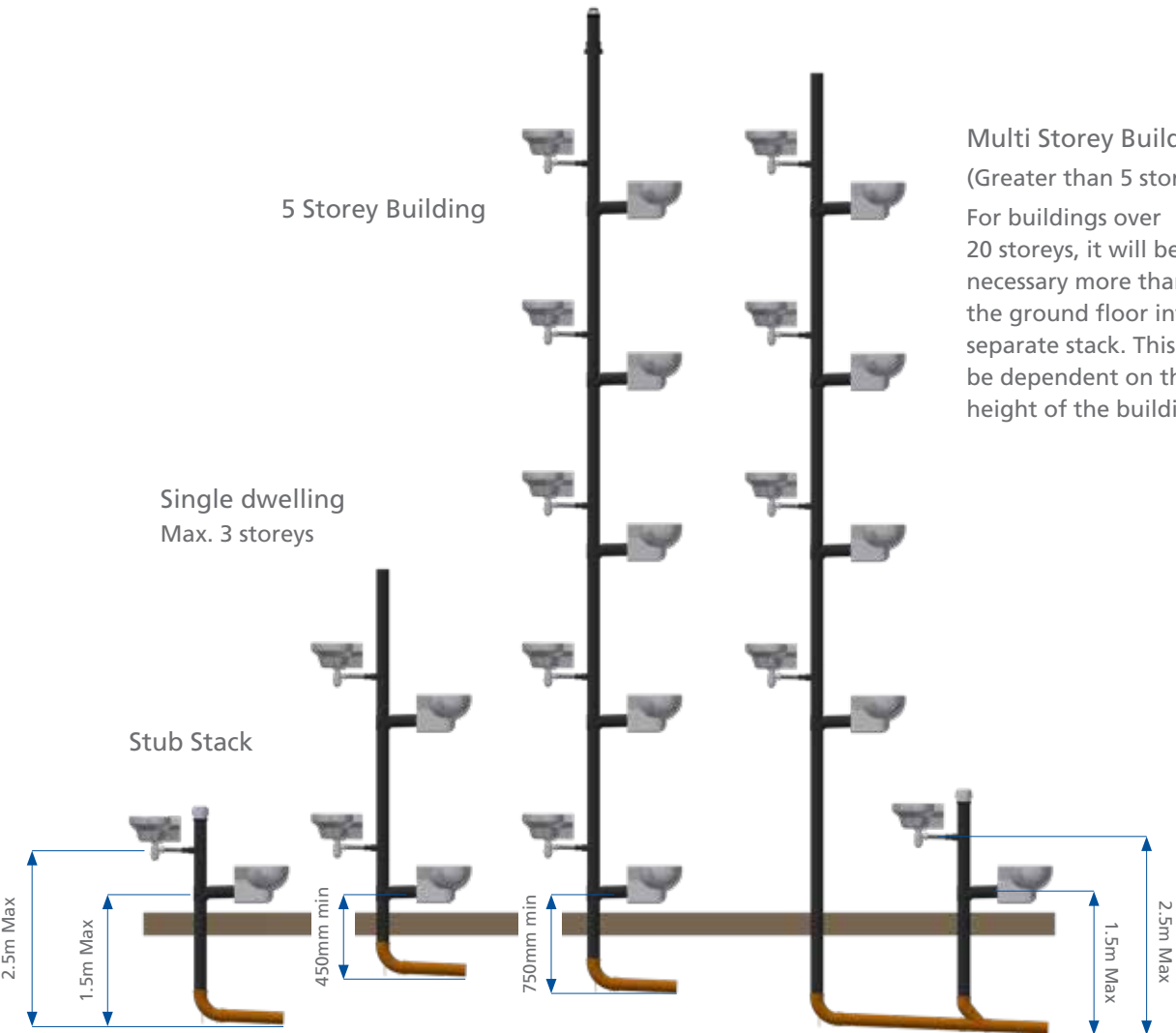

Multi Storey Buildings
(Greater than 5 storeys)
For buildings over 20 storeys, it will be necessary more than the ground floor into a separate stack. This will be dependent on the height of the building.

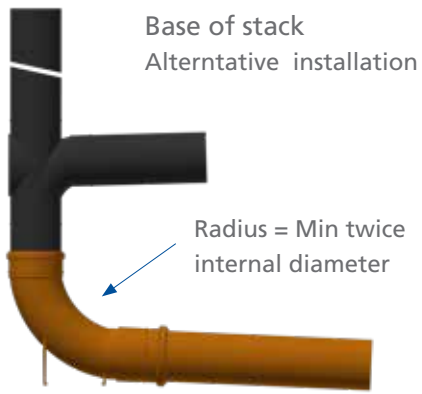
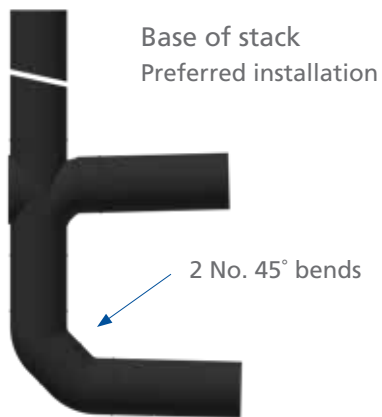

Terrain FUZE

Basic Principles for Rainwater Designs

Sizing of rainwater installations

The following general guidelines are based on BS EN 12056-3:2000 *Gravity Drainage Systems Inside Buildings – Roof Drainage, Layout and Calculations*.

There are two factors to consider when calculating the rainwater flow from a roof, firstly the design rainfall intensity to be used and the effective roof area to be drained.

Rainfall intensity

It is important to confirm the design rainfall intensity with the client before carrying out any design work; this can be done by calculation (refer to BS EN 12056-3:2000) or based on local requirements.

Effective roof area

Before the effective roof area can be calculated it is necessary to determine if the calculation will be affected by:

- a) Snow, (Section NB4, BS EN 12056-3:2000) details the design requirements for snow which should be taken into account.
- b) Wind, there is no requirement to allow for the effect of wind when designing a rainwater system for flat roofs or roofs protected from the wind by adjacent buildings. However, the wind and the roof slope can have the effect of increasing the flow of rainwater from the roof of unprotected pitched roofs.

Note: Flat roofs should be designed to allow for structural deflection under dead and imposed loads, BS 6229:2003, table 6 details the minimum finished falls for a flat roof dependent upon the roof covering.

- c) Tall Buildings, when draining onto a lower level roof the effective catchment area of a wall should be taken as 50% of its area up to a maximum exposed height of 10m

The effective roof area can be calculated using the following formulae,

Flat roof

$$A(m^2) = L \times B$$

where:

A = Effective roof area (square metres)

L = Length of roof (metres)

B = Width of roof (metres)

Pitched roof

$$A(m^2) = L \times (B+H/2)$$

where:

A = Effective roof area (square metres)

L = Length of roof (metres)

B = Width of roof (metres)

H = Height of roof between eaves and ridge (metres)

If an adjacent wall is to be incorporated into the equation then the following needs to be added to the two formulae

$$0.5 (l \times w) \quad \text{where:}$$

L is up to maximum of 10m

Calculating design flow

Having determined the rainfall intensity (mm/hr) and effective roof area, A(m²), the following calculation is required to establish the actual design flow from the roof.

$$\text{Flow rate, } Q (l/s) = \frac{A(m^2) \times RI (mm/hr)}{3600}$$

Fixing small roof outlet to proprietary plastic finish

Applicable to: all 2180 and 2181 Roof Outlets

- Apply recommended adhesive to flange of outlet body
- Dress plastic material over flange to the edge of opening
- Secure the flat or domed grid with brass screw supplied, lightly clamping the roof finish material in position

Fixing small roof outlet to mineral felt finish

Applicable to: all 2180 and 2181 Roof Outlets

- Apply suitable bitumastic primer to flange of outlet body
- Apply liquid bitumen or activator to roof and prepared area of flange
- Lay first layer of felt to edge of flange
- Dress second and third layers over the flange to the edge of the opening
- Secure the flat or domed grid with the brass screw supplied, lightly clamping the edge of the second and third layers of felt



Rainwater Drainage

Terrain Siphonic Rainwater System



Why use a Siphonic roof drainage system?

With average UK annual temperatures predicted to rise by up to 3.5°C over the next 70 years, climate change is already driving the need for innovative solutions to the management of rainfall and surface water.

With ten times the flow capacity of a conventional gravity system and significantly faster water removal rates, Terrain Siphonic Roof Drainage System 'sucks' water from a roof to cope with downpours that would overwhelm a gravity system and is ideal for complex roof shapes.

Offering valuable total project cost savings of typically 20-45% over a conventional system, Terrain Siphonic Roof Drainage System can be factory fabricated and gives important structural and space savings, with a reduced build programme.

The system has a comprehensive range of roof drains for every flat and pitched roof membrane, from asphalt to bitumen to modern single ply membranes. Ideal for commercial, industrial, sports, leisure, education and healthcare buildings, the roof drains are extremely compact and the range includes an inlet for the top deck of multi-storey car parks.

- 10 times the flow capacity of a conventional gravity system
- Faster water removal rates
20-45% cost savings over a conventional gravity system
- Reduces underground drainage
- Ideal for complex roof shapes
structural and space saving
- Accurate design software

Flow Capacity

A 75mm roof drain can remove up to 25 litres of rainwater per second, whilst the 125mm drain can remove up to 100 litres of rainwater per second with certain piping configurations

Terrain FUZE

How it works

The Terrain Siphonic Roof Drainage System 'sucks' water from the roof, using a powerful hydraulic force created by water accelerating down the full height of the building to deliver far greater capacity and flow rates than a gravity system. In a gravity drainage system, pipework carries both air and water. The flow in gravity pipes is extremely inefficient because of the large core of air which enables the water to flow resulting in the need for larger pipes and more of them as well as extensive underground systems.

In the Terrain Siphonic Roof Drainage System as rain falls, the roof drain prevents the ingress of air, rapidly purging it until the system is fully primed and running full bore. Water is transported in smaller diameter pipes to fewer, more convenient locations. The system responds quickly to rainfall changes, is self-cleaning, drains rapidly when rainfall ceases, and is designed to prevent blockage by leaves, twigs and other debris.

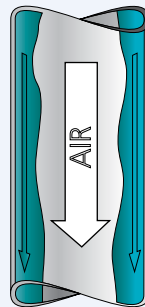

Gravity flow

A gravity drainage system limits capacity to one-third water that adheres to the inner pipe wall with a large two-thirds air core.



Terrain Siphonics

In the the Siphonic system air is purged from the pipe so that it runs 100% full of water, normally achieving 10 to 15 times higher flow rates.

The Terrain Siphonic roof drain incorporates a one-piece inducer or air baffle plate, which becomes submerged in shallow water to exclude air. The height of the inducer above the body ensures the system primes rapidly with a minimum depth of water.

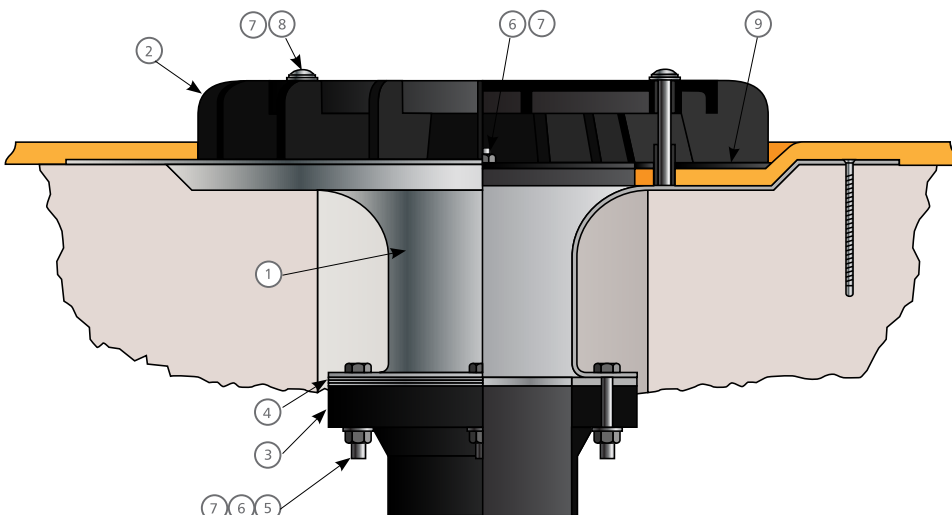

KEY

1. Terrain Siphonic roof drain body
2. Terrain Siphonics inducer
3. HDPE stub flange connector
4. Neoprene gasket
5. Hex headed set screw
6. Full nut
7. Washer
8. Button headed cap screw
9. Flashing ring

Rainwater Drainage

The piping system

The collector pipe is normally installed horizontally without slope at high level and runs to a convenient point where it drops to ground level with a transition break connection into the below-ground gravity drainage system or manhole chamber.



Terrain FUZE high density polyethylene pipes are manufactured in the UK to BS EN 1519-1:2000

Recommended pipes

Terrain FUZE pipes are manufactured in the UK to BS EN 1519-1:2000 and BBA certification. Fully welded to withstand high negative pressures, they offer excellent performance and durability with high weather and corrosion resistance.

With a wide range of diameters and fittings for maximum design flexibility, they are lightweight with electro-weld joints for rapid and simple installation. In addition, stainless steel and cast iron pipes can be used for aesthetics or as dictated by the site.

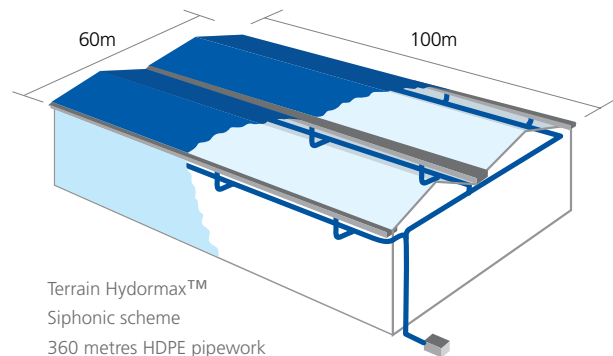

Correct installation

Essential to the success and performance of a siphonic system, correct installation is ensured by the system design software and prefabrication of specified pipework. In addition, installation time may be reduced by fabricating pipe work. This can be completed offsite by Terrain if required and installation is completed by approved installers.

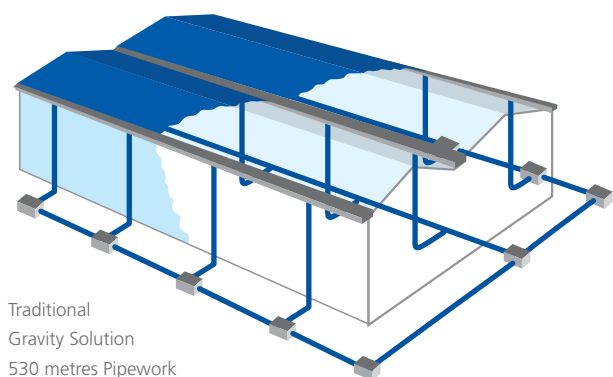

Chemical drainage systems for Commercial and Public Buildings

Terrain FUZE can be used for a range of chemical applications due to their chemical resistance characteristics. This makes Terrain Soil & Waste pipe systems ideal for use in laboratories, hospitals and educational establishments, as well as a number of other commercial drainage applications.

Terrain FUZE

Chemical Resistance

The following tables provide a list of inorganic compounds, which may be conveyed through HDPE systems with no internal pressure or mechanical stress, at temperatures up to 20°C and 60°C and those fluids which are unsuitable.

Fluid concentration classifications used in table	
=	No Data
-	Not recommended
0	Conditionally Resistant
+	Resistant

Chemical	Concentration	Temperature		
		20	40	60
Acetaldehyde	40% aqueous solution	+	+	0
Acetaldehyde	Technically pure	+	0	
Acetic acid	50% Aqueous	+	+	+
Acetic acid	Technically pure, glacial	+	+	0
Acetic acid anhydride	Technically pure	+	0	
Acetic acid ethylester		+		
Acetic acid isobutyl ester	Technically pure	+		
Acetone	up to 10% aqueous	+	+	+
Acetone	Technically pure	+	+	+
Acetonitrile	100%	0		
Acetophenone	100%	0		
Acrylic acid methyl ester	Technically pure	0		
Acrylicethyl	Technically pure	0		
Acrylonitrile	Technically pure	+	+	+
Adipic acid	Saturated, aqueous	+	+	+
Allyl alcohol	96%	+	+	+
Ammonia	Gaseous, technically pure	+	+	+
Ammonium acetate	Aqueous, all	+	+	+
Ammonium persulphate		+		
Amonium salts, aqueous inorganic	Saturated	+	+	+
Amyl acetate	Technically pure	+	+	+
Amyl alcohol	Technically pure	+	+	+
Aniline	Technically pure	+	0	
Antimony trichloride	90% aqueous	+	+	+

Chemical	Concentration	Temperature		
		20	40	60
Aqua regia	Mixing ratio	-		
Arsenic acid	80% aqueous	+	+	+
Barium salts, aqueous inorganic	Saturated	+	+	+
Beer	Usual commercial	+		
Benzaldehyde	Saturated, aqueous	+	+	0
Benzene	Technically pure	0	0	
Benzene sulfonic acid	Technically pure	+	+	0
Benzene (Gasoline)	Free of lead and aromatic compounds	+	+	
Benzoic acid	Aqueous, all	+	+	+
Benzyl alcohol	Technically pure	+	+	0
Beryllium salts, aqueous, inorganic		+	+	+
Borax	Aqueous, all	+	+	+
Boric acid	All, aqueous	+	+	+
Bromine water	Saturated, aqueous	-		
Butadiene	Technically pure	0		
Butane	Technically pure	+		
Butanediol	Aqueous 10%	+	+	+
Butanol	Technically pure	+	+	+
Butyl acetate	Technically pure	+		
Butyl phenol p-tertiary	Technically pure	0		
Butylene glycol	Technically pure	+	+	+
Butylene liquid	Technically pure	-		
Butyric acid	Technically pure	+		
Cadmium salts aqueous inorganic	< Saturated acid	+	+	+

* Plastic pipe and fittings combined chemical resistance clarification table ISO/TR10358 - 1993

Chemical Drainage

Tables of fluids* which can be conveyed through HDPE pipes and fittings with no internal pressure, mechanical stress and temperatures up to 60°C

Chemical	Concentration	Temperature		
		20	40	60
Caesium salts, aqueous, inorganic	<Saturated acid	+	+	+
Calcium acetate	Saturated	+	+	+
Calcium hydroxide	Saturated aqueous	+	+	+
Calcium lactate	Saturated	+	+	+
Calcium salts, aqueous, inorganic	Saturated acid	+	+	+
Carbon dioxide	Technically pure, anhydrous	+	+	+
Carbon tetrachloride	Technically pure	-		
Carbonic acid		+	+	+
Caro's acid				
Caustic potash solution (potassium hydroxide)	50% aqueous	+	+	+
Caustic soda solution	50% Aqueous	+	+	+
Chloric acid	10% aqueous	+	+	
Chloric acid	20% aqueous	0		
Chlorine	moist, 97%, gaseous	-		
Chlorine	Liquid, technically pure, as double pipe system	-		
Chlorine	Anhydrous, technically pure, as double pipe system	0	0	
Chlorine water	saturated	0	0	
Chloroacetic acid, mono	50% Aqueous	+	+	0
Chloroacetic acid, mono	Technically pure	+	+	0
Chlorobenzene	Technically pure	0		
Chloroethanol	Technically pure	+	+	+
Chlorosulphonic acid	Technically pure	-		
Chromic acid	All, aqueous	0		
"Chromic acid + water + sulphuric acid"	"50g 15g 35g"	-		
Chromium (II)- salts, aqueous, inorganic	<Saturated acid			
Compressed air, containing oil		+	+	
Copper salts, aqueous inorganic	<Saturated acid	+	+	+
Cresol	Cold saturated, aqueous	+	+	0
Crotonic aldehyde	Technically pure	+		
Cyclohexane	Technically pure	+	+	+

Chemical	Concentration	Temperature		
		20	40	60
Cyclohexanol	Technically pure	+	+	+
Cyclohexanone	Technically pure	+	0	0
Dextrine	Usual commercial	+	+	+
Di isobutyl ketone	Technically pure	+	0	
Dibromobenzene	<Saturated acid	0		
Dibutyl ether	Technically pure	0		
Dibutyl phthalate	Technically pure	+	0	0
Dichloroacetic acid	50% Aqueous	+	+	0
Dichloroacetic acid	Technically pure	+	+	0
Dichloroacetic acid methyl ester	Technically pure	+	+	+
Dichlorobenzene	Technically pure	0		
Dichloroethylene	Technically pure	-		
Diesel oil		+		
Diethyl ether		-		
Diethylamine	Technically pure	+		
Dimethyl formamide	Technically pure	+	+	0
Dimethylamine	Technically pure	+		
Dioxane	Technically pure	+	+	+
Ethanolamine	Technically pure	+		
Ethyl alcohol (Ethnause)	Technically pure 96%	+	+	+
Ethyl benzene	Technically pure	0		
Ethyl chloride (G)	Technically pure	0		
Ethyl ether	Technically pure	+		
Ethylene diamine	Technically pure	+	+	+
Ethylene glycol	<50%	+	+	+
Ethylene glycol	Technically pure	+	+	+
Ethylenediamine-tetraacetic acid (EDTA)		+		
Fluorine	Technically pure	-		
Fluorosilicic acid	32% aqueous	+	+	+
Formaldehyde	40% aqueous	+	+	+
Formamide	Technically pure	+	+	+
Formic acid	<25%	+	+	+

* Plastic pipe and fittings combined chemical resistance clarification table ISO/TR10358 - 1993

Terrain FUZE

Tables of fluids* which can be conveyed through HDPE pipes and fittings with no internal pressure, mechanical stress and temperatures up to 60°C

Chemical	Concentration	Temperature		
		20	40	60
Formic acid	up to 50% aqueous	+	+	+
Formic acid	Technically pure	+	+	+
Frigen 12 (freon 12)	Technically pure	-		
Fuel oil		+		
Furfuryl alcohol	Technically pure	+	+	+
Gelatin	All, aqueous	+	+	+
Glucose	All, aqueous	+	+	+
Glycerol	Technically pure	+	+	+
Glycin	10% aqueous	+	+	
Glycolic acid	37% aqueous	+	+	+
Heptane	Technically pure	+	+	
Hexane	Technically pure	+	+	
Hydrazine hydrate	aqueous	+	+	+
Hydrochloric acid	up to 30% aqueous	+	+	+
Hydrochloric acid	38% aqueous	+	+	
Hydrocyanic acid	Technically pure	+	+	+
Hydrofluoric acid	40%	+	+	0
Hydrogen	Technically pure	+	+	+
Hydrogen chloride	Technically pure, gaseous	+	+	+
Hydrogen peroxide	30% aqueous	+		
Hydrogen peroxide	90% aqueous	0		
Hydrogen sulphide	Saturated aqueous	+	+	+
Hydrogen sulphide	Technically pure	+	+	0
Hydroquinone	30%	+	+	+
Lodine-potassium iodide solution (Lugol's solution)		+		
Iron salts, aqueous inorganic	<Saturated acid	+	+	+
Isooctane	Technically pure	+		
Isopropyl alcohol (ESC)	Technically pure	+	+	0
Isopropyl ether	Technically pure	0		
Lactic acid	10% aqueous	+	+	+
Lead acetate	aqueous saturated	+	+	+
Lead salts, aqueous, inorganic	<Saturated acid	+	+	+

Chemical	Concentration	Temperature		
		20	40	60
Linseed oil	Technically pure	+	+	+
Lithium salts, aqueous, inorganic	<Saturated acid	+	+	+
Magnesium salts, aqueous, inorganic	<Saturated acid	+	+	+
Maleic acid	Cold saturated, aqueous	+	+	+
Mercury	pure	+	+	+
Mercury salts	<Saturated	+	+	+
Methane (natural gas)	Technically pure	+		
Methanol	All	+	+	+
Methyl acetate	Technically pure	+		
Methyl amine	32%, aqueous	+		
Methyl bromide	Technically pure	0		
Methyl ethyl ketone	Technically pure	+		
Methyl isobutyl ketone		+		
Methyl methacrylate		+		
Methyl phenyl ketone (acetophenon)		+		
Milk		+	+	+
Mineral water		+	+	+
Mixed acids -nitric 15% -hydrofluoric 15% -sulphuric 18%	3 parts 1 part 2 parts	0		
Mixed acids -sulphuric -nitric -water	10 % 20 % 70 %	+		
Mixed acids -sulphuric -nitric -water	50 % 33 % 17 %	-		
Mixed acids -sulphuric -nitric -water	50 % 31 % 19 %"	-		
Mixed acids -sulphuric -phosphoric -water	30 % 60 % 10 %	+	+	+
N,N-Dimethylaniline	Technically pure	+		
N, methylpyrrolidon		+		
Naphthalene	Technically pure	+		
Nickel salts, aqueous in organic	<saturated acid	+	+	+

* Plastic pipe and fittings combined chemical resistance clarification table ISO/TR10358 - 1993

Tables of fluids* which can be conveyed through HDPE pipes and fittings with no internal pressure, mechanical stress and temperatures up to 60°C

Chemical	Concentration	Temperature		
		20	40	60
Nitrating acid -sulphuric acid -nitric acid -water	65 % 20 % 15 %	-		
Nitric acid	6.3% aqueous	+	+	+
Nitric acid	<25%	+	+	0
Nitric acid	65% aqueous	0	-	
Nitric acid	85%	-		
Nitric acid	100%	-		
Nitrobenzene	Technically pure	+		
Nitrotoluene (o-, m-, p-)	Technically pure	+	0	
Nitrous acid		+		
Nitrous gases (nitric oxide)	diluted, moist, anhydrous	0		
Oleic acid	Technically pure	+	+	0
Oleum	10% SO3	-		
Olive oil		+	+	0
Oxygen	Technically pure	+	+	0
Ozone	up to 2%, in air	0		
Ozone	Cold saturated, aqueous	0		
Palm oil, palm nut oil		+		
Paraffin emulsions	usual commercial, aqueous	+		
Paraffin oil		+		
Perchlorid acid	10% aqueous	+		
Perchlorid acid	70% aqueous			
Perchloroethylene (tetrachlorethylene)	Technically pure	0		
Phenol	up to 10%, aqueous	+	+	0
Phenol	Up to 90%, aqueous	+	+	0
Phosgene	gaseous, technically pure	0		
Phosgene	Liquid, technically pure	-		
Phosphoric acid	85%, aqueous	+	+	+
Phosphoric acid	Upto 95%	+	+	
Phosphorous chlorides -trichloride -pentachloride -oxichloride	Technically pure	-		
Photographic developer	usual commercial	+	+	0

Chemical	Concentration	Temperature		
		20	40	60
Photographic emulsions		+	+	
Photographic fixer	usual commercial	+	+	
Phthalic acid	saturated, aqueous	+	+	+
Potassium hydroxide	50%	+	+	+
Potassium aluminium salts, (alum), aqueous, inorganic	<saturated acid	+	+	+
Potassium persulphate (potassium peroxidsulfate)	All, aqueous	+	+	+
Potassium hypochlorite		0		
Propane	Technically pure, gaseous	0		
Propane	Technically pure, liquid	+		
Propanol, n- and iso-	Technically pure	+	+	0
Propionic acid	50% aqueous	+	+	+
Propionic acid	Technically pure	+	0	0
Propylene glycol	<50%	+	+	+
Propylene glycol	Technically pure	+	+	+
Pyridine	Technically pure	+	0	0
Salicylic acid	saturated	+	+	+
Sea water		+	+	+
Silicic acid		+	+	+
Silicone oil		+	+	+
Silver salts, aqueous, inorganic	<saturated acid	+	+	+
Sodium chlorite	diluted, aqueous	0		
Sodium hypochlorite	12.5% active chlorine, aqueous	0	0	
Sodium persulphate	cold saturated, aqueous	+	+	+
Sodium salts, aqueous, inorganic	<saturated acid	+	+	+
Stannous chloride	cold saturated, aqueous	+	+	+
Starch solution	All, aqueous	+	+	+
Styrene				
Succinic acid	Aqueous, all	+	+	+
Sulfuryl chloride	Technically pure	-		
Sulphur dioxide	Technically pure, liquid	-		

* Plastic pipe and fittings combined chemical resistance clarification table ISO/TR10358 - 1993

Terrain FUZE

Tables of fluids* which can be conveyed through HDPE pipes and fittings with no internal pressure, mechanical stress and temperatures up to 60°C

Chemical	Concentration	Temperature		
		20	40	60
Sulphur dioxide	All, moist	+	+	+
Sulphuric acid	saturated aqueous	+	+	+
Sulphuric acid	Up to 80% aqueous	+	+	0
Sulphuric acid	Up to 96% aqueous	-		
Sulphuric acid	98%	-		
Tannic acid	All, aqueous	+	+	+
Tetrachlorethylene (perchloroethylene)		-		
Tetrachloroethane	Technically pure	0		
Tetraethylene lead	Technically pure	+		
Tetrahydrofurane	Technically pure	0		
Tin salts, aqueous, inorganic	<saturated acid	+	+	+
Toluene	Technically pure	0		
Trichloromethane	100%			
Trichloroacetic acid	50% aqueous	+	+	+
Trichloroacetic acid	Technically pure	+	0	-
Trichloroethane	Technically pure	0		
Trichloroethylene	Technically pure	-		
Triethylamine	Technically pure	+		
Trifluoroacetic acid	up to 50%	+		
Turpentine oil	Technically pure	0	0	
Urea	Up to 30% aqueous	+	+	+
Urine		+	+	+
Vinyl acetate	Technically pure	+	+	
Vinyl chloride	Technically pure	-		
Waste gases, containing Alkaline		+	+	+
Waste gases, containing hydrochloric acid	all	+	+	+
Waste gases, containing hydrogen fluoride	Traces	+	+	+
Waste gases, containing nitrous gases	Traces	+	0	0
Waste gases, containing sulphur dioxide	Traces	+	+	

* Plastic pipe and fittings combined chemical resistance clarification table ISO/TR10358 - 1993

Fabrication

For over 40 years the Terrain Fabrication Service has been at the forefront of providing drainage solutions. From unique one-off fittings to complete fabricated drainage stacks, we have the expertise to overcome the challenges found within construction sites in the UK.

Terrain fabricated drainage stacks

By working with your design team we can take your plans and provide you with a drainage solution tailor made for your building. Because we understand the constraints of site storage we will work with your build schedule to ensure that the fabricated solutions are delivered when required. With the additional ability to pre-air test the stacks prior to delivery, the system can be installed more efficiently by reducing both installation and testing times.

Key Benefits



Simple on-site connections

Straightforward installation saves on labour costs



Reduces on-site labour costs

Reduced installation time keeps overall project costs down



Reduces on-site installation time

Installation is simple and quicker than assembling loose fittings



Reduces on-site waste

Made to measure engineered solutions means there is a reduction in wasted materials



Pre-air testing available

Removes the time and skills required for on-site testing



Widest portfolio of bespoke solutions

Providing customised solutions for tricky one-off projects

40
YEARS

Terrain has over 40 years experience of fabricating

You can expect quality from a brand you can trust



BES 6001 accreditation

Our materials have all been responsibly sourced with full traceability throughout the supply chain



Unique fitting - Terrain FUZE HDPE low level waste manifold

Due to the growing demand for space saving and low level connections, we have developed the low level waste manifold specifically for use with the Terrain Fabrication Service. Available in 110mm and 160mm, the low level waste manifold is the ideal solution for overcoming the technical difficulties of bringing in up to 6 x 56mm connections at low level into the drainage stack. With side entries it is ideally suited for installation at slab level and can be fabricated with a close coupled WC connection. Fitting can be fabricated with long spigots or ring seal connections for easy connection onto MuPVC or HDPE waste systems.



Terrain FUZE

By working closely to your schedule and applying the same standardised methods throughout every stage, you can rest assured that your bespoke system is undergoing the same rigorous process that has made our systems so sought after across some of the UK's most iconic buildings.

The four simple steps

From the moment you submit your enquiry, wheels are set in motion that results in a fully bespoke system being delivered to your site.

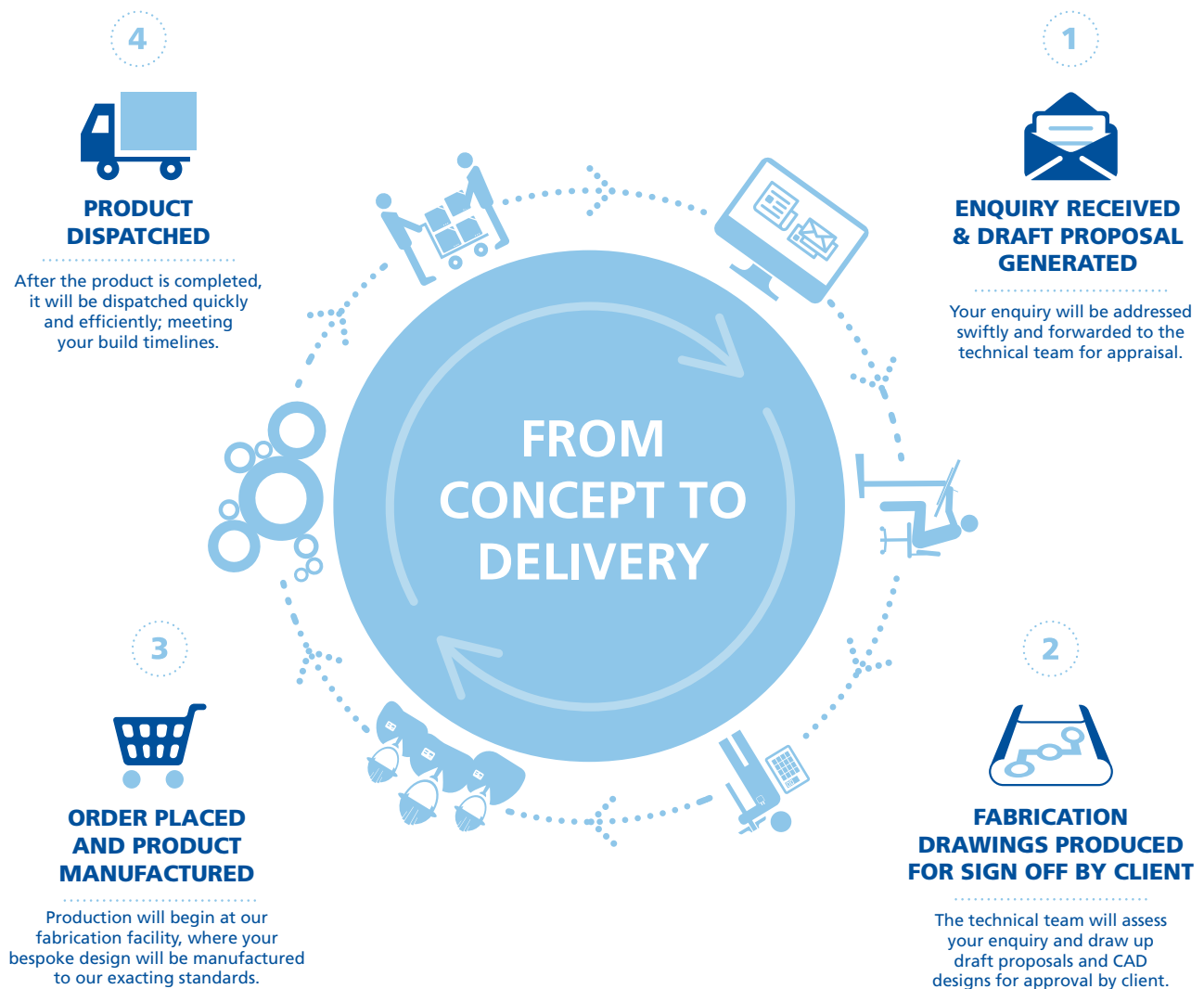

Terrain FUZE installed throughout major central London residential project

Polypipe Terrain met challenging requirements at a mixed-use housing development in the heart of London's Docklands.



**Terrain FUZE
fabricated
drainage stacks
across 42
storeys**

Working alongside main contractor Balfour Beatty Construction and M&E contractor Briggs and Forrester MEP Ltd, Polypipe designed and delivered prefabricated drainage stacks utilising its popular Terrain FUZE for the Providence Tower and Bar Building apartment buildings, which stand at 42 and 12 storeys respectively.

Terrain FUZE incorporates a number of engineered fittings to aid installation and is ideally suited to off-site fabrication where repetition is prevalent, such as in high rise buildings.

Unique to this development, which encompasses high-end luxury apartments and affordable housing, was the use of 160mm diameter low entry manifold piping, a wide pipe suitable for the project.

This ability to prefabricate bespoke products off-site, in turn driving quick turn around times, and the reduced labour, made Polypipe a key project partner.

The light weight nature of Terrain FUZE brought many advantages over traditional materials, not least in its manoeuvrability on site, while the use of prefabrication meant that the system could be installed quickly and efficiently, providing significant time and resource savings.

Paul Campbell, Project Director of Briggs and Forrester MEP Ltd, said: "Whilst there were many benefits to using Terrain FUZE over alternative solutions, it was Polypipe Terrain's ability to custom engineer low entry manifold piping that really impressed us. Being engineered specific to the project, in Polypipe's on site fabrication facilities, meant the turnaround time was minimal, ensuring a smooth installation."

Damian Farrell, London & South East Sales Director, of Polypipe Terrain, said: "Our experience on delivering on projects of this nature, combined with our extensive system knowledge, means that we can create engineered solutions that meet the needs of the development, such as the 160mm diameter low entry manifold piping that was unique to this project."

The shell and core of the buildings are now complete and the fit out is due to complete in 2016.



CASE STUDY

Project

Providence Tower and Bar Building

Client

Briggs and Forrester MEP Ltd

Application

Fabricated drainage system

Products

Terrain FUZE

Terrain FUZE

Live stack replacement service

By utilising the inherent benefits of the Terrain Fabrication Service we can help in particularly difficult situations; where old, often decaying cast iron soil stacks in local authority housing have deteriorated to the point that they may pose a public health issue.

When you have issues with drainage systems in a typical high rise building which is occupied it can be of great expense to temporarily rehouse the residents whilst the issue is resolved. In the most severe of cases, the entire soil stack may need to be replaced. Below are some photos of some actual cast iron soil stacks removed from a high rise Local Authority building where ongoing system breakdown has caused sanitation issues, such as leaking and blocked pipes.



No one wants to have to move out of the comfort of their own home, and it's often not easy to find suitable replacement housing when refurbishment work is required. Thanks to our fabricated soil stack offering, old soil stacks can now be replaced live with very limited disturbance

to residents. Live Stack Replacement sees contractors replacing old soil stacks with complete new Terrain FUZE HDPE or Terrain Acoustic soil stacks quickly, often floor-by-floor, so that residents can remain in their homes and housing providers do not need to re-house them elsewhere.

Fabrication Case Studies

Residential 'live stack replacement' made possible with Terrain fabricated solution

Large scale 'live' drainage replacement works were able to take place thanks to a time saving solution from Polypipe.



**Terrain
Acoustic dB12
& Terrain FUZE**



Acoustic dB12

Terrain FUZE

Having worked closely with M&E Contractor IDS and Birmingham City Council on a refurbishment programme since 2009, Polypipe Terrain's fabrications team devised a solution which would enable residents to stay in their homes while essential works were undertaken to replace the original cast iron soil and waste pipes across three separate high rise towers.

Polypipe Terrain manufactured 200metres of 110mm Terrain dB12 and 75mm Terrain FUZE fabricated soil and waste stacks to exact specifications and delivered them to site in Kings Norton, where sub-contractor Lovell was able to complete installations across 96 properties 40% faster than the average for such works.

Polypipe Terrain's ability to fabricate its drainage products off-site in its UK manufacturing facilities, along with the unique features of the soil and waste solution provided, ensured that the number of joints and cuts were kept to a minimum.

Using fabricated drainage stacks meant that average installation times per property were reduced from five hours to just three.

A vital element of this project was to complete work with as little intrusion as possible. As a result of the type of works programme put into place it was possible to successfully deliver live stack replacements across 96 individual properties ahead of the timescales set out, with minimum disruption to residents.

The challenges presented on this project, not only with residents in place but also a lack of space for installation teams to work, were easily overcome thanks to Polypipe Terrain's ability to provide a high quality 'one fitting solution'.

CASE STUDY

Project

Loweswater House,
Waltham House and
Sandhurst House
Kings Norton,
Birmingham

Client

IDS

Application

Drainage stacks

Products

Terrain Acoustic dB12
Terrain FUZE

Terrain FUZE

Good Site Practice

- Do not throw or drop pipes, or drag them along hard surfaces.
- In case of mechanical handling, use protective slings and padded supports. Metal chains and hooks should not make contact with the pipe.

On-site storage

- Stack pipe lengths
 - either on a flat base
 - or on level ground
 - or on 75mm x 75mm timber at 1 meter centres (Fig. 1)
- Provide side support with 75mm wide battens at 1m centres (Fig. 1).
- Maximum stack (normal conditions): seven layers high.
- Ideally, stacks should contain one diameter pipe size only. Where this is not possible, stack largest diameter pipes at base of stack. Small pipes may be nested inside larger pipes.
- If stored in the open for long periods or exposed to strong sunlight, cover the stack with opaque sheeting.
- Store fittings under cover. Do not remove from cartons or packaging until required.

Storage in hot climates

- Ultra-violet light can affect pipes and fittings: pipe colour may change and rubber seals may be degraded.
- Accordingly:
 - store all materials in well-ventilated, shady conditions
 - do NOT expose to direct sunlight
 - keep fittings in original packaging until required for use
- Maximum stack (hot conditions): six layers high.

Site safety

- The relevant regulations detailed in the Health & Safety at Work Act 1974, and Construction (Design & Management Regulations 1995, must be adhered to on site.
- MSDS data sheets are available on request.

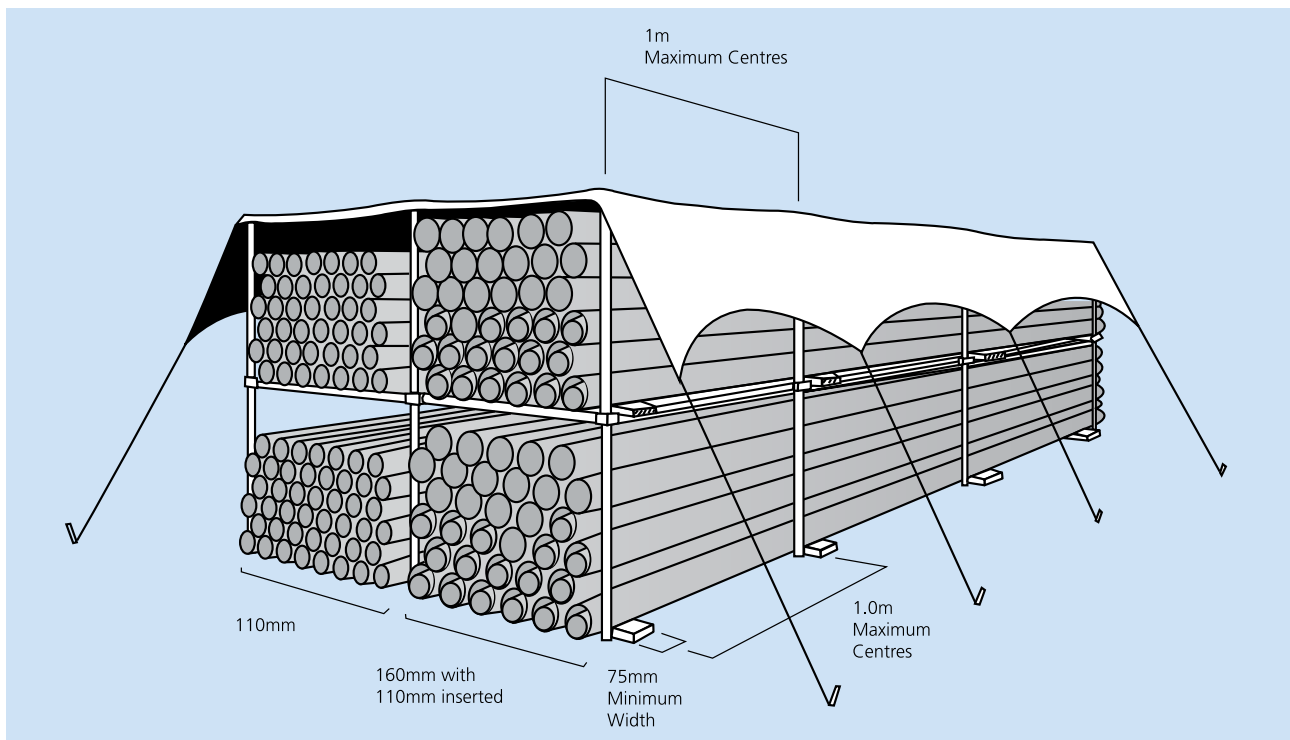

Fig. 1 Pipe stacking

Joining Methods

Terrain FUZE offers workable and effective solutions to a wide range of project constraints through the availability of a number of joining methods. Each connection is categorised according to its varying properties, with the different classifications assembled as follows:

a) Removable

Connections which can be disconnected after assembly.

b) Non-removable

Connections which cannot be disconnected after assembly.

c) Tension-resistant

Connections which cannot be disconnected by tensional forces.

d) Non-tension-resistant

Connections which can be disconnected by tensional forces.



Butt weld



Screw-threaded coupling



Electrofusion coupling



Expansion socket



Ring-seal socket



Flange joint

Terrain FUZE

Electrofusion Welding

1. Cut the pipe or fitting using the appropriate pipe cutter or saw. Make sure the end of the pipe or fitting is square and clean.



2. Scrape the oxidation layer from the spigot of the pipe or fitting to at least the insertion depth of the coupling using the appropriate pipe scraper. Ensure that the spigot ends and the couplers are kept clean and free from dirt, water and grease.



3. Insert into the centre stop of the coupling. Mark the spigots using a wax pencil.



4. Unpack your Polypipe Terrain FUZE electrofusion welding machine and ensure you have the correct leads attached.



5. Ensuring that the pipe work is supported correctly, attach the leads to the coupling and push the start/stop button. This will begin the electrofusion welding process.



6. There will be two visual indications showing that the weld has been completed successfully. The first will be on the screen showing that the welding is 100% complete. The second will be a visual indication on the coupling, as shown below.



Jointing Methods

Electrofusion Welding

The before and after



Before



After

Examples of electrofusion welded joints which have been made correctly and incorrectly:

Example of a good electrofusion weld joint



You can see that the pipe surface has been scraped and the fitting has been welded once. The pipe and coupling surfaces have welded together to make a good joint.

Examples of incorrectly prepared electrofusion weld joints



The above coupling was welded twice without the coupling being left to cool down after the first weld. This has resulted in the pipe becoming distorted due to the excess heat.

Terrain FUZE



In the above joint the pipe has not been cut square and you can also see that the pipe surface has not been scraped. This joint is likely to leak.

Butt Welding

1. Prepare pipe ends and insert into butt welding machine



2. Use the planing tool to ensure that the pipe ends are square and free of any burr's



3. Press the pipe/fitting ends lightly against the hot plate melting the pipe ends until a small bead is visible around both ends.



4. Remove hot plate and press the ends together with the necessary pressure (as advised by welding machine) and lock the clamps in place until the weld begins to cool.



Jointing Methods

Butt Welding

Examples of butt welded joints which have been made correctly and incorrectly. These can be easily identified with a visual inspection:

Example of a good butt weld joint

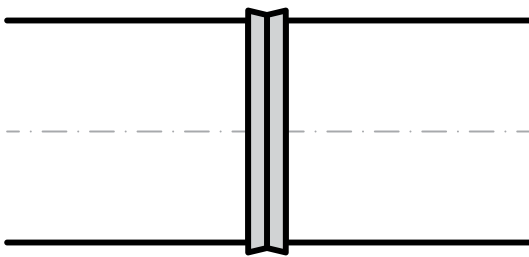

Two equal size beads continuing all the way around the pipe on both sides of the joint

Examples of incorrect butt weld joints

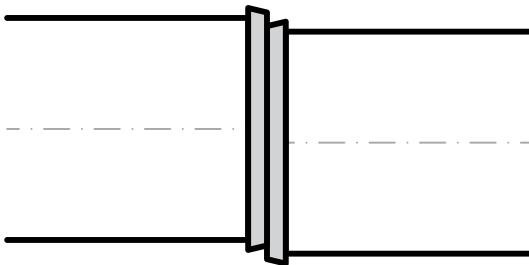

The pipes have been misaligned during the welding process

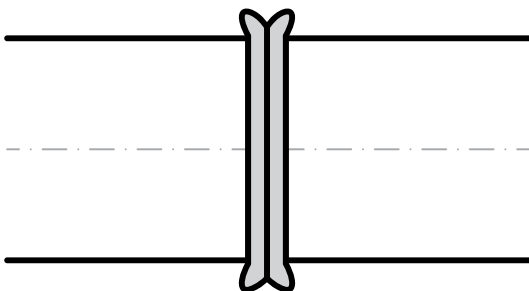

Too much pressure has been exerted during the welding process when the pipe ends are on the hot plate. No pressure should be applied at this stage

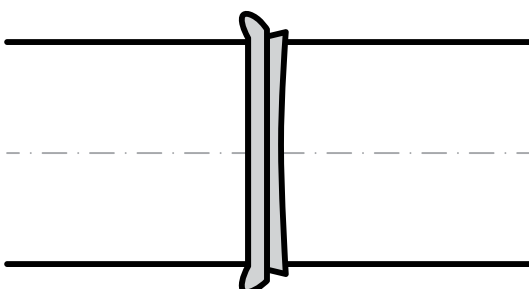

The two pipe ends have not heated evenly on the hotplate. Possibly one of the pipe ends was not cut/planed square

Terrain FUZE

Ring Seal Joints

Available in sizes 40 – 315mm

Connection Properties:

- a) Removable
- d) Non-tension-resistant

Use

Ring-seal sockets facilitate the assembly of pre-fabricated sections.

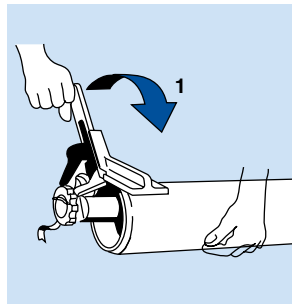

The pipe should be chamfered to approximately 15° and lubricated with suitable Polypipe product. Do not use oil or grease which can damage the rubber seal.

Assembly

The ring-seal socket is suitable for use on both horizontal and vertical applications with the small dimensions providing a space-saving advantage. Assembly instructions are replicated for both ring-seal sockets and screw-threaded joints, with the insertion depth corresponding for the same diameters. Ring seal sockets are also provided with a cap to prevent dirt entering the pipe on-site. The pipe must be fully inserted into the socket as it is not intended to act as an expansion socket.

A flush fit is obtained by chamfering the pipe end to approximately 15° and lubricating it with silicone oil. To avoid damage to the rubber seal, do not use oil or grease.

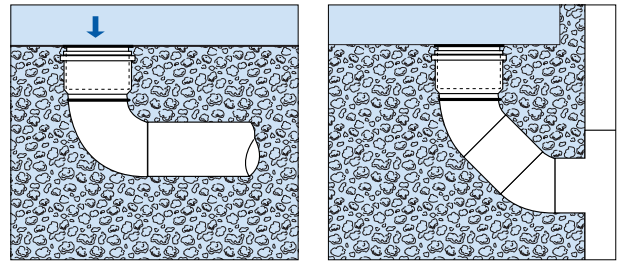

Protection Cap.

Expansion Joints

Available in sizes 40 - 315mm

Connection Properties:

- a) Removable
- d) Non-tension-resistant

Use

Expansion sockets can be used in underground pipe systems as normal push-fit fittings but must be provided on vertical stacks running from floor to floor and for rainwater pipes both inside and outside the building.

Installation

Expansion sockets are suitable for use in both vertical and horizontal applications with the depth of the sleeve enabling the assembly of stacks and collector pipelines. The design of the seal allows for pipe movement during expansion and contraction, ensuring that the connection remains water tight even under substantial hydraulic load.

To ensure easy assembly of the sleeve, the following conditions must be observed:

- Chamfer the inserted pipe end to approximately 15°.
- Lubricate the pipe end with a suitable Terrain product.

Note – do not use oil or grease which can compromise the rubber seal.

- Observe the indications on the outer surface of the expansion socket for insertion depth.

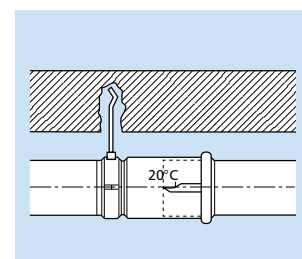

Horizontal assembly (e.g. at an ambient temperature of 20°C).

Joining Methods

Compression Joints

Available in sizes 40 – 110mm

Connection Properties:

- a) Removable
- d) Non-tension-resistant

Use

Screw-threaded joints are used for the assembly of pre-fabricated parts which need to be dismantled easily. See ring seal for assembly instructions.



Screw-threaded joint



Flanged Joints

Available in sizes 50 – 315mm

Connection Properties

- a) Removable
- c) Tension-resistant

Use

The flanges are made of a special, painted aluminium alloy and have standard dimensions (PN 10 and 16). These are most commonly used to create a removable connection in industrial plants.

By using a blank flange, it is possible to create an inspection access opening for large diameter pipes (200, 250 and 315mm).



Terrain FUZE

Key Features

Specific products for adapting in direction of flow

Direction of flow 

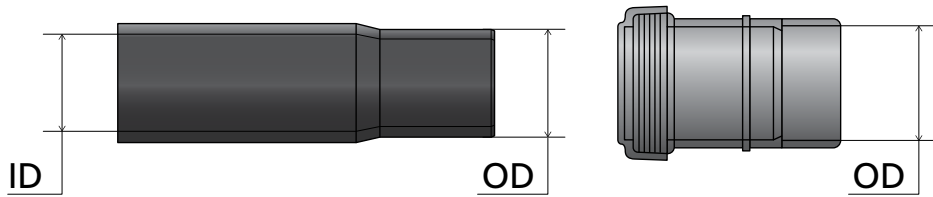

Material	OD					
	1/4"	1/2"	2"	3"	4"	6"
PVC-u	36mm	43mm	56mm	82mm	110mm	160mm
PP	35mm	41mm	54mm			
HDPE	40mm	50mm	56mm	90mm	110mm	160mm
dB12	40mm		50mm		110mm	160mm
Iron	42mm	47.8mm	60mm			
Copper	35mm	42mm	54mm		108mm	
Clay					100mm	
Vulcathene		48mm	60mm	89mm	114mm	
Cast iron					112mm	
Ridgidrain					118mm	176mm
Chrome	32mm					

Material	ID					
	1/4"	1/2"	2"	3"	4"	6"
PVC-u	32mm	39mm	52mm	76mm	104mm	154mm
PP	31mm	37mm	50mm			
HDPE	34mm	44mm	50mm	83mm	101mm	148mm
dB12	36mm		46mm		104mm	153mm
Iron	32mm	38mm	50mm			
Copper	32mm	39mm	51mm		104mm	
Clay					76mm	
Vulcathene		38mm	51mm	76mm	102mm	
Cast iron					98mm	
Ridgidrain					100mm	150mm
Chrome	28mm					

Note: Pipes to be chamfered and lubricated when being used with ring seal, use 9136250L Silicone grease.

References: 1. Terrain Soil and Waste Product Installation guide. 2. BSEN12056 Gravity drainage systems inside buildings. Sanitary pipework, layout and calculation.

For more information please call our [Technical Team on 01622 795200](tel:01622795200)

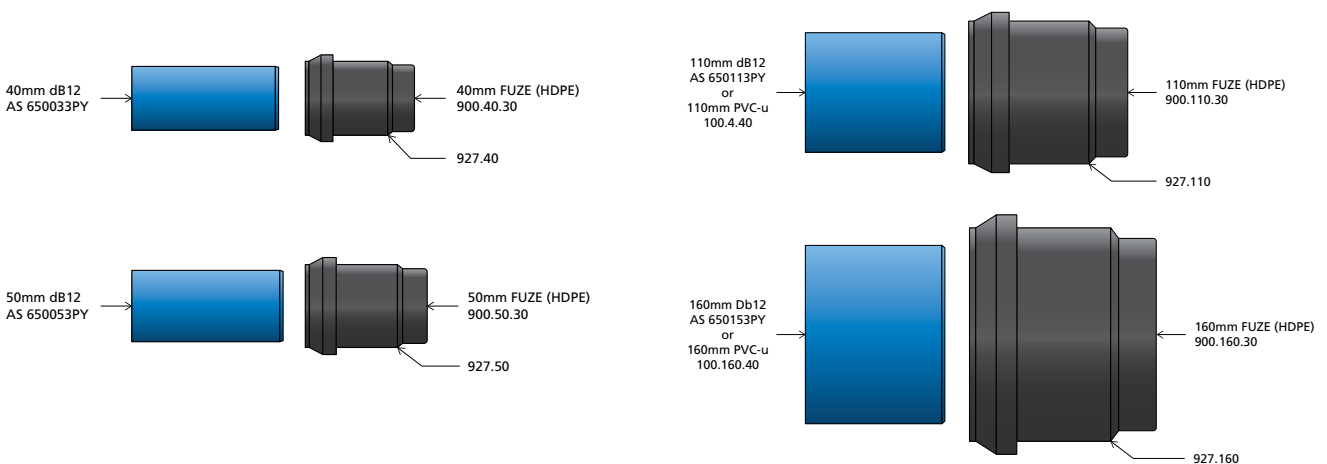

Joining Methods

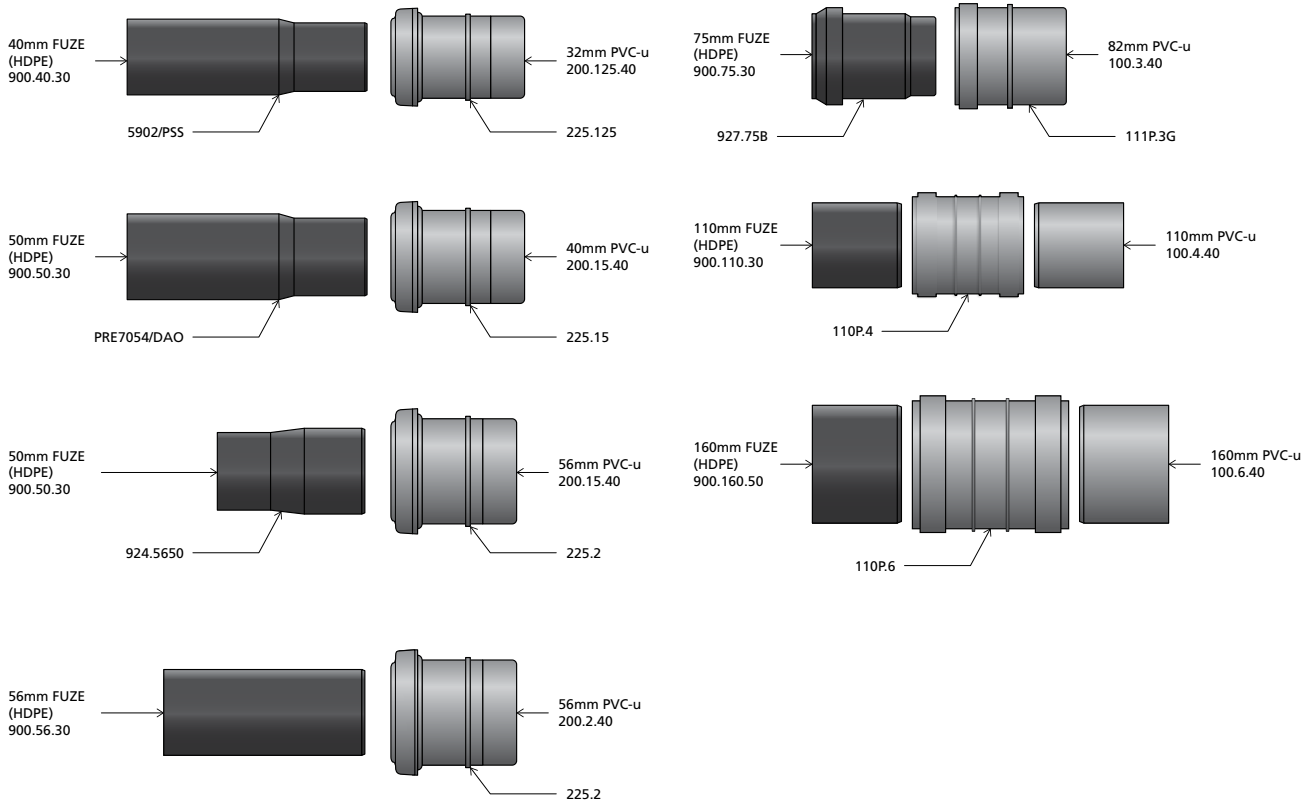

Vulcathene - FUZE (HDPE)

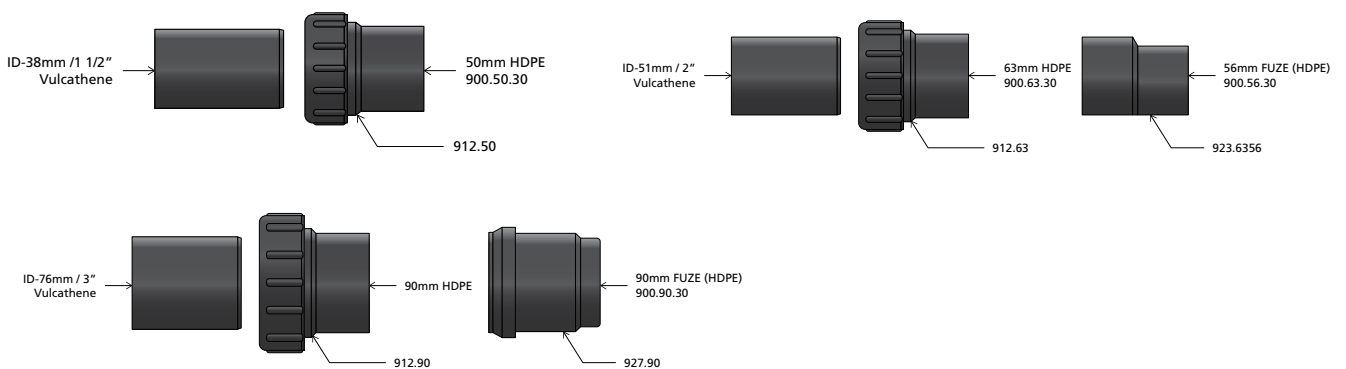

Chrome - FUZE (HDPE)

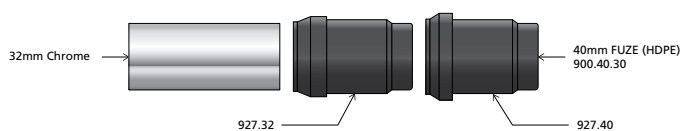

Terrain FUZE

PVC-u - FUZE (HDPE)

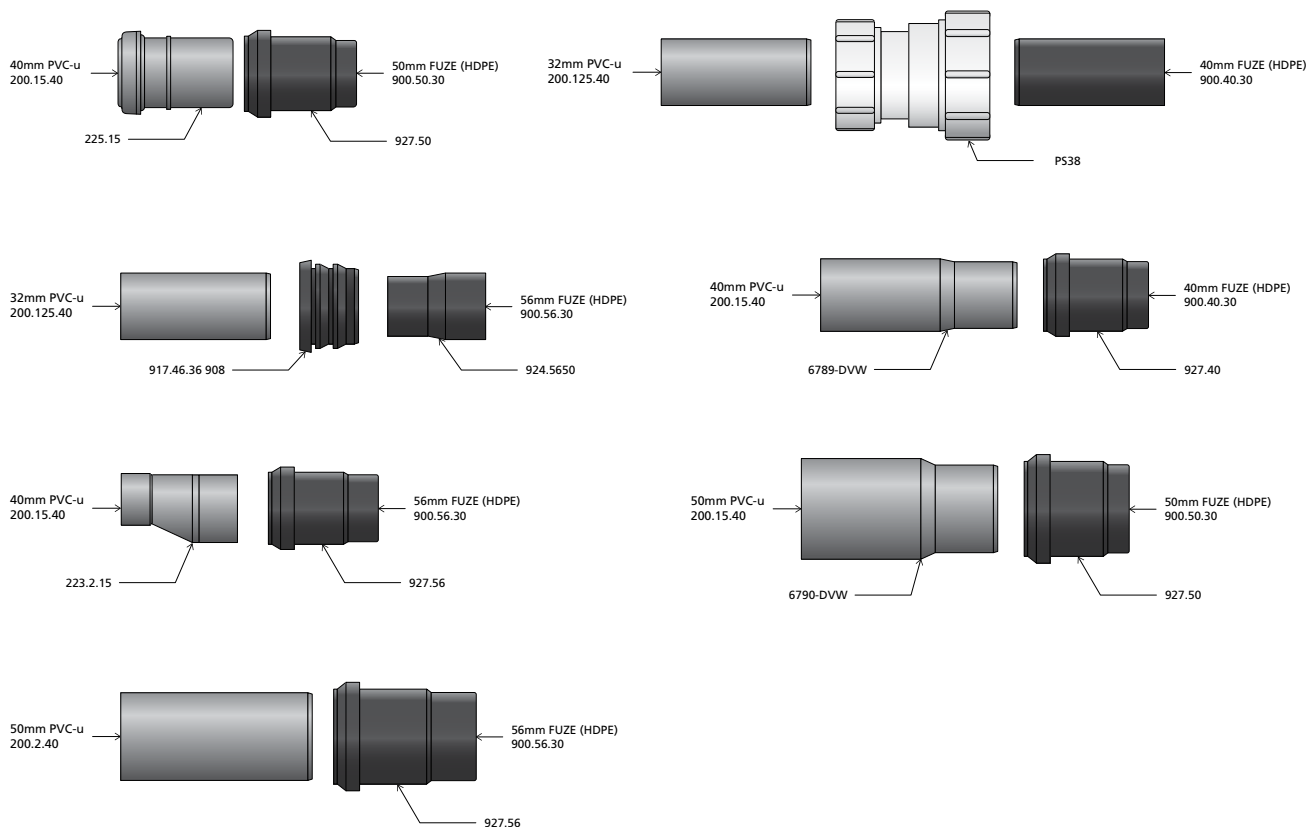

COMPATIBILITY TABLE

Part number	Terrain FUZE size	Compatibility			
		PVC (200 series)	PP (300 series)	ABS (600 series)	Copper
927.4036B	40mm	32mm 	32mm 	32mm 	35mm
927.5036B	50mm	32mm 	32mm 	32mm 	32mm
927.5043B	50mm	32mm 	32mm 	32mm 	32mm
927.5636B	56mm	32mm 	32mm 	32mm 	32mm
927.5643B	56mm	32mm 	32mm 	32mm 	32mm

Adapting to other materials

HDPE Thermal Expansion

Terrain FUZE HDPE pipe work systems expand and contract with changes in temperature, both ambient temperature and from the temperature of the waste discharge through the pipework. This guide describes the principles of thermal movement allowance and provides advice covering assembly and jointing techniques.

The advice and guidance is based on typical situations only. For further information contact the Terrain Technical Services Department.

Terrain FUZE HDPE offers substantial durability against the flow of hot water. A waste pipe with no mechanical load will tolerate temperatures of up to 80°C and up to 95°C is permissible for a maximum of two minutes.

Thermal movement **MUST** always be accounted for in both locked and expansion systems (explained in the next set of pages).

Calculating thermal movement

Terrain FUZE HDPE has a coefficient of expansion of 0.2 (mm/m/°C), the design and installation of above ground drainage systems must be able to accommodate for this. Calculate the thermal movement on straight lengths between anchors using:

$$\Delta L = \alpha L \Delta T$$

Where

ΔL = expansion (mm) OR contraction (-mm)

α = co-efficient of linear expansion (mm/m/°C)
Terrain FUZE HDPE, 0.2

L = Total length of the pipe between anchor points (m)

ΔT = Temperature difference (°C)

NB. For waste discharges ΔT should always be calculated from 0°C, so if the temperature of the water in the pipe is to be 60°C, then ΔT is 60°C.

Example 1 - Typical vertical stack

Example 1 - Typical vertical stack A 10 storey foul drainage stack will collect and convey domestic waste (assumed temperature 60°C) and connect directly to drain. Each storey is 3m high.

$$\Delta L = \alpha L \Delta T$$

$$\Delta L = 0.2 \times 3.0 \times 60 = 36\text{mm thermal movement per floor.}$$

Example 2 - Typical suspended pipe run

A 20 metre, high-level lateral run has been designed in an open car park area. The maximum length between anchor points should be 5m. The assumed temperature of the waste fluid is 50°C.

$$\Delta L = \alpha L \Delta T$$

$$\Delta L = 0.2 \times 5.0 \times 50 = 50\text{mm thermal movement between anchor points.}$$

Terrain FUZE

Vertical Expansion System

Expansion system anchored below slab

Rail system rules apply as per page 44.

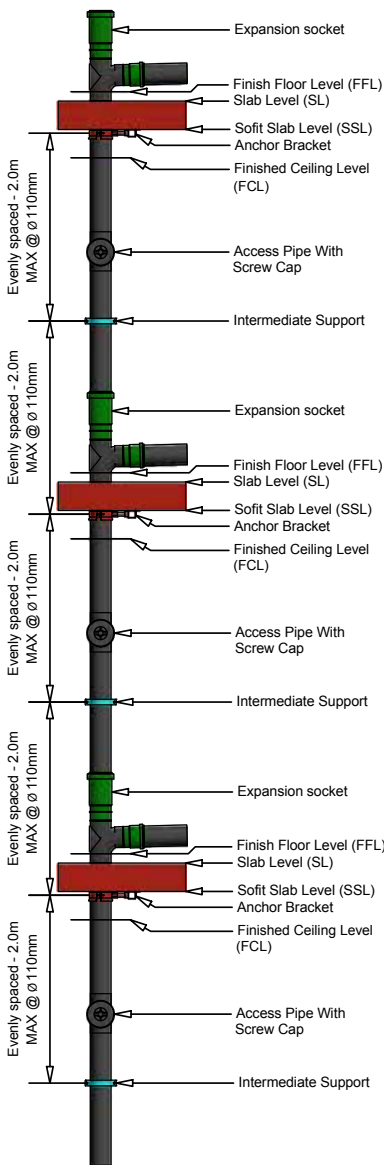

Expansion system anchored above slab

Rail system rules apply as per page 44.

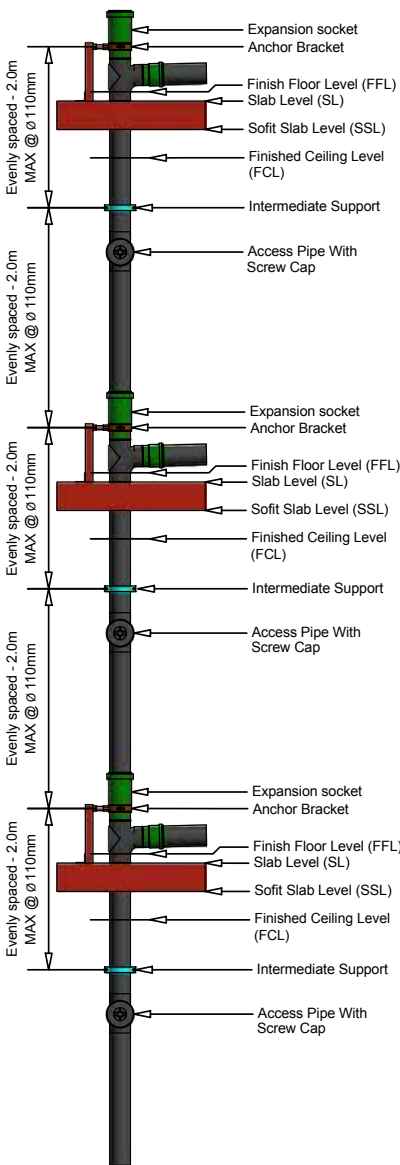

Examples of expansion system anchored to a structural wall

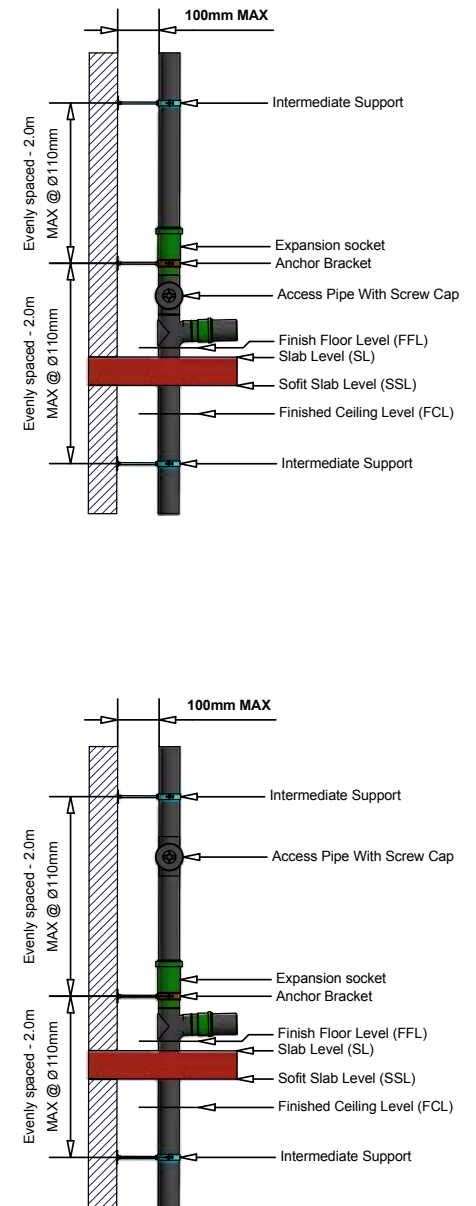

Installation details

Horizontal Expansion System

Support and expansion socket distances

Unless there is an alternative provision for thermal movement, pipework should be fitted with expansion sockets in the following locations:

- At spacing's no greater than 5m for pipework OD $\geq 75\text{mm}$ and above
- At spacing's no greater than 2m for pipework OD $\leq 63\text{mm}$ and below
- Where the maximum distance between fixed points exceeds 2m
- At changes of direction or branch runs greater than 1m in length
- Any point where pipework passes through a floor or wall and is made good or fire-stopped must be treated as an anchor point when determining positions of expansion sockets
- Low Level WC Manifolds incorporate ring seal adaptors at each branch connection to compensate for thermal movement and also allow the branch to be 'turned' to the correct angle to allow connection to the WC

Horizontal Expansion System		
Pipe size diameter (OD mm)	Maximum distance between expansion sockets (m)	Intermediate support at any change of direction and at below maximum centres (mm)
40	2.0	400
50	2.0	500
56	2.0	560
63	2.0	630
75	5.0	750
90	5.0	900
110	5.0	1100
125	5.0	1250
160	5.0	1600
200	5.0	2000
250	5.0	2500
315	5.0	3000

* See table on page 49 for pipe weights (empty and full).

Example - $\text{\O}160\text{mm}$ Pipe

Key

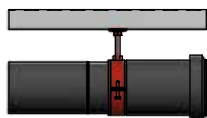

Anchor bracket & Expansion socket

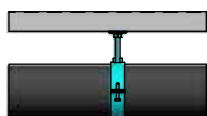

Intermediate support

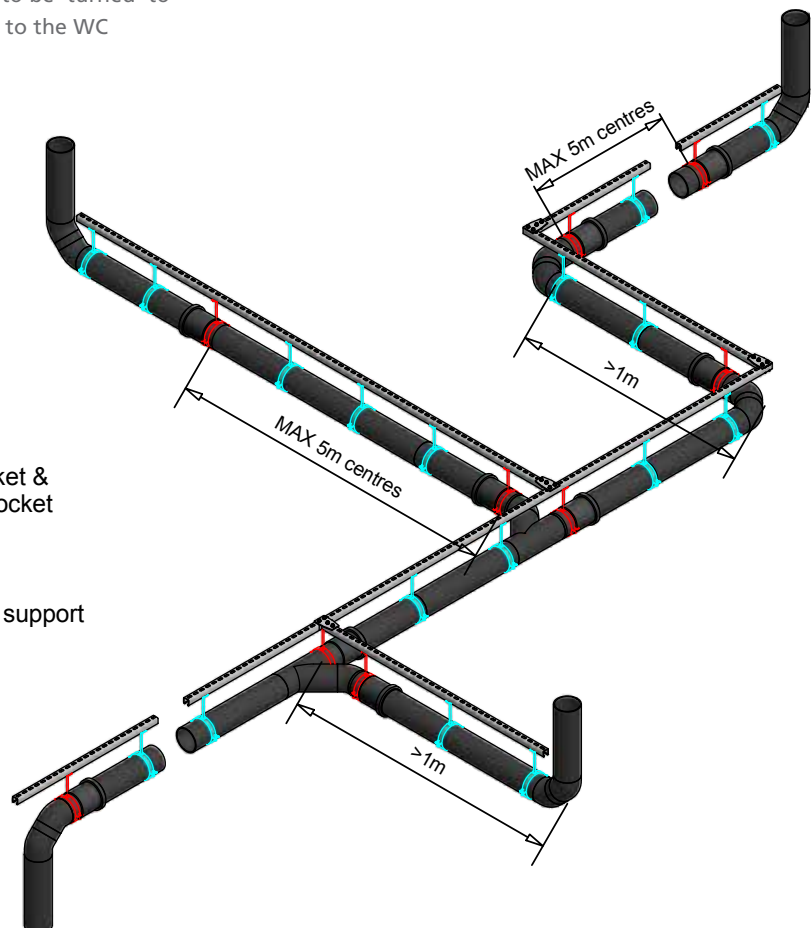

Terrain FUZE

Bracketing an Expansion System

- Terrain FUZE HDPE can be anchored from the slab or off a rail system
- Cross bracing must be used for drop rods longer than figures shown below
- Rails are not supplied by Polypipe Terrain

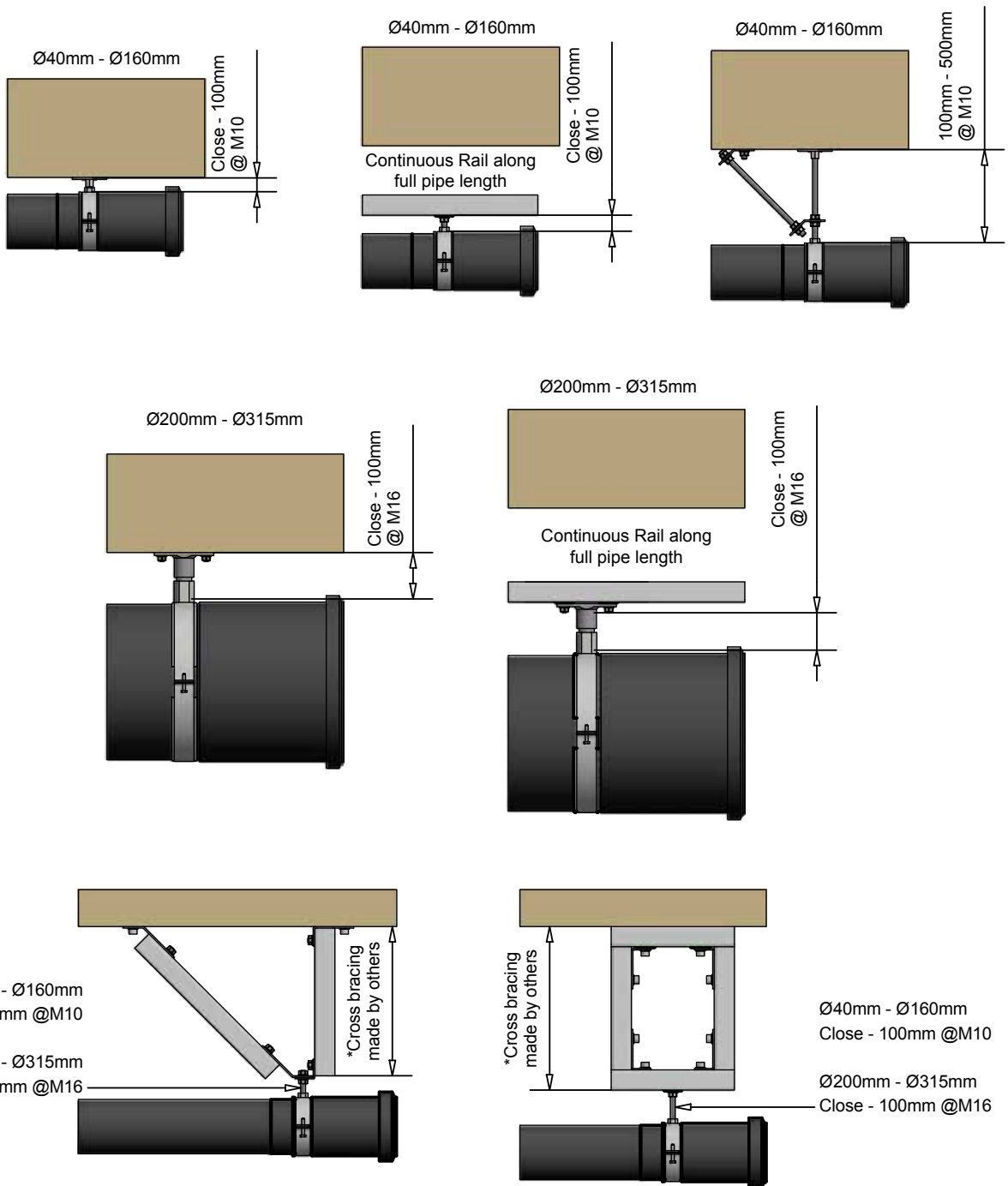

Installation details

Example of an Expansion System

Expansion sockets may be omitted if alternative provision is created in one of the following ways.

- Above the highest branch connection to a foul and/or waste stack is free to move through a weatherproof sleeve

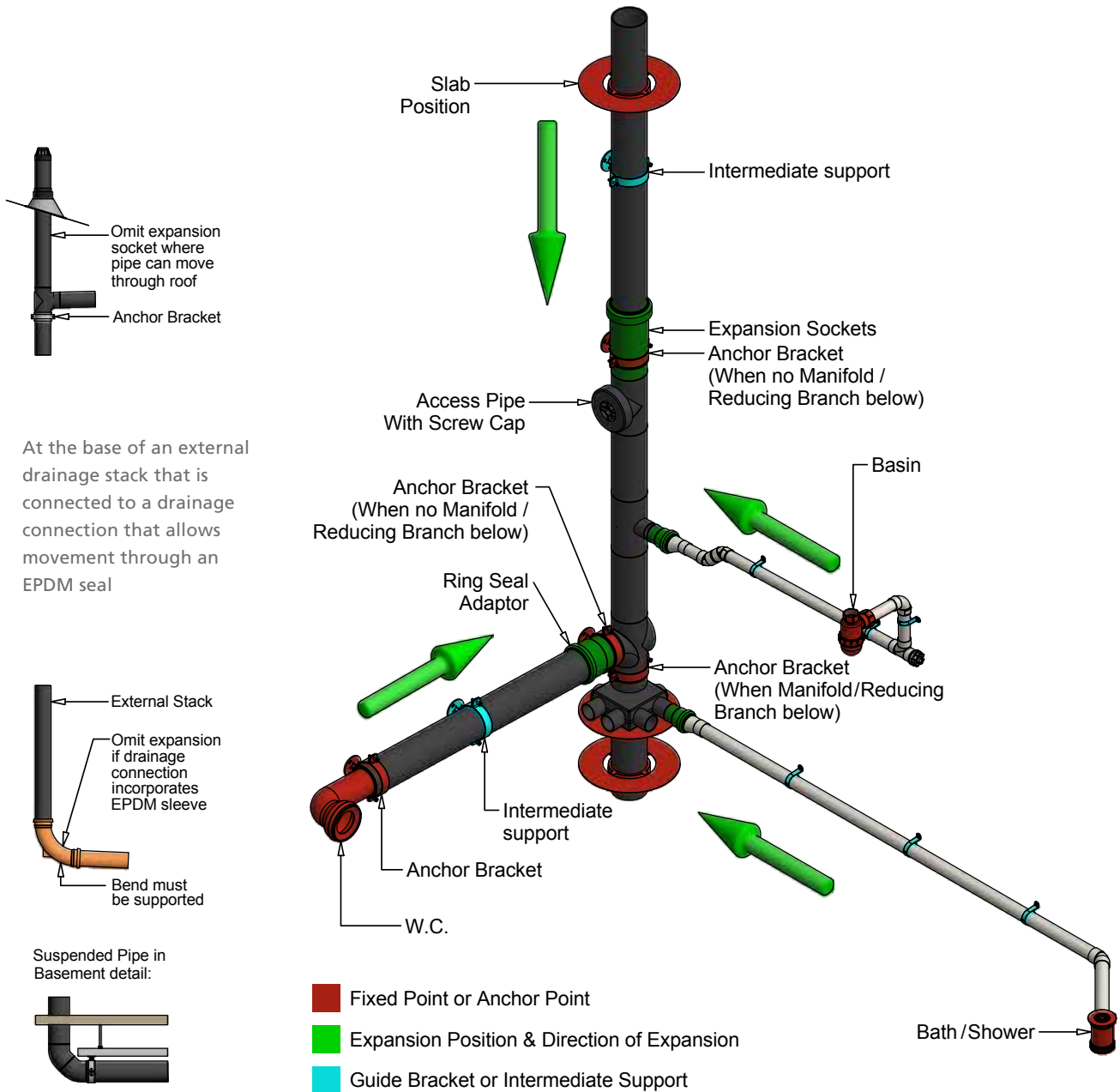

Terrain FUZE

Vertical Locked System

Locked system anchored below slab

Rail system rules apply as per page 46.

Locked system anchored above slab

Rail system rules apply as per page 46.

Locked system anchored to a structural wall

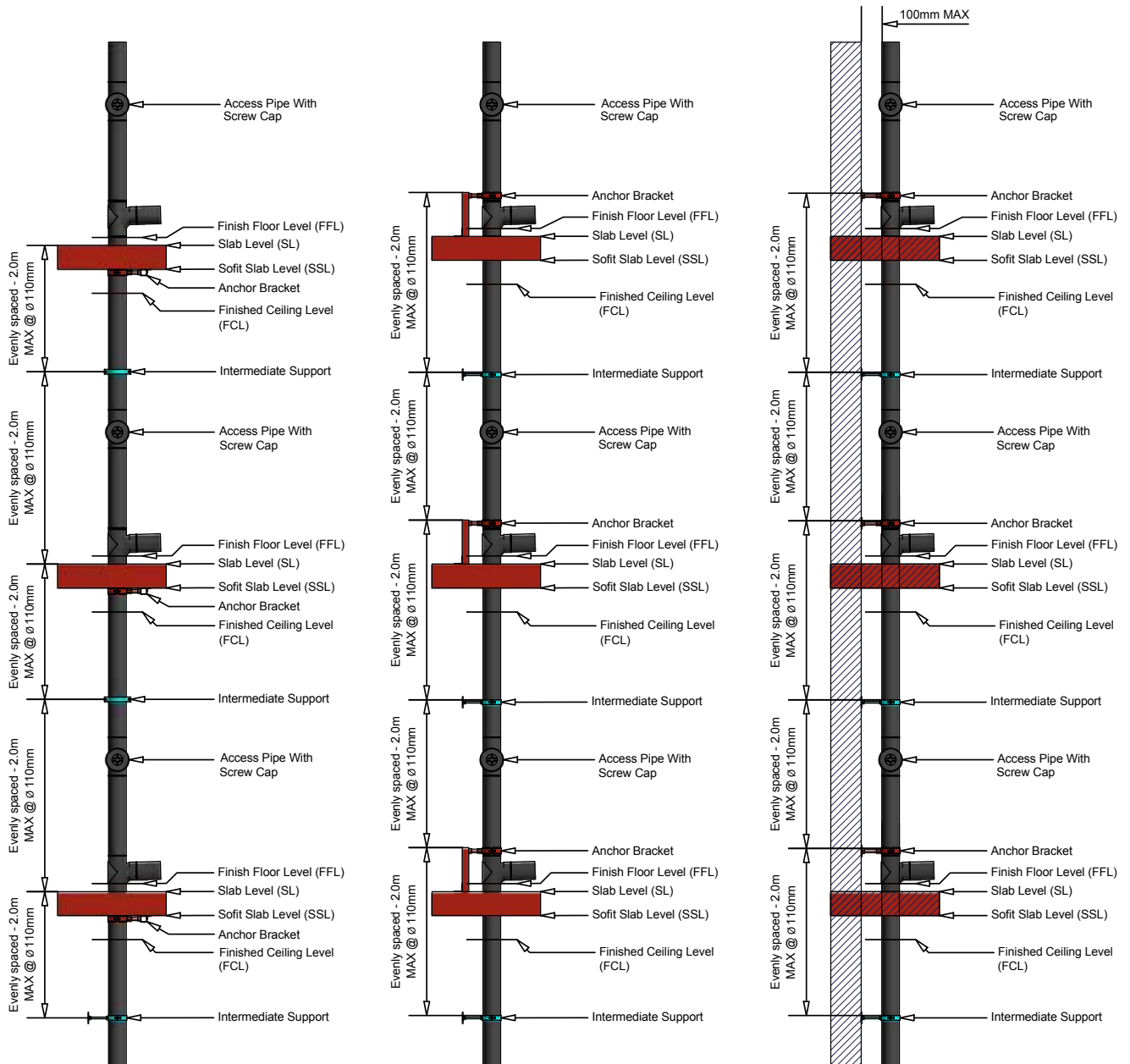

Installation details

Horizontal Locked System

Support and anchor brackets

Unless there is an alternative provision for thermal movement, pipework should be fitted with anchor brackets in the following locations:

- At spacing's no greater than 5m for pipework OD $\geq 75\text{mm}$ and above
- At spacing's no greater than 2m for pipework OD $\leq 63\text{mm}$ and below
- Where the maximum distance between fixed points exceeds 2m
- At changes of direction or branch runs greater than 1m in length
- Any point where pipework passes through a floor or wall and is made good or fire-stopped must be treated as a fixed point when determining positions of anchor brackets

Pipe will still expand and contract into itself in a locked system. Even in a locked system, thermal movement needs to be accounted for.

Example - $\text{\O}160\text{mm}$ Pipe

Key

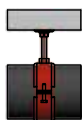

Anchor bracket

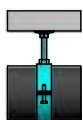

Intermediate support

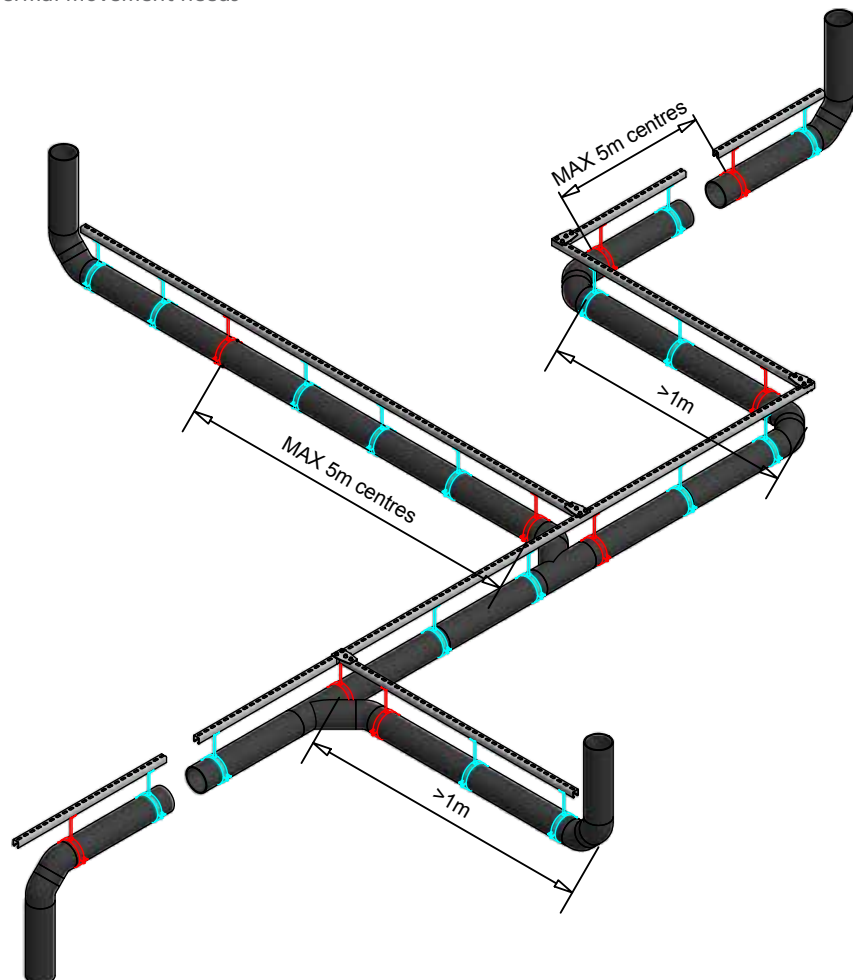

Horizontal Expansion System		
Pipe size diameter (OD mm)	Maximum distance between anchor brackets on straight pipe run (m)	Maximum distance between intermediate supports (mm)
40	2.0	400
50	2.0	500
56	2.0	560
63	2.0	630
75	5.0	750
90	5.0	900
110	5.0	1100
125	5.0	1250
160	5.0	1600
200	5.0	2000
250	5.0	2500
315	5.0	3000

* See table on page 49 for pipe weights (empty and full).

Terrain FUZE

Bracketing a Locked System

Types of Anchor Brackets on locked rail system

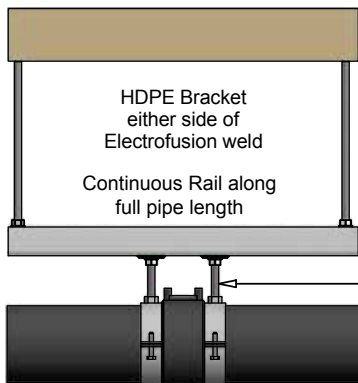

Ø 40 - Ø 160 M10
Close - 100mm

Ø 200 - Ø 315 M16
Close - 100mm

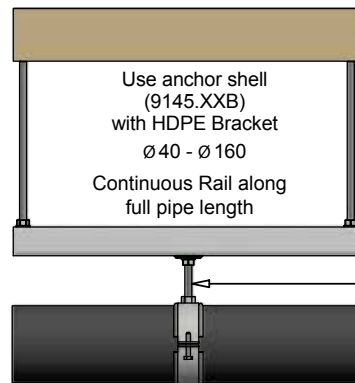

Ø 40 - Ø 160 M10
Close - 100mm

Ø 200 - Ø 315 M16
Close - 100mm

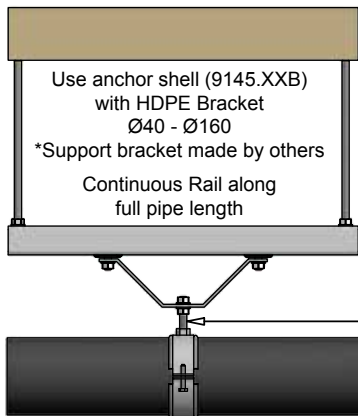

Ø 40 - Ø 160 M10
Close - 100mm

Ø 200 - Ø 315 M16
Close - 100mm

Use anchor shell
(9145.XXB)
with HDPE Bracket

Ø 40 - Ø 160

*Support bracket made by others

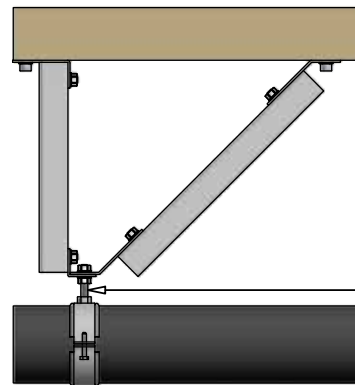

Ø 40 - Ø 160 M10
Close - 100mm

Ø 200 - Ø 315 M16
Close - 100mm

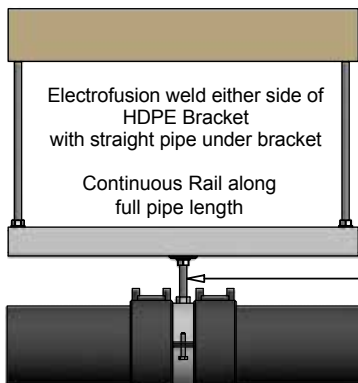

Ø 40 - Ø 160 M10
Close - 100mm

Ø 200 - Ø 315 M16
Close - 100mm

Use anchor shell
(9145.XXB)
with HDPE Bracket

Ø 40 - Ø 160

*Support bracket made by others

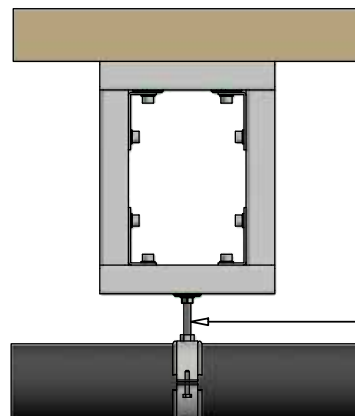

Ø 40 - Ø 160 M10
Close - 100mm

Ø 200 - Ø 315 M16
Close - 100mm

Installation details

Summary of Expansion & Locked Systems

Expansion systems

Rulings for anchor brackets in an expansion system:

- Pipe diameters up to 160mm - M10 drop rods up to 100mm below slab or rail
- Pipe diameters up to 160mm - M10 drop rods with M10 cross brace up to 500mm below slab or rail
- Pipe diameters up to 160mm where the vertical drop is greater than listed above use either the rail system or use Unistrut as a drop rod with a cross brace and an M10 connection to the bracket
- Pipe diameters 200-315mm - M16 drop rods up to 100mm below slab or rail
- Pipe diameters 200-315mm where the vertical drop is greater than listed above use either the rail system or use Unistrut as a drop rod with a cross brace and an M16 connection to the bracket

Locked systems

Rulings for anchor brackets in a locked system:

- In no circumstances should drop rods alone be used to support a locked anchor point
- Close coupled rail system up to 160mm diameter - M10 connection between bracket and rail
- Close coupled rail system 200-315mm diameter - M16 connection between bracket and rail
- Pipe diameters 200-315mm - M16 drop rods up to 100mm below slab or rail
- If the rail is not being used a suitable drop support needs to be created using Unistrut and a cross brace with the same size connections to brackets as listed above for a rail system

Horizontal Expansion System		
FUZE HDPE pipe diameter (OD mm)	Pipe weight full of water (Kg/m)	Pipe weight empty (Kg/m)
40	1.278	0.370
50	1.986	0.460
56	2.493	0.530
63	3.147	0.595
75	4.479	0.740
90	6.391	0.980
110	9.525	1.450
125	12.283	1.860
160	20.190	3.080
200	31.741	4.100
250	49.252	6.100
315	78.045	9.510

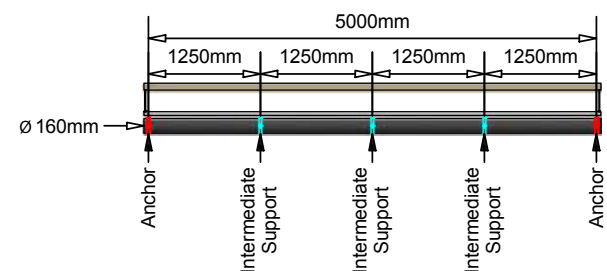
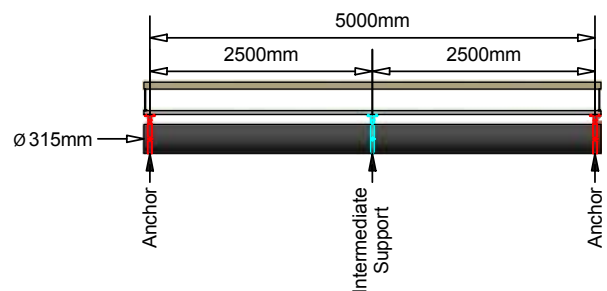

Terrain FUZE

WC connections

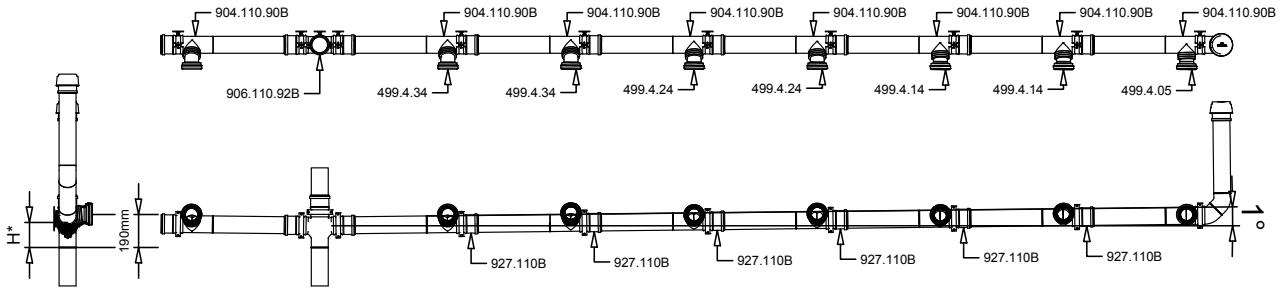

Float laid to a Fall of 1° (17mm drop/1metre run)

Note: If a secondary ventilation system is being installed then expansion must be provided to both the soil and waste stack and the secondary ventilation stack. Note: It is important to lubricate the ring seal adaptor with silicone grease.(9136.250L).

WC position (height H* from FFL)							
H*	1	2	3	4	6	6	7
mm	170	156	142	128	114	100	86

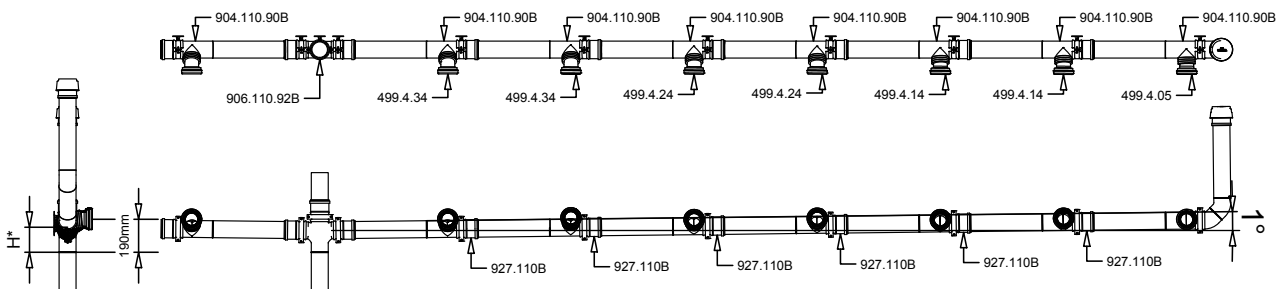

Risers and branches

It is recommended that an expansion socket is incorporated at each floor level when designing and installing FUZE HDPE stacks in multi-storey buildings. Where a branch is taken off a main run, the thermal movement of the main run is going to affect the branch.

- Establish the distance between the branch and the nearest anchor
- Calculate the movement at the point where the branch joins the run
- Establish the hole size through the wall and ensure that there is enough space for the branch to naturally flex, taking into account that the movement of the branch will be limited where it passes through a wall
- If there is not enough room for the required offset, think about adding expansion sockets and anchor points to the main run to reduce the amount of movement experienced by the branch

Installation details

Deflection Leg

The flexibility of Terrain FUZE permits expansion or contraction to be compensated for by means of directional change within a pipe system (deflection leg) as shown below. To allow the pipe to deflect at a change in direction it is essential to calculate the distance to the first bracket (a) so that the pipe is free to expand and contract.

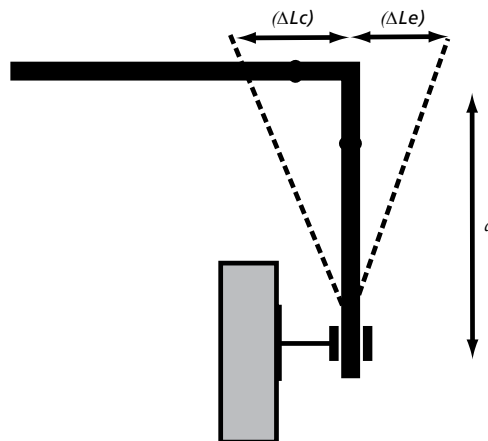

Step 1: Calculate the change in length

$$\Delta L = \alpha \times L \times \Delta T$$

Where:

ΔL = Expansion (mm) or contraction (-mm)

α = Co-efficient of linear expansion (mm/m°C). For Terrain FUZE $\alpha=0.2$

L = Total length of the pipe between anchor points (m)

ΔT = Temperature difference (°C)

Note: For waste discharges ΔT should always be calculated from 0°C so if the max. water temperature is 60°C, ΔT is 60°C

Step 2: Determine the length of the deflection leg

$$a = 10 \times \sqrt{(\Delta L \times \text{Ø})}$$

Where:

a = Deflection leg length (distance to first bracket)

ΔL = Expansion (mm) or contraction (-mm) from Step 1 above

Ø = Pipe outside diameter (mm)

Terrain FUZE

Non-pressure Underground Installation

HDPE pipes marked (BD) are also suitable for underground applications.

Strict attention must be given to the trench where the pipe is to be laid. This must be completely flat and should be void of any sharp objects or stones which could cause localised deformation of the pipeline. A minimum bedding of 10cm of sand should be used to provide continual support along the whole length of the pipe and minimise the risk of point-loading within the trench. Following this, the first 15-20cm of cover should be of sand again and this must be compressed to avoid pipe movement. Compacting of the cover material should take place immediately after the pipe has been covered to restrict the initial stages of movement. The depth of the trench is dependant upon whether the application is trafficked or non-trafficked and the possibility of freezing temperatures. Official guidelines, standards and regulations should be observed to calculate this requirement. (See illustrations)

A minimum depth of 80cm must cover the pipe. To evenly distribute ground pressure on trafficked applications it is recommended to cover the layer of sand with a light concrete casting.

Two or more pipes laid in the same trench should not come into contact. A recommended distance of 10-15cm should remain between each pipeline to facilitate future maintenance. As with a standard pipe installation, this void should be filled with sand and compacted.

Rigid installations, where the pipeline is covered with concrete, do not undergo the same stresses as normal laying conditions and therefore the pipe is at no risk of deformation.

In underground installations, the ambient temperature is fairly stable and the fluid temperatures from the varying inlets have mixed and stabilised within the above ground pipe system. Expansion sockets are not required every six metres.

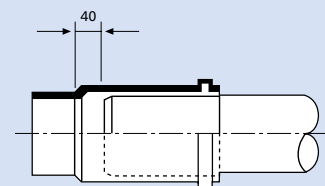
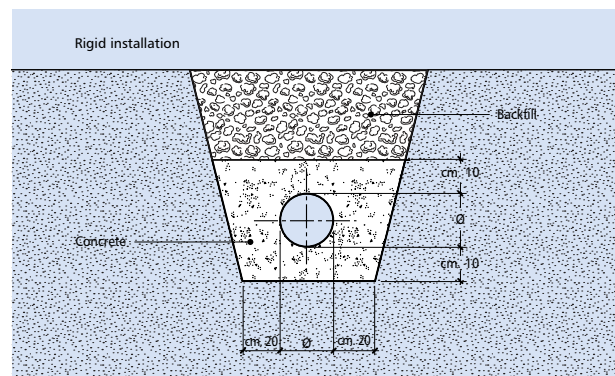
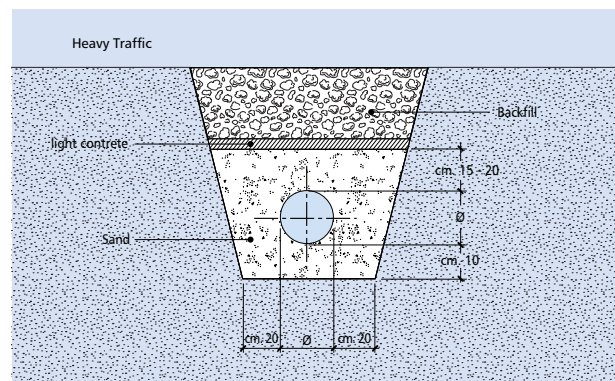
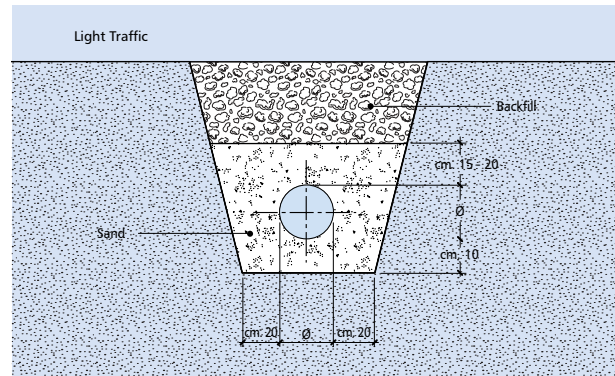

N.B.: The spigot should be pushed fully into the expansion socket, marked at the socket edge and withdrawn by 40mm.

Installation details

Special Consideration for Buried Drain Application

The Terrain FUZE HDPE system is suitable for buried drain applications under the envelope of the building at reasonable shallow depths and normal conditions.

When any of the following conditions exist please contact Polypipe Terrain for confirmation on its suitability:

- Pipes at depths greater than 4 metres below ground level
- Pipes subjected to external water pressures exceeding 2 metres head (high water table)
- Contaminated ground conditions
- Pipes subjected to internal negative pressures
- If during the construction stage high point loads will be experienced due to heavy plant etc.
- If other manufacturers components are to be incorporated into the system
- Non domestic type discharges are expected, for example:
 - High volume discharges that could subject the pipe to more than 1.5 bar pressure
 - Combined high temperature and high volume discharges
 - Chemical waste
 - Radioactive waste

When leaving the footprint of the building we would recommend adapting onto a system designed for this purpose. Ridgidrain, for surface water drainage, or Polysewer, for foul sewers from Polypipe Civils are suitable systems for these applications.

Ridgidrain

- Surface water applications
- 100-900mm diameter HDPE pipes and fittings
- BBA approved



Polysewer

- Foul and combined applications
- 150 – 300mm diameter PVCu pipes and fittings
- BSi Kitemarked and BBA approved



For further information please contact Polypipe Civils on 01509 615100 or civils@polypipe.com

Terrain FUZE

The Terrain Firetrap Sleeve is a cost-effective product for the fire stopping of pipe penetrations whilst maintaining similar thermal and acoustic properties as standard mineral fibre insulation. Terrain Firetrap Sleeve was developed with ease of installation in mind. The sleeve can be quickly and simply fitted onto the pipe and slid into the penetration ensuring that there are no air gaps around the sleeves by filling with mortar or mastic. In a fire situation, the sleeve expands to fill the available space (15mm max) between the pipe and the penetration and will crush and close off plastic drainage pipes. The pipe forms a solid char preventing the passage of fire and smoke to the adjacent compartment.

Applications

- For Terrain PVC, Terrain FUZE and Terrain Acoustic dB12 above ground drainage through:
- Concrete, masonry or plasterboard partitions
- Concrete floor constructions

Benefits

- Up to 4 Hour Fire Rating to BS 476 Part 20, BS EN 1366-3
- Protects pipe above and below the slab
- Cost effective
- One sleeve can replace two collars
- Easy installation
- Don't have to drill slab
- No need for mechanical fixings
- No mastic is required, providing close fit
- Easily cut to size to minimise wastage
- Simple to install without special tools or skills
- Will accept hole irregularities of up to 15mm
- Can be retro-fitted
- Offers excellent acoustic insulation
- Maintains the thermal insulation of the pipe through the slab or wall penetration
- Maintains vapour seal of existing insulation
- Allows for thermal movement of pipe



Terrain Firetrap Sleeve
was developed with ease
of installation in mind.

Part no	Pipe diameter suitable for (mm)	Sleeve hole diameter (mm)	Sleeve outside diameter (mm)	Length (mm)
1925.42	40	42	92 - 104	300
1925.54	50	54	104 - 116	300
1925.60	56	60	110 - 122	300
1925.67	63	67	117 - 129	300
1925.76	75	76	126 - 138	300
1925.102	90	102	152 - 164	300
1925.114	110	114	164 - 176	300
1925.127	125	127	177 - 189	300
1925.169	160	169	219 - 231	300

Firetrap Sleeves

Fire protection for vertical Terrain drainage pipework in a NON fire rated duct

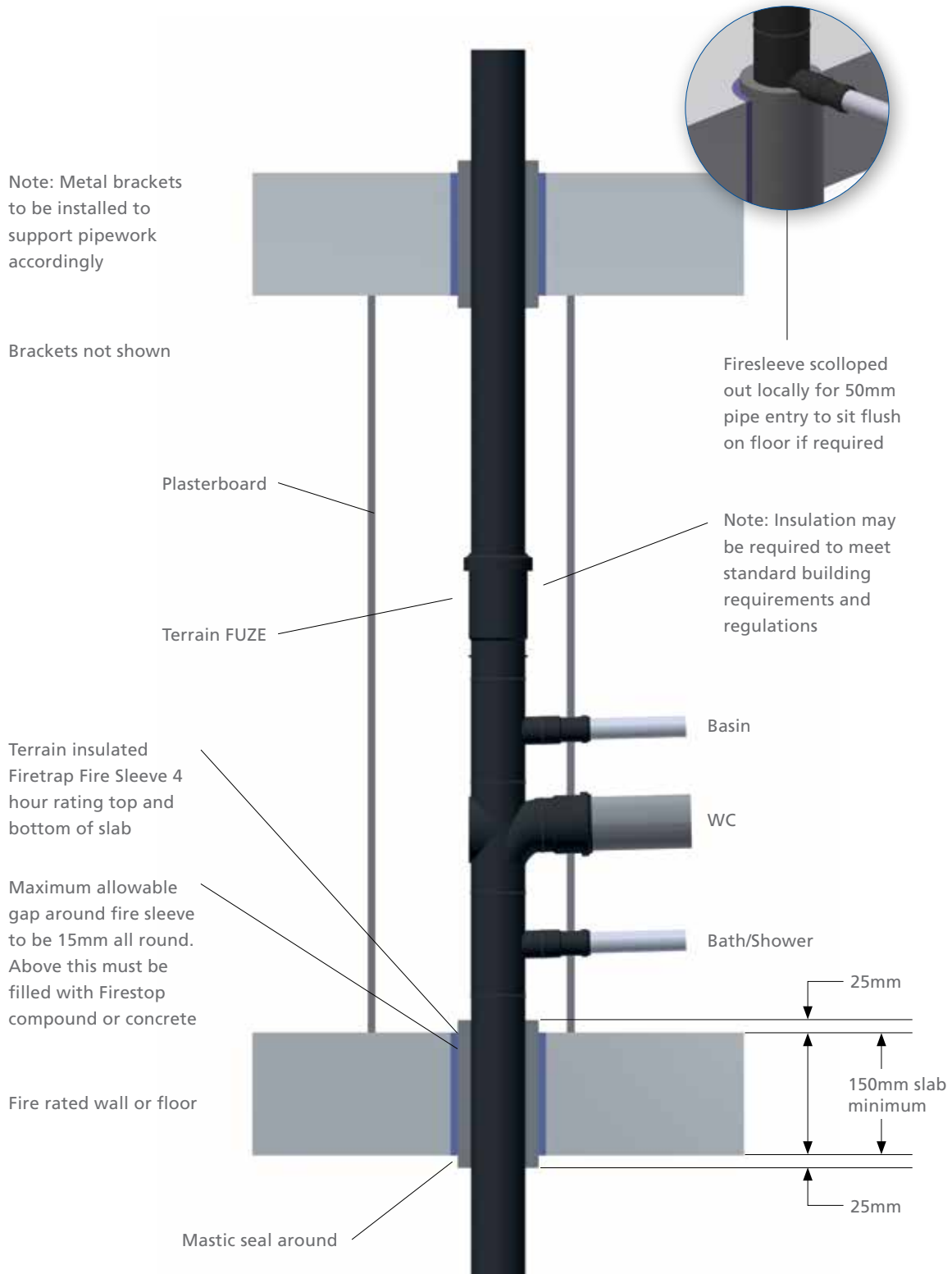

Terrain FUZE

Terrain Firetrap Collars have been specifically designed to re-instate the fire resistance of a wall or floor which has been penetrated by services such as Terrain PVC, Terrain FUZE or Terrain Acoustic dB12.

Manufactured in steel, each fire collar contains an internal lining of intumescent graphite impregnated organic polymer. Anchoring hooks are also supplied. The collars will seal pipes from 50mm to 315mm diameter and can be face fixed or set-in to a wall or ceiling structure. They are suitable for use on concrete, masonry and plasterboard partitions.

They have a up to 2 hour fire rating and feature mounting tabs for quick and easy installation.

Applications

For Terrain PVC, Terrain FUZE and Terrain Acoustic dB12 above ground drainage through:

- Concrete, masonry or plasterboard partitions
- Concrete floor construction
- Fire-proof concrete
- Brickwork walls

Features

- Up to 2 Hour fire rating
- Powder coated steel sleeve
- Can be surface mounted or built in
- Mounting tabs for quick and easy installation
- Seals against smoke, toxic gases, flames and heat
- Can be installed in a recessed area to minimize overall dimensions
- Maintains vapour seal of existing insulation
- Allows for thermal movement of pipe



Product code	ø	Fire rating
1625.40R	40mm	2 Hour
1625.55R	55mm	2 Hour
1625.63R	63mm	2 Hour
1625.75R	75mm	2 Hour
1625.82R	82mm	2 Hour
1625.90R	90mm	2 Hour
1625.110R	110mm	2 Hour
1625.125R	125mm	2 Hour
1625.160R	160mm	2 Hour
1625.200R	200mm	2 Hour
1625.250R	250mm	2 Hour
1625.315R	315mm	2 Hour



Collars will seal pipes from 40mm to 315mm diameter and can be face fixed or set-in to a wall or ceiling structure

Firetrap Collars

Fire protection for vertical Terrain drainage pipework in a NON fire rated duct

Note: Metal brackets to be installed to support pipework accordingly

Brackets not shown

Plasterboard

Terrain FUZE

Terrain insulated
Firetrap Fire Sleeve 4
hour rating top and
bottom of slab

Maximum allowable
gap around fire sleeve
to be 15mm all round.
Above this must be
filled with Firestop
compound or concrete

Fire rated wall or floor

Mastic seal around

Firecollar

Note: Insulation may be required
to meet standard building
requirements and regulations

Basin

WC

Bath/Shower

150mm slab
minimum

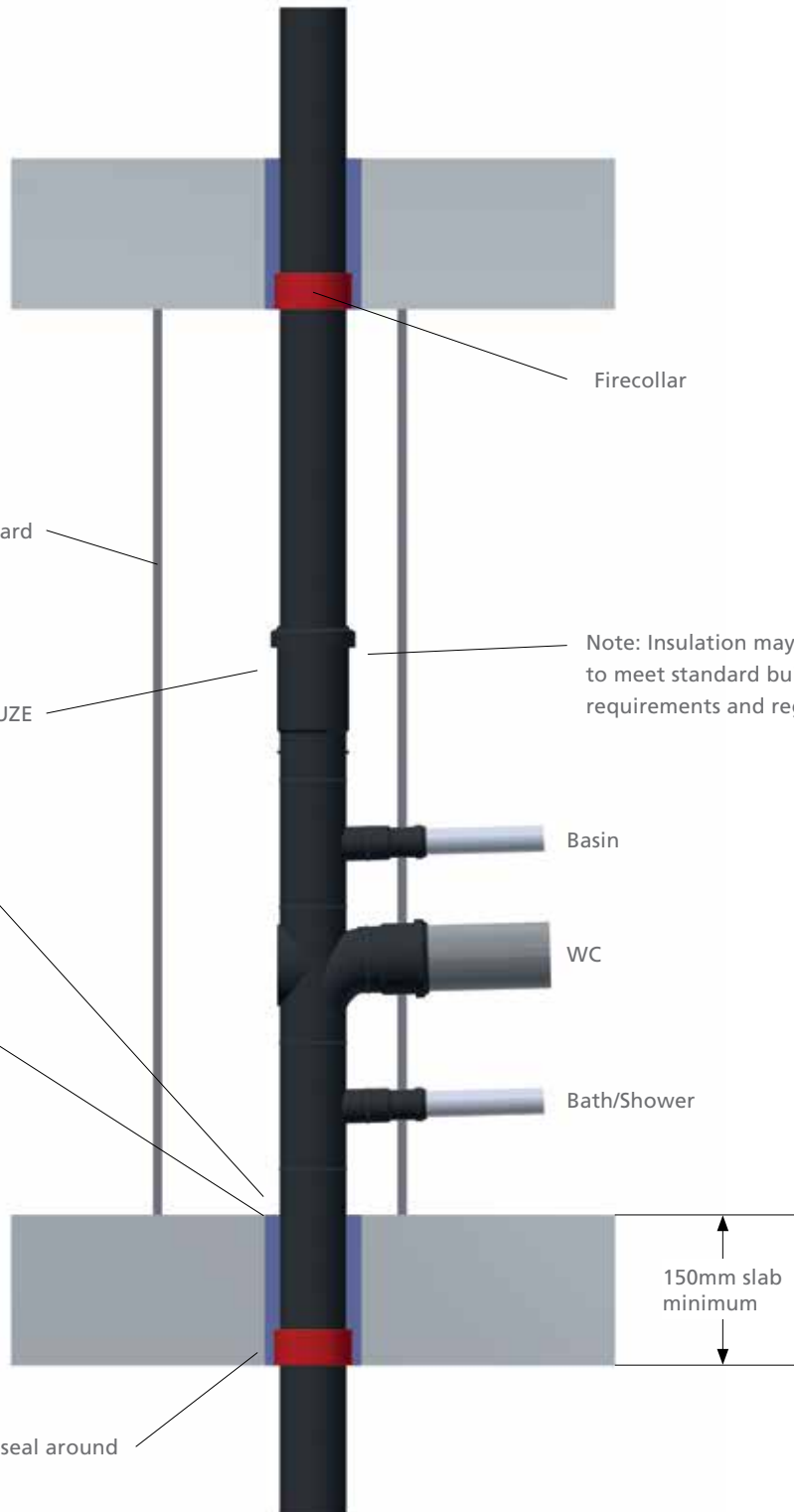

Terrain FUZE

Terrain FUZE should be tested in accordance with guidelines stated within BS EN 12056-2: 2000 (Annex NG.3.1) which lays out the following:

NG.3 Testing

NG.3.1 Air test

NOTE Normally this test is carried out to confirm that all pipes and fittings are airtight. It should be completed in one operation but for large multi-storey systems testing in sections may be necessary.

NG.3.1.1 Preparation

The water seals of sanitary appliances should be fully charged and test plugs or bags inserted into the open ends of the pipework to be tested. To ensure that there is a satisfactory air seal at the base of the stack, or at the lowest plug or bag in the stack if only a section of the pipework is to be tested, a small quantity of water sufficient to cover the plug or bag can be allowed to enter the system. One of the remaining test plugs should be fitted with a tee piece, with a cock on each branch, and one branch being connected by means of a flexible tube to a manometer. Alternatively, a flexible tube from a tee piece fitted with cocks on its other two branches can be passed through the water seal of a sanitary appliance. Any water trapped in this tube should be removed and then a manometer can be connected to one of the branches.

NG.3.1.2 Application

Air is pumped into the system through the other branch of the tee piece until a pressure equal to 38 mm water gauge is obtained. The air inlet cock is then closed and pressure in the system should remain constant for a period of not less than 3 min.

NG.3.1.3 Leak location

NOTE Defects revealed by an air test may be located by the methods given in NG.3.1.3.1, NG.3.1.3.2 and NG.3.1.3.3.

NG.3.1.3.1 Smoke

A smoke producing machine may be used which will introduce smoke under any pressure into the defective pipework. Leakage may be observed as the smoke escapes. Smoke cartridges containing special chemicals should be used with caution, taking care that the ignited cartridge is not in direct contact with the pipework and that the products of combustion do not have a harmful effect upon the materials used for the discharge pipe system. Smoke testing of plastics pipework should be avoided due to naphtha having a detrimental effect, particularly on ABS, PVC-U and MUPVC. Rubber jointing components can also be adversely affected.

NG.3.1.3.2 Soap solution

With the pipework subject to an internal pressure using the smoke machine method as described in NG.3.1.3.1, a soap solution can be applied to the pipes and joints. Leakage can be detected by the formation of bubbles.

NG.3.1.3.3 Water test

There is no justification for a water test to be applied to the whole of the plumbing system. The part of the system mainly at risk is that below the lowest sanitary appliance, and this may be tested by inserting a test plug in the lower end of the pipe and filling the pipe with water up to the flood level of the lowest sanitary appliance, provided that the static head does not exceed 6 m.

*For accurate readings, please ensure equipment is regularly checked.

Permission to reproduce extracts from BS EN 12056-2:2000 is granted by BSI. British Standards can be obtained in PDF or hard copy formats from the BSI online shop: www.bsigroup.com/Shop or by contacting BSI Customer Services for hardcopies only: Tel: +44 (0)20 8996 9001, Email: cservices@bsigroup.com.

System testing

Air pressure test to comply with BS EN 12056-2

For testing a stack with connections

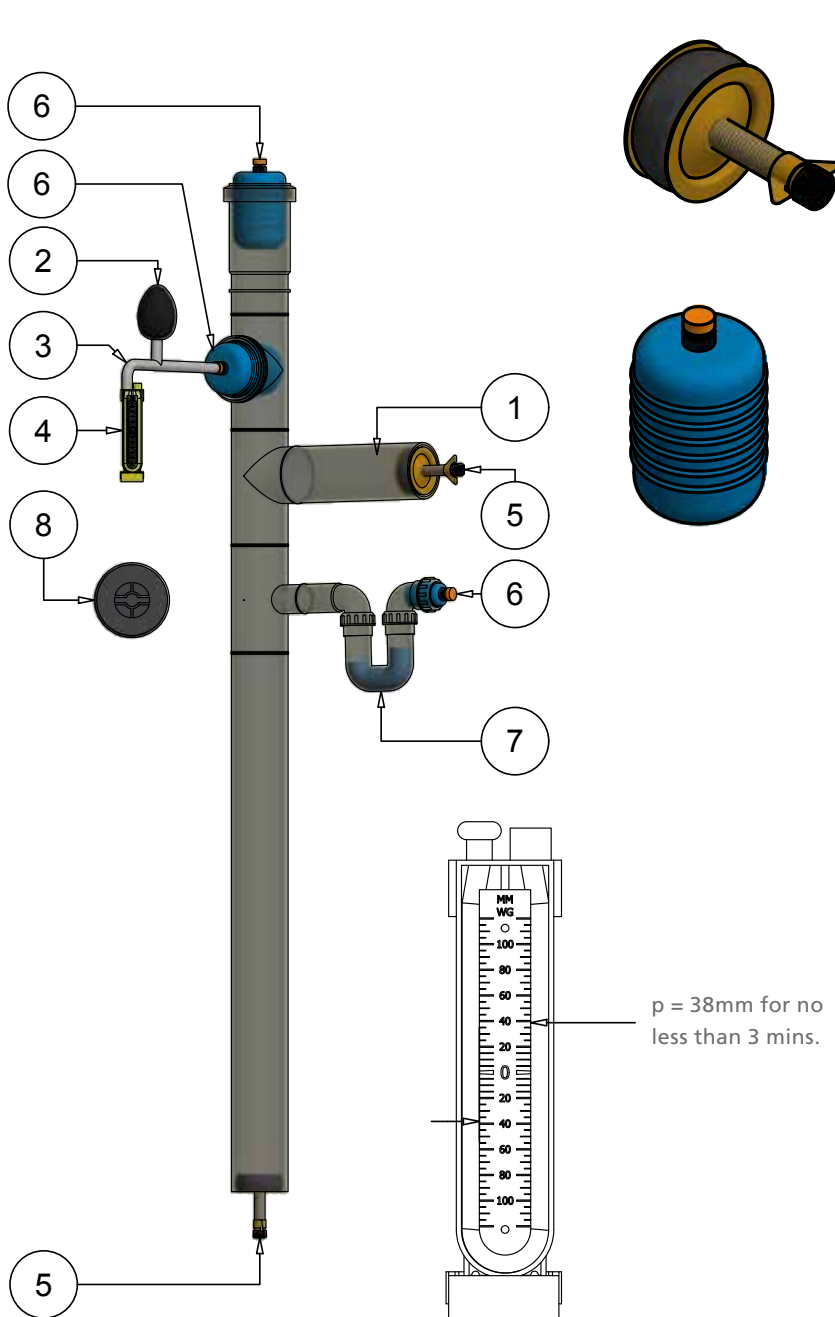

Screwed Test Plug

- Blank or open
- For use in pipe ends
- Manufactured and supplied by others

Air Bag

- Blank
- For use in access pipe/ expansion socket/pipe ends
- Manufactured and supplied by others

Traps must be filled with water to ensure there is positive pressure within the system to seal the waste inlet.

KEY	
NO.	PART
1	Pipework to test
2	Bellow
3	Hose
4	U-Gauge (should read 38mm)
5	Screwed Test Plug
6	Air Bag
7	Trap (must be filled with water)
8	Screwed End Cap (for access door)

Note: *For accurate readings, please ensure equipment is regularly checked.

Terrain FUZE pipes

HDPE pipes

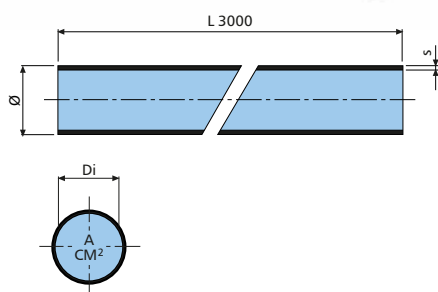

Ø	Di	S	A cm ²	PN	Kg/m	Code
HDPE SIPHONIC RAINWATER PIPE (5.8 METRE LENGTH)						
200	187.6	6.2	276.4	5	3.93	900.200.58H
250	234.4	7.8	431.5	5	5.98	900.250.58H
315	295.4	9.8	685.3	5	9.47	900.315.58H

Ø	Di	S	A cm ²	PN	Kg/m	Code
HDPE PIPE (5 METRE LENGTH)						
40	34	3	9	8	0.37	900.40.50B
50	44	3	15.2	6.4	0.46	900.50.50B
56	50	3	19.6	5.7	0.53	900.56.50B
63	57	3	25.4	5	0.595	900.63.50B
75	69	3	37.3	4.1	0.74	900.75.50B
90	83	3.5	54.1	4	0.98	900.90.50B
110	101.4	4.3	80.7	4	1.45	900.110.50B
125	115.2	4.9	104.5	4	1.86	900.125.50B
160	147.6	6.2	171.1	4	3.08	900.160.50B
200	187.6	6.2	276.4	3.2	4.1	900.200.50B
250	234.4	7.8	431.5	3.2	6.1	900.250.50B
315	295.4	9.8	685.3	3.2	9.51	900.315.50B

Ø	Di	S	A cm ²	PN	Kg/m	Code
HDPE PIPE (3 METRE LENGTH)						
40	34	3	9	8	0.370	900.40.30B
50	44	3	15.2	6.4	0.460	900.50.30B
56	50	3	19.6	5.7	0.530	900.56.30B
63	57	3	25.4	5	0.595	900.63.30B
75	69	3	37.3	4.1	0.740	900.75.30B
90	83	3.5	54.1	4	0.980	900.90.30B
110	101.4	4.3	80.7	4	1.450	900.110.30B
125	115.2	4.9	104.5	4	1.860	900.125.30B
160	147.6	6.2	171.1	4	3.080	900.160.30B

HDPE fittings

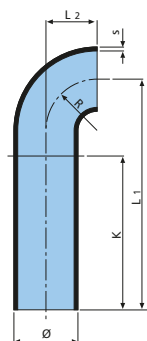

Ø	S	L ₁	L ₂	R	K	Kg	Code
HDPE 90° BEND							
40	3	150	30	30	120	0.070	907.40.90B
50	3	180	40	40	140	0.095	907.50.90B
56	3	210	40	40	170	0.120	907.56.90B
63	3	210	50	50	160	0.145	907.63.90B
75	3	210	70	70	140	0.180	907.75.90B
90	3.5	240	90	90	150	0.280	907.90.90B
110	4.3	270	100	100	170	0.490	907.110.90B
125	4.9	200	110	110	90	0.490	907.125.90B
160	6.2	140	140	140	-	0.690	907.160.90B

Terrain FUZE Fittings

HDPE fittings

Ø	S	L ₁	L ₂	R	K	Kg	Code
HDPE 90° WIDE RADIUS BEND							
200*	6.2	300	300	240	75	1.745	907.200.90B
250*	7.8	335	335	320	30	3.4	907.250.90B
315*	9.8	370	370	350	30	5.89	907.315.90B

* Segmented

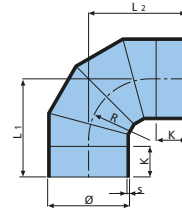

Ø	S	L	K	Kg	Code
HDPE 91.5° (88.5°) BEND					
40	3	50	20	0.035	901.40.92B
50	3	60	20	0.05	901.50.92B
56	3	65	20	0.06	901.56.92B
63	3	70	20	0.075	901.63.92B
75	3	75	20	0.095	901.75.92B
90	3.5	80	20	0.135	901.90.92B
110	4.3	95	25	0.23	901.110.92B
125	4.9	103	35	0.33	901.125.92B
160	6.2	123	35	0.7	901.160.92B

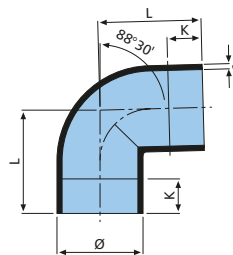

Ø	S	L	K	Kg	Code
HDPE 112.5° (67.5°) BEND					
110*	4.3	125	50	0.34	901.110.112B
160*	6.2	161	70	0.91	901.160.112B
200*	6.2	183	80	1.30	901.200.112B
250*	7.8	196	80	2.19	901.250.112B
315*	9.8	295	139	5.2	901.315.112B

* Segmented

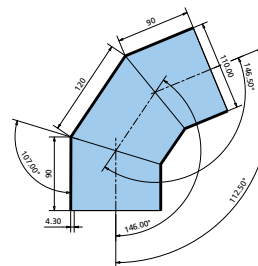

Ø/Ø ₁	S	L ₁	L ₂	L ₃	Kg	Code
HDPE 45° BEND WITH SOCKET BRANCH						
90/40	3.5	55	45	100	0.15	901.9040.135B
110/40	4.3	60	55	110	0.21	901.11040.135B
110/50	4.3	60	55	110	0.21	901.11050.135B

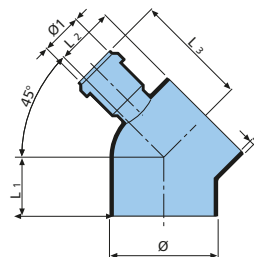

Ø	S	L ₁	K	Kg	Code
HDPE 45° BEND					
40	3	45	20	0.03	901.40.135B
50	3	45	20	0.04	901.50.135B
56	3	45	20	0.045	901.56.135B
63	3	50	20	0.06	901.63.135B
75	3	50	20	0.07	901.75.135B
90	3.5	55	20	0.11	901.90.135B
110	4.3	60	25	0.17	901.110.135B
125	4.9	65	25	0.245	901.125.135B
160	6.2	69	20	0.43	901.160.135B

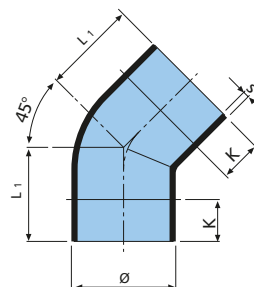

All dimensions in mm unless otherwise stated

Terrain FUZE Fittings

HDPE fittings

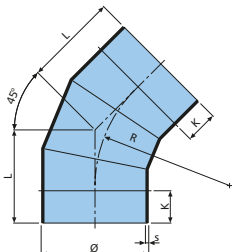

Ø	S	L	R	K	Kg	Code
HDPE 45° WIDE RADIUS BEND						
200*	6.2	180	420	75	1.33	901.200.135B
250*	7.8	185	430	30	2.15	901.250.135B
315*	9.8	185	440	30	3.4	901.315.135B

* Segmented

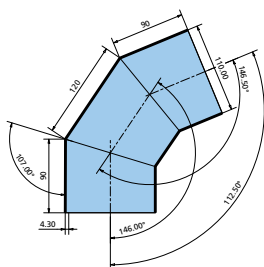

Ø	S	L	K	Kg	Code
HDPE 150° (30°) BEND					
110*	4.3	50	35	0.15	901.110.150B
160*	6.2	64	42	0.38	901.160.150B
200*	6.2	113	86	0.86	901.200.150B
250*	7.8	117	83	1.39	901.250.150B
315*	9.8	128	85	2.41	901.315.150B

* Segmented

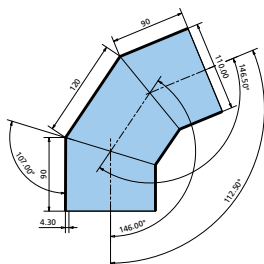

Ø	S	L	K	Kg	Code
HDPE 165° (15°) BEND					
110*	4.3	43	35	0.13	901.110.165B
160*	6.2	50	39	0.30	901.160.165B
200*	6.2	92	79	0.70	901.200.165B
250*	7.8	99	82	1.18	901.250.165B
315*	9.8	104	84	1.97	901.315.165B

* Segmented

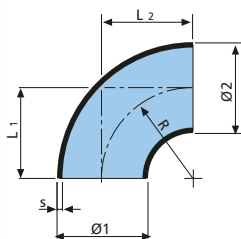

Ø ₁ /Ø ₂	S	L ₁	L ₂	R	Kg	Code
HDPE 90° REDUCING BEND						
50/40	3	40	40	40	0.025	901.5040.90B
63/50	3	50	50	50	0.045	901.6350.90B

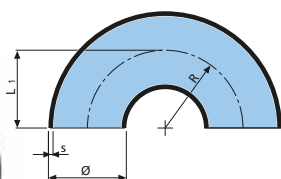

Ø	S	L ₁	R	Kg	Code
HDPE 180° BEND					
110	4.3	103	99	0.450	901.110.180
63	3.0	63	64	0.115	901.63.180
75	3.0	75	74	0.210	901.75.180
90	3.5	90	88	0.330	901.90.180

HDPE fittings

\emptyset/\emptyset_1	S/S ₁	L	L ₁	L ₂ /L ₃	K ₁	K ₂	K ₃	Kg	Code
HDPE 45° Y BRANCH									
40	3	135	45	90	25	30	30	0.07	904.40.135B
50	3	165	55	110	35	20	20	0.105	904.50.135B
56	3	180	60	120	40	25	25	0.13	904.56.135B
63	3	195	65	130	40	25	25	0.155	904.63.135B
75	3	210	70	140	40	25	25	0.205	904.75.135B
90	3.5	240	80	160	50	20	20	0.32	904.90.135B
110	4.3	270	90	180	55	20	20	0.53	904.110.135B
125	4.9	300	100	200	60	20	20	0.765	904.125.135B
160	6.2	375	125	250	75	25	25	1.475	904.160.135B
200*	6.2	540	180	360	85	10	10	2.99	904.200.135B
250*	7.8	660	220	440	115	55	55	5.8	904.250.135B
315*	9.8	840	280	560	160	95	95	11.1	904.315.135B

* Segmented

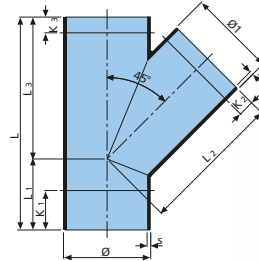

\emptyset/\emptyset_1	S/S ₁	L	L ₁	L ₂ /L ₃	K ₁	K ₂	K ₃	Kg	Code
HDPE 90° BRANCH									
40	3	130	75	55	45	20	20	0.06	904.40.90B
50	3	150	90	60	55	25	25	0.085	904.50.90B
56	3	175	105	70	65	30	30	0.105	904.56.90B
63	3	175	105	70	60	25	25	0.12	904.63.90B
75	3	175	105	70	55	25	25	0.145	904.75.90B
90	3.5	200	120	80	65	25	25	0.22	904.90.90B
110	4.3	225	135	90	65	20	20	0.365	904.110.90B
125	4.9	250	150	100	70	20	20	0.51	904.125.90B
160	6.2	350	210	140	105	30	30	1.19	904.160.90B
200*	6.2	360	180	180	25	30	25	1.705	904.200.90B
250*	7.8	440	220	220	40	40	40	3.1	904.250.90B
315*	9.8	560	280	280	70	65	70	6.15	904.315.90B

* Segmented

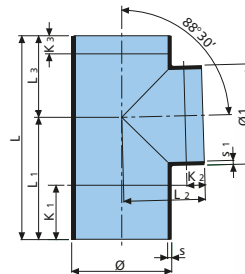

Terrain FUZE Fittings

HDPE fittings

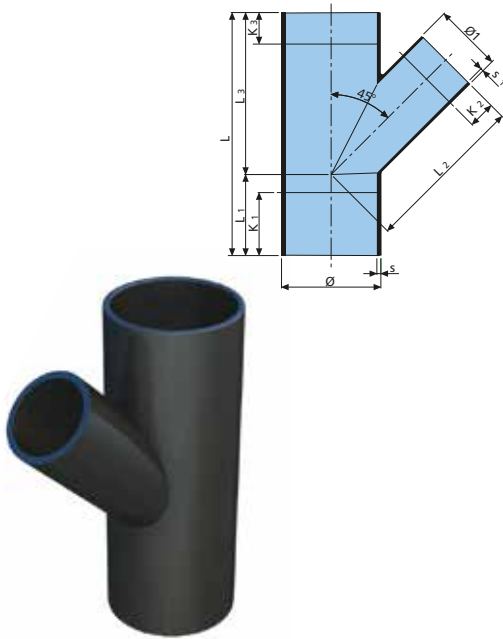

\emptyset/\emptyset_1	S	S ₁	L	L ₁	L ₂ /L ₃	K ₁	K ₂	K ₃	Kg	Code
HDPE REDUCING Y BRANCH 45°										
50/40	3	3	165	55	110	40	45	45	0.1	904.5040.135B
56/50	3	3	180	60	120	40	30	30	0.125	904.5650.135B
63/40	3	3	195	65	130	40	30	30	0.105	904.6340.135B
63/50	3	3	195	65	130	40	30	30	0.15	904.6350.135B
63/56	3	3	195	65	130	40	25	25	0.18	904.6356.135B
75/40	3	3	210	70	140	60	30	40	0.15	904.7540.135B
75/50	3	3	210	70	140	60	30	40	0.19	904.7550.135B
75/56	3	3	210	70	140	55	25	35	0.19	904.7556.135B
75/63	3	3	210	70	140	55	25	35	0.19	904.7563.135B
90/40	3.5	3	240	80	160	80	40	50	0.27	904.9040.135B
90/50	3.5	3	240	80	160	80	40	50	0.275	904.9050.135B
90/56	3.5	3	240	80	160	75	35	45	0.275	904.9056.135B
90/63	3.5	3	240	80	160	65	30	25	0.275	904.9063.135B
90/75	3.5	3	240	80	160	65	30	25	0.3	904.9075.135B
110/40	4.3	3	270	90	180	95	50	55	0.45	904.11040.135B
110/50	4.3	3	270	90	180	95	50	55	0.44	904.11050.135B
110/56	4.3	3	270	90	180	90	40	45	0.455	904.11056.135B
110/63	4.3	3	270	90	180	80	35	40	0.455	904.11063.135B
110/75	4.3	3	270	90	180	75	30	35	0.47	904.11075.135B
110/90	4.3	3.5	270	90	180	65	25	30	0.485	904.11090.135B
125/40	4.9	3	300	100	200	95	45	50	0.61	904.12540.135B
125/50	4.9	3	300	100	200	95	45	50	0.63	904.12550.135B
125/56	4.9	3	300	100	200	95	45	50	0.63	904.12556.135B
125/63	4.9	3	300	100	200	95	40	50	0.585	904.12563.135B
125/75	4.9	3	300	100	200	95	40	50	0.63	904.12575.135B
125/90	4.9	3.5	300	100	200	80	35	30	0.65	904.12590.135B
125/110	4.9	4.3	300	100	200	70	25	25	0.7	904.125110.135B
165/75	6.2	3	375	125	250	130	80	100	1.223	904.16075.135B
165/90	6.2	3.5	375	125	250	120	70	90	1.272	904.16090.135B
160/110	6.2	4.3	375	125	250	110	45	55	1.25	904.160110.135B
160/125	6.2	4.9	375	125	250	100	40	50	1.3	904.160125.135B
* 200/75	6.2	3	540	180	360	210	160	181	2.246	904.20075.135B
* 200/90	6.2	3.5	540	180	360	200	155	175	2.328	904.20090.135B
* 200/110	6.2	4.3	540	180	360	150	140	65	2.4	904.200110.135B
* 200/125	6.2	4.9	540	180	360	140	130	55	2.5	904.200125.135B
* 200/160	6.2	6.2	540	180	360	115	85	35	2.7	904.200160.135B
* 250/110	7.8	4.3	660	220	440	215	185	150	4.4	904.250110.135B
* 250/125	7.8	4.9	660	220	440	205	175	140	4.75	904.250125.135B
* 250/160	7.8	6.2	660	220	440	180	130	50	4.85	904.250160.135B
* 250/200	7.8	6.2	660	220	440	150	50	90	5	904.250200.135B
* 315/110	9.8	4.3	840	280	560	305	260	235	8.6	904.315110.135B
* 315/125	9.8	4.9	840	280	560	290	250	220	9.15	904.315125.135B
* 315/160	9.8	6.2	840	280	560	270	205	200	9.15	904.315160.135B
* 315/200	9.8	6.2	840	280	560	240	125	175	9.45	904.315200.135B
* 315/250	9.8	7.8	840	280	560	205	130	140	9.25	904.315250.135B

* Welded

HDPE fittings

$\varnothing/\varnothing_1$	S/S ₁	L	L ₁	L ₂	L ₃	K ₁	K ₂	K ₃	Kg	Code
HDPE SWEEPED BRANCH FITTING										
110/110	4.3	230	140	120	90	90	40	20	0.415	904.110.92B

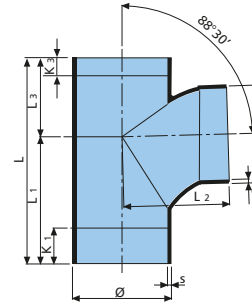

$\varnothing/\varnothing_1$	S	S ₁	L	L ₁	L ₂ /L ₃	K ₁	K ₂	K ₃	Kg	Code
HDPE 45° DOUBLE REDUCING BRANCH										
110/40	4.3	3	270	90	180	95	30	15	0.435	906.11040.135B
110/50	4.3	3	270	90	180	95	30	15	0.455	906.11050.135B
110/110	4.3	4.3	270	90	180	50	15	15	0.63	906.110.135B

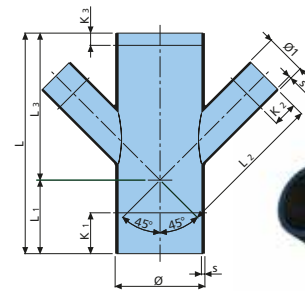

$\varnothing/\varnothing_1$	S	S ₁	L ₁	L ₂	K ₁	K ₂	Kg	Code
HDPE DOUBLE Y BRANCH 60°								
50/40	3	3	55	110	40	50	0.093	906.5040.60B
63/50	3	3	65	130	50	40	0.141	906.6350.60B
110/110	4.3	4.3	90	120	50	-	0.393	906.110.60B

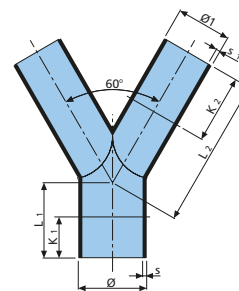

Terrain FUZE Fittings

HDPE fittings

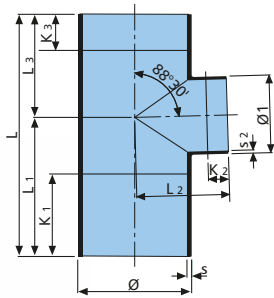

Ø1/Ø1	S	S ₂	L	L ₁	L ₂ /L ₃	K ₁	K ₂	K ₃	Kg	Code
HDPE REDUCING BRANCH 90°										
50/40	3	3	150	90	60	60	25	30	0.08	904.5040.90B
56/50	3	3	175	105	70	70	30	35	0.105	904.5650.90B
63/40	3	3	175	105	70	70	30	35	0.115	904.6340.90B
63/50	3	3	175	105	70	70	30	35	0.125	904.6350.90B
63/56	3	3	175	105	70	60	30	30	0.125	904.6356.90
75/40	3	3	175	105	70	75	25	35	0.14	904.7540.90B
75/50	3	3	175	105	70	70	25	35	0.14	904.7550.90B
75/56	3	3	175	105	70	65	25	30	0.14	904.7556.90B
75/63	3	3	175	105	70	60	25	25	0.145	904.7563.90B
90/40	3.5	3	200	120	80	85	25	45	0.205	904.9040.90B
90/50	3.5	3	200	120	80	85	25	45	0.41	904.9050.90B
90/56	3.5	3	200	120	80	85	25	35	0.41	904.9056.90B
90/63	3.5	3	200	120	80	75	25	35	0.41	904.9063.90B
90/75	3.5	3	200	120	80	70	25	30	0.43	904.9075.90B
110/40	4.3	3	225	135	90	100	25	60	0.345	904.11040.90B
110/50	4.3	3	225	135	90	95	25	50	0.345	904.11050.90B
110/56	4.3	3	225	135	90	90	25	45	0.345	904.11056.90B
110/63	4.3	3	225	135	90	95	25	35	0.34	904.11063.90B
110/75	4.3	3	225	135	90	85	25	35	0.345	904.11075.90B
110/90	4.3	3.5	225	135	90	75	25	30	0.36	904.11090.90B
125/110	4.9	4.3	250	150	100	80	20	30	0.49	904.125110.90B
160/110	6.2	4.3	350	210	140	135	45	60	1.12	904.160110.90B
160/125	6.2	4.9	350	210	140	125	45	50	1.145	904.160125.90B
* 200/110	6.2	4.3	360	180	180	70	60	70	1.51	904.200110.90B
* 200/125	6.2	4.9	360	180	180	65	60	65	1.46	904.200125.90B
* 200/160	6.2	6.2	360	180	180	45	50	45	1.6	904.200160.90B
* 250/110	7.8	4.3	440	220	220	110	75	110	2.715	904.250110.90B
* 250/125	7.8	4.9	440	220	220	105	75	105	2.42	904.250125.90B
* 250/160	7.8	6.2	440	220	220	85	65	85	2.8	904.250160.90B
* 250/200	7.8	6.2	440	220	220	65	60	65	2.82	904.250200.90B
* 315/110	9.8	4.3	560	280	280	170	100	170	5.315	904.315110.90B
* 315/125	9.8	4.9	560	280	280	165	100	165	5.42	904.315125.90B
* 315/160	9.8	6.2	560	280	280	145	90	145	5.37	904.315160.90B
* 315/200	9.8	6.2	560	280	280	120	65	120	5.57	904.315200.90B
* 315/250	9.8	7.8	560	280	280	95	65	95	5.62	904.315250.90B

* Welded

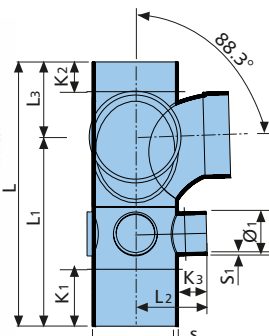

Ø1/Ø1	S	S ₁	L	L ₁	L ₂	L ₃	K ₁	K ₂	K ₃	Kg	Code
HDPE 88° CORNER BOSS BRANCH											
110/56	4.3	3.0	338	240	90	97	73	37	27	0.71	906.11090.12B

HDPE fittings

Ø	S	L	L ₁	L ₂	L ₃	K ₁	K ₂	Kg	Code
HDPE 88° CORNER BRANCH									
110	4.4	231	134	120	97	43	37	0.479	906.11090.92B

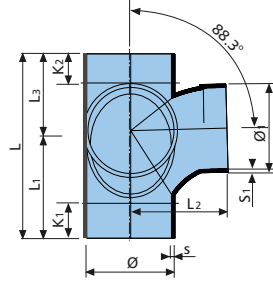

Ø	S	L	L ₁	L ₂	L ₃	K ₁	K ₂	Kg	Code
HDPE 88° 3 WAY CORNER BRANCH									
110	4.4	231	134	120	97	43	37	0.579	906.11093.92B

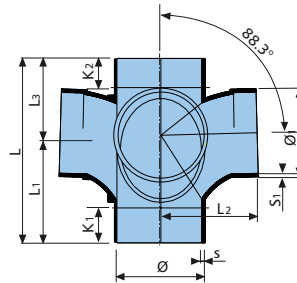

Ø/Ø ₁	S	S ₁	L	L ₁	L ₂	L ₃	K ₁	K ₂	K ₃	Kg	Code
HDPE 4 WAY BRANCH											
110/56	4.3	3	257	177	90	79	133	37	37	0.483	920.110.56B
160/56	6.2	3	146	73	120	73	15	15	15	0.699	920.160.56B

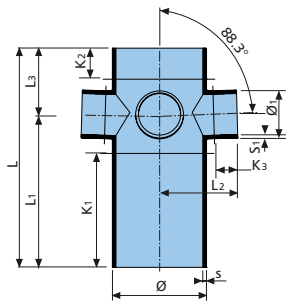

Ø/Ø ₁	S	S ₁	L	L ₁	L ₂	L ₃	K ₁	K ₂	K ₃	Kg	Code
HDPE 88° SINGLE BOSS BRANCH											
110/56	4.3	3	338	240	90	97	73	37	27	0.575	904.11090.12B

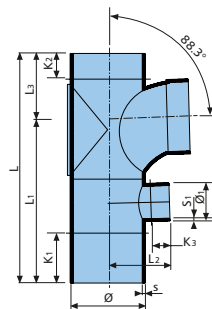

Ø/Ø ₁	S	L	L ₁	L ₂	L ₃	K ₁	K ₂	Kg	Code
HDPE 88° DOUBLE BRANCH									
110/110	4.3	231	134	120	97	43	37	0.553	906.110.92B

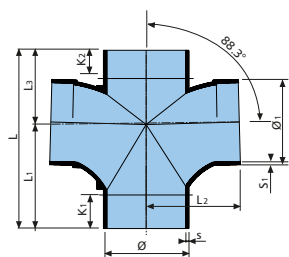

Terrain FUZE Fittings

HDPE fittings

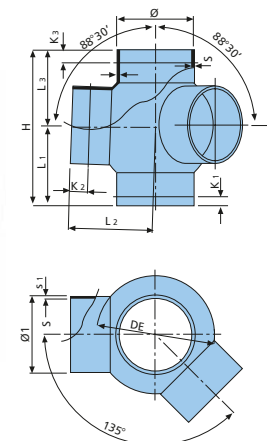
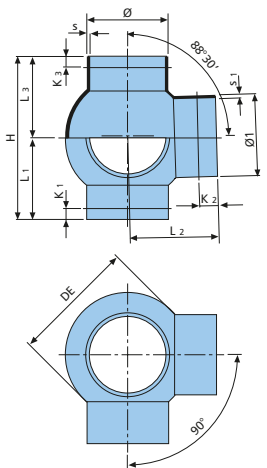
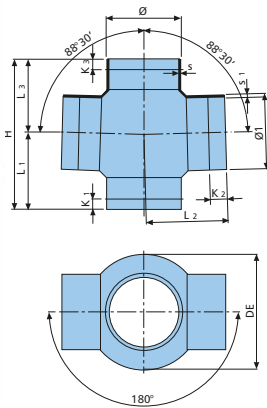

$\varnothing/\varnothing_1$	S	S ₁	H	DE	L ₁ /L ₃	L ₂	K ₁ /K ₃	K ₂	Kg	Code
HDPE 180° DOUBLE BRANCH BALL FITTING										
110/50	4.3	3	220	170	105	120	15	15	0.44	916.11050.180B
110/56	4.3	3	220	170	105	120	15	15	0.45	916.11056.180B
110/75	4.3	3	220	170	105	120	15	15	0.43	916.11075.180B
110/90	4.3	3.5	220	170	105	120	15	15	0.47	916.11090.180B
110/110	4.3	4.3	220	170	105	120	15	15	0.48	916.110.180B
125/50	4.9	3	220	190	110	125	15	15	0.495	916.12550.180B
125/56	4.9	3	220	190	110	125	15	15	0.5	916.12556.180B
125/75	4.9	3	220	190	110	125	15	15	0.555	916.12575.180B
125/90	4.9	3.5	220	190	110	125	15	15	0.555	916.12590.180B
125/110	4.9	4.3	220	190	110	125	15	25	0.565	916.125110.180B
125/125	4.9	4.9	220	190	110	125	15	25	0.625	916.125.180B

$\varnothing/\varnothing_1$	S	S ₁	H	DE	L ₁ /L ₃	L ₂	K ₁ /K ₃	K ₂	Kg	Code
HDPE 90° DOUBLE BRANCH BALL FITTING										
110/50	4.3	3	220	170	105	120	15	15	0.45	916.11050.90B
110/56	4.3	3	220	170	105	120	15	15	0.425	916.11056.90B
110/75	4.3	3	220	170	105	120	15	15	0.5	916.11075.90B
110/90	4.3	3.5	220	170	105	120	15	15	0.465	916.11090.90B
110/110	4.3	4.3	220	170	105	120	15	15	0.505	916.110.90B
125/50	4.9	3	220	190	110	125	15	15	0.5	916.12550.90B
125/56	4.9	3	220	190	110	125	15	15	0.5	916.12556.90B
125/75	4.9	3	220	190	110	125	15	15	0.53	916.12575.90B
125/90	4.9	3.5	220	190	110	125	15	15	0.54	916.12590.90B
125/110	4.9	4.3	220	190	110	125	15	25	0.605	916.125110.90B
125/125	4.9	4.9	220	190	110	125	15	25	0.62	916.125.90B

$\varnothing/\varnothing_1$	S	S ₁	H	DE	L ₁ /L ₃	L ₂	K ₁ /K ₃	K ₂	Kg	Code
HDPE 135° DOUBLE BRANCH BALL FITTING										
110/50	4.3	3	220	170	105	120	15	15	0.44	916.11050.135B
110/56	4.3	3	220	170	105	120	15	15	0.445	916.11056.135B
110/75	4.3	3	220	170	105	120	15	15	0.455	916.11075.135B
110/90	4.3	3.5	220	170	105	120	15	15	0.47	916.11090.135B
110/110	4.3	4.3	220	170	105	120	15	25	0.5	916.110.135B
125/50	4.9	3	220	190	110	125	15	15	0.49	916.12550.135B
125/56	4.9	3	220	190	110	125	15	15	0.555	916.12556.135B
125/75	4.9	3	220	190	110	125	15	15	0.565	916.12575.135B
125/90	4.9	3.5	220	190	110	125	15	15	0.575	916.12590.135B
125/110	4.9	4.3	220	190	110	125	15	25	0.6	916.125110.135B
125/125	4.9	4.9	220	190	110	125	15	25	0.74	916.125.135B

HDPE fittings

\emptyset/\emptyset_1	S	S ₁	H	DE	L ₁ /L ₃	L ₂	K ₁ /K ₃	K ₂	Kg	Code
HDPE 90° MULTI BRANCH BALL FITTING										
110/50	4.3	3	220	170	105	120	15	15	0.32	916.11050.903B
110/56	4.3	3	220	170	105	120	15	15	0.47	916.11056.903B
110/75	4.3	3	220	170	105	120	15	15	0.46	916.11075.903B
110/90	4.3	3.5	220	170	105	120	15	15	0.51	916.11090.903B
110/110	4.3	4.3	220	170	105	120	15	15	0.545	916.110.903B
125/50	4.9	3	220	190	110	125	15	15	0.57	916.12550.903B
125/56	4.9	3	220	190	110	125	15	15	0.515	916.12556.903B
125/75	4.9	3	220	190	110	125	15	15	0.515	916.12575.903B
125/90	4.9	3.5	220	190	110	125	15	15	0.525	916.12590.903B
125/110	4.9	4.3	220	190	110	125	15	25	0.595	916.125110.903B
125/125	4.9	4.9	220	190	110	125	15	25	0.67	916.125.903B

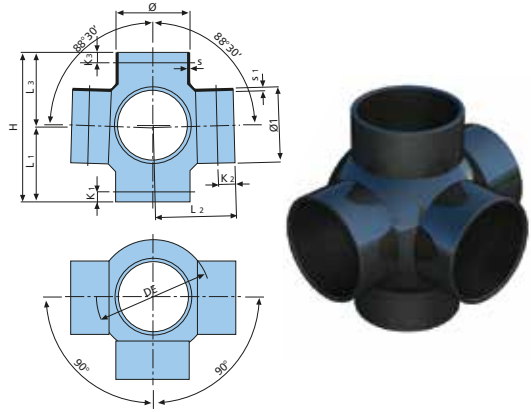

\emptyset/\emptyset_1	S	S ₁	H	DE	L ₁ /L ₃	L ₂	K ₁ /K ₃	K ₂	Kg	Code
HDPE 135° MULTI BRANCH BALL FITTING										
110/50	4.3	3	220	170	105	120	15	15	0.465	916.11050.1353B
110/56	4.3	3	220	170	105	120	15	15	0.455	916.11056.1353B
110/75	4.3	3	220	170	105	120	15	15	0.44	916.11075.1353B
110/90	4.3	3.5	220	170	105	120	15	15	0.45	916.11090.1353B
110/110	4.3	4.3	220	170	105	120	15	15	0.54	916.110.1353B
125/50	4.9	3	220	190	110	125	15	15	0.63	916.12550.1353B
125/56	4.9	3	220	190	110	125	15	15	0.515	916.12556.1353B
125/75	4.9	3	220	190	110	125	15	15	0.62	916.12575.1353B
125/90	4.9	3.5	220	190	110	125	15	15	0.63	916.12590.1353B
125/110	4.9	4.3	220	190	110	125	15	25	0.62	916.125110.1353B
125/125	4.9	4.9	220	190	110	125	15	25	0.67	916.125.1353B

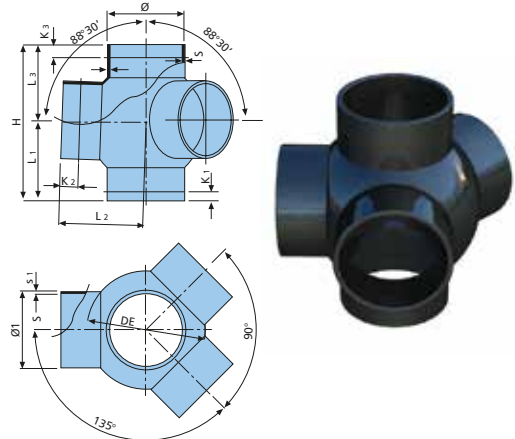

\emptyset/\emptyset_1	S	S ₁	H	DE	L ₁ /L ₃	L ₂	K ₁ /K ₃	K ₂	Kg	Code
HDPE MULTI BRANCH BALL FITTING										
110/50	4.3	3	220	170	105	120	15	15	0.48	916.11050.904B
110/56	4.3	3	220	170	105	120	15	15	0.48	916.11056.904B
110/75	4.3	3	220	170	105	120	15	15	0.475	916.11075.904B
110/90	4.3	3.5	220	170	105	120	15	15	0.535	916.11090.904B
110/110	4.3	4.3	220	170	105	120	15	15	0.575	916.110.904B
125/50	4.9	3	220	190	105	125	15	15	0.53	916.12550.904B
125/56	4.9	3	220	190	105	125	15	15	0.485	916.12556.904B
125/75	4.9	3	220	190	105	125	15	15	0.425	916.12575.904B
125/90	4.9	3.5	220	190	105	125	15	15	0.68	916.12590.904B
125/110	4.9	4.3	220	190	105	125	15	25	0.69	916.125110.904B
125/125	4.9	4.3	220	190	105	125	15	25	0.74	916.125.904B

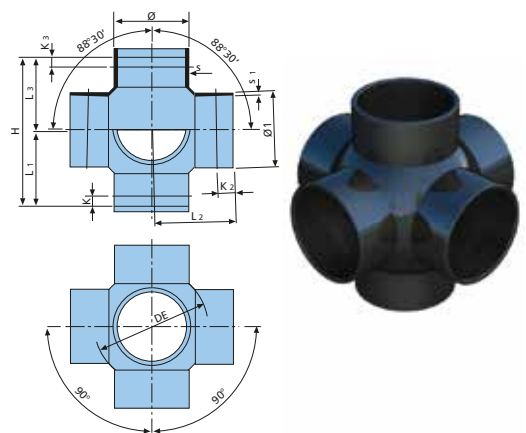

Terrain FUZE Fittings

HDPE fittings

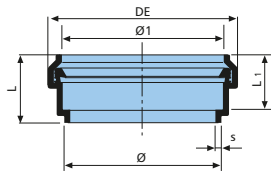

\emptyset/\emptyset_1	S	DE	L	L ₁	Kg/m	Code
HDPE SHORT RING SEAL ADAPTOR WITH CAP						
90	3.5	108	42	31.5	0.07	909.90B
110	4.3	130	42	31.5	0.115	909.110B

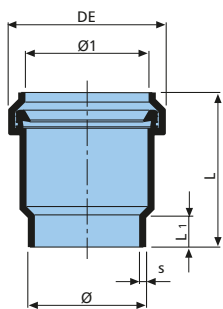

\emptyset/\emptyset_1	S	DE	L	L ₁	Kg	Code
HDPE RING SEAL ADAPTOR WITH CAP						
40	3	56.5	65	13	0.04	927.40B
50	3	66.5	65	13	0.05	927.50B
56	3	72.5	65	13	0.05	927.56B
63	3	79	65	11	0.065	927.63B
75	3	92	90	17	0.11	927.75B
90	3.5	108	90	17	0.15	927.90B
110	4.3	130	95	17	0.22	927.110B
125	4.9	149	95	15	0.23	927.125B
160	6.2	188	130	30	0.53	927.160B
200	6.2	225	170	18	1.075	927.200B
○ 250	7.8	278	170	22	1.37	927.250B
○ 315	9.8	350	180	22	1.97	927.315B

○ Without cap

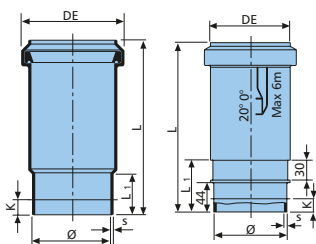

\emptyset	S	DE	L	L ₁	K	Kg	Code
HDPE EXPANSION JOINT WITH CAP							
40	3	73	235	60	40	0.16	911.40B
50	3	81	235	56	40	0.2	911.50B
56	3	90	235	50	40	0.22	911.56B
63	3	96	235	56	40	0.25	911.63B
75	3	109	235	56	40	0.3	911.75B
90	3.5	117	235	54	40	0.335	911.90B
* 110	4.3	140	255	46	20	0.5	911.110B
125	4.9	154	235	53	40	0.625	911.125B
160	6.2	192	260	72	40	1.01	911.160B
200	6.2	228	350	80	40	1.85	911.200B
○ 250	7.8	280	440	183	100	3.38	911.250B
○ 315	9.8	350	480	183	100	6.1	911.315B

○ Without cap * For rigid support

HDPE fittings

$\varnothing/\varnothing_1$	S	DE	L	L_1	Kg	Code
HDPE - PVC RING SEAL ADAPTOR						
40 x 36	3	49	92	35	0.05	927.4036B
50 x 36	3	49	92	35	0.06	927.5036B
50 x 43	3	56	92	35	0.06	927.5043B
56 x 36	3	49	92	35	0.06	927.5636B
56 x 43	3	56	92	35	0.06	927.5643B

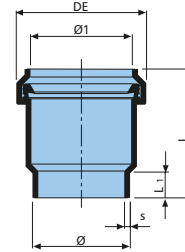

$\varnothing/\varnothing_1$	S	DE	L	L_1	L_2	Kg	Code
HDPE SPIGOT BEND WITH CAP							
40/46	3	52	60	51	22	0.055	917.4046.90B
50/46	3	52	62	51	22	0.06	917.5046.90B
* 50/58	3	64	68	55	24	0.07	917.5058.90B
56/46	3	52	64	60	22	0.07	917.5646.90B
* 56/58	3	64	65	60	22	0.075	917.5658.90B

* with protective plug for socket

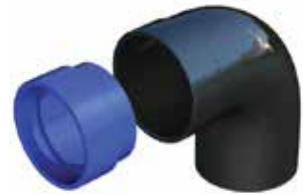
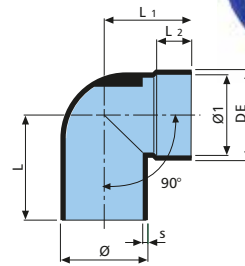

\varnothing	S	DE	L	L_1	Kg	Code
HDPE EXTENDED SPIGOT BEND						
56	3	50	100	80	0.085	902.56.90B

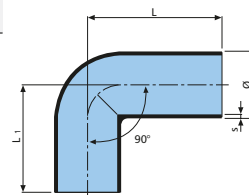

\varnothing	S	DE	L	L_1	Kg	Code
HDPE SLEEVE						
40/46	3	52	30	20	0.015	917.4046B
50/46	3	52	30	20	0.015	917.5046B
* 50/58	3	64	38	20	0.02	917.5058B
56/46	3	52	38	20	0.02	917.5646B
* 56/58	3	64	38	20	0.025	917.5658B

* with protective plug for socket

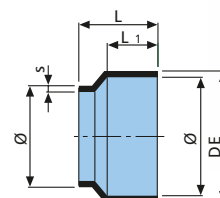

Terrain FUZE Fittings

HDPE fittings

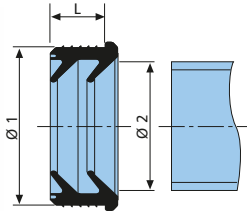

Ø 1	Ø 2	L	Kg	Code
GASKET				
46	36-40	22	0.01	917.4636.908B
58	36-40	22	0.2	917.5836.908B
58	47-50	22	0.3	917.5847.908B

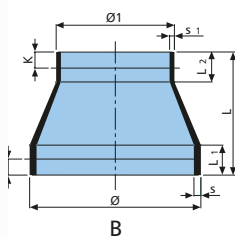
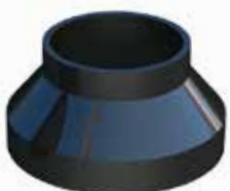
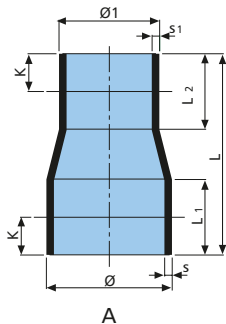

Ø1 Ø ₁	S	S ₁	L	L ₁	L ₂	K	Kg	Code
HDPE CONCENTRIC REDUCERS								
50/40	3	3	80	30	30	15	0.04	924.5040B
56/50	3	3	80	30	30	15	0.04	924.5650B
63/40	3	3	80	30	30	15	0.04	924.6340B
63/50	3	3	80	30	30	15	0.05	924.6350B
63/56	3	3	80	30	30	15	0.045	924.6356B
75/40	3	3	80	30	30	15	0.045	924.7540B
75/50	3	3	80	30	30	15	0.05	924.7550B
75/56	3	3	80	30	30	15	0.06	924.7556B
75/63	3	3	80	30	30	15	0.06	924.7563B
90/40	3.5	3	80	30	30	15	0.085	924.9040B
90/50	3.5	3	80	30	30	15	0.065	924.9050B
90/56	3.5	3	80	30	30	15	0.07	924.9056B
90/63	3.5	3	80	30	30	15	0.09	924.9063B
90/75	3.5	3	80	30	30	15	0.095	924.9075B
110/40	4.3	3	80	30	30	15	0.09	924.11040B
110/50	4.3	3	80	30	30	15	0.115	924.11050B
110/56	4.3	3	80	30	30	15	0.095	924.11056B
110/63	4.3	3	80	30	30	15	0.105	924.11063B
110/75	4.3	3	80	30	30	15	0.125	924.11075B
110/90	4.3	3.5	80	30	30	15	0.125	924.11090B
125/110	4.9	4.3	80	30	40	20	0.325	924.125110B
125/50	4.9	3	80	30	30	15	0.125	924.12550B
125/56	4.9	3	80	30	30	15	0.125	924.12556B
125/63	4.9	3	80	30	30	15	0.125	924.12563B
125/75	4.9	3	80	30	30	15	0.135	924.12575B
125/90	4.9	3.5	80	30	30	15	0.255	924.12590B
160/110	6.2	4.3	115	30	30	15	0.255	924.160110B
200/160	9.2	6.2	180	60	60	20	0.325	924.200160B

▼ A B ●

HDPE fittings

\emptyset/\emptyset_1	S	L	L ₁	L ₂	L ₃	DE	Kg	Code
HDPE THREADED COUPLING								
40	3	74	30	34	66	60	0.075	912.40B
50	3	76	30	33	66	70	0.08	912.50B
56	3	46	30	34	66	80	0.12	912.56B
56/63	3	48	-	34	66	80	0.1	912.5663B
63	3	79	30	43	66	85	0.13	912.63B
75	3	106	30	45	87	109	0.25	912.75B
90	3.5	86	30	46	88	128	0.34	912.90B
110	4.3	113	30	65	89	144	0.47	912.110B

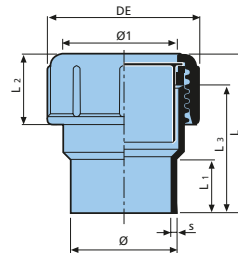

\emptyset	S	Kg	Code
HDPE RING			
50	3	0.0015	9118.50B
56	4	0.002	9118.56B
63	4	0.002	9118.63B
75	4	0.004	9118.75B
90	3	0.002	9118.90B
110	4	0.006	9118.110B

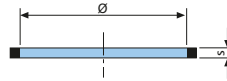

\emptyset	S	Kg	Code
HDPE RING SEAL			
50	6	0.004	9119.50B
56	6	0.005	9119.56B
63	7	0.006	9119.63B
75	10	0.02	9119.75B
90	7	0.01	9119.90B
110	10	0.025	9119.110B

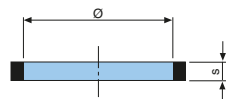

\emptyset_1	RG	DE	L ₂	Kg	Code
HDPE NUT					
50	62	70	33	0.03	9120.50B
56	71	80	34	0.05	9120.56B
63	76	85	43	0.06	9120.63B
75	96	109	45	0.1	9120.75B
110	132	144	65	0.21	9120.110B

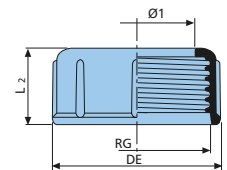

Terrain FUZE Fittings

HDPE fittings

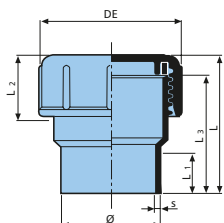

Ø	S	L	L ₁	L ₂	L ₃	DE	Kg	Code
HDPE SCREWED END CAP								
40	3	75	30	34	66	60	0.075	936.40B
50	3	75	30	33	66	70	0.08	936.50B
56	3	77	30	34	66	80	0.12	936.56B
63	3	76	30	43	66	85	0.135	936.63B
75	3	103	30	45	87	109	0.28	936.75B
90	3.5	103	30	46	88	128	0.355	936.90B
110	4.3	106	30	65	89	144	0.5	936.110B

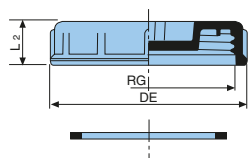
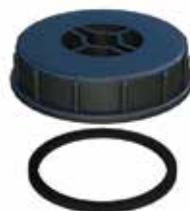

Ø	RG	DE	L ₂	Kg	Code
HDPE SHORT END CAP WITH SEAL					
110	132	149	33	0.215	9938.110B

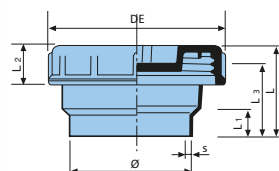
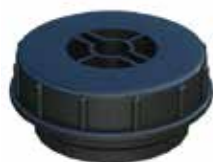

Ø	S	L	L ₁	L ₂	L ₃	DE	Kg	Code
HDPE SHORT SCREWED CAP								
110	4.3	63	12	33	50	149	0.315	935.110B

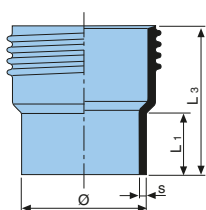

Ø	S	L ₁	L ₃	Kg	Code
HDPE THREADED UNION					
50	3	30	66	0.03	9122.50B
56	3	30	66	0.025	9122.56B
63	3	30	66	0.04	9122.63B
75	3	30	87	0.095	9122.75B
90	3.5	30	88	0.085	9122.90B
110	4.3	30	89	0.17	9122.110B

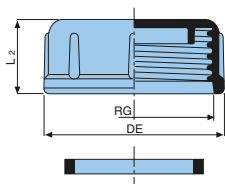

Ø	RG	DE	L ₂	Kg	Code
HDPE END CAP WITH SEAL					
50	63	70	33	0.035	9121.50B
56	71	80	34	0.075	9121.56B
63	77	85	43	0.085	9121.63B
75	97	109	45	0.16	9121.75B
90	113	128	46	0.215	9121.90B
110	132	144	65	0.3	9121.110B

HDPE fittings

Ø	S	L	Kg	Code
HDPE BLANK END				
40	3	10	0.01	930.40B
50	3	10	0.01	930.50B
56	3	10	0.01	930.56B
63	3	10	0.015	930.63B
75	3	10	0.02	930.75B
90	3.5	10	0.03	930.90B
110	4.3	10	0.05	930.110B
125	4.9	10	0.07	930.125B

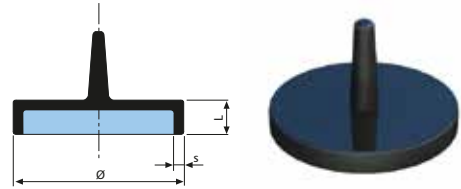

Ø	S	L	Kg	Code
HDPE END CAP				
160	6.2	72	0.31	930.160B
200	6.2	110	0.56	930.200B
250	7.8	93	0.75	930.250B
315	9.2	117	1.42	930.315B

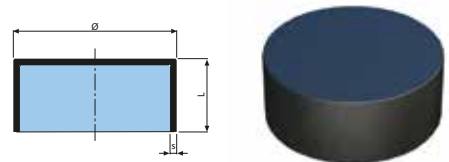

Ø	S	S ₁	DE	L	L ₁	Kg	Code
HDPE ANCHOR PIPE							
50	3	4	57	68	32	0.03	970.50B
56	3	4	64	68	32	0.035	970.56B
63	3	4	71	72	34	0.045	970.63B
75	3	5	84	83	39.5	0.06	970.75B
90	3.5	5	100	100	47.5	0.1	970.90B
110	4.3	6	120	112	53.5	0.165	970.110B

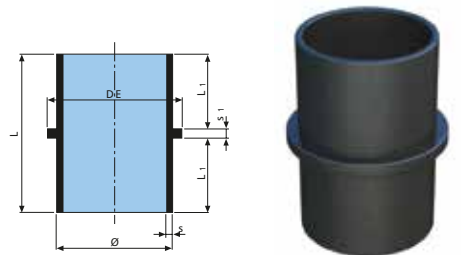

M/Ø	L	For Flange	Kg	Code
HDPE GALVANISED BOLT SET WITH WASHER FOR FLANGE				
16	90	50-56	0.215	984.1650B
16	100	63-75	0.23	984.1663B
16	100	90	0.23	984.1690B
16	100	110-125-140	0.25	984.16110B
20	110	160	0.41	984.20160B
20	130	200-250-315	0.45	984.20250B

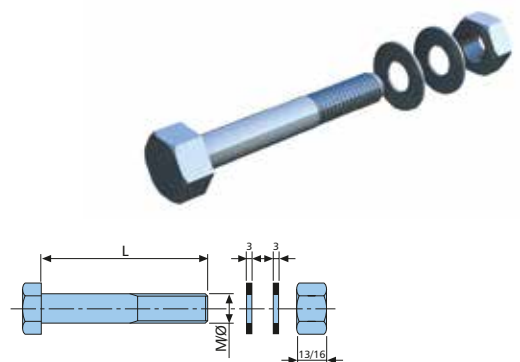

Terrain FUZE Fittings

HDPE fittings

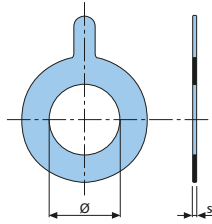

Ø	S	Kg	Code
FLAT RUBBER SEAL FOR FLANGE			
50	3	0.02	982.50B
56	3	0.02	982.56B
63	3	0.02	982.63B
75	3	0.03	982.75B
90	3	0.04	982.90B
110	3	0.045	982.110B
125	3	0.035	982.125B
160	3	0.07	982.160B
200	3	0.11	982.200B
250	3	0.14	982.250B
315	3	0.14	982.315B

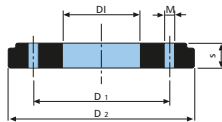

Ø	S	DI	D ₁	D ₂	M	Hole No	Kg	Code
PAINTED ALUMINIUM BACKING FLANGE								
50	20	62	120	150	18	4	0.625	981.50B
56	20	64	123	159	18	4	0.71	981.56B
63	17	78	128	165	18	4	0.65	981.63B
75	21	93	148	185	18	4	0.885	981.75B
90	22	108	160	200	17	8	1.005	981.90B
110	22	128	182	220	19	8	1.05	981.110B
125	22	136	176	220	18	8	1.15	981.125B
160	25	179	240	285	22	8	1.84	981.160B
200	26	235	295	337	22	8	2.325	981.200B
250	30	285	350	396	22	12	3.78	981.250B
315	30	340	400	444	22	12	3.945	981.315B

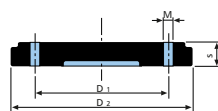

Ø	S	D ₁	D ₂	M	Hole No	Kg	Code
PAINTED ALUMINIUM BLANK FLANGE							
50	20	120	150	18	4	0.76	983.50B
56	20	123	159	18	4	0.865	983.56B
63	17	128	165	18	4	1.02	983.63B
75	21	148	185	18	4	1.305	983.75B
90	22	162	200	17	8	1.525	983.90B
110	22	176	220	18	8	1.7	983.110B
125	22	182	280	19	8	1.8	983.125B
160	25	240	285	22	8	2.945	983.160B
200	26	295	337	22	8	4.485	983.200B
250	30	350	396	22	12	7.495	983.250B
315	30	400	444	22	12	9.345	983.315B

HDPE fittings

Ø	S	D ₁	D ₂	L	L ₁	Kg	Code
HDPE FLANGE ADAPTORS							
50	3	88	61	52	12	0.075	980.50B
56	3	94	72	90	12	0.115	980.56B
63	3	102	75	90	15	0.125	980.63B
75	3	122	89	90	15	0.185	980.75B
90	3.5	138	106	90	15	0.215	980.90B
110	4.3	158	120	100	18	0.335	980.110B
125	4.9	158	128	100	18	0.34	980.125B
160	6.2	212	175	100	18	0.585	980.160B
200	6.2	268	232	100	20	0.92	980.200B
250	7.8	320	285	100	20	1.48	980.250B
315	9.8	370	236	100	20	1.72	980.315B

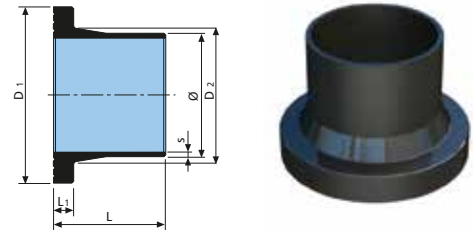

Ø	S	L	L ₁	L ₂	H	DE	K ₁	K ₂	Kg	Code
HDPE 90° ACCESS PIPE WITH SCREW CAP										
40	3	130	75	55	69	54	45	20	0.085	938.40.90
50	3	150	90	60	75	70	55	25	0.13	938.50.90B
56	3	175	105	70	84	85	65	30	0.195	938.56.90B
63	3	175	100	75	80	82	60	25	0.175	938.63.90B
75	3	175	105	70	117	117	55	25	0.365	938.75.90B
90	3.5	200	120	80	125	123	65	25	0.52	938.90.90B
110	4.3	240	140	100	94	146	65	20	0.62	938.110.90B
125	4.9	250	150	100	124	146	70	20	0.77	938.125.90B
160	6.2	350	210	140	145	146	105	30	1.355	938.160.90B
200	6.2	360	180	180	165	146	180	25	1.71	938.200.90B
250	7.8	440	220	220	190	146	220	40	3.075	938.250.90B
315	9.8	560	280	280	225	146	280	70	5.5	938.315.90B

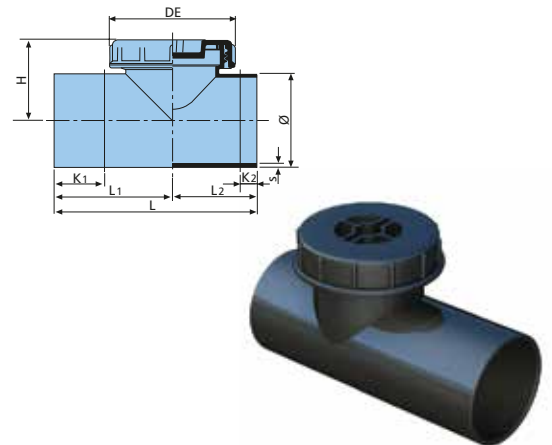

Ø / Ø ₁	S	S ₁	L	L ₁	L ₂	H	DE	K ₁	Kg	Code
HDPE 45° ACCESS PIPE WITH SCREW CAP										
110/110	4.3	4.3	270	90	180	220	150	55	0.84	938.110.135B
160/110	6.2	4.3	375	125	275	280	150	110	1.76	938.160.135B
125/110	4.9	4.3	300	100	200	230	150	70	1.24	938.125.135B

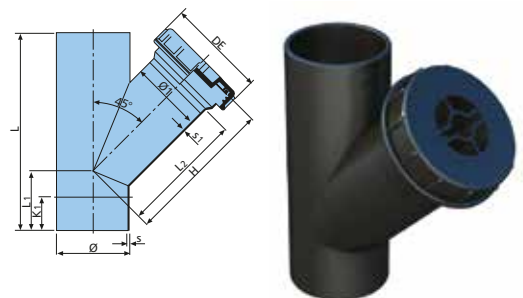

Terrain FUZE Fittings

HDPE fittings

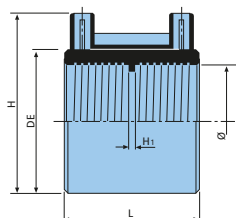

Ø	L	DE	H	H ₁	Kg	Code
HDPE ELECTROFUSION COUPLINGS						
40	64	52	68	3	0.055	910.40B
50	60	63	80	3	0.07	910.50B
56	60	70	86	3	0.085	910.56B
63	60	77	92	3	0.08	910.63B
75	60	90	105	3	0.105	910.75B
90	60	106	121	3	0.135	910.90B
110	60	126	143	3	0.165	910.110B
125	60	142	158	3	0.21	910.125B
160	60	178	194	3	0.26	910.160B
200	153	233	248	3	1.705	910.200B
250	153	285	300	3	2.135	910.250B
315	153	350	365	3	2.61	910.315B

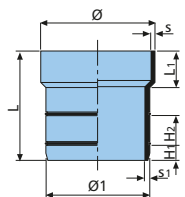

Ø / Ø ₁	S	S ₁	L	L ₁	H ₁	H ₂	Kg	Code
HDPE MALE PVC ADAPTOR WITH RING SEAL								
110/100	4.3	6	105	30	25	25	0.162	9113.110100B

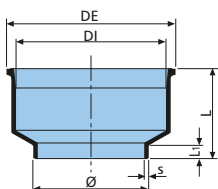

Ø	S	DI	DE	L ₁	L ₂	Kg	Code
HDPE WC PAN CONNECTOR WITH CAP							
90	3.5	120	131	67	12	0.12	925.90B
110	4.3	120	131	68	15	0.13	925.110B

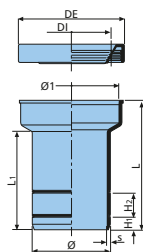

Ø / Ø ₁	S	DI	DE	L	L ₁	Kg	Code
HDPE WC CONNECTOR FOR PVC WITH RING SEAL							
90/100	3.5	102±5	140	166	130	0.28	925.90100B
110/100	4.3	102±5	140	166	130	0.39	925.110100B

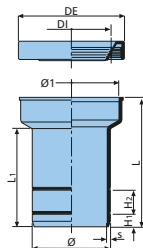

Ø / Ø ₁	S	DI	DE	L	L ₁	H ₁	H ₂	Kg	Code
HDPE MALE PVC ADAPTOR WITH RING SEAL									
100	4.3	102±5	140	166	125	17	30	0.35	925.100B

HDPE fittings

Ø	S	DI	DE	L	L ₁	Kg	Code
HDPE EXTENDED WC PAN CONNECTOR WITH CAP							
90	3.5	110	117	125	9	0.175	993.90B
100	4.3	110	117	125	11	0.17	993.100B

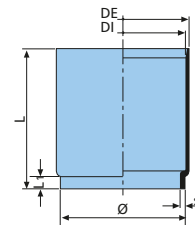

Ø	S	L	DE	Kg	Code
HDPE SLIDING CONNECTOR					
110	4.3	196	140	1.0	911S.110B
160	6.7	230	185	1.225	911S.160B
200	6.7	270	226	1.445	911S.200B
250	8.3	300	284	2.91	911S.250B
315	10.4	320	354	5.1	911S.315B

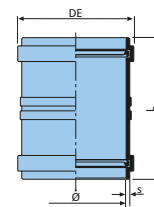

Ø	S	L	H	DE	Kg	Code
HDPE RING SEAL SOCKET						
110	4.3	176	6	130	0.43	910P.110B
160	6.7	230	6	185	1.24	910P.160B
200	6.7	270	6	226	1.815	910P.200B
250	8.3	300	7	284	5.14	910P.250B
315	10.4	320	9	354	7.33	910P.315B

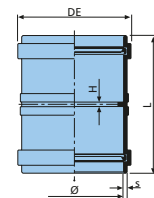

Ø	S	DI	DE	L	L ₁	Kg	Code
HDPE EXTENDED FLOOR PAN CONNECTOR WITH 2 SEALS							
110	4.3	102±5	140	166	125	0.42	993.110DB

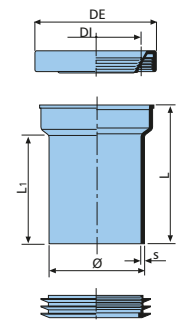

Terrain FUZE Fittings

HDPE fittings

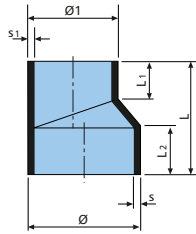
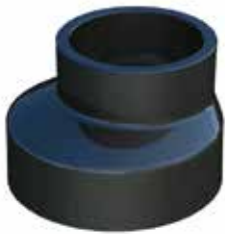

$\text{Ø}/\text{Ø}_1$	S	S ₁	L	L ₁	L ₂	Kg	Code
HDPE ECCENTRIC REDUCER							
50/40	3	3	80	35	35	0.035	923.5040B
56/40							923.5640B
56/50	3	3	80	37	35	0.04	923.5650B
63/40	3	3	80	37	35	0.04	923.6340B
63/50	3	3	80	37	35	0.04	923.6350B
63/56	3	3	80	40	35	0.045	923.6356B
75/40	3	3	80	37	35	0.055	923.7540B
75/50	3	3	80	37	35	0.05	923.7550B
75/56	3	3	80	37	35	0.05	923.7556B
75/63	3	3	80	35	35	0.055	923.7563B
90/40	3.5	3	80	37	35	0.065	923.9040B
90/50	3.5	3	80	37	35	0.065	923.9050B
90/56	3.5	3	80	37	35	0.075	923.9056B
90/63	3.5	3	80	37	35	0.07	923.9063B
90/75	3.5	3	80	37	35	0.095	923.9075B
110/40	4.3	3	80	37	35	0.095	923.11040B
110/50	4.3	3	80	37	35	0.1	923.11050B
110/56	4.3	3	80	37	35	0.1	923.11056B
110/63	4.3	3	80	37	35	0.105	923.11063B
110/75	4.3	3	80	37	35	0.105	923.11075B
110/90	4.3	3.5	80	37	35	0.14	923.11090B
125/110	4.9	4.3	80	37	35	0.135	923.125110B
125/50	4.9	3	80	37	35	0.13	923.12550B
125/56	4.9	3	80	37	35	0.125	923.12556B
125/63	4.9	3	80	37	35	0.125	923.12563B
125/75	4.9	3	80	37	35	0.13	923.12575B
125/90	4.9	3.5	80	37	35	0.13	923.12590B
160/110	6.2	4.3	80	37	35	0.23	923.160110B
160/125	6.2	4.9	80	37	35	0.22	923.160125B

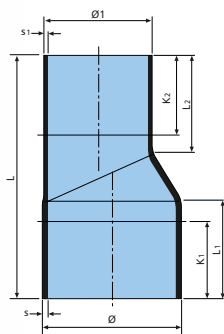

$\text{Ø}/\text{Ø}_1$	S	S ₁	L	L ₁	L ₂	K ₁	K ₂	Kg	Code
HDPE LONG ECCENTRIC REDUCER									
160/110	6.2	4.3	215	35	37	20	20	0.43	923.160110LB
160/125	6.2	4.9	140	45	40	20	20	0.33	923.160125LB
200/110	6.2	4.3	285	80	40	50	10	0.94	923.200110LB
200/125	6.2	4.9	285	80	40	50	10	0.91	923.200125LB
200/160	6.2	6.2	210	80	37	50	10	0.72	923.200160LB
250/200	7.8	6.2	405	160	140	100	100	1.965	923.250200LB
315/200	9.8	6.2	540	160	140	100	100	3.49	923.315200LB
315/250	9.8	7.8	450	160	150	100	100	3.295	923.315250LB

HDPE fittings

Ø	S	L	L ₁	R	K	Kg	Code
HDPE SHORT RADIUS BEND							
90	3.5	270	50	50	200	0.3	902.90.90B
110	4.3	300	60	60	220	0.5	902.110.90B

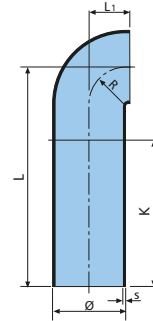

Ø	S	DI	DE	L	L ₁	K	Kg	Code
HDPE WC BEND WITH CAP								
110	4.3	120	132	300	125	220	0.600	929.110.90
90	3.5	120	132	270	115	200	0.420	929.90.90

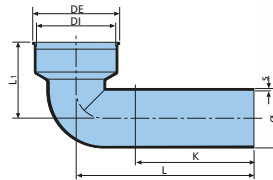

Ø/Ø ₁	Mod	S	L	L ₁	L ₂	DE	K	Kg	Code
HDPE WC BEND HANGING PAN WITH SEAL AND CAP									
90/90	A	3.5	270	90	40	108	150	0.398	999.90.90B
110/110	A	4.3	300	87	40	130	180	0.596	999.110.90B

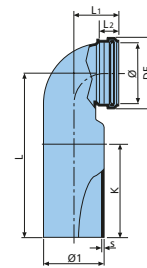

Ø	S	L	L ₁	R	K	Kg	Code
HDPE WC PAN CONNECTOR - WHITE							
90	3.5	102±5	140	166	130	0.285	925.90W
110	4.3	102±5	140	166	130	0.355	925.110W

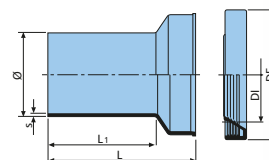

Terrain FUZE Fittings

HDPE fittings

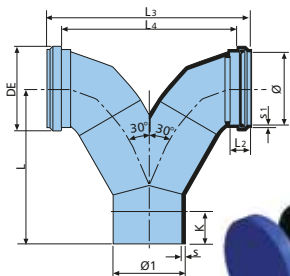
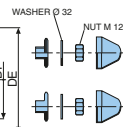
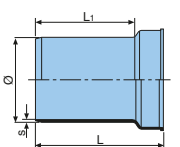
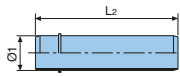
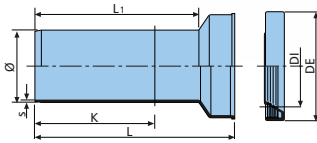
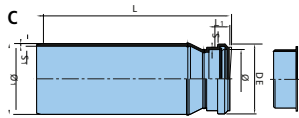
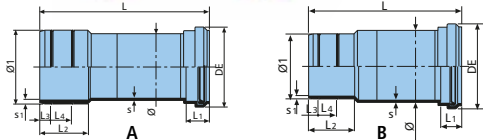

\emptyset/\emptyset_1	Mod	S	S ₁	DE	L	L ₁	L ₂	L ₃	L ₄	Kg	Code
HDPE STRAIGHT WC PAN CONNECTOR WITH SEAL AND CAP											
90/100	A	3.5	5.5	109	232	31	70	15	28	0.332	999.90100.00B
90/100	C	4.3	4.3	109	300	31	180	-	-	0.48	998.90100.00B

\emptyset	S	DE	DI	L	L ₁	K	Kg	Code
HDPE LONG WC PAN CONNECTOR WITH SEAL								
90	3.5	140	102±5	250	200	150	0.36	925L.90B
90	3.5	140	102±5	300	260	200	0.42	925XL.90B

\emptyset/\emptyset_1	S	DI	DE	L	L ₁	L ₂	L ₃	Kg	Code
HDPE WC CONNECTOR FOR HANGING PAN WITH SEAL AND WHITE COVERINGS									
90/45	3.5	102±5	132	166	122	195	24	0.45	925.9044B
110/45	4.3	102±5	132	166	129	199	24	0.53	925.11044B

\emptyset/\emptyset_1	S	S ₁	DE	L	L ₂	L ₃	L ₄	K	Kg	Code
HDPE DOUBLE WC PAN CONNECTOR WITH LIP SEALS AND CAPS										
90/110	4.3	3.5	108	210	-	270	-	50	0.764	929.90110.90DB
110/110	4.3	4.3	130	205	37	285	240	50	0.816	929.110.90DB

HDPE fittings

\emptyset/\emptyset_1	S	DE	L	L ₁	L ₂	L ₃	K	Kg	Code
HDPE WC BEND FOR HANGING PAN WITH 1-LIP SEAL AND CAP, LEFT									
110/110	4.3	130	320	100	35	85	170	0.72	949.110LB
90/90	3.5	108	290	100	35	85	150	0.442	949.90LB
110/90	4.3	108	315	100	35	85	170	0.616	949.11090LB

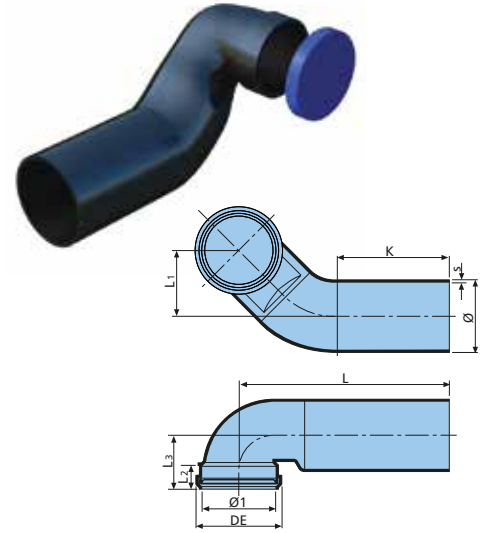

\emptyset/\emptyset_1	S	DE	L	L ₁	L ₂	L ₃	K	Kg	Code
HDPE WC BEND FOR HANGING PAN WITH 1-LIP SEAL AND CAP, RIGHT									
110/110	4.3	130	320	100	35	85	170	0.72	949.110RB
90/90	3.5	108	290	100	35	85	150	0.442	949.90RB
110/90	4.3	108	315	100	35	85	170	0.616	949.11090RB

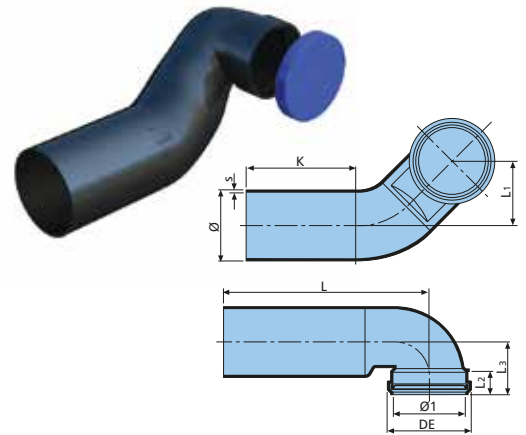

\emptyset/\emptyset_1	S	S ₁	DE	L	L ₁	L ₂	L ₃	L ₄	K	Kg	Code
HDPE WC PAN CONNECTORS											
110/110	4.3	4.3	130	340	95	37	285	240	120	1.09	949.110DB
110/90	4.3	3.5	108	335	100	-	285	-	120	1.02	949.11090DB

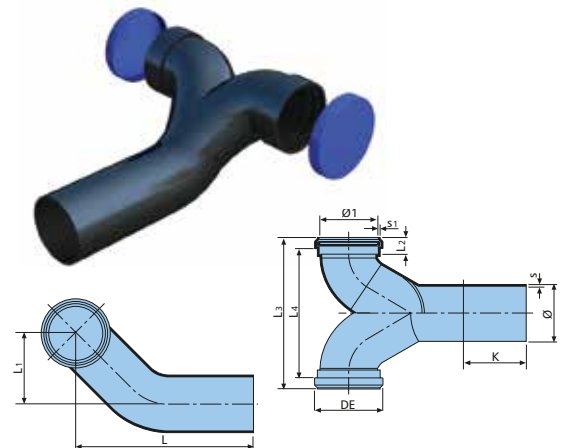

Terrain FUZE Fittings

HDPE fittings



Ø	α	S	DI	DE	L	L ₁	L ₂	Kg	Code
HDPE TRAP WITH SEAL AND CAP									
110	0°	4.3	102±5	140	270	215	170	0.72	9631.110.0B
110	45°	4.3	102±5	140	240	225	160	1.002	9631.110.45B
110	90°	4.3	102±5	140	340	225	220	0.99	9631.110.90B

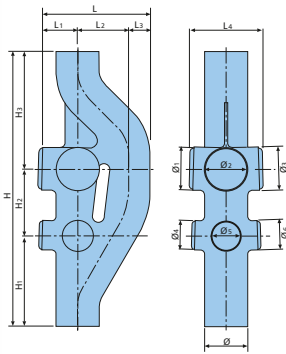
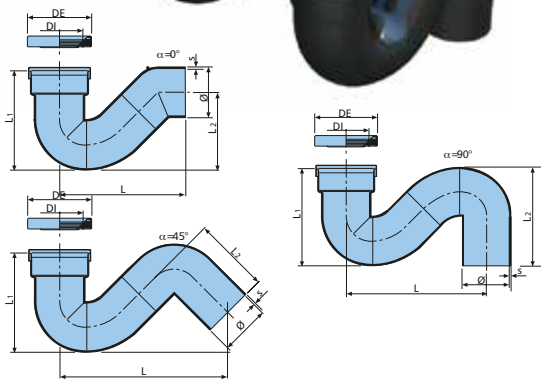

Ø	Ø ₁	Ø ₂	Ø ₃	Ø ₄	Ø ₅	Ø ₆	L	L ₁	L ₂	L ₃	L ₄	H	H ₁	H ₂	H ₃	Kg	Code
HDPE VENTILATION BRANCH																	
110	110 max	75 max	275	90	130	55	188	700	230	170	300	2.57					908.110B
160	110 max	75 max	310	90	160	60	190	1010	460	170	380	5					908.160B

HDPE fittings

∅	∅ ₁	S	S ₁	L	L ₁	L ₂	K	A	B	Kg	Code	
HDPE ADAPTOR (CAST IRON, STEEL, ASBESTOS CEMENT PIPES)												
▼	50	60	3	3	300	240	60	170	53-54	48-49	0.165	926.5060B
▼	50	73	3	3	275	220	55	170	60-67	53-60	0.145	926.5073B
▼	50	80	3	3	285	230	55	170	67-74	60-67	0.17	926.5080B
▼	50	90	3	3	305	235	70	170	80-84	73-77	0.205	926.5090B
▼	50	100	3	3	310	240	70	170	90-94	83-87	0.215	926.50100B
▼	56	60	3	3	265	205	65	140	53-54	-	0.13	926.5660B
▼	56	73	3	3	245	190	55	140	60-67	-	0.13	926.5673B
▼	56	80	3	3	245	190	55	140	67-74	53-60	0.15	926.5680B
▼	56	90	3	3	265	195	70	140	80-84	60-67	0.18	926.5690B
▼	56	100	3	3	270	200	70	140	90-94	-	0.2	926.56100B
▼	63	73	3	3	265	205	65	140	60-67	-	0.18	926.6373B
▼	63	80	3	3	245	195	55	140	67-74	-	0.165	926.6380B
▼	63	90	3	3	265	195	70	140	80-84	-	0.175	926.6390B
▼	75	80	3	3	250	190	65	-	67-74	-	0.19	926.7580B
▼	75	90	3	3	245	175	70	120	80-84	73-77	0.215	926.7590B
▼	75	100	3	3	150	80	70	120	90-94	83-87	0.215	926.75100B
▼	90	110	3.5	3.5	160	60	100	-	84-98	-	0.19	926.90110B
●	110	125	4.3	4.3	165	43.5	100	-	102-111	100-109	0.25	926.110125B
●	110	140	4.3	4.3	180	80	100	-	102-126	100-124	0.31	926.110140B
●	125	150	4.9	4.9	180	80	100	-	116-136	115-134	0.425	926.125150B

▼ Model 1 ● Model 2 ■ Flat Seal ◆ O Ring

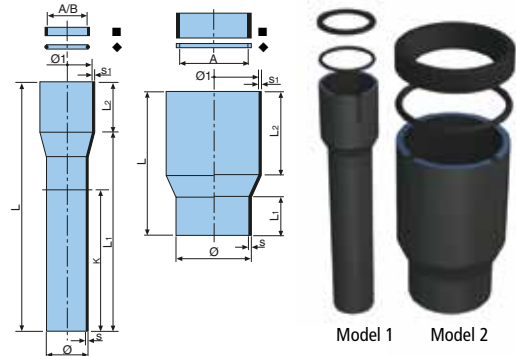

∅	S	L	L ₁	L ₂	H	H ₁	K	Kg	Code
HDPE UNIVERSAL TRAP, VERTICAL INLET AND HORIZONTAL OUTLET									
110	4.3	270	160	310	370	260	220	1.92	931.110B
63	3	210	95	185	235	160	160	0.52	931.63B
75	3	210	135	245	335	245	140	0.92	931.75B
90	3.5	240	140	270	320	225	200	1.19	931.90B

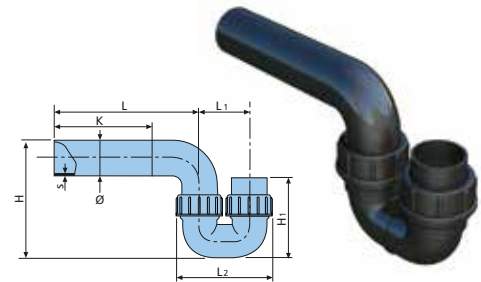

∅/∅ ₁	S	L	L ₁	H	H ₁	Kg	Code
HDPE TRAP, VERTICAL INLET AND HORIZONTAL OUTLET							
40/40	3	150	80	140	110	0.22	931.4040B
40/50	3	180	80	160	110	0.31	931.4050B
40/56	3	210	80	155	110	0.31	931.4056B
50/50	3	180	100	170	110	0.31	931.5050B
50/56	3	210	100	165	110	0.31	931.5056B

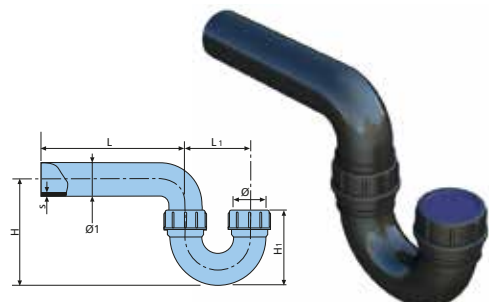

Terrain FUZE Fittings

HDPE fittings

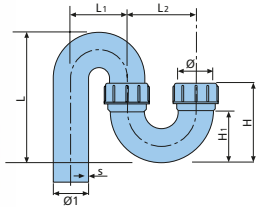

$\varnothing/\varnothing_1$	S	L	L ₁	L ₂	H	H ₁	Kg	Code
HDPE TRAP, VERTICAL INLET AND OUTLET								
40/40	3	160	60	80	110	60	0.235	932.4040B
40/50	3	180	80	80	110	65	0.34	932.4050B
40/56	3	238	80	80	110	65	0.34	932.4056B
50/50	3	180	80	100	110	70	0.34	932.5050B
50/56	3	190	80	100	120	70	0.37	932.5056B

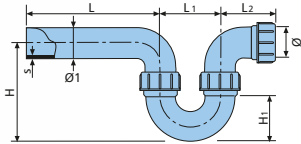

$\varnothing/\varnothing_1$	S	L	L ₁	L ₂	H	H ₁	Kg	Code
HDPE TRAP, HORIZONTAL INLET AND OUTLET								
40/40	3	150	80	90	140	40	0.31	945.4040B
40/50	3	180	80	90	160	65	0.37	945.4050B
40/56	3	210	80	90	160	40	0.4	945.4056B
50/50	3	180	100	90	170	70	0.42	945.5050B
50/56	3	210	100	90	165	80	0.44	945.5056B

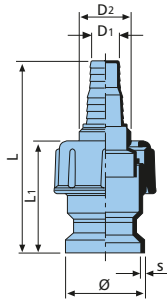

\varnothing	S	D ₁	D ₂	L	L ₁	Kg	Code
HDPE WASHING MACHINE CONNECTOR							
50	3	15/20	1"G	120	65	0.065	933.50B

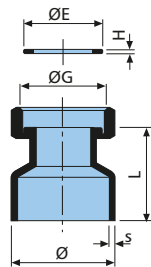

\varnothing	\varnothing_G	S	L	\varnothing_E	H	Nut	Kg	Code
HDPE FITTING WITH NUT - BRASS								
40	1 1/4"	3	45	40	2	Brass	0.08	918.40.125BN
40	1 1/2"	3	45	45	2	Brass	0.09	918.40.15BN
50	1 1/4"	3	45	40	2	Brass	0.08	918.50.125BN
50	1 1/2"	3	45	45	2	Brass	0.09	918.50.15BN

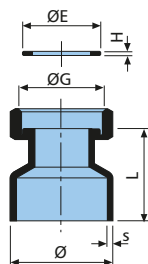

\varnothing	\varnothing_G	S	L	\varnothing_E	H	Nut	Kg	Code
HDPE FITTING WITH NUT - PLASTIC								
40	1 1/4"	3	45	40	2	Plastic	0.03	918.40.125B
40	1 1/2"	3	45	45	2	Plastic	0.03	918.40.15B
50	1 1/4"	3	45	40	2	Plastic	0.03	918.50.125PN
50	1 1/2"	3	45	45	2	Plastic	0.03	918.50.15PN

HDPE fittings

Ø	ØG	S	L	ØE	H	Nut	K	Kg	Code
HDPE EXTENDED FITTING WITH NUT - BRASS									
40	1¼"	3	195	40	2	Brass	110	0.13	918.40.125EB
40	1½"	3	195	45	2	Brass	110	0.145	918.40.15EBN
50	1¼"	3	195	40	2	Brass	110	0.15	918.50.125EBN
50	1½"	3	195	45	2	Brass	110	0.155	918.50.15EBN

Ø	ØG	S	L	ØE	H	Nut	K	Kg	Code
HDPE EXTENDED FITTING WITH NUT - PLASTIC									
40	1¼"	3	195	40	2	Plastic	110	0.08	918.40.125EPN
40	1½"	3	195	45	2	Plastic	110	0.085	918.40.15EPN
50	1¼"	3	195	40	2	Plastic	110	0.1	918.50.125EPN
50	1½"	3	195	45	2	Plastic	110	0.095	918.50.15EPN

Ø	ØG	S	L	H	Nut	K	Kg	Code
HDPE BEND WITH NUT								
40	1¼"	3	130	25	Brass	100	0.1	918.40.125.90BN
40	1½"	3	130	30	Brass	100	0.105	918.40.15.90BN
40	1¼"	3	130	25	Plastic	100	0.035	918.40.125.90B
40	1½"	3	130	30	Plastic	100	0.04	918.40.15.90PB

Ø	ØG	S	L	L ₁	L ₂	H	Nut	Kg	Code
HDPE REDUCING BEND WITH NUT									
40/50	1¼"	3	130	50	54	25	Brass	0.11	918.4050.125.90BN
40/50	1½"	3	120	50	N.C.	30	Brass	0.12	918.4050.15.90BN
40/50	1¼"	3	130	50	54	25	Plastic	0.06	918.4050.125.90PB
40/50	1½"	3	120	50	N.C.	30	Plastic	0.055	918.4050.15.90PB

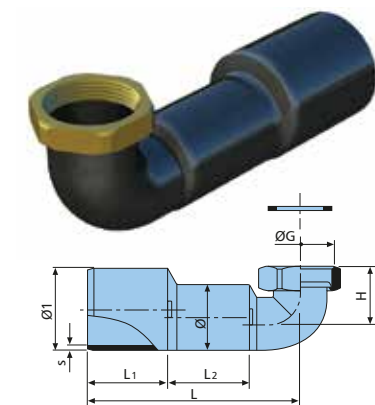
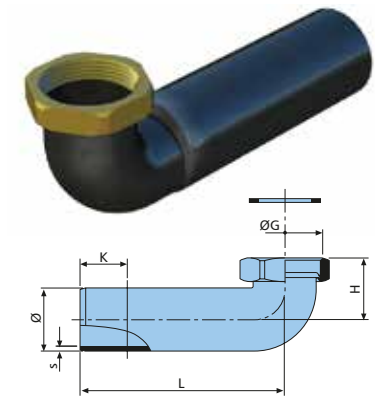
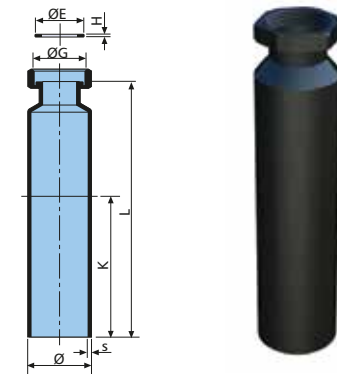
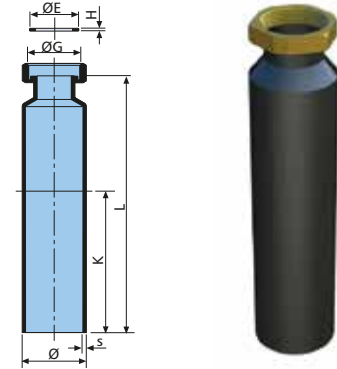

Terrain FUZE Fittings

HDPE fittings

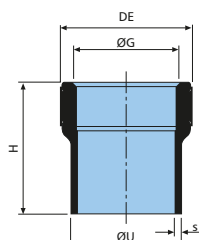

ØU	ØG	S	DE	H	Kg	Code
HDPE END WITH INTERNAL THREADING, REINFORCED WITH STEEL RING						
40	1/2"	3	40.5	55	0.065	916.40.05B
40	3/4"	3	40.5	55	0.06	916.40.075B
40	1"	3	40.5	55	0.06	916.40.1B
50	1/2"	3	50	60	0.075	916.50.05B
50	3/4"	3	50	60	0.075	916.50.075B
50	1"	3	50	60	0.075	916.50.1B
50	1 1/4"	3	50	60	0.07	916.50.125B
50	1 1/2"	3	58.5	60	0.07	916.50.15B
56	2"	3	70	65	0.1	916.56.2B
63	2"	3	70	65	0.105	916.63.2B
75	2 1/2"	3	89	70	0.135	916.75.25B

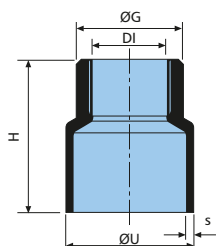

ØU	ØG	S	DI	H	Kg	Code
HDPE END WITH EXTERNAL THREADING, REINFORCED WITH STEEL RING						
50	1 1/4"	3	29	60	0.055	917.50.125B
50	1 1/2"	3	29	60	0.065	917.50.15B
56	2"	3	47	65	0.09	917.56.2B
63	2"	3	47	65	0.095	917.63.2B
75	2 1/2"	3	57	70	0.125	917.75.25B

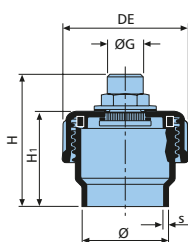

Ø	ØG	S	DE	H	H ₁	Kg	Code
HDPE THREADED FITTING WITH BRASS NIPPLE							
40	1/2" x 15mm	3	60	81	74	0.18	936.40.05NB
40	3/4" x 18mm	3	60	84	74	0.24	936.40.075NB
50	1/2" x 15mm	3	71	92	76	0.15	936.50.05NB
50	3/4" x 18mm	3	71	95	76	0.185	936.50.075NB
50	1" x 22mm	3	71	95	76	0.245	936.50.1NB

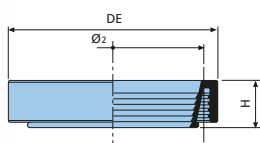

Ø	Ø ₂	DE	H	Kg	Code
HDPE SEAL FOR WC SLEEVES AND EXTENDED BENDS					
115	102±5	120	23.5	0.082	9129.125

HDPE fittings

L	OD	H	Code
FIRETRAP SLEEVE			
17	67	300	1925.17
21	71	300	1925.21
27	77	300	1925.27
34	84	300	1925.34
42	92	300	1925.42
48	98	300	1925.48
54	104	300	1925.54
60	110	300	1925.60
67	117	300	1925.67
76	126	300	1925.76
80	130	300	1925.80
89	139	300	1925.89
102	152	300	1925.102
108	158	300	1925.108
114	164	300	1925.114
127	177	300	1925.127
134	184	300	1925.134
140	190	300	1925.140
159	209	300	1925.159
169	219	300	1925.169

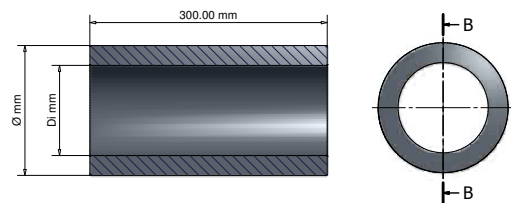

Size mm	Fire Rating	D	W	Colour	Kg	Code
HDPE END WITH EXTERNAL THREADING, REINFORCED WITH STEEL RING						
40	2 hour	52	60	RED	0.15	1625.40R
55	2 hour	67	60	RED	0.21	1625.55R
63	2 hour	83	60	RED	0.32	1625.63R
75	2 hour	95	60	RED	0.37	1625.75R
82	2 hour	102	60	RED	0.4	1625.82R
90	4 hour	110	60	RED	0.42	1625.90R
110	2 hour	130	60	RED	0.48	1625.110R
125	4 hour	161	60	RED	0.94	1625.125R
160	4 hour	209	60	RED	1.33	1625.160R
200	4 hour	255	60	RED	1.96	1625.200R
250	2 hour	305	200	RED	2.35	1625.250R
315	2 hour			RED	13	1625.315R



Terrain FUZE Fittings

HDPE fittings

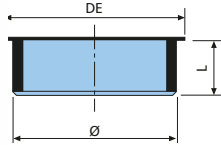

Ø	DE	L	Kg	Code
HDPE PROTECTIVE CAP FOR SOCKET				
56	62	25	0.01	9130.56B
63	71	38	0.015	9130.63B
75	85	38	0.02	9130.75B
90	102	38	0.03	9130.90B
110	123	39	0.04	9130.110B
125	135	38	0.055	9130.125B
160	167	36	0.055	9130.160B
200	220	50	0.13	9130.200B

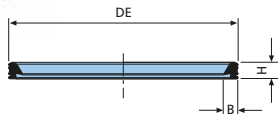

Ø	DE	H	B	Kg	Code
HDPE 1 LIP SEAL FOR SOCKETS					
100	114	9.3	8.2	0.02	927.100.908B
90	103	8.9	7.5	0.015	927.90.908B
110	123.9	8.9	7.9	0.02	927.110.908B
125	142.2	10.2	8.9	0.025	927.125.908B
160	179.8	11.5	10.2	0.045	927.160.908B
200	223.7	12.8	11.2	0.045	927.200.908B
250	282	19.5	1.6	0.5	927.250.908B
315	350	20.5	17.15	0.055	927.315.908B

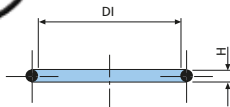

Ø	H	For Codes	Kg	Code
O-RING FOR ADAPTORS (PVC)				
100	2.62	353-354	0.002	9113.908B

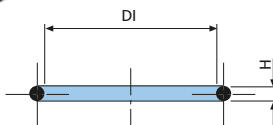

Ø	DI	H	Kg	Code
HDPE O RING FOR SOCKETS				
40	39+1	6	0.005	9116.40B
50	49+1	6	0.005	9116.50B
56	54+1	6	0.005	9116.56B
63	62+1	6	0.01	9116.63B
75	79+1	6	0.01	9116.75B
90	89+1	6	0.01	9116.90B
110	109+1.5	7	0.015	9116.110B
125	124+1.5	8	0.025	9116.125B
160	159+1.5	9	0.035	9116.160B

HDPE fittings

Ø	H	B	DE	Kg	Code
HDPE SEAL FOR EXPANSION SOCKETS					
40	16	12	60	0.025	911.40.908B
50	16	12	70	0.035	911.50.908B
56	16	12	76	0.04	911.56.908B
110	16	12.5	130.5	0.07	911.110.908B
160	16	12.5	180.5	0.115	911.160.908B
63	16	12.5	83	0.045	911.63.908B
75	16	12.5	95.5	0.05	911.75.908B
90	16	12.5	111	0.055	911.90.908B
125	16	12	143.5	0.07	911.125.908B
200	21.8	11.2	223.7	0.045	911.200.908B
250	19.5	16	282	0.05	911.250.908
315	20.5	17.15	350	0.055	911.315.908

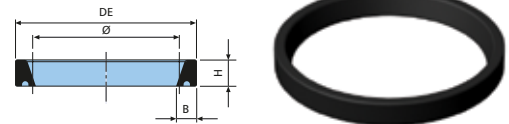

Ø ext. pipe	D	H	H ₁	Kg	Code
HDPE M10 BRACKET					
40	43	30	15	0.2	9144.40B
50	53	30	15	0.195	9144.50B
56	59	30	15	0.21	9144.56B
63	66	30	15	0.225	9144.63B
75	78	30	15	0.34	9144.75B
90	93	30	15	0.31	9144.90B
110	113	30	15	0.35	9144.110B
125	128	30	15	0.35	9144.125B
160	163	30	15	0.4	9144.160B

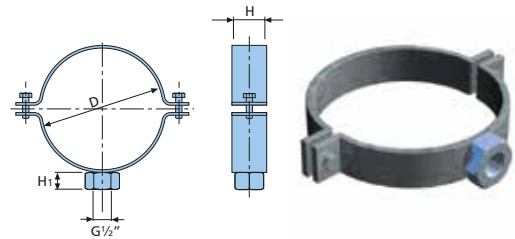

Ø ext. pipe	D	H	H ₁	Kg	Code
ADJUSTABLE PIPE BRACKET G1"					
200	203	40	43	1.05	9144.200B
250	253	40	43	1.25	9144.250B
315	318	40	43	1.55	9144.315B

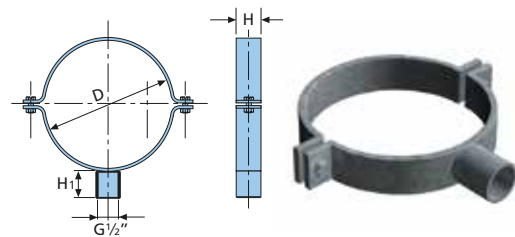

Ø ext. pipe	D	H	H ₁	Kg	Code
HDPE M16 BRACKET					
200	202	38	43	1.07	9149.200B
250	254	38	43	1.32	9149.250B
315	325	48	43	1.56	9149.315B

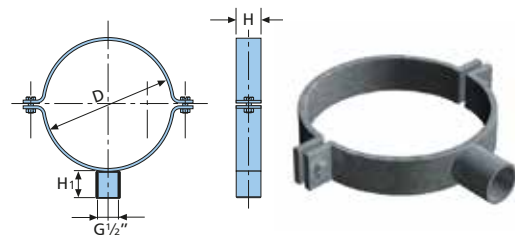

HDPE pipe anchoring shells not required

Terrain FUZE Fittings

HDPE fittings

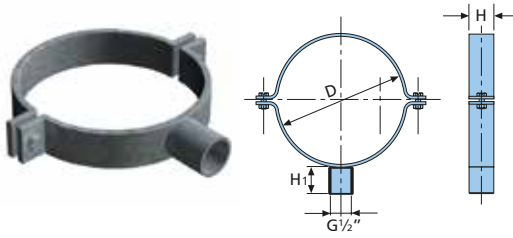

∅ ext. pipe	D	H	H ₁	Kg	Code
HDPE M10 BRACKET					
200	200	38	43	1.07	9141.200B
250	250	38	43	1.32	9141.250B
315	315	38	43	1.56	9141.315B

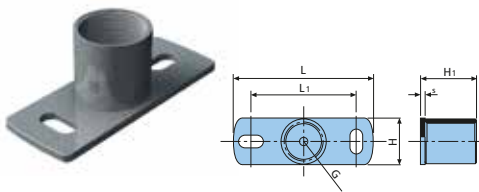

L	G	L ₁	H	H ₁	S	Kg	Code
GALVANISED STEEL FLANGE 1"							
80	M10	52	30	13	2	0.06	9148.19B
120	1/2"	82	40	20	4	0.165	9148.10B
120	1"	90	40	48	4	0.250	9148.25B

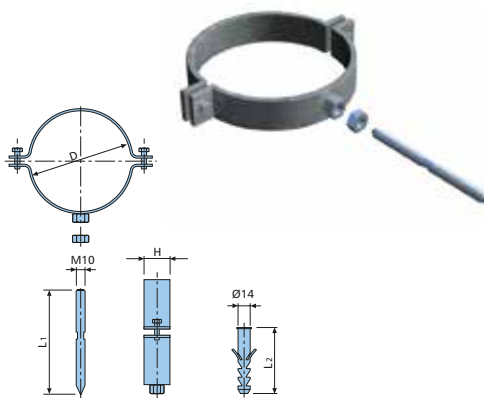

∅ ext. pipe	D	H	L ₁	L ₂	Kg	Code
HDPE M10 ANCHOR BRACKET						
40	43	30	120	75	0.23	9142.40B
50	53	30	120	75	0.24	9142.50B
56	59	30	120	75	0.255	9142.56B
63	66	30	120	75	0.27	9142.63B
75	78	30	120	75	0.28	9142.75B
90	93	30	120	75	0.33	9142.90B
110	113	30	120	75	0.345	9142.110B
125	128	30	120	75	0.32	9142.125B
160	163	30	120	75	0.435	9142.160B

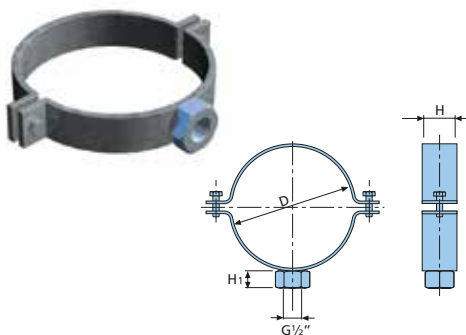

∅ ext. pipe	D	H	H ₁	Kg	Code
HDPE 1/2" BRACKET					
40	43	30	15	0.2	9143.40B
50	53	30	15	0.195	9143.50B
56	59	30	15	0.21	9143.56B
63	66	30	15	0.225	9143.63B
75	78	30	15	0.34	9143.75B
90	93	30	15	0.31	9143.90B
110	113	30	15	0.35	9143.110B
125	128	30	15	0.35	9143.125B
160	163	30	15	0.4	9143.160B

HDPE fittings

∅ ext. pipe	D	L	S	Kg	Code
HDPE PIPE ANCHORING SHELL					
40	43	30	1	0.035	9145.40B
50	53	30	1	0.045	9145.50B
56	59	30	1	0.05	9145.56B
63	66	30	15	0.055	9145.63B
75	78	30	15	0.065	9145.75B
90	93	30	15	0.075	9145.90B
110	113	30	15	0.095	9145.110B
125	128	30	15	0.105	9145.125B
160	163	30	15	0.13	9145.160B
200	203	30	15	0.3	9145.200B
250	253	30	15	0.35	9145.250B
315	318	30	15	0.4	9145.315B

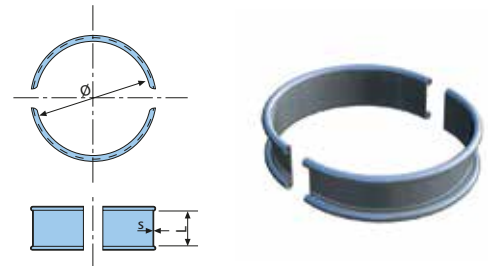

∅ ext. pipe	D	H	H ₁	Kg	Code
ACOUSTIC PIPE BRACKET					
90	93	30	9	0.075	9146.90B
110	113	30	9	0.095	9146.110B
160	163	30	9	0.105	9146.160B

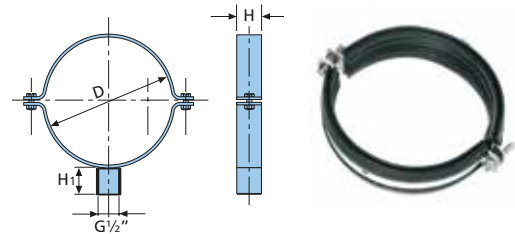

L	L ₁	H	H ₁	Kg	Code
RUBBER INSERT STRIP					
30	34	4	2	5.015	9104.40B
40	45	6	4	1.580	9104.30B

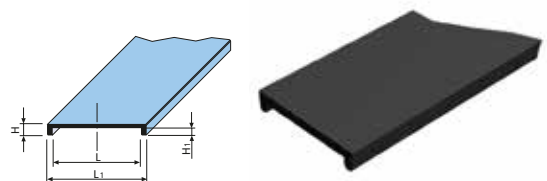

L	L ₁	H	H ₁	Kg	Code
ANTI VIBRATION RUBBER INSERT FOR CLIPS (30 METRE LENGTH)					
30	36	9	3	6.11	9105.30B

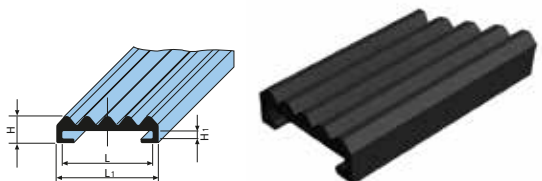

Terrain FUZE Tooling

Terrain FUZE Electrofusion Welding Machine

Product code: 9000.40315.110V

Supplied complete with yellow cable for pipe diameters up to and including 160mm and blue cables for pipe diameters greater than 160mm.

General Properties:

Supply voltage	110V
Pipe diameters	40-315mm
Supply current	10A
Supply power	3500W
Supply protection	Class 1 – earthed
Weight	15Kg
Size	410 x 350 x 200mm
Protection level	IP65
Operating temp.	-15oC to +45oC



Part number	Description	Pipe diameters
AW00-2003	Yellow replacement leads	Up to and including 160mm
AW00-2004	Blue replacement leads	Above 160mm



Terrain FUZE Pipe Cutter

Part number	Description	Pipe diameters
9500.663T	Pipe Cutter – Model T1	40 to 63mm
9500.50140T	Pipe Cutter – Model T2	50 to 140mm
9500.100160T	Pipe Cutter – Model T3	100 to 160mm

General Properties:

Model T1

Weight: 0.6Kg
Pipe diameters: 40-63mm

Model T2

Weight: 1.4Kg
Pipe diameters: 50-140mm

Model T3

Weight: 1.6Kg
Pipe diameters: 100-160mm

Spare cutting wheels

Part number	Pipe diameters
9501.63T	40 to 63mm
9501.168T	50 to 160mm



Terrain FUZE Pipe Chamfer Tool

Part number	Description	Pipe diameters
9502.32160T	Pipe Chamfer Tool – Model 1	32 to 160mm
9500.50140T	Pipe Chamfer Tool – Model 2	40 to 250mm

General Properties:

Model 1

Weight: 0.8Kg
Pipe diameters: 32-160mm

Model 2

Weight: 1.4Kg
Pipe diameters: 40-250mm



Pipe scraper

Product code: 9507T

Notes

Terrain FUZE



Polypipe Building Services

New Hythe Business Park
College Road
Aylesford
Kent
ME20 7PJ
United Kingdom
Tel: +44 (0)1622 795200
Fax: +44 (0)1622 716796

commerciaLENquiries@polypipe.com
www.polypipe.com/building-services