



THE BELSAW COMPANY

90 Karina Court • San Jose • CA • 95131
Fax (408) 441-1222 • <http://www.belsaw.com>

BARGAIN BLITZ

freud

PERFORMAX

DELTA
WOODWORKING MACHINERY

PORTER
CABLE

GENERAL

GENERAL
INTERNATIONAL

POWERMATIC

EXCALIBUR
SOMMERVILLE
DESIGN

DEWALT

BOSCH

Featuring the one & only
Belsaw Planer/Molder,
its parts, accessories and
numerous other essential
tools and supplies for
every shop.

ALSO INSIDE:

*The Complete Belsaw
Planer/Molder
Pattern Knives
Catalog!*



CMT



"Jorgensen"

Amana Tool Corp.

SYSTI
MATIC



SENCO®
FASTENING SYSTEMS

JET



BIESEMEYER

metabo

BESSEY



Makita
POWER TOOLS FOR THE LEADING PRO

ROUSSEAU
COMPANY

© 2000 The Belsaw Company. This catalog supersedes all other Catalog offers. We reserve the right to correct any typographical and pictorial errors when ordering. Printed in the USA.

Order Toll Free! 1-800-468-4449 Mon.-Fri. 7:00am to 3:00pm Pacific Time

The Belsaw Planer/Molder... NO Other Machine Offers This Much!

Planing Capacity

Max Depth Of Cut	3/16"
Max Width Of Cut	12-3/8"
Max Thickness Of Stock	6-1/4"
Min Thickness Of Stock	3/16"
Minimum Length Of Stock	8"

Molding Capacity

Max Depth Of Cut	3/4"
Max Width Of Cut	12-3/8"
Max Thickness Of Stock	6-1/4"
Min Length Of Stock	8"

General Specifications

Cutterhead Speed	4500 RPM
Cutterhead	3-Knife
Cutterhead Bearings	Sealed Ball Bearing
Feed Rate (FPM)	12 FPM (Standard), 20 FPM (Optional)
Cuts Per Inch	94 @ 12 FPM or 56 @ 20 FPM
Bed Width	12-3/8"
Bed Length	27-1/4"
Bed Construction	1 Piece Solid Cast Iron

Electrical Specifications

Motor	5 HP Industrial Duty
Voltage/Amperage	220v. Single Phase, 23-26 Amps
Starter Switch	Magnetic
Switch	Rocker With Removable Key
Motor RPM	3,450 RPM

The Belsaw Planer / Molder



- Planes Lumber
- Makes Moldings
- Surface Sands



- Plane your own lumber and save money over lumberyard prices. Plus, dimension your material to your needs and control the quality instead of having to accept what is available!
- Create your own intricate moldings in virtually any wood species you desire. Be it a stock pattern, tongue and groove or one of your own designs, no other machine opens up such flexibility!
- Surface sand your lumber to eliminate hours of tedious hand sanding!

Simply stated, this machine can make AND save you money every time you use it!

Buy the versatile Belsaw planer/molder and you will find rugged construction, and features not found on similar equipment...

- Heavy duty chain and sprocket Feedworks system ensures that full power is transmitted to the feed rollers for positive and consistent feed rate. This will deliver consistent planing and molding finish results.
- Our molding guide system will make molding setups fast and easy.
- Exclusive hairline height scale, precision cuts are not only possible, but consistent.
- Solid 3-1/2" bar stock steel cutterhead that has been precision milled. The cutterhead is multipurpose so that planing and molding can be performed without the need to buy molding attachments.
- Rubber feed rollers are manufactured to a specific durometer that ensures correct feed pressure that will not mar delicate molding patterns.
- Safety interlock switch that cuts power to the planer when the hood is opened. This exclusive feature should prove that we have taken extra measures to ensure operator safety.
- Solid cast iron bed measures a full 27-1/2" long and offers superior material support and adds to the machine's stability.
- Dual drive belt system ensures that full power is transmitted from the 5 HP industrial duty motor to the cutterhead.

The **Belsaw Planer/Molder** ideally lends itself to high production by utilizing combined power-fed operations. Yet the simplified chain and sprocket drive system provides easy maintenance and factory assured alignment. The drive reduction system keeps moving parts operating at low speeds, lessening friction and resulting wear. You can also change the standard feed rate of 12' per minute to an optional rate of 20' per minute, letting you work your stock nearly twice as fast. With this unit, you can put an end to your search for properly dimensioned stock. In order to insure the highest standard of quality, each component part, as well as the finished machine, is carefully examined and tested before being approved for shipment. By providing the highest quality, the most innovative and imaginative engineering, and the utmost in service and integrity, Belsaw has fulfilled the needs of the home craftsman and the woodworking industry for well over 60 years.

Select the planer/molder package that best suits your needs!

Designed for the professional woodworker but priced for the do-it-yourself-er. Get the BEST Belsaw has to offer in a planer/molder. Includes the basic unit, 5HP continuous duty motor with magnetic controls. Plus...

- Our precision dial indicator knife setting gauge for precise planer knife adjustment.
- The dust collector attachment for connection to your dust collection system.
- Our high performance molding guide system for rapid setup of molding operations.
- A set of our Micro-Bevel high speed steel planer knives specifically designed for planing "problem" wood species.

985-Pro-Pack
\$ 1,875.00



High Performance Molding System

Includes: The basic machine package Shown above PLUS our molding guide system and 4-Edge molding guides.



VP-3
\$ 1,759.00



Includes The Molding Guide System! (displayed on page 3)



Includes 4 Edge Molding Guides! (displayed on page 3)



Basic Planer/Molder

Includes: Our world famous Planer-Molder with heavy steel stand, single phase 220v. 5 HP industrial duty motor, prewired magnetic starter switch, pre-installed planer knives, and all required V-belts.

112002
\$ 1,695.00



Accessories



Knife Hone & Guide

With this handy sharpener, you will be able to hone your jointer and planer knives to razor sharpness without removing them from the machine! Great for quick touch-ups and extends the period between major re-sharpening.

#D1123

\$ 8.95



Lumber Thickness Gauge

This easy to use thickness gauge will provide lumber thickness readings in seconds. Measures from 0" to 2" by 1/32" increments. Use it to calibrate your planer thickness gauge, measure lumber thickness, molding widths, etc. Made from aluminum.

#MJ-821

\$ 14.95

Feedworks Chain Replacement Kit

This kit contains the three drive chains in the feedworks system. Also included is the 20" V-Belt that transfers power from the cutterhead to the feedworks. Replacing all three chains at the same time will ensure longer sprocket life and deliver consistent transfer of drive power to the feed rollers.

#BRK-1 \$ 34.95
For Belsaw Planer/Molders models 910 & 912, order by kit number below...



#BRK-2 \$ 47.95

Complete Feedworks Rebuild Kit

Completely rebuild your planers feedworks system with this kit. Includes all sprockets, chains, bushings, link adjustment assemblies, 20" V-Belt, and sprocket weldments to replace worn out feed works systems.

This kit will breath new life into your planer/molder giving you many more years of service. Will not fit on Belsaw planer/molder models 910/912. Please contact Customer Service for other

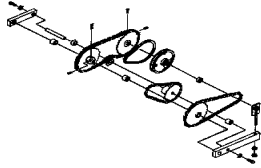

BRK-3 \$ 329.95

Feed Roller Rebuild Kits



Replace your planer/molder's worn and grooved feed rollers to restore feed performance. This kit includes the front and rear feed rollers, feed roller bushings, and a complete set of feed roller tension springs. If you are having any feeding problems, by installing this kit, any difficulty you have been having should be eliminated.

#BRK-4 \$ 89.95

For Belsaw Planer/Molders models 910 & 912,

Order by kit number below... **#BRK-5 \$ 89.95**

Replacement Feed Rollers

Replace your worn feed rollers with this genuine replacement. Manufactured to original specifications. Fits 12" planer/molders. Sold individually. # 4509062 **\$ 26.95**
For 8" planer/molder order #4549008 **\$ 24.95**

Drive Bushing Replacement Kits

This kit contains all the bronze oilite bushings found in your planer's feedworks system. We suggest that you replace all bushings at the same time. **#BRK-6 \$ 22.95**

For Belsaw Planer/Molders models 910 & 912,

order by kit number below... **#BRK-10 \$ 21.95**

Bed Elevation Repair Kit

Renew the elevation system with this kit that contains the four corner sprockets, bushings and roller chain. Also works on Belsaw 910/912 planers. **#BRK-7 \$ 79.95**

Drive Sprocket Replacement Kit

This kit contains all the sprockets found in your planer/molders feedworks system. This kit fits on all current model 12" planer molders. Will not fit planer models 910 or 912. **#BRK-8 \$ 249.95**

Aluminum Gib Replacement Kit

This set includes six 5-3/4" gibs, three 1" gibs, three 1" gib spacers and all of the necessary socket set screws.

BRK-9 \$ 79.95

T-Handle Hex Keys

For Adjusting Jack Screws
#51610 5/32" \$ 2.99

For Adjusting Gib Screws
#51612 3/16" \$ 3.49



"Tri-Sand" Abrasive Surfacing System

Install this optional accessory on your 12" planer-molder to convert it into a surface sanding machine! Very easy to install on the cutterhead of your 12" Planer-Molder. With this accessory, you will be able to sand away any remaining mill marks on your planed lumber and save yourself time from tedious hand sanding. This system comes complete with all required aluminum gibs, pulley, a set of three (3) 100 grit abrasive pads, and a V-Belt.



#4500540 \$ 96.50

"Tri-Sand" Abrasive Pads (sets of 3)

#3703040 80 Grit \$ 8.25

#3703041 100 Grit \$ 8.25

#3703042 150 Grit \$ 8.25

Increase Your Belsaw Planer/Molders Feed Rate By 60%!

With just the change of a sprocket, you can speed up the feed rate of your Belsaw planer up to 20 feet per minute - a 60% boost over the standard 12 feet per minute rate.



Your owners manual leads you step by step through installation. Ideal for owners who production plane lumber.

#4500551 Model 910/912 Planers \$ 49.95

#4509583 For models made after 1983 \$ 41.50

Planer Bed Wax

Extends the life of feed rollers, chains, bearings and sprockets by reducing feed drag. Very easy to apply and long lasting. Does not contain silicone. Use on virtually any machine surface. Protects against corrosion. 14 ounce can.



#WPW1 \$ 17.95

Locking Caster Kit

Fits any Belsaw 12" Planer-Molder as well as the Sears 12" Planer-Molders. Set includes 4 casters with a positive locking foot brake for stability after being moved to the desired location and all mounting hardware.



#4500526 \$ 62.50

Belsaw Planer Knife Sets

Belsaw Planer Knives

Made from only the highest quality materials. We also have specially priced our sets with quantity discounts so you can stock up with extra sets on hand. 12" knives are sold 3 blades to a set; 8" are sold 2 blades to a set.

#4501958 12" \$ 48.50

#4540858 8" \$ 36.95



Belsaw 12" MICRO-BEVEL PREMIUM QUALITY Planer Knives

These high speed steel knives feature a secondary bevel ground at the tip that will allow you to get much more life out of your knives before they require sharpening. Further benefits such as a smoother planed finish make Micro-Bevel knives the choice of professionals! Sold per set of 3 knives.

#4501963 \$ 69.95

12" Solid Carbide Planer Knives

#TN 6325C (Set of 3) \$ 349.95

Molding Guide System

This complete molding guide system will save you time when making the transition from planing to molding operations. Takes only minutes to attach and is constructed from high density particle board for stability and strength, it measures a full 42" long. The two sets of standard guides (included) make adjustments easy.



#4500502 \$ 98.75

Edge Molding Guides

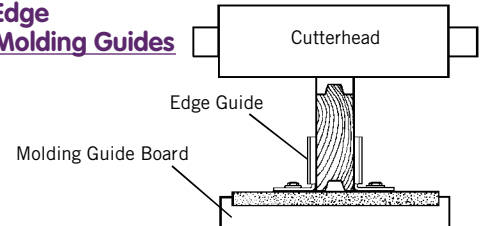

Use the optional edge molding guides when molding profiles such as tongue and groove patterns. Made from heavy gauge formed steel. Zinc plated to guard against corrosion. Four required.

#4509492 \$ 8.25 ea.

Dust Collection Attachment

Includes dust port, and internal dust channel. Very easy to install. Fits Belsaw model 985, & similar models. Attachment will not fit model 910/912 planers.



#4500592 \$ 59.95

Knife setting Gauges

Dial Indicator Knife Setting Gauge

Position knives to within thousands of an inch. Once you set your knives using this gauge, you will never use anything else again! Large Dial Indicator face is easy to read. Indicator has 1" travel with secondary dial. Measures in increments of .001". Large Indicator Anvil and instructions are included.



#SC-001G \$ 76.50

The "Sure-Set" Knife Setting Gauge

Take readings on the left and right side of the planer knives and the adjustable floating top pin will indicate alignment. An economical alternative to more expensive gauges.



#4501960 \$ 32.50

Economy Knife Setting Gauge

This simple gauge straddles the top of the cutterhead over the planer knives. Simply raise the knife until it makes contact with the gauge. Instructions are included.

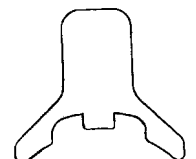

#MGA-B14D \$ 9.95

Dust Collectors

Belsaw 3 HP Dust Collector

- High Efficiency Cloth Bags
- 1836 CFM of Power
- 3HP, 230 volt, single phase motor
- Casters For Mobility
- Adaptable for one 6", or three 4" hose connections

MC-2DC **\$ 449.00**



Ideal for use in shops with Multiple Machines!



Belsaw 3 HP Dust Collector

- High Efficiency Cloth Bags
- 1836 CFM of Power
- 3HP, 230 volt, single phase motor
- Casters For Mobility
- Adaptable for one 6", or three 4" hose connections

MC-CT-201H **\$ 449.00**



Ideal for use in shops with Multiple Machines!



Belsaw 1 HP Dust Collector

- High Efficiency Cloth Bags
- 700 CFM of Power
- 1HP, 115/230 volt, single phase motor
- Casters For Mobility
- One 4" hose connection

MC-CT-80A **\$ 189.00**



Ideal for use with tablesaws, radial arm saws and sanding machines!



Belsaw 2 HP Dust Collector

- High Efficiency Cloth Bags
- 1059 CFM of Power
- 2HP, 230 volt, single phase motor
- Casters For Mobility
- Adaptable for one 5", or two 4" hose connections

MC-IDC **\$ 279.00**



Ideal for use with Belsaw Planer/Molders!



Belsaw 1 HP Dust Collector

- High Efficiency Cloth Bag
- 700 CFM of Power
- 1HP, 115 Volt motor
- Casters For Mobility
- One 4" hose connection

MC-CT-50S **\$ 149.00**



Mount on a wall or use the caster-mounted base for mobility!



Belsaw 1 HP Dust Collector

- High Efficiency Cloth Bags
- 700 CFM of Power
- 1HP, 115/230 volt, single phase motor
- Casters For Mobility
- One 4" hose connection

MC-CT-90C **\$ 179.00**



Ideal for use with tablesaws, radial arm saws and sanding machines!





Dust Collection Basics Book

This book will guide you through all the steps in connecting your home shop dust control system. Tips on design, layout and construction. A must read book if you want total dust control in your shop!

#W1050 \$ 5.95

Dust Collection Basics Video

This video was written with the home shop woodworker in mind. Tape discusses topics such as system design, duct material, fittings, construction and grounding.

#JW1050V \$ 12.99

Floor Sweep

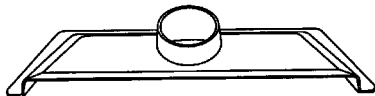

Use in conjunction with our 4" blast gate; open gate and sweep dust in. Attach to floor with double sided tape or duct tape. ABS plastic.

#W1003 \$ 9.95

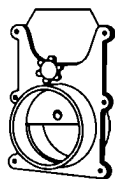

Blast Gates

A blast gate enables you to maximize your dust collection system efficiency by allowing you to control air flow from one machine to another. Available both in plastic and aluminum.

Aluminum Blast Gates

#W1141	3" Outlet	\$ 10.95
#W1142	4" Outlet	\$ 12.95
#MRT-226	5" Outlet	\$ 24.50
#MRT-227	6" Outlet	\$ 27.95

Plastic Blast Gates

#W1006	3" Outlet	\$ 5.50
#W1007	4" Outlet	\$ 6.50
#W1008	5" Outlet	\$ 7.95
#W1009	6" Outlet	\$ 9.95

Steel Band Hose Clamps



#W1021	3"	\$.89 ea.
#W1022	4"	\$.89 ea.
#W1023	5"	\$.99 ea.
#W1024	6"	\$ 1.09 ea.

Grounding Kit

This kit will allow you to ground your dust collection system to reduce static electricity and fire hazards. Kit includes 50' of 14 gauge copper wire, grounding screws, terminals, drill bit and instructions.

#W1053 \$ 12.95

Dust Collection Hood



This fully adjustable Dust Collection Nozzle fits any 4" flexible hose attached to a dust collector and provides a quick and easy pick-up source for dust producing machines. 1-1/8" x 12-1/2" wide nozzle rotates 360° and can be angles 180° in any position between straight up and straight down. Stable stand adjusts from 24" to 43-1/2", making it ideal for portable power tools.

#D2267 \$ 49.95

6" Universal Dust Hood



Fits over a 4-1/2" hole and can be adapted to many woodworking tools. Use it on band saws, tablesaws, shapers, sanders, etc. A very cost effective way of solving a messy problem. Outlet diameter is 4".

#W1010 \$ 5.95

Wye Branch

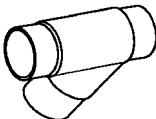

3" Wye Branch
#W1014 \$ 4.95

4" Wye Branch
#W1015 \$ 6.95

Adapters & Reducers

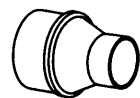

2-1/2" to 3" to Adapter
#W1041 \$ 4.95

2-1/2" to 4" to Adapter
#W1044 \$ 5.50

4" to 5" to Adapter
#W1037 \$ 6.95

4" to 3" Reducer
#W1011 \$ 3.95

3" to 2" Reducer
#W1020 \$ 3.95

Splice Fitting



3" Splice Fitting
#W1018 \$ 3.95

4" Splice Fitting
#W1019 \$ 4.95

T Fitting

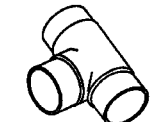

3" T-Fitting
#W1012 \$ 4.95

4" T-Fitting
#W1013 \$ 6.95

Elbow Fitting



3" Elbow Fitting
#W1016 \$ 4.95

4" Elbow Fitting
#W1017 \$ 6.95

Universal Dust Port

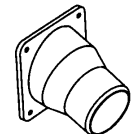

Fits over a 3" hole and is easily attached with double sided tape or screws. Outlet diameter is 2-1/2" so it will fit most home shop vacuums.

#W1042 \$ 5.50

Jointer Dust Hoods

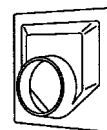

Fits most jointers on the market today. Model W1001 fits over a 6-1/2" x 6-1/2" chute and W1002 fits over a 7" x 8-1/2" chute. Outlet diameter is 4".

#W1001 8" x 8" Dimen. \$ 6.95

#W1002 10" x 8" Dimen. \$ 7.95

Tablesaw Dust Hoods

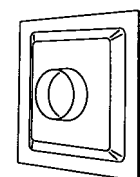

Fits most 8", 10" and 12" contractor type tablesaws. Very popular with contractors because they can be permanently attached to the saw without adding excessive weight. W1004 measures 12-1/4" L. x 12-1/4" W. x 2-1/2" H and W1005 measures 14-1/16" L. x 14-1/16" W. x 2-1/2" H. Outlet diameter is 4".

#W1004 \$ 9.95

#W1005 \$ 11.95

Plastic Dust Collector Hose



Our flexible dust collector hoses are specifically designed for your dust collection needs. (2-1/2" hose is the standard diameter for shop vacs).

#W1027	2-1/2" Diameter x 10'	\$ 12.95
#W1028	3" Diameter x 10'	\$ 13.95
#W1031	4" Diameter x 10'	\$ 18.95
#W2031	4" Diameter x 10' CLEAR	\$ 17.95
#W1032	4" Diameter x 20'	\$ 34.95
#W1033	5" Diameter x 10'	\$ 24.95

Natural Rubber -Wire Reinforced Dust Collector Hose

Our premium quality dust collector hose is manufactured from natural rubber and wire reinforced. Sold in 5' increments. Priced per foot.

#FH-2.5	2-1/2" Dia.	\$ 5.25/ft
#FH-3	3" Dia.	\$ 5.95/ft
#FH-4	4" Dia.	\$ 6.40/ft
#FH-5	5" Dia.	\$ 7.80/ft
#FH-6	6" Dia.	\$ 9.60/ft

Dust Collector Separator

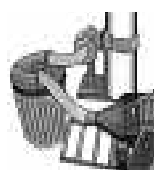

Just fit the dust collection separator onto any standard 32 gallon metal trash can between your machinery and dust collector system. Automatically removes heavy wood chips. Ideal when connected to planers and other machinery that create high volumes of wood waste.

#W1049 \$ 34.95

Mini Dust Collection Separator fits 5 gallon bucket. Use with 2-1/2" diameter hose for shop vacs.

#W2049 Mini Collector \$ 22.95

Replacement Filter Bags & Band Clamps

#19252	14" 1-Micron Filter Bag	\$ 27.95
#19275	14" Band Clamp (required with bag)	\$ 10.95
#19253	20" 1-Micron Filter Bag	\$ 34.95
#19277	20" Band Clamp (required with bag)	\$ 12.95

4" Plastic Quick Disconnect

4" inside diameter on one side and 4" outside diameter on the other to quickly provide an airtight fit.

#W1038 \$ 5.95

DELTA Air Cleaner



Improve the air quality in your shop with this air cleaner from Delta. It quietly cleans and circulates the air, filtering up to 98% of airborne particles 5 microns in size and up to 85% of particles 1 micron in size. The pleated outer



filter and 3-pocket inner filter can be replaced quickly and easily without the need for tools. The 850 CFM performance of this unit will clean the air in a 20 x 20 x 8 foot room 16 times per hour.

#50-860 \$ 249.00

Optional Accessories:

#50-858	Pleated outer filter (Pack of 2)	\$ 24.00
#50-859	Three-pocket inner filter	\$ 49.50

FREIGHT NOTES



Extra freight charges apply.



Heavy machine motor freight charges apply.

Drilling Accessories

Freud Forstner Bits

Freud's Forstner bits drill clean holes in wood and most wood products. Use for drilling flat bottom holes, pocket holes, or overlapping holes.

Individual Forstner Bits - All have 3/8" Shanks

Order	Dia.	Material	Price
#FB-001	1/4"	Steel	\$ 7.55
#FC-001	1/4"	Carbide Tipped	\$13.50
#FB-002	3/8"	Steel	\$ 7.55
#FC-002	3/8"	Carbide Tipped	\$13.50
#FB-003	1/2"	Steel	\$ 8.70
#FC-003	1/2"	Carbide Tipped	\$13.55
#FB-004	5/8"	Steel	\$ 9.75
#FC-004	5/8"	Carbide Tipped	\$14.15
#FB-005	3/4"	Steel	\$10.85
#FC-005	3/4"	Carbide Tipped	\$16.80
#FB-006	7/8"	Steel	\$11.95
#FC-006	7/8"	Carbide Tipped	\$18.20
#FB-007	1"	Steel	\$14.05
#FC-007	1"	Carbide Tipped	\$19.90
#FB-008	1-1/8"	Steel	\$15.10
#FC-008	1-1/8"	Carbide Tipped	\$21.30
#FB-009	1-1/4"	Steel	\$16.20
#FC-009	1-1/4"	Carbide Tipped	\$22.75
#FB-010	1-3/8"	Steel	\$19.90
#FC-010	1-3/8"	Carbide Tipped	\$23.35
#FB-011	1-1/2"	Steel	\$24.25
#FC-011	1-1/2"	Carbide Tipped	\$27.60
#FB-012	1-5/8"	Steel	\$25.25
#FC-012	1-5/8"	Carbide Tipped	\$29.60
#FB-013	1-3/4"	Steel	\$27.20
#FC-013	1-3/4"	Carbide Tipped	\$32.15
#FB-014	1-7/8"	Steel	\$28.15
#FC-014	1-7/8"	Carbide Tipped	\$35.19
#FB-015	2"	Steel	\$30.60
#FC-015	2"	Carbide Tipped	\$37.40
#FB-016	2-1/8"	Steel	\$34.95
#FC-016	2-1/8"	Carbide Tipped	\$43.30

16-Piece Forstner Bit Set



Get sixteen precision ground bits along with an attractive wooden storage box. Includes 1/4", 3/8", 1/2", 5/8", 3/4", 7/8", 1", 1-1/8", 1-1/4", 1-3/8", 1-1/2", 1-5/8", 1-3/4", 1-7/8", 2", 2-1/8". All Bits have 3/8" shanks. This is an excellent value!

#D1030 \$ 59.95

7-Piece Forstner Bit Set



Nothing beats a Forstner bit when it comes to drilling a clean-sided, flat-bottomed hole! But even better yet, look at the low price of this set! Get seven precision ground bits along with an attractive wooden storage box. Includes 1/4", 3/8", 1/2", 5/8", 3/4", 7/8", and 1". All Bits have 3/8" shanks.

#D1027 \$ 19.95

Carbide Tipped 35mm Hinge Boring Bit



Carbide tipped boring bit creates clean entry holes with smooth interiors for European-style hinges. 3/8" shank.

#D1026 \$ 15.95

Freud Forstner Bit Sets



16-Piece Forstner Bit Set

#FB-100 \$ 269.95

7-Piece Forstner Bit Set

#FB-107 \$ 37.50

Vise Clamps



Vise clamps adjust quickly and easily to lock your workpiece in any position. The clamping pad pivots to conform to any workpiece, ensuring uniform pressure.

#W1301 6" \$ 12.95
#W1302 9" \$ 15.95

Drill Press Vise



Cast iron construction. Features a jaw width of 6" and will hold workpieces up to 5-1/2" wide.

#DPV-6 \$ 29.95

Drill Press Tool Caddy

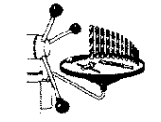

Keep your drill bits, tools and other accessories organized and within easy reach of your drill press. Easy to attach.

#DC-911 \$ 12.95

Split Ring Drill Bit Depth Stop Collars

This seven piece set consists of the following sizes: 1/8", 3/16", 1/4", 5/16", 3/8", 7/16" and 1/2".



#7805 \$ 7.95

115-Piece Jobber Drill Bit Set



Includes 29 fractional bits ranging from 1/16" to 1/2", lettered bits from A to Z and 60 numbered bits. High speed steel bits are treated and finished with a black oxide coating and housed in a rugged steel case.

#D1137 \$ 59.95

29-Piece HSS Drill Set



This set contains a total of 29 high speed steel drill bits ranging in size from 1/16" to 1/2" by 1/64" increments. Always have the right size bit on hand! Set also includes the steel drill index for storage.

#D1135 \$ 23.95

Taper Drill Bit Set

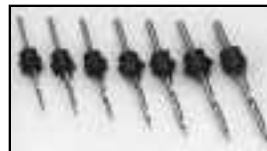

Our high quality taper drill bit set comes complete with drills, counter-sinks, and stop collars for boring holes to match the following screw sizes: 5, 6, 7, 8, 9, 10, & 12.

#D1041 \$ 19.95

Jet Benchtop Mortiser



Jet's hollow chisel mortiser features a 1/2HP, 115 volt, 1725RPM motor for solid performance and trouble free operation. Its heavy duty cast-iron and steel construction will ensure durability and stability. Rack and pinion head raising and lowering allows for positive drilling control and will give a full 4-3/4" head stroke.

#JBM-5
\$ 245.00



Includes 1/4", 3/8", and 1/2" chisel and bits!

Mortising Chisel & Bits

Part #	Size (sq/in)	Depth Cap. (in)	Bit Size (in)	Bit Shank (Dia/in)	Price
MBC-1/4	1/4	1-3/4	1/4	5/32	\$ 29.00
MBC-5/16	5/16	2-1/8	5/16	7/32	\$ 29.00
MBC-3/8	3/8	2-3/4	3/8	1/4	\$ 29.00
MBC-1/2	1/2	2-7/8	1/2	3/8	\$ 29.00
MBC-3/4	3/4	3-5/8	3/4	1/2	\$ 49.00
MBC-5	5 piece set includes 1 each of above				\$ 99.00

7-Piece Brad Point Bit Set



7-Piece Brad Point Bit Set includes 1/8", 3/16", 1/4", 5/16", 3/8", 7/16" and 1/2" bits. This starter set contains the most popular sizes for doweling.

#D1031 \$ 6.95

7-Piece Deluxe Brad Point Set

Includes 1/8", 3/16", 1/4", 5/16", 3/8", 7/16" and 1/2" bits. These bits feature fully ground flutes that produce cleaner, smoother holes.



#D1033 \$ 9.95



7-Piece Carbide Tipped Brad Point Set



If you work with wood, you need this set! The carbide tips will outlast regular carbon or high speed steel bits many times over. Includes: 1/8", 3/16", 1/4", 5/16", 3/8", 7/16" & 1/2". Plus you get this wooden box to keep them in!

#D1032 \$ 19.95

25-Piece Brad Point Set



We all have a collection of drill bits in the shop don't we? But when you need a particular size, we never seem to be able to find it! With this set, you get 25 brad point drills from 1/8" to 1/2" diameter in 1/64th inch increments.

#D1034 \$ 19.95

FREIGHT NOTES



Extra freight charges apply.



Heavy machine motor freight charges apply.

Mini-Lathe

Jet 14" Mini Wood Lathe



#JML-1014
\$ 329.00



If you've ever thought about turning pens or other small objects, this new mini-lathe is for you. This cast-iron unit has 10" of swing over the bed and has a spindle capacity of 14". Features a 1/2HP, 115Volt motor with six speeds ranging from 500 to 3975 RPM. With a 1"x8" tpi headstock spindle and a No. 2 Morse taper on both the head and tailstock, this lathe will accept a variety of accessories. Comes standard with 5" tool rest, live center for tailstock, 3" face plate, and spur center.

Mini-Lathe Accessories:

#709160	3 Piece Pen Making Chisel Set	\$ 79.99
#709163	5 piece Mini-Chisel Set	\$ 84.99
#709010	Gold Ball Point Pen Kit	\$ 7.99
#709011	Gold Pencil Kit	\$ 8.99
#709015	Mont Blanc Style Pen Kit	\$ 10.99
#709013	Mont Blanc Style Letter Opener	\$ 12.99
#709024	5 Piece Exotic Hardwoods Pen Blanks	\$ 12.99
#709019	HUT Finish	\$ 9.99
#709014	7mm Pen Mandrel MT #2	\$ 19.99
#WSUT1	1 oz. Insta-Cure Glue	\$ 6.40
#709021	7mm HSS Twist Drill Bit	\$ 6.99
#709123	"Pens From The Wood Lathe" Book	\$ 12.99
#709016	Maple Double Slot Display Box	\$ 4.99
#709017	Walnut Double Slot Display Box	\$ 5.99
#709018	Bubinga Double Slot Display Box	\$ 7.99

Shapers

Jet 1 HP Wood Shaper

- Powerful, reversing, 1 HP, single phase motor
- Two reversible spindle speeds, 7,000 & 9,000 RPM
- Mitre gauge and dust chute are standard
- 1/2" & 3/4" interchangeable spindles • 1/2" & 1/4" router collets included
- Two year limited warranty!



#JWS-18HO
\$ 499.00



Jet 1-1/2 HP Wood Shaper

Powerful, reversing, 1-1/2 HP, single phase motor. Two reversible spindle speeds, 7,000 & 9,000 RPM. Comes standard with mitre gauge, 4" dust chute, 1/2" & 3/4" interchangeable spindles, 1/2" & 1/4" router bit collets. Net weight 190 lbs. Two year limited warranty!



***Order before March 31, 2001**
and receive a **\$149.00**
12-piece carbide-tipped
router bit set FREE!

#JWS-22CS
\$ 699.99



Band Saw Blades



Swedish Band Saw Blades

These silicon carbide blades with their milled teeth, are designed to give you the absolute cleanest cuts. The thin kerf design means less waste and greater maneuverability. Low tension gives you more power and creates far less wear and tear on your saw. Available in a variety of widths for everything from resaw to sweeping turns to craft cuts, and in lengths to fit most band saw makes and models.

Part #	Length	Width TPI	Price
80x1/8x14T	80" x 1/8"	14	\$27.50
80x3/16x10T	80" x 3/16"	10	\$21.45
80x1/4x6T	80" x 1/4"	6	\$20.40
80x3/8x6T	80" x 3/8"	6	\$21.45
80x1/2x4T	80" x 1/2"	4	\$22.20
93.5x1/8x14T	93-1/2" x 1/8"	14	\$29.95
93.5x3/16x10T	93-1/2" x 3/16"	10	\$23.30
93.5x1/4x6T	93-1/2" x 1/4"	6	\$22.15
93.5x3/8x6T	93-1/2" x 3/8"	6	\$23.30
93.5x1/2x4T	93-1/2" x 1/2"	4	\$24.20
93.5x3/4x3T	93-1/2" x 3/4"	3	\$32.35
105x1/8x14T	105" x 1/8"	14	\$32.45
105x3/16x10T	105" x 3/16"	10	\$25.20
105x1/4x6T	105" x 1/4"	6	\$23.90
105x3/8x6T	105" x 3/8"	6	\$25.20
105x1/2x3T	105" x 1/2"	3	\$26.20
105x1/2x4T	105" x 1/2"	4	\$26.20
105x3/4x3T	105" x 3/4"	3	\$35.35

Maggi Steff 3-Speed Stock Feeder

This light duty stock feeder is ideal for the small shop and will deliver the performance found in the larger units at a very affordable price.

#OM312
(Single Phase) \$ 465.00

SPECIFICATIONS:

Feed Speeds	13, 19.5, 23 & 29 FPM
Number of Wheels	3
Roller Suspension	0.6"
Vertical Adjustment	9-3/4" to 15"
Horizontal Adjustment	5-1/4" to 9-5/8"
Weight	Net 26 lbs. Shipping 30 lbs.
Motor	0.25 HP, Single Phase, 115 volt



Optional Accessory

#34200001 Extra Cast Iron Base \$100.00

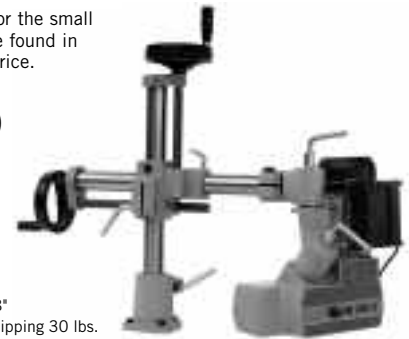

Board Buddies™ For The Shaper

These green wheels rotate in both directions for reversible shaper operations. Just mount these Board Buddies™ to your fence and simply adjust for a variety of wood thickness and hold down pressure. Plus, with the addition of an optional track, there is variable adjustment for precise positioning along the shaper's fence.

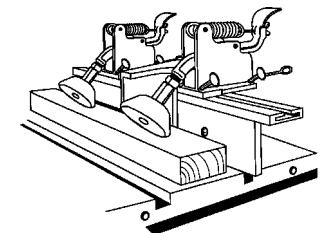

Optional Tracks

#W1105	\$36.95	#W1107	12" Track	\$11.95
		#W1108	24" Track	\$18.95

The Shaper Handbook

Woodworkers will welcome the exhaustive coverage the authors give this valuable machine. Written by Cliffe and Holtz. Softcover 256 pages. This is a "must have" book for woodworkers who own, or operate wood shapers.

6798-6 \$17.95



Welded to Size Bandsaw Blades

Don't see your blade size above? We also custom weld blades to your specifications. Our MORSE blade stock is hard edge flexible back band, which is an alloy carbon steel with a specially hardened edge and a resilient, flexible back. Simply give us the desired blade width, teeth per inch, and blade length and we'll do the rest!

Bandsaw Blade Prices

1/4"	Blade Width	\$1.15 per foot
3/8"	Blade Width	\$1.25 per foot
1/2"	Blade Width	\$1.30 per foot
3/4"	Blade Width	\$1.75 per foot
1"	Blade Width	\$2.20 per foot

Table Saw & Accessories

General International 10" Deluxe Builder's Tablesaw

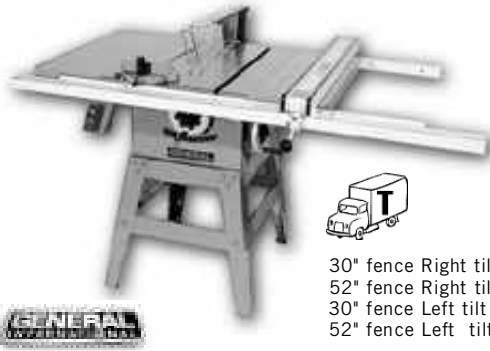

Heavy duty precision cast iron ribbed table with T-slots for mitre gauge has two solid cast iron extension wings. The 30" or deluxe 52" rip fence system makes quick and precise adjustments. A 2 HP, 115/230V, 1 phase motor provides plenty of power, with a prewired 230V motor to switch connection for easy setup. 4" dust collection outlet, dado insert, and deluxe cast iron miter gauge is included.



- 30" fence Right tilt saw #50-175-M1 **\$ 719.00**
- 52" fence Right tilt saw #50-175L-M1 **\$ 749.00**
- 30" fence Left tilt saw #50-185-M1 **\$ 719.00**
- 52" fence Left tilt saw #50-185L-M1 **\$ 749.00**

Feather Board



This wood feather board will keep your stock tight against the rip fence and down on the table during ripping operations giving you more control. Will fit in standard 3/4" wide mitre slots.

#19134

\$ 15.95

Deluxe Feather Board

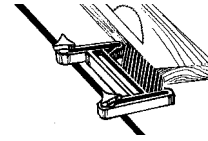

Our plastic featherboard keeps stock up against the fence on tablesaws, shapers, router tables, etc. Fits in standard mitre slots.

#10215

\$ 9.95

Biesemeyer T-Square Saw Fence Systems



Biesemeyer T-Square saw fence system fits any new or used table saw, making it a faster more efficient woodcutting tool. The T-Square's hairline pointer and built-in tape allow you to make precision setups, cut after cut. The fence locks only at the front of the tablesaw. Its three-point locking system ensures that the fence will be precisely parallel to the blade and will provide a smooth, clean cut accurate to 1/64th of an inch. All parts are constructed of rugged material for many years of dependable use. Designed and warranted for commercial users who rely on their tablesaw on a daily basis and cannot afford poor results. This system will provide 50" cut capacity to the right of the blade and 12" to the left side of the blade.

#78-900

\$ 359.00

Biesemeyer Super Fence Systems

Same high quality features as the commercial fence system but designed for the home hobbyist and small cabinet shop's budget. Purchase the fence you need by the right of the blade capacity. (Not warranted for commercial use).



- #78-930 12" Left/28" Right Capacity **\$ 259.00**
- #78-931 12" Left/40" Right Capacity **\$ 269.00**
- #78-935 12" Left/52" Right Capacity **\$ 279.00**

Tapering Jig

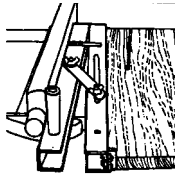

Cut tapers with ease when using this jig on your tablesaw, band-saw or radial arm saw. Converts to left or right hand use and is adjustable up to a 15° taper. Very easy to use and constructed from aluminum.

#19066

\$ 19.95

Safe "V" Shoe

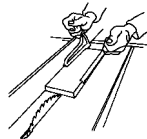

Unique because of a bottom groove that applies pressure down and in towards the fence. Made from high density plastic. Sold per pair.

#10223 **\$ 7.95**

Delta Sliding Jig



Provides greater accuracy and safety when cutting angled tenons, straight tenons, and dados on either left or right-tilted table saws. Fits standard 3/8" x 3/4" miter gage grooves.

#43-188

\$122.15



Zero Clearance Table Saw Inserts

- #DL-1U 13-3/8" x 3-3/4" Delta Universal **\$ 21.95**
- #JT-1 12-1/2" x 3-9/16" Jet/Powermatic 64 **\$ 21.95**
- #JT-2L1 13-5/16" x 3-11/16" Jet XACTA Left Tilt **\$ 22.95**
- #PM-1 14-7/16" x 4" Powermatic 66 **\$ 21.95**
- #GE-1 13-13/16" x 3-1/2" General #350 **\$ 21.95**

The Zero Clearance concept is simple; the blade cuts its own perfectly sized slot by being raised through a machinable "blank" insert. Inserts are 1/2" thick high-density phenolic laminate, with bonded laminate surface-offering superior rigidity, flatness, durability, and low friction. User friendly features include top-accessible leveling screws, lateral adjustment screws for a vibration free fit, rear anti-lift pin (except JT-1) and a precut blade pocket on bottom that provides clearance for fully retracted blades and bevel cuts. Instructions included. Use only carbide tipped blades. Colors may vary.

Magnetic Featherboard

NEW!



Powerful magnets hold the Grip-Tite guide solid to any cast iron or steel tabletop. As a board is pushed between the Grip-Tite guide and the fence, flexible polycarbonate feather blades force the board down and against the fence. Narrow boards can be cut, shaped, or jointed without putting your hands near the blade.

#GRIP-TITE

\$ 34.95

Push Stick

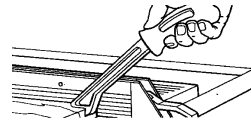

Specially designed handle for comfort and grip. Sold individually.

#10221

\$ 4.95

Anti-Kickback Mechanism



These safety colored yellow rollers rotate clockwise for tablesaws and prevent dangerous kickback. Also maintain even pressure against the saw table and fence so that ripping long boards is a very easy operation. If you work alone, this table saw accessory will really speed up your ripping operations while providing a higher degree of safety for the operator. Optional track makes adjustments a breeze. Sold in pairs.

#W1104

\$ 36.95

Saw Gauge

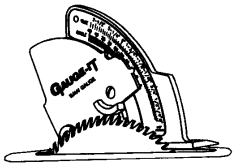

This useful and quick acting gauge will allow you to measure the blade height of your table-saw or the angle the saw is set to in a matter of seconds! Use the left tilting version for left tilt saws, the right tilt version for all others.

- #338-2500 (LH Version) **\$ 28.20**
- #338-2000 (RH Version) **\$ 28.20**

9-in-1 Saw Aid Tool



Of course it works like (1) a safety push stick, with a long, narrow hold-down surface. But this tool also works as: (2) a table saw depth gauge, (3) router depth gauge, (4) 6" hook rule, (5) 30°/60° angle gauge, (6) 45° angle gauge, (7) 9" rule, (8) 90° engineers square, (9) center finder. The depth gauges and center finder are accurate to .005"; engineers square is accurate to .01". Heavy-duty, glass-filled-nylon tool is guaranteed for 5 years against breakage!

#19107

\$14.95

FREIGHT NOTES



Extra freight charges apply.



Heavy machine motor freight charges apply.

Freud "Thin Kerf" Carbide Tipped Blades



Freud's "Thin Kerf" carbide tipped blades combine all the top features of their Industrial blades to give you a superior finished cut at an extremely affordable price. All these blades feature Freud's exclusive anti-kickback shoulder design for greater safety. The

thin kerf requires less cutting power both from you and the saw. Order number, blade diameter, bore and number of teeth are listed.

Trim Saw Blade

#TK001 4-3/8" 20mm/3/8"36 T \$26.65

Decking/Framing Blade

#TK103 7-1/4" 5/8"-Dmd 16 T \$15.95

Framing Blades

#TK203 7-1/4" 5/8"-Dmd 24 T \$22.15
 #TK204 8" 5/8"-Dmd 24 T \$22.85
 #TK206 10" 5/8" 24 T \$28.55

Finishing Blades

#TK303 7-1/4" 5/8"-Dmd 40 T \$27.55
 #TK304 8" 5/8"-Dmd 40 T \$28.30
 #TK306 10" 5/8" 40 T \$34.25

Fine Cutoff Blades

#TK406 10" 5/8" 60 T \$41.60
 #TK806 10" 5/8" 80 T \$55.70
 #TK407 12" 1" 72 T \$59.20

General Purpose Combination Blades

#TK903 7-1/4" 5/8"-Dmd 30 T \$23.95
 #TK904 8" 5/8"-Dmd 35 T \$26.10
 #TK905 9" 5/8" 40 T \$33.75
 #TK906 10" 5/8" 50 T \$38.70

Compound Mitre Saw Blade

#TK604 8-1/2" 5/8" 60 T \$44.55
 #TK606 10" 5/8" 60 T \$49.25

Blade Stabilizers

#SC-001 2 each 3-1/2" x 5/8" \$16.85

Dado Blade Sets

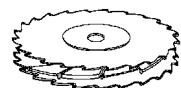

We offer a selection of dado blades to suit your pocket book. Generally speaking, the more you pay, the better quality you get.



Fine Dado Sets - For commercial quality dado cuts in solid woods and wood grain materials. Stackable to 13/16" wide.

Order #	Dia.	Bore	Teeth	OUR PRICE
#1710	6"	5/8"	16	\$129.95
#1740	8"	5/8"	22	\$143.35
#1750	8"	1"	22	\$143.35

Super Fine Dado Sets - Provides absolutely smooth and perfect square bottom dado cuts in all woods and chip prone materials. Stackable to 13/16" wide.

Order #	Dia.	Bore	Teeth	OUR PRICE
#1755	8"	5/8"	42	\$256.75

Freud Safety Dado Sets

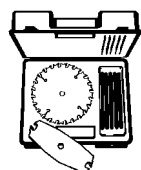

The secret is the shoulder. It is in front of every tooth and it limits the tooth's bite. There is almost no climbing, and kick back. This dado also cuts a smooth square bottom and tear-out is virtually non-existent. Includes 4 - 1/8" chippers and 1-1/16" chipper. Storage case comes standard.

Order #	Dia.	Bore	Teeth	OUR PRICE
#SD306	6"	5/8"	24	\$138.50
#SD308	8"	5/8"	24	\$147.75

Right Angle Jig



This amazingly affordable jig is constructed using top quality aluminum castings and plates which are machined to exacting tolerances. It has the perfect weight-use ratio to dampen vibration, yet is still light enough to easily slide the workpiece through the machining process. Cut tenons, dados, rail ends, and finger joints safely and with complete accuracy.

#W1500 \$169.95
 Shown with optional 6" Vise Clamps - #W1301 \$12.95ea

Delta Tenoning Attachment

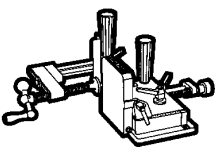

Delta has taken the standard tenoning jig and made it better! More adjustments, better holding power and cast iron construction provides stability. Great for cutting tenons on large projects!

#34-183 \$106.95

Clamping Miter Gauge

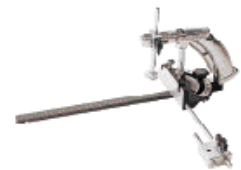

Our Clamping Miter Gauge is safer than standard miter gauges. It has a comfortable D-handle grip, built-in sliding stop, and positive trigger clamping action. It fits standard miter

gauge slots, 3/8" x 3/4", with positive angle stops at 90° and 45° both left and right side. Bar extends to 12"

#W1323 \$39.95

Incra Miter Gauge



Incra's famous incremental accuracy is now available on their new miter gauge. Whether it's your basic 90 degree cut-off, simple picture frames, complex compound miters, or a 20-sided object, the Miter Gauge by

Incra delivers perfect, repeatable accuracy without trial and error setups first time, every time, at every angle. Features include a 27" fence, positive angle stops every half degree, zero sideplay anti-friction sliding miter bar, and "Shop Stop" incremental stop positioner.

#MITER2000/27 \$184.95

Jointer' Clamp



Here is a simple, inexpensive solution for precisely putting a straight edge on any warped or crooked stock, all in one pass on your table saw without using a jointer. Will also do shallow taper cuts with superior control of the stock

#121000 \$15.95

10" Sanding Disc



Square-up stock, smooth and square miter or end cuts...and do it all right on your table or radial-arm saw. For small, angled pieces, and end grain, it's a quick finish. With our hardened, tempered-steel discs, your

10" table saw or radial arm saw can work like a high performance disc sander, with a big table for easy workpiece feeding. Use your miter gauge for perfect control. Arbor hole is 5/8" to fit most 10" saws. Sanding discs are tough, aluminum oxide for fast, clean sanding.

#56-895 \$18.95
 #56-897
 60 Grit, Self-stick, Replacement Discs (2pk) \$3.99
 #56-899 \$3.99
 100 Grit, Self-stick Replacement Discs(2pk)

General International 6" Jointer



#80-100L-M1
 \$549.00

The biggest 6" jointer on the market. Features an extra-long 55-1/4" precision ground bed, rabbeting ledge, 3 knife cutter-head, and a center mounted precision ground fence. 3/4HP, 1 Phase 115V motor is housed in an enclosed steel base with 4" dust outlet.

Magnetic Jointer Knife Setting Jigs



This knife setting system allows you to get jointer knives in perfect alignment every time. It also allows you to shift nicked knives to get a perfect cut to an accuracy of ± .001". For 4" to 8" jointers with HSS knives.

#W1211 Steel Body Jig \$49.95
 #W1210 Polycarbonate Body Jig \$29.95

Push Blocks



Our push blocks are constructed of high-impact molded plastic with natural rubber friction pads that grip the workpiece firmly. Woodworkers can work with confidence knowing that these blocks are between their fingers and the cutting tool. Bright, safety-orange color makes them easy to find and reminds woodworkers that safety comes first!

#W1400 Standard Push Block \$4.95
 #W1401 Large Push Block \$7.95

FREIGHT NOTES



Extra freight charges apply.



Heavy machine motor freight charges apply.

Sanders

Performax "16-32 Plus" Drum Sander

From the premier drum sander manufacturer, we are very pleased to offer one of the most innovative machines to come along in years! The 5" x 16" extruded aluminum, precision machined and balanced, self-cooling drum operates at 1700 RPM with a 1HP direct drive, continuous duty motor. Performax's "no-give" power feed conveyor is an integral part of the 16-32 PLUS. The durable, thin abrasive belt and the reinforced steel bed provides a rigid surface to precisely sand stock to within .010" uniform thickness. With a variety of abrasive grits, and an infinitely variable feed rate of 0-10 feet per minute, you have the flexibility to surface, dimension, and finish sand your material all in one machine! Comes with an 80 grit abrasive already mounted on the drum.

***Order before April 30, 2001 and receive FREE Infeed/Outfeed Tables, FREE box of Ready-to-Wrap sandpaper and FREE Tracker Kit!**

SPECIFICATIONS:

Maximum Width (in Two Passes) 32"
 Maximum Material Thickness 3"
 Minimum Material Thickness 1/16"
 Main Sanding Motor 1 HP, 115 Volt, Single Phase
 Conveyor Motor 1/30 HP, Infinitely VS

Optional Accessories

Stand for 16-32+
#608002 \$ 50.00

Locking Casters (4 each)
#98-0130 \$ 88.00

Ready-to-Wrap Abrasive Strips (4 strips per box)
 36, 60, 80, 100, 120, 150, 180, or 220 grit boxes

Specify Grit **\$ 26.95**



(Shown on optional stand and casters)

***BONUS**
 with purchase before April 30, 2001

#16-32+ \$ 869.00

Jet 6" x 89" Horizontal Edge Sander

1-1/2 HP, single phase, 115/230 volt motor. Belt platen can be positioned vertically, horizontally or at any angle in between. Single lever belt tensioning, with micro-adjusting belt tracking mechanism. Includes 4" round dust port for efficient dust control, mitre gauge, removable fence, and horizontal back stop.



JET
#EHVS-80 \$ 669.00

Jet Oscillating Vertical Spindle Sander

Oscillating spindle action delivers swirl free sanding results every time. Large, trunnion mounted table for superior material support, conveniently located push button on/off switch, and the 10 different sanding spindles (included) will handle most of your contour sanding needs. The main spindle support runs in precision ball bearings and is oscillated by a heavy duty worm-and-gear mechanism. Comes complete with 10 spindles from 1/4" to 4", 2 spindle wrenches, and a 4" dust chute.

#JOVS-10 \$ 799.00



Abrasive Cleaning Sticks



Increase the life of new sanding belts and discs with our high quality abrasive cleaners. Simply press the cleaner lightly against moving sanding belts and discs to remove clogged-up pitch and sawdust. Available in two sizes for almost any cleaning application.

#W1305 1-3/8" x 1-3/8" x 8-1/2" **\$6.95 ea.**
#W1307 2" x 2" x 12" **\$7.45 ea.**

Delta 4" Belt / 6" Disc Sander

DELTA



This handy little sander is powered by a 1/3 HP, single phase, 115 volt motor. Features include a tilting die cast aluminum table that can be mounted on either the belt or disc unit, a belt that operates horizontally, vertically and at any angle in between, a handy threaded belt tracking control knob, and an integral dust spout for shop vacuum hook up.

#31-460 \$ 125.00

Delta 6" x 48" Belt/9" Disc Sander

DELTA



This unit has an adjustable belt which operates vertically, horizontally or at any angle in-between. Large 9" diameter abrasive disc is perfect for sanding large curves or rounding out sharp corners. Standard equipped backstop keeps wood in place. Power take-off spindle lets you add on the accessory flex shaft. Standard equipped T-handle wrench makes all the necessary adjustments. Features a 1HP, 120 volt motor, complete with stand.

#31-695 \$ 319.00

Delta BOSS Spindle Sander



Delta's Bench Oscillating Spindle Sander has a heavy duty direct drive, 1/4HP induction motor that runs smoothly and quietly at 60 SPM with a 7/8" stroke. Other features include built-in compartments for storing drums and sleeves, built-in dust collection system with 1-1/2" dust port, and an 18" diameter cast iron table. Includes 3/4" drum, 1/2" spindle and dust bag.

#31-780 \$ 199.00

Delta Spindle Sander Accessories

Sanding spindle kit includes 1", 1-1/2", 2" and 3" rubber spindle drums, abrasive sleeves, and table inserts.

#31-781 Sanding Spindle Kit **\$59.00**
#50-780 Steel Stand **\$64.80**

4-1/2" Abrasive Sleeves for Delta BOSS Sander

Description	Part No.	Price
1/2X4-1/2X80G	1/2" x80 Grit Sleeve	\$ 1.65
1/2X4-1/2X120G	1/2" x120 Grit Sleeve	\$ 1.65
1/2X4-1/2X150G	1/2" x150 Grit Sleeve	\$ 1.65
3/4X4-1/2X80G	3/4" x80 Grit Sleeve	\$ 1.80
3/4X4-1/2X120G	3/4" x120 Grit Sleeve	\$ 1.80
3/4X4-1/2X150G	3/4" x150 Grit Sleeve	\$ 1.80
1X4 1/2X80G	1" x80 Grit Sleeve	\$ 1.90
1X4 1/2X120G	1" x120 Grit Sleeve	\$ 1.90
1X4 1/2X150G	1" x150 Grit Sleeve	\$ 1.90
1-1/2X4 1/2X80G	1-1/2" x80 Grit Sleeve	\$ 2.00
1-1/2X4 1/2X120G	1-1/2" x120 Grit Sleeve	\$ 2.00
1-1/2X4 1/2X150G	1-1/2" x150 Grit Sleeve	\$ 2.00
2X4-1/2X80G	2" x80 Grit Sleeve	\$ 2.20
2X4-1/2X120G	2" x120 Grit Sleeve	\$ 2.20
2X4-1/2X150G	2" x150 Grit Sleeve	\$ 2.20
3X4-1/2X80G	3" x80 Grit Sleeve	\$ 2.60
3X4-1/2X120G	3" x120 Grit Sleeve	\$ 2.60
3X4-1/2X150G	3" x150 Grit Sleeve	\$ 2.60

FREIGHT NOTES



Extra freight charges apply.



Heavy machine motor freight charges apply.

Shop Supplies

Franklin Titebond Glue



Very light tan in color, once set becomes virtually clear. This is a ready to use aliphatic resin adhesive with exceptional strength that is easily sanded, resists moisture and sets fast. Similar to white glue, it was specifically designed for people who work extensively with wood.

#506-4	16 oz.	\$ 4.15
#506-5	Quart	\$ 6.50
#506-6	Gallon	\$ 14.25

Franklin Waterproof Titebond II Glue



Designed for use where exposure to moisture is possible. It will maintain a positive glue bond even when exposed to rain! Ideal for outdoor furniture construction, bathroom cabinetry and kitchen cabinetry.

#500-4	16 oz	\$ 4.95
#500-6	Gallon	\$ 17.80

Polyurethane Wood Glue



This glue is 100% waterproof, gap filling (expands as it dries), sands and scrapes like wood, can be stained and painted, and it works in 30 minutes. It also features a low consumption rate compared to other adhesives, will not burn, soften, or clog sandpaper and is gentle on saw blades and other equipment. It is fully guaranteed and can be used on exterior or interior woods.

#EX50	50 ML	\$ 2.25
#EX250	250 ML	\$ 8.95
#EX750	750 ML	\$ 18.95

Glue Applicator

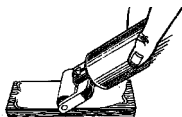

The wide roller dispenses glue evenly and uniformly to a wide variety of surfaces. Works very well for gluing large surfaces and works even better for edge gluing lumber.

# G-08	\$ 9.95
--------	---------

All Purpose Gluing Kit



Apply your adhesive with pinpoint precision into dowel holes, finger joints, dovetail joints, board edges, etc. Eight different nozzle attachments for a wide variety of application needs. Also includes a wide roller head for edge and face gluing applications.

# G-09	\$ 19.95
--------	----------

Glue Brushes



Great to have around the shop. Inexpensive enough to be disposable yet can be used over and over by simply cleaning after each use. Made from pure black horse-tail bristle, set in a handle with a bright, tin-plate finish

#130250	1/4" Glue Brush	4 for \$ 1.00
#13030	1/2" Glue Brush	4 for \$ 1.00
#D2026	50 Piece Assorted	\$ 9.95

"Hot Shot" Instant Glues



Very fast acting, these adhesives will bond just about everything. Carefully read the descriptions below and select the adhesive that best suits your needs. We also offer a sampler package below.

The Original "Hot Stuff" - Bonds clean and smooth surfaces. Setting time is incredibly fast at only 3 to 10 seconds.

#WHS1	1 oz.	\$ 6.40
#WHS2	2 oz.	\$ 11.10
#WHS4	4 oz.	\$ 21.10

Super "T" Glue - For filling small gaps between the surfaces to be bonded. Setting time is 10-15 seconds.

#WSUT1	1 oz.	\$ 6.40
#WSUT2	2 oz.	\$ 11.10
#WSUT4	4 oz.	\$ 21.10

Special "T" Glue - For filling large gaps and a longer open time. Setting time is about 20 to 50 seconds.

#WST1	1 oz.	\$ 7.25
#WST2	2 oz.	\$ 12.20
#WST4	4 oz.	\$ 23.35

"Hot Shot" Surface/Joint Cleaner & Accelerator - Speeds the setting time for almost instant bonding. Pump spray bottle.

#WNCF2M	2 oz	\$ 6.65
#WNCF5M	5 oz	\$ 11.10
#WNCF18M	18 oz. Refill	\$ 39.95

Ultra Super Solvent - Removes adhesives from hands, workpiece or wherever the glue was not meant to be.

#WUS2	2 oz.	\$ 6.65
-------	-------	---------

"Hot Shot" Replacement Tips - Sold per pack of 2 tips.

#WS2	\$ 2.20
------	---------

"Hot Shot" Sampler Packs - Each kit includes all three glues, 3 oz. of Accelerator, 2 oz. Solvent, 2 spouts with caps and the applicator tubing. Order by the glue quantity you desire.

#WSS1	1 oz. Set	\$ 32.95
#WSS2	2 oz. Set	\$ 46.75

Pitch and Gum Cleaner



This 18 oz. gum and pitch cleaner is great for cleaning saws, router bits, shaper cutters and other cutting tools. Very easy to use and works in minutes. Loosens build up on cutting tools so that it can be wiped away.

#SBC	\$ 5.95
------	---------

Woodworking Sprays



DriCote lets blades, bits and cutting tools work easier, and longer by coating the cutting edges with a micro-thin, extremely tough material that bonds with the metal to prevent build-up of resin and pitch.

TopCote dramatically reduces friction on

sliding parts and seals against rust and corrosion, dirt, dust, and moisture. **Bearing lubricant** allows router bit and shaper cutter bearings to stand up to heat and abuse. It can free a frozen bearing and keep dust out. All are silicone free and ozone friendly.

#204805	5.5 oz. Dricote	\$ 10.90
#204801	10.75 oz. Dricote	\$ 15.95
#205805	5.5 oz. Topcote	\$ 10.90
#205801	10.75 oz. Topcote	\$ 15.00
#209405	5.5 oz. Bearing Lube	\$ 13.90

Incra Precision Marking Rules



At first glance, you might think you are looking at an ordinary ruler. But look closer and you will see micro-fine marking holes and slots at every scale position to instantly locate a sharp pencil point or scribe exactly where you want it!

#RULE06	6" Marking Rule	\$ 7.50
#RULE12	12" Marking Rule	\$ 12.95
#PROTRAC06	6" Precision Protractor	\$ 24.50
#XY0603	6"x3" X-Y Marker	\$ 29.95
#CENTER12	12" Centering Rule	\$ 17.95

Incra Precision Bend Rules



Same marking precision found in a rule bent to 90°. Now you can mark the face and edge of your material in a single motion.

#BNDRUL06	6" Bend Rule	\$ 12.95
#BNDRUL12	12" Bend Rule	\$ 18.50

Incra Precision T-Rules



For perfect marking alignment, use this specialty T-Rule. Anodized aluminum edge coupled with a precision rule.

#T-RULE06	6" T-Rule	\$ 18.50
#T-RULE12	12" T-Rule	\$ 24.95

Incra Precision Rule Sets

Each set contains a precision marking rule, T-rule and Bend rule.

#IRSET06	6" Rule Set	\$ 38.95
#IRSET12	12" Rule Set	\$ 55.95

Boeshield Tool Care Kit



Specially designed to make all your tools last for years with this single care kit. One bottle removes resin gum and pitch from blades and bits; another removes rust and stains from any surface; and the third bottle prevents rust while it lubricates. Includes two 8.45 oz. pump bottles and one 12 oz. aerosol bottle.

#T904DP	\$ 16.95
---------	----------

FREIGHT NOTES



Extra freight charges apply.



Heavy machine motor freight charges apply.

Oversized Dust Pan

Hold flush to the floor to pick up large messes in one swoop. Measures 16" wide, and 10" deep. Made from aluminum to guard against corrosion.

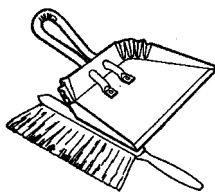

#DP16 \$ 10.99

Counter Duster (above)

This product was specifically selected to withstand heavy workshop use. Brush area measures 8" with a comfort grip handle. Use it to clean off bench tops, machinery, and tools.

#243727 \$ 4.95

Plastic Knobs For Making Jigs & Fixtures



Make fixtures easier, quicker and in some cases, safer to use. The knobs are hard, black plastic like those on industrial machines. Ratchet levers are spring loaded to remain engaged until you lift and disengage them. Ideal for work in tight spaces.

- | | | |
|------------------|----------------------------------|----------------|
| A #19702B | T-Knob with 3/8" -16 insert | \$ 1.19 |
| B #19301B | T-Knob with 1/4" -20 insert | \$ 1.09 |
| C #19710B | Star Knob w/1/4" -20 stud | \$ 1.19 |
| D #19712B | Star Knob w/5/16" -18 stud | \$ 1.29 |
| E #19705B | Star Knob w/1/4" -20 stud | \$ 1.19 |
| F #19706B | Star Knob w/3/8" -16 insert | \$ 1.29 |
| G #19714B | Star Knob w/3/8" -16 stud | \$ 1.39 |
| H #19726B | Ratchet Lever w/5/16" -18 bolt | \$ 3.59 |
| I #19727B | Ratchet Lever w/5/16" -18 insert | \$ 3.59 |
| J #19725B | Post Handle w/5/16" -18 insert | \$ 2.29 |

Versatile T-Track

The T-Track system will put a quick-acting clamping system at every work station in your shop! Create special jigs, positioners and hold-downs to suite your work and save hours of set-up time. Hold-downs have a 2-1/2" capacity and includes knob and 1/4-20 sliding bolt.

- | | | |
|---------------|-------------|-----------------|
| #16227 | 24" T-Track | \$ 14.95 |
| #16228 | 36" T-Track | \$ 16.95 |
| #16229 | Hold-Down | \$ 9.95 |

32" Aluminum Miter Track



Cut a 1" groove in your router table top, drop in this precision channel and screw in place. Fits your 3/4" x 3/8" miter gauge (without washer) perfectly!

#16210 \$ 13.95

Universal Mobile Base



With this set of brackets, you can custom make a mobile base exactly sized for your equipment. Simply cut hardwood rails (not supplied) to fit in the corner brackets. Three casters

provide superior mobility and a locking foot pedal locks the base firmly in place. Will handle machinery up to 300 pounds. Sold per set to make up one mobile base.

#50-345 \$ 58.15

Shop Fox Mobile Bases



Mini Mobile Base

600 pound capacity adjusts from 10-1/2" x 14-1/2" to 17" x 21-1/2"

#D2260 \$ 65.95

Heavy-Duty Mobile Base

600 pound capacity adjusts from 18-1/2" x 20" to 29" x 29"

#D2057 \$ 69.95

Super Heavy-Duty Mobile Base

1,200 pound capacity adjusts from 18" x 20-1/4" to 28-1/2" x 33-1/2"

#D2058 \$ 89.95

Extension Kit for D2260 and D2057 Mobile Bases

This kit will handle tablesaw extension tables with legs that are up to 44" away from the base.

#D2259 \$ 59.95

Pedestal Roller Stand

Adjustable from 26" to 43" high. Cast iron base. Roller measures 1-3/8" in diameter by 14" wide. Lock knob holds roller at selected height.



#S-3501C
\$ 39.95



Ball Roller Stand

Adjustable from 26" to 43" high. Cast iron base with leveling feet. Allows material to roll in any direction.



#S-1608
\$ 39.95

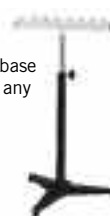

4-Point Roller Stand

This new and improved roller stand provides stability for every wood processing job. Welded square steel construction, variable height adjustment from 24-1/2" to 42" and flat storage make this the roller stand of choice. 13" wide ball bearing roller. 150 pound capacity.



#D2054
\$ 22.95



Delta Sharpening Center



Features cast iron construction to minimize operating vibration and a single phase 1/5 HP motor for a variety of sharpening jobs. Tool rest base supports the sliding tool holder for steadier, safer sharpening; adjusts for height and tool angle, and may be mounted to either the wet or dry wheel.

Water tank has adjustable water pressure knob for regulating water flow and wet wheel has front and rear splash guards for retaining water spray during operation.



#23-710
\$ 159.00

Optional Accessory:

Knife grinding attachment will secure Planer and Jointer knives up to 12" long during sharpening operations. May be used on wet or dry wheel.

#23-715 Knife Grinding Attachment \$ 59.95

Heavy Duty 5-Roller Stand

For greater work stability and support, this 5 roller stand features large diameter ball bearing rollers mounted on a sturdy adjustable pedestal base. Adjusts in height from 26-1/2" to 45". 15-7/8" wide ball bearing rollers. 250 lb. capacity.



#D2274 \$ 69.95



Tilting Roller Stand

Beefy rollers and sturdy adjustable base makes this stand ideal for handling or supporting any flat or round stock. Independent rollers adjust to any angle. Adjusts in height from 25-1/4" to 43-1/4". Rollers tilt from 0 to 45". 5-3/4" wide ball bearing rollers. 150 lb. capacity.



#D2272 \$ 42.95



Heavy Duty 9-Roller Table

Use this versatile roller table wherever you need extra work-piece support. Features all-steel welded construction and measures 19" wide x 65" long. Comes with 9 ball bearing rollers and has four independently adjustable legs for any leveling requirement. Adjustable in height from 26-3/8" to 44-1/8". Rollers tilt from 0 to 45". 5-3/4" wide ball bearing rollers. 1,000 lb. capacity.



#D2271 \$ 149.95



FREIGHT NOTES



Extra freight charges apply.



Heavy machine motor freight charges apply.

Rousseau Router Stand



The RM 3300 folding router stand is ideal for shop or job site use. Comes with an adjustable aluminum router fence and has the option of two height settings, 34-1/2" or 36". The high pressure laminate top measures 20" x 24" x 3/4" attached to a heavy 16 gauge sheet metal skirt. The design of the tubular steel legs with their large footprint, (26" x 27") combine to make this unit very stable.

ROUSSEAU
COMPANY



#RM3300

\$ 246.00

Bosch 2 HP Variable Speed Router

BOSCH



- 12 AMP • No load RPM 8,000-25,000 • 1/4" & 1/2" collets included • Exclusive Precision Centering System design; accurate, repeatable cuts at any depth setting.

#1617EVS

\$ 189.95

6-Piece Carbide Tipped Roundover Bit Set



This set includes four of the most popular sizes of roundover bits: 1/8", 1/4", 3/8" and 1/2".

D1062 1/4" shank \$ 39.95

6-Piece Carbide Tipped Roundover Bit Set



Complete set of roundover bit sizes with radius: 1/8", 1/4", 3/8", 7/16" and 1/2" (2ea). All sizes have a 3/8" guide bearing.

D2101

1/4" shank

\$ 49.95

8-Piece Carbide Tipped Straight Bit Set



Set includes these popular bit sizes: 1/8", 1/4", 13/32", 1/2", 19/32", 27/32" (2ea), and 15/16".

D2100

1/4" shank

\$ 31.95

5-Piece Carbide Tipped Router Bit Set



This edge forming set includes 1/2" Flush trim, 3/8" Roundover, 5/32" Roman Ogee, 45° Chamfer and 3/8" Rabbet. All have 1/4" shanks and come packed in a wooden storage box.

#D1063

\$ 37.95

Makes These Profiles!



12-Piece Carbide Tipped Router Bit Set



This convenient bit collection includes: 1/4" Straight, 1/2" Straight, 3/4" Straight, 1/2" 8° dovetail, 1/2" Radius Roundover, 1/2" Rabbeting, 1/2" Cove, 1/2" 90° V-Groove, 45° Chamfer, 1/2" Flush Trim, 11/32" Combination Panel, and 1/2" Roundover.

D2102

1/4" shank

\$ 59.95

Wood Visas

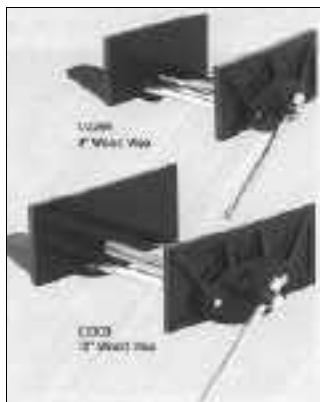

Durable cast iron and chrome plated, cold rolled steel wood visas feature precision machined castings with perfectly aligned guide bars. 8" Vise has 8" throat capacity and 10" vise has 9" throat capacity.

#D2255

8" Wood Vise

\$37.95

#D2303

10" Wood Vise

\$49.95

Belsaw Bench Stops

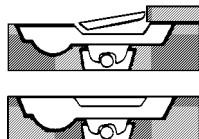

This stop is easily installed into your bench top. Turn the thumb screw to raise and lower. Very stable support. Made from a soft metal that will limit harm to cutting tools if they come in contact.

MJ-815

\$ 5.95

"No-Scuff" Clamps

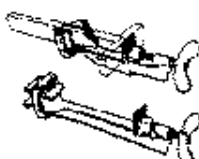

The right angle clamp (top illustration), is used to clamp assemblies perpendicular (like pulling a shelf into a dadoed cabinet side), and the regular profile is largely used to clamp face frames without scuffing. Light weight, they only weigh

about 1-1/2 lbs. each. Both clamps can eliminate the need for long bar clamps.

#D2268

Right Angle Clamp

\$14.95

#D2269

Face Frame Clamp

\$14.95

Bar Clamps

These "F-Style" clamps feature a quick positioning head that slides against the workpiece and then holds its position as clamping force is applied. Swivel handle provides tremendous leverage. 4" throat depth.



#D2231

8" Bar Clamp

\$ 6.95

#D2232

12" Bar Clamp

\$ 7.50

#D2233

16" Bar Clamp

\$ 7.75

#D2234

20" Bar Clamp

\$ 7.95

#D2235

24" Bar Clamp

\$ 8.95

#D2236

32" Bar Clamp

\$10.95

#D2237

36" Bar Clamp

\$11.95

#D2238

40" Bar Clamp

\$12.95

Pony® Pipe Clamp Fixtures



Make various clamp lengths by using common 1/2" or 3/4" black pipe. The multiple disk clutch locks the tail-piece at any point on the pipe for solid clamping results.

For even more added versatility, you can also purchase optional clamp stands and padded faces for your clamp fixture. Baked enamel finish. Pipe not included.

#05000

3/4" pipe

\$ 9.30

#05200

1/2" pipe

\$ 8.80

Clamp Pads

(for style 05000 & 05200 clamp)

#74560

\$ 3.50

Jorgensen® 4 - Corner Framing Clamp

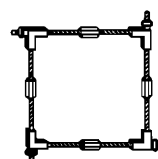

Applies equal pressure to the four corners of your picture frames, and casework to ensure that the frame is square and that the mitres match. Each corner's pressure can be individually set. # 94240 - Adjustable from 2" x 2" to 24" x 24". # 94480 - Adjustable from 2" x 2" to 48" x 48".

#94240

Small Clamp

\$ 11.25

#94480

Large Clamp

\$ 14.50

Clamp-N-Tool Guide

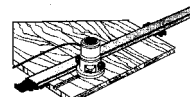

The only bar clamp available that also functions as an obstruction free straight edge. The short jaws apply a surprisingly high amount of clamping pressure and stay out of the way. Low profile and instant clamping, these clamps function very well when used as a straight edge for sawing, routing, scribing, and cutting.

#CT24C

24" Capacity

\$ 23.95

#CT36C

36" Capacity

\$ 27.95

#CT50C

48" Capacity

\$ 31.95

FREIGHT NOTES



Extra freight charges apply.



Heavy machine motor freight charges apply.



Mail Orders To:
THE BELSAW COMPANY
90 Karina Court
San Jose, CA 95131
Tel. (800) 468-4449

Order Toll-Free 1-800-468-4449
Fax In Your Order 1-408-441-1222
(24 Hour Fax Line)

ORDER FORM

If you need more room, please use a separate sheet of paper

Shipping And Handling:

Use this chart to calculate charges for items NOT shipped freight Collect, or items not subject to additional charges.

\$1.00 to \$40.00	\$ 7.00
\$40.01 to \$55.00	\$ 8.00
\$55.01 to \$100.00	\$ 10.00
\$100.01 to \$150.00	\$ 11.00
\$150.01 and OVER	\$ 14.00
COD ORDERS ADD	\$ 6.50

*Orders shipped to Alaska and Hawaii are subject to additional shipping charges.

**Certain items in this catalog are subject to additional shipping charges. If you are not sure what to add, please call.



Symbol represents **EXTRA** shipping charge due to the item being large or heavy.



Motor Freight Policy:

Items weighing over 70 lbs. are required to ship via motor freight. Freight charges will be calculated at the time the order is placed.

Rush Shipping Services:

UPS Next Day Air Delivery: The fastest method for shipping we offer. Orders received before 12 (noon) will be shipped out the same day. Shipping cost is \$ 20.00 in addition to our regular shipping charges as noted above.

UPS Second Day Air Delivery: Orders received before 12 (noon) will be shipped out the same day. Shipping cost is \$ 11.00 in addition to our regular shipping charges as noted above.

Three Day Select: Orders received before 12(noon) will be shipped out the same day. Shipping cost is \$ 8.00 in addition to our regular shipping charges as noted above.

Sales Tax: We are required by law to collect sales taxes. Please include the appropriate state sales tax along with any county and city taxes with your order for the states listed below. Failure to do so may delay your order.

California • Idaho • Nevada • Washington



Freight is a taxable item in the states of Nevada & Washington. If you live in these states, please figure your sales tax carefully.

Returns: We want you to be thoroughly happy with the products you purchase from The Belsaw Company. If you need to return an item for any reason, please contact our returns department for a return authorization and other instructions.

Customer Service: If you have any questions about your order or products you received, please ask for our customer service department and we will try to answer any questions you might have.

Sold To: (Please include the number above your name on the mailing label) Customer Number _____ Name _____ Address _____ City _____ State ____ Zip _____ Telephone _____	Please check here if your address has changed <input type="checkbox"/> Ship To: Name _____ Address _____ City _____ State ____ Zip _____ Telephone _____
-----------------------------------------------------------------------------------------------------------------------------------------------------------------------------------------	-------------------------------------------------------------------------------------------------------------------------------------------------------------------------

Order Number	Qty.	Product Description	Price Each	Total Price

Method Of Payment:
• Check Or Money Order • Visa/MasterCard • Discover / Novus Card • COD
Card No. _____
Your Bank Card Expiration Date: ____/____/____
Signature __X_____
  

Subtotal
Sales Tax (CA, ID, NV, WA)
Shipping (See Chart)
Express Shipping
Grand Total

Open Accounts: Available only to government agencies, institutions, public and private schools. Orders must be written on purchase orders with complete billing address noted. Request a credit application from The Belsaw Company's credit department.
Duplicate Catalogs: We make every effort to eliminate duplicate mailing labels. If you receive more than one catalog, we would appreciate your sending a label from each catalog to our order department.

Thank You for you order!

Rosette Cutterhead & Knives













For years, rosette cutters have been priced out of the reach of the average woodworker. That was until now! Finally, a manufacturer has taken the time to develop an affordable rosette cutter system to fill your needs. The HSS knives will produce the intricately-carved, rosettes up to 3" in diameter. Purchase the cutterhead and then select the interchangeable pattern you wish to carve. The 1/2" shank on the cutterhead is easily installed in your drill press and should be operated between 250-350 RPM for the best results.

Only **\$ 19.95 each**

Please note pattern number when ordering. Art not shown to scale.



Rosette Cutterhead Only
#W1250 \$ 29.95

 #W1256 • 2-5/8"	 #W1257 • 2-7/8"	 #W1258 • 2-11/16"	 #W1259 • 2-7/16"
 #W1260 • 2-11/16"	 #W1261 • 3"	 #W1262 • 2-1/2"	 #W1263 • 2-5/8"
 #W1264 • 3-1/16"	 #W1265 • 2-5/8"	 #W1266 • 2-1/2"	 #W1267 • 2-1/2"



THE BELSAW COMPANY
90 Karina Court
San Jose CA • 95131

Visit us on the
World Wide Web:
<http://www.belsaw.com>

The Belsaw Company is a
member of The CB Tool Group.

PRSRRT STD
 U.S. POSTAGE
 PAID
 SAN JOSE, CA
 PERMIT NO. 5187

Order Toll Free! 1-800-468-4449 *Mon.-Fri. 7:00am to 3:00pm Pacific Time*

Foam Brush Set



Disposable foam brush sets are ideal for all water and oil based stains and finishes. Each brush features wood handle and plastic stiffener for unsurpassed control. This brush set includes 10-1" brushes, 8-2" brushes and 6-3" brushes.

#D2031 **\$ 7.95**

Disposable Foam Brushes



50-Piece Bristle Brush Set



Environmentally friendly bristle brushes are inexpensive enough to throw away when finished, saving time and messy clean-up with water or chemical solvents. These solvents eventually end up as costly waste. Ideal for all painting chores.

#D2025 **\$ 17.95**

"Industrial Use" Vinyl Gloves



These quality vinyl gloves protect hands from paint, stains, and irritating cleaning solvents. They are great for other messy chores, such as automotive or farm work. Because these gloves are ISO-9002 Medical Grade, they are also perfect for non-sterile medical use. Each dispenser box contains 100 gloves which are powdered to make them easy to put on and remove. (Not approved for sterile medical use)

Each dispenser box contains 100 gloves which are powdered to make them easy to put on and remove. (Not approved for sterile medical use)



#D2029 Large **\$ 9.95**
 #D2030 Medium **\$ 9.95**

Delta Magnetic Work Light



Illuminate your work! The powerful magnetic base adheres to any steel surface providing extra light in hard-to-reach work areas. Great for automotive use and general workshop lighting. Features include a flexible 14" arm and an extra-long 8" cord. Uses up to 50-watt track light bulb (not included).

#25-869 **\$ 19.95**

New Magnetic Work Light

Oilstone Sharpening Kit



This all-in-one kit handles most woodworkers' honing chores. Includes one 8" combination (coarse/medium) aluminum oxide stone, a honing guide to ensure a proper bevel angle, a 1 oz. bottle of honing oil and a special non-slip rubber pad.

#D1118 **\$ 16.95**

Flex-Jaw Spring Clamps



Made from high strength, impact-resistant plastic with swivel jaws. Designed to apply uniform clamping pressure. Comfort grip handles.

#FJAW-1.5 1-1/2" Cap. **\$ 1.50**
 #FJAW-2.5 2-1/2" Cap. **\$ 2.35**
 #FJAW-3.5 3-1/2" Cap. **\$ 3.70**

Shop Tool Stand



700 lb. capacity

This tool table allows you to free up valuable work space by getting your smaller tools off your bench. A second shelf can be added to store other items.

#D2056 **\$ 39.95**

8 Piece Deluxe Plug Cutting Kit



This quality set features the most popular sizes of plug cutters make a smooth sided plug with rounded shoulders for easy insertion into a bored hole. The plug remains snug in the wood until sawed out or broken out with a screw driver.

#D2022 **\$ 39.95**

Safety Ear Muff & Eye Protection



All-in-one hearing and eye protection! Optimumuff is a hot new innovative combination of two of the industry's leading safety products. Eye protection is tested in accordance with ANSI Z87.1-1989. Noise reduction rating NRR 26 dB. Blue with red brow bar lens

#OM-77L **\$ 29.95**