

THE DENTAL  
SOLUTIONS  
COMPANY™



# The 3D x-ray family

[dentsplysirona.com](https://dentsplysirona.com)



## As versatile as practice life.

The Dentsply Sirona 3D x-ray family offers 3 units, Galileos Comfort Plus, Orthophos SL 3D and Orthophos XG 3D, whose visual possibilities cover the entire range of all specializations in dentistry. Which unit is the one for you and your practice? You can find out here!

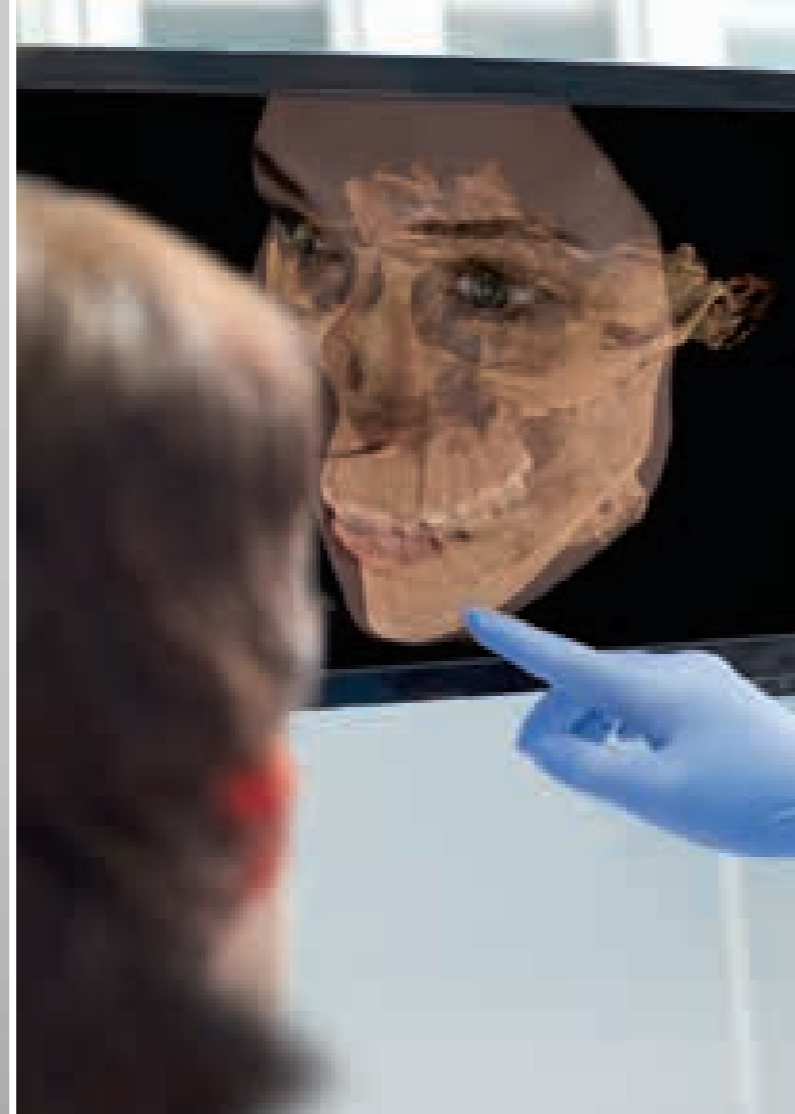



## The third dimension makes the difference

More precise diagnoses, clearer explanations: 3D imaging has many benefits. Be it overlaid teeth, unexpected nerve channel paths, concealed roots, or temporomandibular joint anomalies, 3D images are of inestimable value in a large number of diagnoses.

- 3D imaging increases your own diagnostic accuracy
- Better inclusion of the patients in planning
- No referral of your patients to specialists
- These units increase your practice services and your success



## Work quickly, precisely and reliably

Dentsply Sirona imaging units stand out for their simple operation and positioning, thus providing efficient workflows. The unprecedented image quality allows extremely precise diagnosis and planning. With Dentsply Sirona, you trust a global brand with hundreds of thousands of units in practice distinguished by their Made in Germany quality.



Optimum Workflow



Unparalleled  
image quality



Proven solution

## Flexibility and reliability with a low dose

The Dentsply Sirona 3D x-ray family combines high resolution image quality with great flexibility. Simply choose the best volume for your practice – this can be easily adjusted for the individual patient situation and will support your diagnosis with clear, sharp images with the lowest dose.



An overview of the volumes available in the Dentsply Sirona 3D family:

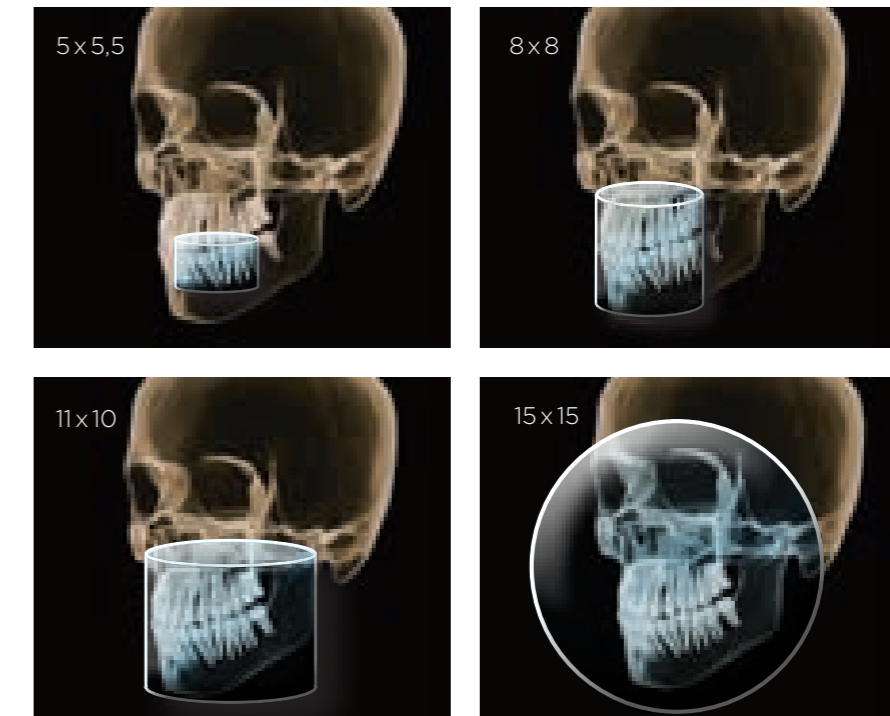

Other available volumes (varies according to the unit): 8 cm x 5.5 cm; 11 cm x 8 cm; 11 cm x 7.5 cm upper jaw; 15 cm x 8.5 cm upper jaw; 15 cm x 8.5 cm lower jaw.

More possibilities for your practice

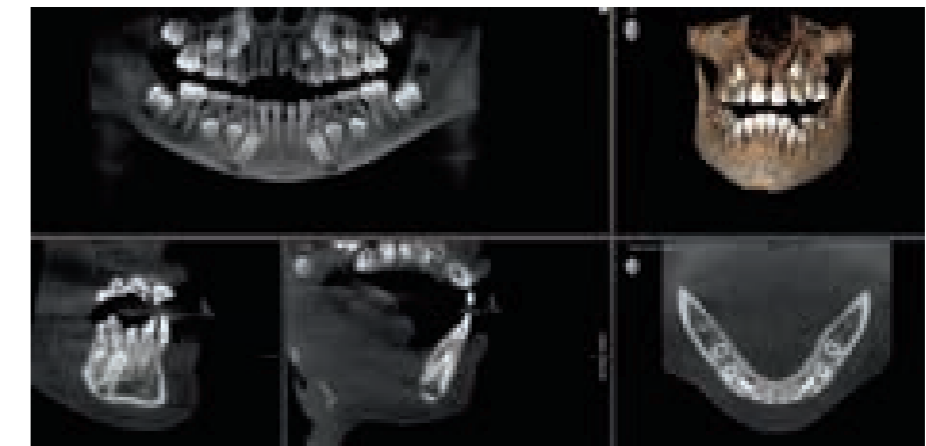

8 cm x 8 cm images taken in Low Dose with 15  $\mu$ Sv

The best image quality for all indications: In order for you to be ideally prepared for every case, the Dentsply Sirona 3D x-ray family naturally offers outstanding solutions for both 2D and 3D approaches. You gain additional flexibility in 3D thanks to the Low Dose mode, with which you can generate images at lower radiation dose comparable to the level of 2D x-rays depending on the indication.

## Easy operation, safe positioning

Dentsply Sirona offers unique patented solutions for operating the units and positioning the patients. Optimize your practice workflow with intuitive user interfaces and automatic positioning aids that eliminate unnecessary corrective scans and waiting times.



### The new positioning tools make for good imaging.

"Positioning with the Orthophos SL is very easy for our team. The many aids such as automatic light localizers, illuminated height adjustment buttons and intuitive program selection allow us to work efficiently with very good image quality. In combination with Sidexis 4, we have a comprehensive package that gives us absolute confidence in the findings."

PD Dr. Dr. Lutz Ritter, Oral and Maxillofacial Surgery, Hennef



### 1 Intuitive operation

No matter how your x-ray room is set up – the swiveling and tilting EasyPad makes it highly flexible and the clearly arranged buttons and symbols ensure optimum operation.

### 2 The patented occlusal bite block

Position the patient with the patented occlusal bite block. The unit automatically determines the correct tilt of the head and indicates it using corresponding symbols and colors – all you need to do is press the up and down arrows.

### 3 Stable positioning for high-quality images

Stable patient positioning prevents motion blurring. The motorized 3-point head fixation and stable handles give your patients the necessary support. At the same time, the EVI\* light localizers show you the patient's position in the volume. The integrated temple width measurement ensures an orbit specific to each patient and thereby results in high image sharpness.

\* EVI = Easy Volume Indicator



## Working digitally is this easy

### Sidexis 4 - this is the core of the digital workflow with Dentsply Sirona.

The software with its intuitive user interface has a very simple structure: it follows the clear format of your work processes and provides you at all times with all visual data of your patients seamlessly and at a glance - whether 2D, 3D or intraoral. This integrates your patients optimally and thus results in a high acceptance of your treatment proposal. Sidexis 4 is pure imaging efficiency, giving you a quick overview of the entire history of the patient. This allows you to add a time dimension to your diagnostic options in a very intuitive way. The lightbox is ideal for a comprehensive diagnosis, as it lets you compare 2D and 3D images as well as camera images and facescan data side-by-side.

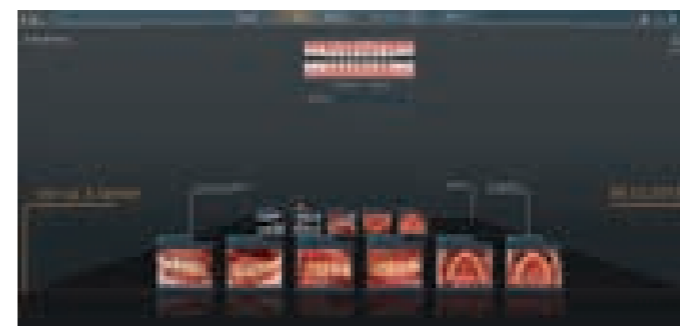

Simple overview of the patient history

## Advantages at a glance

- Modern design
- Software platform for all Dentsply Sirona x-ray units
- Intuitive operation, optimally coordinated workflows
- Simple overview of the patient history thanks to the intuitive timeline
- Easy export of DICOM data sets
- Interface of the integrated solutions from Dentsply Sirona

## The simple way to a completed implant

Software and hardware perfectly coordinated – that is Dentsply Sirona quality in implantation. With the support of the Galileos Implant software, prosthetic suggestions from the CEREC software can be combined with your 3D x-ray data. In this way you can enjoy absolute certainty in an efficient, time-saving workflow. And your patients can look forward to perfect results with fewer treatment sessions.

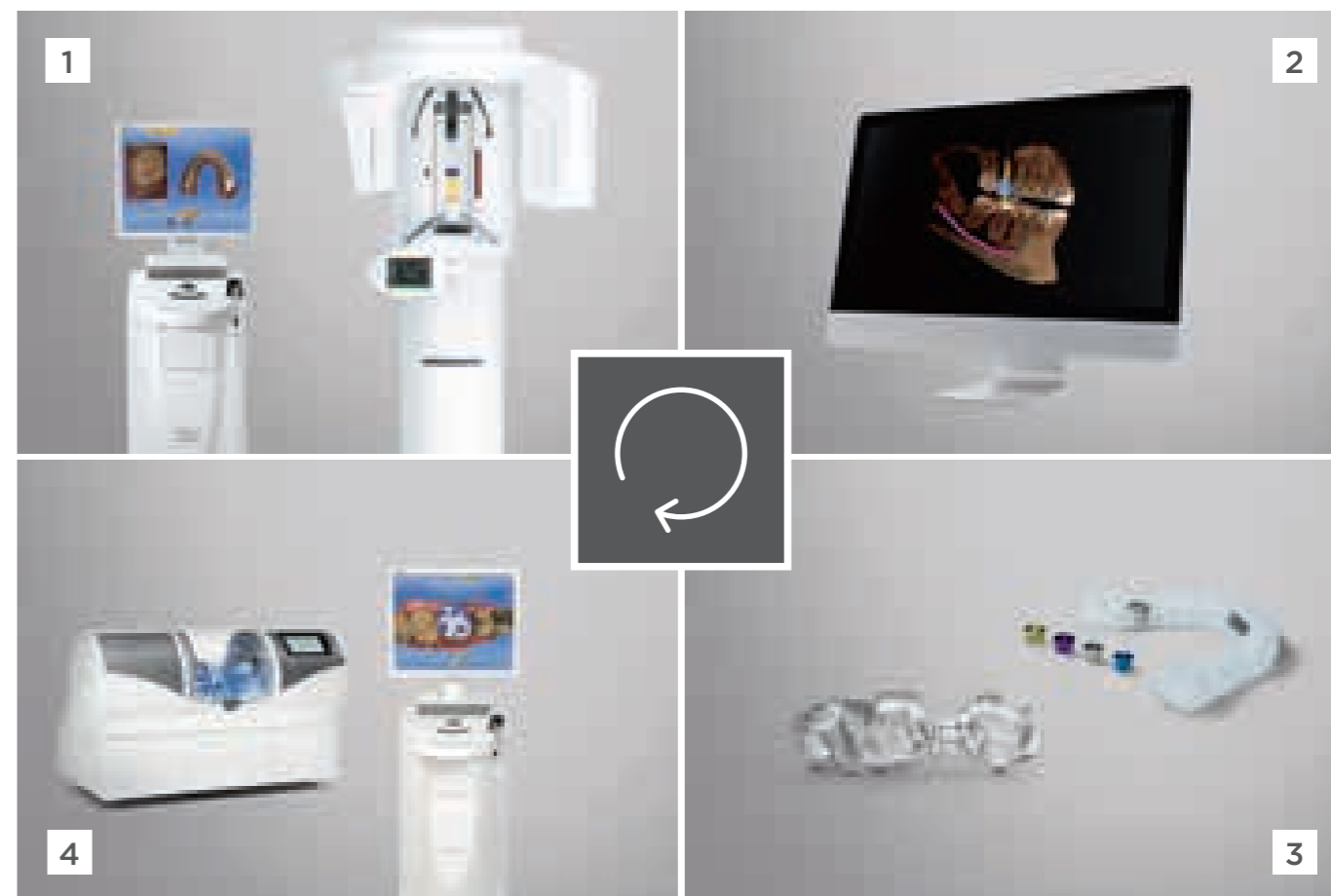

### 1. Session

**1 Scan:**  
In the first step, all of the necessary images for planning are prepared: Intraoral impressions for the prosthesis – 3D x-ray images for surgical planning.

**2 Plan:**  
The prosthetic suggestion and the x-ray data are combined in the software. On the basis of this combination, implant planning and the completion of the appropriate surgical guide follow.

### 2. Session

**3 Place:**  
Next, the implant is inserted securely and in an uncomplicated fashion using the surgical guide, which allows minimally invasive work. With CEREC Guide 2, Dentsply Sirona has the most convenient and quickest in-house surgical guide in the world. Or order your surgical guide from SICAT directly out of the software.

### 3. Session

**4 Restore:**  
In the final step, you plan the abutment and crown with the CEREC 4.5 software, which you then produce quickly and very precisely in your own practice with CEREC MC X or the MC XL Premium package. The crown is precisely fitted and this is monitored with either intraoral sensors or a 3D Low dose image.



## Extensive practice offering made easy

In addition to integrated implantology, Sidexis 4 integrates many other time-saving and convenient software solutions. For example, the SICAT Function offers a simple workflow for functional diagnosis and therapy of temporomandibular joint dysfunction. For the first time, a 3D solution is available that allows analysis of the upper airway and treatment of obstructive sleep apnea in a purely digital workflow thanks to the new SICAT Air software. Doing so, the dose can even be reduced to match that of 2D images.\*

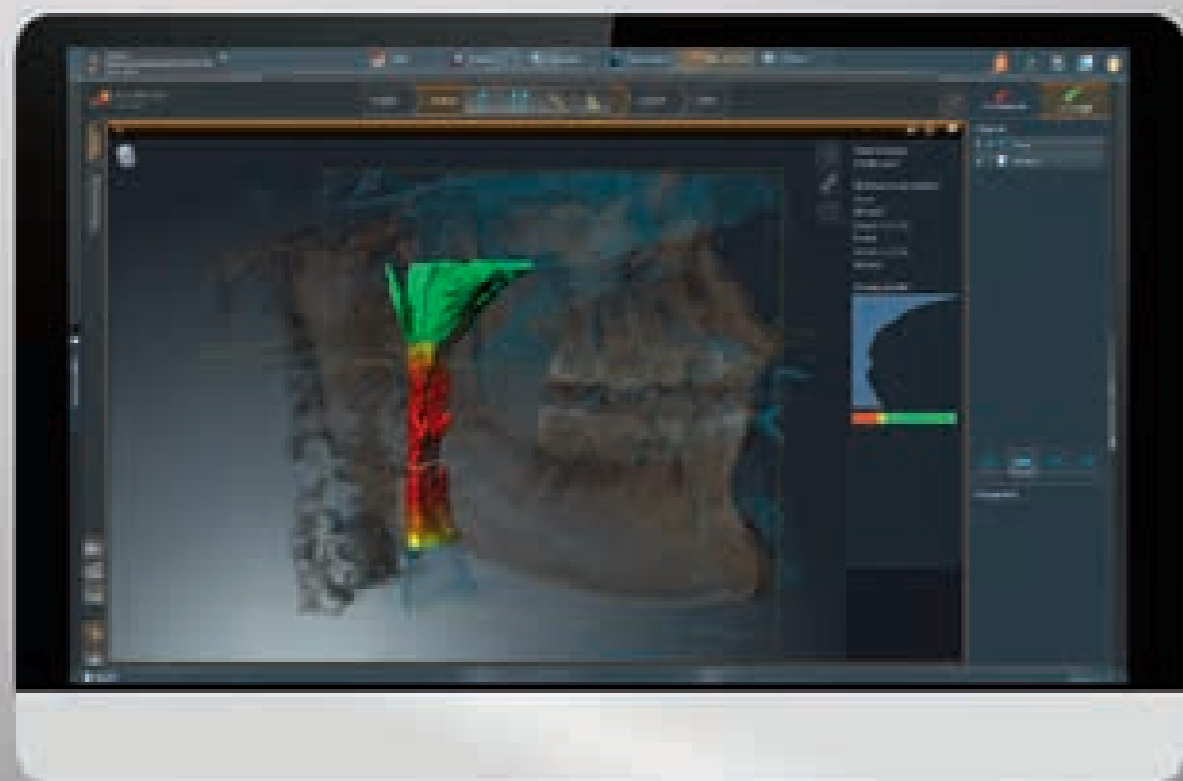

### SICAT Air and SICAT Optisleep

After analysis of the upper airway in 3D, SICAT Air gives a report on the effect of the planned protrusion degree and possible effects on the temporomandibular joint. Ordering an individual patient therapeutic appliance with Optisleep is done purely digitally.

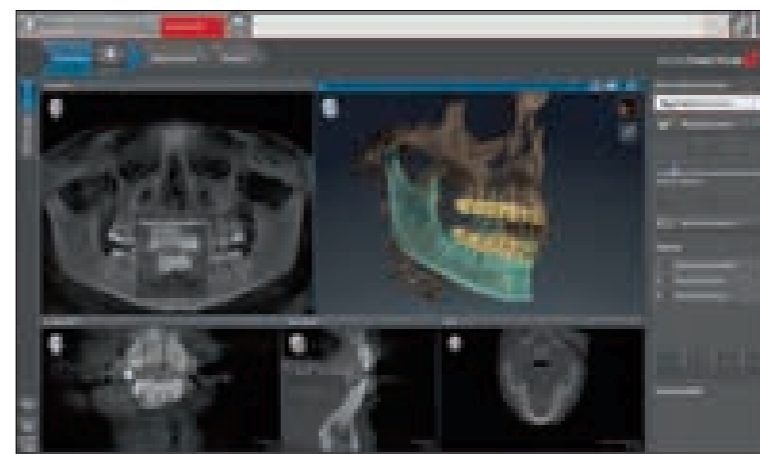

SICAT Function

### SICAT Function

For the first time, SICAT Function gives an anatomically correct view of the movement of the lower jaw of the individual patient in the 3D volume. Movement of the mandibular joint can be visualized for each point in the 3D volume.

### SICAT Function with CEREC

In combination with CEREC, you receive the actual articulation in CAD/CAM. The advantages: functional prosthetics with reduced grinding effort and implementation of new treatments.

### SICAT Optimization

SICAT Optimization is the world's first CMD therapeutic appliance that implements both the individual patient movements and the pure condyle-fossa relationship in the therapeutic appliance. Depending on the preference, the SICAT Optimization is completed purely digitally with SICAT.



1 Freedom in centric 2 canine guidance 3 Michigan principle

# Endodontics in the third dimension

Due to their unparalleled image quality Orthophos units are a great fit for all endodontic requirements. Together with 3D Endo™ they open up new dimensions for your practice. With a small 3D volume of 5 cm x 5.5 cm the Orthophos units are equipped with a perfect field of view for all endodontic cases. In combination with the High Definition (HD) mode you can expect extremely sharp images with an outstanding level of detail of up to 80 µm.

## Complex cases? Nothing left to hide?

3D Endo™, the first CBCT based software designed to improve endodontic treatment planning for more predictability. Plan for an optimal cavity access and your final instrument.

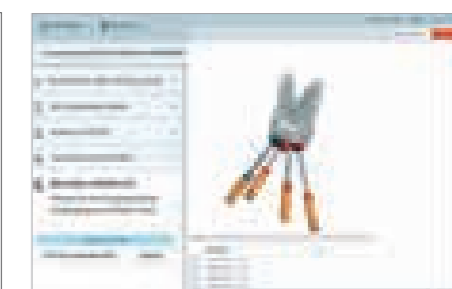
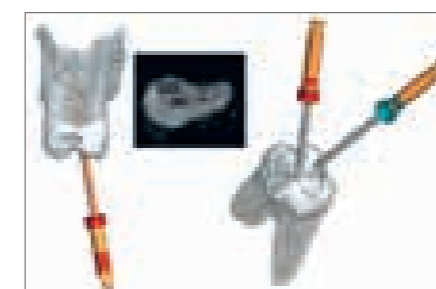

### Designed to improve treatment quality

- Isolate the tooth of interest
- Clearly visualize the tooth anatomy in 3D
- Identify all canals
- Anticipate risky areas

### Know what to expect

- Evaluate 3D working length and cavity access depth
- Locate canal orifices without opening the tooth
- Plan for an optimal cavity access and your final instrument
- Simple and consistent methodology for all cases

### An intuitive way to analyze CBCT scan data

- Simple and consistent methodology for all cases
- Know how to use the software in 30 min
- Quick & Easy to use

## Experience you can rely on

Around the world, over 100,000 extraoral imaging units from Dentsply Sirona have been installed in practices. They impress their users with their high German quality standards, proverbial reliability in use, and ease of operation. Reliable after-sales support and topical product training provide additional peace of mind.

Dentsply Sirona is a pioneer in the field of imaging. We have been establishing new methods for 120 years – but only when they really do provide a simpler solution to challenges and allow you to work faster, more safely and more economically – and all to the benefit of the patients. The ideas that our 200+ developers are pursuing are becoming products, on which you can absolutely rely in everyday practice thanks to our extensive experience. You notice it when you work with a Dentsply Sirona 3D x-ray unit. The workmanship is first-class – even Made in Germany. If you choose Dentsply Sirona, you choose a solution built on viable, sustainable products that represent a first-class technological solution not only today, but in the future time and again.



**"Made in Germany" quality and future viability:**  
At the Center of Innovation in Bensheim, Germany, Dentsply Sirona products are developed for the highest demands.



## Which unit is the one for you?

Frequency and type of use, specialization, price, and personal preferences – every dental practice has its own requirements for an x-ray unit. Here is a quick overview of which Dentsply Sirona 3D x-ray unit is right for you.

### Units at a glance

	Orthophos XG 3D	Orthophos SL 3D	Galileos Comfort Plus
General dentists	■	■	-
Orthodontic practice	■	■	■
Implanting dentist	■	■	-
Implantology practice	-	■ Orthophos SL 3D 11 cm x 10 cm	■
Oral and maxillofacial surgery	-	■ Orthophos SL 3D 11 cm x 10 cm	■
Radiology center	-	■ Orthophos SL 3D 11 cm x 10 cm	■
ENT practice	-	■ Orthophos SL 3D 11 cm x 10 cm	■
Functional diagnosis	-	-	■

■ Suitable.

## Exactly what you need

You will quickly find out which 3D x-ray unit fits best in your daily routine. Galileos Comfort Plus, Orthophos SL 3D or Orthophos XG 3D - high-volume DVT or hybrid unit: All units offer you many possibilities and can be integrated perfectly into your practice.



Galileos and I make a super team.

Dr. Dr. Dieter Hültenschmidt, Maxillofacial Surgery, Karlsruhe

"Its simple and time-saving operation means that it fits in very well in my practice routine and its great volume covers all relevant problem areas. Thanks to the great image quality and the 3D volume, I can give my patients the best possible advice. Without my Galileos, I would not be as successful today."



The allrounder for diagnostics.

Marcin Wojtunik, Specialist in oral surgery, Pfronten

"It is not only because of my interest in technology that I find the combination of direct conversion technology and the reconstructive sharp layer procedure in the Orthophos SL to be truly exciting. The resulting precise images work perfectly for interpretation. In combination with the volume selection in 3D, we have a universally applicable diagnostic partner for our practice."



Individualized x-ray diagnosis with reduced radiation is important to me.

Dr. Björn Ludwig, orthodontist, Traben-Trarbach

"As an orthodontist, I treat patients of all ages, whose treatment presents all kinds of x-ray requirements. The Orthophos XG 3D helps me with its variety of programs and possibilities for reducing radiation from 2D to 3D - for me, this is individual and practical x-ray technology."





# Galileos Comfort Plus

A magnificent 3D x-ray unit that is characterized by reliable results and has absolute flexibility, the simplest operation, and high resolution image quality.

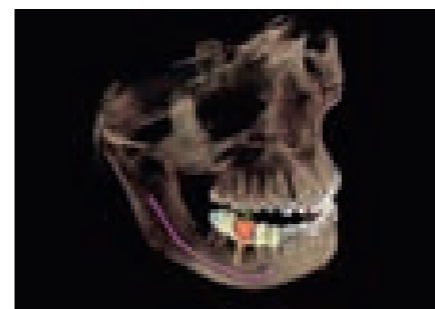

## Integrated Implantology

Integrated implantology reduces the number of sessions required to achieve a completed implant. With the Galileos implant software, you can combine the prosthetic suggestion from CEREC with the 3D x-ray data in order to make a simple plan for the implant.

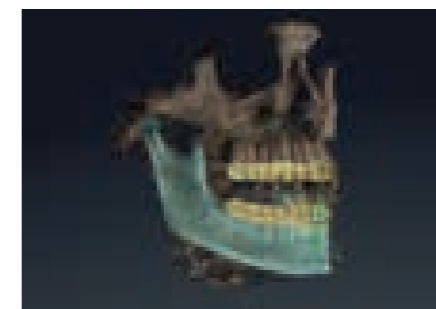

## SICAT Function

For the first time, the software for diagnosis and treatment of cranial mandibular dysfunctions gives an anatomically correct view of the individual patient movement of the lower jaw in the 3D volume.

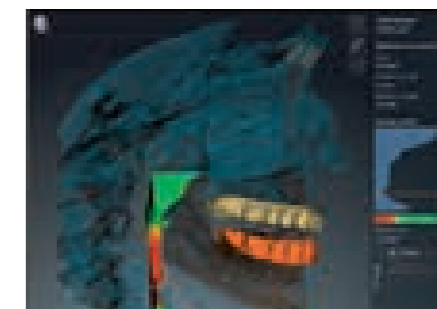

## SICAT Air

The software allows the analysis of the upper airway in 3D and supports efficiently in the planning of an appliance-based therapy of obstructive sleep apnea with Optisleep.

The Galileos Comfort Plus is the comprehensive package to meet the highest of demands with an extremely low dose and unparalleled reliability. At the same time the optionally integrated Facescanner offers every practice extremely up-to-date patient advice.

All this makes Galileos Comfort Plus not only a three time Townie award winner (2013-2015), but in fact the unit recommended by dentists.

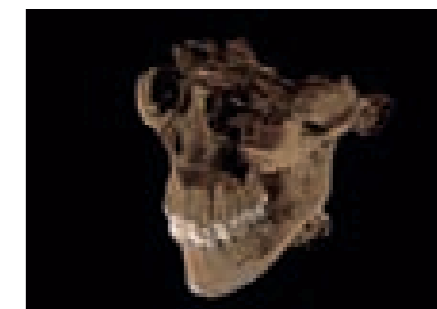
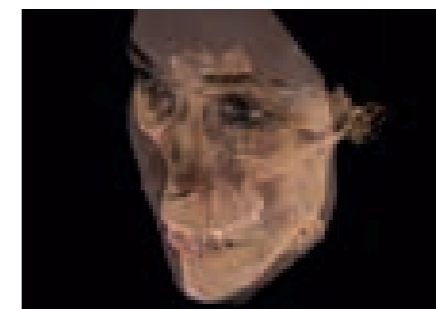
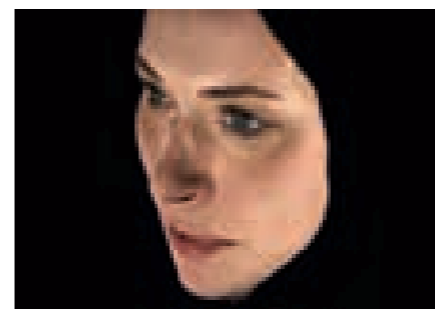

## Integratable Facescanner

While taking the x-ray image, the optionally integrated Facescanner plots the patient's facial surface. This realistic illustration makes your treatment suggestions for patients more understandable and builds confidence in your expertise.



A true all-in-one imaging unit. Unbelievably sharp 2D panoramic images, full flexibility in 3D volumes, and simple, dependable positioning of the patient for perfect images and optimal reproducibility – the Orthophos SL 3D simplifies the imaging workflow for your entire team.

# Orthophos SL 3D

Orthophos SL is the latest member of the successful Sirona 3D imaging family. It wins points for functionality, quality and design.

With the Orthophos SL 3D, your practice is extremely well prepared for various treatment situations. On the 2D side, the groundbreaking DCS sensor and SL technology satisfy the requirements of dentists with very high demands for panoramic imaging. In 3D, a variety of volumes allows you to adjust to the given indication with ease: whether it be 11 cm x 10 cm for the full dentition including wisdom teeth and upper airways, an 8 cm x 8 cm standard volume or a 5 cm x 5 cm for a targeted area of interest - meaning your practice is well prepared for all eventualities. Additionally you can flexibly define image parameters based on the indication from high definition to greatly dose reduced. The optional cephal arm provides detailed, high-contrast cephalometric images perfectly suited for orthodontic analyses and tracings. In combination with the pioneering Sidexis 4 software, the Orthophos SL offers a variety of innovative solutions for the practice workflow. Patients appreciate the soothing Ambient Light, which offers a choice of over 30 colors for a pleasant atmosphere in your x-ray room that fits perfectly into the look of your practice.

## Smart options for all practices

- 1 DCS and Sharp Layer technology**  
Thanks to DCS and SL technology, you not only get high-resolution panoramic images in the sharp layer, but can respond interactively within the image to special cases (lingually/buccally) – without additional imaging.
- 2 Variety of volumes**  
Whether the analysis of the upper airways, extracting wisdom teeth or the focused view of a dental area, the Orthophos SL 3D has a number of volumes for a broad spectrum of applications.
- 3 E(asy) V(olume) I(ndicator) light localizer**  
In order to make best use of the volume sizes, the EVI light localizer automatically indicates the patient's position in the volume.

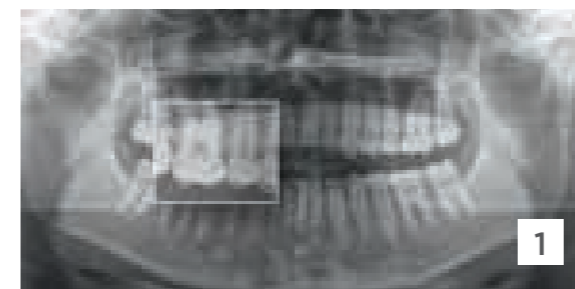

DCS and Sharp Layer technology

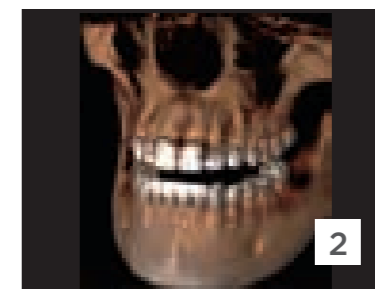

Variety of volumes

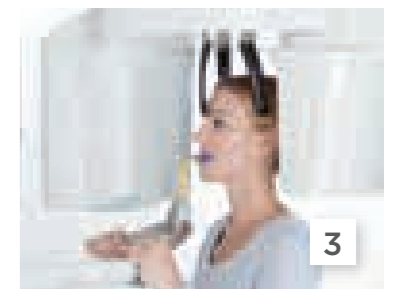

EVI light localizer



reddot award 2016  
winner

## DCS - Sharpness down to the smallest detail

Experience the future of panoramic imaging with the Direct Conversion Sensor (DCS)\*. x-rays are converted directly to electrical signals - in contrast to conventional systems there is no signal loss due to light conversion. Your advantage: Incomparable definition even at very low dose.

\* Only with Orthophos SL

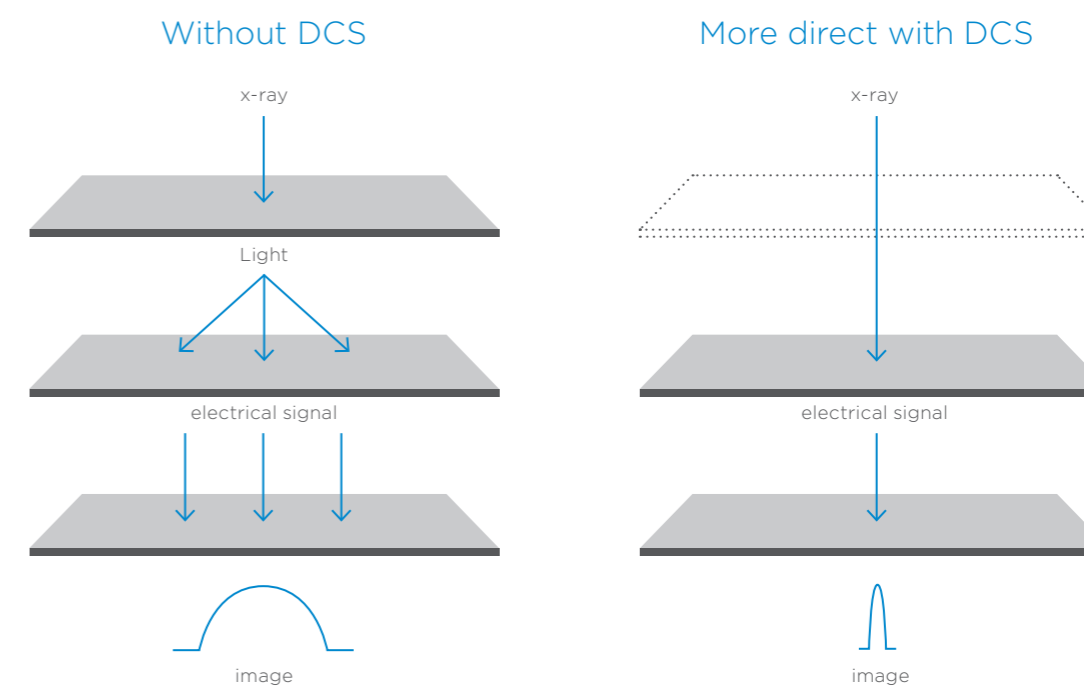

[dentsplysirona.com/dcs-technology](https://dentsplysirona.com/dcs-technology)

Learn more about our DCS technology on our website



## Low Dose: CBCT in a 2D image dose range

Indication-based diagnosis using CBCT images in the same dose range as 2D X-ray images is now possible with the Low Dose mode. It's optimized pre-filtering preserves dense structures such as bone even at a highly reduced dose, so it can be used easily and efficiently in many specialist fields, for example, orthodontics or implantology.

Your practice will be even more flexible, because depending on the patient case you decide: whether to use your Orthophos SL to obtain high-resolution, focused volumes for the finest of structures (HD), balanced images for general questions (SD), or Low Dose imaging for minimum radiation doses.

### Low dose application examples

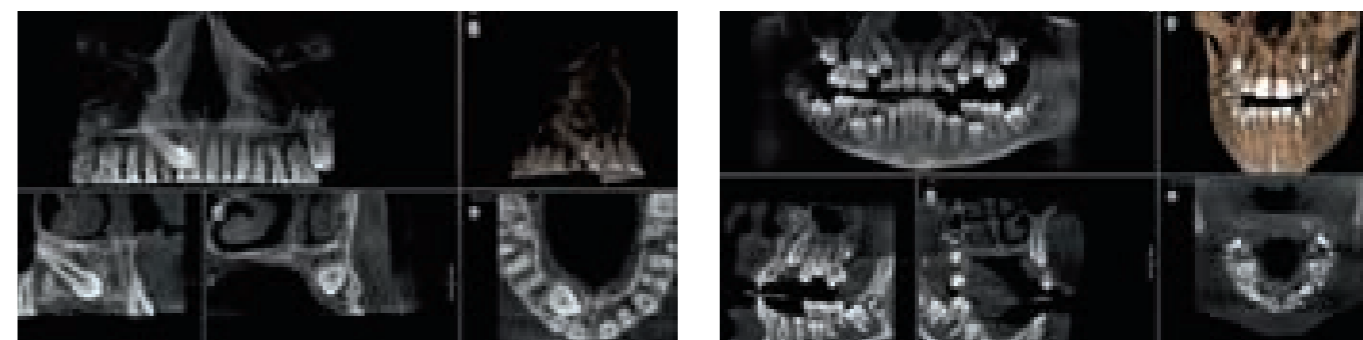

Locating displaced canine teeth 5 cm x 5,5 cm at 3  $\mu$ Sv

Determining the position of teeth 8 cm x 8 cm at 8  $\mu$ Sv

### Low Dose for a wide range of clinical tasks

- Locating displaced canine teeth
- Determining the position of teeth and reviewing courses of treatment in orthodontics
- Postoperative 3D check in implantology and surgery
- Analysis of the airways and paranasal sinuses

"With the new Low Dose mode, I can now optimally check the success of a procedure postoperatively and in 3D without exposing the patient to unnecessary radiation levels"

Dr. med. dent Gerd Frahsek, Velbert



# Orthophos XG 3D

Optimized for daily tasks in the practice: The world's most popular hybrid unit Orthophos XG 3D combines 2D and 3D x-rays.

With a volume of 8 cm x 8 cm, Orthophos XG 3D is perfectly adapted to fit the needs of any practice: One scan is sufficient for capturing the entire jaw. MARS (Metal Artifact Reduction Software) reduces artifacts that might occur from metal fillings,



and thus prevents incorrect diagnoses. If an even smaller volume is sufficient, choose the reduced volume of 5 cm x 5.5 cm. In difficult cases and for endodontics, the HD mode provides extremely detailed images. In all standard cases, the extensive

panoramic and cephalometric programs are guaranteed to deliver the right x-ray image.

## Optional Ceph arm

The traditional cephalometric function of the Orthophos XG 3D provides you with lateral and symmetrical p.a. or a.p. images for diagnosis. In cases of displaced teeth, you can also fall back on the benefits of 3D x-ray to determine their exact location.

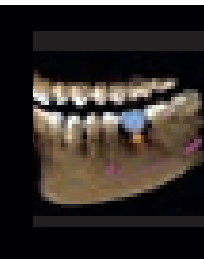
## Comparison of standard mode and HD mode

Mode	VOL 1 (8 cm Ø x 8 cm height)	VOL 2 (5 cm Ø x 5,5 cm height)
Standard mode	<ul style="list-style-type: none"> <li>200 individual images</li> <li>Voxel size 160 µm</li> </ul> 	<ul style="list-style-type: none"> <li>200 individual images</li> <li>Voxel size 160 µm</li> </ul> 
HD mode	<ul style="list-style-type: none"> <li>500 individual images</li> <li>Voxel size 160 µm</li> </ul>	<ul style="list-style-type: none"> <li>500 individual images</li> <li>Voxel size 100 µm</li> </ul> 

## HD image quality with ASTRA

ASTRA provides brilliant, contrast-rich images and thereby creates ideal conditions for a reliable diagnosis.

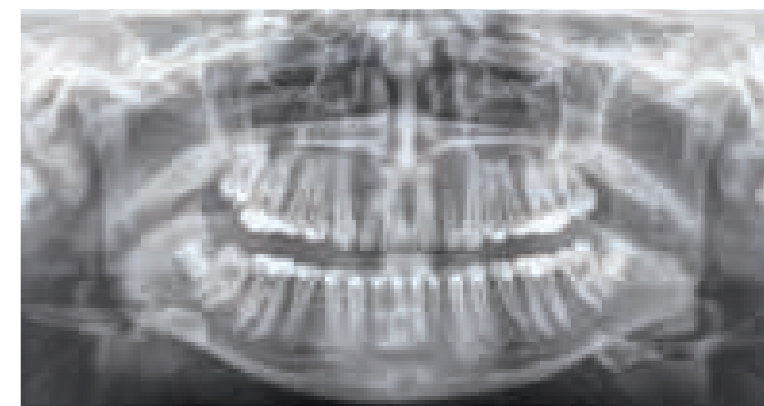

Simply reliable. Every day. Dentists that decided for an Orthophos XG 3D can confirm that. Because since its introduction it vows dental professionals by matching perfectly the daily practice tasks. The option to upgrade to 3D at any time gives it the capability to grow with your practice.

# Space requirements

Orthophos: Space requirements min. 1,280 mm x 1,411 mm

Orthophos: With Ceph arm at least 2,155 mm x 1,411 mm

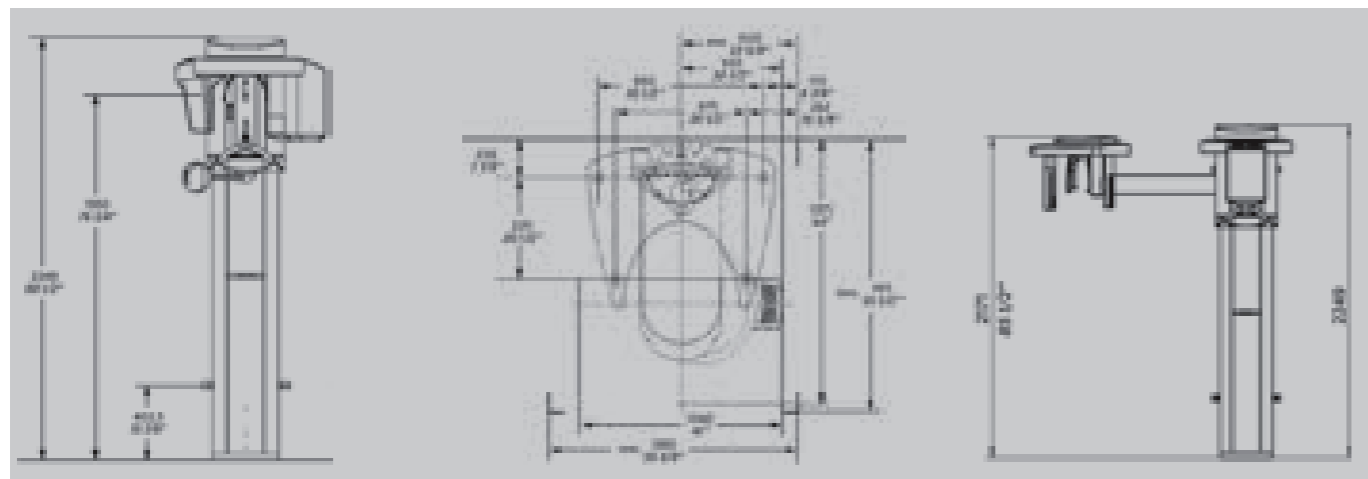

Galileos Comfort Plus: Space requirement at least 1,600 mm x 2,250 mm



\*Minimum space size.\*\*Recommended space size.

# Technical properties

Overview of performance features	Galileos Comfort Plus	Orthophos SL 3D	Orthophos XG 3D
Imaging volume	15 cm spherical imaging volume collimated 15 x 8.5 cm (UJ/LJ)	11 cm Ø x 10 cm height 11 cm Ø x 8 cm height 11 cm Ø x 7.5 cm height 8 cm Ø x 8 cm height 8 cm Ø x 5.5 cm height 5 cm Ø x 5.5 cm height	8 cm Ø x 8 cm height 8 cm Ø x 5.5 cm height 5 cm Ø x 5.5 cm height
3D resolution: Isotropic voxel size	0.25/0.125 mm	0.16 mm; 0.08 mm in HD mode	0.16 mm; 0.1 mm in HD mode
Scan time/exposure time	14 s/2-5 s	2-5 s; 14 s im HD mode	2-5 s; 14 s in HD mode
X-ray generator kV mA	98 3-6	60-90 3-16	60-90 3-16
Effective dose (Ludlow)	20 µSv-154 µSv	Low Dose: 3 µSv-20 µSv SD: 23 µSv-145 µSv HD: 57 µSv-273 µSv	14 µSv-166 µSv
Minimum space need (depth x width x height)	1,600x1,600 x 2,250 mm	1,411 x 1,280 x 2,250 mm	1,411 x 1,280 x 2,250 mm
Door size	For setup at least 66 cm	For setup at least 66 cm	For setup at least 66 cm
Weight	X-ray unit approx. 120 kg	X-ray unit approx. 110 kg	X-ray unit approx. 110 kg
<b>Technical equipment</b>			
Operation	EasyPad	EasyPad	EasyPad
Patient positioning	Standing/seated Chin rest/bite block Forehead support and head fixation	Standing/sitting, chin support/bite block, occlusal bite block with automatic patient positioning, universal bite block with colored stop positions	Standing/sitting, chin support/bite block, occlusal bite block with automatic patient positioning for 2D panoramic images Universal bite block with colored stop positions
Floor stand	□	□	□
Wheelchair appropriate	■	■	■
Remote control	□	□	□
Upgrade options	Facescanner (optional)	Cephalometric x-ray (optional), also available as a pure 2D unit with 3D upgrade option	Cephalometric x-ray (optional), also available as a pure 2D unit with 3D upgrade option

■ Available □ Optional



Individual patient positioning even for wheelchair patients.



Remote control with display of image parameters (optional).



Stable floor stand (optional).

# More than images – real solutions

## More solutions for your practice with x-rays from Sirona.

The Sidexis 4\*, with its intuitive user interface and display of all kinds of images on a monitor – whether intraoral, 2D panoramic, or 3D – increases the efficiency of your practice and the accuracy of your diagnoses like no other software. But Sirona does not stop with the diagnosis – our solutions allow you to plan treatment for a number of different conditions and customize treatment for the individual patient. The processes remain in your practice and your patients appreciate your modern, understandable treatment methods. For satisfied patients and reliable work in your practice.

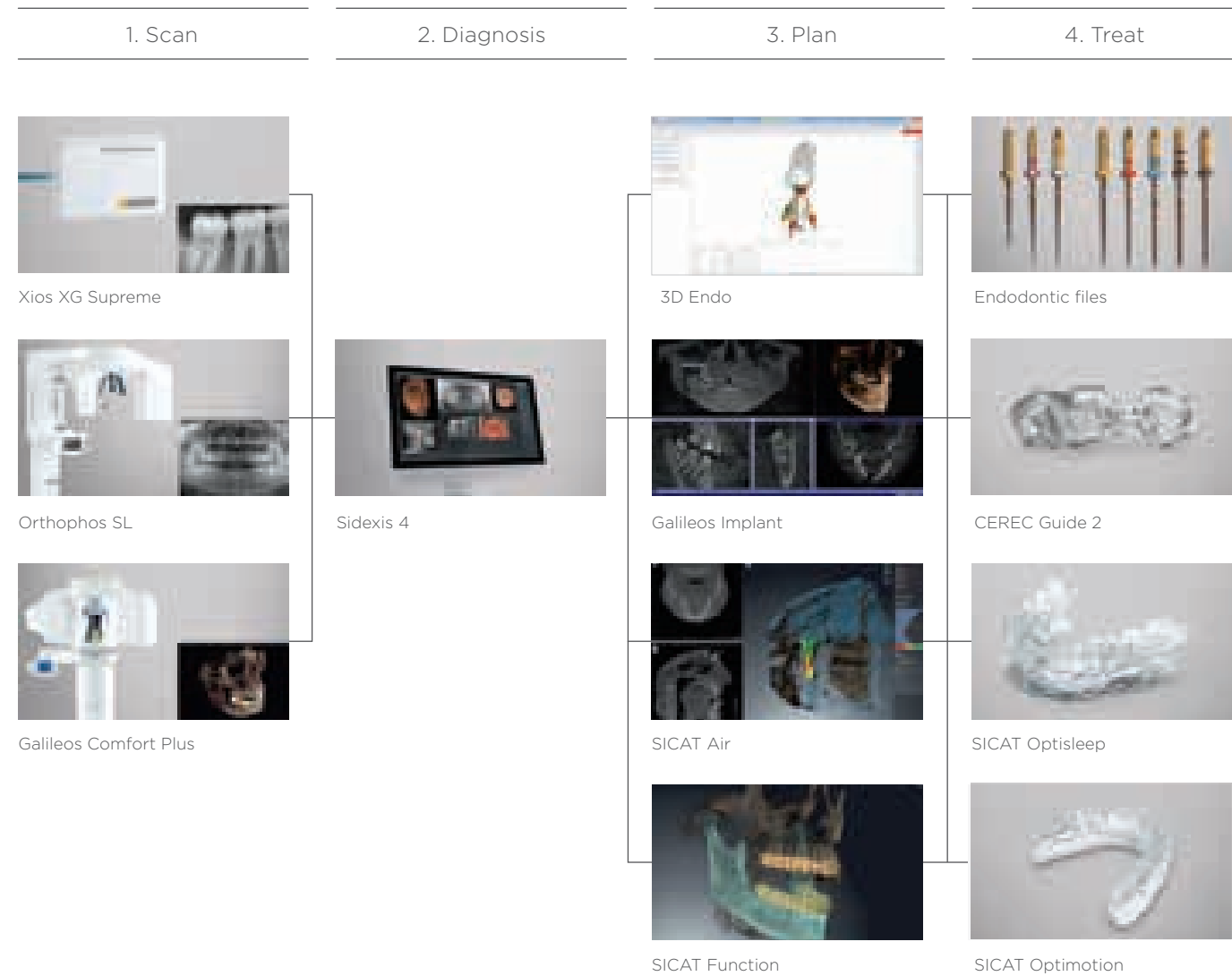

\*Sidexis 4 system requirements: [sirona.com/sidexis4-system\\_requirements](http://sirona.com/sidexis4-system_requirements)

## Panorama

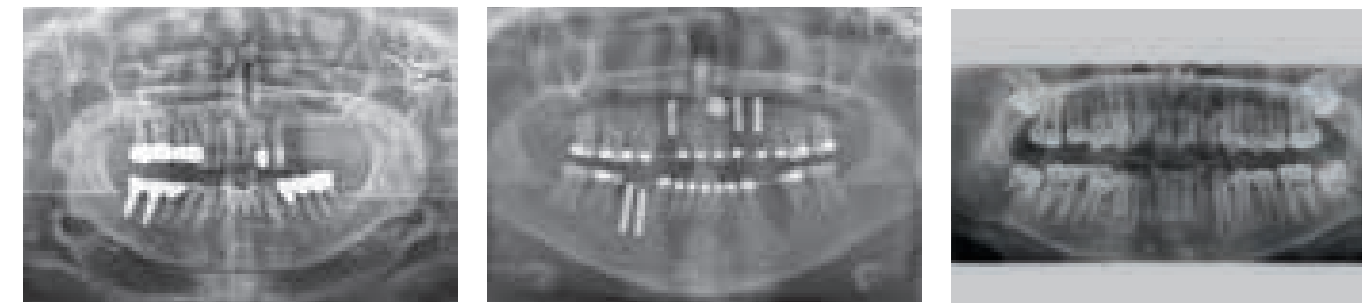

P1 orthoradial radiation      P2 without ascending rami      P10 pediatric panorama, beam field reduced in height and length

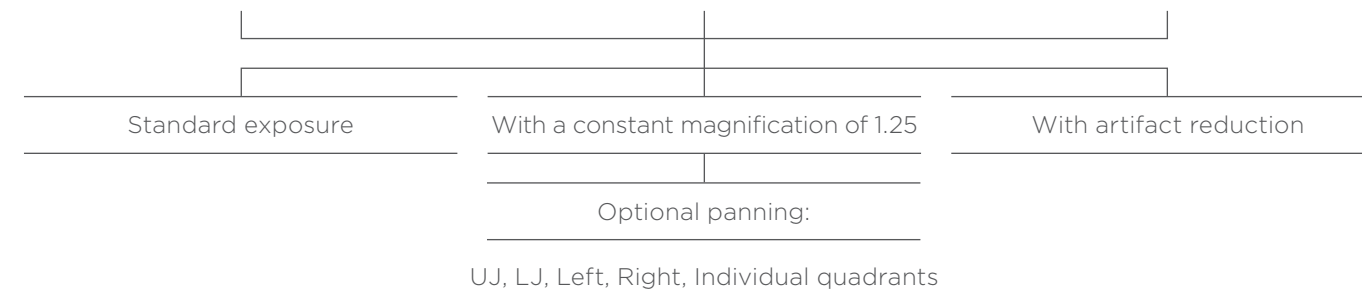

P12 thick slice in anterior tooth region

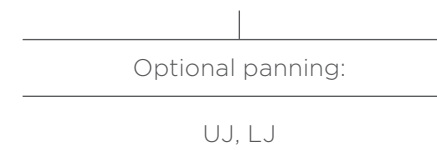

## Bitewing

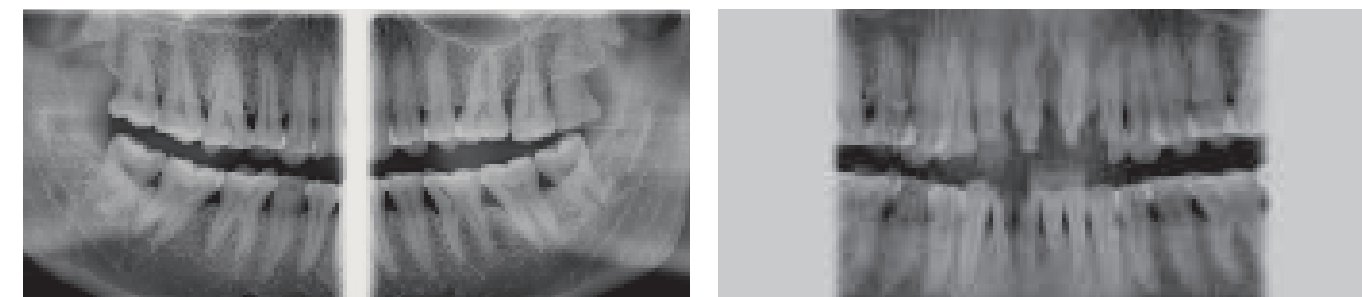

BW1      BW2 anterior tooth region



## TMJ

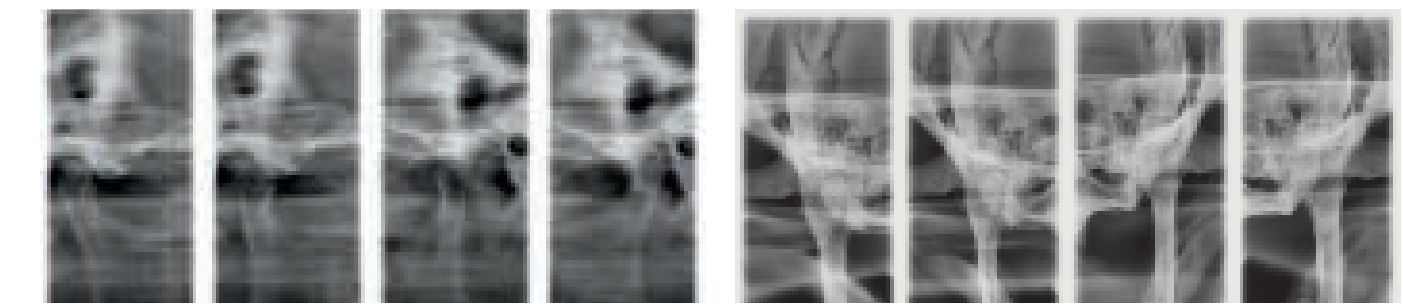

TM1 lateral      TM2 axial\*\*

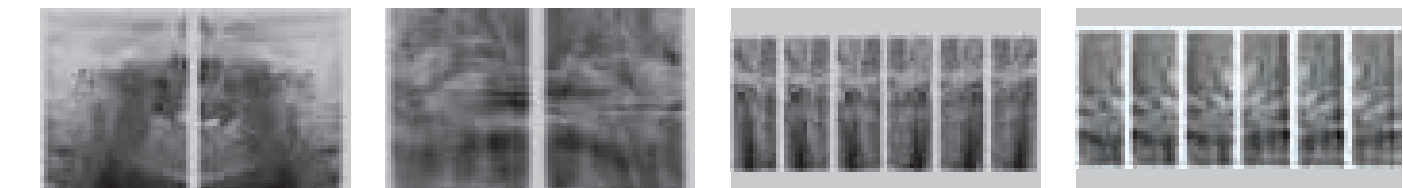
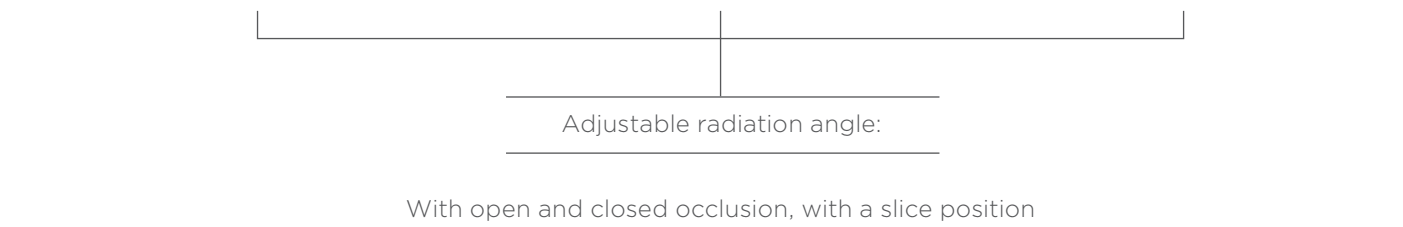

TM4\*\*      TM5\*\*      TM6\*\*

## Sinus



S1 jaw cavities      S2 jaw cavities twice\*\*      S3 simple jaw cavities linear      S4 jaw cavities twice linear\*\*

## Multislice in posterior tooth region

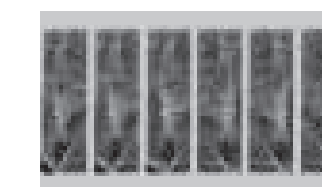

MS 1\*\*

This overview shows all 2D programs and the related images of the ORTHOPHOS XG 3D. Differences from the Orthophos SL 3D are marked accordingly.

\*\* Image not available with the Orthophos SL 3D

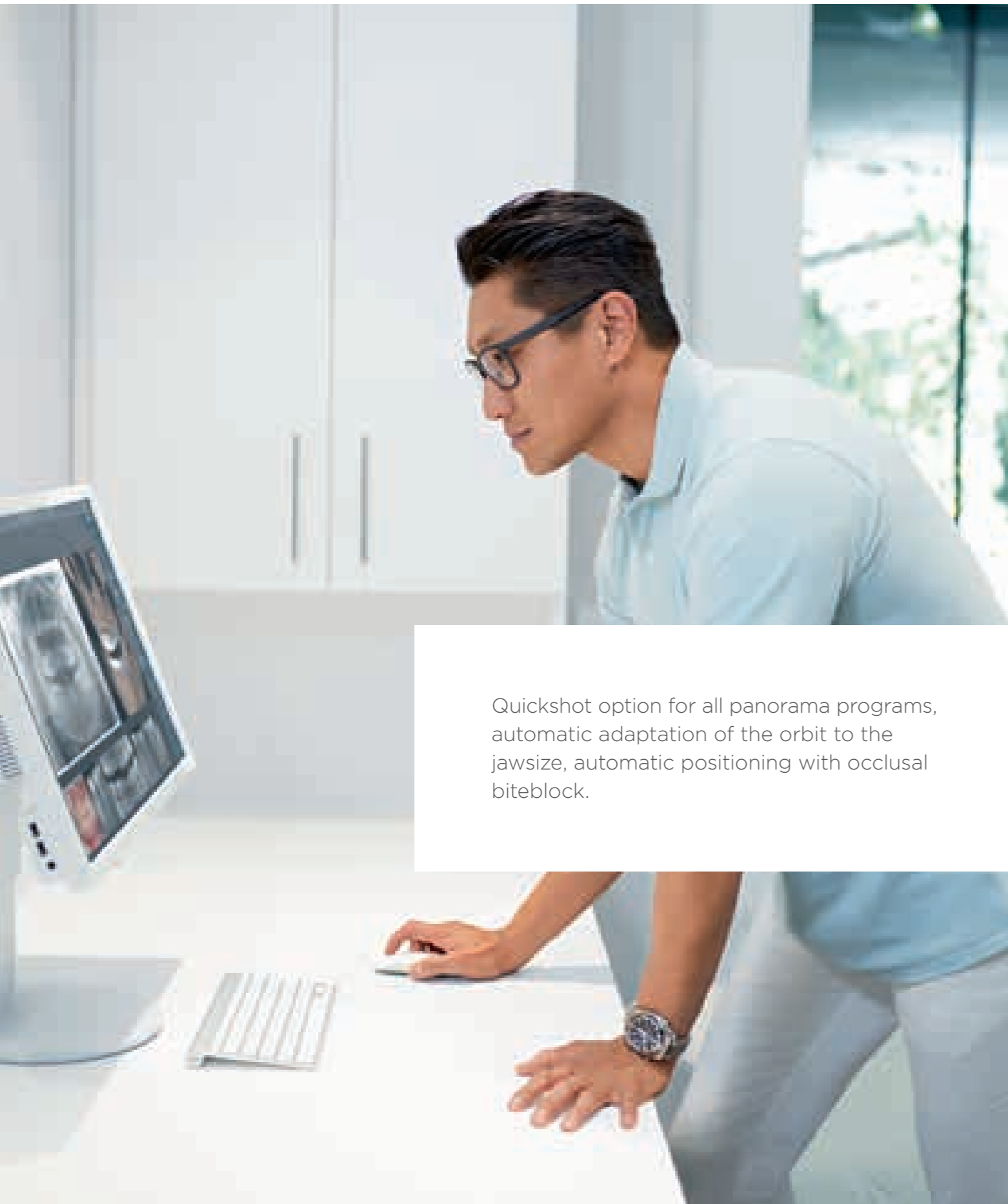

Quickshot option for all panorama programs, automatic adaptation of the orbit to the jawsize, automatic positioning with occlusal biteblock.

#### Dentsply Sirona

Sirona Dental Systems GmbH  
Fabrikstraße 31, 64625 Bensheim, Deutschland  
dentsplysirona.com

THE DENTAL  
SOLUTIONS  
COMPANY™

#### Procedural Solutions

Preventive  
Restorative  
Orthodontics  
Endodontics  
Implants  
Prosthetics

#### Enabling Technologies

CAD/CAM  
Imaging  
Treatment Centers  
Instruments

