



Commercial  
Vehicles



**The Amarok**

# Pretty

**Uncompromising off-road. Spirited on the asphalt**  
The Amarok combines everything that you expect from an exclusive, premium, class leading vehicle.

### Unique drive combination

The enhanced grip with the option of Permanent 4x4 (4MOTION) with 8-speed automatic gearbox

### Powerful Diesel engines

Choice of three engines - a responsive 2.0L 4-cylinder engine with 132kW of power and up to 420Nm of torque (400Nm for manual transmission) and two V6 3.0L engines - 165kW with 550Nm of torque (500Nm for manual transmission) or 190kW and 580Nm of torque

### High level of grip on every terrain

Outstanding off-road ABS and Hill Descent Assist

### Striking exterior design

An aggressive exterior look, combined with alloy wheels, makes the Amarok range everything you expect from a premium, class leading vehicle

### Modern interior design

Redesigned dash panel, including air-vents and upper dash storage space

### Advanced infotainment systems

New audio and navigation system, along with App-Connect™ and voice recognition

### Overboost

Unique to Amarok V6 models you can have more overtaking power on tap with a quick burst delivering up to 180kW for TDI500 and TDI550 variants or 200kW for TDI580

### Multi-Collision Braking System\*

This new system triggers braking post collision to help prevent secondary collisions

### Largest tray in its class

With a load area over 2.5m<sup>2</sup> in area and able to fit a pallet between the wheel arches

### Stopping Power

Unique to the Amarok V6 models are 332mm disc brakes up front and 300mm disc brakes in the rear



-App-Connect is compatible for selected apps with the latest smartphone versions of iOS and Android, active data service, and connection cable (sold separately).

\*Safety technologies are designed to assist the driver, but should not be used as a substitute for safe driving practices.

# y, Rugged



Core V6 model shown

# Amarok V6 Range

## 4 Cylinder Range

### Dual Cab 4x2:

- 16-inch steel wheels
- Height adjustable front seats
- Power mirrors with heating function
- Power windows with one-touch up and down
- Climatic air-conditioning
- Rear bench seat with 3 child seat anchor points
- Heavy duty rubber flooring
- Centre console storage compartment with lid
- 3 point seat belts and headrests for all seating positions
- High level stop light incorporating lighting for tray area
- Leather-covered multi-function steering wheel
- Instrument cluster with multi-function Plus display
- Cruise control
- Composition Media system
- App-Connect™ USB interface
- Multi-Collision Braking system\*

### Core 4x4:

- Dual Cab 4x2, Plus:
- Selectable or Permanent 4x4 (4MOTION) systems
- Engine under body protection (plate type)
- 16-inch Korama alloy wheels
- Pirelli ATR tyres (245/70 R16)
- Rear bumper, with integrated step
- Rear parking sensors
- Rear View Camera\*
- Core 4x4 decal on tub sides

## Standard equipment Amarok Core V6

### Exterior

- 17-inch Posadas alloy wheels
- Radiator grille with chrome element
- Extended wheel arches
- Front fog lights

### Interior

- Austin cloth seat upholstery
- Instrument cluster with multi-function Plus display
- Leather-covered multi-function steering wheel
- Cruise control
- Single Zone air conditioning system
- Composition Media audio system
- App-Connect™ USB interface
- Rear parking sensors with Rear View Camera\*
- Multi-Collision Braking system\*

## Standard equipment Amarok Sportline V6

### Core V6, plus:

### Exterior

- 18-inch Manaus alloy wheels
- Radiator grille with chrome elements
- Comfort closing rear tailgate
- Colour-coated exterior mirrors, partially chromed
- Rear privacy glass
- Rear bumper, chromed, with integrated step
- Tinted tail lights

### Interior

- Salipra cloth seat upholstery
- Dash panel with decorative inserts in bright silver
- Dual-zone Climatronic air conditioning system
- Four 12V sockets, (three in cabin and one in tray)
- Front and rear parking sensors with Rear View Camera\*



## Standard Equipment Amarok Highline V6

Sportline V6, plus:

### Exterior

- Bi-xenon headlights with LED daytime running lights
- Stainless steel styling bar
- Stainless steel side steps
- Front fog lights with cornering function

### Interior

- Discover Media navigation system
- Alarm with interior monitoring
- Safelock (deadlocking) system

## Standard equipment Amarok Ultimate V6 580

Highline V6 580 Black, plus:

### Exterior

- Silver 20-inch Talca alloy wheels
- Stainless steel styling bar (long design)
- Stainless steel side steps with LED lighting
- Special cargo area coating

### Interior

- Nappa leather appointed upholstery\* in black
- ergoComfort seats for driver and front passenger (14-way electric, 2-way manual)
- Instrument cluster with Premium Colour multi-function display
- Leather-covered multi-function steering wheel with paddle shifters
- Stainless steel pedals
- Tailored carpet mats

## Standard Equipment Amarok Highline V6 580 Black

Highline V6, plus:

- TDI580 engine with 190kW of power (200kW on over-boost) and 580Nm of torque

### Exterior

- Black 20-inch Talca alloy wheels
- Gloss black styling bar (long design)
- Gloss black side bars (no step)
- Gloss black painted exterior mirrors
- Gloss black and chrome grille

### Interior

- Black headlining & pillar trims



\*Leather appointed seats have a combination of genuine and artificial leather, but are not wholly leather.

# When Power Is Everything

## The legendary Volkswagen 2.0L TDI engine The 2.0L TDI 4-cylinder engine

With up to 132kW of power and 420Nm of torque, the 2.0 TDI has proven itself as worksite and bush trail ready. With not one but two Turbo-chargers, this Bi-turbo unit delivers power and torque from super low revs ensuring a smoother and more enjoyable driving experience.

### 2.0L TDI400 (132kW, 400Nm)

Fuel consumption 8.0L / 100km\*\*

### 2.0L TDI420 (132kW, 420Nm)

4x2: Fuel consumption 8.4L / 100km\*\*

4x4: Fuel consumption 8.5L / 100km\*\*



### 3.0L TDI500 (165kW, 500Nm) Overboost function up to 180kW

Fuel consumption: 9.7L / 100km\*\*

CO<sub>2</sub> emissions: 254 g/km

### 3.0L TDI550 (165kW, 550Nm) overboost function up to 180kW

Fuel consumption: 9.1L / 100km\*\*

CO<sub>2</sub> emissions: 240 g/km

### 3.0L TDI580 (190kW, 580Nm) overboost function up to 200kW

Fuel consumption: 8.9L / 100km\*\*

CO<sub>2</sub> emissions: 234 g/km

\*\*Fuel consumption figures according to Australian Design Rule (ADR) 81/02 derived from laboratory testing. Factors including but not limited to driving style, road and traffic conditions, environmental influences, vehicle condition and accessories fitted, will in practice in the real world lead to figures which generally differ from those advertised. Advertised figures are meant for comparison amongst vehicles only.

# ng V6

## Powerful like no other The V6 3.0L TDI engine

Available in two power outputs producing 165kW and 550Nm of torque (500Nm for manual transmissions) or 190kW and 580Nm of torque. The V6 turbodiesel engine has more than enough power reserves even in the most demanding situations. With Overboost, you can ramp up the power even more when you need it most with a quick burst of either up to 180kW or 200kW, depending on your engine, while also prolonging maximum torque delivery. Optimised in 3rd and 4th gear, the Overboost function increases the engine's output for up to ten seconds, making it ideal for overtaking.



**01 Permanent 4x4.** This always-on 4x4 system with Torsen differential excels on all surfaces. Torque is mechanically distributed from front to rear (40:60) with the ability to drive distribution to each wheel optimised by traction control intervention.

**02 Selectable 4x4.** The 4x4 drive system with a transfer case enables the front wheels to be electrically engaged and disengaged while driving. On steep inclines or longer stretches of challenging terrain an additional reduction gear set can also be engaged (available with manual transmission only).



**03 8-speed automatic gearbox.** The Amarok is the only vehicle in its class that offers the flexibility and performance of the 8-speed automatic transmission. The 1st gear is designed for off-road driving, whereas the 8th gear is optimised for economy driving at highway speeds.

**04 6-speed manual gearbox and Selectable 4x4 4MOTION (not illustrated).** The robust 6-speed manual gearbox offers responsive and smooth gear changes for all driving conditions. The manual transmission is combined with the dual range Selectable 4x4 system (available on Core models only).



**01 Side slope angle.** The broad track of the Amarok provides enormous stability even when driving along slopes with up to a 50° incline.<sup>1</sup>

**02 High-climbing ability.** The Amarok handles 100% (45°) grades with up to maximum payload.<sup>1</sup>

**03 Off-road ABS.** Once activated, the wheels lock when braking on loose surfaces with a larger interval, essentially creating a wedge which significantly reduces the braking distance. This noticeably increases the driving safety.

**04 Approach/departure angle and wading depth.** The maximum slope angle for the new Amarok is 28.0° at the front and 23.6° at the rear. It can handle pool with a wading depth of 500 mm.

# King

100% incline, 50° gradient  
and off-road ABS  
**Outstanding all terrain  
performance**

Asphalt, dirt, gravel. In the Amarok you will experience the ultimate in driving capability on almost any terrain. It combines high ground clearance with rigid body stability along with the proven 4MOTION all-wheel drive system. This vehicle also comes into its own on the road, with the Torsen® differential significantly increasing traction while cornering.



<sup>1</sup> Figures may vary depending on the equipment line and engine type. Please note that these are statically calculated figures.



# Of The Hill



Highline model shown



### **Premium equipment**

The only vehicle in its class with ergoComfort seats

The Amarok Ultimate (shown) offers a premium leather appointed upholstery seats# with additional under-seat storage, rear grab handles and individual map lamps. In addition, the Amarok Ultimate offers a leather-wrapped multi-function steering wheel with shift paddles as well as front 14-way adjustable ergoComfort seats.

# Leather appointed seats have a combination of genuine and artificial leather, but are not wholly leather.



**01 Composition Media system**

The crystal clear 6.33" colour touch screen is packed with the latest multimedia functions, including App-Connect™ and Bluetooth®. For added convenience the telephone functions can be voice activated.

| DC | CE | CE6 | SL |



**02 App-Connect™**

With this function, selected apps are mirrored from your smart phone to the touch screen of the radio or navigation system display via the USB port and controlled using the touchscreen.

| DC | CE | CE6 | SL | HL | HLB | UL |



**03 Discover Media navigation system.**

In addition to the functions of the Composition Media radio system with six loud speakers, there is a second integrated SD-card slot which is compatible with the SD-card with the map data.

| HL | UL | HLB |



**04 Voice Control.**

You are free to operate the telephone and audio functions without taking your hands off the steering wheel. Furthermore, you can call up virtually all menus and notifications on the radio using voice control.

| DC | CE | CE | CE6 | SL | HL | HLB | UL |



**05 Climatronic air conditioning.** This system offers 2-zone temperature control for the driver and front passenger. Depending on the intensity of the sun's rays and the outside temperature, the air conditioning adds more or less cool air accordingly.

| SL | HL | HLB | UL |

\*App-Connect is compatible for selected apps with the latest smartphone versions of iOS and Android, active data service, and connection cable (sold separately).



01

**01 Cargo area coating.** The UV-resistant special coating in anthracite provides excellent protection against mechanical and chemical wear. | UL |



02

**02 Load light.** The exterior load light helps illuminate the tray, ideal for early starts or late finishes | DC | CE | CE6 | SL | HL | HLB | UL |

**The smoothest moving tailgate.** The comfort feature makes opening and closing the tailgate a breeze, while still rated to carry up to 200kg. | SL | HL | HLB | UL |

**12V socket** (not illustrated). A 12V socket is fitted on the inside of the left side panel. | SL | HL | HLB | UL |

## Packs a pallet The widest tray in its class

No other pickup provides so much space between the wheel arches: the loading width of 1,222 mm even enables Euro pallets to be loaded crosswise. The spacious cargo box with a 2.52 m<sup>2</sup> load surface features convincing dimensions – such as the 508 mm high side panels and the low loading sill height of 780 mm.



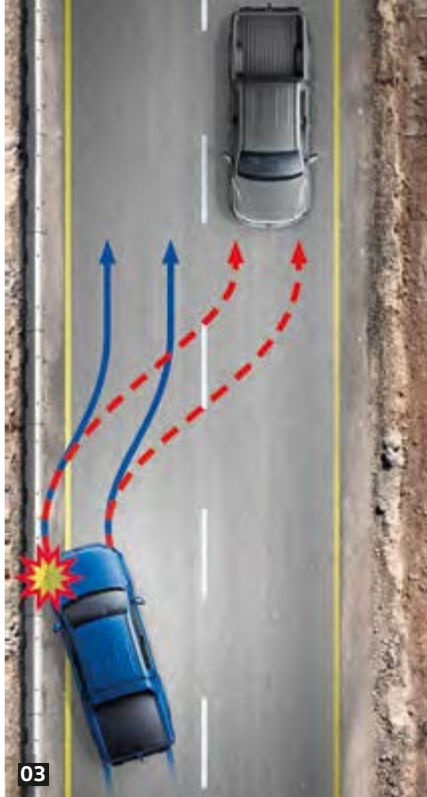

03





04





05

## Safety systems\*

 **03 Automatic Post-Collision Braking System.** Triggers braking after a collision, with the aim of preventing secondary collisions. After a short delay, the vehicle begins phased braking action down to 10 km/h. | DC | CE | CE6 | SL | HL | HLB | UL |

 **Electronic Stability Programme** (not illustrated). Prevents under or over-steering via targeted braking of individual wheels. | DC | CE | CE6 | SL | HL | HLB | UL |

 **Front and head/thorax airbags** (not illustrated) for the driver and front passenger. | DC | CE | CE6 | SL | HL | HLB | UL |

 **Height-adjustable head restraints** (not illustrated) and 3-point seatbelts are featured throughout, with pretensioners on the front seats. | DC | CE | CE6 | SL | HL | HLB | UL |

**332mm disc brakes in the front, 300mm disc brakes in the rear** (not illustrated). Offer an optimum performance during high brake loads. | CE6 | SL | HL | HLB | UL |

**Trailer Stabilisation** (not illustrated). Configured for the Genuine Volkswagen tow bar wiring to compliment the Electronic Stability Programme, helping to reduce trailer sway. | DC | CE | CE6 | SL | HL | HLB | UL |

## Driver assistance systems\*

 **04 Static cornering light.** Ensures optimal visibility in poor weather conditions. The fog light nearest to the corner illuminates the roadside when turning. | HL | HLB | UL |

 **05 Rear View Camera.** Simplifies reversing by showing a limited view of the area behind the vehicle on the display. Static guidelines facilitate the parking process. | DC | CE | CE6 | SL | HL | HLB | UL |

**Hill Start Assist** (not illustrated). Prevents the vehicle from rolling back on inclines and makes it easier to start off on uphill slopes. | DC | CE | CE6 | SL | HL | HLB | UL |

 **Hill Descent Assist** (not illustrated). Allows you to drive down slopes in a safe, controlled way by governing the engine speed and applying the brakes, if necessary. | CE | CE6 | SL | HL | HLB | UL |

 **Park Pilot** (not illustrated). Emits audible warnings when obstacles are detected behind the vehicle when parking. | DC | CE | CE6 | Emits audible warnings at the front and rear of the vehicle when parking. | SL | HL | HLB | UL |

 **Cruise control** (not illustrated). As of a speed of 30 km/h, it maintains the set speed depending on uphill and downhill inclines. | DC | CE | CE6 | SL | HL | HLB | UL |

 **Tyre Pressure Monitoring System** (not illustrated). Warns when there is a deviation in tyre pressure and indicates the driver to check tyre pressure as soon as possible. | HL | HLB | UL |

 **Mechanical rear differential lock** (not illustrated). When activated ensures both rear wheels receive the same amount of power and rotations. This offers optimal traction on sandy or slippery surfaces. | DC | CE | CE6 | SL | HL | HLB | UL |



**01 Roll cover.** The lockable load compartment cover protects the cargo from prying eyes. Accessory  
| DC | CE | CE6 | SL | HL | UL |

**02 Styling bar (long).** This impressive styling bar enhances the look of the Amarok. The Ultimate model has a stainless steel finish, while the Highline 580 Black model has a gloss black bar.  
| HLB | UL |

# Tough No

## Sporty and distinctive Create a strong impression

With its stainless steel styling bar and side steps, striking front design and 18-inch Manaus alloy wheels, the Amarok Highline model creates a strong impression.

The frontal design features two double chrome strips, honeycomb grille highlights and a more aggressive fog light design.



# ot Rough



Highline model shown

# Technical Specifications - 4 Cylinder Range

Engine	TDI420 4x2	TDI400 4x4	TDI420 4x4
Type	4 cylinder Bi-turbo diesel, DOHC, 16 valve		
Cubic capacity, litres/cc	2.0 / 1,968		
Max power, kW @ rpm	132 @ 4,000	132 @ 4,000	132 @ 4,000
Max torque, Nm @ rpm	420 @ 1,750	400 @ 1,500 - 2,250	420 @ 1,750
Compression ratio	16.5:1		
Fuel system	Common Rail Direct Injection		
Exhaust emission control	Water-cooled exhaust gas recirculation (EGR), catalytic converter and diesel particulate filter (DPF)		
Fuel type (Recommended)	Diesel EN 590		
<b>Transmission</b>	<b>8 Speed Automatic</b>	<b>6 Speed Manual</b>	<b>8 Speed Automatic</b>
Driven wheels	4x2 Rear Wheel Drive	4x4 (4MOTION) Selectable	4x4 (4MOTION) Permanent
Gear Ratios	Final Drive: 3.70 1st Gear: 4.714 2nd Gear: 3.143 3rd Gear: 2.106 4th Gear: 1.667 5th Gear: 1.285 6th Gear: 1.00 7th Gear: 0.839 8th Gear: 0.667 Reverse Gear: 3.300	Final Drive: 4.10 1st Gear: 3.583 2nd Gear: 1.889 3rd Gear: 1.114 4th Gear: 1.00 5th Gear: 0.564 6th Gear: 0.473 Reverse Gear: 3.250	Final Drive: 3.70 1st Gear: 4.714 2nd Gear: 3.143 3rd Gear: 2.106 4th Gear: 1.667 5th Gear: 1.285 6th Gear: 1.00 7th Gear: 0.839 8th Gear: 0.667 Reverse Gear: 3.300
<b>Fuel consumption**</b>			
Combined, L/100km	8.4	8.0	8.5
Urban, L/100km	10.0	9.2	10.1
Extra Urban, L/100km	7.6	7.3	7.6
CO <sub>2</sub> emissions, g/km	224	211	224
Fuel tank capacity, litres	80	80	80
<b>Towbar Capacity*</b>			
Braked, kg	3,000		
Unbraked, kg	750		
Towball load limit, kg	300		

\*\*Fuel consumption figures according to Australian Design Rules (ADR) 81/02 derived from laboratory testing. Factors including but not limited to driving style, road and traffic conditions, environmental influences, vehicle condition and accessories fitted, will in practice in the real world lead to figures which generally differ from those advertised. Advertised figures are meant for comparison amongst vehicles only.

\*When fitted with Volkswagen Genuine Tow Bar. Towing capacities are applicable to Volkswagen Genuine Accessory Tow Bar. Towing capacity figures are maximum figures and actual towing capacity depends on factors including the laden mass of the vehicle, driving conditions and fitment of any accessories. Volkswagen Group Australia does not endorse or will not be held liable for any claim, loss or damage arising from the use or fitment of electronic trailer brakes.



# Technical Specifications - 4 Cylinder Range

## Running Gear

Suspension	2.0 litre, 4 cylinder TDI
Front axle	Transverse link with A-frame arm double wishbone and anti-roll bar
Rear axle	Multi-layer rigid axle with leaf spring and stabiliser bar
Steering	Power assisted rack & pinion steering
Brake systems	Anti-lock Braking System (ABS) with Electronic Brake-pressure Distribution (EBD), Brake Assist and Electronic Stabilisation Program (ESP)
Brakes	
Front / Rear, mm	303, Ventilated Discs / 292, Drum
Brake systems	ESP, off-road ABS, ASR, EDL, Hill Holder, Brake Assist, Traction Control and Off-Road ABS including Hill Descent
Turning circle, m	12.95

## Weights

	TDI420 4x2 Core	TDI400 4x4 Core	TDI420 4x4 Core
Unladen Mass, kg	1,885	2,007	2,022
Payload, kg	1,155	1,033	1,018
Gross Vehicle Mass (GVM) kg	3,040	3,040	3,040
Gross Combined Mass (GCM) kg	5,550	5,550	5,550
Roof load, kg	100	100	100

# Dimensions

Exterior Dimensions	TDI420 4x2	TDI400 Core 4x4	TDI420 Core 4x4
Overall length mm	5,181	5,254	5,254
Width mm	1,944	1,944	1,954
Width incl. mirrors mm	2,228	2,228	2,228
Height mm	1,834	1,834	1,878 <sup>^</sup>
Wheelbase mm	3,095	3,095	3,095
Ground clearance mm	230	226	226
Entry angle	28.0	28.0	28.0
Departure angle	28.0	23.6	23.6
Ramp angle	23.0	23.0	23.0
Wading depth, mm	500	500	500

## Tray Dimensions

Length, mm	1,555
Width, mm (Max.)	1,620
Width, mm (between wheel arches)	1,222
Tailgate opening, mm (Max.)	1,364
Height (tailgate), mm	508
Height from ground, mm	780

## Amarok Dual Cab

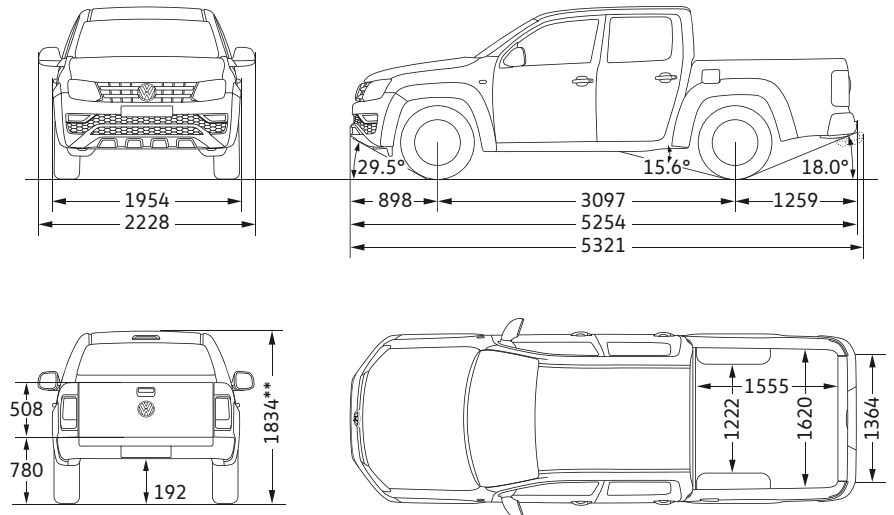

<sup>^</sup> Including sports bar

<sup>‡</sup> Payload is defined as the Gross Vehicle Mass (GVM) minus the Kerb Mass. Payload is the maximum combined weight of occupants, cargo, added structures and tow ball down weight (when towing). GVM must not be exceeded.

\*\*Height shown without sports bar.

# Technical Specifications - 6 Cylinder Range

Engine	3.0 litre V6 TDI500	3.0 litre V6 TDI550	3.0 litre V6 TDI580			
Type	6 cylinder turbo diesel, 24 valve	6 cylinder turbo diesel, 24 valve	6 cylinder turbo diesel, 24 valve			
Cubic capacity, litres/cc	3.0 / 2,967	3.0 / 2,967	3.0 / 2,967			
Max power, kW @ rpm	165 @ 3,250 - 4,500	165 @ 2,500 - 4,500	190 @ 3,250 - 4,500			
Max torque, Nm @ rpm	500 @ 1,250 - 3,000	550 @ 1,500 - 2,500	580 @ 1,400 - 3,000			
Compression ratio	17.0:1	17.0:1	17.0:1			
Fuel system	Bosch EDC17 electronic engine control unit	Bosch EDC17 electronic engine control unit	Bosch EDC17 electronic engine control unit			
Exhaust emission control	Water-cooled exhaust gas recirculation (EGR), catalytic converter and diesel particulate filter (DPF)	Water-cooled exhaust gas recirculation (EGR), catalytic converter and diesel particulate filter (DPF)	Water-cooled exhaust gas recirculation (EGR), catalytic converter and diesel particulate filter (DPF)			
Fuel type (Recommended)	Diesel EN 590	Diesel EN 590	Diesel EN 590			
<b>Transmission</b>	<b>6 Speed Manual</b>	<b>8 Speed Automatic</b>	<b>8 Speed Automatic</b>			
Driven wheels	4x4 (4MOTION) Selectable	4x4 (4MOTION) Permanent	4x4 (4MOTION) Permanent			
Gear Ratios	1st Gear: 5.070 2nd Gear: 2.614 3rd Gear: 1.524 4th Gear: 1.000 5th Gear: 0.770 6th Gear: 0.657 Reverse Gear: 4.823	1st Gear: 4.714 2nd Gear: 3.143 3rd Gear: 2.106 4th Gear: 1.667 5th Gear: 1.285 6th Gear: 1.00 7th Gear: 0.839 8th Gear: 0.667 Reverse Gear: 3.317	1st Gear: 4.714 2nd Gear: 3.143 3rd Gear: 2.106 4th Gear: 1.667 5th Gear: 1.285 6th Gear: 1.00 7th Gear: 0.839 8th Gear: 0.667 Reverse Gear: 3.317			
<b>Performance#</b>						
0 - 100km/h, seconds	xx	7.9	7.3			
<b>Fuel consumption**</b>						
Combined, L/100km	9.7	9.1	8.9			
Urban, L/100km	11.4	10.6	9.6			
Extra Urban, L/100km	8.6	8.3	8.5			
CO <sub>2</sub> emissions, g/km	254	240	234			
Fuel tank capacity, litres	80	80	80			
<b>Towbar Capacity#</b>	<b>Core V6 Manual</b>	<b>Core V6</b>	<b>Sportline V6</b>	<b>Highline V6</b>	<b>Highline 580 Black</b>	<b>Ultimate V6</b>
Braked kg	3,000	3,500	3,500	3,500	3,500	3,500
Unbraked, kg	750	750	750	750	750	750
Towball load limit, kg	300	300	300	300	300	300

#Please note figures are sourced from overseas data where equipment levels by model variant may vary.

\*\*Fuel consumption figures according to Australian Design Rules (ADR) 81/02 derived from laboratory testing. Factors including but not limited to driving style, road and traffic conditions, environmental influences, vehicle condition and accessories fitted, will in practice in the real world lead to figures which generally differ from those advertised. Advertised figures are meant for comparison amongst vehicles only.

#When fitted with Volkswagen Genuine Tow Bar. Towing capacities are applicable to Volkswagen Genuine Accessory Tow Bar. Towing capacity figures are maximum figures and actual towing capacity depends on factors including the laden mass of the vehicle, driving conditions and fitment of any accessories. Volkswagen Group Australia does not endorse or will not be held liable for any claim, loss or damage arising from the use or fitment of electronic trailer brakes.

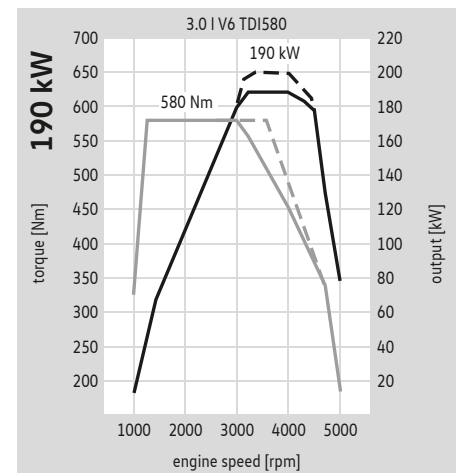
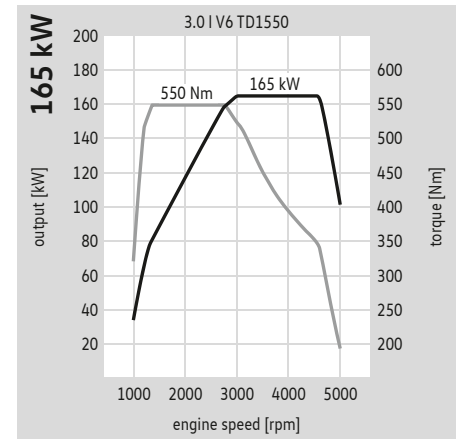
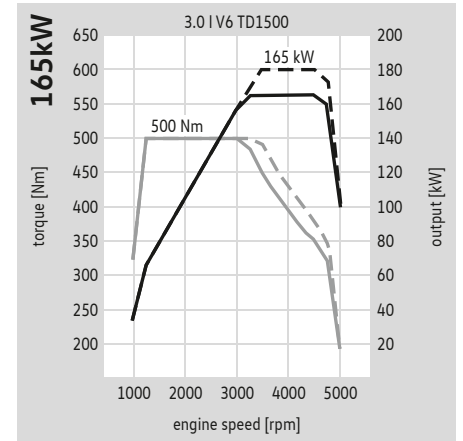

# Technical Specifications - 6 Cylinder Range

Running Gear	3.0 litre V6 TDI500	3.0 litre V6 TDI550	3.0 litre V6 TDI580			
Suspension						
Front axle	Transverse link with A-frame arm, double wishbone and anti-roll bar	Transverse link with A-frame arm, double wishbone and anti-roll bar	Transverse link with A-frame arm, double wishbone and anti-roll bar	Transverse link with A-frame arm, double wishbone and anti-roll bar	Transverse link with A-frame arm, double wishbone and anti-roll bar	Transverse link with A-frame arm, double wishbone and anti-roll bar
Rear axle	Multi-layer rigid axle with leaf spring and stabiliser bar	Multi-layer rigid axle with leaf spring and stabiliser bar	Multi-layer rigid axle with leaf spring and stabiliser bar	Multi-layer rigid axle with leaf spring and stabiliser bar	Multi-layer rigid axle with leaf spring and stabiliser bar	Multi-layer rigid axle with leaf spring and stabiliser bar
Steering	Power assisted rack & pinion steering	Power assisted rack & pinion steering	Power assisted rack & pinion steering	Power assisted rack & pinion steering	Power assisted rack & pinion steering	Power assisted rack & pinion steering
Brakes						
Front / Rear, mm	Ventilated, 332 / Ventilated, 300	Ventilated, 332 / Ventilated, 300	Ventilated, 332 / Ventilated, 300	Ventilated, 332 / Ventilated, 300	Ventilated, 332 / Ventilated, 300	Ventilated, 332 / Ventilated, 300
Brake systems	ESP, ABS, ASR, EDL, Hill Holder, Brake Assist, Traction Control and Off-Road ABS including Hill Descent	ESP, ABS, ASR, EDL, Hill Holder, Brake Assist, Traction Control and Off-Road ABS including Hill Descent	ESP, ABS, ASR, EDL, Hill Holder, Brake Assist, Traction Control and Off-Road ABS including Hill Descent	ESP, ABS, ASR, EDL, Hill Holder, Brake Assist, Traction Control and Off-Road ABS including Hill Descent	ESP, ABS, ASR, EDL, Hill Holder, Brake Assist, Traction Control and Off-Road ABS including Hill Descent	ESP, ABS, ASR, EDL, Hill Holder, Brake Assist, Traction Control and Off-Road ABS including Hill Descent
Turning circle, m	12.95	12.95	12.95	12.95	12.95	12.95
<b>Weights</b>	<b>Core V6 Manual</b>	<b>Core V6</b>	<b>Sportline V6</b>	<b>Highline V6</b>	<b>Highline 580 Black</b>	<b>Ultimate V6</b>
Unladen Mass, kg	2,076	2,091	2,104	2,147	2,209	2,244
Payload, kg †	1,004	989	976	933	871	836
Gross Vehicle Mass (GVM), kg	3,080	3,080	3,080	3,080	3,080	3,080
Gross Combined Mass (GCM), kg	5,550	6,000	6,000	6,000	6,000	6,000
Roof load, kg	100	100	100	100	100	100

## Dimensions

Exterior Dimensions	3.0 litre V6 TDI500	3.0 litre V6 TDI550	3.0 litre V6 TDI580
Overall length, mm	5,254	5,254	5,254
Width, mm	1,954	1,954	1,954
Width incl. mirrors, mm	2,228	2,228	2,228
Height, mm (HL)	1,878	1,878	1,878
Height, mm (UL)	1,834	1,834	1,834
Wheelbase, mm	3,095	3,095	3,095
Ground clearance, mm	192	192	192
Entry angle	28.0°	28.0°	28.0°
Departure angle	23.6°	23.6°	23.6°
Ramp angle	23.0°	23.0°	23.0°
Wading depth, mm	500	500	500
Track Front/Rear, mm	1,654 / 1,658	1,654 / 1,658	1,654 / 1,658

Tray Dimensions	3.0 litre V6 TDI500	3.0 litre V6 TDI550	3.0 litre V6 TDI580
Length, mm	1,555	1,555	1,555
Width, mm (Max.)	1,620	1,620	1,620
Width, mm (between wheel arches)	1,222	1,222	1,222
Tailgate opening, mm (Max.)	1,364	1,364	1,364
Height (tailgate,) mm	508	508	508
Height from ground, mm	780	780	780

Amarok Dual Cab (with wheel arch flares and rear step bumper)

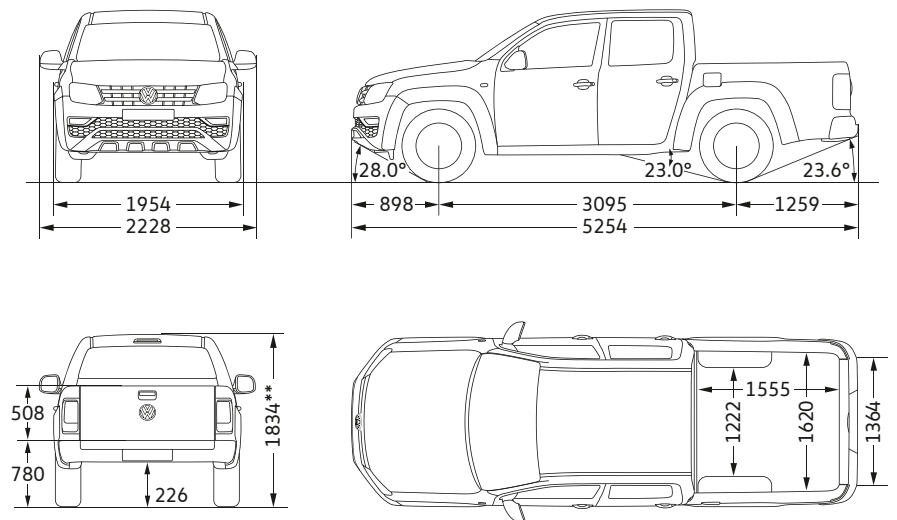

° Track figures are based on rim off-set of 45

† Payload is defined as the Gross Vehicle Mass (GVM) minus the Kerb Mass. Payload is the maximum combined weight of occupants, cargo, added structures and tow ball down weight (when towing). GVM must not be exceeded.

\*\*Height shown without sports bar.

# Volkswagen Accessories

Volkswagen Genuine Accessories ensures your Amarok remains 100% Volkswagen. The extensive range of Amarok Genuine Accessories provides you with the opportunity to adapt your Amarok even more precisely to your individual needs. From interior to exterior solutions, styling options, Volkswagen Genuine Accessories perfectly compliments your Amarok.

For the full range, please visit [www.volkswagen.com.au/en/owners/volkswagen-accessories.html](http://www.volkswagen.com.au/en/owners/volkswagen-accessories.html)



**01** 19" Aragonit alloy wheel

Part.no 2H0071499AX1 (Gloss black)



**02** 18" Durban alloy wheel

Part.no 2H6071498Z98 (matte black)



**03** 17" Rocadura alloy wheel

Part.no 2H0071497AFZZ (gloss machined)



**04** Roof bars

Part.no VGA071126AM17 (Flush mount)  
Part.no VGA071126AM17C (Commercial)



**05** Black Side steps

Part.no 2H0071691L041



**06** Black Styling bar

Part.no 2H0071000ENP1



**07 Towbar**

Part.no 2H6092134  
(3.5 Tonne towbar for Amarok V6 auto only - MY18 onwards)  
Part.no 2H0092134A  
(3.0 Tonne towbar for Amarok with bumper)  
Part.no 2H0092134B  
(3.0 Tonne towbar for Amarok without bumper)



**08 Amarok Platform system**

Part.no VGA2H6421AM17



**09 Amarok roll cover**



**08 Tonneau Cover**

Part.no VGA2H7071778  
(to suit without sports bars)  
Part.no VGA2H7071778A  
(to suit with highline sports bars)



**11 Cargo Manager**

Part.no 2H6061166  
(Only compatible with the roll cover)



**12 Amarok 5-piece liner**

Part.no VGA2H7061164



**13 Amarok EZDown® tailgate damper**

Part.no VGA2H00ED0800 (with torsion bar)  
Part.no VGA2H00ED0300 (without torsion bar)



**14 Amarok Alloy tray range**



**15 Amarok bonnet protector**

Part.no VGA823010S (tinted black)  
Part.no VGA823010 (clear)



**16 Rubber floor mats set**

Part.no 2H206150282V (front)  
Part.no 2H006151282V (rear)



**17 Slimline Weathershields (front and rear)**

Part.no VGA845015S (tinted/black)  
Part.no VGA845015 (clear)



**18 Running boards**

Part.no 2H0071691B

## Seat upholstery



01



02



03



04

**01** Austin cloth seat upholstery in Titanium Black and Moon Rock Grey | DC | CE | CE6 |

**02** Salipra cloth seat upholstery in Palladium | SL | HL | HLB |

**03** Vienna leather seat upholstery# in Palladium | HL | HLB |

**04** Nappa leather seat upholstery# in Black with seams in Ceramique | UL |

## Wheels



05



06



07



08



09



10



11

**05** Steel wheels, 6.5J x 16. With 205 R 16 tyres. | DC |

**06** Korama alloy wheel, 6.5 J x 16. With 245/70 R 16 tyres. | CE |

**07** Posadas alloy wheel, 8.0 J x 17. With 245/65 R 17 tyres. | CE6 |

**08** Manaus alloy wheel, 7.5 J x 18. With 255/60 R 18 tyres. | SL | HL |

**09** Cantera alloy wheel, 8.0 J x 19. With 255/55 R 19 tyres. | HL |

**10** Talca alloy wheel, gloss black finish, 8.0 J x 20. With 255/50 R 20 tyres. | HLB |

**11** Talca alloy wheel, 8.0 J x 20. With 255/50 R 20 tyres. | UL |

#Leather appointed seats have a combination of genuine and artificial leather, but are not wholly leather.

| DC | Dual Cab 4x2 AT | | CE | Core | | CE6 | Core V6 | | SL | Sportline | | HL | Highline | | HLB | Highline 580 Black | | UL | Ultimate | **Standard Option** | Optional extra

## Paint finishes

**01** Candy White Solid | B4B4 |  
| DE | CE | CE6 | SL | HL | HLB | UL |



01

**02** Mojave Beige Metallic | 1B1B |  
| DE | CE | CE6 | SL | HL |



02



03

**03** Reflex Silver Metallic | 8E8E |

**04** Ravenna Blue Metallic\* | 5Z5Z |  
| HLB | UL |

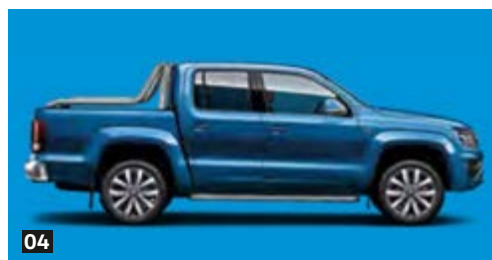

04

**05** Indium Grey Metallic | X3X3 |  
| DE | CE | CE6 | SL | HL | HLB | UL |



05



06

**06** Starlight Blue Metallic | 3S3S |  
| DE | CE | CE6 | SL | HL |

**07** Deep Black Pearl Effect | 2T2T |  
| DE | CE | CE6 | SL | HL | HLB | UL |



07

**08** Ravenna Blue Matte\*\* | 9547 |  
| UL |



08



09

**09** Indium Grey Matte\*\* | 9709 |  
| UL |

**10** Tornado Red Solid | G2G2 |  
| HL | HLB | UL |



10

**11** Peacock Green Metallic\* | 8U8U |  
| UL |



11

\*Available on Amarok Ultimate model only.

#Leather appointed seats have a combination of genuine and artificial leather, but are not wholly leather.

+Matte paint requires special care. If matte paint is not cleaned and maintained properly, the finish may be altered or damaged.

Please note that Metallic, Matte and Pearl affect paint are optional at additional cost. The print process does not allow for exact reproduction of the exterior or the upholstery colours. Not all colours are available with optional body coloured bumpers and/or roof height increases.

Please contact your Volkswagen Dealer for further information on colours and upholstery combinations.

# Volkswagen Choice

**Volkswagen Choice**

Guaranteed Future Value

Naturally we understand that your Volkswagen represents a valuable investment, so we understand that you want to maintain it in premium condition. Volkswagen Choice<sup>^</sup> is a finance program tailored to the requirements of Volkswagen owners by providing assurance around your Volkswagen's future value<sup>^</sup>, whilst offering simple monthly instalment financing options.

Whether you are selecting your new Volkswagen for business or personal use, you can choose the contract term that best suits your requirements. Enjoy the confidence that comes from having locked in a minimum value up front to be attributed to your vehicle at the end of your contract<sup>^</sup>. There are also no account keeping fees with a fixed interest rate.

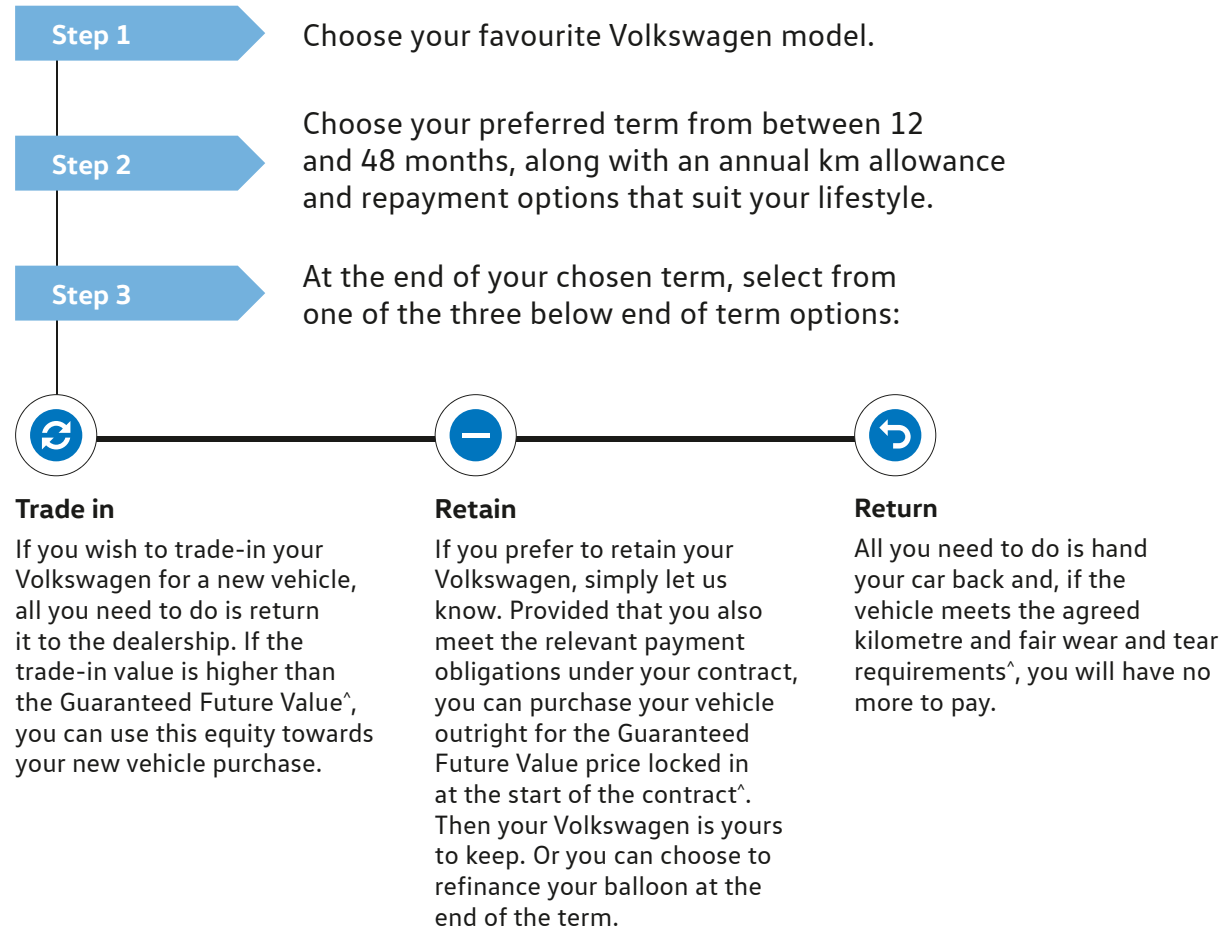

<sup>^</sup>The Volkswagen Choice Program consists of an option to return the vehicle to Volkswagen Financial Services (VFS)\*\* at the end of the term and require VFS to purchase the vehicle at price known as the Guaranteed Future Value (GFV) as determined by VFS. At the end of the term, you can elect to: (1) trade-in the vehicle; (2) exercise the option to return the vehicle; or (3) retain the vehicle by paying the GFV, which is a lump sum owed to VFS at the end of the loan term after all repayments have been made. You will be liable for any loan contract deficit and additional charges, if you exceed the nominated kilometre allowance and/or the vehicle is not in an acceptable condition. Available on new and demonstrator Volkswagen vehicles for selected models. Contact your nearest Volkswagen dealer to verify eligible vehicles for this program. Fleet, government, rental buyers, hire car and chauffeur companies excluded.

\*\*VFS is trading name of Volkswagen Financial Services Pty Ltd ABN 20 097 071 460, Australian Credit Licence 389344.



# Peace of Mind



## 5 years

### Unlimited Kilometre Warranty

At Volkswagen, we pride ourselves on the highest quality standards that come with German engineering.

We back this commitment with a 5 year unlimited kilometre warranty on all new Volkswagen vehicles\*.



## 1 year

### Roadside Assist

Every new Volkswagen comes with a 1 year Roadside Assist membership<sup>^</sup>.

That's 24 hour roadside assistance, emergency accommodation, car rental and towing as well as property and other assistance, all included for added peace of mind.



## Volkswagen

### Care Plans

Volkswagen Care Plans<sup>†</sup> have you covered for your first 3 or 5 scheduled services, providing you significant savings off the total Assured Service Pricing RRP. It's convenient, hassle-free scheduled servicing easily available for purchase at your local Volkswagen Dealer.



## Assured

### Service Pricing

Assured Service Pricing<sup>#</sup> gives you the transparency of knowing how much your service will cost up front.

Our Volkswagen Dealers have access to the latest diagnostic equipment and tools. Plus, they use Volkswagen Genuine Parts<sup>®</sup> to ensure your Volkswagen stays a Volkswagen.

You're in safe hands at your Volkswagen Dealer when it comes to servicing.

\*Conditions and exclusions apply, see <https://www.volkswagen.com.au/en/owners/warranty.html>. Your rights under this warranty are provided in addition to, and in some cases overlap with, consumer guarantees under the Australian Consumer Law and do not limit or replace them.

<sup>^</sup>Volkswagen Roadside Assist is provided by AWP Australia Pty Ltd ABN 52 097 227 177 trading as Allianz Global Assistance, under an arrangement with Volkswagen Group Australia Pty Limited ABN 14 093 117 876. Conditions and exclusions apply, see <https://www.volkswagen.com.au/en/owners/roadside-assist.html>.

<sup>†</sup>Volkswagen Care Plans are available at participating Volkswagen Dealers for all models and covers standard items as contained in each scheduled service interval only. These Care Plans can only be purchased prior to the first scheduled service and up to 22,500 km/15 months (whichever occurs first) for all models except Volkswagen Crafter models, which is 30,000 km/15 months (whichever occurs first). The timeframe takes effect from when the vehicle is first reported in our system as 'sold'. Discount structure varies by model. For details of what is not included in a scheduled service, please refer to the program terms and conditions available here: <https://www.volkswagen.com.au/en/owners/volkswagen-care-plans.html>

<sup>#</sup>Assured Service Pricing applies to the first 5 standard scheduled services of your vehicle which are scheduled to occur at every 15,000 km/12 month interval (whichever occurs first) or for Volkswagen Crafter models only, 20,000 km/12 month interval (whichever occurs first). On or before 31 December each year, Volkswagen will publish the maximum price for a specified Scheduled Service that will be applicable from, and remain fixed for, the following calendar year only. For details on the Eligible Model List, pricing, items not included and for full terms and conditions, please see <https://au.volkswagen.com.au/service-pricing-guide>.



Core V6

Sportline V6



Highline V6

Ultimate V6

# The Amarok

Volkswagen Group Australia Pty Ltd  
24 Muir Road Chullora NSW 2190  
ABN 14 093 117 876

Printed in Australia  
November 2019  
[www.volkswagen.com.au](http://www.volkswagen.com.au)

Publication: VWCAMARMY20

Your Volkswagen Dealer.

#### **Important information**

Apple CarPlay® is a registered trade mark of Apple Inc. Android Auto™ is a registered trade mark of Google Inc. MirrorLink® is a registered trade mark of Car Connectivity Consortium LLC. Bluetooth® is a registered trade mark of Bluetooth SIG Inc.

Volkswagen distributed by Volkswagen Group Australia Pty Ltd (ABN 14 093 117 876) of 24 Muir Road Chullora, NSW 2190. Specifications are as planned at November 2019, for Model Year 2020 and are subject to change without notice or obligation. All information in this brochure are correct at the time of publication, however variations may occur from time to time and Volkswagen, in so far as it is permitted by law to do so, shall not be liable in any way as a result of any reliance by any person on anything contained in this brochure. Authorised Volkswagen Dealers will provide up-to-date information on model application, design feature, prices, and availability on request.



Commercial  
Vehicles



# The Amarok V6 Specifications

# Features and Specifications

Safety and security	V6 TDI500 Core	V6 TDI550 Core	V6 TDI550 Sportline	V6 TDI550 Highline	V6 TDI580 Highline Black	V6 TDI580 Ultimate
<b>Airbags</b>						
Driver and front passenger airbags	●	●	●	●	●	●
Driver and front passenger side (head & thorax) airbags	●	●	●	●	●	●
<b>Seat belts</b>						
3 point seat belts for all passengers	●	●	●	●	●	●
Front height adjustable seat belts with pre-tensioners and belt force limiters	●	●	●	●	●	●
Outer rear seat belt pre-tensioners	●	●	●	●	●	●
Visual and acoustic warning for driver seat belt not fastened	●	●	●	●	●	●
<b>Child Restraints</b>						
Child seat top tether anchorage points (3)	●	●	●	●	●	●
ISOFIX child seat anchorage points, outer rear seats	●	●	●	●	●	●
<b>Brakes and Traction Control</b>						
Automatic flashing brake lights activated in emergency braking situation	●	●	●	●	●	●
Electronic Stabilisation Programme (ESP)	●	●	●	●	●	●
Electronic Brake-pressure Distribution (EBD)	●	●	●	●	●	●
Anti-lock Braking System (ABS)	●	●	●	●	●	●
Brake Assist	●	●	●	●	●	●
Anti-Slip Regulation (ASR)	●	●	●	●	●	●
Electronic Differential Lock (EDL)	●	●	●	●	●	●
Auto Hold function	●	●	●	●	●	●
Trailer Sway Stability Control (only with genuine tow bar wiring kit)	●	●	●	●	●	●
Mechanical Differential Lock	●	●	●	●	●	●
Multi-collision brake	●	●	●	●	●	●
Active Roll-over Prevention	●	●	●	●	●	●
<b>Driver Assistance Technology*</b>						
Off-road mode with optimised ABS, ESP, transmission and hill decent control	●	●	●	●	●	●
Parking distance sensors, rear with acoustic warning	●	●	—	—	—	—
Parking distance sensors, front and rear with acoustic warning	—	—	●	●	●	●
Optical Parking System (OPS) in radio/navigation display	●	●	●	●	●	●
Rear View Camera (RVC)	●	●	●	●	●	●
Dusk sensing headlight function	○	○	●	●	●	●
Rain sensing wipers	○	○	●	●	●	●

\*Safety technologies are designed to assist the driver, but should not be used as a substitute for safe driving practices.

● Standard   ○ Optional Extra   — Not available   A Volkswagen Genuine Accessory (Dealer fitted)

<b>Safety and security</b>	<b>V6 TDI500 Core</b>	<b>V6 TDI550 Core</b>	<b>V6 TDI550 Sportline</b>	<b>V6 TDI550 Highline</b>	<b>V6 TDI580 Highline Black</b>	<b>V6 TDI580 Ultimate</b>
<b>Lighting</b>						
Halogen headlamps	●	●	●	—	—	—
Bi-Xenon headlamps with integrated LED daytime driving lights, automatic self-levelling	—	—	—	●	●	●
Front fog lights	●	●	●	—	—	—
Front fog lights with static cornering lights	—	—	—	●	●	●
Separate headlight and fog light switch	●	●	●	●	●	●
Coming / leaving home function	○	○	●	●	●	●
Internal headlight range adjustment	●	●	●	●	●	●
Rear high mount stop light, LED	●	●	●	●	●	●
Tinted tail lights	—	—	●	●	●	●
Rear fog lamp	●	●	●	●	●	●
<b>Locking</b>						
Lockable rear tailgate with comfort closing	—	—	●	●	●	●
Electronic engine immobiliser	●	●	●	●	●	●
Alarm system with interior monitoring and SAFELOCK	—	—	—	●	●	●
Remote central locking with folding key	●	●	●	●	●	●
<b>Head Restraints</b>						
Rear head restraints height adjustable (3)	●	●	●	●	●	●

## Exterior Equipment / Styling

<b>Roof</b>						
Roof gutter inserts (Black)	●	●	●	●	●	●
Roof bar mounting points	●	●	●	●	●	●
Roof bars	A	A	A	A	A	A
Bicycle, kayak, ski, surfboard and snowboard holders	A	A	A	A	A	A
<b>Towbar</b>						
Towbar, with removable tongue	A	A	A	A	A	A
Wiring Kit - 7-pin flat trailer connector	A	A	A	A	A	A
<b>Windows</b>						
Power front / rear, with roll-back function and one touch up-down	●	●	●	●	●	●
Remote operated convenience close and open feature	●	●	●	●	●	●
Heat insulating tinted glass	●	●	●	●	●	●
Dark tinted rear side window and rear window glass, 65% light absorbing	—	—	●	●	●	●

Exterior Equipment / Styling	V6 TDI500 Core	V6 TDI550 Core	V6 TDI550 Sportline	V6 TDI550 Highline	V6 TDI580 Highline Black	V6 TDI580 Ultimate
<b>Body Enhancements</b>						
Painted door handles and exterior mirrors	—	—	●	●	●	●
Chrome radiator grille highlights with two double chrome strips	—	—	●	●	—	●
Chrome radiator grille highlights with single chrome strip	●	●	—	—	—	—
Chrome radiator grille with two gloss black and two chrome strips	—	—	—	—	●	—
Chrome rear step bumper	—	—	●	●	—	●
Matte black rear step bumper	●	●	—	—	●	—
Extended wheel arch flares	●	●	●	●	●	●
Side Steps (Stainless Steel)	A	A	A	●	—	—
Side Steps (Stainless Steel) - Illuminated	—	—	—	—	—	●
Side Bars (Gloss Black) - Without step	—	—	—	—	●	—
Styling Bar (Stainless Steel) - Standard type	A	A	A	●	—	—
Styling Bar (Stainless Steel) - Long type	—	—	—	—	—	●
Styling Bar (Gloss Black) Long type	—	—	—	—	●	—
Rolling cover (lockable)	A	A	A	A	A	A
Hard tonneau cover (lockable)	A	A	A	A	A	—
Soft tonneau cover	A	A	A	A	A	—
Canopy with side windows and rear door	A	A	A	A	A	A
<b>Protection</b>						
Underbody protection (engine) - plate type	●	●	—	—	—	—
Underbody protection (engine) - bar type	—	—	●	●	●	●
Mudflaps, front and rear	●	●	●	●	●	●
Durabed tubliner coating	—	—	—	—	—	●
Slimline weather shields (set of 4)	A	A	A	A	A	A
Bonnet protector - clear / tinted	A	A	A	A	A	A
Tubliner - 5 piece	A	A	A	A	A	—
Underbody protection (fuel tank)	A	A	A	A	A	A
<b>Wheels and Tyres</b>						
Alloy wheels (Posadas) 17 x 6.5" with 245/65 R17	●	●	—	—	—	—
Alloy wheels (Manaus) 18 x 7" with 255/60 R18	—	—	●	●	—	—
Alloy wheels (Cantera) 19 x 8" with 255/55 R19	—	—	—	○	—	—
Alloy wheels (Talca) 20 x 8" with 255/50 R20	—	—	—	—	—	●
Alloy wheels (Gloss black Talca) 20 x 8" with 255/50 R20	—	—	—	—	●	—
Tyre Pressure Monitoring System (TPMS)	—	—	—	●	●	●
Full size steel spare wheel	●	●	—	—	—	—
Full size alloy spare wheel	—	—	●	●	●	●
Tool kit with vehicle jack	●	●	●	●	●	●
Alloy wheels (various design 18" and 19") Please consult your Volkswagen Dealer for correct wheel and tyre fitment by model	A	A	A	A	A	A



<b>Comfort &amp; Convenience</b>	<b>V6 TDI500 Core</b>	<b>V6 TDI550 Core</b>	<b>V6 TDI550 Sportline</b>	<b>V6 TDI550 Highline</b>	<b>V6 TDI580 Highline Black</b>	<b>V6 TDI580 Ultimate</b>
<b>Air Conditioning</b>						
Dual-zone automatic climate control air conditioning	—	—	●	●	●	●
Single zone air-conditioning	●	●	—	—	—	—
<b>Cruise Control</b>						
Cruise Control with stalk mounted controls	●	●	●	●	●	●
<b>In-Car Entertainment and Technology</b>						
<u>Composition Media Audio system 6.33"</u>						
6.33" colour touch screen display, AM/FM radio with phase diversity tuner, CD player (MP3/WMA compatible). AUX and SD card slot and external USB input. Car menu with convenience and service settings.	●	●	●	—	—	—
<u>Discover Media audio and satellite navigation system 6.33"</u>						
6.33" colour touch screen display, AM/FM radio with phase diversity tuner, CD player (MP3/WMA compatible). AUX and SD card slot, external USB input, and four (4) speakers. Car menu with convenience and service settings.	—	—	—	●	●	●
App-Connect™ USB interface for Apple CarPlay®, Android Auto™ and MirrorLink® in centre console	●	●	●	●	●	●
Audio, telephone and Multi-Function Display controls mounted on steering wheel	●	●	●	●	●	●
Auxiliary input audio socket in centre console	●	●	●	●	●	●
Bluetooth® phone connectivity with contacts display, operation via touch screen audio unit or Multi-Function Display and Bluetooth® audio streaming	●	●	●	●	●	●
Speakers, front and rear (6)	●	●	●	●	●	●
Voice Control, telephone and navigation functions	●	●	●	●	●	●
<b>Instrumentation</b>						
Multi-Function Display (MFD Plus) monochrome display – driving time, trip length, average and current speed, average and current fuel consumption, distance till empty, speed warning function, vehicle status, audio, telephone, navigation and convenience menus	●	●	●	●	●	—
Multi-Function Display (MFD Premium) colour display and screen transitions with animations – driving time, trip length, average and current speed, average and current fuel consumption, tyre pressure indicator setting, distance till empty, speed warning function, vehicle status, audio, telephone, navigation and convenience menus	—	—	—	—	—	●
<b>12 V socket</b>						
Centre console and dashboard	—	—	●	●	●	●
Centre console	●	●	●	●	●	●
Second row centre console	—	—	●	●	●	●
Cargo area	—	—	●	●	●	●
<b>Interior Lighting</b>						
Interior lights - door operated with reading lights, front and rear	—	—	●	●	●	●
Interior lights - door operated with reading lights, front	●	●	—	—	—	—

<b>Comfort &amp; Convenience</b>	<b>V6 TDI500 Core</b>	<b>V6 TDI550 Core</b>	<b>V6 TDI550 Sportline</b>	<b>V6 TDI550 Highline</b>	<b>V6 TDI580 Highline Black</b>	<b>V6 TDI580 Ultimate</b>
<b>Interior Trims</b>						
Aluminium-look decorative inserts in dashboard	—	—	●	●	●	●
Chrome highlight trim to air vent and rotary light switch	—	—	●	●	●	●
Chrome highlights to mirror adjustment and power window switches	—	—	●	●	●	●
Leather covered steering wheel and gearshift knob	●	●	●	●	●	●
Aluminium finish accelerator and brake pedals	—	—	—	—	—	●
Rubber floor covering in cab	●	●	—	—	—	—
Carpet floor covering in cab	—	—	●	●	●	●
Carpet mats, front and rear with decorative stitching	A	A	A	A	A	●
Front and rear, rubber mats	A	A	A	A	A	A
<b>Mirrors</b>						
Electric adjusted door mirrors with heating function	●	●	●	●	●	●
Unpainted black exterior mirrors	●	●	—	—	—	—
Colour-painted exterior mirrors with chrome highlights	—	—	●	●	—	●
Gloss black painted exterior mirrors	—	—	—	—	●	—
<b>Steering Wheel</b>						
3 spoke leather covered steering wheel	●	●	●	●	●	●
Steering wheel mounted gearshift paddles	—	—	—	—	—	●
Audio, telephone and Multi-Function Display controls	●	●	●	●	●	●
Height and reach adjustable steering wheel	●	●	●	●	●	●
<b>Seating</b>						
Cloth seat upholstery - Austin trim	●	●	—	—	—	—
Cloth seat upholstery - Salipra trim	—	—	●	●	●	—
Vienna leather appointed seat upholstery#	—	—	—	○	○	—
Cloth seat upholstery - micro-fibre	—	—	—	○	○	—
Nappa leather appointed seat upholstery#	—	—	—	—	—	●
Manual height adjustment - front	●	●	●	●	●	—
ErgoComfort driver's seat with 14-way adjustment with seat cushion tilt adjustment, cushion depth adjustment and electric adjustment for backrest and lumbar	—	—	—	—	—	●
Individually heated front seats	—	—	—	○	○	●
Rear seat backrest forward folding	●	●	●	●	●	○
Rear seat base split folding (60/40)	●	●	●	●	●	●
<b>Grab Handles</b>						
Roof line folding grab handles (4)	●	●	●	●	●	●
B-pillar fixed grab handles (2)	●	●	●	●	●	●
A-pillar fixed grab handle (1)	●	●	●	●	●	●

#Leather appointed seats have a combination of genuine and artificial leather, but are not wholly leather.

● Standard   ○ Optional Extra   — Not available   A Volkswagen Genuine Accessory (Dealer fitted)

<b>Comfort &amp; Convenience</b>	<b>V6 TDI500 Core</b>	<b>V6 TDI550 Core</b>	<b>V6 TDI550 Sportline</b>	<b>V6 TDI550 Highline</b>	<b>V6 TDI580 Highline Black</b>	<b>V6 TDI580 Ultimate</b>
<b>Storage</b>						
Centre console armrest with storage compartment	●	●	●	●	●	●
Storage under front seats	—	—	●	●	●	—
Door pockets, front and rear	●	●	●	●	●	●
Front seat backrest storage pockets	●	●	●	●	●	●
Driver's and passenger's side vanity mirrors	●	●	●	●	●	●
Compartment with lid in roof console	—	—	●	●	●	●
Lockable glove compartment	●	●	●	●	●	●
Rear centre floor cup holders (2)	—	—	●	●	●	●
Bottle holders in front and rear door pockets	●	●	●	●	●	●
<b>Tray Body</b>						
Lashing rings for load restraining (4)	●	●	●	●	●	●
Cargo area light	●	●	●	●	●	●
12 volt socket	—	—	●	●	●	●

## Optional Equipments

<b>Interior</b>						
Vienna leather appointed seat upholstery <sup>#</sup>	—	—	—	○	○	—
Micro-fibre seat upholstery	—	—	—	○	○	—
Individually heated front seats	—	—	—	○	○	●
<b>Paint</b>						
Metallic, Pearl or Matte effect paint finish	○	○	○	○	○	○

<sup>#</sup>Leather appointed seats have a combination of genuine and artificial leather, but are not wholly leather.

# Technical Specification

Engine	3.0 litre V6 TDI500	3.0 litre V6 TDI550	3.0 litre V6 TDI580
Type	6 cylinder turbo diesel, 24 valve	6 cylinder turbo diesel, 24 valve	6 cylinder turbo diesel, 24 valve
Installation	Longitudinal	Longitudinal	Longitudinal
Cubic capacity, litres/cc	3.0 / 2,967	3.0 / 2,967	3.0 / 2,967
Bore/stroke, mm	83.0 / 91.4	83.0 / 91.4	83.0 / 91.4
Max power, kW @ rpm	165 @ 3,250 - 4,500	165 @ 2,500 - 4,500	190 @ 3,250 - 4,500
Max torque, Nm @ rpm	500 @ 1,250 - 3,000	550 @ 1,500 - 2,500	580 @ 1,400 - 3,000
Compression ratio	17.0:1	17.0:1	17.0:1
Fuel system	Bosch EDC17 electronic engine control unit	Bosch EDC17 electronic engine control unit	Bosch EDC17 electronic engine control unit
Exhaust emission control	Water-cooled exhaust gas recirculation (EGR), catalytic converter and diesel particulate filter (DPF)	Water-cooled exhaust gas recirculation (EGR), catalytic converter and diesel particulate filter (DPF)	Water-cooled exhaust gas recirculation (EGR), catalytic converter and diesel particulate filter (DPF)
Fuel type (Recommended)	Diesel EN 590	Diesel EN 590	Diesel EN 590
Fuel tank capacity, litres	80	80	80
Battery	520 Amp 92Ah (AGM)	520 Amp 92Ah (AGM)	520 Amp 92Ah (AGM)
<b>Transmission</b>	<b>6 Speed Manual</b>	<b>8 Speed Automatic</b>	<b>8 Speed Automatic</b>
Driven wheels	4x4 (4MOTION) Selectable	4x4 (4MOTION) Permanent	4x4 (4MOTION) Permanent
Gear Ratio	1st Gear: 5.070 2nd Gear: 2.614 3rd Gear: 1.524 4th Gear: 1.000 5th Gear: 0.770 6th Gear: 0.657 Reverse Gear: 4.823	1st Gear: 4.714 2nd Gear: 3.143 3rd Gear: 2.106 4th Gear: 1.667 5th Gear: 1.285 6th Gear: 1.00 7th Gear: 0.839 8th Gear: 0.667 Reverse Gear: 3.317	1st Gear: 4.714 2nd Gear: 3.143 3rd Gear: 2.106 4th Gear: 1.667 5th Gear: 1.285 6th Gear: 1.00 7th Gear: 0.839 8th Gear: 0.667 Reverse Gear: 3.317
<b>Fuel Consumption**</b>			
Combined, L/100km	9.7	9.1	8.9
Urban, L/100km	11.4	10.6	9.6
Extra Urban, L/100km	8.6	8.3	8.5
CO <sub>2</sub> emission, g/km	254	240	234

\*\*Fuel consumption figures according to Australian Design Rule (ADR) 81/02 derived from laboratory testing. Factors including but not limited to driving style, road and traffic conditions, environmental influences, vehicle condition and accessories fitted, will in practice in the real world lead to figures which generally differ from those advertised. Advertised figures are meant for comparison amongst vehicles only.

# Technical Specification

## Chassis

Full-length ladder frame chassis in high strength steel

Fully galvanised body with 6 year anti-corrosion perforation warranty

## Running Gear

### Suspension

Front axle

Transverse link with A-frame arm double wishbone and anti-roll bar

Rear axle

Multi-layer rigid axle with leaf spring and stabiliser bar

### Steering

Power assisted rack & pinion steering (Hydraulic)

### Brake size

Front, mm

332, Ventilated Discs

Rear, mm

300, Ventilated Discs

### Brake systems

ESP, off-road ABS, ASR, EDL, Hill Holder, Brake Assist, Traction Control and Off-Road ABS including Hill Decent

### Turning circle, metres

12.95

## Towbar Capacity\*

Braked kg (TDI500)

3,500 (3,000)

Unbraked kg

750

Towbar load limit kg

300

≠When fitted with Volkswagen Genuine Tow Bar. Towing capacities are applicable to Volkswagen Genuine Accessory Tow Bar. Towing capacity figures are maximum figures and actual towing capacity depends on factors including the laden mass of the vehicle, driving conditions and fitment of any accessories. Volkswagen Group Australia does not endorse or will not be held liable for any claim, loss or damage arising from the use or fitment of electronic trailer brakes.  
Figures in (brackets) relate to Amarok V6 Core with manual transmission only

# Measurements and Dimensions

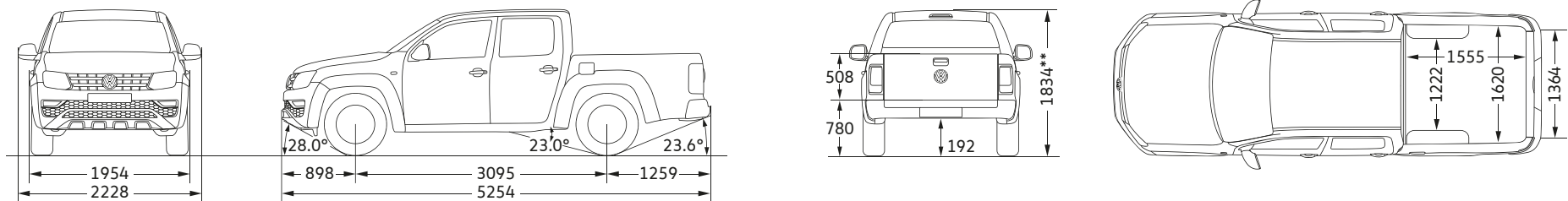

\*Height shown without sports bar.

# Measurements and Dimensions

Weights <sup>^</sup>	3.0 litre V6 (TDI500)/TDI550/TDI580
Unladen Mass <sup>1</sup> Kg's	
Core	2,091 (2,076)
Sportline	2,104
Highline	2,147
Highline 580 black	2,209
Ultimate	2,244
Payload <sup>‡</sup> kg	
Core	989 (1,004)
Sportline	976
Highline	933
Highline 580 black	871
Ultimate	836
Gross Vehicle Mass (GVM) kg	3,080
Gross Combined Mass (GCM) kg	6,000 (5,550)
Roof load kg	100
<b>Exterior Dimensions<sup>^</sup></b>	
Overall length mm	5,264
Width mm	1,954
Width incl. mirrors mm	2,228
Height, mm (HL)	1,878 <sup>^</sup>
Height, mm (SL / UL / Core / HL black)	1,834
Wheelbase mm	3,095
Ground clearance, mm	192
Entry angle	28.0°
Departure angle	23.6°
Ramp angle	23.0°
Wading depth, mm	500
Track mm	
Front <sup>**</sup>	1,654
Rear <sup>**</sup>	1,658
<b>Tray Dimensions<sup>^</sup>#</b>	
Length, mm	1,555
Width mm (Max.)	1,620
Width mm (between wheel arches)	1,222
Tail gate opening mm (Max.)	1,364
Height (tail gate) mm	508
load area m <sup>2</sup>	2.52
Tie down points	4
Height from ground mm	780

<sup>^</sup>Including styling bar.

<sup>1</sup> The Unladen Mass (UM) includes 10L of fuel, vehicle fluids and no occupants. Figures quoted are for base model vehicles only.

<sup>‡</sup>Payload is defined as the Gross Vehicle Mass (GVM) minus the Kerb Mass. Payload is the maximum combined weight of occupants, cargo, added structures and tow ball down weight (when towing). GVM must not be exceeded.

<sup>#</sup>Please note figures are sourced from overseas data where equipment levels by model variant may vary.

Figures in (brackets) relate to Amarok V6 Core with manual transmission only.

<sup>\*\*</sup>Track figures are based on rim off-set of 45.

# Colours

## Solid paint finishes



**Candy White** | Solid paint finish | B4B4



**Tornado Red\*** | Solid paint finish | G2G2  
\*Not available on Amarok V6 Core

## Matte paint finish



**Ravenna Blue\*\*** | Matte paint finish | 9547  
\*Available on Amarok V6 Ultimate only.



**Indium Grey\*\*** | Matte paint finish | 9709  
\*Available on Amarok V6 Ultimate only.

## Metallic and Pearlescent paint finishes



**Mojave Beige** | Metallic paint finish | 1B1B



**Ravenna Blue\*** | Metallic paint finish | 5Z5Z  
\*Available on Amarok V6 Ultimate/ HL black only.



**Indium Grey** | Metallic paint finish | X3X3



**Reflex Silver** | Metallic paint finish | 8E8E



**Starlight Blue** | Metallic paint finish | 3S3S



**Deep Black** | Pearl paint finish | 2T2T



**Peacock Green Metallic** | Metallic paint finish | 8U8U  
\*Available on Amarok V6 Ultimate only.

## Seat upholstery



**Austin**  
Cloth seat upholstery | Titanium Black and Moon Rock Grey

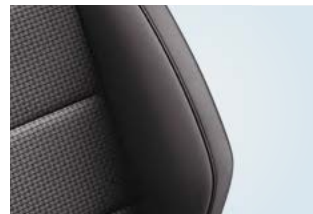

**Salipra**  
Cloth seat upholstery | Palladium



**Vienna**  
Leather seat upholstery\* | Palladium



**Micro-fibre**  
Cloth seat upholstery | Titanium black



**Nappa**  
Leather seat upholstery\* | Black with seams in Ceramique

#Leather appointed seats have a combination of genuine and artificial leather, but are not wholly leather.

+Matte paint requires special care. If matte paint is not cleaned and maintained properly, the finish may be altered or damaged.

Please note that Metallic, Matte and Pearl affect paint are optional at additional cost. The print process does not allow for exact reproduction of the exterior or the upholstery colours. Not all colours are available with optional body coloured bumpers and/or roof height increases. Please contact your Volkswagen Dealer for further information on colours and upholstery combinations.

# The Amarok V6

Volkswagen Group Australia Pty Ltd  
24 Muir Road Chullora NSW 2190  
ABN 14 093 117 876

Printed in Australia  
November 2019  
[www.volkswagen.com.au](http://www.volkswagen.com.au)

Publication:VWCAMARV6SLSPECMY20

Your Volkswagen Dealer.

#### **Important information**

Apple CarPlay® is a registered trade mark of Apple Inc. Android Auto™ is a registered trade mark of Google Inc. MirrorLink® is a registered trade mark of Car Connectivity Consortium LLC. Bluetooth® is a registered trade mark of Bluetooth SIG Inc.

Volkswagen is distributed by Volkswagen Group Australia Pty Ltd (ABN 14 093 117 876) of 24 Muir Road Chullora, NSW 2190. Specifications are as planned at November 2019 for model year 2020 and are subject to change without notice or obligation. All information in this brochure are correct at the time of publication, however variations may occur from time to time and Volkswagen, in so far as it is permitted by law to do so, shall not be liable in any way as a result of any reliance by any person on anything contained in this brochure. Authorised Volkswagen Dealers will provide up-to-date information on model application, design feature, prices, and availability on request.