

EastCoast<sup>®</sup>  
Mouldings

THE BOOK OF STANDARD

# EC MOULDING PROFILES

CROWN

DOOR & WINDOW

BASE

CHAIR RAIL

MISC.

BOARD & PANEL



The “EC” prefix, as a moulding pattern identifier, is the trusted symbol of high quality and consistent shapes within the millwork industry.

EastCoast<sup>®</sup>  
Mouldings

The “EC” prefix was developed by EastCoast Mouldings as a way to create consistent standards and efficiency for modern mass production, while maintaining the highest quality.

Each profile is crafted with precision and the latest digital technology to be architecturally correct. This assures that each profile is recreated with quality, consistency and exact detail, allowing profiles to accurately match in the future for homeowners to easily repair or remodel the moulding profiles in a home.

More than 1,000 different moulding profiles are offered by EastCoast Mouldings.

Note: This catalog is produced to assist dealers, builders, architects, designers and home owners in choosing the moulding patterns best suited for almost any application. An end view of each profile is shown in full scale.

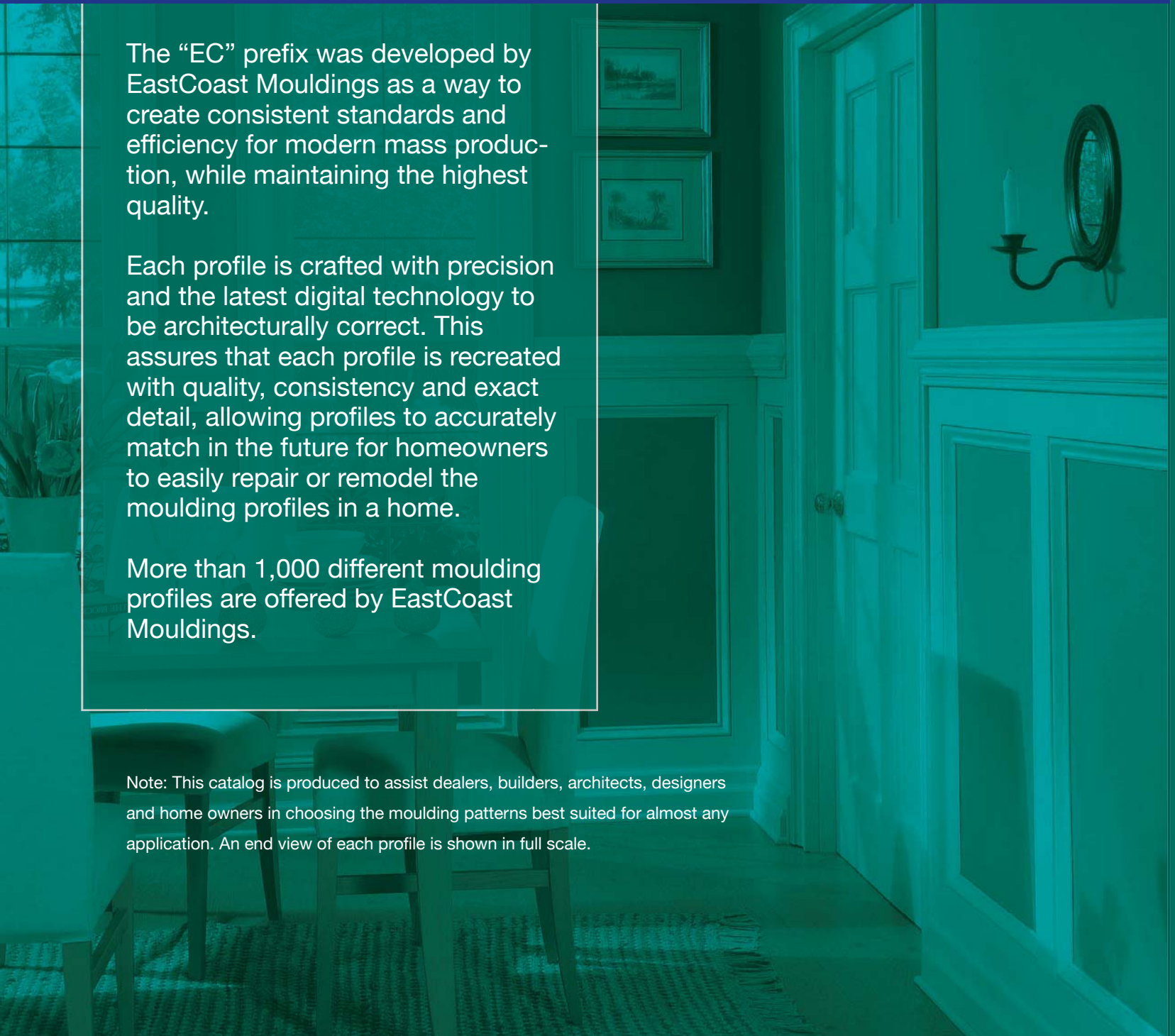

# What is GEARScan?



Notice the use of a special, patent pending GEARScan barcode next to all the moulding profiles throughout this catalog. These unique barcodes will also be added to other forms of literature, displays and samples.

Users of our ECMDGears mobility app will be able to scan this code and get a real time display of the items associated with that profile showing the dealer's price without requiring each item to be selected individually.

ECMDGears users can view the availability of those related items and easily convert it into an order.

## 4 CROWN MOULDINGS

- 4-12 | CROWN
- 8-10 | DENTIL

## 13 DOOR & WINDOW TRIM

- |                   |                 |
|-------------------|-----------------|
| 13-18   CASING    | 18-19   STOOL   |
| 13-14   BACK BAND | 18   BRICK MOLD |
| 16-17   APRON     | 21   MULLION    |
| 20   ROSETTE      | 21   STOP       |
| 20   PLINTH       | 21   ASTRAGAL   |

## 24 BASE MOULDINGS

- 24-30 | BASE
- 24-25 | BASE CAP
- 26 | SHOE
- 27 | QUARTER ROUND
- 28 | COVE

## 31 CHAIR RAILS

- 31-33 | CHAIR RAIL
- 33 | CHAIR RAIL BACKER
- 34 | PANEL MOULD

## 35 MISCELLANEOUS

- |                       |                    |
|-----------------------|--------------------|
| 35   FULL ROUND       | 36   PICTURE MOULD |
| 35   HAND RAIL        | 36   SCREEN BEAD   |
| 36   CORNER           | 37   SHINGLE       |
| 36   CABINET MOULDING | 37   CHAMFER       |
| 36   HALF ROUND       | 38   S4S           |

## 39 BOARD AND PANEL

- 39 | S4S
- 40-41 | PATTERN STOCK
- 42-43 | RUSTIC SHIPLAP

## 42 PRODUCT SELECTION

- 44-47 | MATCHING GUIDE
- 48 | GEARSCAN
- 49 | NOTES
- 50-51 | PRODUCT SELECTION

# CROWN MOULDINGS

Including: Crown and Dentils

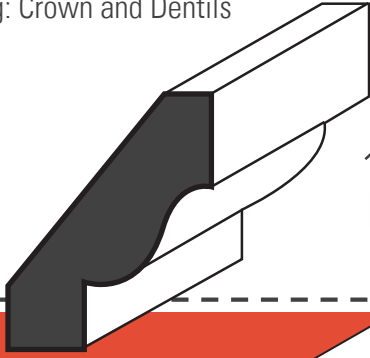

**EC 60**  
1-3/4"  
GEARScan  
000060



**EC 58**  
2-3/4"  
GEARScan  
000058

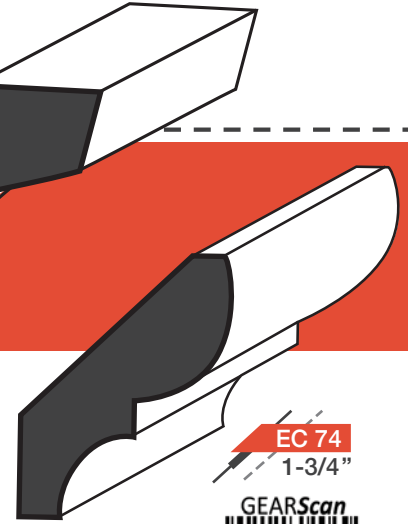

**EC 74**  
1-3/4"  
GEARScan  
000074



**EC 838**  
8-3/8"  
GEARScan  
000838



**EC 550**  
5-1/2"  
GEARScan  
000550



**EC 718**  
7-1/8"  
GEARScan  
000718

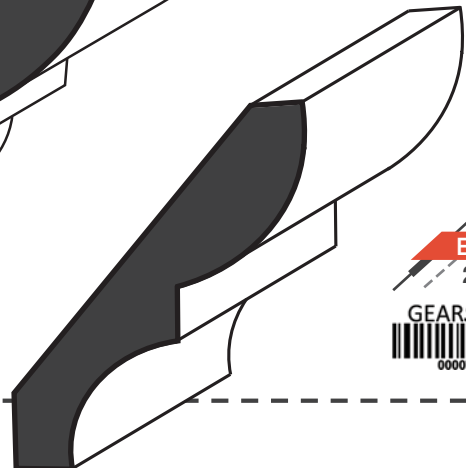

**EC 70**  
2-3/4"  
GEARScan  
000070

# CROWN MOULDINGS

Including: Crown and Dentils

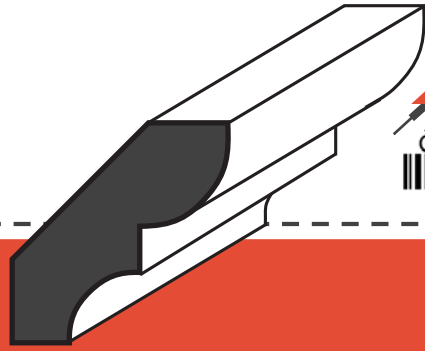

**EC 75**  
1-5/8"  
GEARScan  
000075

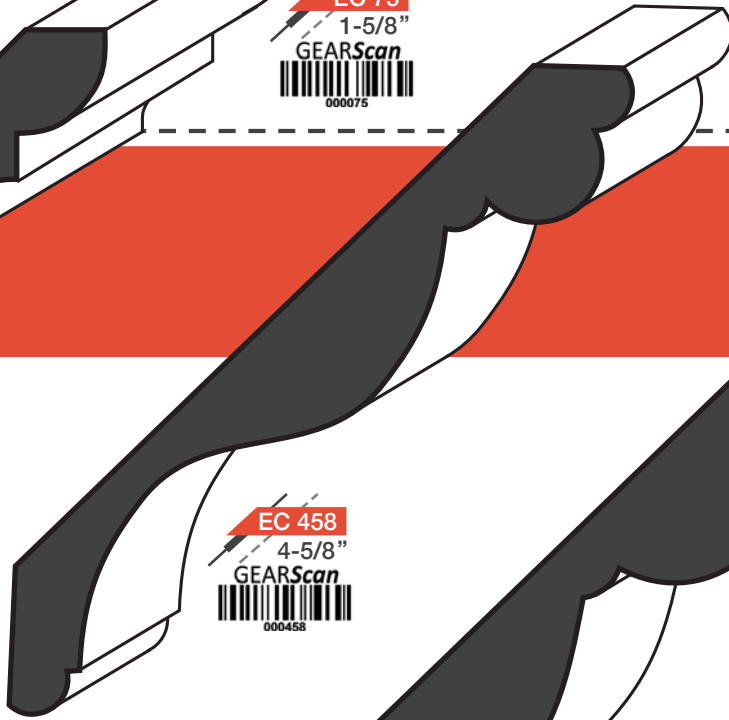

**EC 458**  
4-5/8"  
GEARScan  
000458

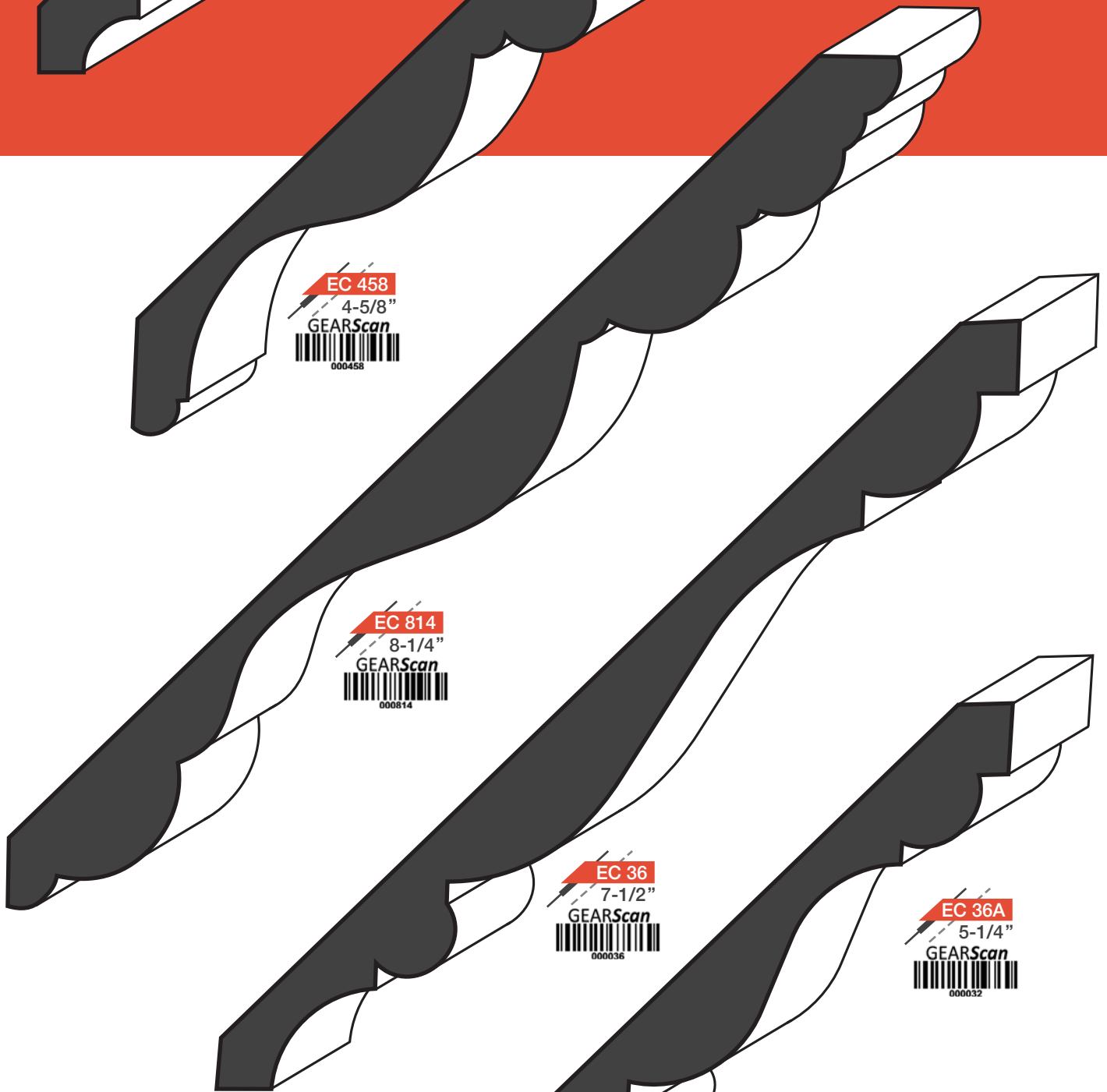

**EC 814**  
8-1/4"  
GEARScan  
000814

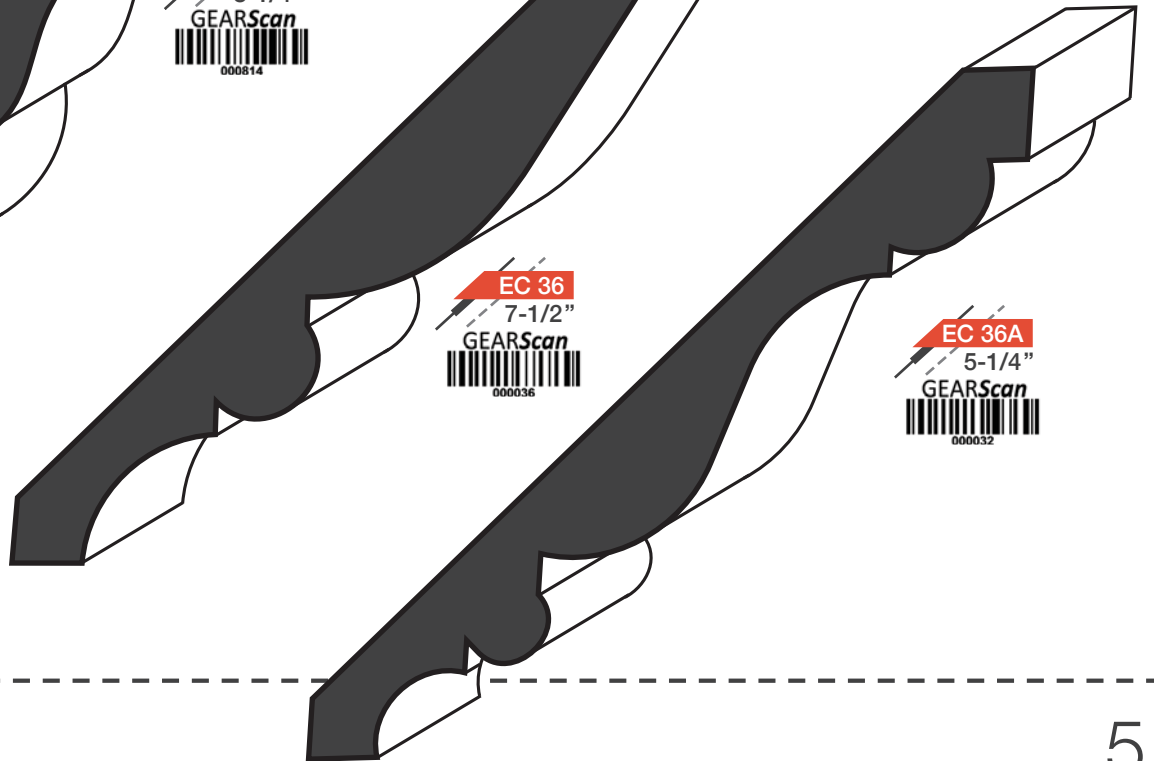

**EC 36**  
7-1/2"  
GEARScan  
000036

**EC 36A**  
5-1/4"  
GEARScan  
000032

# CROWN MOULDINGS

Including: Crown and Dentils

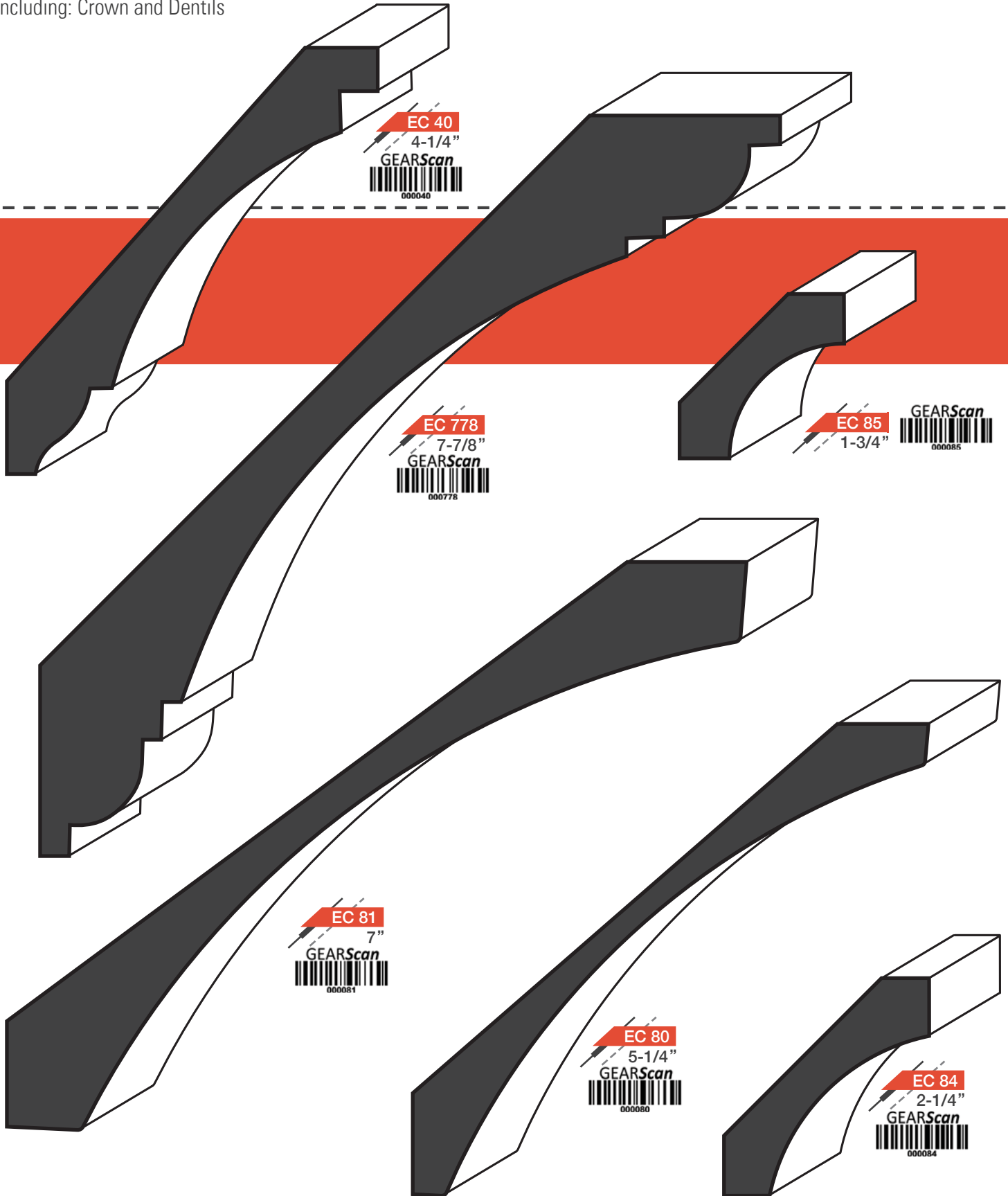

**CROWN MOULDINGS**

Including: Crown and Dentils

**EC 39**  
5-3/8"  
GEARScan  
000039

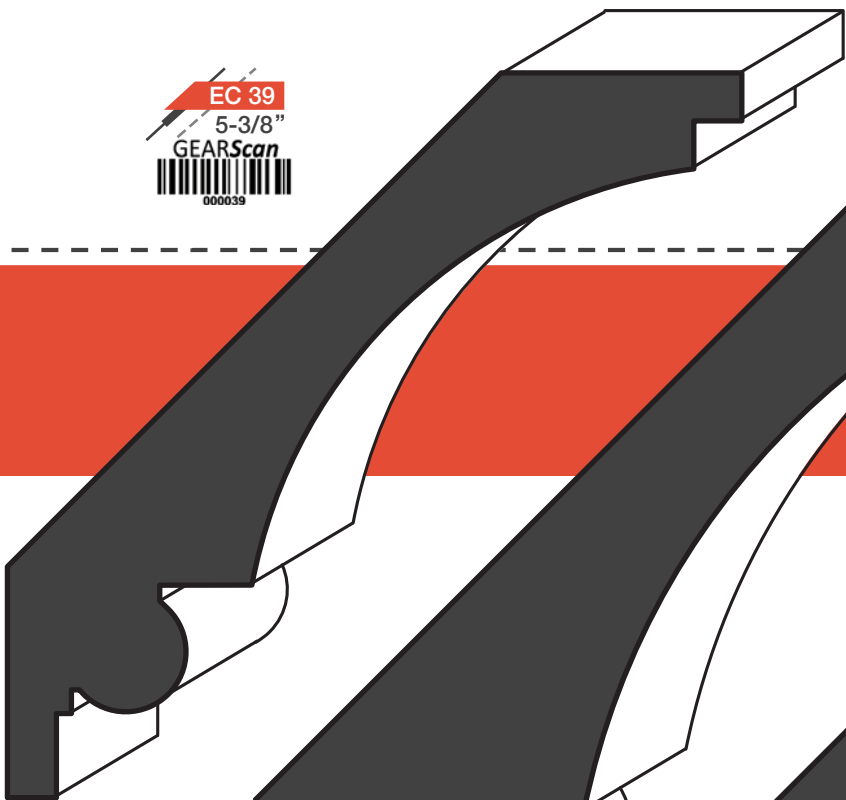

**EC 50**  
5-1/4"  
GEARScan  
000050



**EC 24**  
7-3/4"  
GEARScan  
000024



**EC 33**  
6-1/4"  
GEARScan  
000033

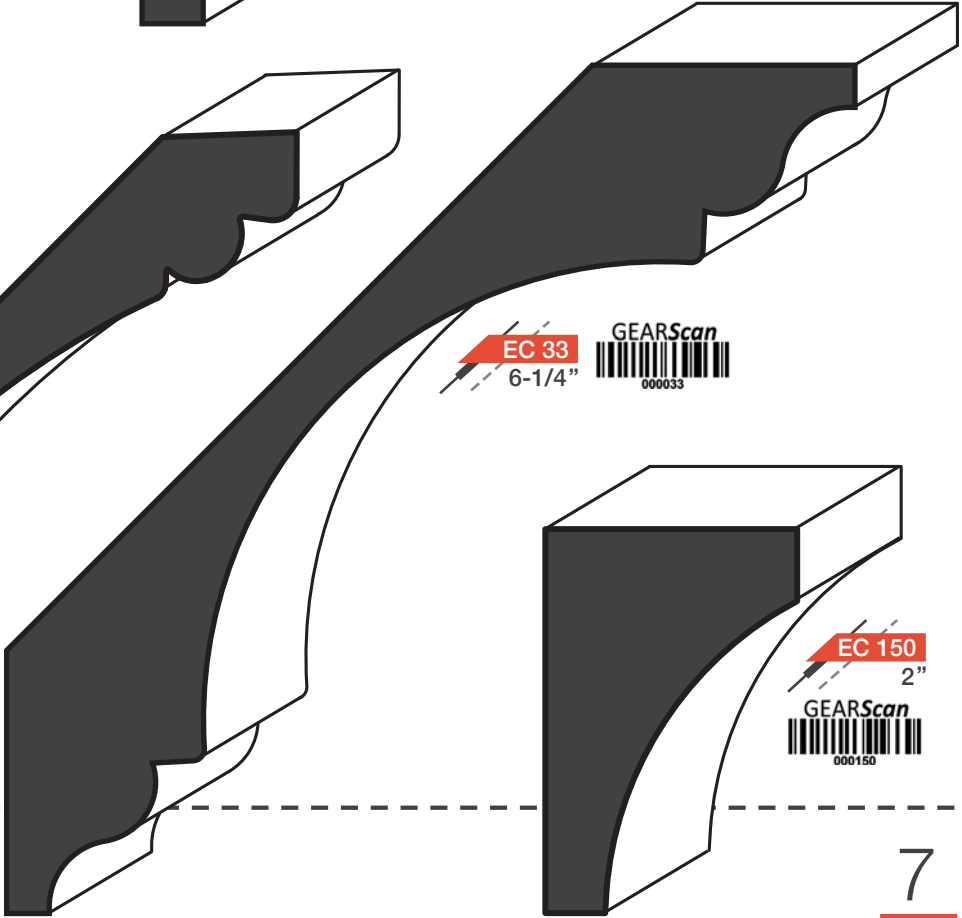

**EC 501**  
5-1/2"  
GEARScan  
000501



**EC 150**  
2"  
GEARScan  
000150

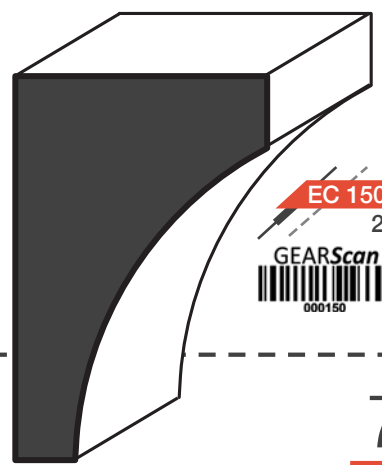

# CROWN MOULDINGS

Including: Crown and Dentils

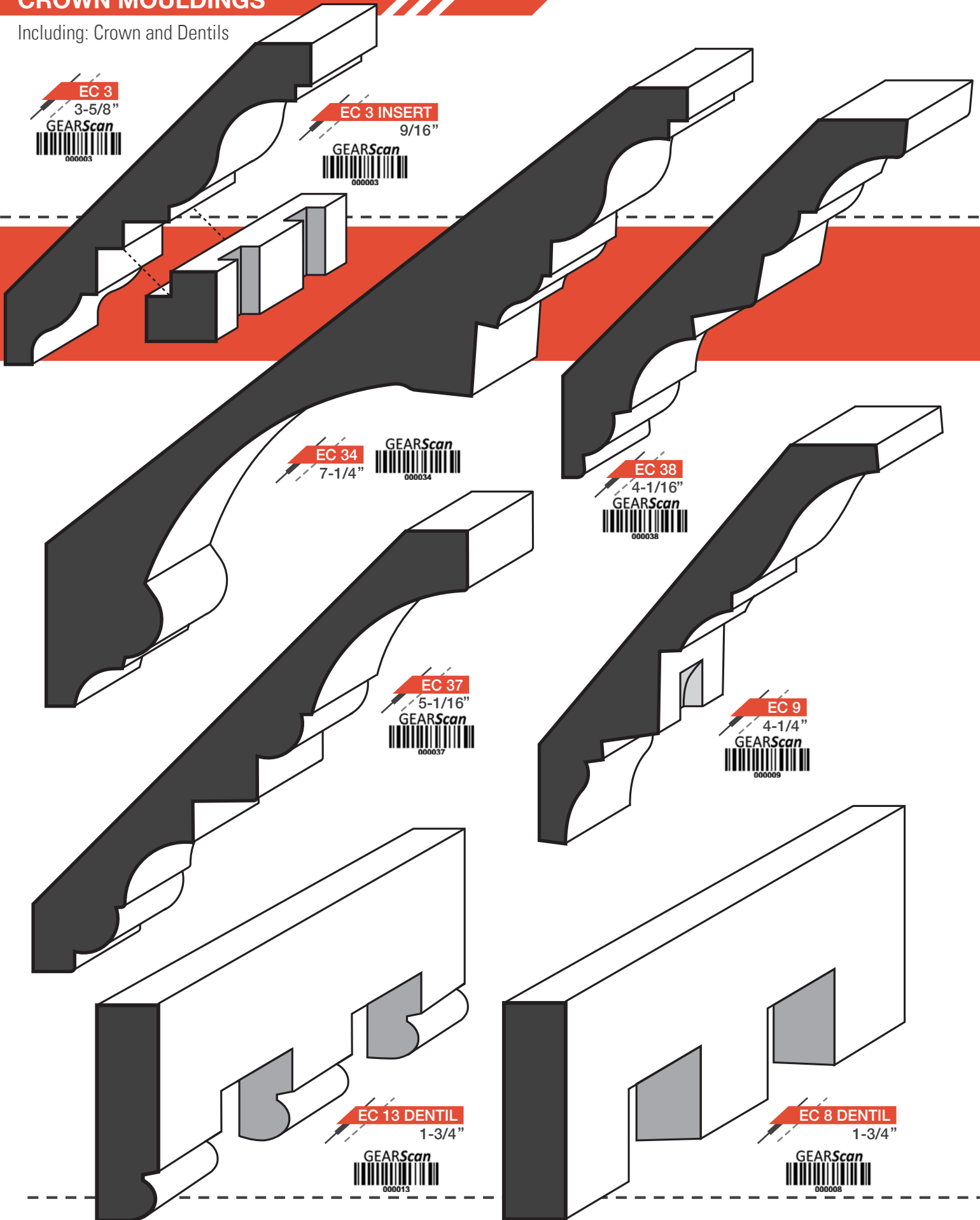



# CROWN MOULDINGS

Including: Crown and Dentils

**EC 18**  
4-1/4"  
GEARScan  
000018

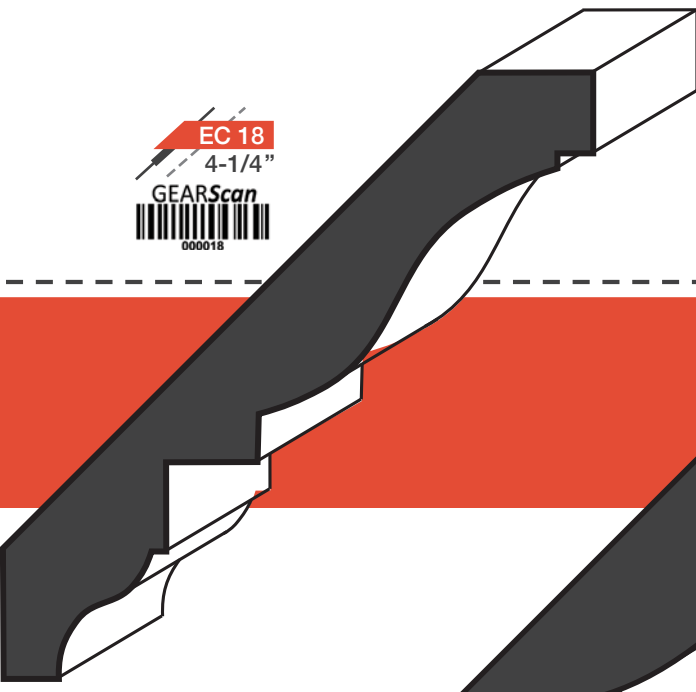

**EC 738**  
7-3/8"  
GEARScan  
000738

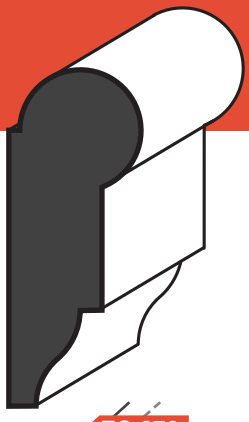
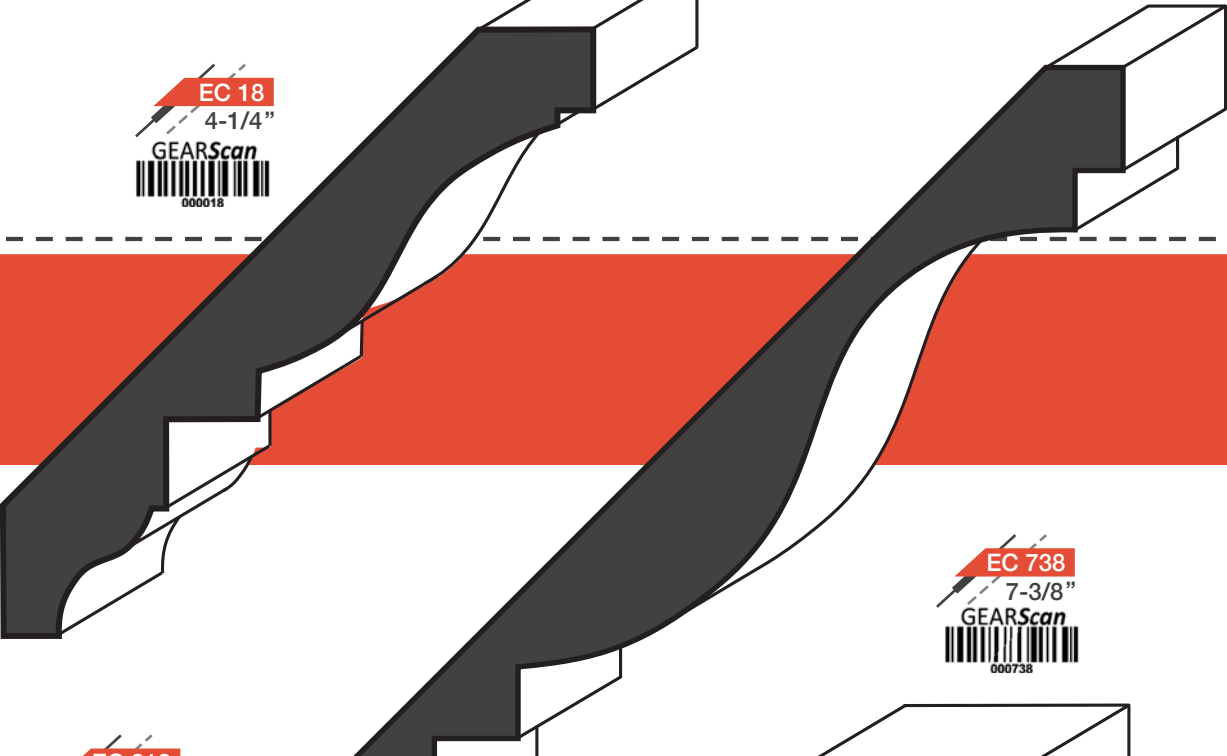

**EC 273**  
1-3/4"  
GEARScan  
000273

**EC 818**  
8-1/8"  
GEARScan  
000818



**EC 61**  
6"  
GEARScan  
000061

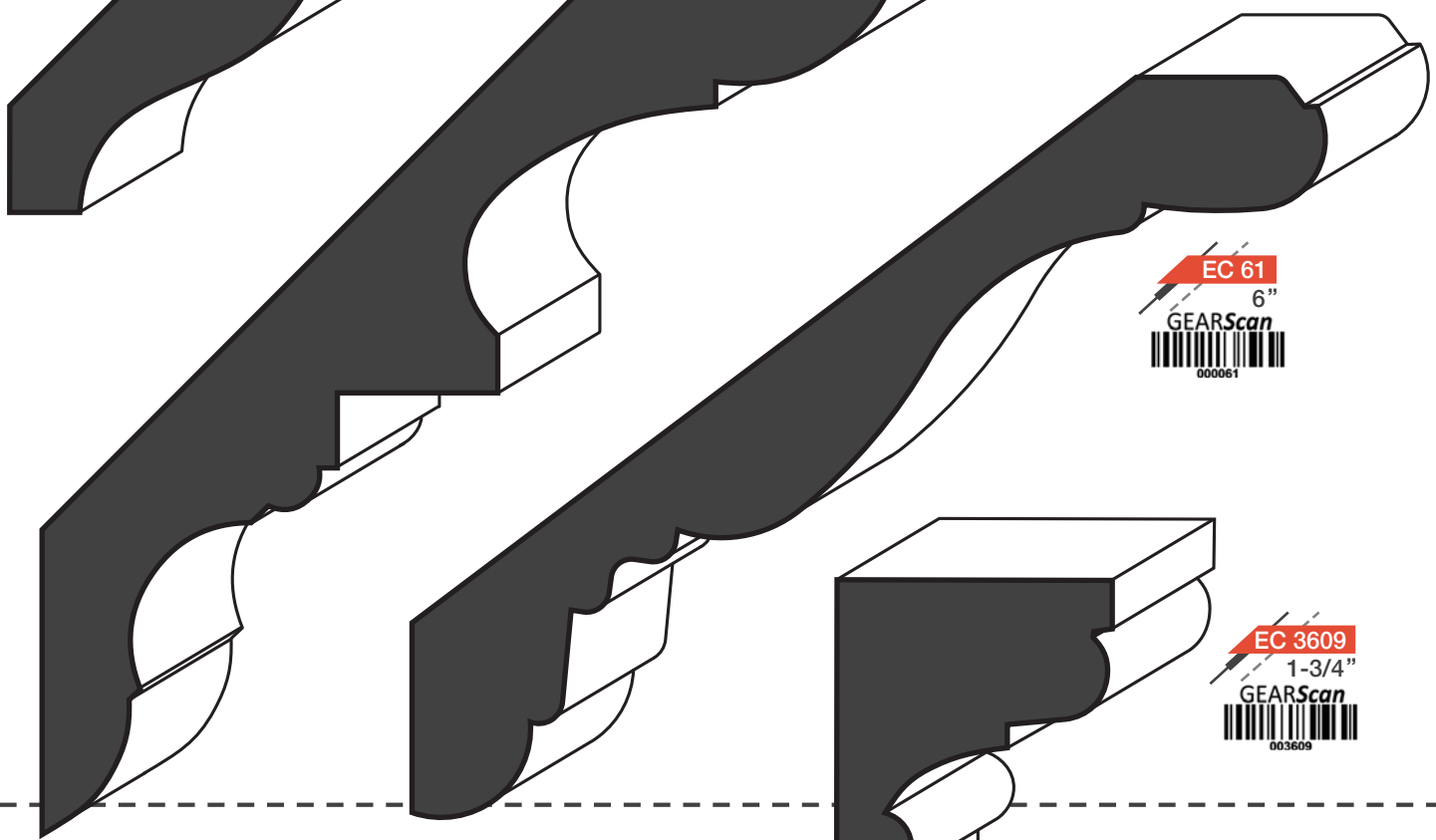

**EC 3609**  
1-3/4"  
GEARScan  
003609

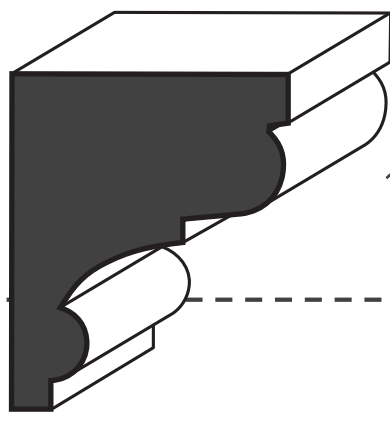

# CROWN MOULDINGS

Including: Crown and Dentils

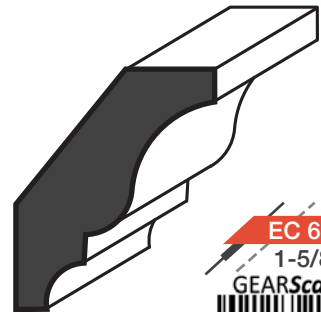
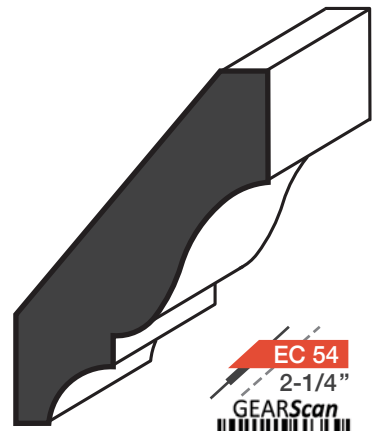
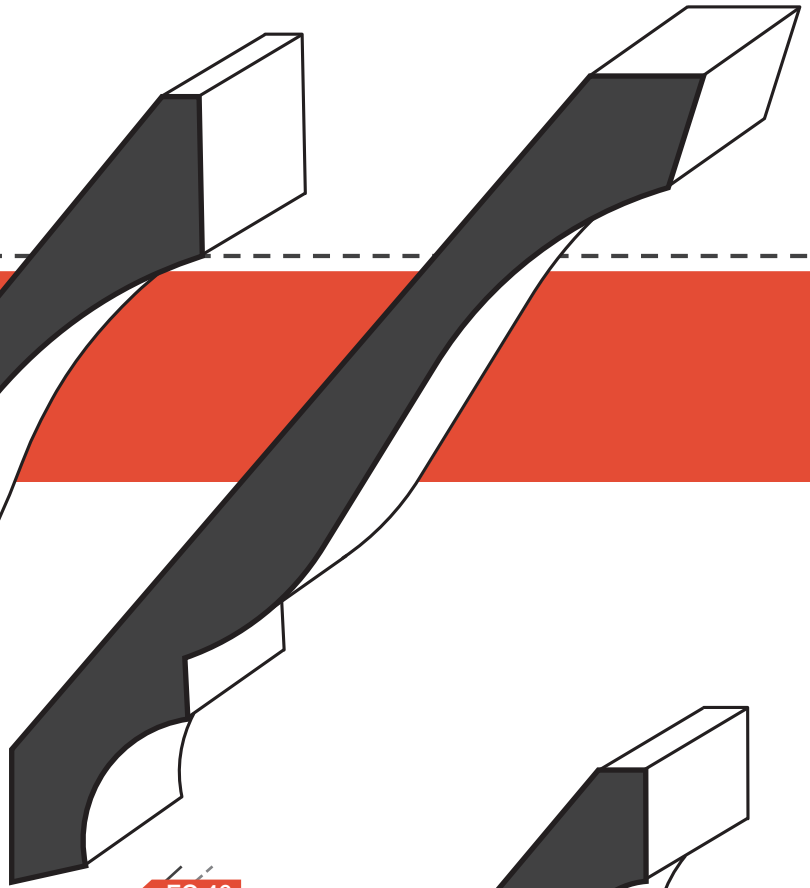

**A** EC 49 | Crown

**B** EC 623 | Base Inverted

# CROWN MOULDINGS

Including: Crown and Dentils

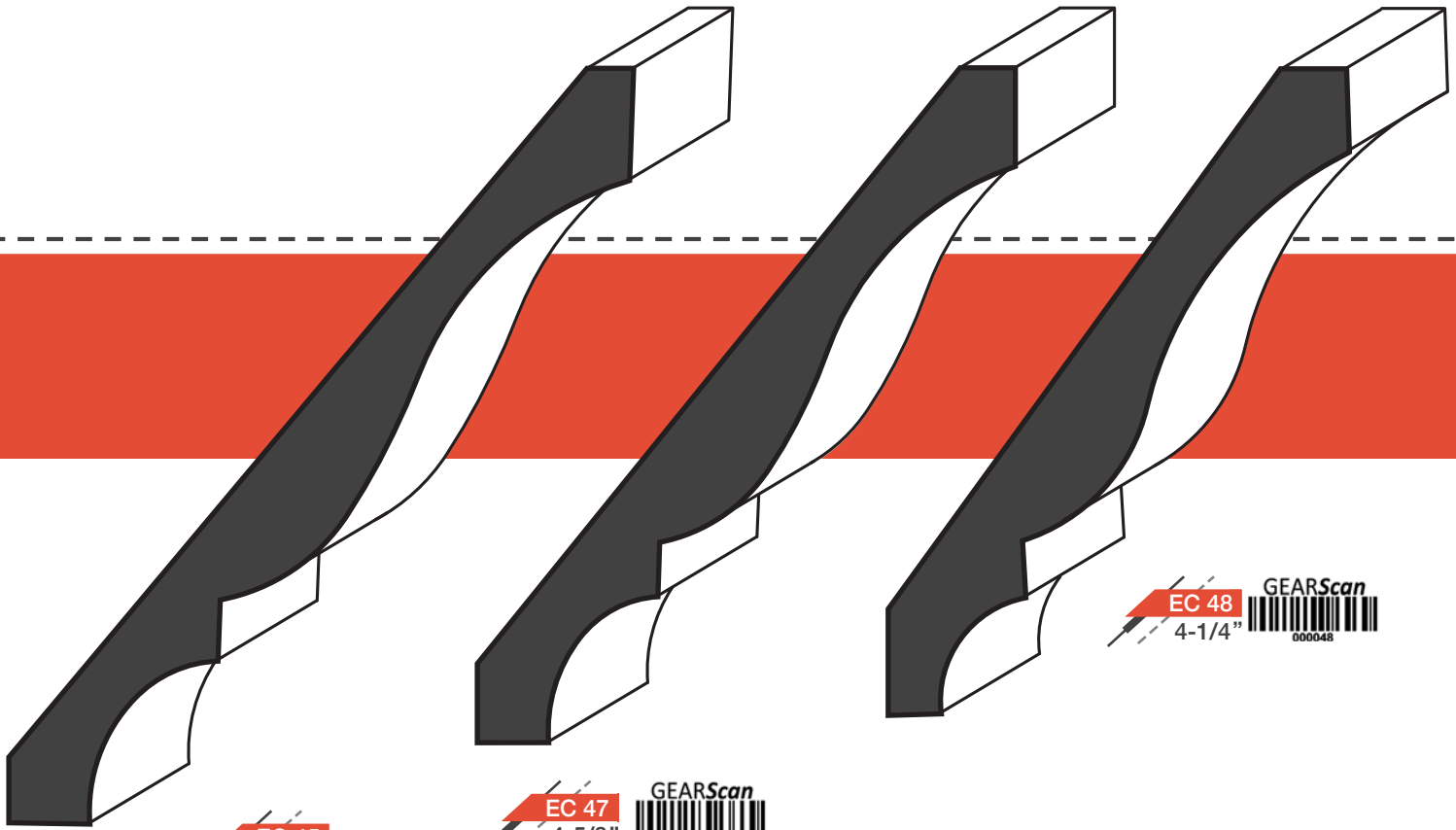

**EC 45**  
5-1/4"  
GEARScan  
000045

**EC 47**  
4-5/8"  
GEARScan  
000047

**EC 48**  
4-1/4"  
GEARScan  
000048

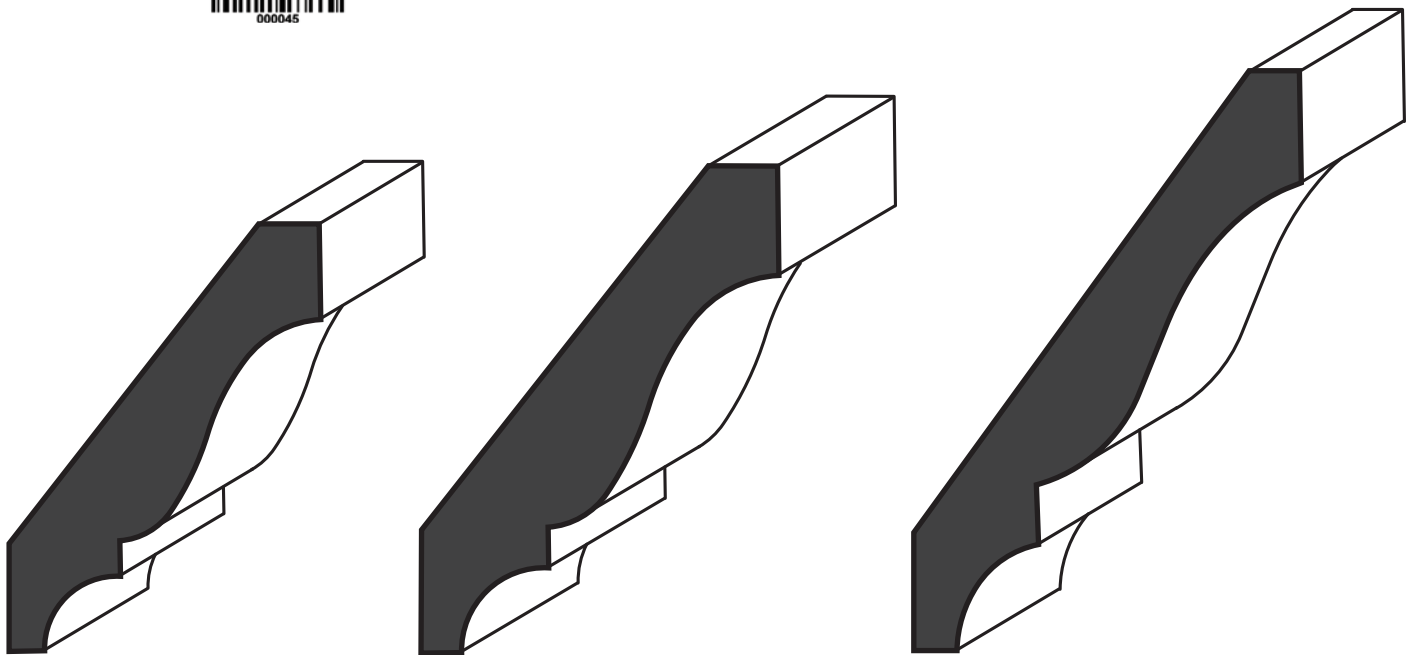

**EC 52**  
2-3/4"  
GEARScan  
000052

**EC 51**  
3-1/4"  
GEARScan  
000051

**EC 49**  
3-5/8"  
GEARScan  
000049

# CROWN MOULDINGS

Including: Crown and Dentils

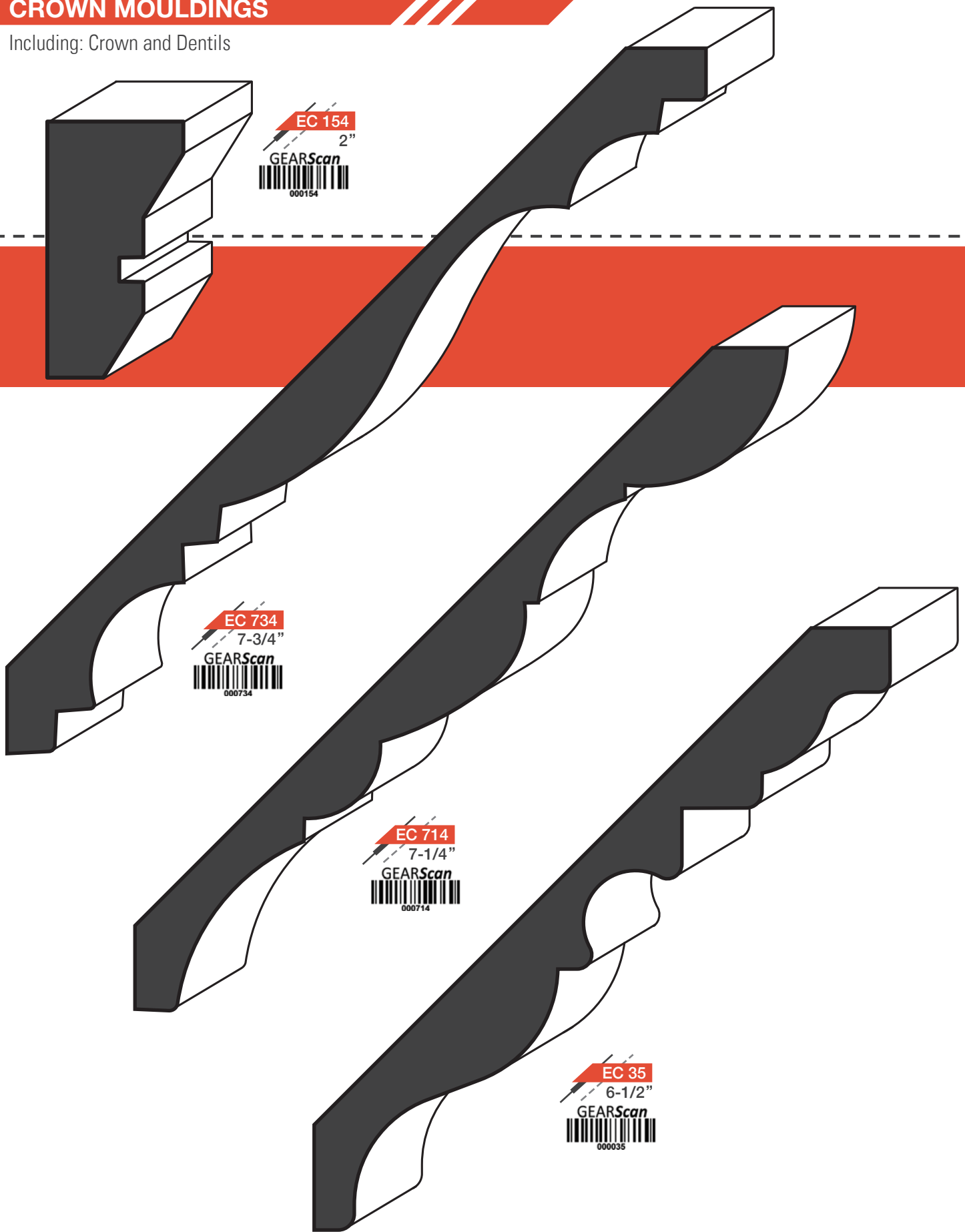

# DOOR AND WINDOW TRIM

Including: Back Bands, Rosettes, Plinths, Stops, Astragals, Stools, Aprons and Mullions

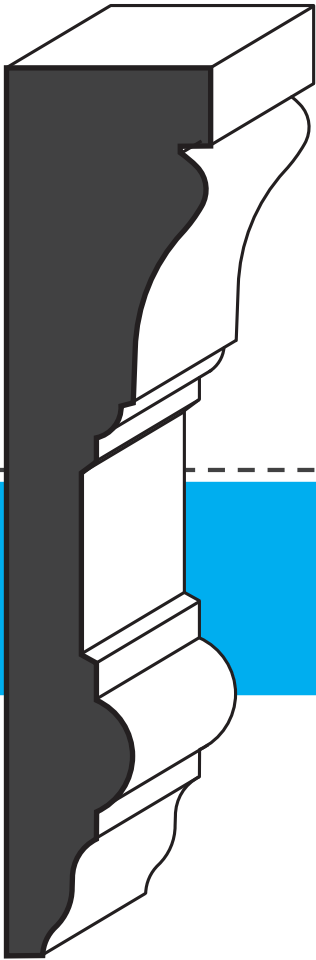

**EC 466**  
4-5/8"  
GEARScan  
000466

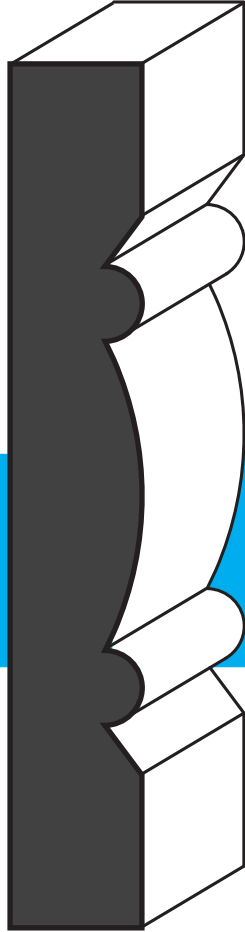

**EC 412**  
4-1/2"  
GEARScan  
000412

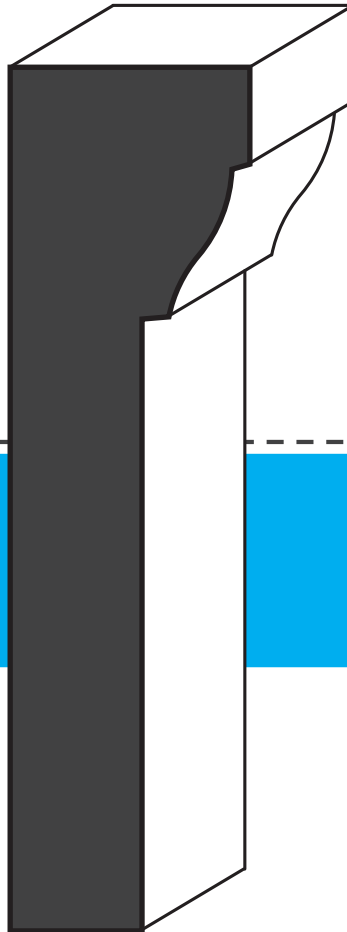

**EC 190**  
4-1/2"  
GEARScan  
000190

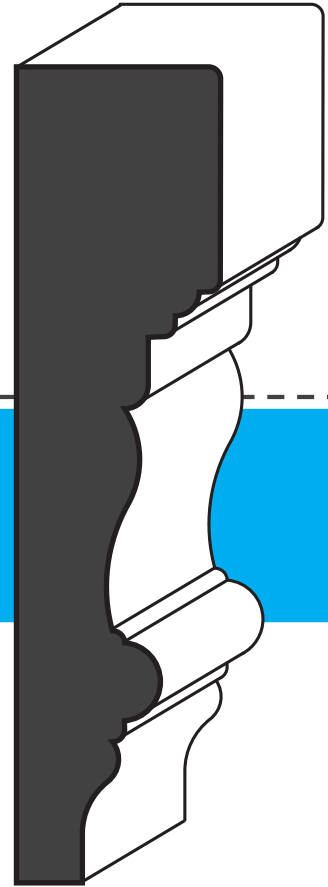

**EC 414**  
4-1/4"  
GEARScan  
000414

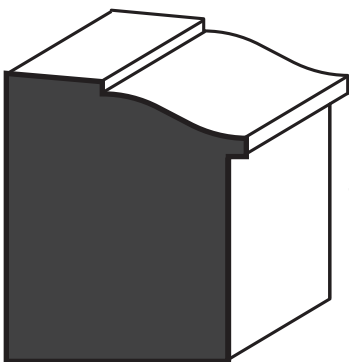

1-1/16"

**EC 284**  
1-1/2"  
GEARScan  
000284

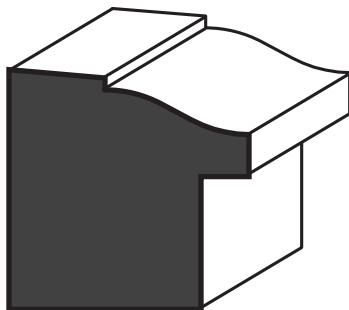

11/16"

**EC 284A**  
1-1/4"  
GEARScan  
000285

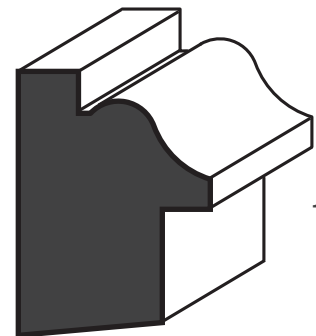

11/16"

**EC 282**  
1-3/8"  
GEARScan  
000282

# DOOR AND WINDOW TRIM

Including: Back Bands, Rosettes, Plinths, Stops, Astragals, Stools, Aprons and Mullions

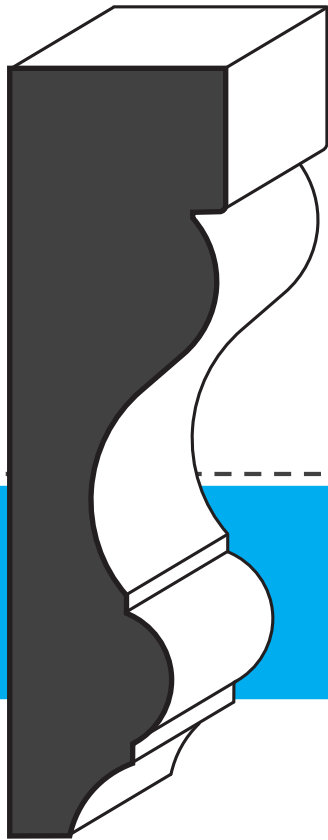

**EC 436** 4" 

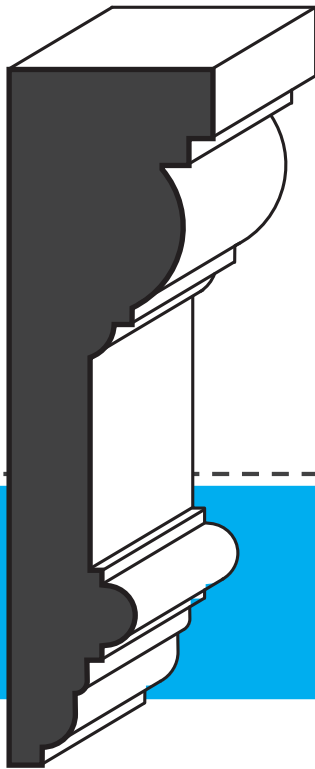

**EC 446** 3-5/8" 



**EC 460** 3-11/16" 

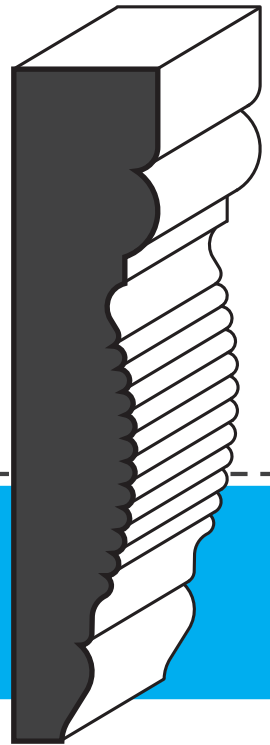

**EC 453** 3-1/2" 

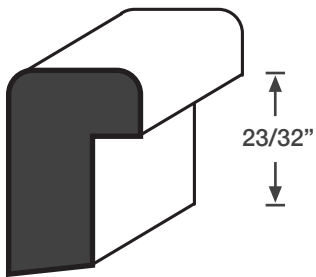

**EC 280** 1-1/16" 

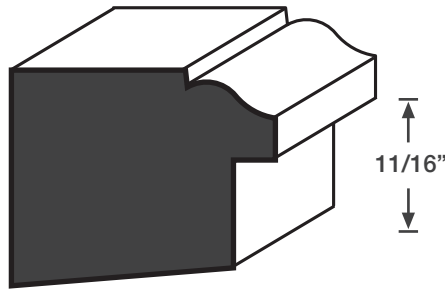

**EC 283** 1-3/8" 

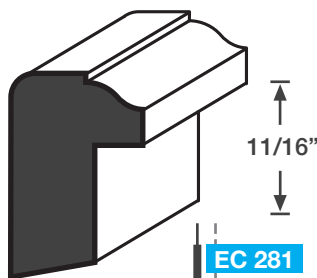

**EC 281** 1-1/16" 

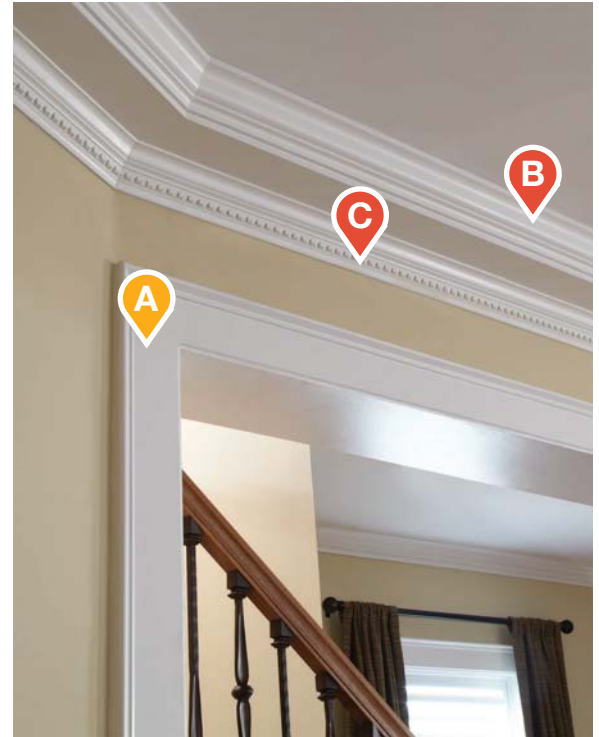

- A** 1 x 4 w/ EC 163 | Cap
- B** EC 45 | Crown
- C** EC 9 | Dentil

# DOOR AND WINDOW TRIM

Including: Back Bands, Rosettes, Plinths, Stops, Astragals, Stools, Aprons and Mullions

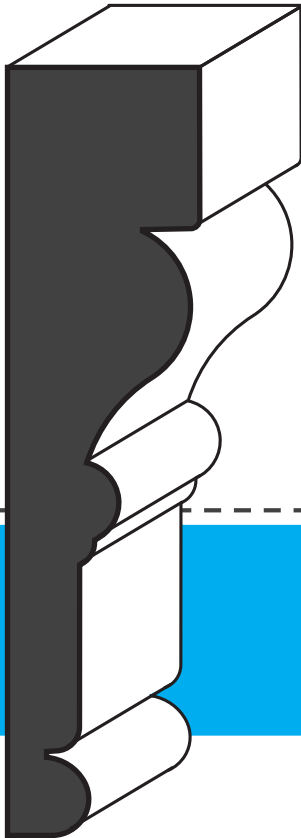

EC 4  
4"  
GEARScan  
000004

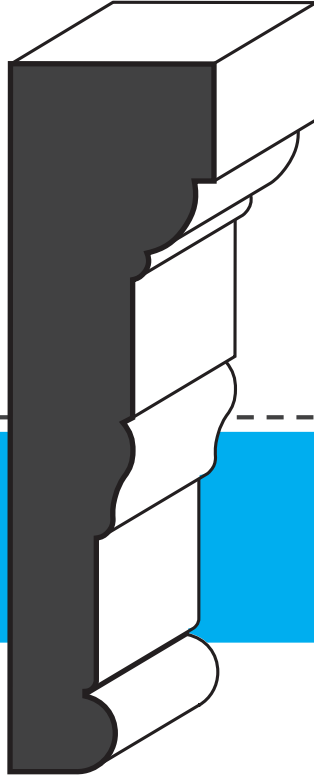

EC 470  
3-11/16"  
GEARScan  
000470

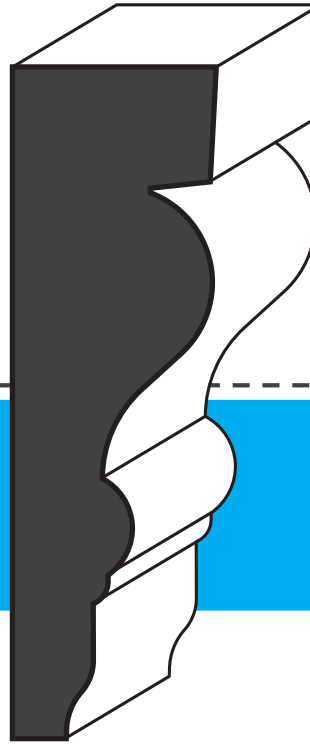

EC 464  
3-1/2"  
GEARScan  
000464

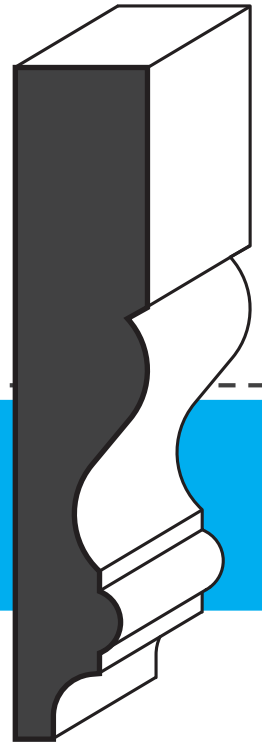

EC 350  
3-1/2"  
GEARScan  
000350

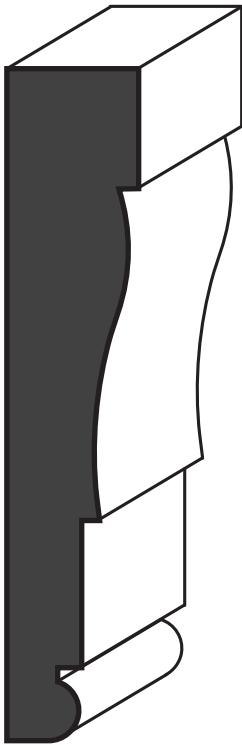

EC 445A  
3-1/2"  
GEARScan  
000441

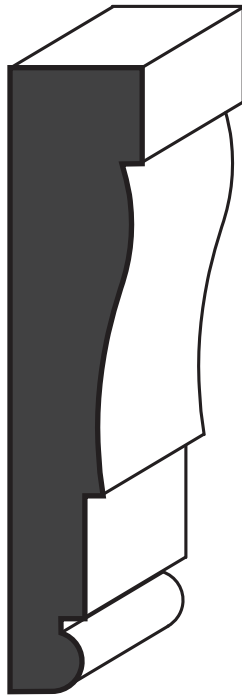

EC 445  
3-1/4"  
GEARScan  
000445

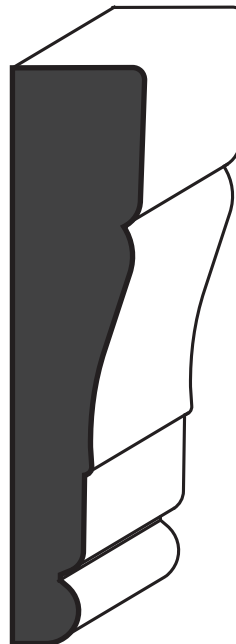

EC 371  
3"  
GEARScan  
000371

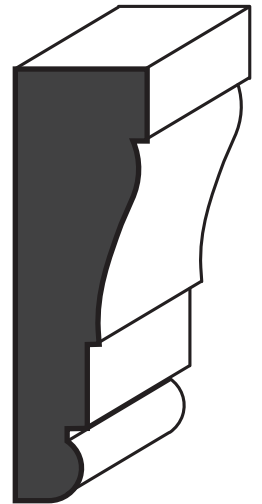

EC 376  
2-1/4"  
GEARScan  
000376

# DOOR AND WINDOW TRIM

Including: Back Bands, Rosettes, Plinths, Stops, Astragals, Stools, Aprons and Mullions

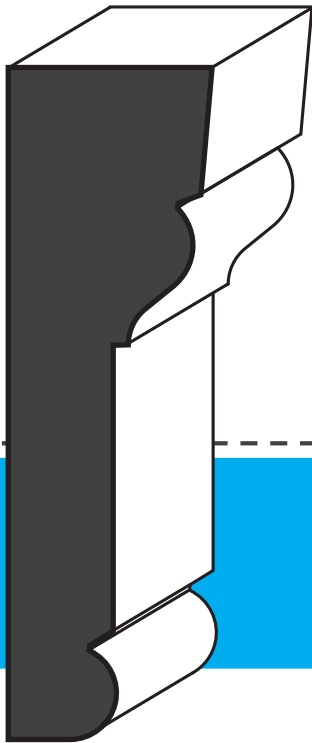

EC 20  
3-1/2"  
GEARScan  
000020

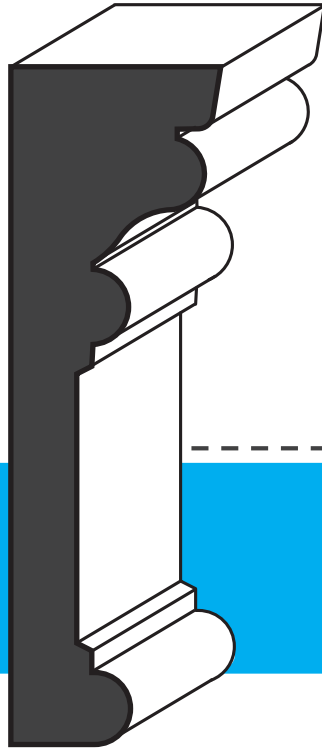

EC 1  
3-1/2"  
GEARScan  
000400

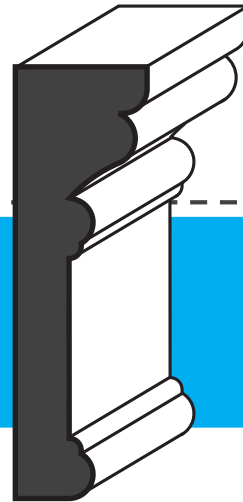

EC 401  
2-1/4"  
GEARScan  
000401

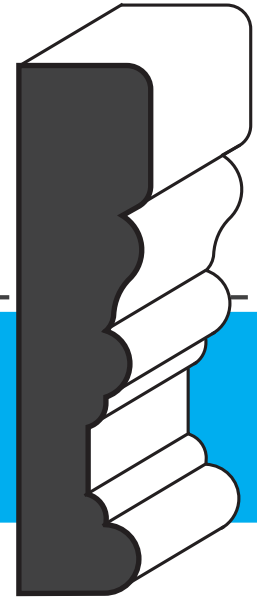

EC 402  
2-3/4"  
GEARScan  
000402

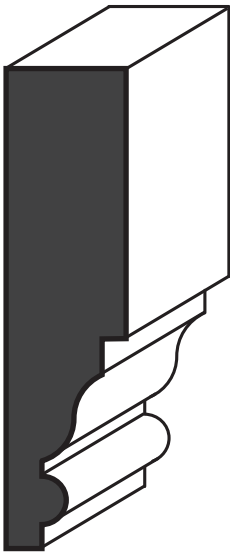

EC 12  
2-1/2"  
GEARScan  
000012

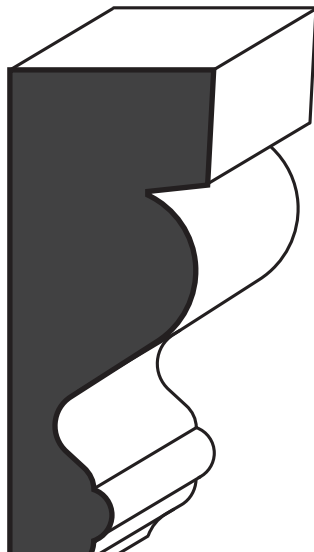

EC 463  
2-3/4"  
GEARScan  
000463



EC 455  
3-1/2"  
GEARScan  
000455

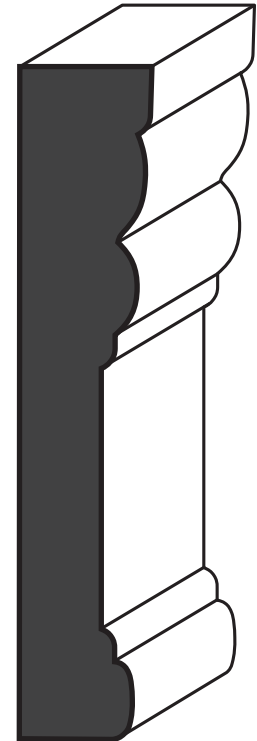

EC 480  
3-1/2"  
GEARScan  
000480



# DOOR AND WINDOW TRIM

Including: Back Bands, Rosettes, Plinths, Stops, Astragals, Stools, Aprons and Mullions

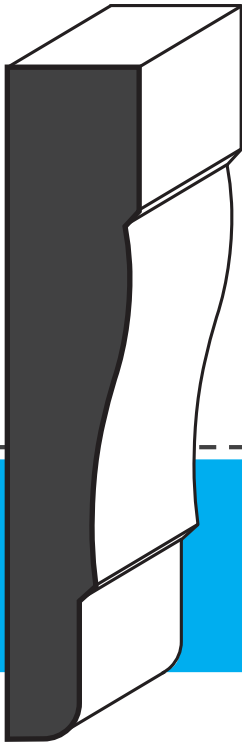

**EC 444A** 3-1/2" **GEARScan**  
000443

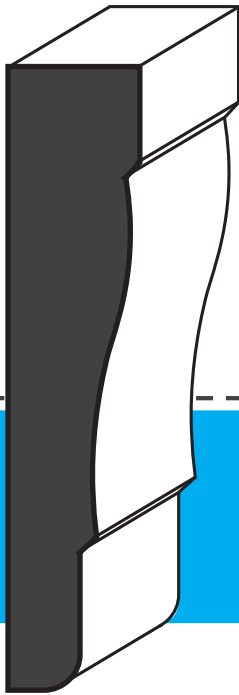

**EC 444** 3-1/4" **GEARScan**  
000444

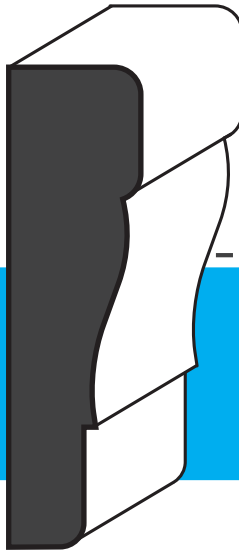

**EC 351** 2-1/2" **GEARScan**  
000351

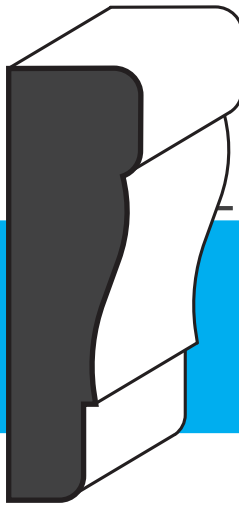

**EC 356** 2-1/4" **GEARScan**  
000356

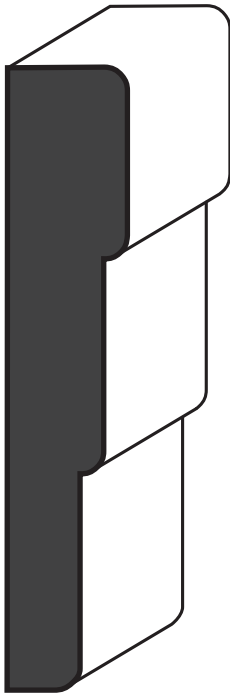

**EC 683** 3-1/4" **GEARScan**  
000683

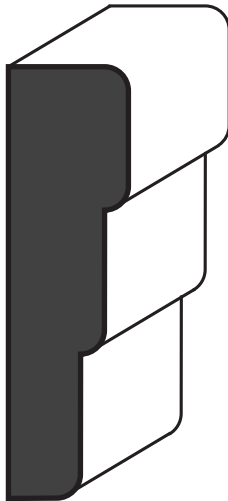

**EC 387** 2-1/4" **GEARScan**  
000387

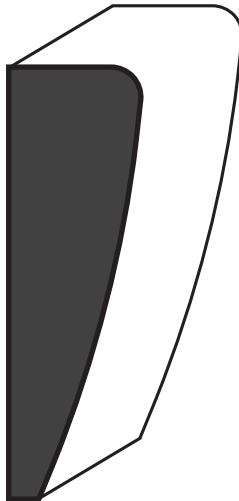

**EC 327** 2-1/4" **GEARScan**  
000327

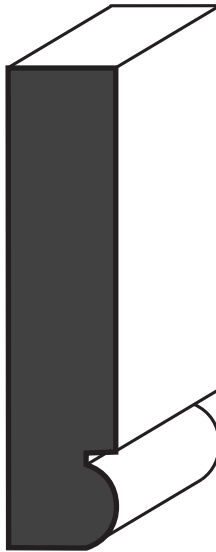

**EC 755** 2-1/2" **GEARScan**  
000755

# DOOR AND WINDOW TRIM

Including: Back Bands, Rosettes, Plinths, Stops, Astragals, Stools, Aprons and Mullions

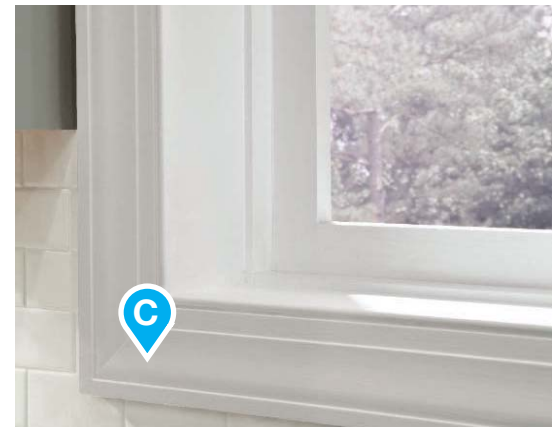
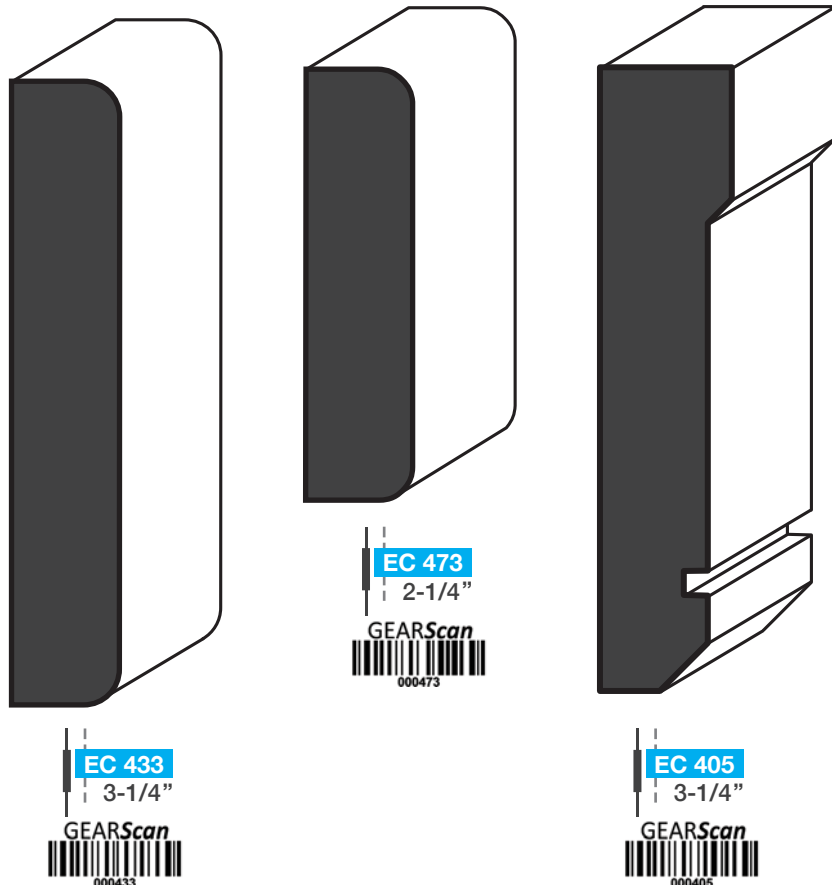
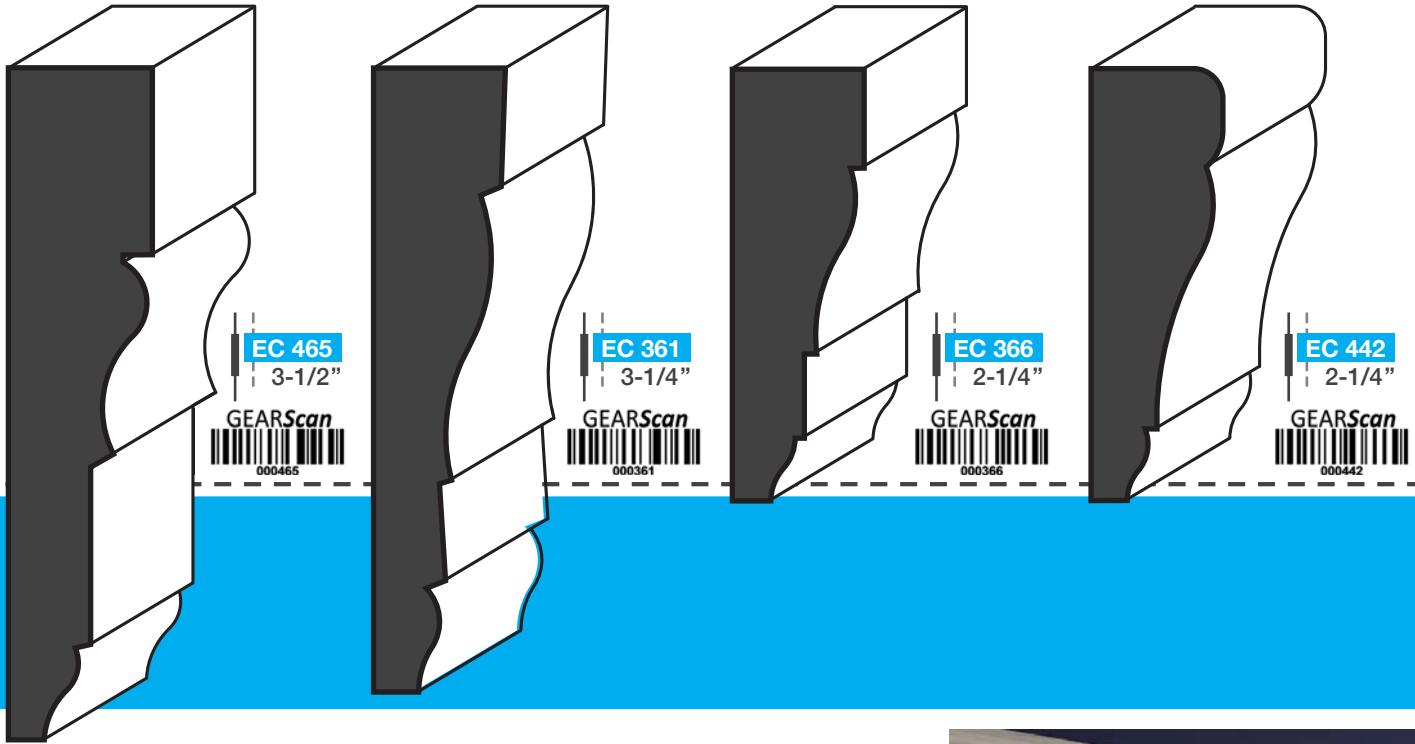

- A** EC 444 | Casing
- B** EC 988 | Mull
- C** EC 445 | Casing

# DOOR AND WINDOW TRIM

Including: Back Bands, Rosettes, Plinths, Stops, Astragals, Stools, Aprons and Mullions

EC 1002  
3-1/2"  
GEARScan  
001002

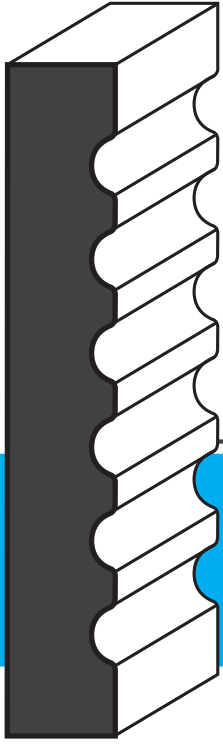

EC 14  
3-1/4"  
GEARScan  
000014



EC 514  
5-1/4"  
GEARScan  
000514

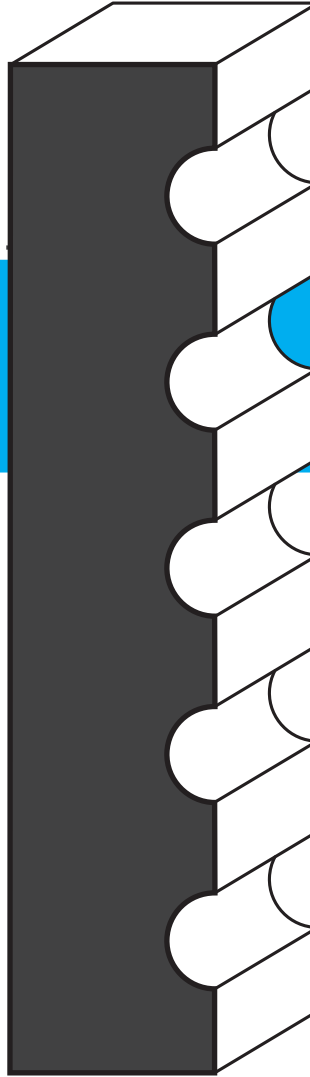

EC 714  
7-1/4"  
GEARScan  
000714

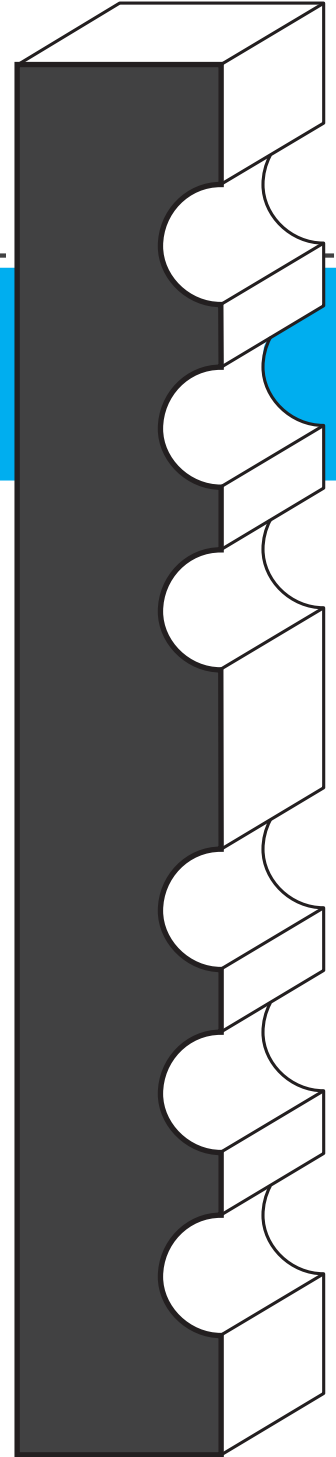

EC 1006  
3-1/2"  
GEARScan  
001006

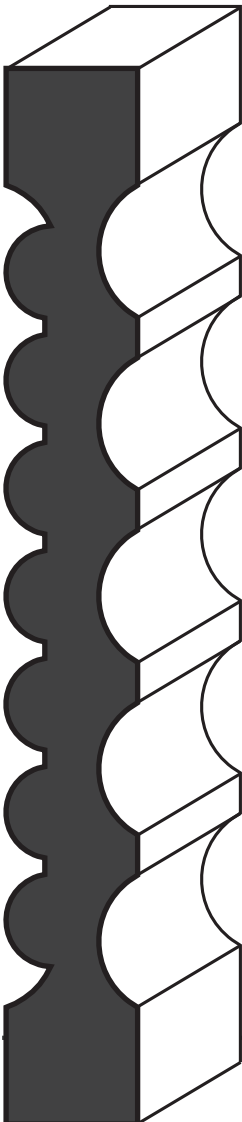
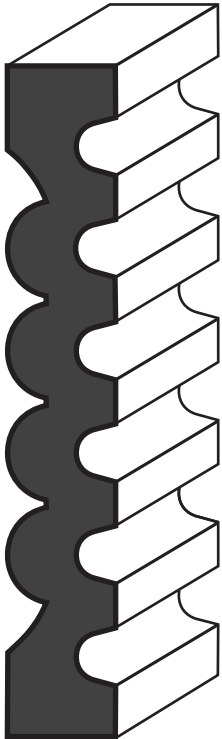

EC 545  
5-1/2"  
GEARScan  
000545



# DOOR AND WINDOW TRIM

Including: Back Bands, Rosettes, Plinths, Stops, Astragals, Stools, Aprons and Mullions

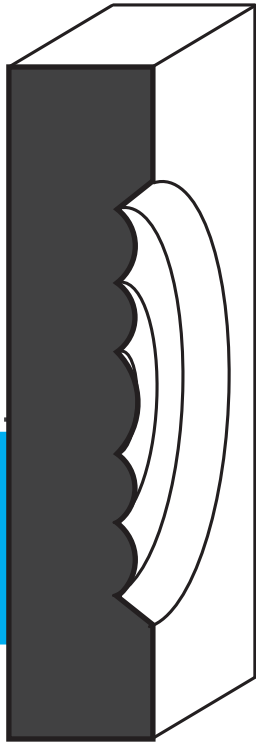

EC 30  
3-1/2"  
Rosette  
GEARScan  
000030

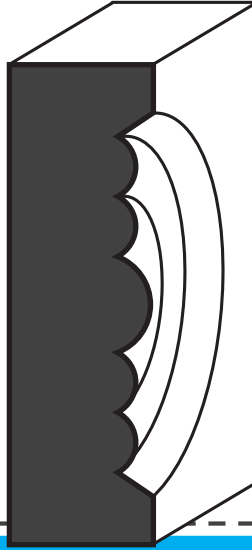

EC 29  
2-1/2"  
Rosette  
GEARScan  
000029

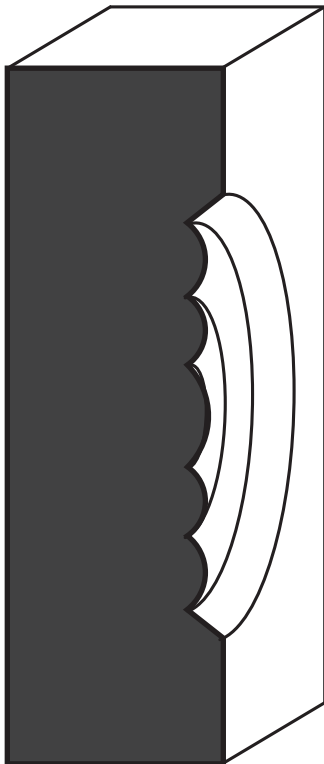
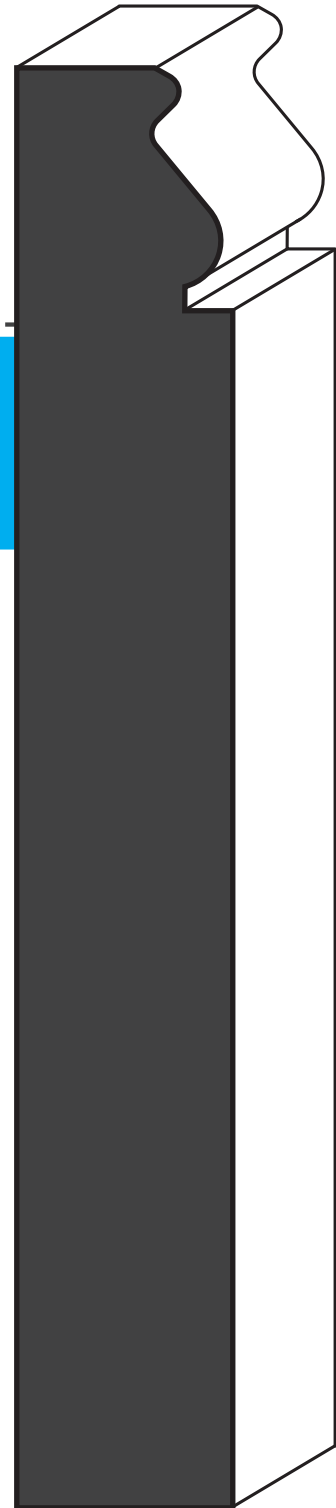

EC 28  
3-5/8"  
Rosette  
GEARScan  
000028

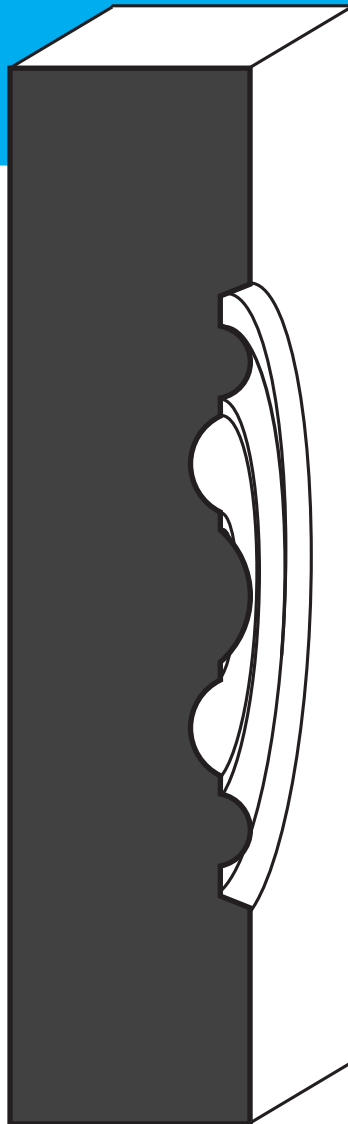

EC 25  
5-1/2"  
Rosette  
GEARScan  
000025

# DOOR AND WINDOW TRIM

Including: Back Bands, Rosettes, Plinths, Stops, Astragals, Stools, Aprons and Mullions

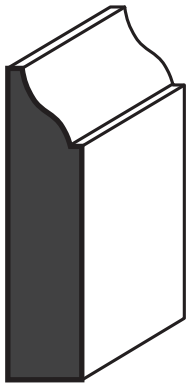

EC 935  
1-5/8"  
GEARScan  
000935



EC 936  
1-3/8"  
GEARScan  
000936



EC 937  
1-1/4"  
GEARScan  
000937

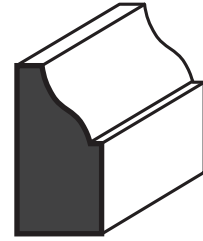

EC 940  
7/8"  
GEARScan  
000940



EC 941  
5/8"  
GEARScan  
000941



EC 941A  
3/4"  
GEARScan  
000942



EC 816  
1-3/8"  
GEARScan  
000816



EC 817  
1-1/4"  
GEARScan  
000817

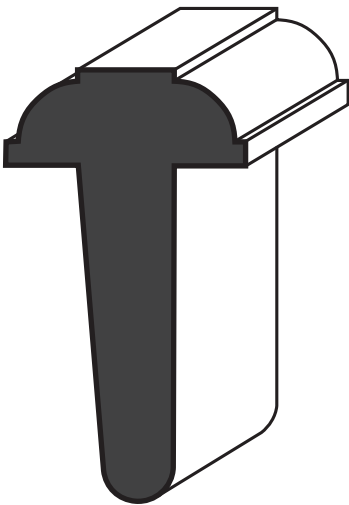

EC 1300  
1-3/4"  
GEARScan  
001300

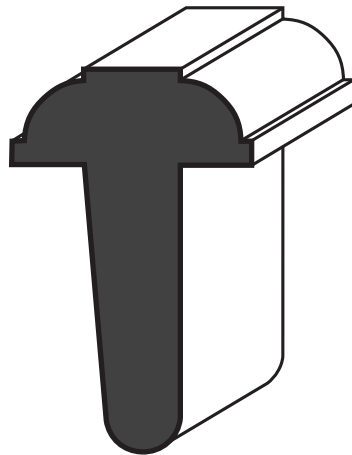

EC 1305  
1-3/8"  
GEARScan  
001305

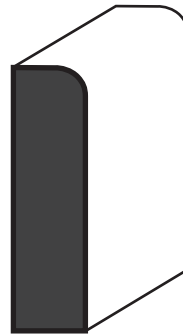

EC 886  
1-3/8"  
GEARScan  
000886

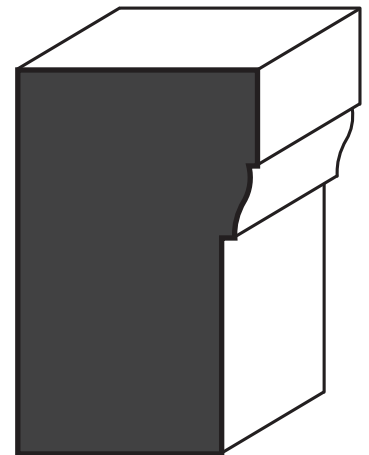

EC 180  
2"  
GEARScan  
000180

# DOOR AND WINDOW TRIM

Including: Back Bands, Rosettes, Plinths, Stops, Astragals, Stools, Aprons and Mullions

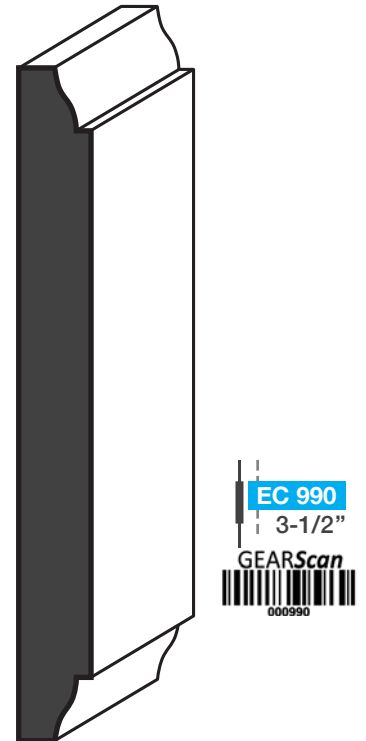
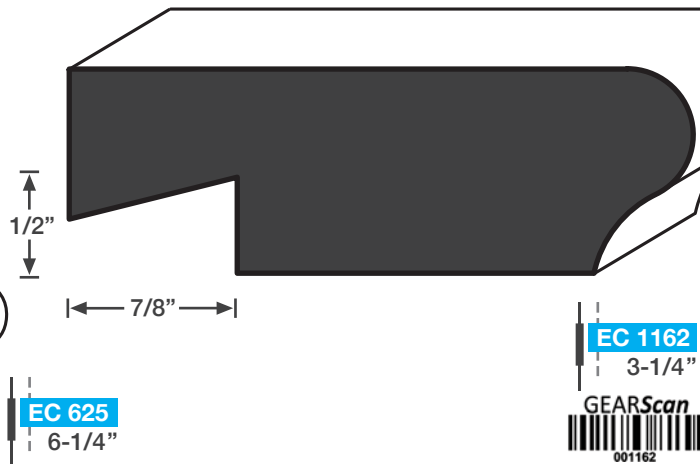
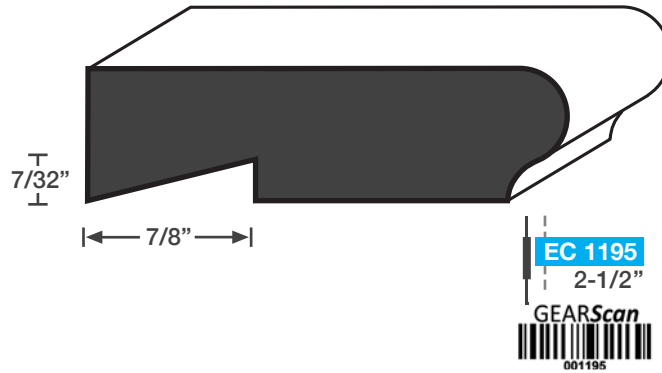
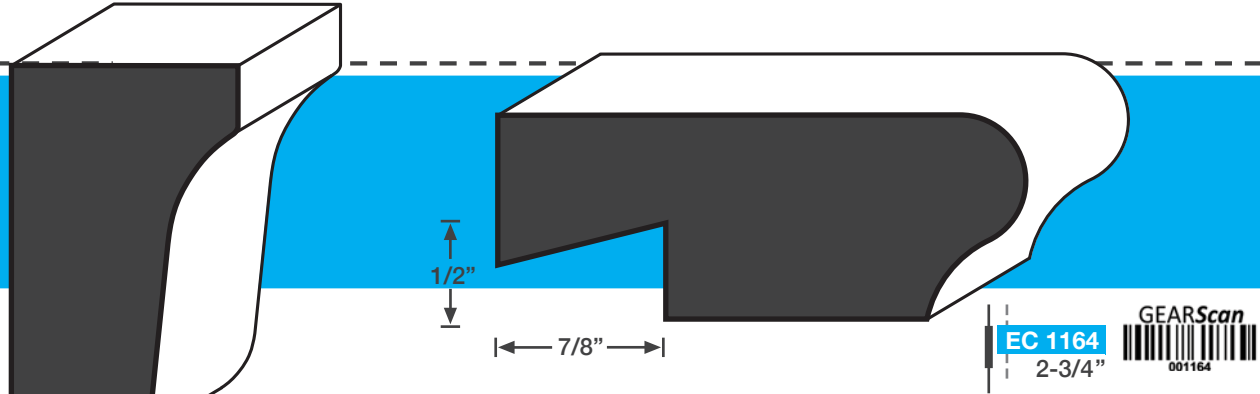
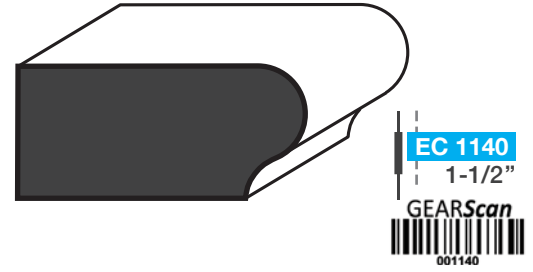
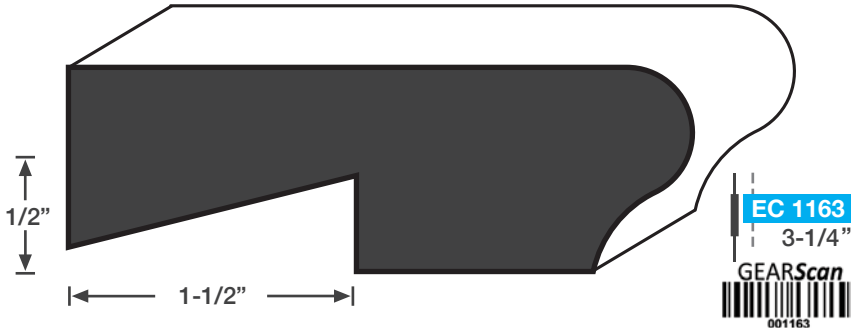

# DOOR AND WINDOW TRIM

Including: Back Bands, Rosettes, Plinths, Stops, Astragals, Stools, Aprons and Mullions



EC 1021  
4-1/2" GEARScan  
101021

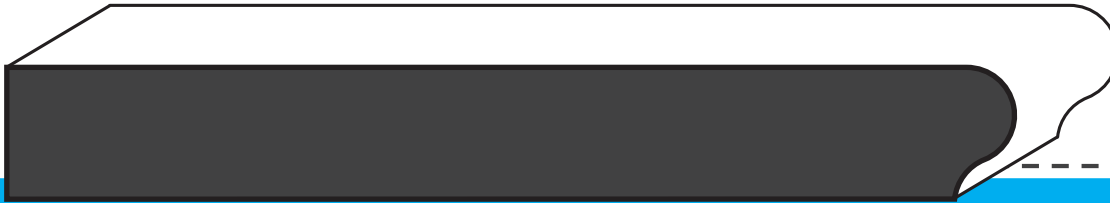

EC 1021  
5-1/4" GEARScan  
010215



EC 1021  
7-1/4" GEARScan  
010217



EC 1121  
5-1/4" GEARScan  
001124

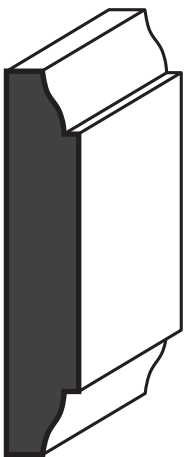

EC 987  
2" GEARScan  
000987

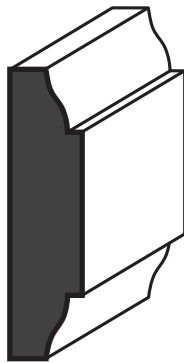

EC 988  
1-1/2" GEARScan  
000988

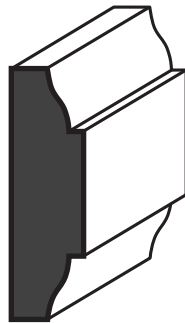

EC 988A  
1-5/16" GEARScan  
000986

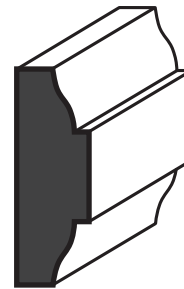

EC 989  
1-1/8" GEARScan  
000989

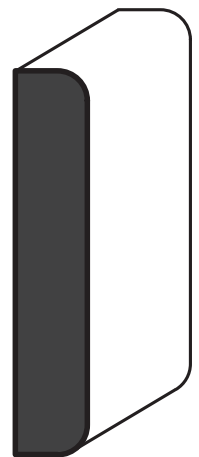

EC 972  
2" GEARScan  
000972

# BASE MOULDINGS

Including: Base Caps and Shoe

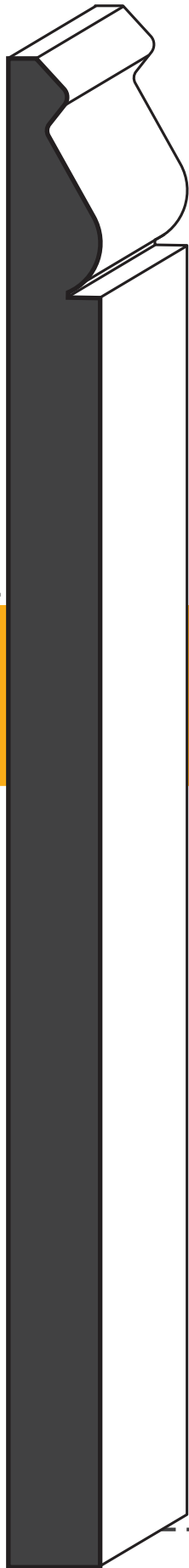

EC 910  
9-1/4" GEARScan  
000910

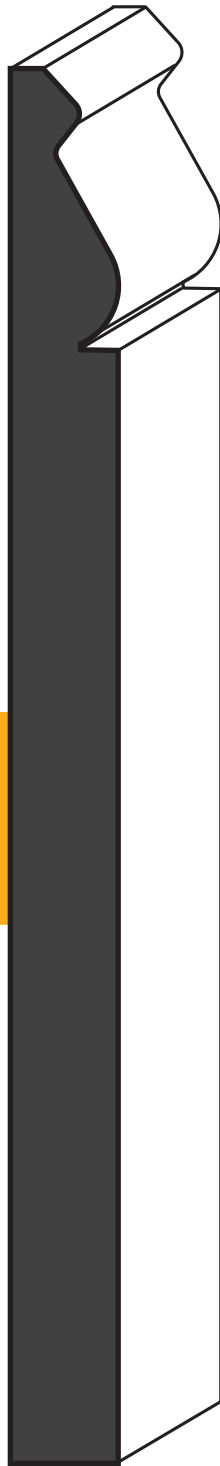

EC 810  
7-1/4" GEARScan  
000810



EC 616  
6-1/8" GEARScan  
000616

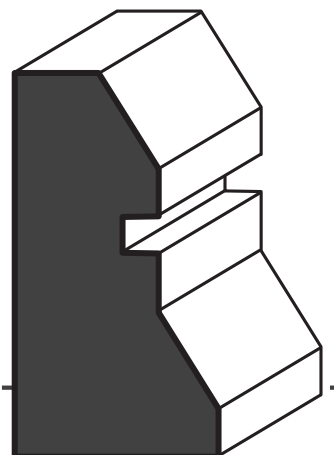

EC 154  
2" GEARScan  
000154



# BASE MOULDINGS

Including: Base Caps and Shoe

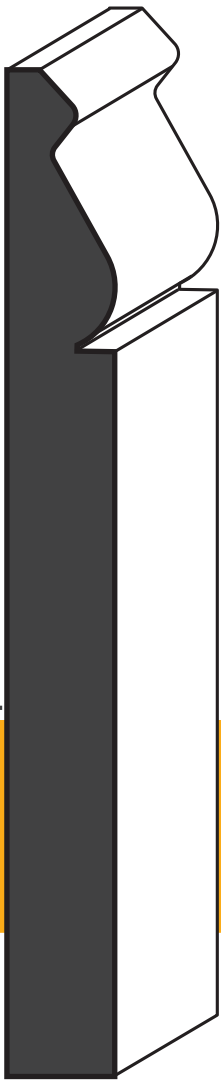

**EC 610**  
5-1/4"  
GEARScan  
000610

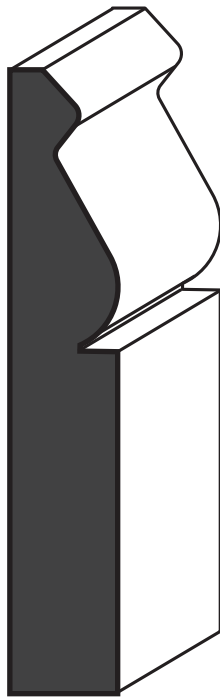

**EC 310**  
3-1/4"  
GEARScan  
000310



**EC 172**  
3/4"  
GEARScan  
000172

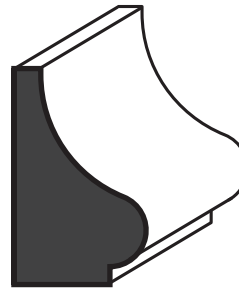

**EC 167**  
1-1/8"  
GEARScan  
000167

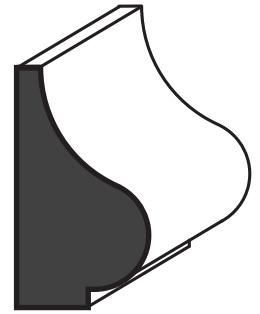

**EC 166**  
1-1/4"  
GEARScan  
000166

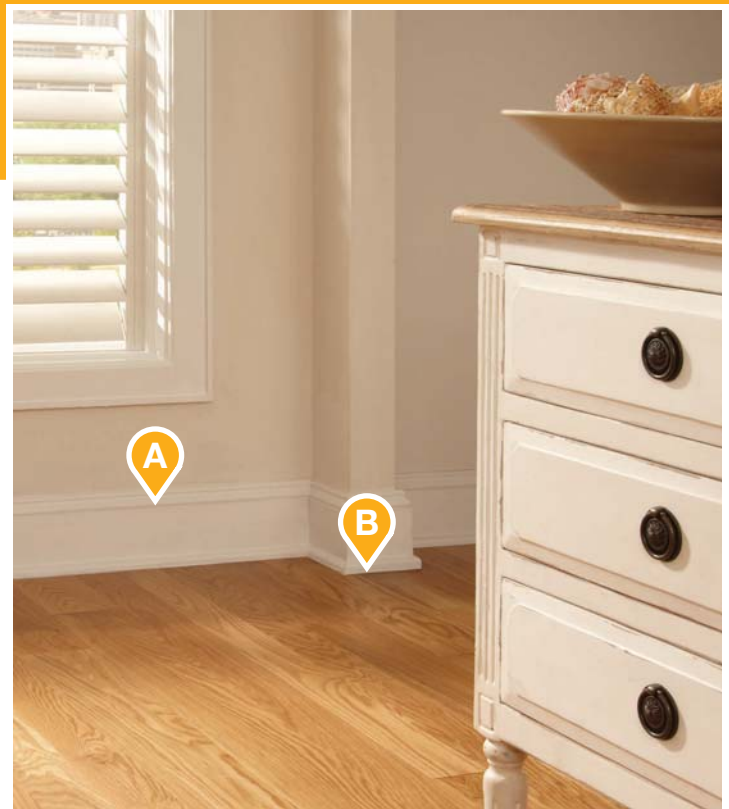

- A** EC 610 | Base
- B** EC 127 | Shoe



**EC 163**  
1-3/8"  
GEARScan  
000163



**EC 162**  
1-1/8"  
GEARScan  
000162



**EC 164**  
1-1/8"  
GEARScan  
000164

# BASE MOULDINGS

Including: Base Caps and Shoe

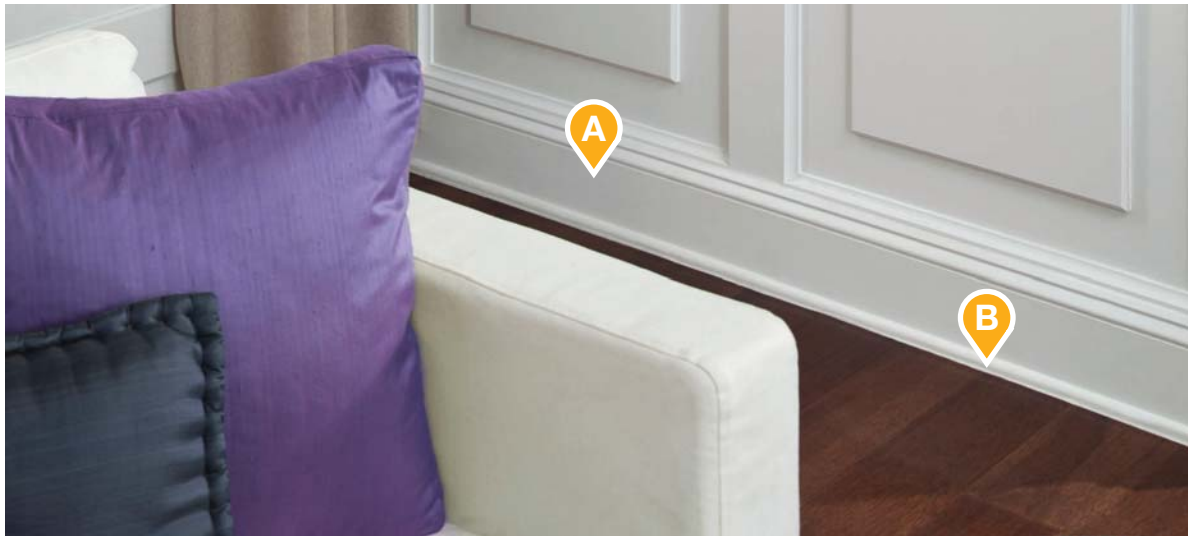
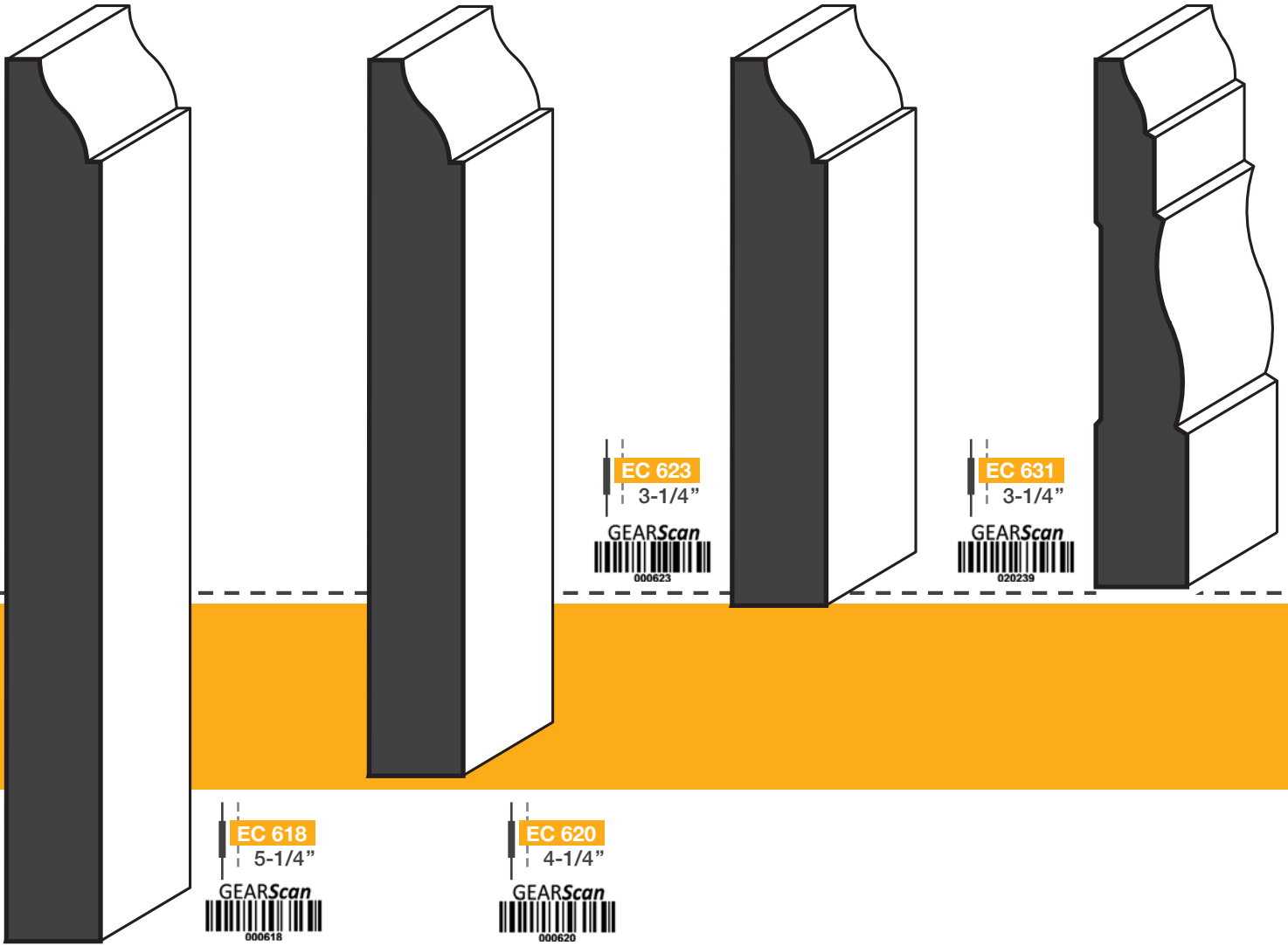

**A** EC 616 | Base    **B** EC 127 | Shoe

# BASE MOULDINGS

Including: Base Caps and Shoe

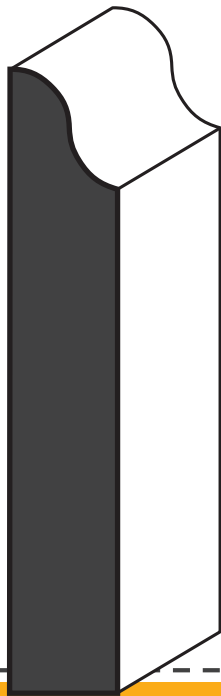

**EC 663**  
3-1/4"  
GEARScan  
000663

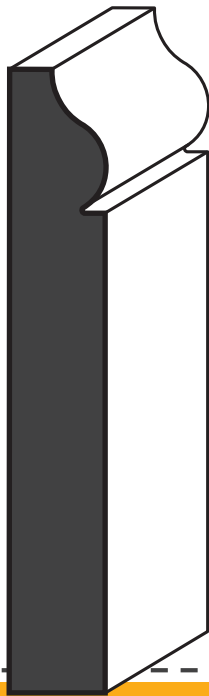

**EC 623A**  
3-1/4"  
GEARScan  
000624

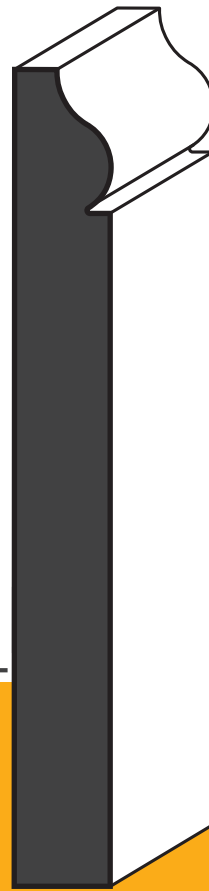

**EC 620A**  
4-1/4"  
GEARScan  
000621

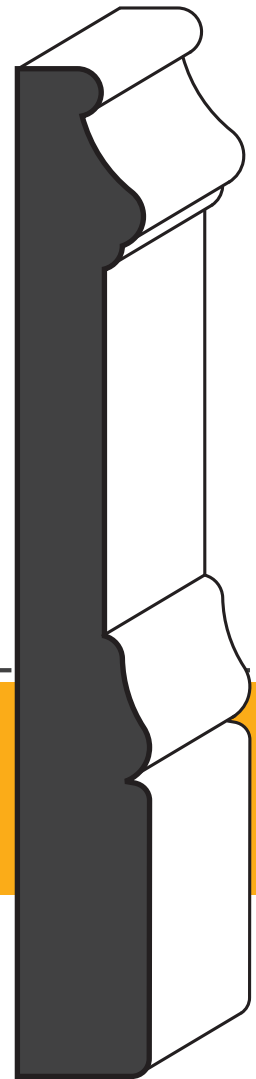

**EC 467**  
5-1/4"  
GEARScan  
000467

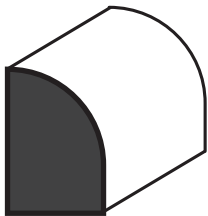

**EC 126**  
3/4"  
GEARScan  
000126

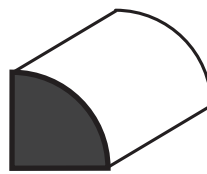

**EC 108**  
1/2"  
GEARScan  
000108



**EC 127**  
11/16"  
GEARScan  
000127

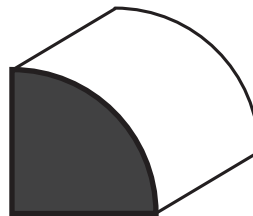

**EC 105**  
3/4"  
GEARScan  
000105

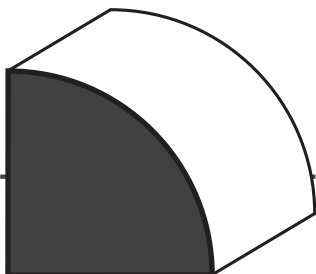

**EC 103**  
1-1/16"  
GEARScan  
000103

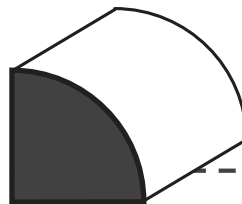

**EC 106**  
11/16"  
GEARScan  
000106

# BASE MOULDINGS

Including: Base Caps and Shoe

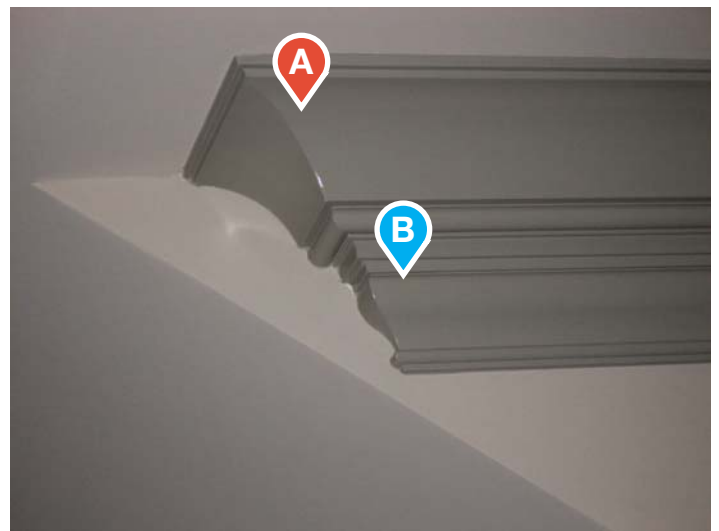
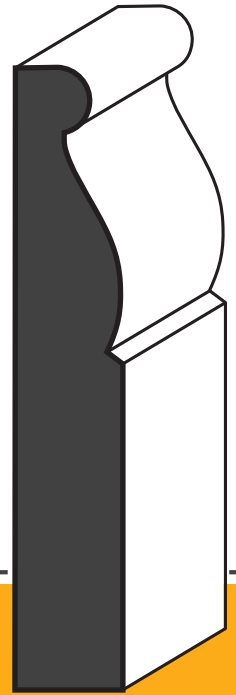
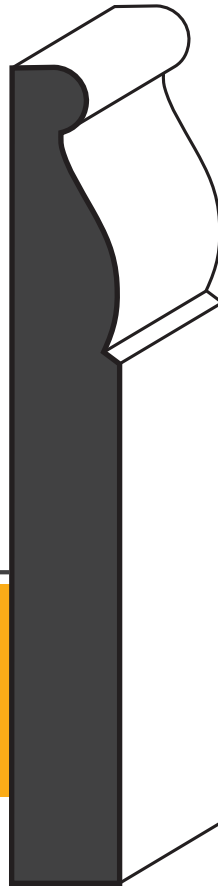
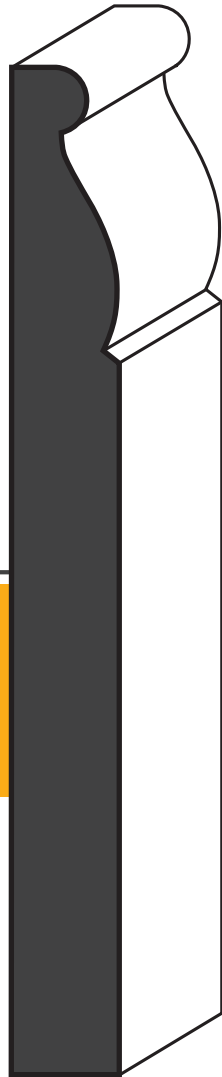
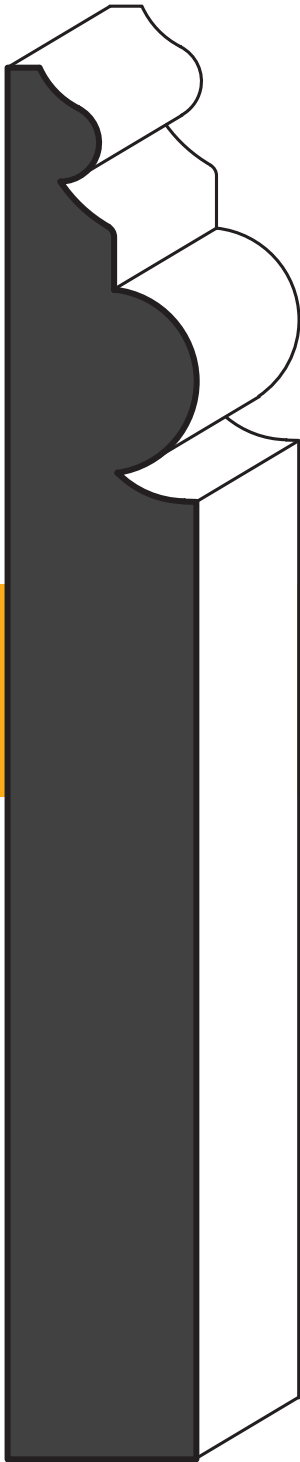

**A** EC 24 | Crown    **B** EC 436 | Casing

# BASE MOULDINGS

Including: Base Caps and Shoe

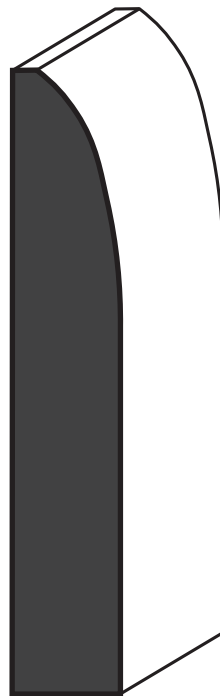
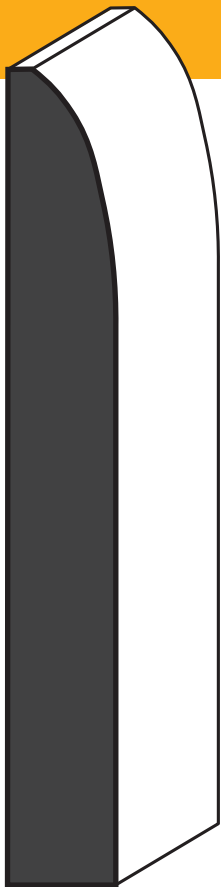
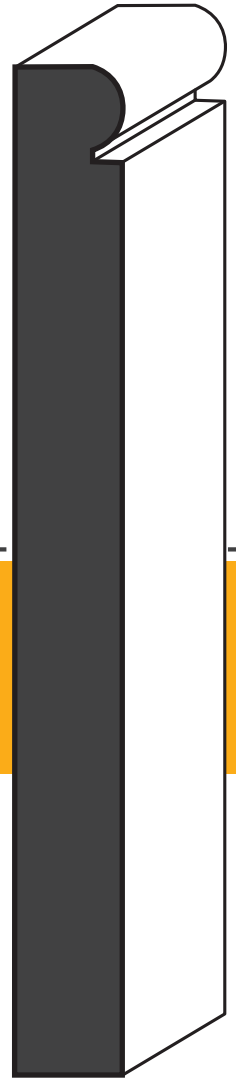
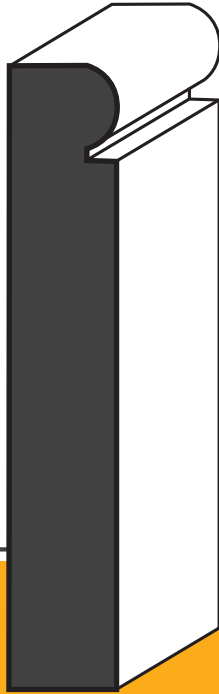
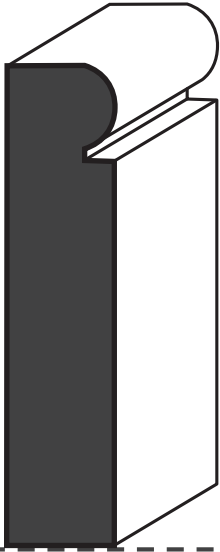

# BASE MOULDINGS

Including: Base Caps and Shoe

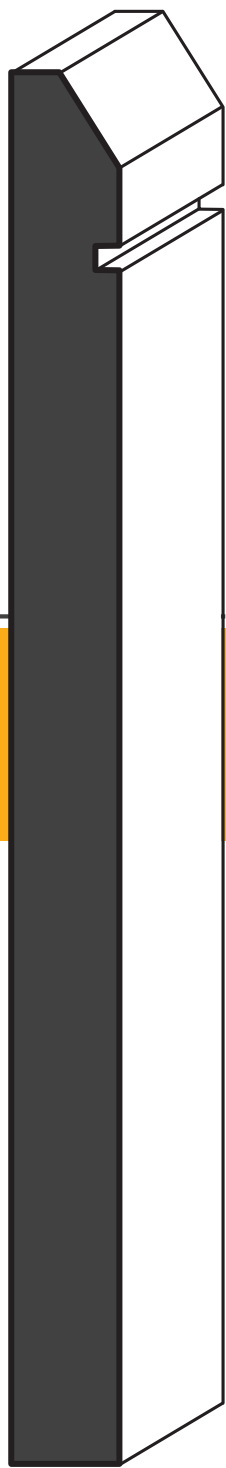

**EC 700**  
7-1/4"

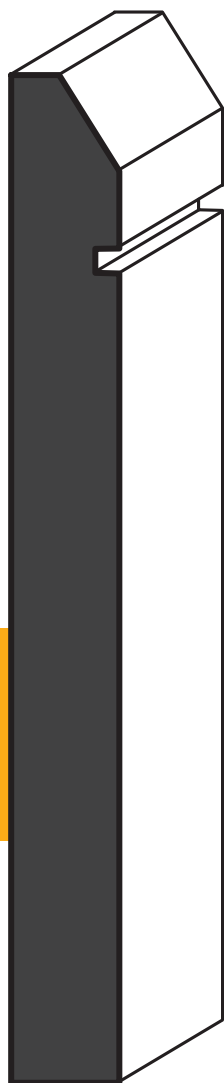

**EC 705**  
5-1/4"

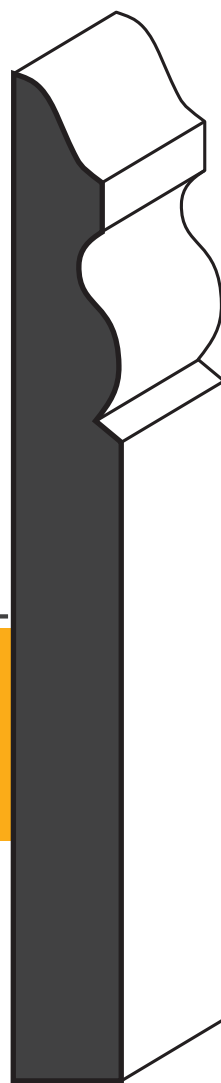

**EC 5180**  
5-1/4"



**EC 19**  
5"



**EC 101**  
1/2"



**EC 100**  
11/16"

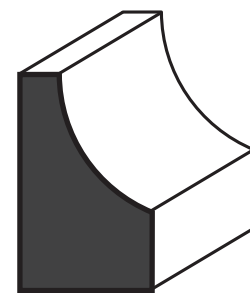

**EC 94**  
1-1/8"



# CHAIR RAILS

Including: Rail Backers, Mullions and Panel Moulds



EC 520  
5-1/4"  
GEARScan  
000520

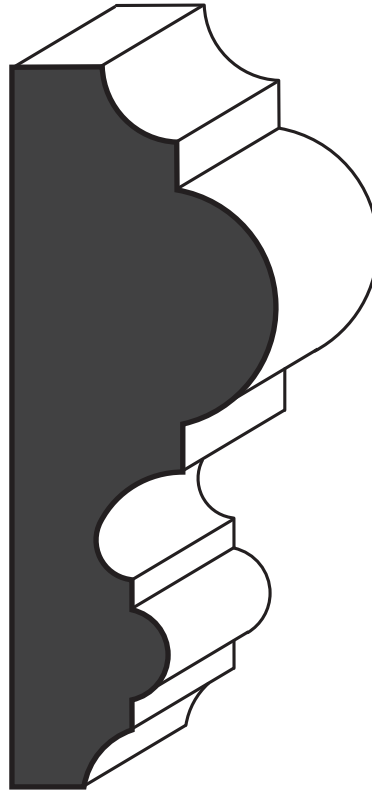

EC 340  
3-3/4"  
GEARScan  
000340

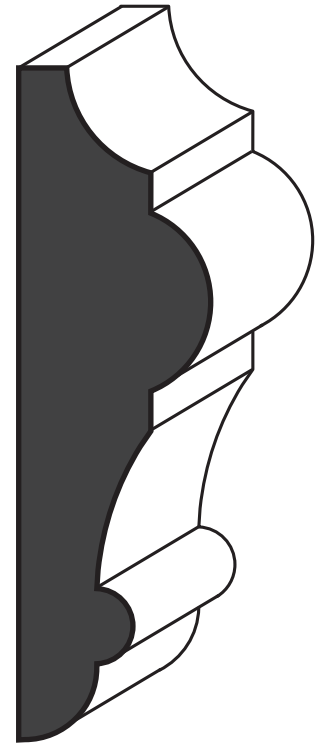

EC 397  
3-1/2"  
GEARScan  
000397



EC 2  
3-7/16"  
GEARScan  
000002

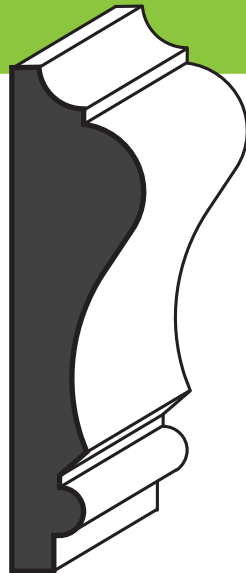

EC 390  
2-5/8"  
GEARScan  
000390



- A** EC 397 | Chair Rail w/ 1 x 4
- B** EC 100 | Cove

# CHAIR RAILS

Including: Rail Backers, Mullions and Panel Moulds

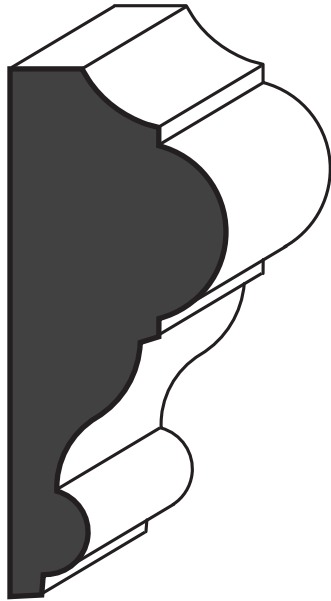

EC 299  
2-3/4" 

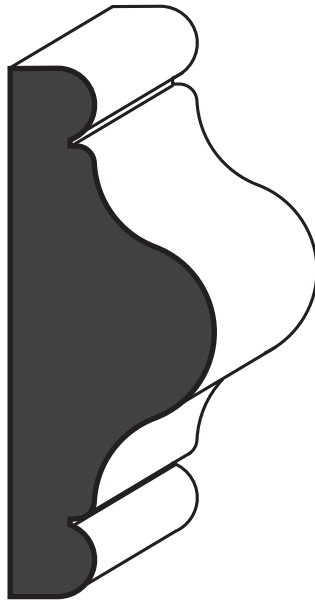

EC 302  
2-3/4" 



EC 394  
2-5/8" 

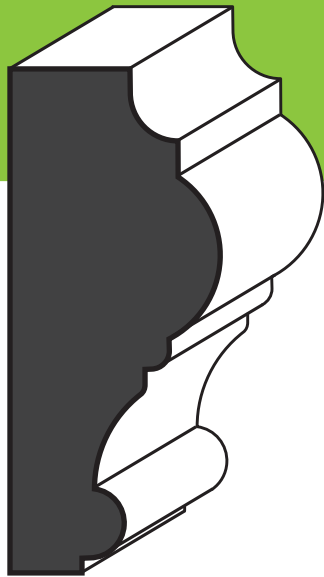

EC 394A  
2-5/8" 



EC 5  
2-5/8" 



EC 336  
2-1/2" 



# CHAIR RAILS

Including: Rail Backers, Mullions and Panel Moulds

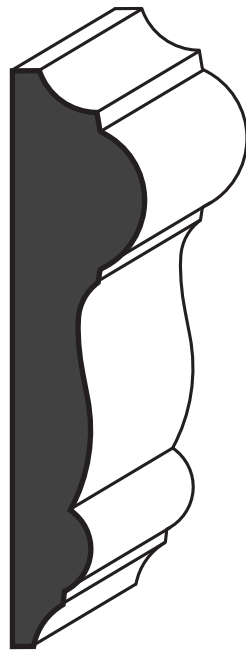

EC 297 | 3" | GEARScan | 000297



EC 300 | 3" | GEARScan | 000300

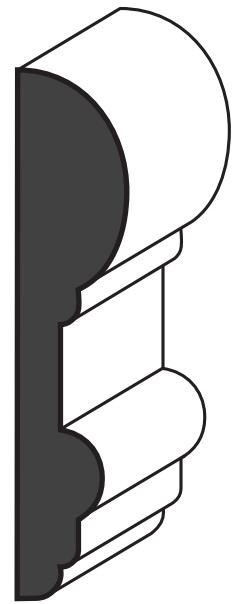

EC 1001 | 2-3/4" | GEARScan | 001001

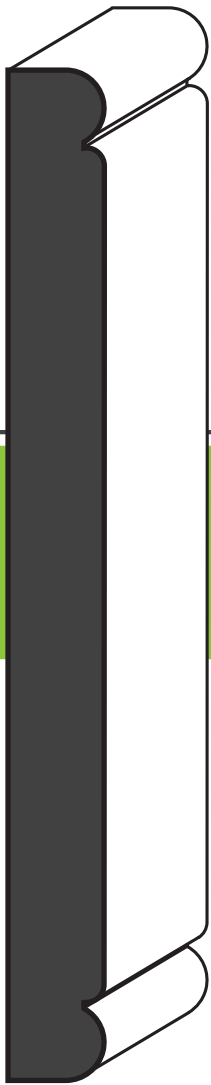

EC 398 | 5-1/4" | GEARScan | 000398



EC 425 | 4-1/2" | GEARScan | 000425



EC 6 | 4-1/2" | GEARScan | 000006

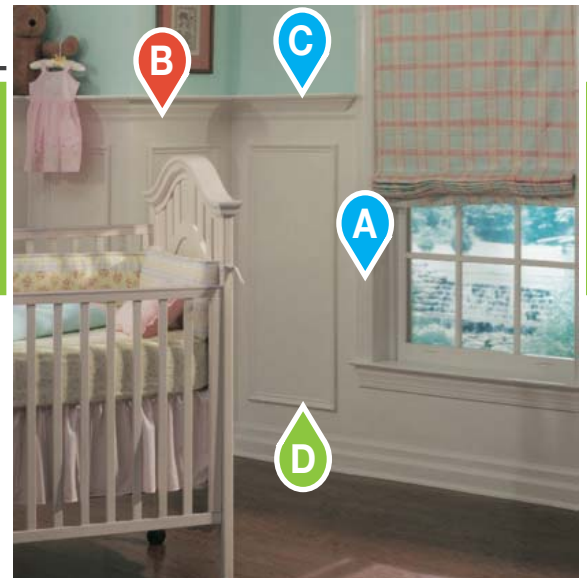

- A** EC 445 | Casing
- B** EC 54 | Crown
- C** EC 1021 | Stool
- D** EC 163 | Panel

# CHAIR RAILS

Including: Rail Backers, Mullions and Panel Moulds

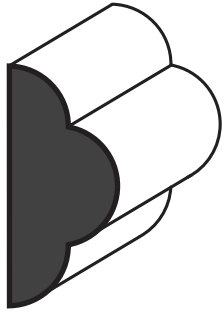

EC 137  
1-1/4" GEARScan  
000137



EC 292  
1-1/8" GEARScan  
000292

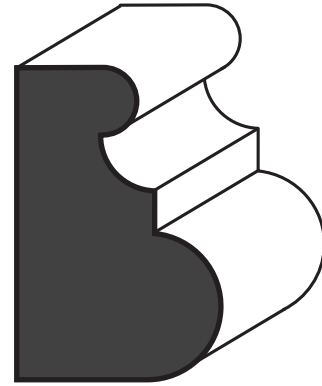

EC 42  
1-5/8" GEARScan  
000042



EC 135  
1-3/16" GEARScan  
000135



EC 182  
1-5/8" GEARScan  
020193



EC 1219  
1-5/8" GEARScan  
001219



EC 4234  
1-5/8" GEARScan  
004234



EC 139  
1-3/16" GEARScan  
000139

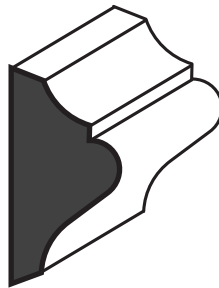

EC 183  
1-1/8" GEARScan  
000183



EC 1217  
1-1/2" GEARScan  
001219

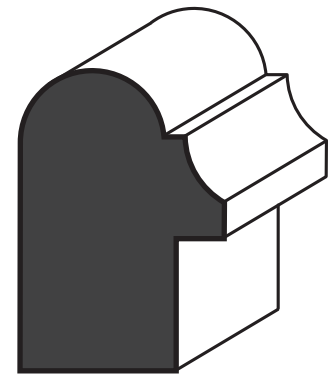

EC 289  
1-9/16" GEARScan  
000289

# MISCELLANEOUS

Including: S4S, Screen, Corner Hand Rail, Rake, Shingle, Drip, Corners, Qtr Rounds, and Covers

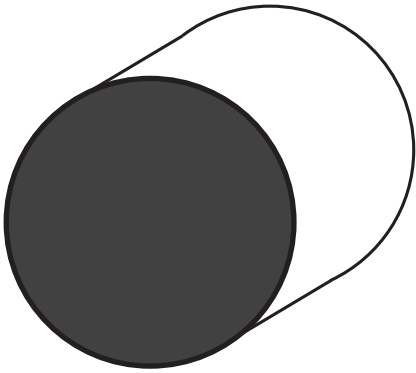

EC 232  
1-1/2"  
GEARScan  
000232

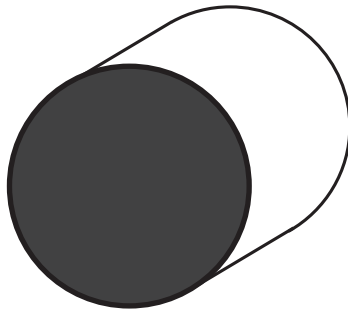

EC 233  
1-1/4"  
GEARScan  
000233

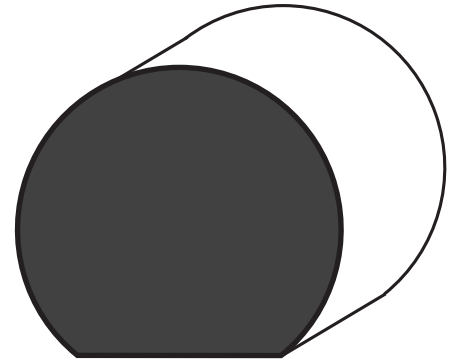

EC 231  
1-11/16"  
GEARScan  
000231

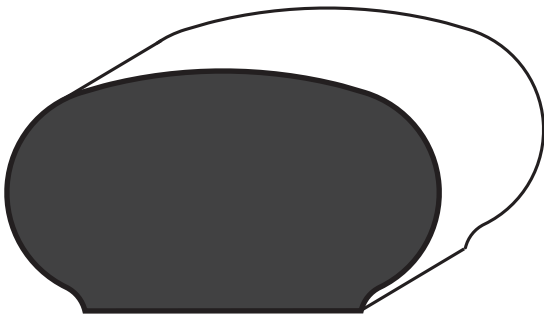

EC 240  
2-1/4"  
GEARScan  
000240



EC 230  
1-11/16"  
GEARScan  
000230

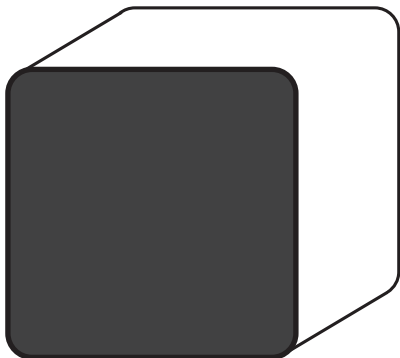

EC 236  
1-1/2"  
GEARScan  
000236

**A** EC 47 | Crown    **B** EC 54 | Crown

# MISCELLANEOUS

Including: S4S, Screen, Corner Hand Rail, Rake, Shingle, Drip, Corners, Qtr Rounds, and Covers

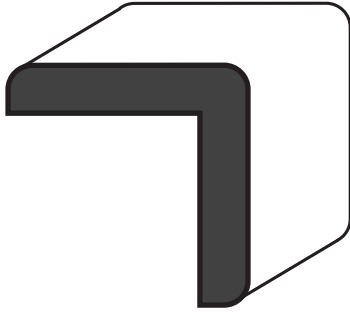

EC 204  
1-1/4"  
GEARScan  
000204



EC 740  
1-1/8"  
GEARScan  
000740

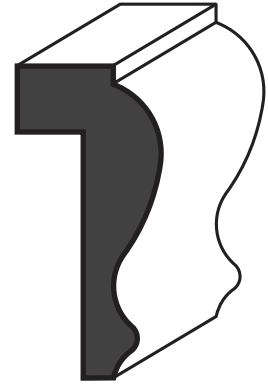

EC 741  
1-5/8"  
GEARScan  
000741

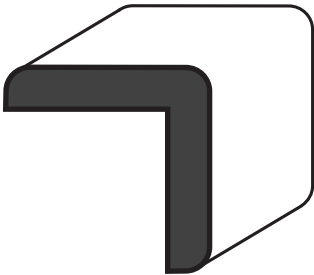

EC 205  
1-1/16"  
GEARScan  
000205

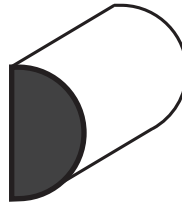

EC 122  
1/2"  
GEARScan  
000122

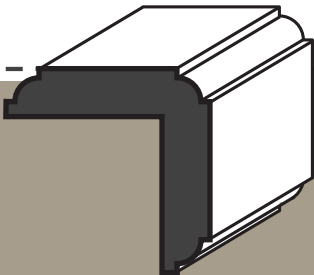

EC 202  
1-1/16"  
GEARScan  
000202

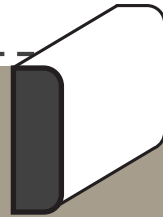

EC 142  
3/4"  
GEARScan  
000142



EC 206  
3/4"  
GEARScan  
000206

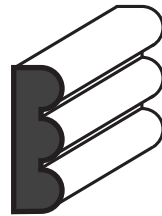

EC 144  
3/4"  
GEARScan  
000144



EC 148  
3/8"  
GEARScan  
000148

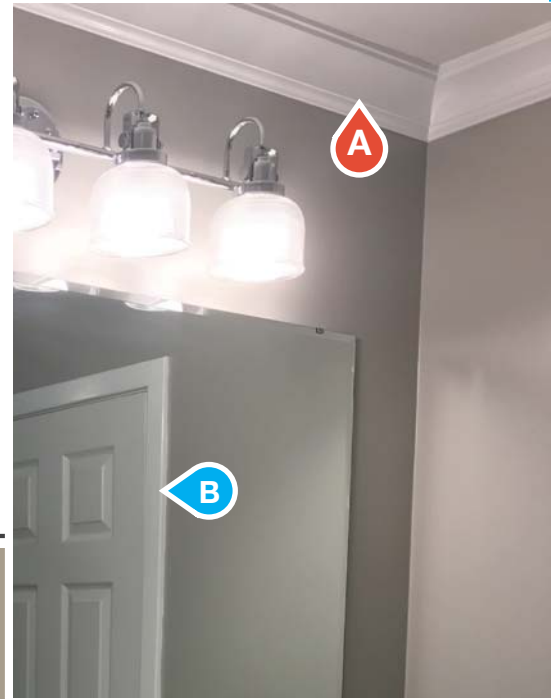

**A** EC 40 | Crown

**B** EC 473 | Casing

# MISCELLANEOUS

Including: S4S, Screen, Corner Hand Rail, Rake, Shingle, Drip, Corners, Qtr Rounds, and Covers

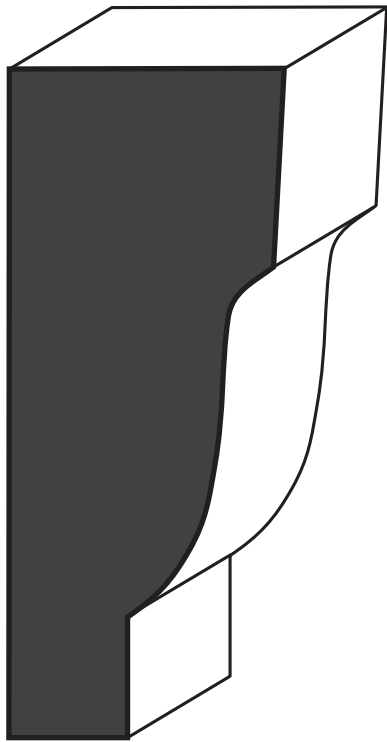

EC 1229  
3-1/2"  
GEARScan  
0001229

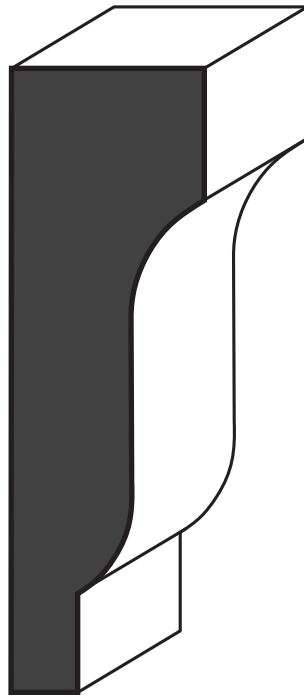

EC 1206  
3-1/4"  
GEARScan  
0001206

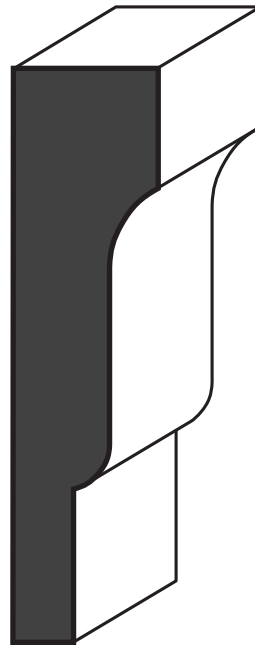

EC 1228  
3"  
GEARScan  
0001228

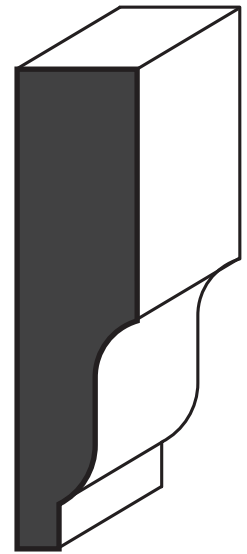

EC 207  
2-1/2"  
GEARScan  
000207



EC 212  
2-1/2"  
GEARScan  
000212

EC 197  
1-5/8"  
GEARScan  
000197

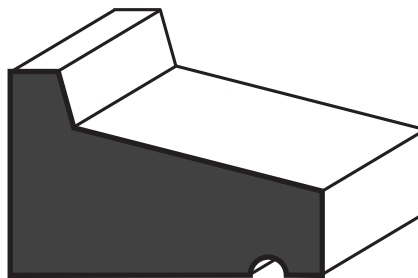
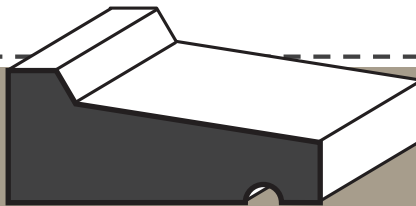

EC 188  
1-5/8"  
GEARScan  
000188

EC 210  
1-5/8"  
GEARScan  
000210

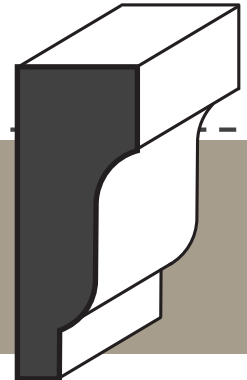

EC 995  
3/4"  
GEARScan  
000995

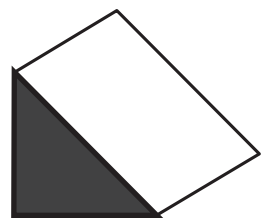

# MISCELLANEOUS

Including: S4S, Screen, Corner Hand Rail, Rake, Shingle, Drip, Corners, Qtr Rounds, and Covers

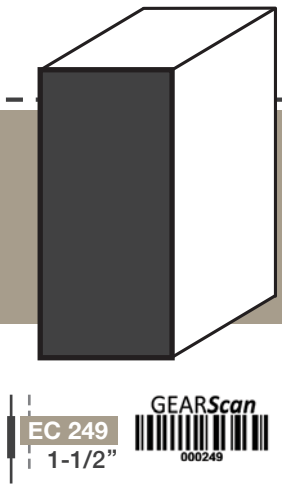
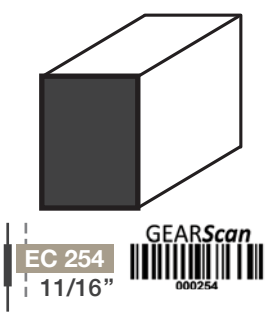
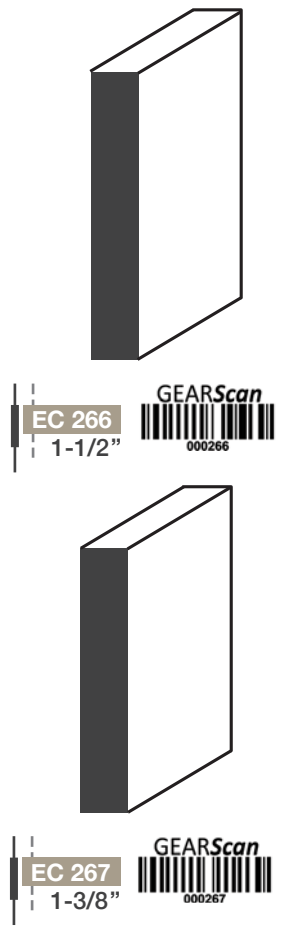
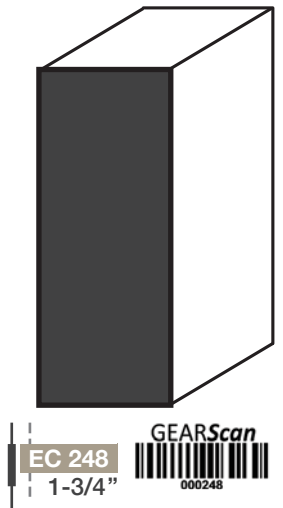
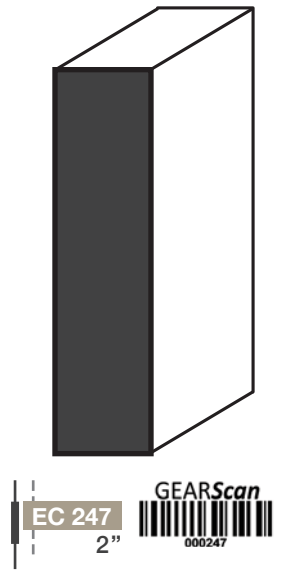
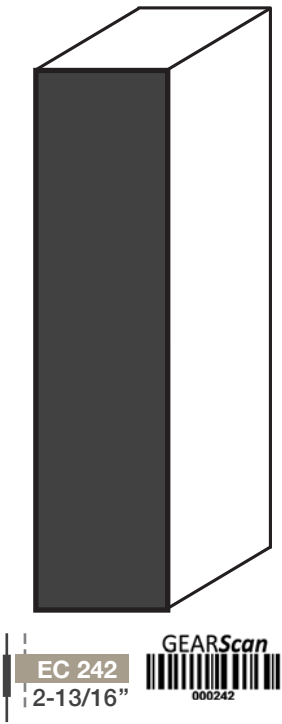

- A** EC 9 | Dentil Crown
- B** EC 163 | Base Cap
- C** EC 5/4 x 6 | S4S
- D** EC 1 | Casing

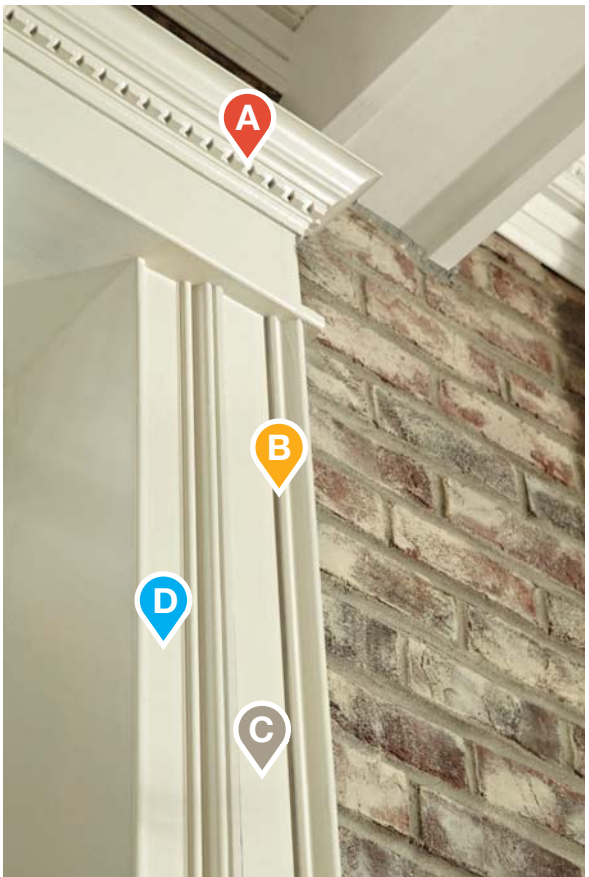

# BOARDS AND PANELS

Including: Pattern Stock, S4S Boards and Panels

Square edge also available in these sizes:

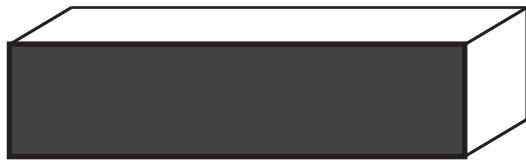

**EC 1x4**  
3-1/2"  
GEARScan  
520004  
(DRAWING NOT TO SCALE)

**EC 1x2**  
1-1/2"  
GEARScan  
520002

**EC 1x10**  
9-1/4"  
GEARScan  
520010

**EC 1x12**  
11-1/4"  
GEARScan  
520012



**EC 1x6**  
5-1/2"  
GEARScan  
520006  
(DRAWING NOT TO SCALE)

**EC 1x16**  
15-1/4"  
GEARScan  
520016

**EC 1x18**  
17-1/4"  
GEARScan  
520018

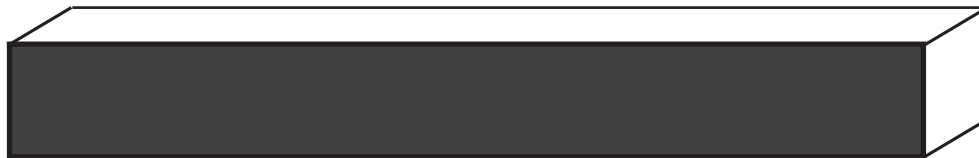

**EC 1x8**  
7-1/4"  
GEARScan  
520008  
(DRAWING NOT TO SCALE)

**EC 1x24**  
23-1/4"  
GEARScan  
520024

Eased edge also available in these sizes:

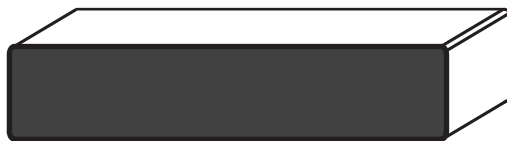

**EC 1x4**  
3-1/2"  
GEARScan  
522004  
(DRAWING NOT TO SCALE)

**EC 1x10**  
9-1/4"  
GEARScan  
522010

**EC 1x12**  
11-1/4"  
GEARScan  
522012

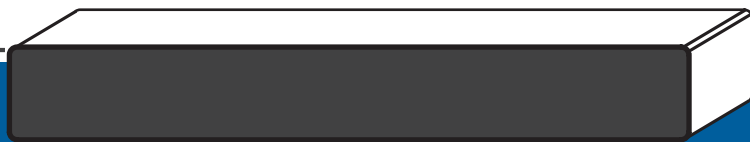

**EC 1x6**  
5-1/2"  
GEARScan  
522006  
(DRAWING NOT TO SCALE)



**EC 1x8**  
7-1/4"  
GEARScan  
522008  
(DRAWING NOT TO SCALE)

# BOARDS AND PANELS

Including: Pattern Stock, S4S Boards and Panels

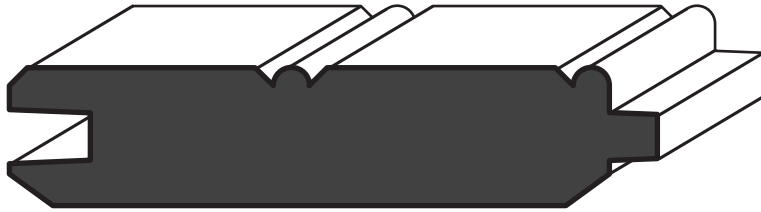

**T&G V-JOINT**  
1 x 4"  
GEARScan  
010005

**T&G V-JOINT**  
1 x 6"  
GEARScan  
010003

**T&G V-JOINT**  
1 x 8"  
GEARScan  
010004



**T&G FLOORING**  
1 x 4"  
GEARScan  
010008

**T&G FLOORING**  
1 x 6"  
GEARScan  
010009

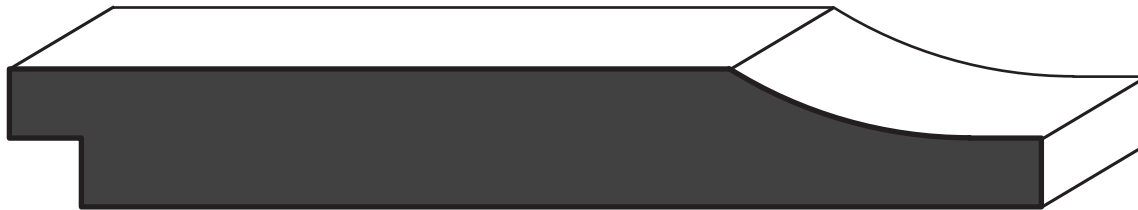

**105 SIDING**  
1 x 6"  
GEARScan  
010011



**WP4**  
1 x 6"  
GEARScan  
010017

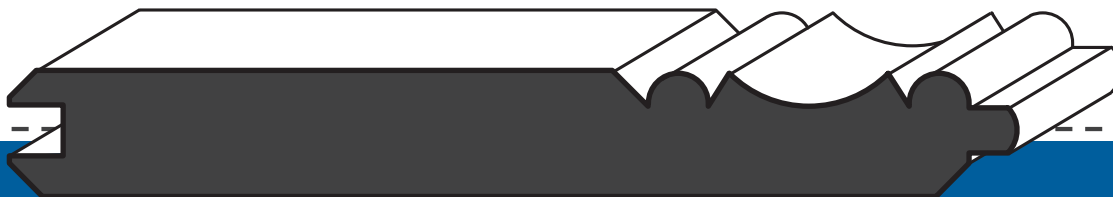

**PICKWICK SIDING**  
1 x 6"  
GEARScan  
010002

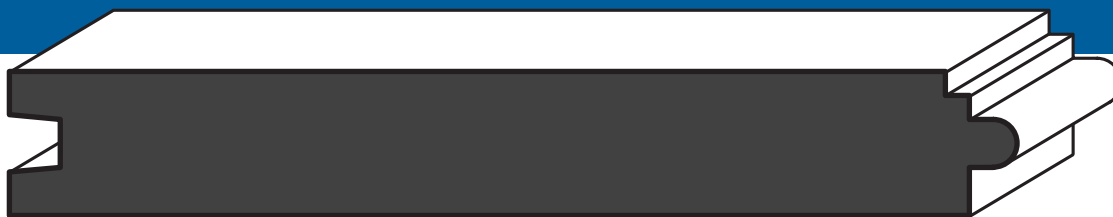

**PENNY GAP**  
1 x 6"  
GEARScan  
010018



# BOARDS AND PANELS

Including: Pattern Stock, S4S Boards and Panels

SIS2E also available in these sizes:



**SIS2E**  
3-1/2"  
GEARScan  
523004  
(DRAWING NOT TO SCALE)

**SIS2E**  
1 x 6  
GEARScan  
523006

**SIS2E**  
1 x 8  
GEARScan  
523008



**BEVEL**  
1 1/16"  
GEARScan  
010012  
(DRAWING NOT TO SCALE)

**SIS2E**  
1 x 10  
GEARScan  
523010

**SIS2E**  
1 x 12  
GEARScan  
523012

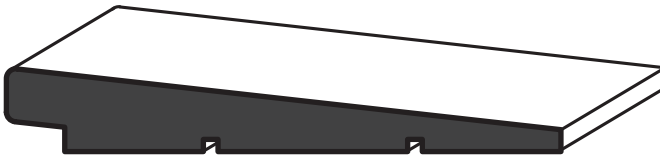

**RABBETED BEVEL**  
1 x 8  
GEARScan  
010014  
(DRAWING NOT TO SCALE)

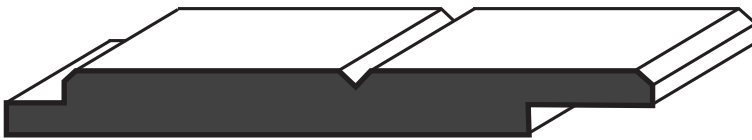

GEARScan  
010007  
**CHANNEL RUSTIC**  
1 x 8  
(DRAWING NOT TO SCALE)

GEARScan  
010006  
**CHANNEL RUSTIC**  
1 X 10



**V-JOINT DECKING**  
2 x 6  
GEARScan  
010053  
(DRAWING NOT TO SCALE)



**PLYWOOD**  
4' x 8'  
GEARScan  
540000  
(DRAWING NOT TO SCALE)

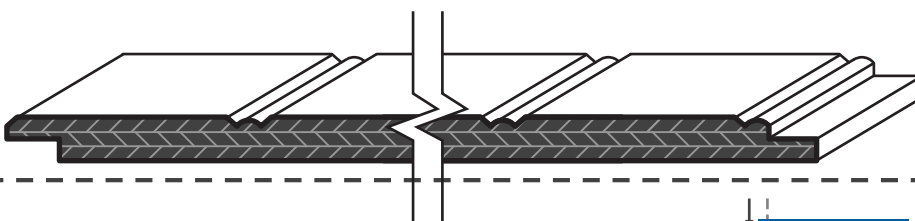

**BEADED**  
4' x 8'  
GEARScan  
540001  
(DRAWING NOT TO SCALE)



\* Photography used with permission of Water's Edge Woods (Comer, GA)



Shiplap gap siding, also known as penny gap or nickel gap siding, is commonly used to create the timeless shadow effect for interior walls. A great addition to your craftsman home or that accent wall.

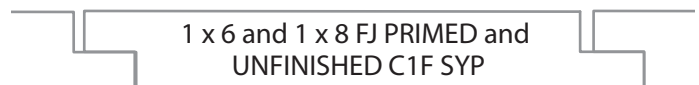

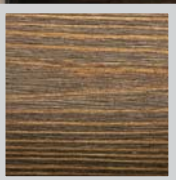
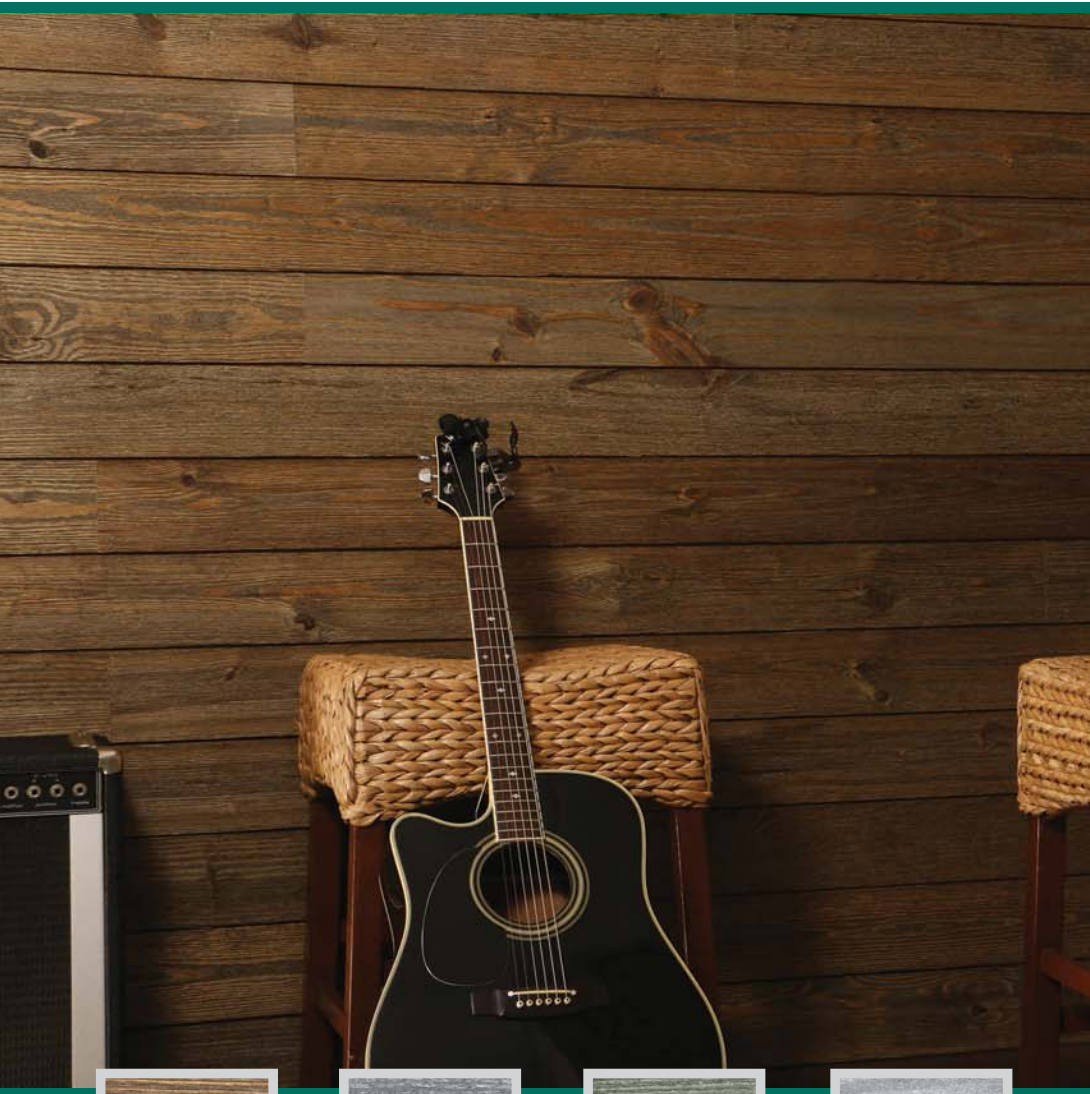

Woodshed

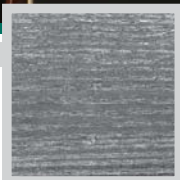

Cottage

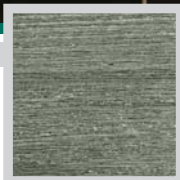

Barnwood

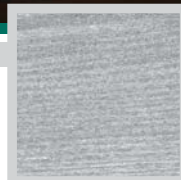

Silo

EastCoast Mouldings offers 4 colors of factory-primed, rustic shiplap SYP sidings and S4S. The photos above only represent several installation options. Use your imagination and find that room or wall for this new look.

Stock Sizes Available:  
 1 x 6 x 12 - Shiplap  
 1 x 6 x 16 - Shiplap  
 1 x 4 x 16 - S4S





**Moulding Tips & Suggestions**

- The most visually pleasing crown and base mouldings are applied in proportion to the ceiling height.

<p>Suggestions for 8 ft. ceiling heights</p> <ul style="list-style-type: none"> <li>• 2-1/4 in. - 3-5/8 in. crown mouldings</li> <li>• 3-1/4 in. - 5-1/4 in. base mouldings</li> </ul> <p>Suggestions for 9 ft. ceiling heights</p> <ul style="list-style-type: none"> <li>• 4-1/4 in. - 5-1/2 in. crown mouldings</li> <li>• 4-1/4 in. - 6-1/8 in. base mouldings</li> </ul>	<p>Suggestions for 10 ft. ceiling heights</p> <ul style="list-style-type: none"> <li>• 5-1/4 in. - 7-1/4 in. crown mouldings</li> <li>• 5-1/4 in. - 9-1/4 in. base mouldings</li> </ul> <p>Greater than 10 ft. ceiling heights</p> <ul style="list-style-type: none"> <li>• Lots of opportunities for compound crowns and bases to achieve the desirable look. Again, scale the dimensions proportional to the living space.</li> </ul>
---	---
- Door and window casings are influenced by the ceiling heights but are also selected according to door heights.

  - Door heights of 6 ft. 8 in. - 2-1/4 in. - 3-1/2 in. casing
  - Door heights of 7 ft. - 2-1/2 in. - 4 in. casing
  - Door heights of 8 ft. - 3-1/2 in. and larger
- Base caps offer a decorative transition from the S4S base to the wall. Base caps are also commonly used to design wainscoting panels for less expense.
- Chair rails should be installed at the height to protect the wall at the height of your chair back. Decoratively, chair rails break up a room creating an opportunity for multiple color schemes or panel options.
- Picture mould was historically used to hang pictures from when walls were plaster and difficult to drive nails into. Today, picture moulding is frequently used as an extension of the crown, enhancing the wall treatment.

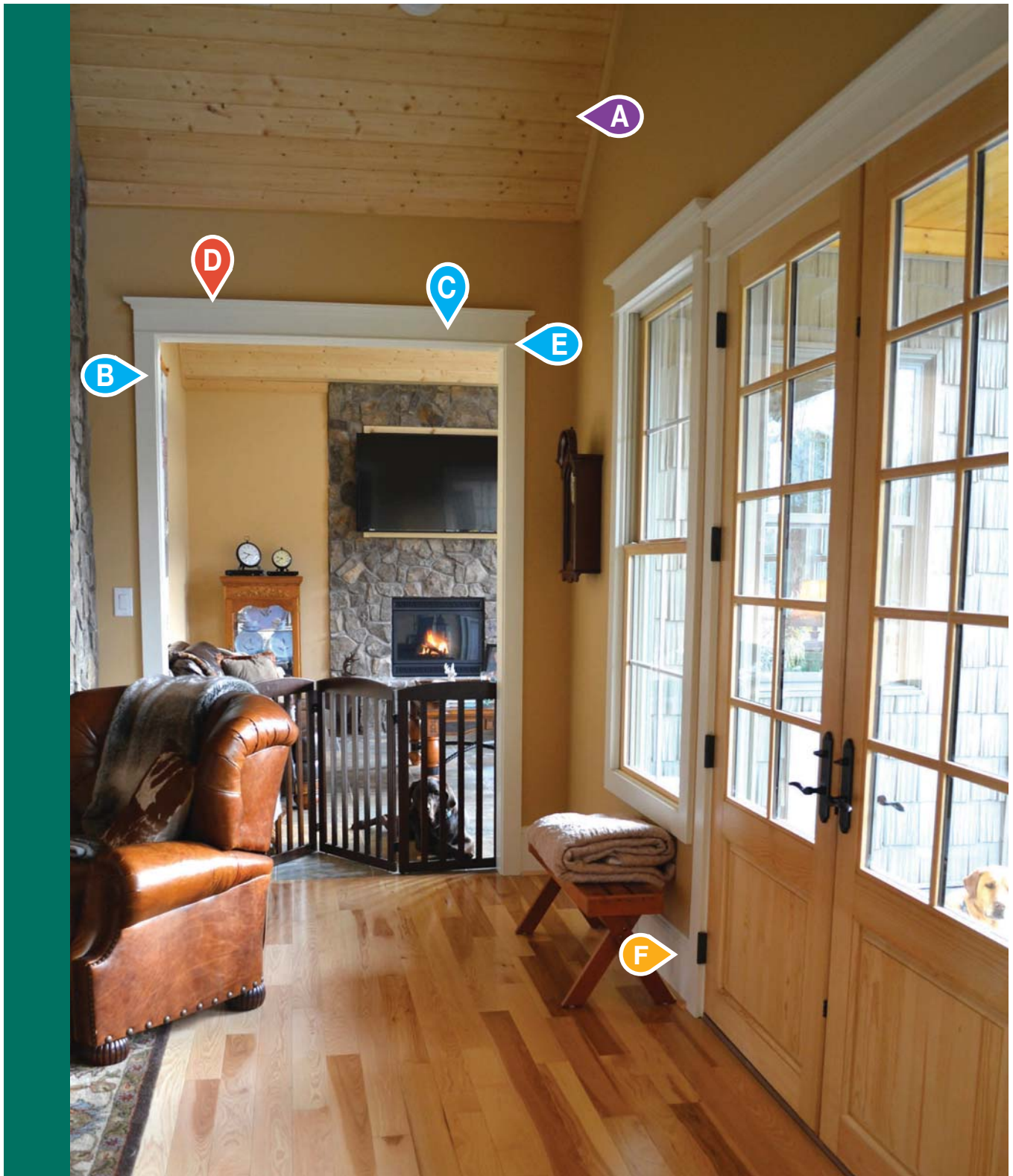

**A** Spruce ECB | Ceiling

**E** EC 886 | Stop

**B** 1 x 4 | Casing

**F** EC 810 | Base

**C** 1 x 6 | Header

**D** EC 3609 | Crown

## Moulding designs should complement the architectural design of your home and your furnishings.

Below is an illustrated guide with suggestions on how to pair mouldings best suited for the dimensions of a room.

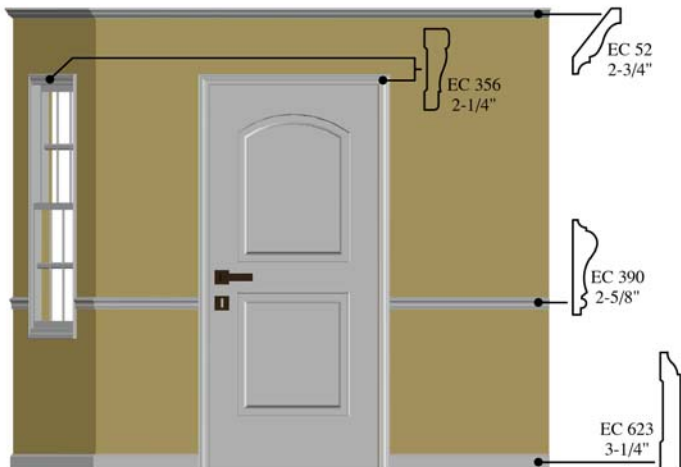

8 ft. Ceiling with a 6 ft. 8 in. Door

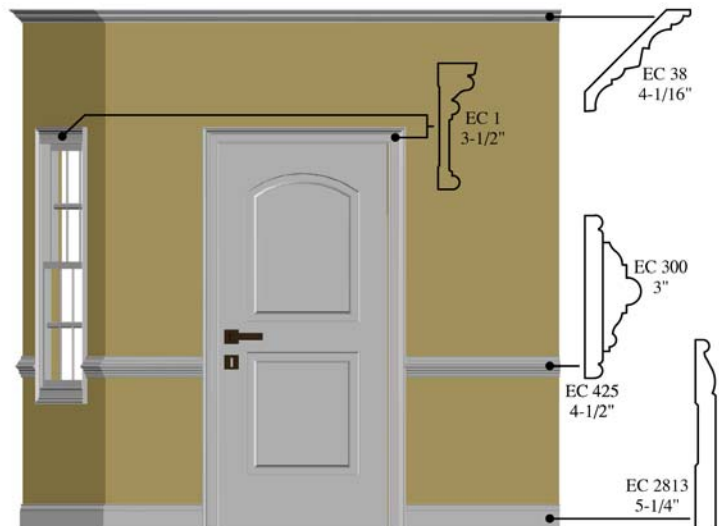

9 ft. Ceiling with a 6 ft. 8 in. Door

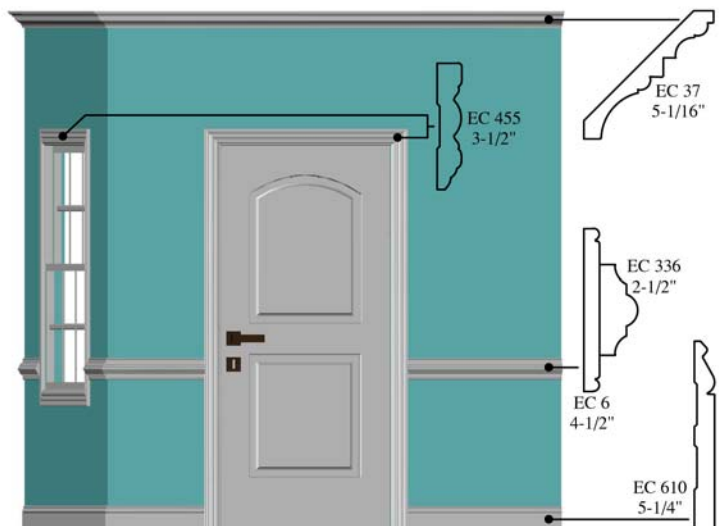

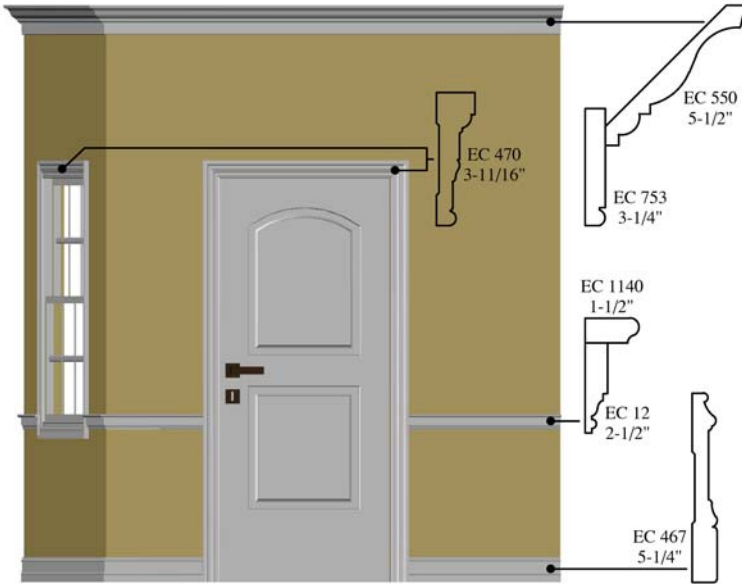

**10 ft. Ceiling with a 7 ft. Door**

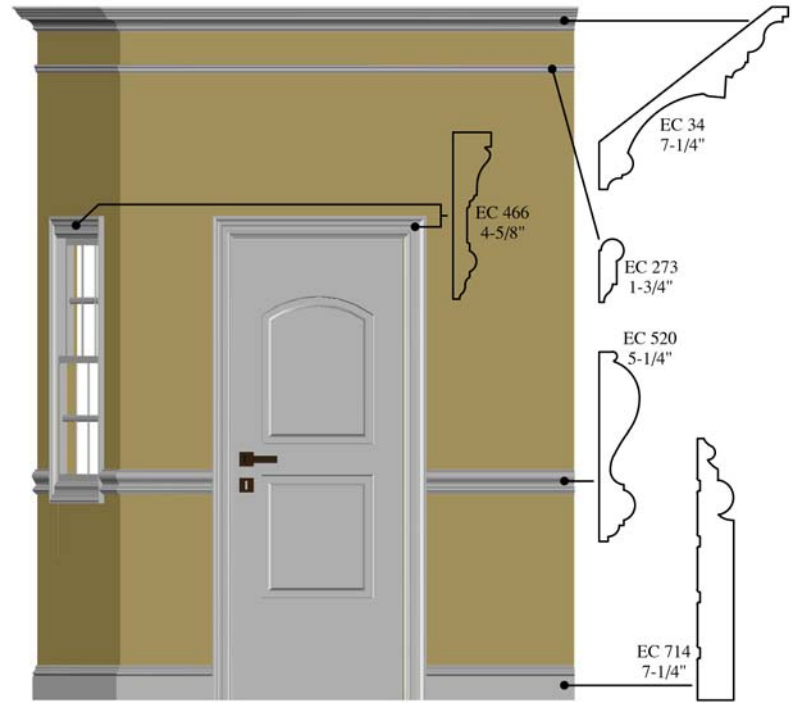

**12 ft. Ceiling with a 8 ft. Door**

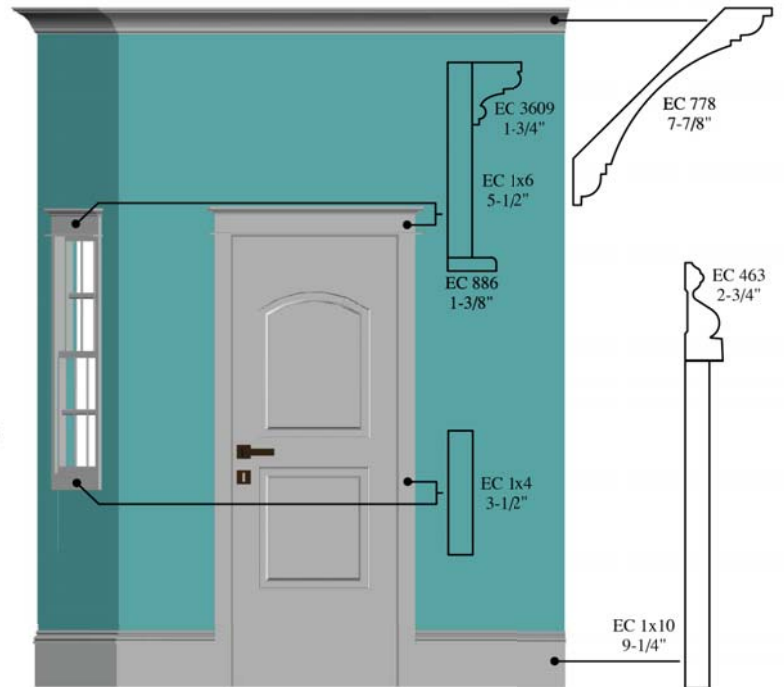
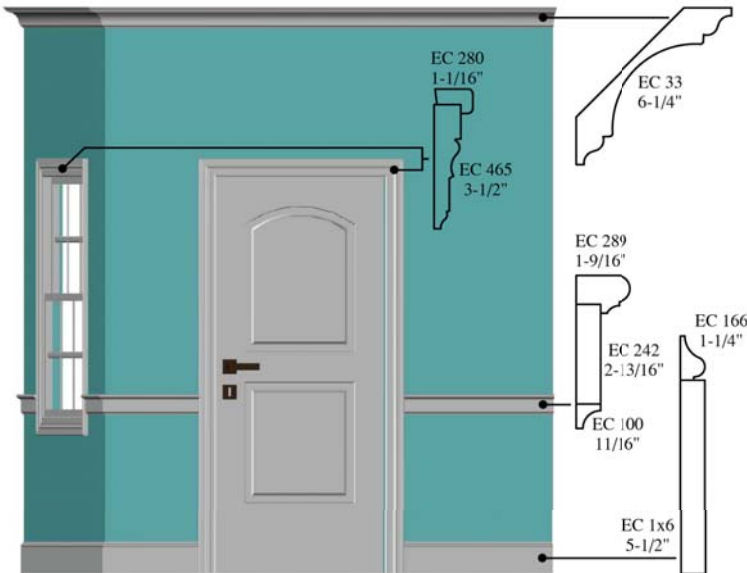

# A new way to select, quote and order mouldings SIMPLE AS 1, 2, 3



1. Select Shape 2. Select Species 3. Place Order

Dealers can now take advantage of a quicker, easier sales process, resulting in more satisfied customers and greater sales.

GEARScan Display technology utilizes a special bar code on each moulding profile. When you select an individual shape, simply scan the GEARScan barcode underneath and you'll see your cost and availability on each stocked and custom order species.

ECMDGears with the new GEARScan functionality makes selling mouldings quicker and customers happier.



Scan this with a QR Code-Ready Smart Phone to view the ECMD Gears video





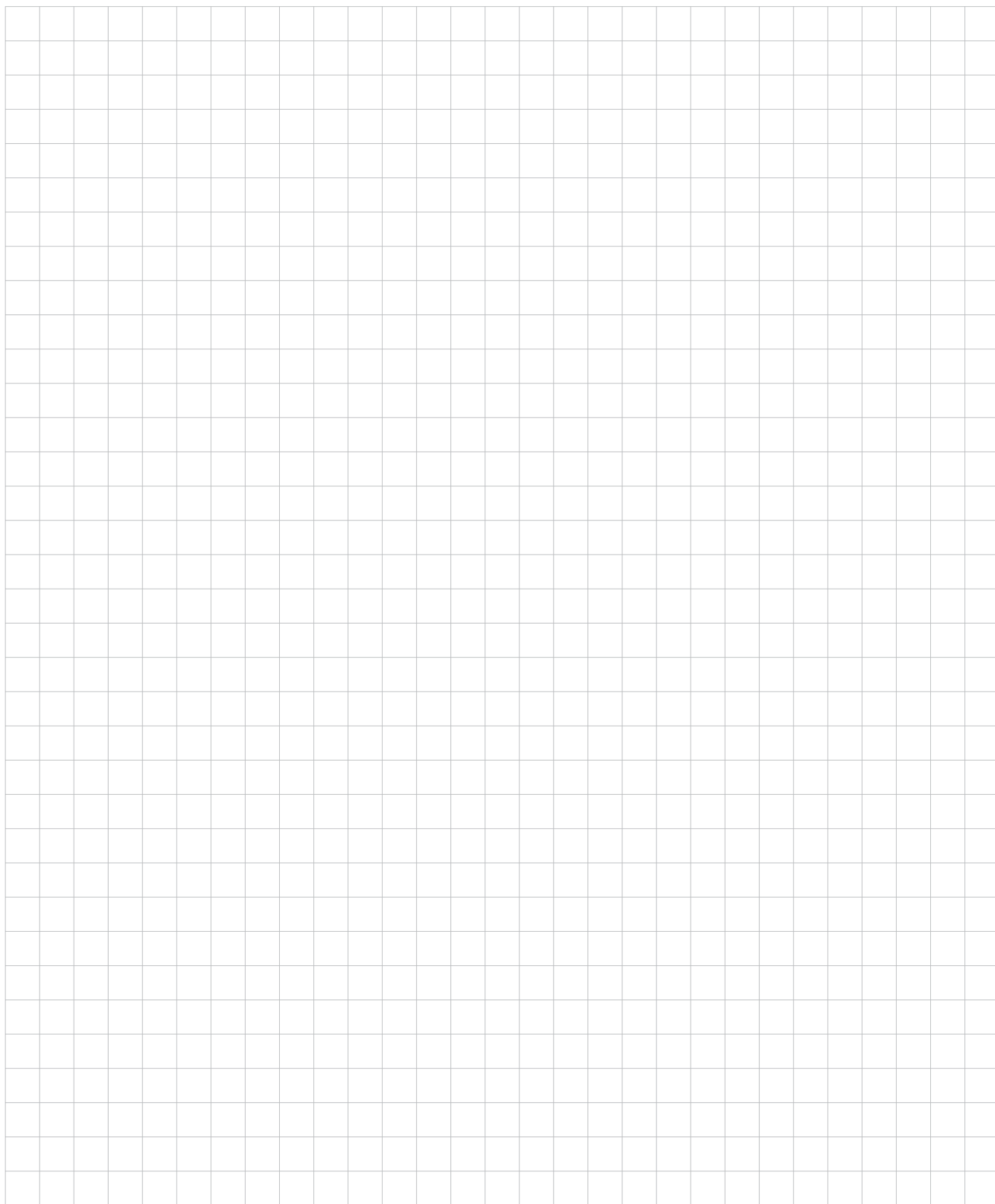

# PRODUCT SELECTION GUIDE

Profile	Type	Stock	Page	Profile	Type	Stock	Page	Profile	Type	Stock	Page
EC 1	Casing	F, P, M, S	16	EC 60	Crown	S	4	EC 205	Corner	S, O	36
EC 2	Chair	S	31	EC 61	Crown	S, M	9	EC 206	Corner	S, O	36
EC 3	Dentil	S	8	EC 68	Crown	S, F, P	10	EC 207	Shingle	P	37
EC 3	Dentil Insert	S	8	EC 70	Crown	P	4	EC 210	Shingle	F, P	37
EC 4	Casing	M	15	EC 74	Crown	S, P	4	EC 212	Shingle	P	37
EC 5	Chair	S	32	EC 75	Crown	S, F, P	5	EC 230	Handrail	S	35
EC 6	Backer	S	33	EC 80	Cove	M	6	EC 231	Handrail	S	35
EC 8	Dentil	S	8	EC 81	Cove	M	6	EC 232	Full Rd.	H	35
EC 9	Dentil	P, S	8	EC 84	Cove	S	6	EC 233	Full Rd.	H	35
EC 12	Apron	F, P, M	16	EC 85	Cove	S	6	EC 236	S4S	S	35
EC 13	Dentil	S	8	EC 94	Cove	S	30	EC 240	Handrail	S	35
EC 14	Casing	P, S	19	EC 100	Cove	S, O, P	30	EC 242	S4S	F, P	38
EC 18	Crown	F	9	EC 101	Cove	S	30	EC 247	S4S	S	38
EC 19	Base	P	30	EC 103	Qtr. Rd.	S	27	EC 248	S4S	S	38
EC 20	Casing	F, P	16	EC 105	Qtr. Rd.	S	27	EC 249	S4S	S	38
EC 24	Crown	P	7	EC 106	Qtr. Rd.	S, P	27	EC 254	S4S	S	38
EC 25	Rosette	S	20	EC 108	Qtr. Rd.	S	27	EC 266	S4S	S	38
EC 26	Plinth	S	20	EC 122	Half Rd.	S	36	EC 267	S4S	S	38
EC 28	Rosette	S	20	EC 126	Shoe	S, O, P	27	EC 273	Picture	S, P, F	9
EC 29	Rosette	S	20	EC 127	Shoe	S, P	27	EC 280	B. Band	S	14
EC 30	Rosette	S, O	20	EC 135	Chair	P	34	EC 281	B. Band	S, F	14
EC 33	Crown	M	7	EC 137	Chair	S, P	34	EC 282	B. Band	P	13
EC 34	Crown	M	8	EC 139	Chair	P	34	EC 283	B. Band	P	14
EC 35	Crown	M	12	EC 142	Screen	S	36	EC 284	B. Band	F	13
EC 36	Crown	M	5	EC 144	Screen	S	36	EC 284A	B. Band	F	13
EC 36A	Crown	M	5	EC 148	Glass Bd.	S	36	EC 289	Panel	S	34
EC 37	Crown	F, P, M, S	8	EC 150	Base Cap	P	7	EC 292	Chair	S	34
EC 38	Crown	F	8	EC 154	Base Cap	P	12	EC 297	Chair	S, F	33
EC 39	Crown	P	7	EC 162	Base Cap	O	24	EC 299	Chair	P	32
EC 40	Crown	P, S	6	EC 163	Base Cap	S, P, M	25	EC 300	Chair	S, P, F	33
EC 41	Crown	P, M, S	10	EC 164	Base Cap	S	25	EC 302	Chair	P	32
EC 42	Panel	P	34	EC 166	Base Cap	S	25	EC 310	Base	M	25
EC 45	Crown	S, F, P, M	11	EC 167	Base Cap	S	25	EC 327	Casing	S, P	17
EC 46	Crown	F	10	EC 172	Base Cap	S	25	EC 336	Chair	F, P	32
EC 47	Crown	S, F, P, M, O	11	EC 180	Brick	S, P	21	EC 340	Chair	P	31
EC 48	Crown	F, P, M	11	EC 182	Panel	P	34	EC 350	Casing	M	15
EC 49	Crown	S, F, P, M	11	EC 183	Chair	S	34	EC 351	Casing	S	17
EC 50	Crown	P, M	7	EC 188	Drip	P	37	EC 356	Casing	S, F, P, M, O	17
EC 51	Crown	S, P, M, O	11	EC 190	Brick	P	13	EC 361	Casing	S, F, P	18
EC 52	Crown	S, F, P	11	EC 197	Drip Cap	P	37	EC 366	Casing	S, F, P, M	18
EC 54	Crown	S, P, O	10	EC 202	Corner	S	36	EC 371	Casing	F	15
EC 58	Crown	S	4	EC 204	Corner	S	36	EC 376	Casing	S, F, P, M	15

F = FJ, Raw    P = FJ Primed    M = Primed MDF    S = Solid Pine    O = Oak    H = Poplar  
R = Raw    U = Spruce    L = Alder    C = Inland Red Cedar    A = Maple    Y = Cypress

# PRODUCT SELECTION GUIDE

Profile	Type	Stock	Page	Profile	Type	Stock	Page	Profile	Type	Stock	Page	
EC 387	Casing	S, P	17	EC 623	Base	S, F, P, M	26	EC 990	Mullion	S	22	
EC 390	Chair	S, F, P	31	EC 623A	Base	O	27	EC 995	Chamfer	S	37	
EC 394	Chair	S	32	EC 625	Base	M	22	EC 1001	Chair Rail	F	33	
EC 394A	Chair	F	32	EC 631	Base	S, P	26	EC 1002	Casing	F	19	
EC 397	Chair	S, P, M	31	EC 663	Base	S, P	27	EC 1006	Casing	F	19	
EC 398	Chair	P, M	33	EC 683	Casing	S, P	17	EC 1021	Stool	S, F, P, M	23	
EC 401	Casing	F, P	16	EC 700	Base	P	30	EC 1121	Stool	P	23	
EC 402	Casing	P	16	EC 705	Base	P	30	EC 1140	Stool	S	22	
EC 405	Casing	P	18	EC 710	Base	S	29	EC 1162	Stool	S, P	22	
EC 412	Casing	P	13	EC 713	Base	S, F, P	29	EC 1163	Stool	S	22	
EC 414	Casing	P	13	EC 714	Casing	F	19	EC 1164	Stool	S, F	22	
EC 425	Backer	F, P	33	EC 714B	Base	M	28	EC 1195	Stool	S, F	22	
EC 433	Casing	F	18	EC 714	Crown	M	12	EC 1206	Shingle	P	37	
EC 436	Casing	P	14	EC 718	Crown	M	4	EC 1217	Chair	S	34	
EC 442	Casing	S, F, P, M	18	EC 734	Crown	M	12	EC 1219	Chair	S	34	
EC 444	Casing	S, F, P, M	17	EC 738	Crown	M	9	EC 1228	Rake	P	37	
EC 444A	Casing	S	17	EC 740	Cabinet	S	36	EC 1229	Rake	P	37	
EC 445	Casing	S, F, P, M, O	15	EC 741	Cabinet	S	36	EC 1300	Astragal	S	21	
EC 445A	Casing	F	15	EC 750	Base	S, P	29	EC 1305	Astragal	S	21	
EC 446	Casing	P	14	EC 751	Base	S, P	29	EC 2805	Base	P	28	
EC 453	Casing	P	14	EC 753	Base	S, P	29	EC 2808	Base	P	28	
EC 455	Casing	F, P	16	EC 755	Casing	F	17	EC 2813	Base	P	28	
EC 458	Crown	M	5	EC 778	Crown	M	6	EC 3609	Crown	P	9	
EC 460	Casing	F, P, M	14	EC 810	Base	S, F, P, M	24	EC 4234	Panel	S, F	34	
EC 463	Casing	F	16	EC 814	Crown	M	5	EC 5180	Base	P, M	30	
EC 464	Casing	F	15	EC 816	Stop	S	21					
EC 465	Casing	P	18	EC 817	Stop	S	21	Boards and Patterns			Stock	Page
EC 466	Casing	P	13	EC 818	Crown	M	9	S4S		F, P, M, S, O, H	39	
EC 467	Base	F, M	27	EC 838	Crown	M	4			A, L, R, Y, U, E, J		
EC 470	Casing	F, P	15	EC 886	Stop	S	21	T&G V-Joint ECB		P, S, Y, U	40	
EC 473	Casing	F	18	EC 910	Base	M	24	Pickwick		S	40	
EC 480	Casing	P	16	EC 935	Stop	S	21	Flooring		S	39	
EC 501	Crown	M	7	EC 936	Stop	S	21	105 Siding		S	40	
EC 514	Casing	F	19	EC 937	Stop	S	21	Eased-Edge S4S		U, M, I	41	
EC 520	Chair Rail	F	31	EC 940	Stop	S	21	S1S2E		C, Y	41	
EC 545	Casing	P	19	EC 941	Stop	S	21	S1S2E Bevel		C, Y	41	
EC 550	Crown	M	4	EC 941A	Stop	S	21	S1S2E RBT Bevel		C	41	
EC 610	Base	S, F, P, M	25	EC 972	Mullion	S	23	WP4		C, Y	40	
EC 616	Base	S, F, M	24	EC 987	Mullion	S	23	Channel		C	41	
EC 618	Base	S, F, P, M	26	EC 988	Mullion	S	23	Decking		U	41	
EC 620	Base	S, F, P, M	26	EC 988A	Mullion	S	23	Penny Gap		M, S, P	40	
EC 620A	Base	O	27	EC 989	Mullion	S	23					

F = FJ, Raw    P = FJ Primed    M = Primed MDF    S = Solid Pine    O = Oak    H = Poplar  
 R = Raw    U = Spruce    L = Alder    C = Inland Red Cedar    A = Maple    Y = Cypress

CROWN

DOOR & WINDOW

BASE

CHAIR RAIL

MISC.

BOARD & PANEL

**Sales and Customer Service**

ECMD Corporate Office

2 Grandview Street

North Wilkesboro, NC 28659

T: 888.222.3961

F: 866.314.0747

[www.eastcoastmouldings.com](http://www.eastcoastmouldings.com)

**EastCoast<sup>®</sup>**  
**Mouldings**