



BOWFLEX

XTREME 2 SE



The Bowflex Xtreme® 2 SE Home Gym Owner's Manual and Fitness Guide



CONGRATULATIONS on your commitment to improving your health and fitness! With the Bowflex Xtreme® 2 SE home gym, you have everything you need to exceed all of your physical fitness, strength, and health expectations!

The Bowflex Xtreme® 2 SE home gym’s exceptional resistance and quality is unmatched by any other single piece of home fitness equipment available. You will not believe the amazing results your body will get with the Bowflex Xtreme® 2 SE home gym!

Please take your time to read through the entire manual and follow it carefully before attempting to use your Bowflex Xtreme® 2 SE home gym. Also locate and read all warning labels that are posted on the machine. It’s important to understand how to properly perform each exercise before you do so using Power Rod® Resistance.

With all of the fitness choices available today, finding the best workout equipment for your needs can be very confusing. Everyone at Nautilus would like to thank you for selecting the Bowflex Xtreme® 2 SE home gym.

The Bowflex Xtreme® 2 SE home gym is the finest home fitness product available, and you’re just about to prove it to yourself.

To validate warranty support, keep the original proof of purchase and record the following information:

Serial Number
Date of Purchase

To register your product warranty, go to:
www.bowflex.com/register
or call 1 (800) 605-3369.

Table of Contents

Important Safety Instructions	2	Arm Exercises:	
Product Specifications	5	Triceps Pushdown w/ Hand Grips	42
Getting To Know Your Machine	6	Triceps Hammer Pushdown	42
How to Use Your Machine	9	Triceps Pushdown w/ Bent Lat Bar	43
Maintenance	12	Single Arm Pushdown	43
Define Your Goals	13	Triceps Extension	44
The Workouts	16	Cross Triceps Extension	44
Chest Exercises:		Hammer Triceps Extension	45
Bench Press	22	Rope Pushdown	45
Chest Fly	22	Triceps Kickback	46
Decline Bench Press	23	Hammer Triceps Kickback	46
Incline Bench Press	23	Resisted Dip	47
Decline Chest Fly	24	Biceps Curl	47
Incline Chest Fly	24	Standing Biceps Curl	48
Shoulder Exercises:		Hammer Biceps Curl	48
Reverse Fly	25	Concentration Biceps Curl	49
Crossover Reverse Fly	25	Reverse Curl	49
Crossover Rear Deltoid Rows	26	Barbell Biceps Curl	50
Crossover High Rear Deltoid Rows	26	Reverse Barbell Biceps Curl	50
Lateral Shoulder Raise	27	Seated Biceps Curl	51
Forearm Lateral Shoulder Raise	27	Seated Biceps Hammer Curl	51
Front Shoulder Raise	28	Arm Opposition Push-Pull	52
Seated Shoulder Press	28	Upper Body Opposition Push-Pull	52
Shoulder Rotator Cuff (internal)	29	Wrist Extension	53
Shoulder Rotator Cuff (external)	29	Wrist Curl	53
Shoulder Extension	30	Abdominal Exercises:	
Shoulder Shrug	30	Trunk Rotation	54
Scapular Protraction	31	Seated (resisted) Oblique Abdominal Crunch	54
Scapular Depression	31	Seated (resisted) Abdominal Crunch	55
Crossover Seated Rear Delt Rows	32	Leg Exercises:	
Scapular Retraction	32	Leg Extension	56
Back Exercises:		Squat	56
Good Morning	33	Standing Hip Extension (knee bent)	57
Standing Low Back Extension	33	Standing Hip Extension (knee extended)	57
Standing Shoulder Pullover w/ Bent Lat Bar	34	Leg Kickback	58
Standing Shoulder Pullover w/ Hand Grips	34	Hip Flexion	58
Narrow Pulldowns w/ Bent Lat Bar	35	Dead Lift	59
Narrow Pulldowns w/ Hand Grips	35	Stiff Leg Dead Lift	59
Bent Over Row	36	Standing Hip Adduction	60
Crossover Bent Over Row	36	Standing Hip Abduction	60
Seated Lat Rows	37	Calf Raise	61
Crossover Seated Lat Rows	37	Single Leg Calf Raise	61
Reverse Grip Pulldowns w/ Lat Bar	38	Muscle Chart	62
Reverse Grip Pulldowns w/ Hand Grips	38	Exercise Log	63
Crossover Wide Pulldowns w/ Hand Grips	39	Bowflex Xtreme® 2 SE Home Gym 6-Week	
Crossover Narrow Pulldowns w/ Hand Grips	39	Satisfaction Guarantee	65
Pulldowns	40	Contacts	66
Stiff Arm Pulldowns	40		
Seated Lat Pulldowns	41		
Seated Wide Lat Pulldowns	41		

Important Safety Instructions



Indicates a potentially hazardous situation which, if not avoided, could result in death or serious injury.

Before using this equipment, obey the following warnings:



Read and understand the complete Owner's Manual. Keep Owner's Manual for future reference.

Read and understand all warnings on this machine. If at any time the Warning stickers become loose, unreadable or dislodged, contact Nautilus® Customer Service for replacement stickers.

- Children must not be let on or near to this machine. Moving parts and other features of the machine can be dangerous to children.
- Not intended for use by anyone under 14 years of age.
- Consult a physician before you start an exercise program. Stop exercising if you feel pain or tightness in your chest, become short of breath, or feel faint. Contact your doctor before you use the machine again.
- Before each use, examine this machine for loose parts or signs of wear. Inspect all cables, pulleys and their connections, making sure they are properly secured and attached, and show no signs of visible wear or damage. Contact Nautilus® Customer Service for repair information.
- Maximum user weight limit: 300 lb. (136 kg). Do not use if you are over this weight.
- This machine is for home use only.
- Do not wear loose clothing or jewelry. This machine contains moving parts. Do not put fingers or other objects into moving parts of the exercise equipment.
- Always wear rubber soled athletic shoes when you use this machine. Do not use the machine with bare feet or only wearing socks.
- Set up and operate this machine on a solid, level, horizontal surface.
- Do not operate this machine outdoors or in moist or wet locations.
- Keep at least 6" (15 cm) clear behind the rod box, and 36" (91 cm) in front of the machine. Keep 15" (38 cm) on the sides of the machine clear. This is the recommended safe distance for access and passage around and emergency dismounts from the machine. Keep third parties out of this space when machine is in use.
- Do not over exert yourself during exercise. Operate the machine in the manner described in this manual.
- Do not use Dumbbells or other weight equipment to incrementally increase the weight resistance. Use only the weight resistance designed for use with this gym.
- Correctly engage the Selector Hook to the Rod End.
- Correctly adjust and safely engage all Positional Adjustment Devices. Make sure that the Adjustment Devices do not hit the user.
- Keep clear of Power Rod® movement path during operation. Keep any bystanders clear of machine and Power Rod® movement path during operation.
- Do not move the machine without aid. Injury to you or damage to the machine can occur.

Safety Warning Labels

Locate and read all safety warnings on the machine before using it. Replace any warning label if it is damaged, illegible, or missing. If you need replacement labels, call a Nautilus Representative. Refer to the Contacts page at the back of this manual.

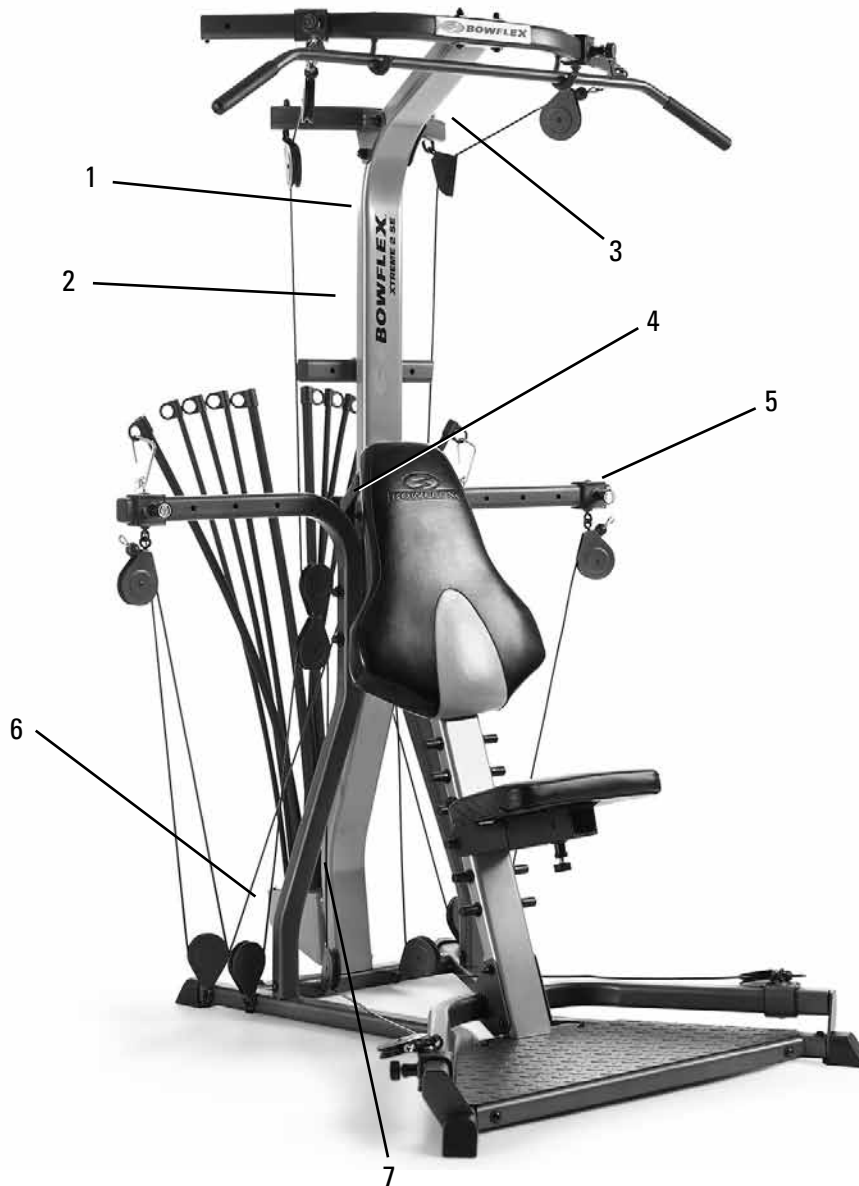

Type		Description
1	WARNING	<ul style="list-style-type: none">• Misuse or abuse of this equipment may lead to serious injury.• Keep children away and supervise teenagers using equipment.• Obtain, read and understand the owner's manual provided with this fitness equipment prior to use.• Replace this or any other warning label if damaged, illegible or missing.

Safety Label Warnings

	Type	Description
2	CAUTION	Before each use check all snap hooks, cables and pulleys for wear and proper function. Tighten all fasteners as necessary.
	MISE EN GARDE	Avant chaque utilisation, vérifiez le fonctionnement de tous les mousqueton, câbles et poulies. Serrez bien toutes les fixations au besoin.
	VORSICHT	Überprüfen Sie alle Karabinerhaken, Kabel und Rollen vor jeder Benutzung auf Abnutzungserscheinungen und Fehlfunktionen. Ziehen Sie alle Befestigungselemente ordnungsgemäß an.
	PRECAUCIÓN	Antes de cada uso, revise todos los cierres a presión, cables y poleas para asegurarse de que no estén desgastados y que funcionan correctamente. Apriete todos los sujetadores según sea necesario.
3	[NOTICE]	Do not hang from bar.
		Ne pas pendre de la barre.
		Nicht von der Stange hängen.
		No cuelgue de la barra.
4	WARNING	The Maximum User Weight for this machine is 300 pounds (136 KG). This machine is for Home use only.
	WARNUNG	Das Maximale Belastungsgewicht für diese Maschine beträgt 136 kg. Dieses Gerät ist nur für die Nutzung im Heimbereich freigegeben.
	AVERTISSEMENT	Le poids maximum de l'utilisateur pour cette machine est de 136 kg (300 livres). Cet équipement est destiné à un usage privé uniquement.
	ADVERTENCIA	El peso máximo para el usuario de esta Máquina es de 136 kg (300 libras). Este equipamiento sólo se puede utilizar en el hogar.
5	WARNING	Make sure selector pin is securely locked into place before starting exercise.
6	CAUTION	At all times, stay out of the paths of moving rods.
	MISE EN GARDE	Restez toujours à l'écart des tiges mobiles.
	VORSICHT	Halten Sie stets Abstand zu beweglichen Stangen.
	PRECAUCIÓN	En todo momento, manténgase alejado del trayecto de las barras móviles.
7	Serial Number	Located on the back of the lower lat tower. Note: For future reference record this number in the serial number box on the Contacts page of this manual.

Specifications / Approvals

Product Specifications

Product Weight	157 lbs. (71 kg)
Product Dimensions	53" (135 cm) long x 49" (124 cm) wide x 82" (208 cm) high
Workout Area	96" (244 cm) long x 78" (198 cm) wide
Number of Exercises	Over 70
Power Rod® Resistance	210 lbs. (95 kg) Nominal
Power Rod® Upgradability	310 lbs. (141 kg.) 410 lbs. (186 kg.)
User Weight Limit	300 lbs. (136 kg)

Regulatory Approvals

Meets:

EN957-1 Class H

EN957-2 Class H

Meets:

ASTM F2276-05

ASTM F2216-05

Getting to Know Your Machine

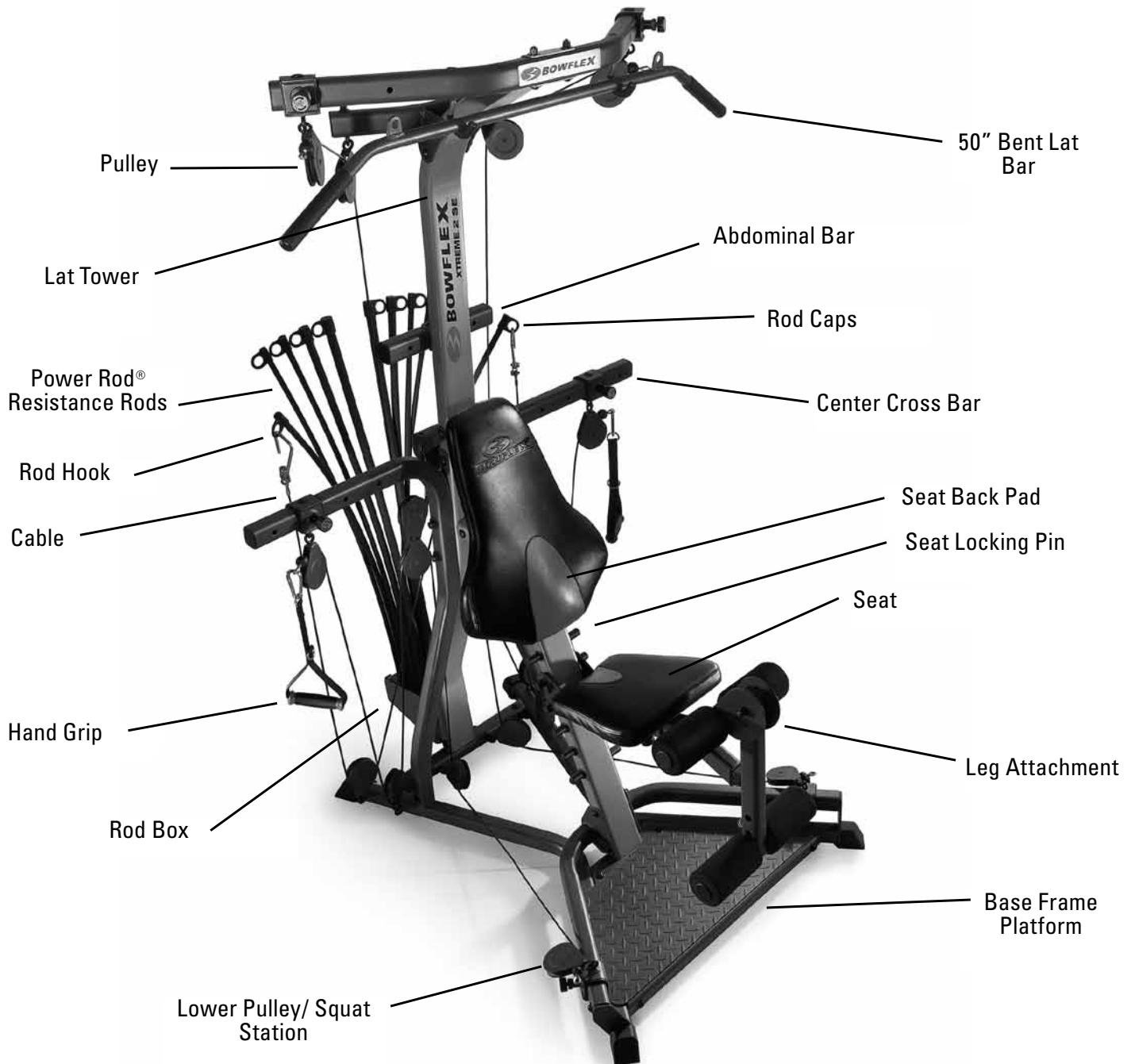

Getting to Know Your Machine

Power Rod® Resistance

Power Rod® resistance rods are made from a special composite material. Your rods are sheathed with a protective black rubber coating. Each rod is marked with its weight rating on the “Rod Cap.”

Adjusting and Understanding the Resistance

The standard Bowflex Xtreme® SE home gym comes with 210 pounds of nominal resistance (one pair of 5 lb. (2.25 kg) rods, two pairs of 10 lb. (4.5 kg) rods, one pair of 30 lb. (13.5 kg) rods, and one pair of 50 lb. (22.5 kg) rods).

Note: Power Rod® Resistance Rods are manufactured using nylon composite material. The weight resistance measurements are estimates and resistance can vary based on environmental and usage patterns and other factors. Rod resistance will normally degrade over time and after extensive usage. If you have any questions regarding the resistance of your Power Rod® Resistance Rods, contact our Bowflex® Customer Service department for assistance.

If you upgraded to a 310 (140 kg) or 410 pound (186 kg) capacity you will have an additional one or two pair of 50 lb. (22.5 kg) rods, respectively.

Connecting the Power Rod® Unit to the Cables

You may use one rod or several rods in combination, to create your desired resistance level.

To hook multiple rods up to one cable, bend the closest rod toward the cable and place the cable hook through that rod cap. You can then hook up the next closest rod through the same cable hook.

Hooking up the closest rod first prevents rods from crossing over the top of one another.

Safety

! When hooking the Power Rod® resistance rods to the cable hooks, do not stand directly over the tops of the rods. Stand off to one side when connecting and disconnecting the Power Rod® resistance rods from the cables.

When You Are Not Using Your Home Gym

Disconnect the cables from the Power Rod® resistance rods when you are not using your Bowflex Xtreme® SE home gym.

! Keep the cables and Power Rod® units bound with the rod binding strap when not in operation, and be sure and remove the binding strap before beginning any exercises using the rods.



**To Order Additional Sets
of 50 lb. (22.5 kg) Power Rod®
Resistance Rods,
Please Call (800) 628-8458.**

Getting to Know Your Machine

The Bowflex Xtreme® 2 SE Home Gym Pulleys

With the versatility to perform over 75 different exercises, the Bowflex Xtreme® 2 SE home gym is designed to give you the best workout possible. And with its innovative, easy-to-use multiple pulley system, you are guaranteed to maximize every exercise for every muscle group.

There are a few things you will need to remember to get the most from your Bowflex Xtreme® 2 SE home gym Pulleys:

Slider Pulleys

The Bowflex Xtreme® 2 SE home gym comes with adjustable “Slider” pulleys which can be personalized for your body by adjusting them to widths that fit your unique physique. There are Slider Pulleys on the Lat Tower (2 positions per side), Center Cross Bars (4 positions per side) and the Squat Pulley Frame (4 positions per side).

You will need to determine which Pulley positions are most comfortable for you when performing ‘Standard’ exercises, and then adjust the pulleys outward or inward to perform exercises in ‘Wide’ or ‘Narrow’ positions. Using the Slider Pulleys at wider or narrower positions for an exercise can target different parts of the same muscle group and increases the benefit of each exercise.

Pulley Locations

Below is a guide to the six different pulley positions used to perform a full workout routine:



Center Cross Bar:
Standard position – used when performing exercises like a Bench Press or Chest Fly.



Lat Tower:
Used for exercises like Pulldowns and Pushdowns.



Leg Extension:
Active pulleys are on the squat pulley frame.



Squat:
Active pulleys are on squat pulley frame and on center cross bar.



Abdominal Crunch position:
Active pulleys are on lat tower.



Rowing Position:
Active pulleys are on squat pulley frame.

How to Use Your Machine

The Bowflex Xtreme® 2 SE Home Gym Cable Routing

To use the Ab Crunch position, you will move the Slider Pulleys and cables from the Center Cross Bar to the Abdominal Bar on the Lat Tower. Refer to the illustrations below for proper cable routing.

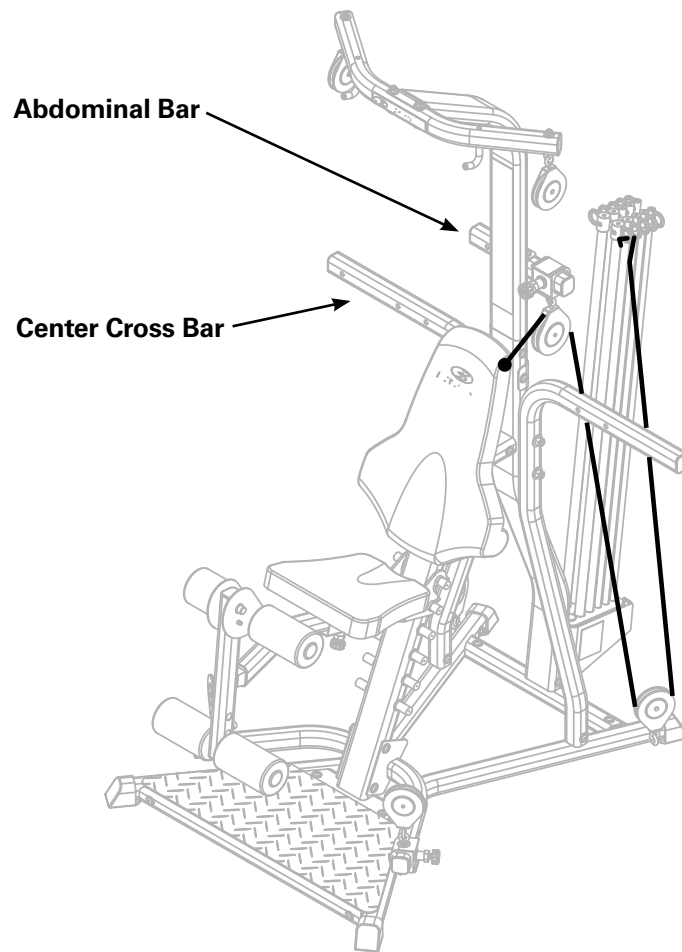

- ⚠ Keep your body weight centered on the machine, seat or base frame platform while exercising.
- When using the machine for standing leg exercises, always hold the Lat Tower of the machine for stability.
- Do not make any adjustments to the seat while sitting on it. Do not stand on the seat.

All exercises in this manual are based on the calibrated resistance and capacity levels of this machine. Only exercises included in this manual or in written materials authorized and supplied by Bowflex® are recommended for operation with this machine.

How to Use Your Machine

Seat Locking Pin

The Seat Locking Pin securely fastens the seat bottom bracket to the seat support rail. The locking pin serves to stabilize the seat for all exercises that require sitting or leaning on it. Make sure the seat has been secured before putting weight on it or attaching Power Rod® resistance to cables attached to the Leg Extension attachment.

Handgrips and Straps

The handgrips fit snugly around your wrist, ankle, or instep. Attach grips to cables by snapping the cable clip onto the D-ring.

Standard Grip: Grasp the handle and cuff together to form a grip without inserting your hand through the cuff portion. Most exercises utilize this grip. The Standard Grip also is used for Hammer Grip exercises, when you need to hold the hand grip vertically for greater wrist support.

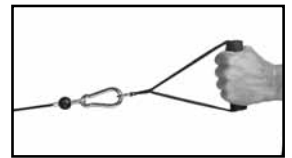

Hand Cuff Grip: Slip your hand through the cuff so that the foam pad rests on the back of your hand. Then grasp the remainder of the grip that is sitting in your palm. This method of gripping is great for exercises like front shoulder raises or any exercise where your palm is facing down.



Ankle Cuff Grip: The cuff opening can be made larger to accommodate the ankle. Simply insert your hand in the cuff and slide it away from the handle. Insert your foot or ankle and tighten the grip by sliding the handle back toward the cuff.



**Abdominal Crunch
Shoulder Harness:**

Arch Cuff Grip: The cuff opening can also fit securely over the arch of your foot. For this grip, insert your foot through the cuff until it is around the arch of your instep, and tighten the cuff around your heel to secure the grip.



Attach the snap hooks to the D-rings on both ends of the harness. Place the harness on your shoulders letting the handles hang over your chest. Grab both handles. With high resistance, a cross arm opposite-handle grip may be used.



Lat Pulldown Bar

The Lat Pulldown Bar enhances exercises that work back, shoulders and triceps muscles.

How to Use Your Machine

Leg Extension Attachment

The leg extension attachment enables you to work the major muscle groups in the legs.

Abdominal Crunch Shoulder Harness

The ab harness gives you the ability to strengthen the muscles of the abdomen by safely adding resistance to abdominal exercises. When using the ab harness, relocate the pulleys from the chest bar to the short abdominal bar.

Safety

Make sure that the seat has been stabilized with the seat locking pin before sitting or putting weight on the seat.

 Before using the grips, straps, lat bar, or ab harness, make sure that all fasteners are in place and tightened.

Make sure that auxiliary cables for the lat bar and leg extension are securely fastened to the primary cables on the unit.

Always use the lock knob on the slider to secure pulleys. Do not allow pulleys to change position during any exercise.

Always use the bar holders to support the lat bar or remove the bar when not in use.

Do not hang from the Lat Tower nor attempt to perform “chin ups” from the bar.

Never pull on the bar unless there is resistance attached to it.

Always use the Lock Knob to secure the attachment to your Bowflex Xtreme® 2 SE home gym.



Grips manufactured under license agreement with Hands-On Sports & Gym Accessories, Inc. Patent #4756527

Maintenance

Inspect your machine for any worn or loose components prior to use. Tighten or replace any worn or loose components prior to use. Pay close attention to cables, straps, or harness and their connections.

Review all warning notices.

-  The safety and integrity designed into a machine can only be maintained when the equipment is regularly examined for damage and repaired. It is the sole responsibility of the owner to ensure that regular maintenance is performed. The owner is responsible to make sure that regular maintenance is done. Worn or damaged components must be repaired or replaced immediately. Only manufacturer supplied components should be used to maintain/repair the equipment.

Clean the bench with a non-abrasive household cleaner after each use. This will keep it looking new. Do not use automotive cleaner, which can make the bench too “slick.”

-  This product, its packaging, and components contain chemicals known to the State of California to cause cancer, birth defects, or reproductive harm. This Notice is provided in accordance with California’s Proposition 65. If you would like additional information, please refer to our Web site at www.nautilus.com/prop65.

If you have any questions regarding your Bowflex Xtreme® 2 SE home gym, please contact our Customer Service Department at 1-800-605-3369 or by mail to: Customer Service, Nautilus, Inc. World Headquarters, 16400 SE Nautilus Drive, Vancouver, WA 98683.

Define Your Goals

Your body will do what you train it to do. That's why it's important to define your goals and focus them. Here are some fitness components that will help you define your goals and choose your fitness program.

Muscle Strength is the maximum force that you can exert against resistance at one time. Your muscle strength comes into play when you pick up a heavy bag of groceries or lift a small child. It is developed when a localized muscle is worked both positively (concentric) and negatively (eccentric) at a resistance – great enough so you can perform only five to eight repetitions of the exercise before the muscle fails. Each set of repetitions is followed by a rest interval that typically runs three times longer than the set. Later, between exercise sessions, the muscle overcompensates for the stress and usually increases in both strength and size.

Muscle Endurance is the ability to perform repeated contractions. It comes into play when you cross-country ski or work on your feet all day. Endurance training addresses the slow twitch, endurance muscle fibers, which depend on oxygen for energy. To develop muscle endurance, use low resistance and high repetitions – about 15-20 repetitions in each set, three sets to each exercise, working the muscle only to fatigue.

Muscle Power is the combination of strength and speed of the muscular contraction. This is often misinterpreted as A) being directly associated with certain skill or sport and/or B) meaning that you must move fast. Load is actually a more important factor than speed when attempting to improve power. When training to achieve muscular power, pick a resistance that fatigues you in the 3-5 repetition range. When performing these reps, it is more important to think of contracting the muscles faster rather than attempting to move faster. Performing sport simulation exercises usually results in a deterioration of the motor pattern or skill. The bio-mechanically sound method of improving power in your sport is to train for power using the correct joint movements, as described in this manual. Then practice the skill associated with your sport, learning to apply this newly achieved power.

Body Composition is the ratio of fat weight (fat) to lean weight (muscles, bones and tissue). As you age, the ratio shifts. The fat weight increases and the lean weight decreases. Training for muscle strength will generally increase muscle size and aerobic conditioning will help burn extra calories. Performing these two forms of exercise, either at different times or together, will create the greatest changes in body fat weight.

Balanced Strength and alignment are the result of equal strength developed in all parts of the body. It comes into play in your standing and sitting posture, and in your ability to perform just about any activity safely and effectively. An over-development of the back will round the shoulders; weak or stretched abdominals can cause lower back pain. You want a balance of muscle strength in front and back. In addition, you need a balance of strength between your middle, lower and upper body.

Flexibility is the ability of a muscle or group of muscles to move the joint through a full range of motion. Flexibility comes into play when you execute an overhand serve or stretch for the top shelf in the kitchen. It is a cooperative movement of opposite muscle groups. When a muscle contracts, its opposite muscle group must relax for the action to occur. Increased flexibility means an increased range of motion, made possible by this simultaneous contracting and relaxing. Good flexibility is important in protecting the body from injury and can be achieved through the balanced strength training programs that are included in this manual.

Cardiovascular Endurance is the ability of the heart and lungs to supply oxygen and nutrients to exercising muscles over an extended period of time. It comes into play when you jog a mile or ride a bike. It is a critical component of overall fitness and health. You may want to design your own personal program specifically geared to your goals and lifestyle. Designing a program is easy, as long as you follow the below guidelines.

Define Your Goals

Design Your Own Program

Understand fitness and its components. Improperly designed programs can be dangerous. Take some time to review this manual as well as other fitness guides.

Know your current fitness level. Before you start any fitness program you should consult a physician who will help you determine your current abilities.

Identify your goals. Goals are critical to choosing and designing an exercise program that fits and enhances your lifestyle, but so is strategy. It's important not to rush the process and try to accomplish too much too soon. That will lead to setbacks and discouragement. Instead, set a series of smaller achievable goals.

Select complementary exercises. Be sure to pair exercises that address compound joint movements and single joint movements. In addition, select exercises that address complementary muscle groups.

Put first things first. During each session, first work muscle groups that need the most training.

Remember your cardiovascular component. Any fitness program must contain a cardiovascular fitness component to be complete. So complement your resistance training with aerobic exercise such as walking, running, or bicycling.

Training variables. When designing your own program there are several variables that, when mixed properly, will equal the right fitness formula for you. In order to find out the best formula, you must experiment with several combinations of variables.

The variables are as follows:

- **Training Frequency:** The number of times you train per week. We recommend daily activity but not daily training of the same muscle group.
- **Training Intensity:** The amount of resistance used during your repetition.
- **Training Volume:** The number of repetitions and sets performed.
- **Rest Intervals:** The time you rest between sets and the time you rest between workouts.

Once you've established a base of fitness, follow these basic principles:

- **Isolate Muscle Groups:** Focus work on specific muscle groups.
- **Progressive Loading:** The gradual systematic increase of repetitions, resistance and exercise period.

Workout Guide

Working Out

A workout begins in your mind's eye. With concentration and visualization you can approach your workout with a positive, constructive attitude. A good pre-workout mental routine is to sit and relax, so that you can focus on what you are about to do and think about achieving your end goal.

Warming Up

We recommend that you warm up by doing light stretching and performing light exercises on the Bowflex Xtreme® 2 SE home gym.

Your Routine

The workout portion of your fitness routine is the series of exercises devoted to your particular goals. Remember, make sure to have fun!

Cool Down

An essential part of the exercise routine is the cool down. Gradually reduce the level of exercise intensity so that blood does not accumulate in one muscle group, but continues to circulate at a decreasing rate. Remember to gradually move yourself into a relaxed state.

Breathing

The most important part of breathing during exercise is, quite simply, that you do it. Breathing in or out during the actual performance is not dependent upon the direction of air flow relative to exertion. It is, in fact, a mechanical process that changes the position of your spine as your rib cage moves. Here are some tips for breathing:

- 1) Be cautious when you are concentrating or exerting effort. This is when you will probably hold your breath. **DO NOT** hold your breath. Do not exaggerate breathing. Depth of inhalation and exhalation should be natural for the situation.
- 2) Allow breathing to occur, naturally, don't force it.

The Workouts

20 Minute Better Body Workout

Frequency: 3 Days Per Week (M-W-F) Time: About 20 Minutes

Start by performing one set of each exercise. Warm up with a light resistance that you can perform easily for 5 -10 reps without fatiguing. Focus on practicing and learning your technique before increasing the resistance. Then move to a more challenging resistance that you can perform no less than 10 reps and no more than 15 reps without your form deteriorating. As you become stronger, you can advance to two sets for each exercise. Complete all sets of each exercise before moving on to the next one. Rest 30 to 45 seconds between sets. Move slowly on each rep. Use a pace that would allow you to stop the movement instantly at any point in the rep. Count three seconds up and three seconds down and work to fatigue during each set.

Body Part	Exercise	Sets	Reps
Chest	Bench Press	1-2	10-15
Back	Seated Lat Rows	1-2	10-15
Shoulders	Crossover Rear Deltoid Rows	1-2	10-15
Arms	Biceps Curl	1-2	10-15
	Triceps Pushdown	1-2	10-15
Legs	Leg Extension	1-2	10-15
Trunk	Standing Low Back Extension	1-2	10-15
	Seated Abdominal Crunch	1-2	10-15

Advanced General Conditioning

Frequency: 4 Days Per Week (M-T-TH-F) Time: About 35-45 Minutes

When you are proficient in performing the exercise techniques of the above routine and are no longer realizing results, or have become just plain bored, it is time to change your program. You can increase your training with this "split system" routine that works opposing muscle groups on different days. To do this, you'll increase your resistance when you can perform 12 reps perfectly, and you'll increase your volume by performing more sets and more exercises. Move slowly on each rep. Use a pace that would allow you to stop the movement instantly at any point in the rep. Count three seconds up and three seconds down and work to fatigue during each set.

Day 1 & 3

Body Part	Exercise	Sets	Reps
Chest	Bench Press	1-3	10-12
Shoulders	Seated Shoulder Press	1-3	10-12
Arms	Triceps Pushdown	1-3	10-12
	Biceps Curl	1-3	10-12
Legs	Leg Extension	1-3	10-12

Day 2 & 4

Body Part	Exercise	Sets	Reps
Back	Seated Lat Rows	1-3	10-12
	Seated Lat Pulldowns	1-3	10-12
Shoulders	Crossover Rear Deltoid Row	1-3	10-12
Arms	Biceps Curl	1-3	10-12
	Reverse Curl	1-3	10-12
Trunk	Standing Low Back Extension	1-3	10-12
	Seated Abdominal Crunch	1-3	10-12

The Workouts

20 Minute Upper/Lower Body

Frequency: 4 Days Per Week (M-T-TH-F) Time: About 20 Minutes

This program provides you with a quick and effective workout that combines muscle conditioning with some cardiovascular benefits. Do this routine when you are limited in time or just want a variation to your normal routine. Perform this program training 2 days, resting 1 to 2. Perform all exercises to near failure, stopping at the point that your technique starts to deteriorate. Rest only 20-30 seconds between sets. As you get stronger, increase the number of sets you perform. Move slowly on each rep. Use a pace that would allow you to stop the movement instantly at any point in the rep. Count three seconds up and three seconds down.

DAY 1 & 3

Body Part	Exercise	Sets	Reps
Chest	Bench Press	1-3	12-15
Back	Seated Lat Rows	1-3	12-15
Shoulders	Crossover Rear Deltoid Rows	1-3	12-15
Arms	Biceps Curl	1-3	12-15
	Triceps Extension	1-3	12-15

DAY 2 & 4

Body Part	Exercise	Sets	Reps
Legs	Leg Extension	1-3	12-15
	Standing Hip Extension	1-3	12-15
	Standing Hip Abduction	1-3	12-15
	Standing Low Back Extension	1-3	10-12
Trunk	Seated Abdominal Crunch	1-3	10-12

The Workouts

Body Building

Frequency: 3 Days On, 1 Day Off

Time: About 45-60 Minutes

Body building requires focused concentration and dedication to training, as well as proper eating habits. Train each muscle group to failure before moving on to the next exercise. Do not neglect any muscle group. If needed, include an aerobic activity to increase your caloric expenditure and help to reduce your body fat levels to achieve a defined muscular look. Rest 30-60 seconds between each set and exercise. Focus on proper form. Tighten the muscle before you move, squeeze the muscle as you move, cramp the muscle at the point of full contraction, and resist the movement as you lower the weight. Move slowly on each rep. Use a pace that would allow you to stop the movement instantly at any point in the rep. Count three seconds up and three seconds down and work to fatigue during each set.

DAY 1

Body Part	Exercise	Sets	Reps
Chest	Bench Press	2-4	8-12
	Chest Fly	2-4	8-12
Shoulders	Seated Shoulder Press	2-4	8-12
	Crossover Rear Deltoid Row	2-4	8-12
	Lateral Shoulder Raise	2-4	8-12
	Shoulder Shrug	2-4	8-12

DAY 2

Body Part	Exercise	Sets	Reps
Back	Seated Lat Row	2-4	8-12
	Seated Lat Pulldowns	2-4	8-12
Arms	Biceps Curl	2-4	8-12
	Reverse Curl	2-4	8-12
	Triceps Pushdown	2-4	8-12
	Triceps Extension	2-4	8-12

DAY 3

Body Part	Exercise	Sets	Reps
Legs	Squat	2-4	8-12
	Leg Extension	2-4	8-12
	Standing Hip Extension	2-4	8-12
	Standing Low Back Extension	2-4	8-12
Trunk	Seated Abdominal Crunch	2-4	8-12
	Seated Oblique Abdominal Crunch	2-4	8-12

The Workouts

Circuit Training – Anaerobic/Cardiovascular

Frequency: 2-3 Times Per Week

Time: About 20-45 Minutes

Circuit training is a great way to achieve the benefits of strength training and cardiovascular training in one quick, challenging routine. The idea is to move quickly from exercise to exercise, taking only as much rest between sets as it takes to set up the next exercise (less than 20 seconds). One circuit equals one set of each exercise. Initially, start with completing one round of Circuit 1. Then add an additional round of the same circuit. Once you reach three rounds of Circuit 1, add one round of Circuit 2. Add additional rounds of Circuit 2 as your fitness level increases. Repeat process with Circuit 3. Do not let your heart rate exceed 220 minus your resting heart rate. Perform each rep of each exercise slowly and with perfect technique. Count three seconds up and three seconds down.

Circuit 1

Body Part	Exercise	Reps
Chest	Bench Press	8-12
Legs	Squat	8-12
Back	Seated Lat Row	8-12
Trunk	Seated Abdominal Crunch	8-12

Circuit 2

Body Part	Exercise	Reps
Shoulders	Seated Shoulder Press	8-12
Legs	Leg Extensions	8-12
Back	Seated Lat Pulldowns	8-12
Trunk	Standing Low Back Extension	8-12
Arms	Biceps Curl	8-12

Circuit 3

Body Part	Exercise	Reps
Shoulders	Crossover Rear Deltoid Rows	8-12
Arms	Triceps Pushdown	8-12
Trunk	Seated Oblique Crunch	8-12

The Workouts

True Aerobic Circuit Training

Frequency: 2-3 Times Per Week

Time: About 20-60 Minutes

Circuit training is a great way to achieve the benefits of strength training and cardiovascular training in one quick, challenging routine. By returning to an aerobic exercise between each set you are increasing your aerobic capacity, endurance and burning fat as energy. The idea is to move quickly from exercise to exercise, taking only as much rest between sets as it takes to set up the next exercise (less than 20 seconds). One circuit equals one set of each exercise. Initially, start with completing one round of Circuit 1. Then add an additional round of the same circuit. Once you reach three rounds of Circuit 1, add one round of Circuit 2. Add additional rounds of Circuit 2 as your fitness level increases. Do not let your heart rate exceed 220 minus your resting heart rate. Perform each rep of each exercise slowly and with perfect technique. Count three seconds up and three seconds down.

Any type of aerobic exercise can be used for this routine. Some examples are: jumping jacks, jogging in place or stair climbing.

Circuit 1

Body Part	Exercise	Reps
Chest	Bench Press	8-12
Aerobic Exercise	30 – 60 Seconds	
Legs	Squat	8-12
Aerobic Exercise	30 – 60 Seconds	
Back	Seated Lat Rows	8-12
Aerobic Exercise	30 – 60 Seconds	
Trunk	Seated Abdominal Crunch	8-12
Aerobic Exercise	30 – 60 Seconds	

Circuit 2

Body Part	Exercise	Reps
Shoulders	Seated Shoulder Press	8-12
Aerobic Exercise	30 – 60 Seconds	
Legs	Leg Extension	8-12
Aerobic Exercise	30 – 60 Seconds	
Back	Seated Lat Pulldowns	8-12
Aerobic Exercise	30 – 60 Seconds	
Trunk	Standing Low Back Extension	8-12
Aerobic Exercise	30 – 60 Seconds	
Arms	Biceps Curl	8-12

The Workouts

Strength Training

Frequency: 3 Days Per Week (M-W-F) Time: About 45-60 Minutes

This program is designed to emphasize overall strength development. This is an advanced routine to be used only after you have progressed from the advanced general conditioning routine and only after you have perfected your exercise techniques. Work each set to near exhaustion. If you can perform more than 5 to 8 reps, you should increase your resistance 5 pounds and decrease your reps to 5. Rest 60 – 120 seconds between each set and exercise. Focus on proper form. Tighten the muscle before you move, squeeze the muscle as you move, cramp the muscle at the point of full contraction, and resist the movement as you lower the weight. Move slowly on each rep. Use a pace that would allow you to stop the movement instantly at any point in the rep. Count two seconds up and four seconds down and work to fatigue during each set.

Day 1

Body Part	Exercise	Sets	Reps
Chest	Bench Press	2-4	5-8
	Chest Fly	2-4	5-8
Shoulders	Seated Shoulder Press	2-4	5-8
	Crossover Rear Deltoid Rows	2-4	5-8
	Shoulder Shrug	2-4	5-8

Day 2

Body Part	Exercise	Sets	Reps
Back	Seated Lat Row	2-4	5-8
	Seated Lat Pulldowns	2-4	5-8
Arms	Biceps Curl	2-4	5-8
	Reverse Curl	2-4	5-8
	Triceps Pushdown	2-4	5-8
	Triceps Extension	2-4	5-8

Day 3

Body Part	Exercise	Sets	Reps
Legs	Squat	2-4	5-8
	Leg Extension	2-4	5-8
	Standing Low Back Extension	2-4	8-12
Trunk	Seated Abdominal Crunch	2-4	5-8

Chest Exercises

Bench Press – Shoulder Horizontal Adduction (and Elbow Extension)

Muscles worked:

Chest muscles (pectoralis major). Also involves front shoulder muscles (anterior deltoid and triceps, located on the back of the upper arm).

Position:

Seated – facing outward

Accessory:

Hand Grips

Pulleys:

Center Cross Bar – wide position

Before you begin:

Remove Leg Extension and adjust seat height. The pulleys should be in the wide position.

Key Points:

- Maintain a 90° angle between upper arms and torso throughout exercise.
- Limit range of motion so elbows do not travel behind shoulders.
- Keep shoulderblades pinched together and maintain good spinal alignment.



START

- Sit and grasp hand grips.
- Straighten arms to front.
- Be sure arms are directly in line with cables, palms facing down and wrists straight.
- Raise chest and pinch shoulderblades together. Maintain a very slight, comfortable, arch in lower back.



ACTION

- Slowly move elbows out, simultaneously bending arms, keeping forearms in line with cables.
- Stop when upper arms are straight out to the sides, level with shoulders.
- Slowly press forward, moving hands toward center. Return to start position with arms straight to front at shoulder width. Keep chest muscles tightened.

Chest Fly – Shoulder Horizontal Adduction (Elbow Stabilized)

Muscles worked:

Emphasizes chest muscles (pectoralis major). Involves front shoulder muscles (anterior deltoid).

Position:

Seated – facing outward

Accessory:

Hand Grips

Pulleys:

Center Cross Bar – wide position

Before you begin:

Remove Leg Extension and adjust seat height. The pulleys should be in the wide position.

Key Points:

- Maintain 90° angle between upper arms and torso throughout exercise.
- Limit range of motion so elbows do not travel behind shoulders.
- Keep shoulderblades pinched together and maintain good spinal alignment.



START

- Sit and grasp hand grips.
- Straighten arms to front.
- Be sure arms are directly in line with cables, palms facing in and wrists straight.
- Raise chest and pinch shoulderblades together. Maintain a slight, comfortable, arch in lower back.



ACTION

- Slowly move arms inward, maintaining the elbows in a slightly bent position throughout movement.
- Stop when upper arms are straight out in front, level with shoulders.
- Slowly return to start position. Keep chest muscles tightened during motion.

Chest Exercises

Decline Bench Press – Shoulder Horizontal Adduction (and Elbow Extension)

Muscles worked:

Chest muscles (pectoralis major). Also involves front shoulder muscles (anterior deltoid) and triceps.

Position:

Seated (seat in lowest position) facing outward

Accessory:

Hand Grips

Pulleys:

Center Cross Bar – standard position

Before You Begin:

Remove Leg Extension and adjust seat to lowest setting.

Key Points:

- Maintain 90° angle between upper arms and torso at the bottom of the motion, and slightly less than 90° at the top of the motion.
- Limit range of motion so elbows do not travel behind shoulders.
- Keep shoulderblades pinched together and maintain good spinal alignment.



START

START

- Sit and grasp hand grips with cable and grip positioned beneath forearm.
- Lower arms 5-6 inches from standard bench press position.
- Straighten arms to front.
- Be sure arms are directly in line with cables, palms facing down and wrists straight.
- Raise chest and pinch shoulderblades together. Keep a gentle arch in lower back.



FINISH

ACTION

- Slowly move elbows outward, simultaneously bending arms, keeping forearms in line with cables at all times.
- Stop when upper arms are straight out to sides, 10° below shoulders.
- Slowly press forward, moving hands toward center. Return to start position, arms straight at shoulder width, hands just above knees in line with cables. Keep chest muscles tightened.

Incline Bench Press – Shoulder Horizontal Adduction (and Elbow Extension)

Muscles worked:

Chest muscles (pectoralis major), especially upper portion. Also involves front shoulder muscles (anterior deltoid) and triceps.

Position:

Seated – facing outward

Accessory:

Hand Grips

Pulleys:

Center Cross Bar – wide position

Before You Begin:

Remove Leg Extension and adjust seat height.

Key Points:

- Upper arms will be 90° from sides of torso at the bottom of movement and slightly more than 90° from the front of torso at the top.
- Limit range of motion so elbows do not travel behind shoulders.
- Keep shoulderblades pinched together and maintain good spinal alignment.



START

START

- Sit and grasp hand grips.
- Straighten arms to front.
- Raise arms 6-8 inches above regular bench press position.
- Keep arms in line with cables, palms down, wrists straight.
- Raise chest and pinch shoulderblades together. Keep a slight, comfortable, arch in lower back.



FINISH

ACTION

- Slowly move elbows out, simultaneously bending arms. Keep forearms in line with cables.
- Stop when upper arms are out to sides, 10° above shoulders.
- Slowly press forward, moving hands toward center. Return to start position, with arms straight to front at shoulder width and in line with cables.

Chest Exercises

Decline Chest Fly—Shoulder Horizontal Adduction (elbow stabilized)

Muscles worked:

Pectoralis Major; Anterior Deltoid

Position:

Seated—facing outward

Accessory:

Hand Grips

Pulleys:

Center Cross Bar—Wide Position

Leg Extension:

Removed



START



FINISH



START

- Grasp Hand Grips in both hands.
- Open your arms into a wide, “embrace” position, elbows slightly bent. Press your forearms downward. At full extension, hands should be level with your hips, palms facing forward.
- Do not lock your elbows.
- Raise chest, pinch shoulderblades together, and maintain a slight, comfortable arch in your lower back.

ACTION

- Slowly press your arms forward and downward, straightening arms and moving your hands together. Hands should be 5-6” lower than standard Chest Fly Finish position.
- Rotate your wrists and forearms upward.
- Return to start position, slowly bringing your arms in front of you, just below chest level.

Success Tips

- Maintain a 60-90° angle between upper arms and torso during exercise.
- Keep chest muscles tightened. Limit and control your range of motion.
- Keep knees bent, feet on Platform, head back against Seat Back Pad.
- To improve your pectoralis involvement, pinch your shoulderblades together throughout movement.

Incline Chest Fly—Shoulder Horizontal Adduction (elbow stabilized)

Muscles worked:

Pectoralis Major; Anterior Deltoid

Position:

Seated—facing outward

Accessory:

Hand Grips

Pulleys:

Center Cross Bar—Wide Pulleys

Leg Extension:

Removed



START



FINISH



START

- Grasp Hand Grips in both hands.
- Press your arms forward and upward, straightening arms and moving your hands together. Hands should be 5-6” higher than the standard Chest Fly start position..
- Do not lock your elbows.
- Raise chest, pinch shoulderblades together, and maintain a slight, comfortable arch in your lower back.

ACTION

- Open your arms into a wide, “embrace” position, elbows slightly bent. Press your forearms upward. At full extension, your elbows should be level with your ears, palms facing forward.
- Rotate your wrists and forearms upward.
- Return to Start position, slowly bringing your arms in front of you, just below chest level.

Success Tips

- Maintain a 60-90° angle between upper arms and torso during exercise.
- Keep chest muscles tightened. Limit and control your range of motion.
- Keep knees bent, feet on Platform, head back against Seat Back Pad.
- To improve your pectoralis involvement, pinch your shoulderblades together throughout movement.

Shoulder Exercises

Reverse Fly – Shoulder Horizontal Abduction (Elbows Stabilized)

Muscles worked:

Back portion of shoulder muscles (rear deltoids, rear portion of middle deltoids).

Position:

Standing – facing machine

Seat:

Removed

Accessory:

Hand Grips

Pulleys:

Center Cross Bar – narrow position

Before You Begin:

Remove Leg Extension. The pulleys should be in the narrow position.

Key Points:

- Maintain a 90° angle between upper arms and sides of torso throughout exercise.
- Keep shoulderblades pinched together and maintain good spinal alignment.



START

START

- Stand on platform.
- Grasp hand grips with palms facing floor, arms nearly straight.
- Stand up straight and bend over slightly from hips until arms are in front of body at a 90° angle to torso.
- Lift chest and pinch shoulderblades together.



FINISH

ACTION

- Maintaining the same slight bend in arms, move elbows out and back, keeping a 90° angle between upper arms and sides of torso.
- Move until elbows are slightly behind shoulders, then slowly reverse the motion, keeping rear shoulder muscles tightened.

Crossover Reverse Fly – Shoulder Horizontal Abduction (Elbows Stabilized)

Muscles worked:

Back portion of shoulder muscles (rear deltoids, rear portion of middle deltoids).

Position:

Standing – facing machine

Accessory:

Hand Grips

Pulleys:

Center Cross Bar – narrow position

Before You Begin:

- Remove seat and leg extension. The pulleys should be in the narrow position.

Key Points:

- Maintain 90° angle between upper arms and sides of torso throughout exercise.
- Keep shoulderblades pinched together and maintain good spinal alignment.



START

START

- Stand on platform.
- Cross arms in front of body and grasp hand grips (right grip in left hand and vice versa) with palms facing floor and arms nearly straight.
- Stand up straight and bend over slightly from hips until arms are in front of body at a 90° angle to torso.
- Lift chest and pinch shoulderblades together.



FINISH

ACTION

- Maintaining same slight bend in arms, move elbows out and back, crossing cables as you pull arms back.
- Keep a 90° angle between upper arms and sides of torso.
- Move until elbows are slightly behind shoulders, then slowly reverse motion keeping rear shoulder muscles tightened.

Shoulder Exercises

Crossover Rear Deltoid Rows – Elbow Flexion

Muscles worked:

Back portion of shoulder muscles (rear deltoids, rear portion of middle deltoids).

Position:

Standing – facing machine

Accessory:

Hand Grips

Pulleys:

Center Cross Bar – narrow position

Before You Begin:

Remove Leg Extension and seat.
Center Cross Bar Pulleys should be in narrow position.

Key Points:

- Maintain a 90° angle between upper arms and sides of torso.
- Keep shoulderblades pinched together and maintain good spinal alignment.
- To work one arm at a time, place non-working hand on top of bench for additional stabilization.



START

START

- Stand on platform.
- Cross arms in front of body and grasp hand grips (right grip in left hand and vice versa) with palms facing down and arms nearly straight.
- Bend over slightly from hips (not spine) and raise arms in front of body, 90° to torso.
- Lift chest, stand up straight with spine in good alignment and tighten trunk muscles.



FINISH

ACTION

- Allowing arms to bend as you go, move elbows outward and backward keeping a 90° angle between upper arms and sides of torso.
- Always point forearms in the direction of cables.
- Move until elbows are slightly behind shoulders, then slowly reverse motion. Keep rear shoulder muscles tightened during entire motion.

Crossover High Rear Deltoid Rows – Elbow Flexion

Muscles worked:

Back portion of shoulder muscles (rear deltoids, rear portion of middle deltoids).

Position:

Standing – facing machine

Accessory:

Hand Grips

Pulleys:

Lat Tower

Before You Begin:

Remove Leg Extension and seat.

Key Points:

- Keep shoulderblades pinched together and maintain good spinal alignment.



START

START

- Stand on platform, with knees slightly bent.
- Cross arms and grab hand grips with palms facing down, arms straight (right hand on left hand grip and vice versa).
- Stand up straight and slightly lean back from hips.
- Lift chest and pinch shoulderblades together.



FINISH

ACTION

- Allowing arms to bend as you go, move elbows out and back keeping a 90° angle between upper arms and sides of torso.
- Always point forearms in direction of cables.
- Move until elbows are slightly behind shoulders, then slowly reverse motion. Keep rear shoulder muscles tightened.

Shoulder Exercises

Lateral Shoulder Raise – Shoulder Abduction (Elbows Stabilized)

Muscles worked:

Side shoulder muscles (middle deltoids), top muscle of rotator cuff (supraspinatus) and upper trapezius muscles.

Position:

Standing – facing outward

Accessory:

Hand Grips

Pulleys:

Squat Pulley Frame – use squat straps

Before You Begin:

Remove Seat and Leg Extension

Key Points:

- DO NOT swing arms upward or move trunk.

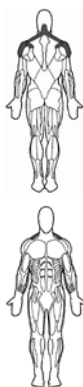

START



FINISH

START

- Stand on platform facing outward. Grasp hand grips with palms facing each other.
- Attain good spinal posture and bend forward slightly at hip (15 to 20°) by keeping spine straight and sticking rear end out. Do not bend at waist.
- Let arms hang directly in line with cables.
- Elevate shoulders slightly toward back of head.

ACTION

- Raise arms out to sides to nearly shoulder level.
- Keep side of arm/elbow facing out/up throughout movement.
- Slowly bring arms into start position without relaxing.

Seated Forearm Lateral Shoulder Raise – Elbows Stabilized

Muscles worked:

Side shoulder muscles (middle deltoids), top muscle of rotator cuff (supraspinatus) and upper trapezius muscles.

Position:

Seated – facing outward

Accessory:

Hand Grips over elbows

Pulleys:

Squat Pulley Frame – narrow position

Before You Begin:

Remove Seat and Leg Extension

Key Points:

- DO NOT swing arms upward or move trunk.

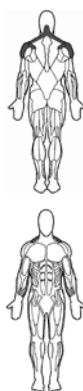

START



FINISH

START

- Slide hand grips over forearms until grip is cradled in elbow.
- Let upper arms hang in line with cables and bend elbows 90°.
- Elevate shoulders slightly toward the back of your head.
- Raise chest and pinch shoulder-blades together.
- Maintain a slight, comfortable, arch in lower back.

ACTION

- Raise arms out to sides to almost shoulder level.
- Keep side of forearms/elbows facing out/up throughout movement.
- Slowly bring arms to start position without relaxing.

Shoulder Exercises

Front Shoulder Raise – Shoulder Flexion (Elbow Stabilized)

Muscles worked:

Front part of shoulder muscles (front deltoids) and front part of middle deltoids.

Position:

Standing – facing outward

Accessory:

Hand Grips

Pulleys:

Squat Pulley Frame

Before You Begin:

Remove Leg Extension and seat. Use platform pulleys.

Key Points:

- Keep chest lifted and abdominals tightened throughout entire motion and maintain good spinal alignment.
- Do not increase arch in lower back while lifting arms.



START

START

- Stand on platform facing outward with knees slightly bent. You may want to lean back against bench.
- Keep chest up, abs tight and maintain a slight arch in lower back.
- Grasp hand grips with palms facing machine and arms straight at sides.



FINISH

ACTION

- Arms may be moved alternately or together.
- Keeping arms straight, move them forward, then up to shoulder height.
- Slowly return arms beside torso and repeat.

Seated Shoulder Press – Shoulder Adduction (and Elbow Extension)

Muscles worked:

Front portion of shoulder muscles (front deltoids and front part of middle deltoids), upper back muscles (upper trapezius), and triceps.

Position:

Seated – facing outward

Accessory:

Hand Grips

Pulleys:

Center Cross Bar – wide position

Before You Begin:

Remove Leg Extension and adjust seat height.

Key Points:

- Keep abdominals tight throughout entire motion and maintain good spinal alignment.
- Do not let the arch increase in the lower back while pressing up.



START

START

- Sit facing outward, knees bent and feet flat on floor.
- Keep chest up, abs tight and maintain a slight arch in lower back.
- Grasp hand grips with palms facing away from machine.
- Raise hand grips to just above shoulder level, keeping palms facing forward.



FINISH

ACTION

- Straighten arms overhead, focusing on moving elbows up and in toward head.
- Slowly return to starting position keeping tension in front shoulder muscles.

Shoulder Exercises

Shoulder Rotator Cuff – Internal Rotation

Muscles worked:

Front rotator cuff muscle (subscapularis).

Position:

Standing – facing left or right

Accessory:

Hand Grips

Pulleys:

Center Cross Bar -wide position

Before You Begin:

Remove Seat and Leg Extension

Key Points:

- Motion should be slow and controlled.
- Do not rotate spine to get additional range of motion. Try for pure rotation of shoulder joint. More is not better!
- Use light resistance only. Pick a resistance that you can perform 12-15 perfect reps.



START

- Stand on platform with one side toward machine. Maintain good spinal alignment.
- Grasp hand grip with arm closest to machine and draw upper arm into side, keeping elbow bent 90°.
- Distance yourself from tower to eliminate slack in cable.
- Use very light resistance.



ACTION

- Rotate forearm toward abdomen, keeping elbow by side.
- Slowly return to start position.

Shoulder Rotator Cuff – External Rotation

Muscles worked:

Rear portion of rotator cuff (infraspinatus, teres minor muscles).

Position:

Standing – facing left or right

Accessory:

Hand Grips

Pulleys:

Center Cross Bar – wide position

Before You Begin:

Remove Leg Extension and seat.

Key Points:

- Motion should be slow and controlled.
- Do not rotate spine to get additional range of motion. Try for pure external rotation of shoulder joint. More is not better!
- Use light resistance only. Pick a resistance that allows you to perform 12-15 reps.



START

- Stand on platform with one side toward machine. Maintain good spinal alignment.
- Using arm furthest from rods, reach across body, grasp hand grip nearest you and draw arm back into side. Keep elbow bent 90°.
- Allow forearm to rest against abdomen and elbow against side, taking out some of the slack or in cables.



ACTION

- Rotate forearm away from abdomen and out to side, keeping elbow/upper arm by side.
- Slowly return to start position.

Shoulder Exercises

Shoulder Extension – Elbows Stabilized

Muscles worked:

Upper back (latissimus dorsi, teres major, rear deltoid muscles), muscles between shoulderblades (middle trapezius, rhomboid muscles) and triceps.



Position:

Standing – facing machine

Accessory:

Hand Grips

Pulleys:

Center Cross Bar – narrow position

Before You Begin:

Remove Leg Extension and seat.

Key Points:

- Do not lose spinal alignment, keep chest lifted.
- Keep lats tightened throughout entire motion.
- Release shoulderblades at end of each rep. Initiate new rep by retracting shoulderblades.



START

START

- Stand on platform, facing machine, knees slightly bent, feet flat on floor.
- Grasp hand grips with palms facing floor.
- Tighten trunk muscles to stabilize spine while maintaining a slight arch in lower back.



FINISH

ACTION

- Initiate by pinching shoulderblades together.
- Continue movement by moving hands in an arc, down and back toward hips.
- Slowly return to start position.

Shoulder Shrug – Scapular Elevation

Muscles worked:

Upper trapezius and associated smaller muscles of region.



Position:

Standing – facing machine

Accessory:

Hand Grips

Pulleys:

Squat Pulley Frame

Before You Begin:

Remove Leg Extension and seat.

Key Points:

- Do not bend neck backward or forward while raising shoulders.
- Do not slouch upon lowering shoulders.
- Keep spine in good alignment through entire motion.
- Make sure both shoulders raise evenly.
- For variation, bend forward slightly from hips, not spine.



START

START

- Stand on platform facing machine.
- Reach down and grasp hand grips with palms facing away.
- Let arms hang, extending toward pulleys.



FINISH

ACTION

- Raise shoulders toward back of head, making sure neck/head does not move.
- Slowly reverse motion, keeping upper trapezius muscles tight.

Shoulder Exercises

Scapular Protraction – Elbows Stabilized

Muscles worked:

Serratus anterior muscles, the muscles on the side of the rib cage.

Position:

Seated – facing outward

Accessory:

Hand Grips

Pulleys:

Center Cross Bar – narrow position

Before You Begin:

Remove Leg Extension and adjust seat height.

Key Points:

- Maintain a 90° angle between upper arms and torso throughout the exercise.
- Keep elbows straight.
- Do not slouch forward in the upper spine to further the motion. Maintain a very slight arch in lower back at all times.



START

- Sit grasp hand grips.
- Lie head back on bench and straighten arms to front.
- Be sure arms are in line with cables, palms facing down and wrists straight.
- Raise chest and pinch shoulderblades. Maintain a slight, comfortable, arch in lower back.

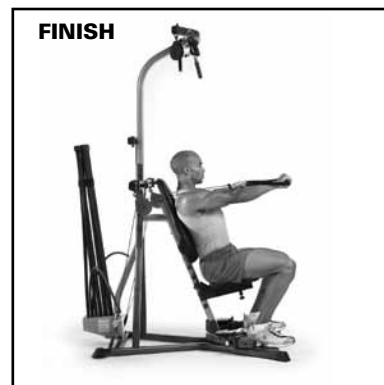

ACTION

- Keeping arms straight and pointing in the same direction of cables, slowly move shoulderblades forward off bench.
- Slowly return to start position.
- Movement is subtle and only occurs in shoulder.

Scapular Depression

Muscles worked:

Develops lower trapezius muscles, which stabilize and move shoulderblades.

Position:

Seated – facing outward

Accessory:

50" Bent Lat Bar

Pulleys:

Lat Tower

Before You Begin:

Remove Leg Extension and adjust seat height.

Key Points:

- Do not lose spinal alignment, keep chest lifted.



START

- Sit facing outward, knees bent, feet flat on floor.
- Grasp 50" Bent Lat Bar.
- Tighten trunk muscles to stabilize spine while maintaining a slight arch in lower back.



ACTION

- Keeping arms straight, slide shoulderblades toward hips.
- When shoulderblades are fully depressed, slowly return to start position.
- Movement is subtle and only occurs in shoulder.

Shoulder Exercises

Crossover Seated Rear Delt Rows—Elbow Flexion

Muscles worked:

Anterior and Middle Deltoids

Position:

Seated on the floor—facing machine

Accessory:

Hand Grips

Pulleys:

Squat Pulley Frame

Leg Extension:

Removed

Success Tips

- Maintain a 90° angle between your upper arms and torso during motion.
- Keep knees bent and feet braced against the Standing Platform.
- Do not bend your torso forward.
- Keep shoulderblades pinched together and maintain good spinal alignment.



START



FINISH



START

- Cross your arms in front of you and grasp the Hand Grips (right Grip in left hand and vice versa), palms facing toward the floor.
- Brace your heels against the end of the Standing Platform.
- Lean back slightly and straighten your arms.
- Raise your arms until they are in front of your body at approximately a 90° angle to your torso.

ACTION

- Allowing your arms to bend as you go, move your elbows outward and backward until elbows are parallel with your shoulders.
- Keep your forearms pointing in the direction of the cables.
- Slowly return to the start position. Do not relax the tension in your shoulder muscles.

Scapular Retraction

Muscles worked:

Develops muscles between shoulderblades (trapezius and rhomboids).

Position:

Seated on floor, facing machine

Accessory:

Hand Grips

Pulleys:

Squat Pulley Frame

Before You Begin:

Remove Leg Extension and Seat

Key Points:

- Do not bend torso forward.
- Do not lose spinal alignment, keep chest lifted.
- Do not pull with arm muscles.



START



FINISH



START

- Sit on floor facing machine.
- Grab hand grips with palms facing each other.
- Place heels against end of platform, bend hips and knees, arms straight.
- Lift chest, sit up straight with spine in good alignment and tighten trunk muscles.

ACTION

- Keeping arms straight, slowly pinch shoulderblades together.
- When shoulderblades are fully retracted, slowly return to start position.

Back Exercises

Good Morning

Muscles worked:

Latissimus Dorsi; Teres Major;
Rear Deltoids

Position:

Standing—facing outward

Accessory:

Squat Bar

Pulleys:

Squat Pulley Frame

Leg Extension:

Removed

Success Tips

- Keep your chest lifted, spine aligned, abs tight and your back flat with no arch.
- Lift with your legs, not lower back or arms.
- Use a light resistance for this movement.
- Lift your head, keep your knees bent and feet on Standing Platform.



START



START

- Grasp the Squat Bar with your palms facing downward.
- Keep your legs bent slightly.
- Bend over, approximately 90° from your hips (not your waist)

FINISH



ACTION

- Initiate the movement by pushing your hips forward.
- Slowly move your trunk until you are in the standing position. Back should be tightened when reaching upright position
- Slowly return to the start position without relaxing tension in your legs.

Standing Low Back Extension – with Hip Extension

Muscles worked:

Muscles in lower back (erector spinae, deep spinal muscles), lower back muscles, gluteus maximus and hamstrings.

Position:

Standing – facing outward

Accessory:

Hand Grips

Pulleys:

Squat Pulley Frame – standard position

Before You Begin:

Remove Seat and Leg Extension

Key Points:

- Keep chest lifted and a very slight arch in lower back at all times.
- Move from hips only, not waist. Do not increase or decrease the arch in lower back during the movement.



START

- Stand facing out.
- Slide hand grips up over forearms to elbows.
- Bend knees comfortably, cross arms in front of chest and pull hand grips tightly to chest.
- Lift chest, tighten trunk muscles and arch lower back slightly. Pinch shoulderblades together slightly.
- Lean forward from hips, slightly letting out tension in the cables.



ACTION

- Keep chest lifted, move entire torso up as a unit by pivoting at hips.
- Slowly return to start position without slouching or changing spinal alignment.

Back Exercises

Standing Shoulder Pullover – with Bent Lat Bar (Elbows Stabilized)

Muscles worked:

Upper back (latissimus dorsi, teres major, rear deltoid muscles). Also involves chest (pectoralis major muscles) and triceps.

Position:

Standing – facing machine

Accessory:

50" Bent Lat Bar

Pulleys:

Lat Tower

Before You Begin:

Remove Seat and Leg Extension

Key Points:

- Do not lose spinal alignment. Relax neck, keep chest lifted, abs tight and maintain a very slight arch in lower back.
- Keep lats tightened throughout entire motion.
- Release shoulderblades at end of each rep. Initiate new rep by depressing shoulderblades.

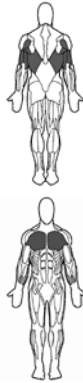

START

- Stand on platform.
- Keep knees slightly bent and feet flat on platform.
- Extend arms overhead and grasp 50" Bent Lat Bar, palms facing down.
- Tighten abs to stabilize spine while maintaining a slight arch in lower back.



ACTION

- Move hands in an arc down toward legs.
- End with arms by sides, pressing shoulderblades down, completely tightening lats.
- Control the return to start position by slowly moving arms overhead and releasing shoulderblades.

Standing Shoulder Pullover – with Hand Grips (Elbows Stabilized)

Muscles worked:

Upper back (latissimus dorsi, teres major, rear deltoid muscles). Also involves chest (pectoralis major muscles) and triceps.

Position:

Standing – facing machine

Accessory:

Hand Grips

Pulleys:

Lat Tower

Before You Begin:

Remove Seat and Leg Extension:

Key Points:

- Do not lose spinal alignment. Relax neck, keep chest lifted, abs tight and maintain a very slight arch in lower back.
- Keep lats tightened throughout entire motion.
- Release shoulderblades at end of each rep. Initiate new rep by depressing shoulderblades.

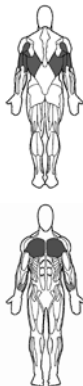

START

- Stand on platform.
- Keep knees slightly bent and feet flat on platform.
- Extend arms overhead and grasp Hand Grips, palms facing down.
- Tighten abs to stabilize spine while maintaining a slight arch in lower back.



ACTION

- Move hands in an arc down toward legs.
- End with arms by sides, pressing shoulderblades down, completely tightening lats.
- Control the return to start position by slowly moving arms overhead and releasing shoulderblades.

Back Exercises

Narrow Pulldowns with Bent Lat Bar – Shoulder Extension (with Elbow Flexion)

Muscles worked:

Latissimus dorsi, teres major and rear deltoid, which make up the large pulling muscles of upper back. Also involves biceps group.

Position:

Seated – facing machine

Accessory:

50" Bent Lat Bar

Pulleys:

Lat Tower

Before You Begin:

Remove Leg Extension

Key Points:

- Do not lose spinal alignment.
- Keep lats tightened throughout entire motion.

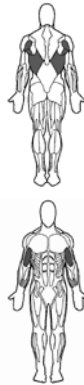

START



FINISH



START

- Grasp 50" Bent Lat Bar, palms facing down, and sit facing machine.
- Position thighs under pulleys. Sit upright with arms extending up. You may position hips under pulleys, but you must lean back slightly from the hips.
- Maintain good spinal alignment, chest lifted, abs tight and slight arch in lower back.

ACTION

- Pull shoulderblades down and together while drawing elbows down to front, and then in, toward sides of body.
- At end of motion, arms should be near (not touching) sides, shoulderblades fully depressed toward hips, and forearms in line with cables (not forward).
- Slowly return to start position. Allow arms and shoulderblades to move up, w/o relaxing muscles.

Narrow Pulldowns with Hand Grips – Shoulder Extension (with Elbow Flexion)

Muscles worked:

Latissimus dorsi, teres major and rear deltoid, which make up the large pulling muscles of upper back. Also involves biceps group.

Position:

Seated – facing machine

Accessory:

Hand Grips

Pulleys:

Lat Tower

Before You Begin:

Remove Leg Extension

Key Points:

- Do not lose spinal alignment.
- Keep lats tightened throughout entire motion.

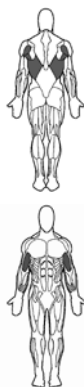

START



FINISH



START

- Grasp Hand Grips, palms facing each other, and sit facing machine.
- Position thighs under pulleys and sit upright with arms extending up. You may position hips under pulleys but you must lean back slightly from the hips.
- Maintain good spinal alignment, chest lifted, abs tight and a slight arch in lower back.

ACTION

- Pull shoulderblades down and together while drawing elbows down and then in, toward sides of body.
- At end of motion, arms should be near (not touching) sides, shoulderblades fully depressed toward hips and forearms in line with cables (not forward).
- Slowly return to start position. Allow arms and shoulderblades to move up fully, without relaxing muscles.

Back Exercises

Bent Over Row

Muscles worked:

Latissimus dorsi, teres major and rear deltoid, which make up the large pulling muscles of upper back. Also involves biceps group.

Position:

Standing – facing machine

Accessory:

Hand Grips

Pulleys:

Squat Pulley Frame

Before You Begin:

Remove Seat and Leg Extension

Key Points:

- Do not bend neck backward or forward while raising bar.
- Do not slouch when lowering hand grips.
- Keep spine in good alignment through entire motion.

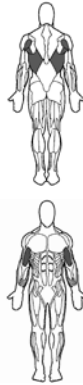

START

- Stand on platform. Reach down and grasp hand grips, palms facing each other.
- Let arms extend in direction of pulleys.
- Keep back flat and knees bent.



ACTION

- Move elbows back as you bring hand grips to a point below chest.
- Slowly reverse motion. Keep knees bent and back flat.

Crossover Bent Over Row

Muscles worked:

Back portion of shoulder muscles (rear deltoids, rear part of middle deltoids).

Position:

Standing – facing machine

Accessory:

Hand Grips

Pulleys:

Squat Pulley Frame

Before You Begin:

Remove Seat and Leg Extension

Key Points:

- Do not bend neck backward or forward while raising bar.
- Do not slouch when lowering hand grips.
- Keep spine in good alignment through entire motion.



START

- Stand on platform.
- Cross arms and reach down and grasp hand grips, palms facing back (left grip in right hand and vice versa).
- Let arms extend in direction of pulleys.
- Keep back flat and knees bent.



ACTION

- Move elbows back as you bring hand grips to a point below chest.
- Slowly reverse motion. Keep knees bent and back flat.

Back Exercises

Seated Lat Rows – Shoulder Extension (and Elbow Flexion)

Muscles worked:

Latissimus dorsi, teres major and rear deltoid muscles, which make up the large pulling muscles of upper back. Also involves biceps.

Position:

Seated on ground, facing machine

Accessory:

Hand Grips

Pulleys:

Squat Pulley Frame

Before You Begin:

Remove Leg Extension and Seat

Key Points:

- Do not bend torso forward at any point.
- Do not lose spinal alignment – keep chest lifted.
- Release shoulderblades at end of each rep and initiate new rep by pinching shoulderblades.



START

- Grab hand grips with palms facing each other.
- Place heels against end of platform, bend knees comfortably.
- Sit up straight with spine in good alignment.



ACTION

- Pinch shoulderblades together.
- Pull upper arms down and back, brushing past sides of the body while keeping forearms pointing in direction of cable.
- Slowly return to start position.

Crossover Seated Lat Rows – Shoulder Extension (and Elbow Flexion)

Muscles worked:

Latissimus dorsi, teres major and rear deltoid muscles, which make up large pulling muscles of upper back. Also involves biceps.

Position:

Seated on the ground, facing machine

Accessory:

Hand Grips

Pulleys:

Squat Pulley Frame

Before You Begin:

Remove Leg Extension

Key Points:

- Do not bend torso forward at any point.
- Do not lose spinal alignment, keep chest lifted.
- Release shoulderblades at end of each rep. Initiate new rep by pinching shoulderblades.



START

- Cross arms and grasp hand grips (right grip in left hand and vice versa) with palms facing each other.
- Place heels against end of platform, bend knees comfortably.
- Sit up straight, spine in good alignment.



ACTION

- Pinch shoulderblades together.
- Pull upper arms down and back, brushing past sides of body while keeping forearms pointing in direction of cable.
- Slowly return to start position.

Back Exercises

Reverse Grip Pulldown with Lat Bar

Muscles worked:

Latissimus Dorsi; Teres Major;
Rear Deltoids; Biceps

Position:

Seated—facing machine

Accessory:

Lat Pulldown Bar

Pulleys:

Lat Cross Bar

Leg Extension:

Removed

Success Tips

- Lift your chest, keep your knees bent and feet on Standing Platform.
- Do not bend your neck forwards or backwards during motion.
- Keep your spine aligned, abs tight and a slight arch in your lower back. Do not slouch.

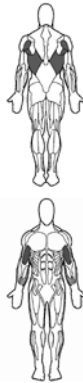

START



FINISH

START

- Grasp the Lat Pulldown Bar, keeping your hands at shoulder width with an underhand grip, and then sit, with your arms extending upward, muscles relaxed and ready.
- You may position your thighs directly beneath the pulleys, but lean back slightly from hips.

ACTION

- Initiate the movement by pulling your shoulderblades downward and together, drawing your elbows down toward your hips and then inward into your trunk.
- The Lat Pulldown Bar may not touch your chest.
- Forearms should stay in line with the direction of the cables.
- Slowly return to the start position, without relaxing the tension in your shoulders.

Reverse Grip Pulldowns – Lat Tower – Shoulder Extension (with Elbow Flexion)

Muscles worked:

Latissimus dorsi, teres major and rear deltoid.
Also involves biceps group.

Position:

Seated – facing machine

Accessory:

Hand Grips

Pulleys:

Lat Tower

Before You Begin:

Remove Leg Extension

Key Points:

- Do not lose spinal alignment.
- Keep lats tightened throughout entire motion.

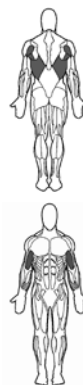

START



FINISH

START

- Grasp hand grips with an underhand grip, at a comfortable width, then sit on seat.
- Position thighs under pulleys and sit upright with arms extending up. You may position hips under pulleys but you must lean back slightly from the hips (not the waist).
- Maintain good spinal alignment, chest lifted, abs tight, and a slight arch in lower back.

ACTION

- Pull shoulderblades down and together while drawing elbows down to sides, then in, toward body.
- At end of motion, arms should be drawn near sides (although may not be touching sides), shoulderblades fully depressed towards hips and forearms in line with direction of cables.
- Slowly return to start position allowing arms and shoulderblades to move up, without relaxing muscles.

Back Exercises

Crossover Wide Pulldowns – Shoulder Extension (with Elbow Flexion)

Muscles worked:

Latissimus dorsi, teres major and rear deltoid. Also involves pectoralis major and triceps.

Position:

Seated – facing machine

Accessory:

Hand Grips

Pulleys:

Lat Tower

Before You Begin:

Remove Leg Extension

Key Points:

- Do not lose spinal alignment.
- Keep lats tightened throughout entire motion.
- Do not lean backward as you pull.

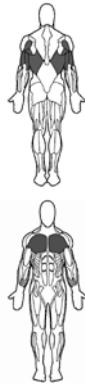

START



FINISH

START

- Cross arms, then grasp hand grips with palms facing forward (right grip in left hand and vice versa). Sit on seat.
- Position thighs under pulleys and sit up with arms extending upward. You may position hips under pulleys but you must lean back from hips (not waist).
- Maintain good spinal alignment, chest up, abs tight and a slight arch in lower back.

ACTION

- Pull shoulderblades down and together while drawing elbows out, away from sides.
- At end of motion, arms should be drawn away from sides, shoulderblades fully depressed toward hips, and forearms in line with direction of cables.
- Slowly return to start position. Allow arms and shoulderblades to move fully up, without relaxing muscles.

Crossover Narrow Pulldowns – Shoulder Extension (with Elbow Flexion)

Muscles worked:

Latissimus dorsi, teres major and rear deltoid. Also involves biceps group.

Position:

Seated – facing machine

Accessory:

Hand Grips

Pulleys:

Lat Tower

Before You Begin:

Remove Leg Extension

Key Points:

- Do not lose spinal alignment.
- Keep lats tightened throughout entire motion.

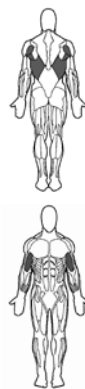

START



FINISH

START

- Cross arms, then grasp hand grips with palms facing each other (left grip in right hand and vice versa). Sit on seat.
- Position thighs under pulleys and sit up with arms extending upward. You may position hips under pulleys but you must lean back from hips (not waist).
- Maintain good spinal alignment, chest lifted, abs tight and a slight arch in lower back.

ACTION

- Pull shoulderblades down and together while drawing elbows down to sides, and then in, toward body.
- At end of motion, arms should be drawn near sides (although not touching sides), shoulderblades fully depressed toward hips and forearms up, in line with cables.
- Slowly return to start position allowing arms and shoulderblades to move fully up, without relaxing muscles.

Back Exercises

Pulldowns—Shoulder Adduction (with elbow flexion)

Muscles worked:

Latissimus Dorsi; Teres Major;
Rear Deltoids; Biceps

Position:

Seated—facing machine

Accessory:

Lat Pulldown Bar

Pulleys:

Lat Cross Bar

Leg Extension:

Removed

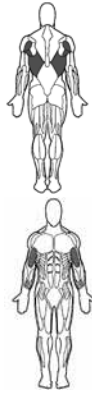

START



FINISH



START

- Grasp the Lat Pulldown Bar with an overhanded grip (palms facing the floor), at the grip width determined by following the directions in the Success Tips.
- Keep your arms extended and muscles relaxed and ready.

ACTION

- Initiate movement by pulling shoulderblades together while simultaneously drawing elbows down and inward.
- The Lat Pulldown Bar may not touch your chest. At the end of the motion, arms should be near your sides, shoulderblades fully depressed.
- Keep forearms in line with the Cables.
- Slowly return to start position.

Success Tips

- Lift your chest, keep your knees bent and feet on Standing Platform.
- To determine the appropriate grip width for you, hold your arms straight out to your sides at shoulder height. Bend your elbows approximately 90°. Hands should be no wider apart than your elbows.
- Keep your spine aligned, abs tight and a slight arch in your lower back.

Stiff-Arm Pulldown—Shoulder Extension (elbow stabilized)

Muscles worked:

Latissimus Dorsi; Teres Major; Rear Deltoids; Lower Trapezius; Biceps

Position:

Standing—facing machine

Accessory:

Lat Pulldown Bar

Pulleys:

Lat Cross Bar

Leg Extension:

Removed

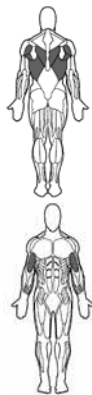

START



FINISH



START

- Grasp the Lat Pulldown Bar with your palms facing down.
- Step back slightly, making sure that there is enough movement in the cable to complete your full range of motion with this exercise.
- Bend slightly from hips, lift chest and tighten your abs to stabilize spine.

ACTION

- Initiate the movement by lowering your shoulder blades, bringing them down and together.
- Keep your arms straight, moving your hands downward in an arc and slowly in toward your thighs.
- Slowly return to the start position without relaxing muscle tension.

Success Tips

- Keep your lats tightened throughout the entire motion.
- Keep your chest lifted and maintain spinal alignment, keeping a very slight arch in your lower back.
- Release your shoulderblades at the end of each rep. Initiate each new rep by depressing your shoulderblades.
- Keep your elbows nearly straight (do not lock elbows) throughout exercise.

Back Exercises

Seated Lat Pulldowns – Shoulder Adduction (with Elbow Flexion)

Muscles worked:

Latissimus dorsi, teres major and rear deltoid. Also involves biceps group.

Position:

Seated – facing machine

Accessory:

Hand Grips

Pulleys:

Lat Tower

Before You Begin:

Remove Leg Extension

Key Points:

- Maintain good spinal alignment, chest lifted, abs tight and a slight arch in lower back.
- Keep lats tightened throughout entire motion.
- Do not let grips touch chest.

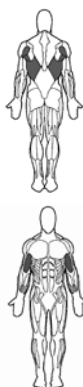

START

START

- Hold arms out to sides at shoulder height. Bend elbows 90°, hands slightly less than elbow width.
- Grasp hand grips at same width as above, then sit down with arms extending upward.
- You may position hips under pulleys but only lean back slightly from hips (not the waist).



FINISH

ACTION

- Pull shoulderblades down and together while drawing elbows down to sides, then in, toward trunk.
- At end of motion, arms should be drawn near sides (not touching sides), shoulderblades fully depressed toward hips and forearms up in line with cables.
- Slowly return to start position. Allow arms and shoulderblades to move up, w/o relaxing muscles.

Seated Wide Lat Pulldowns – Shoulder Adduction (with Elbow Flexion)

Muscles worked:

Latissimus dorsi, teres major and rear deltoid. Also involves biceps group.

Position:

Seated – facing machine

Accessory:

50" Bent Lat Bar

Pulleys:

Lat Tower

Before You Begin:

Remove Leg Extension

Key Points:

- Do not lose spinal alignment.
- Keep lats tightened throughout entire motion.
- If you can't complete the exercise with hands in the wide position, bring hands closer together.

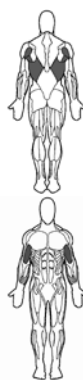

START

START

- Grasp 50" Bent Lat Bar at a comfortable, wide grip, then sit with arms extending up.
- You may position hips under pulleys but you must lean back slightly from hips (not the waist).
- Maintain good spinal alignment, chest lifted, abs tight and a slight arch in lower back.



FINISH

ACTION

- Pull shoulderblades down and together while drawing elbows down to sides, then in, toward trunk.
- 50" Bent Lat Bar may not touch chest, but, at end of motion, arms should be drawn near sides (not touching sides), shoulderblades fully depressed toward hips and forearms up in line with cables.
- Slowly return to start position, Allow arms and shoulderblades to move fully upward, without relaxing muscles.

Arm Exercises

Triceps Pushdown – Elbow Extension

Muscles worked:

Triceps

Position:

Standing – facing machine

Accessory:

Hand Grips

Pulleys:

Lat Tower

Before You Begin:

Remove Seat and Leg Extension

Key Points:

- Keep upper arms motionless.
- Keep wrists straight.
- Tighten triceps throughout exercise and control motion on the way up.
- Maintain good posture by keeping chest lifted and abs tight. Maintain a very slight arch in the lower back.



START

START

- Stand on platform.
- Grasp hand grips at shoulder width, palms down.
- Bring arms down to sides, elbows straight. This is Start Position.
- Bend over slightly from hips, so shoulders are directly over hands. Lift chest and tighten abs to stabilize spine. Maintain a slight arch in lower back.



FINISH

ACTION

- Keep upper arms stationary and elbows next to sides of torso. Slowly allow elbows to bend, moving hands in arcing motion away from legs and up.
- Stop at 90°.
- Think about tightening triceps. Slowly reverse arcing motion and straighten arms fully.

Triceps Hammer Pushdown – Elbow Extension

Muscles worked:

Triceps

Position:

Standing – facing machine

Accessory:

Hand Grips in “Hammer Grip”

Pulleys:

Lat Tower

Before You Begin:

Remove Seat and Leg Extension

Key Points:

- Keep upper arms motionless.
- Keep wrists straight.
- Tighten triceps throughout exercise and control motion on the way up.
- Maintain good posture by keeping chest lifted and abs tight. Maintain slight arch in lower back.



START

START

- Stand on platform.
- Grasp hand grips at shoulder width, with grips in vertical hammer position.
- Bring arms down to sides, elbows straight. This is Start Position.
- Bend over slightly from hips, so shoulders are directly over hands. Lift chest and tighten abs to stabilize spine. Maintain a slight arch in lower back.



FINISH

ACTION

- Keep upper arms stationary and elbows next to sides of torso. Slowly allow elbows to bend, moving hands in arcing motion away from legs and up.
- Stop at 90°.
- Think about tightening triceps. Slowly reverse arcing motion and straighten arms fully.

Arm Exercises

Triceps Pushdown – with Bent Lat Bar (Elbow Extension)

Muscles worked:

Triceps

Position:

Standing – facing machine

Accessory:

50" Bent Lat Bar

Pulleys:

Lat Tower

Before You Begin:

Remove Leg Extension and Seat

Key Points:

- Keep upper arms motionless.
- Keep wrists straight.
- Tighten triceps throughout exercise and control motion on the way up.
- Maintain good posture by keeping chest lifted, abs tight. Maintain a very slight arch in lower back.



START

START

- Stand on platform.
- Grasp 50" Bent Lat Bar at shoulder width, palms down.
- Bring arms down to sides, elbows straight. This is Start Position.
- Bend over from hips, so shoulders are over hands. Lift chest and tighten abs to stabilize spine while maintaining a slight arch in lower back.



FINISH

ACTION

- Keep upper arms stationary and elbows next to sides of torso. Slowly allow elbows to bend, moving hands in arcing motion away from legs and up.
- Stop at 90°.
- Think about tightening triceps. Slowly reverse arcing motion and straighten arms fully.

Single Arm Pushdown – Elbow Extension

Muscles worked:

Triceps

Position:

Standing—facing machine

Accessory:

Hand Grips

Pulleys:

Lat Cross Bars

Leg Extension:

Removed



START

START

- Keep your upper arms motionless and your wrists straight.
- Keep your chest lifted and maintain spinal alignment, keeping a very slight arch in your lower back.
- Tighten the triceps throughout the exercise, using controlled motion.
- Keep your knees bent and feet on Standing Platform.

- Grasp one Hand Grip, palm facing downward.
- Stand approximately 1-2 feet from Lat Tower (adjust for comfort), but keeping feet on Standing Platform.
- Bring your arm in front of you, Hand Grip at chest level.
- Bend over slightly from hips, so that your shoulder is directly over your hand.



FINISH

ACTION

- Keeping your upper arm stationary, elbow next to trunk, slowly push your arm downward in a gentle arc until your hand is near top of the thigh.
- Keeping your triceps tightened, slowly reverse the arcing motion, bringing the Hand Grip back to the start position.

Arm Exercises

Triceps Extension – Elbow Extension

Muscles worked:

Triceps

Position:

Seated – facing outward

Accessory:

Hand Grips

Pulleys:

Center Cross Bar – narrow position

Before You Begin:

Remove Leg Extension and adjust seat height.

Key Points:

- Keep upper arms/shoulders motionless.
- Keep wrists straight.
- Tighten triceps throughout exercise and control motion on the way down.



START

START

- Bend knees and place feet flat on floor.
- Reach behind and grasp one or both of the hand grips, palms facing away.
- Keep elbows above shoulders, directly in line with cables, palms facing out, wrists straight.
- Raise chest and pinch shoulder-blades together. Maintain a slight, comfortable, arch in lower back.



FINISH

ACTION

- Keep upper arm stationary. Slowly straighten elbows allowing hands to move in arcing motion above head.
- Slowly reverse arcing motion until elbows are bent again.

Cross Triceps Extension

Muscles worked:

Triceps

Position:

Seated – facing outward

Accessory:

Hand Grips in "Hammer Grip"

Pulleys:

Center Cross Bar – narrow position

Before You Begin:

Remove Leg Extension

Key Points:

- Keep upper arm motionless.
- Keep wrist straight.
- Tighten triceps throughout exercise and control motion on the way down.
- Keep knees bent and feet flat on floor.



START

START

- Reach over shoulder and grasp a hand grip. Using the Hammer Grip, bend elbow until hand is in front of chest, palm down.
- Lay head back against bench and straighten arm to front.
- With free hand, lightly grasp back of arm near elbow, to stabilize working arm.
- Raise chest and pinch shoulder-blades together. Maintain a slight arch in lower back.



FINISH

ACTION

- Keep upper arm stationary. Bend elbow, moving hand in arcing motion across chest.
- Stop motion when arm is straight, then slowly reverse arc motion until elbow is back in start position.

Arm Exercises

Hammer Triceps Extension – Elbow Extension

Muscles worked:

Triceps

Position:

Seated – facing outward

Accessory:

Hand Grips in “Hammer Grip”

Pulleys:

Center Cross Bar – narrow position

Before You Begin:

Remove Leg Extension and adjust seat height.

Key Points:

- Keep upper arms/shoulders motionless.
- Keep wrists straight.
- Tighten triceps throughout exercise and control the motion on the way down.



START



START

- Bend knees. Place feet flat on platform.
- Reach behind and grasp one or both of the hand grips in the vertical hammer grip position.
- Keep elbows above shoulders, directly in line with cables, palms facing down, wrists straight.
- Raise chest and pinch shoulderblades together. Maintain a slight, comfortable, arch in lower back.

FINISH



ACTION

- Keep upper arm stationary. Slowly straighten elbows, allowing hands to move in arching motion above head.
- Slowly reverse arching motion until elbows are bent again.

“Rope” Pushdown – Elbow Extension

Muscles worked:

Triceps

Position:

Standing—facing machine

Accessory:

Hand Grips in “Hammer Grip”

Pulleys:

Lat Cross Bar

Leg Extension:

Removed

Success Tips

- Keep your knees bent and feet on Standing Platform.
- Keep your upper arms motionless and your wrists straight.
- Keep your chest lifted, abs tight and maintain a slight arch in lower back.
- Tighten the triceps throughout the exercise, using controlled motion.



START



START

- Distance yourself from the Lat Tower, but keep your feet on the Standing Platform.
- Cross your arms and grasp the Hand Grips (right Grip in left hand and vice versa), using the hammer grip position.
- Bring hands toward each other, in front of you, until they are positioned as if grabbing a rope.
- Keep your elbows bent, upper arms at your sides.

FINISH



ACTION

- Keeping your upper arms stationary, elbows next to trunk, slowly straighten your arms downward, in a gentle arc, until hands are near tops of your thighs, hands and elbows straightened and directly in line with shoulders.
- Keeping your triceps tightened, slowly reverse the arching motion and bring the Hand Grips back to the start position.

Arm Exercises

Triceps Kickback

Muscles worked:

Triceps

Position:

Standing – facing machine

Accessory:

Hand Grips

Pulleys:

Center Cross Bar – narrow position

Before You Begin:

Remove Seat and Leg Extension

Key Points:

- Maintain spinal alignment.
- Keep arm at side and wrist straight throughout entire motion.
- Tighten triceps throughout exercise and control motion.
- Keep palms facing upward.



START



START

- Stand on platform.
- Keep chest lifted and maintain a slight arch in lower back.
- Support yourself with one arm on the horizontal bar and grasp a hand grip with free hand, palm facing backward.
- Draw elbow back so upper arm is beside body, elbow bent approximately 90°.

FINISH



ACTION

- Straighten elbow while keeping upper arm completely still.
- When arm is straight, slowly return to start position.

Hammer Triceps Kickback

Muscles worked:

Triceps

Position:

Standing – facing machine

Accessory:

Hand Grips in “Hammer Grip”

Pulleys:

Center Cross Bar – narrow position

Before You Begin:

Remove Seat and Leg Extension

Key Points:

- Maintain spinal alignment.
- Keep arm at side and wrist straight throughout motion.
- Tighten triceps throughout exercise and control motion.
- Maintain Hammer Grip throughout exercise.



START



START

- Stand on platform.
- Keep chest lifted and maintain a slight arch in lower back.
- Support yourself with one arm on horizontal bar and grasp a hand grip in the vertical hammer grip position with free hand, palm facing in.
- Draw elbow back so upper arm is beside body and elbow bent approximately 90°.

FINISH



ACTION

- Straighten elbow while keeping upper arm completely still.
- When arm is straight, slowly return to start position.

Arm Exercises

Resisted Dip – Elbow Extension

Muscles worked:

Triceps

Position:

Standing – facing outward

Accessory:

Hand Grips

Pulleys:

Lat Tower

Before You Begin:

Remove Seat and Leg Extension

Key Points:

- Keep back straight and knees slightly bent.
- Keep the abdominals tight throughout the entire motion and maintain good spinal alignment.



START

- Stand on the platform facing away from machine. Reach back and grab hand grips with thumbs on inside toward body.
- Cable should be between arm and body.
- Upper arms should be at a 90° angle from torso.



ACTION

- Straighten arms down, focusing on moving elbows down and inward toward hips.
- Slowly return to start position keeping tension in back shoulder muscles.

Biceps Curl – Elbow Flexion (in Supination)

Muscles worked:

Biceps

Position:

Standing – facing machine

Accessory:

Hand Grips

Pulleys:

Squat Pulley Frame

Before You Begin:

Remove Seat and Leg Extension

Key Points:

- Keep elbows at sides.
- Keep wrists straight.
- Keep trunk muscles tight and maintain a very slight arch in lower back.



START

- Stand on platform.
- Bend down and grasp hand grips with palms forward.
- Stand with upper arms by sides. Lift chest, tighten abs and maintain a slight arch in lower back.



ACTION

- Curl hand grips forward, then up, and then in toward shoulders while keeping elbows at sides and upper arms completely still.
- Slowly lower to start position by performing the same arcing motion.

Arm Exercises

Standing Biceps Curl—Elbow Flexion (in supination)

Muscles worked:

Biceps

Position:

Standing—facing outward

Accessory:

Hand Grips

Pulleys:

Squat Pulley Frame

Leg Extension:

Removed

Success Tips

- Keep your knees bent and feet on Standing Platform.
- Keep your chest lifted, abs tight and a very slight arch in your lower back.
- Keep your elbows at your sides and your wrists straight.



START

START

- Reach down and grasp the Hand Grips, palms facing forward.
- Straighten, keeping your arms by your sides, elbows loose.



FINISH

ACTION

- Keeping your upper arms stationary and your elbows at your sides, slowly curl the Hand Grips forward, then upward and in towards your shoulders.
- Slowly reverse the arcing motion bringing your hands back to the start position.

Hammer Biceps Curl—Elbow Flexion (in supination)

Muscles worked:

Biceps; Brachialis; Brachioradialis

Position:

Standing—facing outward

Accessory:

Hand Grips in "Hammer" Hold (see Page 10)

Pulleys:

Squat Pulley Frame

Leg Extension:

Removed

Success Tips

- Keep your knees bent and feet on the Standing Platform
- Keep your chest lifted, shoulders pinched together, and a very slight arch in your lower back.
- Keep your upper arms and shoulders motionless and your wrists straight.

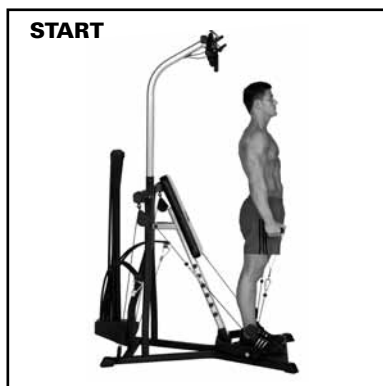

START

START

- Reach down and grasp the Hand Grips using the Hammer hold. Press your upper arms into your sides and bend your elbows until they are at 90° angles.
- Straighten your spine, keeping your upper arms by your sides, elbows loose.



FINISH

ACTION

- Keeping your upper arms stationary and your elbows at your sides, slowly curl the Hand Grips forward, then upward and in towards your shoulders.
- Slowly reverse the arcing motion bringing your hands back to the start position.

Arm Exercises

Concentration Biceps Curl – Elbow Flexion (in Supination)

Muscles worked:

Biceps

Position:

Standing – right or left side facing machine

Accessory:

Hand Grips

Pulleys:

Squat Pulley Frame

Before You Begin:

Remove Seat and Leg Extension

Key Points:

- Keep elbow pointing toward floor at all times.
- Keep wrist straight.
- Bend at hips, not at the waist.
- Keep back straight, chest up and maintain a very slight arch in lower back.



START

- Stand on platform, one side toward machine.
- With hand closest to Power Rod® resistance rods, grasp hand grip.
- Keeping back straight, bend at hips and knees, until trunk is parallel to floor. Place uninvolved hand on thigh to help stabilize.



ACTION

- Curl hand grip away from cable, then up toward shoulder while keeping upper arm completely motionless and elbow pointing toward the floor at all times.
- Slowly return to start position performing the same arc of motion.

Reverse Curl – Elbow Flexion (in Pronation)

Muscles worked:

Deep arm muscle (brachialis). Also the front forearm muscle (brachioradialis) and biceps.

Position:

Standing – facing machine

Accessory:

Hand Grips

Pulleys:

Squat Pulley Frame – with squat straps

Before You Begin:

Remove Seat and Leg Extension

Key Points:

- Keep elbows at sides.
- Keep wrists straight.
- Keep trunk muscles tight and maintain a very slight arch in lower back.



START

- Stand on platform.
- Bend down and grasp hand grips with palms facing backward.
- Stand with arms by sides.
- Lift chest, tighten abs and maintain slight arch in lower back.



ACTION

- Keeping palms facing down, slowly curl hand grips forward, then up, then in toward shoulders while keeping elbows at sides and upper arms completely still.
- Slowly lower to start position.

Arm Exercises

Barbell Biceps Curl – Elbow Extension

Muscles worked:

Biceps

Position:

Standing – facing machine

Accessory:

Squat Bar – with squat straps

Pulleys:

Squat Pulley Frame

Before You Begin:

Remove Seat and Leg Extension

Key Points:

- Keep elbows at sides.
- Keep wrists straight.
- Keep trunk muscles tight and maintain a very slight arch in lower back.



START

START

- Stand on platform.
- Bend down and grasp squat bar with palms facing forward.
- Stand with upper arms by sides (although not pressed tightly). Lift chest, tighten abs and maintain a slight arch in lower back.



FINISH

ACTION

- Curl squat bar forward, then up, and then in toward shoulders while keeping elbows at sides and upper arms completely still.
- Slowly lower to start position by performing same arcing motion.

Reverse Barbell Biceps Curl – Elbow Extension

Muscles worked:

Biceps

Position:

Standing – facing machine

Accessory:

Squat Bar – with squat straps

Pulleys:

Squat Pulley Frame

Before You Begin:

Remove Seat and Leg Extension

Key Points:

- Keep elbows at sides.
- Keep wrists straight.
- Keep trunk muscles tight and maintain a very slight arch in lower back.



START

START

- Stand on platform.
- Bend down and grasp squat bar with palms facing down.
- Stand with upper arms by sides (although not pressed tightly). Lift chest, tighten abs and maintain a very slight arch in lower back.



FINISH

ACTION

- Curl wrists back to bring squat bar forward, then up, and then in toward shoulders while keeping elbows at sides and upper arms completely still.
- Slowly lower to start position by performing same arcing motion.

Arm Exercises

Seated Biceps Curl – Elbow Flexion (in Supination)

Muscles worked:

Biceps

Position:

Seated – facing outward

Accessory:

Hand Grips

Pulleys:

Squat Pulley Frame

Before You Begin:

Remove Leg Extension

Key Points:

- Do not rock upper body while bending elbow.
- Keep wrists straight.
- Keep chest lifted, trunk muscles tight and maintain a very slight arch in lower back.



START

- Grasp hand grips, arms at sides with forearms near thighs.
- Maintain correct spinal alignment.



ACTION

- Curl forearms toward upper arms, keeping upper arms completely still.
- Slowly return to start position without relaxing biceps.

Seated Biceps Hammer Curl – Elbow Flexion

Muscles worked:

Biceps muscles and brachioradialis.

Position:

Seated – facing outward

Accessory:

Hand Grips in “Hammer Grip”

Pulleys:

Squat Pulley Frame

Before You Begin:

Remove Leg Extension

Key Points:

- Do not rock upper body while bending elbow.
- Keep wrists straight.
- Keep chest lifted, trunk muscles tight and maintain a very slight arch in lower back.



START

- Grasp hand grips in vertical hammer grip position, arms at sides, forearms near thighs.
- Maintain correct spinal alignment.



ACTION

- Curl forearms toward upper arms, keeping upper arms completely still.
- Slowly return to start position without relaxing biceps.

Arm Exercises

Arm Opposition Push-Pull

Muscles worked:

Biceps; Brachialis; Brachioradialis

Position:

Standing—facing outward

Accessory:

Hand Grips

Pulleys:

Lat Cross Bar and Squat Pulley Frame

Leg Extension:

Removed



START



FINISH



START

- Grasp the Hand Grips, keeping the one attached to the Lat Tower in an overhand grip and the one attached to the Squat Cable in an underhand grip.
- Straighten the Squat Cable arm and bend the Lat Cable arm at a 90° angle from your upper arm.

ACTION

- Slowly raise the Squat Cable arm while simultaneously lowering the Lat Cable arm, until each arm has reached full possible extension in opposition to each other.
- Slowly reverse, returning to start position.

Success Tips

- Lift your chest and keep your knees slightly bent and feet on Standing Platform.
- For this exercise, one Hand Grip is attached to a Lat Cable and one Hand Grip is attached to a Squat Cable. Alternate sides to build muscle evenly.
- Keep your upper body motionless, elbows at your sides and your wrists straight.
- Keep your trunk muscles tight and maintain a slight arch in lower back.

Upper Body Opposition Push-Pull

Muscles worked:

Middle Deltoids; Supraspinatus; Trapezius; Biceps; Abs

Position:

Seated—facing outward

Accessory:

Hand Grips

Pulleys:

Lat Cross Bar and Center Cross Bar

Leg Extension:

Removed



START



FINISH



START

- Grasp the Hand Grips, keeping the one attached to the Lat Tower in an overhand grip and the one attached to the Rod Cable in an underhand grip.
- Bend your forearms at a 90° angle from your upper arms, which should be at 90° angles from your torso.

ACTION

- Slowly raise the Rod Cable arm while simultaneously lowering the Lat Cable arm, until each arm has reached full possible extension in opposition to each other.
- Slowly reverse, returning to start position.

Success Tips

- Lift your chest and keep your knees bent and feet on Standing Platform.
- For this exercise, one Hand Grip is attached to a Lat Cable and one Hand Grip is attached to a Rod Cable. Alternate sides to build muscle evenly.
- Keep your upper body motionless, elbows at your sides and your wrists straight.
- Keep your trunk muscles tight and maintain a slight arch in lower back.

Arm Exercises

Wrist Extension

Muscles worked:

Back and top parts of forearms.

Position:

Standing – facing machine

Accessory:

Hand Grips

Pulleys:

Squat Pulley Frame

Before You Begin:

Remove Seat and Leg Extension

Key Points:

- Move slowly and keep tension in back of forearms at all times.
- Perform this exercise one arm at a time to make it easier to focus and isolate the back of forearms, or perform it with both arms simultaneously to save time.

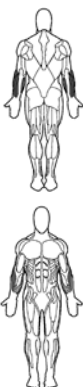

START

START

- Stand on platform, knees slightly bent.
- Grasp hand grips, palms facing down. Rest mid-forearms against sides with elbows flared out.
- Raise chest, tighten trunk muscles and maintain a slight arch in lower back.



FINISH

ACTION

- Slowly curl back of fists toward forearms.
- Slowly return to start position.

Wrist Curl – with Wrist Flexion

Muscles worked:

Front part of forearms. Also increases the strength of grip and isometrically challenges biceps.

Position:

Standing – facing machine

Accessory:

Hand Grips

Pulleys:

Squat Pulley Frame Removed

Before You Begin:

Remove Seat and Leg Extension

Key Points:

- Move slowly and keep tension in front of forearm at all times.
- Do not increase or decrease bend in arms, perform the entire motion at wrist.
- Do not rock body. Keep chest lifted, abs tight and maintain a slight arch in lower back.



START

START

- Stand on platform.
- Bend down and grasp hand grips, palms facing forward, fingertips down.
- Stand with upper arms and elbows by sides.
- Lift chest, tighten trunk muscles and maintain a slight arch in lower back.
- Bend arms 90°, palms up. Hold position throughout entire exercise.



FINISH

ACTION

- Slowly curl fists towards front of forearms.
- Keeping forearms still, slowly let fists return to start position.

Abdominal Exercises

Trunk Rotation

Muscles worked:

Most of trunk muscles. Note: rotation is limited in the spine and should be performed with minimal resistance, in proper alignment.



Position:

Seated, facing outward left or right

Accessory:

Hand Grips

Pulleys:

Center Cross Bar – standard position

Before You Begin:

Remove Leg Extension

Key Points:

! Failure to perform this exercise correctly could result in injury. Use only low weight Power Rods.

- Keep chest lifted and maintain good spinal alignment with a slight arch in lower back.
- Keep hands centered in front of middle of chest and shoulderblades pinched together. Make sure all of motion occurs in torso.
- Move only as far as muscles will take you and eliminate uncontrolled momentum.

START



START

- Sitting sideways on seat with one side facing machine, grasp hand grip closest to you with both hands.
- Raise both arms up to shoulder level, centered in front of middle chest.
- Keep elbows slightly bent.
- Lift chest, pinch shoulderblades together, tighten abs and maintain a slight arch in lower back.

FINISH



ACTION

- Tighten entire ab area and slowly rotate rib cage/arms away from cables (30 – 40°), as if rotating with a rod through middle of spine.
- Slowly return to start position.

Seated (Resisted) Oblique Abdominal Crunch

Muscles worked:

External obliques on resistance side and internal obliques on opposite side.



Position:

Seated – facing outward

Accessory:

Abdominal Crunch Shoulder Harness

Pulleys:

Abdominal bar

Before You Begin:

Remove Leg Extension

Key Points:

- Allow exhalation up and inhalation down, don't exaggerate it.
- Do not lift head/chin. head should follow rib motion, not lead, allowing you to maintain normal neck posture.
- Tighten abs throughout range of motion. Do not let abs relax until set is over.
- MOVING SLOWLY to eliminate momentum is critical.

START



START

- Place seat in lowest position.
- Attach the Abdominal Crunch Shoulder Harness by snapping a hook to each of the D rings. Place the harness on your shoulders letting the handles hang over your chest. Grab both handles. With high resistance, a cross arm opposite-handle grip may be used.
- Lower back can start flat or in a normal arch, knees and hips bent, feet flat on floor.

FINISH



ACTION

- Tighten abs before you move, focusing on area from side of ribs to front of pelvis on the same side.
- Slowly move diagonally, rotating and curling torso, with the side of ribs directed toward front of pelvis.
- Move as far as you can, without moving hips or lower back from bench.
- Slowly reverse motion returning to start position without resting.

Abdominal Exercises

Seated (Resisted) Abdominal Crunch – Spinal Flexion

Muscles worked:

Abdominal area including upper and lower front abs (rectus abdominus) and side abs (obliques).

Position:

Seated – facing outward

Accessory:

Abdominal Crunch Shoulder Harness

Pulleys:

Abdominal bar

Before You Begin:

Remove Leg Extension

Key Points:

- Allow exhalation up and inhalation down, but don't exaggerate it.
- Do not lift head/chin. Your head should follow rib motion, not lead, allowing you to maintain normal neck posture.
- Tighten abs throughout range of motion. Do not let abs relax until set is over.
- MOVING SLOWLY to eliminate momentum is critical.



START

- Attach the Abdominal Crunch Shoulder Harness by snapping one hook to each of the D rings. Place the harness on your shoulders letting the handles hang over your chest. Grab both handles. With high resistance, a cross arm opposite-handle grip may be used.
- Lower back can start out flat or in normal arch, knees and hips bent and feet flat on floor.



ACTION

- Tighten abs and curl only torso, slowly moving ribs toward hips. Move as far as you can without moving hips or neck. LOWER BACK SHOULD NOT LOSE CONTACT WITH BENCH when fully crunched.
- Slowly reverse motion returning to start position without relaxing.

Leg Exercises

Leg Extension

Muscles worked:

All muscles on front of upper thigh (quadriceps muscle group).

Position:

Seated – facing outward

Accessory:

Leg Extension

Pulleys:

Squat Pulley Frame

Before You Begin:

Adjust seat height

Key Points:

- Use slow controlled motion. Do not “kick” into extension.
- Do not let knees rotate out during exercise. Keep kneecaps pointing up and forward.



START

START

- Sit on seat facing away from machine with knees near pivot point and lower roller pads on shins.
- Adjust thighs to hip width, pointing knee caps to front.
- Grasp sides of seat.
- Sit up straight with chest lifted, abs tight and a slight arch in lower back.



FINISH

ACTION

- Tighten quads and straighten legs by moving feet forward, then upward until legs are completely straight and kneecaps are pointing up toward the ceiling.
- Slowly return to start position keeping tension in quads during movement.

Squat

Muscles worked:

All muscles of legs and buttocks (gluteus maximus).

Position:

Standing – facing outward

Accessory:

Squat Bar – with squat straps

Pulleys:

Squat Pulley Frame

Before You Begin:

Remove Seat and Leg Extension

Key Points:

- Make sure you do not bend waist or lower back.
- Keep abs tight throughout entire exercise.
- Keep knees pointed straight out in front of you.
- Never step off platform while under resistance.



START

START

- Stand on platform, feet shoulder width apart.
- Squat down and place squat bar across shoulders. Adjust strap on bar to make sure you have resistance at start of movement.
- Keep spine in good posture, with chest lifted, abs tight and maintain a very slight arch in lower back.



FINISH

ACTION

- Slowly rise to standing position. Keep knees slightly bent.
- Slowly return to start position. Do not allow knees to exceed a 90° angle.

Leg Exercises

Standing Hip Extension – Knee Bent

Muscles worked:

Buttocks area (gluteus maximus).

Position:

Standing – facing machine

Accessory:

Hand Grip on arch

Pulleys:

Squat Pulley Frame

Before You Begin:

Remove Seat and Leg Extension

Key Points:

- Make sure all motion occurs at hip, NOT waist or lower back.
- Keep abs tight throughout entire exercise.
- Maintain exactly the same bend in the knee of moving leg throughout entire exercise.



START

START

- Secure hand grip around arch of foot. Keep this leg bent at approximately 90°.
- Hold onto seat back pad to stabilize yourself.
- Keep spine in good posture, chest lifted, abs tight. Maintain a slight arch in lower back.



FINISH

ACTION

- Tighten glutes. Extend hip by moving entire leg backward.
- Slowly move leg as far as you can, without allowing ANY movement to occur at waist.
- Slowly return to start position.

Standing Hip Extension – Knee Extended

Muscles worked:

Buttocks area (gluteus maximus).

Position:

Standing – facing machine

Accessory:

Hand Grip on arch

Pulleys:

Squat Pulley Frame

Before You Begin:

Remove Seat and Leg Extension

Key Points:

- Make sure all motion occurs at hip, NOT waist or lower back.
- Keep abs tight throughout entire exercise.
- Keep leg in same position – slightly away from body's midline through entire exercise.



START

START

- Secure hand grip around arch of foot. Move leg very slightly away from midline – enough to move leg freely.
- Very slightly bend knee of support leg.
- Hold onto seat back pad to stabilize yourself.
- Keep spine in good posture, chest lifted, abs tight. Maintain a slight arch in lower back.



FINISH

ACTION

- Tighten glutes. Extend hip by moving entire leg backward.
- Slowly move leg as far as you can, without allowing ANY movement to occur at waist.
- Slowly return to start position.

Leg Exercises

Leg Kickback – Hip and Knee Extension

Muscles worked:

Buttocks area (gluteus maximus).

Position:

Standing – facing machine

Accessory:

Hand Grip on arch

Pulleys:

Squat Pulley Frame

Before You Begin:

Remove Seat and Leg Extension

Key Points:

- Do not allow waist, lower back or supportive hip to move.
- Keep abs tight throughout entire exercise.



START

START

- Secure cuff around arch of foot. Keep this leg bent at approximately 90°.
- Hold onto seat back pad to stabilize yourself.
- Keep spine in good posture, chest lifted, abs tight. Maintain a slight arch in lower back.



FINISH

ACTION

- Extend entire leg backward, straightening knee.
- Slowly move leg as far as you can, without allowing ANY movement to occur at waist.
- Slowly return to start position.

Hip Flexion – Knee Flexion

Muscles worked:

Muscles on front of hips (iliopsoas, rectus femoris).

Position:

Standing to the left or right of machine facing away

Accessory:

Hand Grip on ankle

Pulleys:

Squat Pulley Frame

Before You Begin:

Remove Seat and Leg Extension

Key Points:

- Make sure all motion occurs at hip, NOT waist or lower back.
- Keep chest lifted and trunk muscles tight throughout entire exercise.
- Allow lower leg to hang in the direction of cable at all times.



START

START

- Use Center Cross Bar as a stabilizer.
- Secure a hand grip around one of ankles.
- Straighten, but do not lock, knee of support leg.
- Keep spine in good posture, chest lifted, abs tight. Maintain a slight arch in lower back.



FINISH

ACTION

- Lift knee up and in toward torso.
- Allowing knee to bend as you move, bring knee up as far as you can, without allowing ANY movement to occur at waist or lower back.
- Slowly return to start position without resting leg muscles.

Leg Exercises

Dead Lift

Muscles worked:

Buttocks area (gluteus maximus).

Position:

Standing – facing outward

Accessory:

Squat Bar

Pulleys:

Squat Pulley Frame

Before You Begin:

Remove Seat and Leg Extension



START

- Facing away from machine, grip squat bar using one hand with an underhand grip and the other hand with an overhand grip.
- Keep legs bent at 90°. Bend over 30-45° from hips (not waist).
- Keep spine in good posture, chest lifted, abs tight. Maintain a slight arch in lower back.



ACTION

- Push up with legs.
- Slowly move up until you are in the standing position.
- Slowly return to start position.

Stiff Leg Dead Lift

Muscles worked:

Buttocks area (gluteus maximus) and hamstrings.

Position:

Standing – facing outward

Accessory:

Squat Bar

Pulleys:

Squat Pulley Frame

Before You Begin:

Remove Seat and Leg Extension



START

- Stand on platform. Grasp squat bar with palms facing down.
- Keep legs very slightly bent.
- Bend 90° from hips (not waist).
- Keep spine in good posture, chest lifted and abs tight. Maintain a slight arch in lower back.



ACTION

- Push hips forward.
- Slowly move trunk up until you are in standing position. Glutes should be tight when reaching standing position.
- Slowly return to start position.

Key Points:

- Make sure to keep your back flat – do not arch.
- Your motion is entirely at the hips NOT the waist.
- Keep knees slightly bent and head up.
- Use light weight.

Leg Exercises

Standing Hip Adduction

Muscles worked:

Insides of thighs (adductor muscle groups). Also, the outside of hip (gluteus medius) on support leg.

Position:

Stand to left or right of machine – facing outward

Accessory:

Hand Grip over ankle

Pulleys:

Squat Pulley Frame

Before You Begin:

Remove Seat and Leg Extension

Key Points:

- Do not use exercise for losing fat from thighs. Use it to develop hip strength and stability.
- Do not cross attached leg in front of standing/support leg. Use a small range of motion. More is not better.
- Keep spine straight and hips level. Try not to raise hips when raising leg to side or drop the hip when returning to start position.



START

START

- Stand to one side of platform with one side near machine. Slide a hand grip over ankle nearest machine (inside leg).
- Stand straight, lift chest, tighten abs and maintain a slight arch in lower back.
- Adjust position away from machine so there is room to move attached leg toward pulley.



FINISH

ACTION

- Slowly allow attached leg to move in toward support leg (30-45°), keeping hips and spine still.
- Slowly draw leg back to start position.

Standing Hip Abduction

Muscles worked:

Sides of hips (gluteus medius), especially on the standing/support side.

Position:

Stand to left or right of machine – facing outward

Accessory:

Hand Grip over ankle

Pulleys:

Squat Pulley Frame

Before You Begin:

Remove Seat and Leg Extension

Key Points:

- Do not use this exercise for losing fat from hips. It will not make hips smaller. Use it to develop hip strength and stability.
- Use a small range of motion. More is not better.
- Keep spine straight and hips level. Try not to raise hips when raising leg to the side.



START

START

- Stand to one side of platform with one side near machine. Slide hand grip to ankle furthest from machine (outside leg).
- Stand up straight, lift chest, tighten abs and maintain a slight arch in lower back.
- Adjust position so there is some resistance in cables.



FINISH

ACTION

- Slowly move attached leg out to side away from pulley (30-45°), keeping hips and spine still.
- Slowly return to start position without relaxing muscles.

Leg Exercises

Calf Raise – Ankle Plantarflexion (Knee Stabilized)

Muscles worked:

Lower leg or calf (gastrocnemius, soleus).

Position:

Standing – facing machine

Accessory:

Hand Grips

Pulleys:

Squat Pulley Frame

Before You Begin:

Remove Seat and Leg Extension

Key Points:

- Do not lose contact between the balls of feet and the frame as you push.
- Do not change hip or knee position, ONLY ankle motion should be allowed.

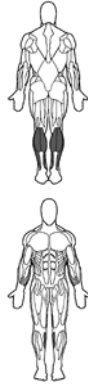

START

- Stand with toes on platform and heels hanging over edge.
- Use hand grips in both hands as resistance and a balance stabilizer.
- Lift chest, tighten abs and maintain a slight arch in lower back.



ACTION

- Slowly press balls of feet into platform and lift heels up.
- Slowly return to start position.

Single Leg Calf Raise—Ankle Plantarflexion (knee stabilized)

Muscles worked:

Gastrocnemius; Soleus

Position:

Standing—facing machine

Accessory:

Hand Grips

Pulleys:

Squat Pulley Platform—Standard Pulley

Leg Extension:

Removed

Success Tips

- Do not lose contact with the balls of your foot and the Standing Platform during motion.
- Keep your chest lifted, spine aligned, abs tight and a slight arch in your lower back.
- Do not lift your hips or excessively arch your back.
- Do not change hip or knee position—ONLY ankle motion should be used.



START

- Stand on one foot, with your toes/balls of feet on the Standing Platform, heels hanging over the edge.
- Use the Hand Grips in both hands as resistance and as a balance stabilizer.
- Keep the unused leg out of the way, do not use it to build momentum.



ACTION

- Slowly press the ball of your foot into the Standing Platform and lift your heel upward.
- Then, maintaining tension, slowly return to the start position.

Muscle Chart

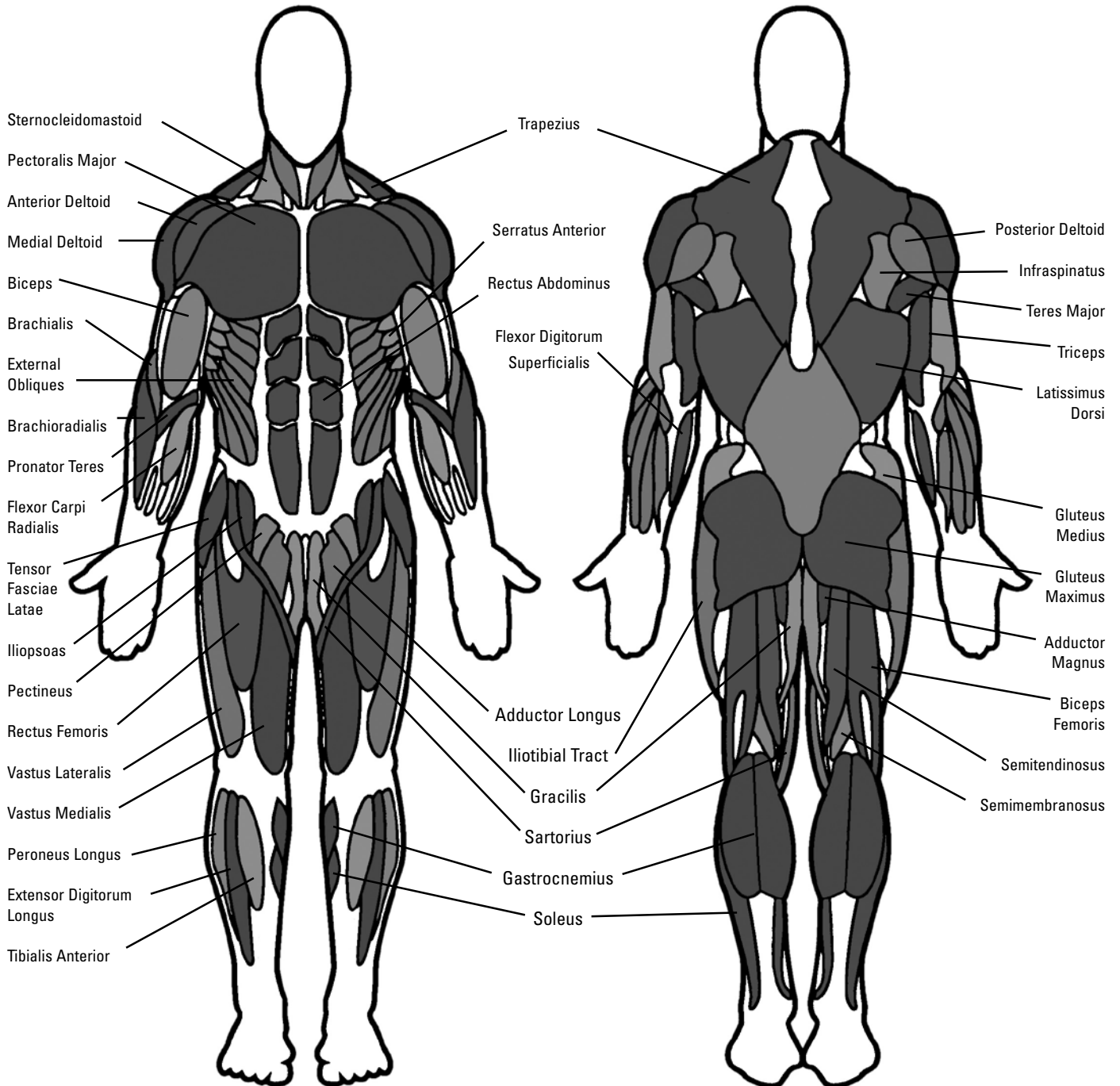

Exercise Log

Please feel free to make copies of this chart to continue your exercise log.

EXERCISE	SETS	DATE	DATE	DATE	DATE	DATE	DATE
<i>Bench Press</i>	Sets	2					
	Reps	10, 9					
	Resistance	120, 130					
	Sets						
	Reps						
	Resistance						
	Sets						
	Reps						
	Resistance						
	Sets						
	Reps						
	Resistance						
	Sets						
	Reps						
	Resistance						
	Sets						
	Reps						
	Resistance						
	Sets						
	Reps						
	Resistance						
	Sets						
	Reps						
	Resistance						
	Sets						
	Reps						
	Resistance						
	Sets						
	Reps						
	Resistance						
	Sets						
	Reps						
	Resistance						

Exercise Log

EXERCISE		DATE	DATE	DATE	DATE	DATE	DATE
	Sets						
	Reps						
	Resistance						
	Sets						
	Reps						
	Resistance						
	Sets						
	Reps						
	Resistance						
	Sets						
	Reps						
	Resistance						
	Sets						
	Reps						
	Resistance						
	Sets						
	Reps						
	Resistance						
	Sets						
	Reps						
	Resistance						
	Sets						
	Reps						
	Resistance						
	Sets						
	Reps						
	Resistance						
	Sets						
	Reps						
	Resistance						

Bowflex® 6-Week Satisfaction Guarantee

We want you to know that Bowflex Xtreme® 2 SE home gym is a superior product. Your satisfaction is guaranteed.

If, for any reason, you are not 100% satisfied with your Bowflex Xtreme® 2 SE home gym, please follow the instructions below to return your merchandise and receive a refund of the purchase price, less shipping and handling.

1. Call a Bowflex® Representative at 1-800-605-3369 for a Return Authorization Number. Return Authorization will be granted if:
 - a. You purchased your Bowflex Xtreme® 2 SE home gym directly from Nautilus, Inc.; and
 - b. You are calling within 6 weeks of the delivery date of your merchandise.
2. All returned merchandise must be properly packaged in the original boxes and in good condition. Returns should be shipped to the address given to you by the Bowflex® Representative.

NOTE: You are responsible for return shipping and for any damage or loss to merchandise that occurs during return shipment. We highly recommend that you insure your shipment.

3. Please mark all boxes clearly with:
 - Return Authorization Number
 - Your Name
 - Your Address
 - Your Phone Number

Boxes without this information clearly marked on the outside may be refused.

4. Please make copies of your original invoice and put one in each box of merchandise. Nautilus, Inc. must receive your shipment within two weeks from the date the Bowflex® Representative issued you your Return Authorization Number.

**Refunds may be denied or delayed
if these instructions are not completely followed.**

This Bowflex® Satisfaction Guarantee applies only to merchandise purchased by consumers directly from Nautilus, Inc. This guarantee does not apply to sales made by dealers or distributors.

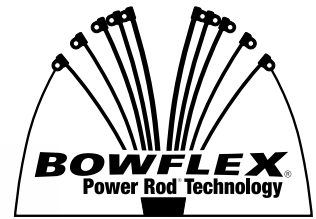

BOWFLEX
XTREME 2 SE

Nautilus, Inc., (800) NAUTILUS / (800) 628-8458, www.NautilusInc.com - Customer Service: North America (800) 605-3369, customerservice@bowflex.com | Asia Pacific & Latin America (360) 859-5180, technics-APLA@nautilus.com | Printed in China | © 2008 Nautilus, Inc., All rights reserved. ™ and ® indicate a trademark or registered trademark. Nautilus, Inc. (www.NautilusInc.com) trademarks include NAUTILUS®, BOWFLEX®, XTREME®, SCHWINN® and UNIVERSAL® and respective logos. Other trademarks are the property of their respective owners.