

THE CLEAN WATER MACHINE

Set Up Instructions



Quick Start

Insert filter before using
Flush one cycle before drinking



Get Help

866-662-6885
support@aquasana.com

Live Healthy

Congratulations! You are about to enjoy, healthy water filtered by your Clean Water Machine.

Start drinking healthier water, better tasting beverages (coffee, tea, smoothies) and better tasting foods (vegetables, rice, pasta, soups). Even your pets and plants can now benefit with chemical-free water.

Please read and follow the instructions on setup and care of the product. If you need help, please call us at 866-662-6885 or email support@aquasana.com.

Enjoy!

Sincerely,

The Aquasana Team

SAVE TIME AND MONEY



with
Water for Life™

The most convenient and economical way to get replacement filters for your system is to sign up for the Water for Life auto-ship program. Replacement filters come with:

- FREE shipping
- A 15% discount
- A System warranty (as long as you're enrolled)

It's free to join
and you can unsubscribe at any time

1-866-662-6885 • aquasana.com/water4life

Filter

Slide lid right to lift off.

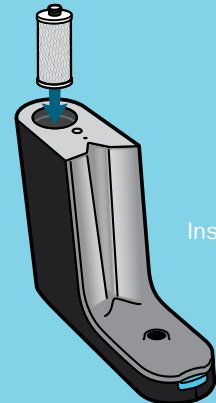

Insert the filter.

Replace lid by sliding left.

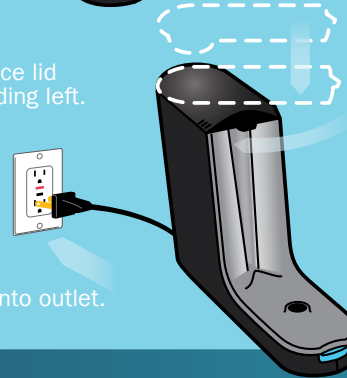

Plug into outlet.

Dispenser

Fill dispenser with tap water.

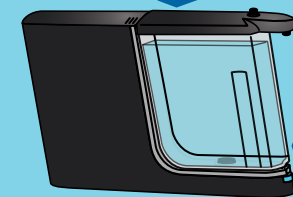

Place firmly on dock.

Hold down button to filter and dispense water instantly.



Release button early to avoid spills.

Pitcher

Fill the inner chamber with tap water.

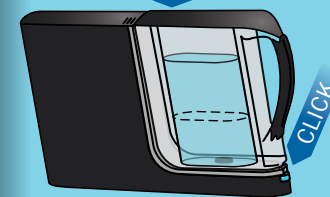

Firmly place on dock. The system will automatically filter entire pitcher.

Wait at least 15 seconds after blue light turns off before you remove.

Place in fridge for chilled water.

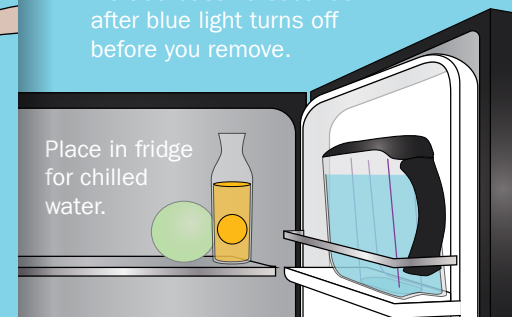

Flush before first use

Use and Care Guide

- To clean the filter unit, wipe exterior with a damp cloth.
- The pitcher and dispenser lids are NOT dishwasher safe and should be hand washed only.
- The clear pitcher and dispenser bodies are dishwasher safe. DO NOT use the heat cycle of the dishwasher to dry.

Precautions

- Do not operate without filter cartridge installed.
- Use only with cold water.
- Children should not operate without supervision.
- Do not use with water that is microbiologically unsafe or of unknown quality without adequate disinfection before or after the system.
- Systems certified for cyst reduction may be used on disinfected waters that may contain filterable cysts.

Operating Specs:

- Temp range: 40-90° F (4.44-32.2° C).
- Rated flow rate: 0.5 gpm (1.8 lpm).
- Capacity of filter: 320 gallons (1,211 l).
- Pressure: 20-70 psi (137-482 kPa).
- Voltage: 100-240.

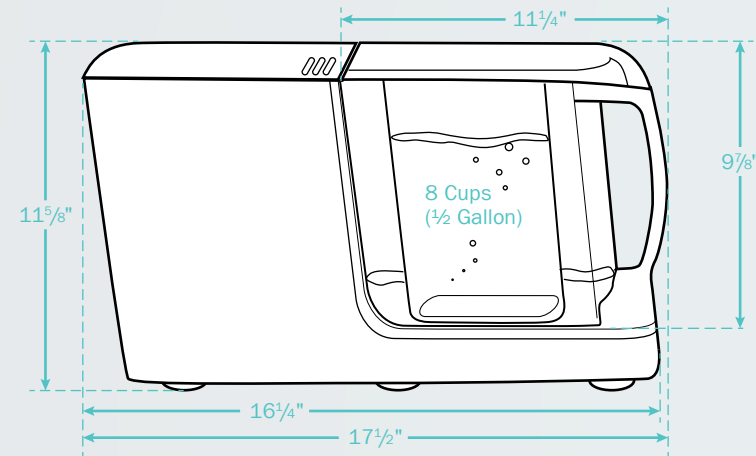
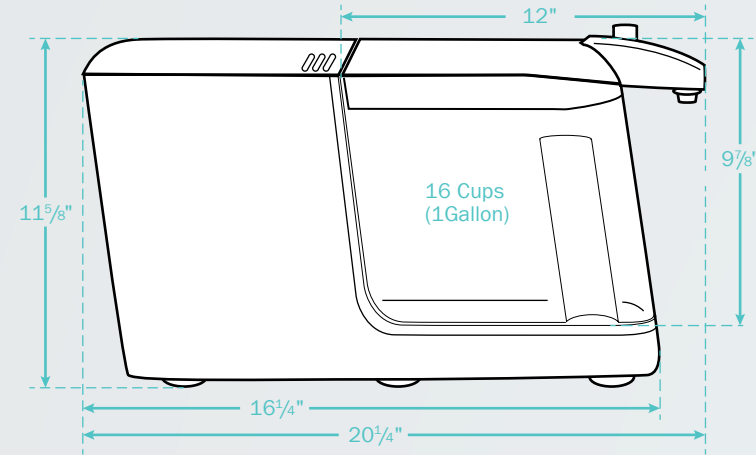

Contents

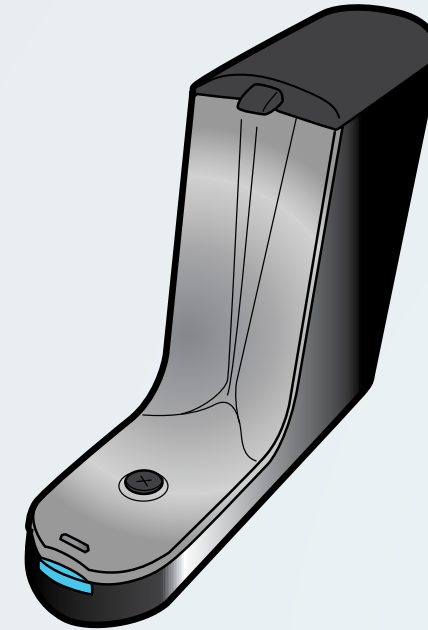

Filtration Dock

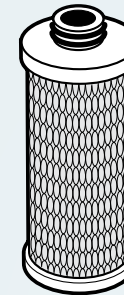

Claryum® Filter

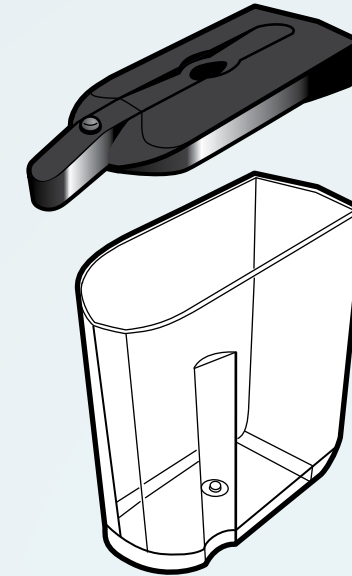

Dispenser with Lid

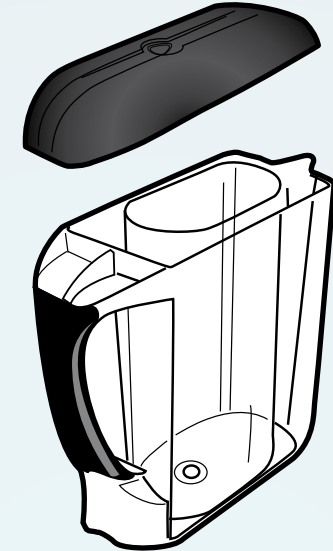

Pitcher with Lid



1 Liter Carafe
(Not part of NSF Certification)

Optional components shown:
Some bundles may not contain the
Dispenser, Pitcher or Carafe.

Install the Filter

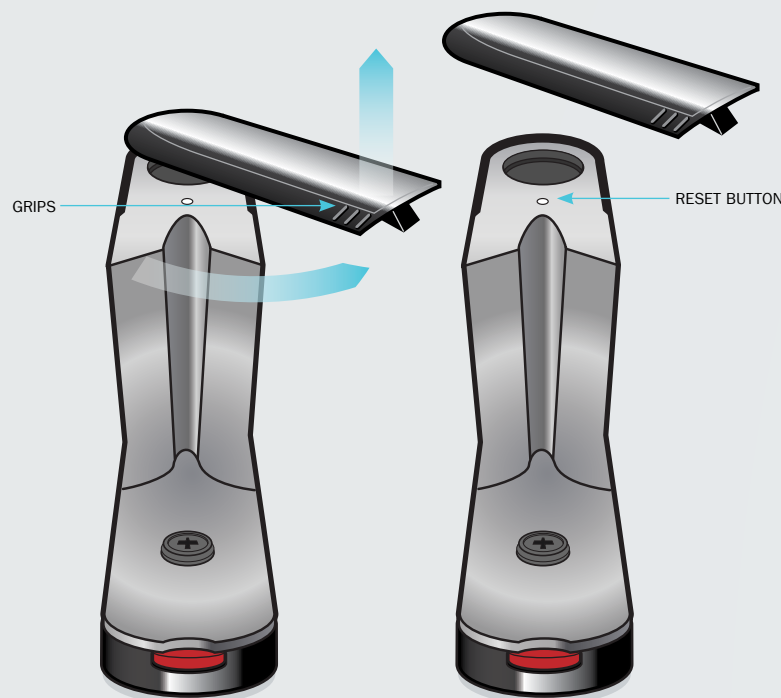

With filtration dock facing forward, use grips on the left side of the top cover to slide to the right until it lifts up and off.

Watch A Setup
Video Online
aquasana.com/cwmsetup

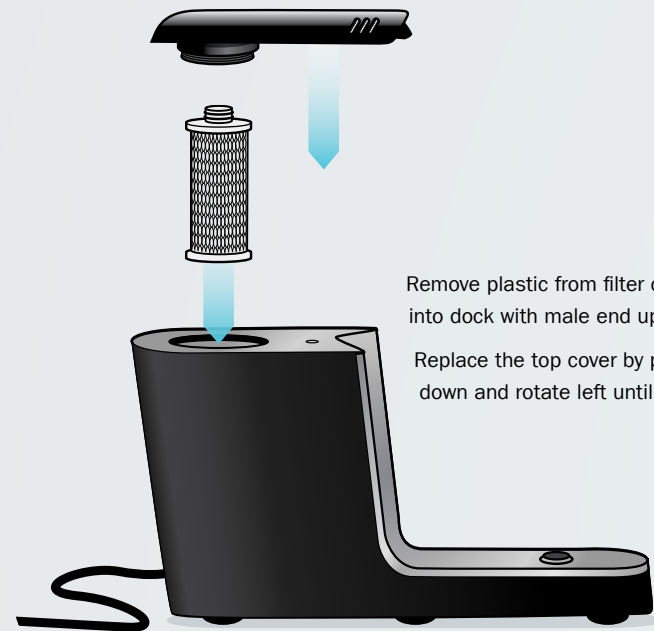

Remove plastic from filter cartridge and place into dock with male end up.

Replace the top cover by pressing it firmly down and rotate left until fully locked in.

Once filter is installed, plug filtration dock into an electrical outlet.

Flush the System for one Cycle with dispenser or pitcher

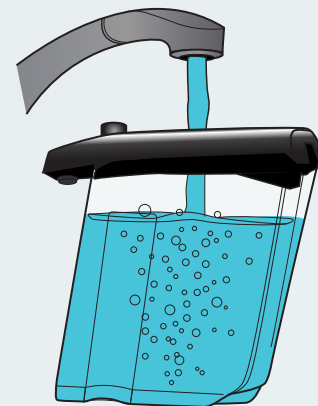

Dispenser

- Place lid on dispenser.
- Fill dispenser with cold water through drop-shape.
- Place dispenser on the filtration dock until fully locked in.
- Hold dispenser button down until all water has filtered through the unit. Discard water. Flushing is complete.



To dispense filtered water, push button on reservoir lid. There will be a 5-10 second delay for water to filter through.

Please wait for system to finish filtering before removing the dispenser from the dock.

Once dispenser is removed there may be residual water left on the dock; this is normal.

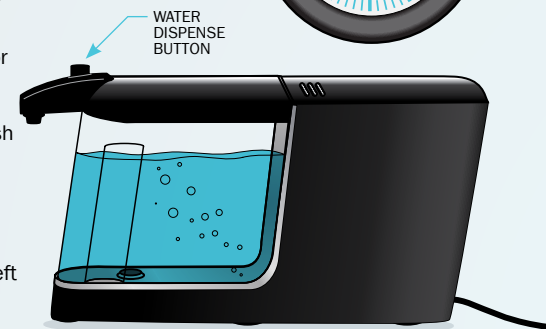

Please note: Water may leak from circular valve when placing dispenser onto dock.



Pitcher

- Place lid on pitcher.
- Fill center reservoir with cold water through drop-shaped opening.
- Place pitcher on filtration dock until locked in. It will automatically filter and run until center reservoir is empty.
- Wait for blue light to turn off.
- Remove pitcher and discard water. Flushing is complete.

The system will run until the center reservoir is completely empty. Do not refill center reservoir if water remains in outer reservoir.

Please wait for blue light to turn off before removing pitcher from dock.

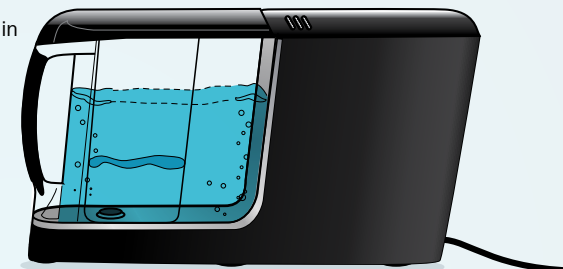

Troubleshooting Guide

What should I do if my system won't run?

- Make sure system is plugged into a power source.
- Ensure dispenser or pitcher is fully attached to filtration dock — remove and replace.
- Make sure dispenser or pitcher contains water. System will not run without water.
- Dry any excess water that may be on the base of the dock.
- Be sure lid is attached to the dispenser or pitcher. System will not run without lid.
- Dispenser will only filter and serve water when button is held down.

What if water is leaking from bottom of dispenser when on the base?

- Ensure the dispenser or pitcher is fully attached to filtration dock — remove it and replace on dock.

What should I do if my system is leaking under the top cover?

- Remove top cover from filtration dock.
(Refer to “Install the Filter” section on how to remove the cover.)
- Ensure black rubber O-ring is in place on the bottom connection point of the lid.
- Ensure cartridge is installed correctly.

My water is cloudy.

- Cloudy water is just microscopic air bubbles, and should dissipate within a few minutes of filling outer reservoir.
- If cartridge was flushed and you continue to see cloudiness, this is normal for the first few days of use on new cartridge installations.

The circular valve at the base of the dock leaks.

- Ensure that dispenser or pitcher is inserted squarely on top of circular valve to avoid depressing the valve plunger that releases water.
- Small amounts of water on the base will not disrupt the filter system.

Why is my system running on and off?

- The pump in the system will shut down at 60 to 75 psi. This will more than likely happen when the filter in the system is clogged. Depending on your water quality, the filter in your system might need to be changed more frequently.

THE INDICATOR LIGHT

SOLID BLUE
Filter is Healthy

BLINKING RED
Filter @ 80% Capacity: ORDER NOW

SOLID RED
Filter @ 100% Capacity: REPLACE

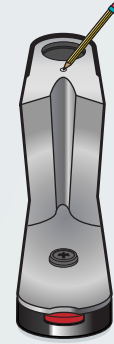

← reset



IMPORTANT

Press reset button with a paper clip, pencil or similar item when you replace the smart filter (see replacement cartridge instructions).

STILL EXPERIENCING AN ISSUE WITH YOUR SYSTEM?

PLEASE CALL AQUASANA AT
866.662.6885
Select option #2

We offer complimentary shipping on unit exchanges.

Your satisfaction is our #1 goal.

TALK
TO A
WATER
EXPERT

1-Year Limited Warranty

What is Covered: This Warranty covers defects in materials or workmanship in manufacturing of your Aquasana drinking or shower water filter systems, except as provided below.

For How Long: This warranty runs for 365 days from the date of purchase by a consumer (“Warranty Period”).

What is not Covered: This warranty does not cover filter cartridges and any products that were not installed in compliance with the instructions or that have been abused or operated incorrectly. It also does not cover incidental or consequential damages caused by a failure of the product. Finally, this warranty is voided if the product is used with parts that are not genuine Aquasana parts. This includes, but is not limited to: replacement filters, faucets, and diverter valves. This warranty does not cover the RHINO Whole House Filtration System.

What Aquasana, Inc. Will Do: We will replace the defective part of the covered product and send it to you with installation instructions upon payment of \$9.50 for shipping and handling per incident.

How To Get Service: To receive service under this Warranty, you must contact Aquasana, Inc. at 1-866-662-6885 or warranty@aquasana.com within the Warranty Period to describe the problem to a customer service representative who will verify that the product is under warranty and arrange for delivery of a replacement part.

How State Law Applies: This warranty gives you specific rights and you may have other rights which vary from state to state.

Some states do not allow the exclusion or limitation of incidental or consequential damages, so the above limitation or exclusion may not apply to you.

Warranty Card: Warranty registration is not required for coverage under the Aquasana Limited Warranty and is not necessary for factory direct purchases made from www.aquasana.com. If you purchased from a retailer or dealer, please complete the online warranty registration form at www.aquasana.com/warranty. Once registered online, we will have a record of your purchase and you will not be required to produce a proof of purchase for a warranty claim.

Aquasana, Inc. • 6310 Midway Rd, Haltom City, TX 76117 • info@aquasana.com • www.aquasana.com • (866) 662-6885

Performance Data Sheet for the Aquasana Clean Water Machine					
Models	Replacement	Rated capacity	Operating pressure range	Operating temp. range	Rated flow
AQ-CWM-RB1, AQ-CWM-RB2, AQ-CWM-RB1W, AQ-CWM-P-W, AQ-CWM-P-B, AQ-CWM-D-W, AQ-CWM-D-B, AQ-PCBK-GC, AQ-PC-GC	AQ-CWM-RD, AQ-CWM-RR	320 gallons 1200 liters	20-70 psi 137-482 kPa	40-90° F 4.44-32.2° C	0.5 gpm 1.8 lpm
Manufactured by: Aquasana, Inc. 6310 Midway Road · Haltom City, Texas 76117 · 866.662.6885					

This system has been tested according to NSF/ANSI 42, 53 & 401 for reduction of the substances listed below. The concentration of the indicated substances in water entering the system was reduced to a concentration less than or equal to the permissible limit for water leaving the system, as specified in NSF/ANSI 42, 53 & 401.



System tested and certified by NSF International against NSF/ANSI Standard 42, 53 and 401 for the reduction of the claims specified on the Performance Data Sheet and at www.nsf.org.

- All contaminants reduced by this filter are listed.
- Not all contaminants listed may be present in your water.
- Does not remove all contaminants that may be present in tap water.



Filter is only to be used with cold water.



Filter usage must comply with all state and local laws.



Testing was performed under standard laboratory conditions, actual performance may vary.



Systems certified for cyst reduction may be used on disinfected waters that may contain filterable cysts.



See owner's manual for general installation conditions and needs plus manufacturer's limited warranty.



Do not use with water that is microbiologically unsafe or of unknown water quality without adequate disinfection before or after the system.

NSF/ANSI 42	Minimum Reduction	Overall % Reduction	Results
Chlorine Reduction, Free Available	<0.5 mg/l	96.06%	Pass
Chloramine Reduction, Free Available	<0.5 mg/l	96.06%	Pass
Particulate Reduction	85%	99.9%	Pass

NSF/ANSI 53	Minimum Reduction	Overall % Reduction	Results
Cyst Live Cryptosporidium & Giardia	99.95%	>99.95%	Pass
Mercury Reduction pH 8.5	<2 ug/L	>96.7%	Pass
Mercury Reduction pH 6.5	<2 ug/L	>96.6%	Pass
Lead Reduction pH 6.5	<10 ug/L	>99.3%	Pass
Lead Reduction pH 8.5	<10 ug/L	>99.4%	Pass
MTBE Reduction	<5 ug/L	91.2%	Pass
Turbidity	<0.5 NTU	99.1%	Pass
VOC Surrogate Test	95%	95%	Pass
Asbestos Reduction	99%	>99%	Pass

NSF/ANSI 401	Maximum Concentration	Minimum Reduction	Overall % Reduction	Results
Phenytol	30 ng/L	95.50%	95.6%	Pass
Ibuprofen	60 ng/L	95.3%	95.4%	Pass
Naproxen	20 ng/L	96.3%	96.4%	Pass
Estrone	20 ng/L	96.30%	96.5%	Pass
Bisphenol A	300 ng/L	98.80%	98.9%	Pass
Nonyl phenol	200 ng/L	97.50%	97.5%	Pass

Organic chemicals included by surrogate testing				
VOCs (by surrogate testing using chloroform)	Drinking water regulatory level (MCL/MAC) mg/L	Influent/Unfiltered	Effluent/Filtered	Percent Reduction
alachlor	0.002	0.050	0.001	>98%
atrazine	0.003	0.100	0.003	>97%
benzene	0.005	0.081	0.001	>99%
carbofuran	0.04	0.190	0.001	>99%
carbon tetrachloride	0.005	0.078	0.0018	98%
chlorobenzene	0.1	0.077	0.001	>99%
chloropicrin	—	0.015	0.0002	99%
2,4-D	0.07	0.110	0.0017	98%
dibromochloropropane (DBCP)	0.0002	0.052	0.00002	>99%
o-dichlorobenzene	0.6	0.080	0.001	>99%
p-dichlorobenzene	0.075	0.040	0.001	>98%
1,2-dichloroethane	0.005	0.088	0.0048	95%
1,1-dichloroethylene	0.007	0.083	0.001	>99%
cis-1,2-dichloroethylene	0.07	0.170	0.0005	>99%
trans-1,2-dichloroethylene	0.1	0.086	0.001	>99%
1,2-dichloropropane	0.005	0.080	0.001	>99%
cis-1,3-dichloropropylene	—	0.079	0.001	>99%
dinoseb	0.007	0.170	0.0002	99%
endrin	0.002	0.053	0.00059	99%
ethylbenzene	0.7	0.088	0.001	>99%
ethylene dibromide (EDB)	0.00005	0.044	0.00002	>99%
haloacetonitriles (HAN)				
bromochloroacetonitrile	—	0.022	0.0005	98%
dibromoacetonitrile	—	0.024	0.0006	98%
dichloroacetonitrile	—	0.0096	0.0002	98%
trichloroacetonitrile	—	0.015	0.0003	98%
haloketones (HK)				
1,1-dichloro-2-propanone	—	0.0072	0.0001	99%
1,1,1-trichloro-2-propanone	—	0.0082	0.0003	96%
heptachlor (H-34, Heptox)	0.0004	0.025	0.00001	>99%
heptachlor epoxide	0.0002	0.0107	0.0002	98%
hexachlorobutadiene	—	0.044	0.001	>98%
hexachlorocyclopentadiene	0.05	0.060	0.000002	>99%
lindane	0.0002	0.055	0.00001	>99%
methoxychlor	0.04	0.050	0.0001	>99%
pentachlorophenol	0.001	0.096	0.001	>99%
simazine	0.004	0.120	0.004	>97%
styrene	0.1	0.150	0.0005	>99%
1,1,2,2-tetrachloroethane	—	0.081	0.001	>99%
tetrachloroethylene	0.005	0.081	0.001	>99%
toluene	1	0.078	0.001	>99%
2,4,5-TP (silvex)	0.05	0.270	0.0016	99%
tribromoacetic acid	—	0.042	0.001	>98%
1,2,4-trichlorobenzene	0.07	0.160	0.0005	>99%
1,1,1-trichloroethane	0.2	0.084	0.0046	95%
1,1,2-trichloroethane	0.005	0.150	0.0005	>99%
trichloroethylene	0.005	0.180	0.0010	>99%
trihalomethanes (THMs)				
bromodichloromethane (THM)		Influent/Unfiltered	Effluent/Filtered	Percent Reduction
bromoform (THM)	0.080	0.300	0.015	95%
chloroform (THM)				
chlorodibromomethane (THM)				
xylenes (total)	10	0.070	0.001	>99%

Aquasana offers an extensive assortment of water filters and vessels to complement a healthy lifestyle.



Filter Bottles



Premium Glass Bottles



Whole Home Filters and Salt-Free Softeners



Shower Filtration

aquasana.com



System tested and certified by NSF International
against NSF/ANSI Standard 42, 53 and 401
for the reduction of the claims specified on the
Performance Data Sheet and at www.nsf.org.

Aquasana, Inc.

6310 Midway Road • Haltom City, Texas 76117
866.662.6885 USA • 877.332.7873 Canada
www.aquasana.com