



The Darcy Boxer Shorts

MEASURE
TWICE

CUT
ONCE

MEASURE
TWICE
CUT
ONCE

The Darcy Boxer Shorts



Like their namesake Darcy, these boxers are classically stylish.

With two options for construction you can choose a womens boxer featuring shorter leg length, side splits and turnover elastic at waist. Or you can choose the mens boxer with traditional exposed elastic, working fly and standard leg length.

Designed for woven fabric with elastic at waist.

Suggested Fabrics

Woven fabrics such as voile, cambric, lawn, quilting cottons, silks and satins. Unsuitable for fabrics with high degree of stretch, bulk or stiffness such as swim lycra, denim or cord.

Trims

Women's version: 6mm width Elastic (does not need to be lingerie elastic), thread.
Men's version: 25mm (or wider) Elastic, thread.

Size Chart

Mens	XXS	XS	S	M	L	XL	XXL
Womens	6	8	10	12	14	16	18

Waist in cm	58	63	68	73	78	83	88
-------------	----	----	----	----	----	----	----

Waist in inches	22.8	24.8	26.7	28.7	30.7	32.7	34.7
-----------------	------	------	------	------	------	------	------

Hip in cm	83	88	93	98	103	108	113
-----------	----	----	----	----	-----	-----	-----

Hip in inches	32.7	34.6	36.6	38.6	40.6	42.6	44.6
---------------	------	------	------	------	------	------	------

Pattern Pieces

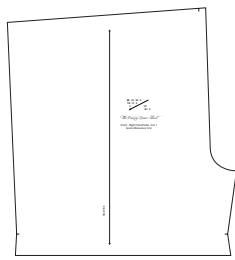

Right Front
cut 1 right side up

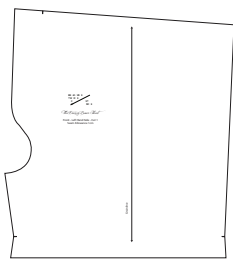

Left Front
cut 1 right side up
cut 1 interfacing for
fly extension only



Fly Facing
cut 1 right side up
cut 1 interfacing

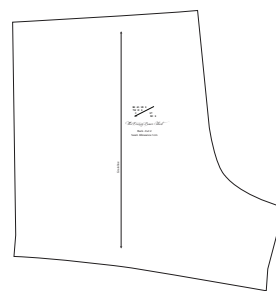

Back
cut 2

Layout

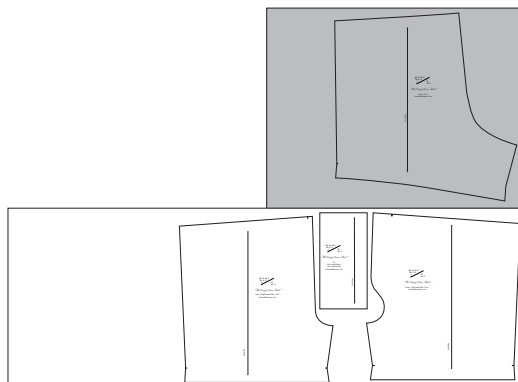

Fabric Usage

All fabric to be cut on straight grain. Need approx 95cm x 112cm width. Allow more for matching of patterns stripes or fabrics with nap or shine.

Elastic

Measure the opening, reduce by one third and then wrap that length around you before you cut. If you like a firmer or looser fit adjust as necessary. Remember these are boxers, you want them to be comfortable!

Glossary of Terms/Pattern Symbols

Grainline - the grain of a woven fabric runs parallel to the selvedge



Cut on fold - place pattern edge on fold of fabric for cutting

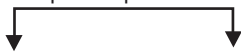

Bias - cutting woven fabric at 45 degrees to the grainline

3 step zig zag - a zig zag stitch where point to point on each zig (or zag) is made up of 3 individual straight stitches

Finish edges - serge/overlock/zig zag/pinked

Babylock - very fine rolled hem finish often done with an overlocker

Pin - use pins to hold your seam in place before stitching.

Press - use your iron to push a seam in the correct direction, create a line for hem

Right side of fabric - the side of the fabric you want facing outwards when garment is done



Wrong side of fabric - the side of the fabric you want facing inwards when garment is done



Securely stitch - reverse stitch or go over the first stitch a few times to ensure it holds in place

Nap - fabrics like velvet, satin or silks can have a sheen or nap (texture). Cut all pattern pieces in the one direction to avoid panels looking like they are different colours.

The Darcy Boxer Shorts - Sewing Instructions Page 1

All seam allowances are 1cm

If you are making the womens version at certain points the construction methods are different. You will see the alternative instructions in these green boxes.

1 - With right sides together match back panel with a front panel at inside leg seam. Pin in place.

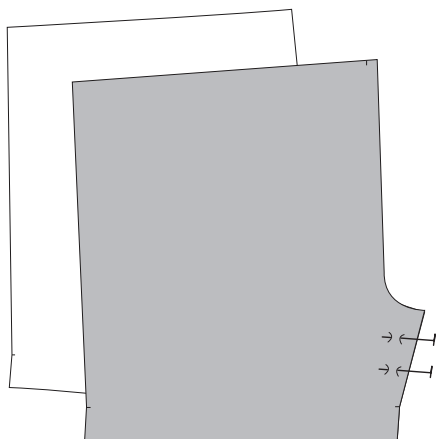

2 - Straight stitch the 1cm seam allowance and finish the raw edges by overlocking or zigzagging.

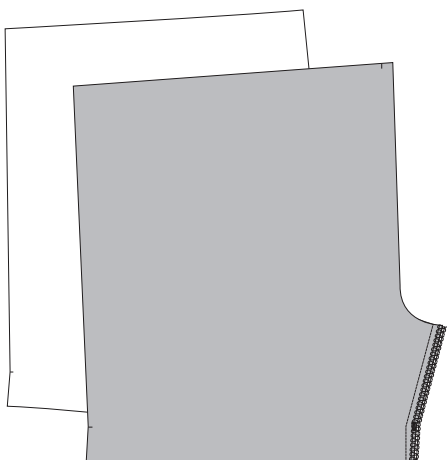

3 - Repeat for other side. Then press with seam allowance going towards the back.

4 - To ensure a very flat finish topstitch down seam. You could use 2 rows of straight stitch or use a twin needle.

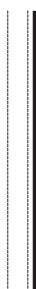

5 - In preparation for buttonholes later on in construction, add some interfacing to the wrong side of the left hand side front.

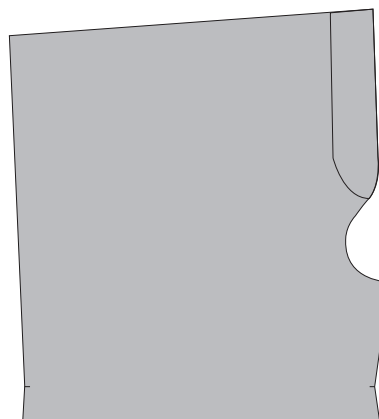

6 - Finish edges of crotch seam by overlocking or zigzagging. Do each edge separately as you don't want to stitch the fly closed.

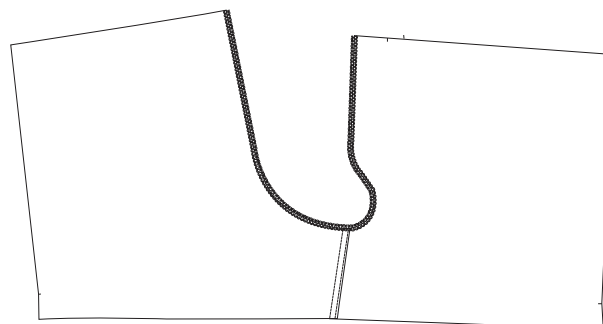
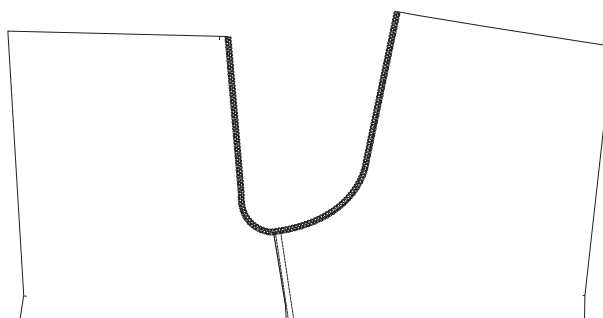

7 - With right sides together, match front and back panels together. Pin in place.

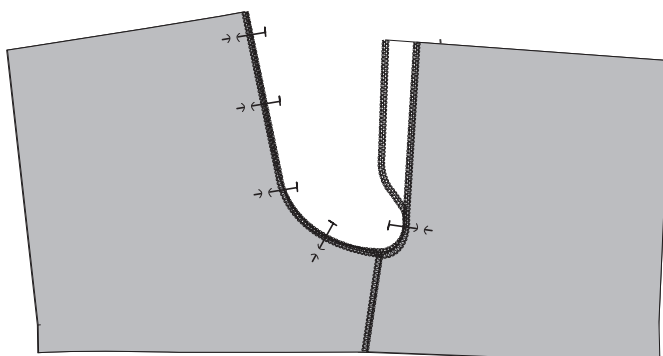

The Darcy Boxer Shorts - Sewing Instructions Page 2

8 - Straight stitch the 1cm seam allowance but finish before you reach the front fly.

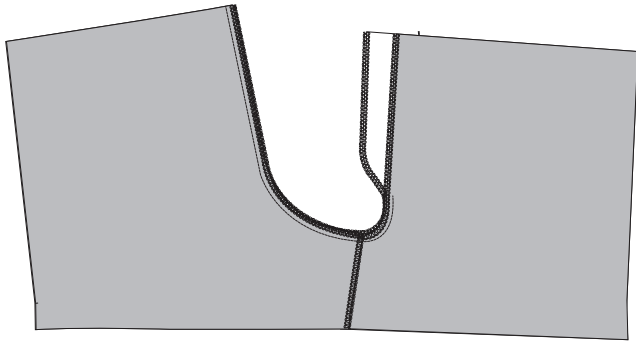

9 - Press both seams to the left hand side and topstitch down to achieve a flat seam.

10 - On fly, iron interfacing on wrong side of fabric.



11 - Fold fly in half, right sides together.

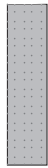

12 - On cut edge fold back by 1cm and press in place.

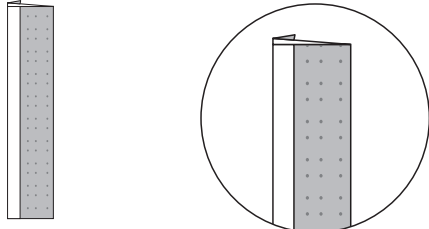

13 - On bottom edge stitch from centre fold to press line of turn back.

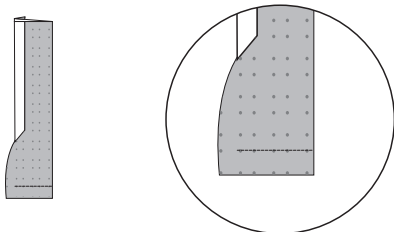

14 - Clip corner.

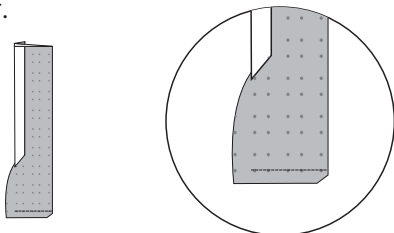

15 - Turn right way out, make sure the bottom corner has a nice point to it, a chopstick can be a handy point turning tool.

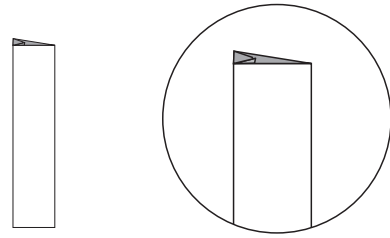

When the fly is turned the right way round, the 1cm turnbacks you pressed in place should be neatly tucked to the inside of the fly.

16 - The fly is now going to be attached to the front right hand side panel using a sandwich technique. Start by matching the top of the fly to the top of the right panel at centre front.

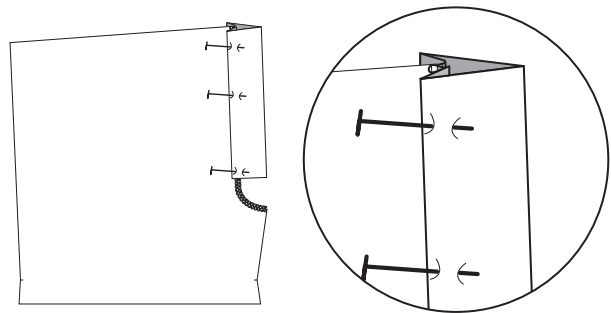

The front panel should now be tucked inside the fly and pinned in place.

17 - topstitch through all the layers to secure it in place.

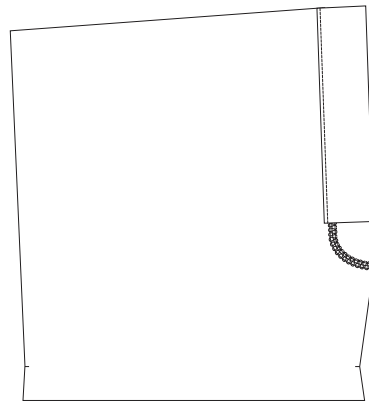

18 - On left hand side front panel prepare for other side of fly.

Fold back fly facing to create a straight line at centre front. Press in place using an iron.

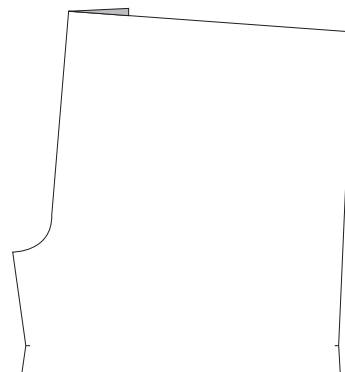

The Darcy Boxer Shorts - Sewing Instructions Page 3

19 - Topstitch fly facing into place following the curve at the bottom of the fly.

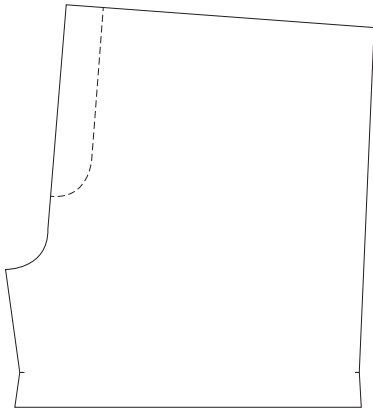

20 - Mark spaces for buttons and buttonholes and then stitch buttonholes into the left hand side fly.

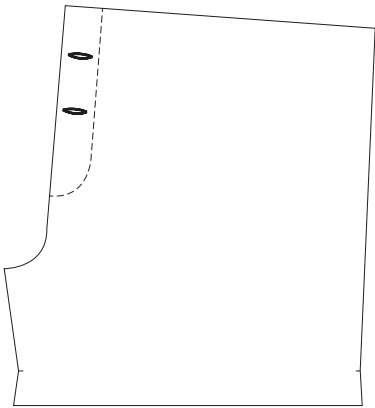

21 - Joining the fly. Place left hand side over right hand side. Ensure the centre front's line up. Pin in place.

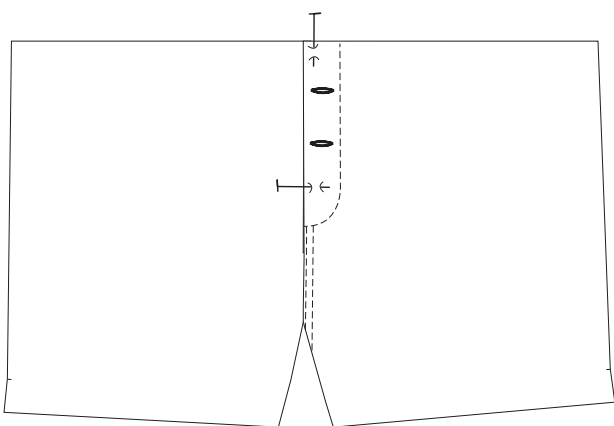

22 - At bottom of fly, add a line of straight topstitching. This will go through all layers. It creates the bottom of the opening of the fly so be sure to securely stitch at the beginning and the end of the line of stitching

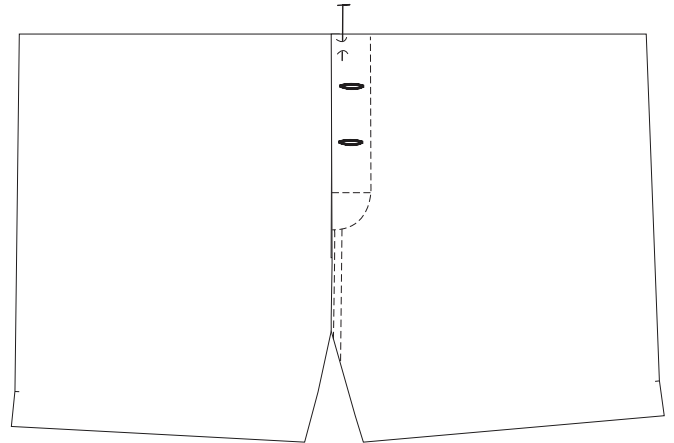

23 - Cut open buttonholes and position buttons on underside.
Hand or machine stitch buttons into place and then button up your fly.

Finish the raw edges of your side seams by overlocking/serging or zigzagging. Do each raw edge separately.

Side seams, with right sides together, match the side seams and pin in place.

Measure 7cm up from bottom edge. Mark with a pin.

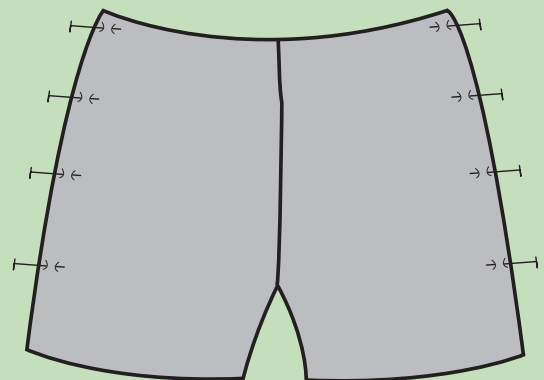

Straight stitch side seam with a 1cm seam allowance. You will be stitching from the top down the the pin at the 7cm mark and stopping at that point.

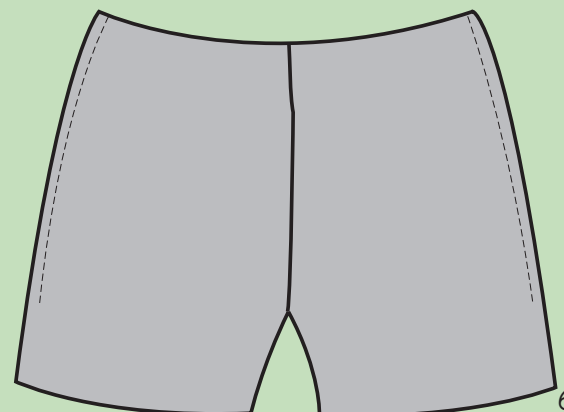

The Darcy Boxer Shorts - Sewing Instructions Page 4

24 - Side seam with right sides together, match the side seams and pin in place.

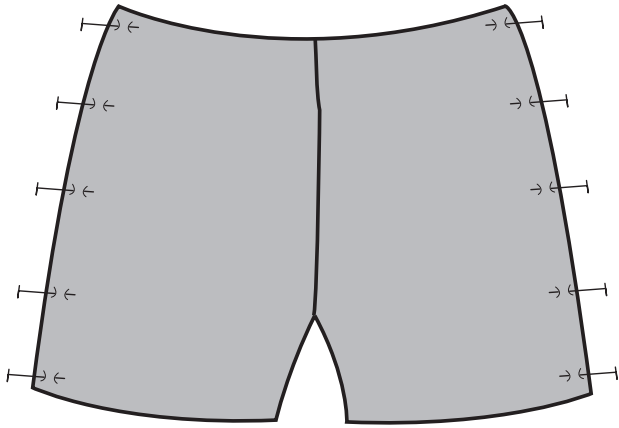

25 - Straight stitch side seams with 1cm seam allowance. Finish raw edges by overlocking/serging or zig zagging. Press seams towards the back.

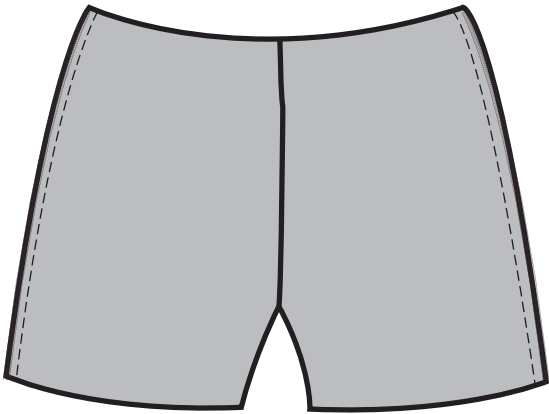

Press seams open.

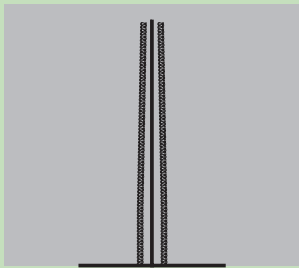

Using a straight stitch, topstitch up past the 7cm mark, across and down the other side to create a neat split in the side hem of your boxer.

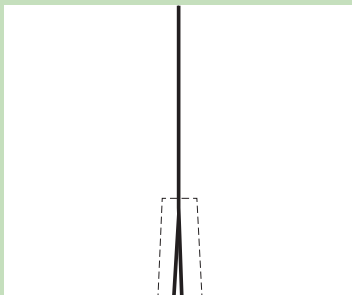

Repeat for opposite side

26 - Neaten raw edges of leg openings by zig zag stitching or overlocking/serging. Turn up 1.5cm hem and press or pin in place. Then straight stitch hem starting from the inside leg.

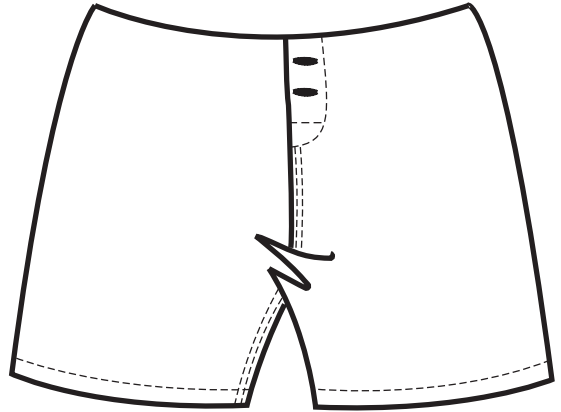

Neaten raw edges of leg openings by zig zag stitching or overlocking/serging.

Turn up 2.5 cm hem and press or pin in place. Then straight stitch hem.

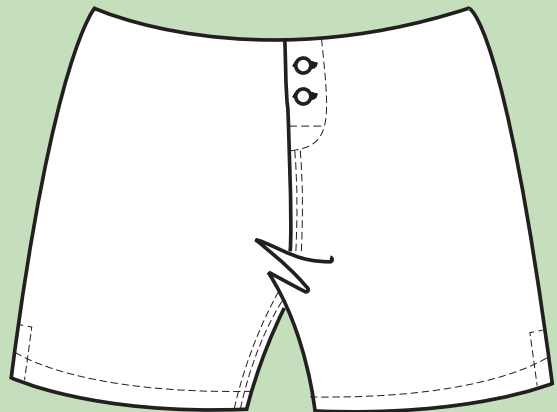

27 - Neaten top opening by zig zagging/overlocking/serging the raw edge.

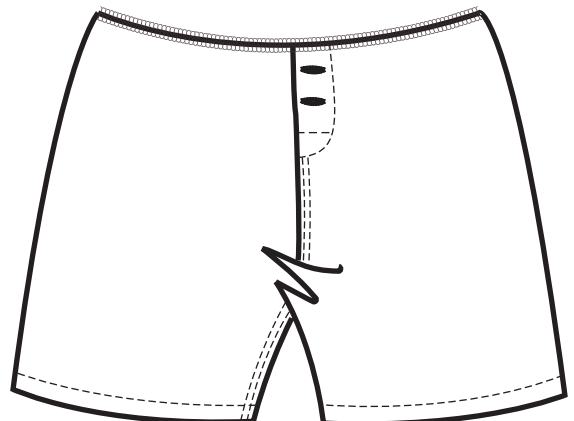

The Darcy Boxer Shorts - Sewing Instructions Page 5

28 - Cut elastic for waistband. Fold elastic in half and half again. Use pins to mark the fold points and divide your elastic into quarters.

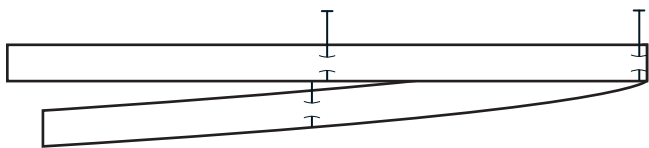

29 - Take open ends of elastic and butt them together, using a zig zag stitch securely stitch them together so they cannot come apart.

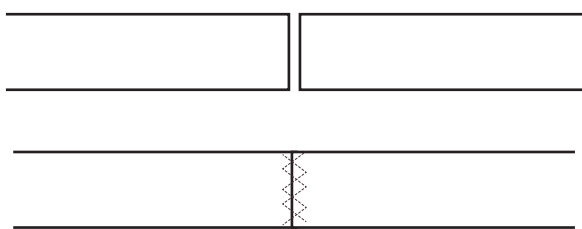

The women's elastic will be 6mm wide elastic or underwear elastic. Instead of butting it together, cut it slightly longer and overlap for a softer finish.

At waist fold over 1cm of fabric to the inside and press.

Starting from the centre back pin the elastic to the inside. Using the 4 pins, pin one to the side seam, one at centre front, the next side seam.

On the right side of the fabric you are going to topstitch the elastic in place.

Starting at the centre back using a 3 step zig zag stitch stretch the elastic and stitch in place.

Be careful to not stretch the fabric, only stretch the elastic. Stretch only as far as the next pin, topstitch that section and move on.

By going quarter by quarter you will get a much better distribution of gather and it makes it easier to sew as well.

Continue stretching the elastic and stitching it to the top edge until you have gone all the way around.

When you reach the centre back, securely end your stitching by reversing then going forward again.

30 - Pin the elastic on the right side of The Darcy Boxer Shorts ensuring you have covered the overlocking/zig zag stitch. You want the elastic to overlap the top by approximately 1cm.

Starting at the centre back seam, secure the elastic to the garment, lining up the elastic over the edge of fabric.

Stretch the elastic and stitch in place along the edge using a three step zig zag stitch.

Be careful to not stretch the fabric, only stretch the elastic.

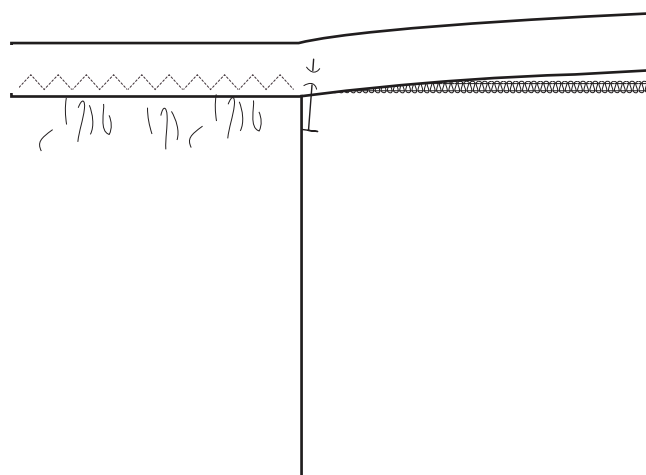

Continue until elastic is attached to entire opening. Once you get to that pin you can move along to the next pin and stretch and stitch again.

By going quarter by quarter you will get a much better distribution of gather and it makes it easier to sew as well.

Continue stretching the elastic and stitching it to the top edge until you have gone all the way around.

When you reach the centre back, securely end your stitching by reversing then going forward again.

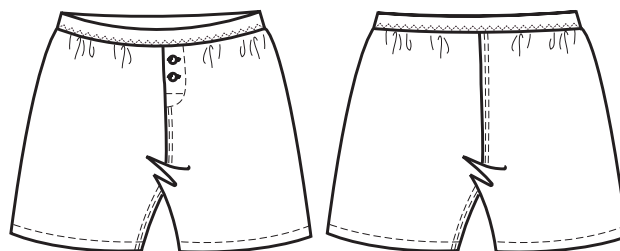

31 - Your boxer shorts are done!

Why not take a look at The Designer Manual for more ideas and inspiration?

**M E A S U R E
T W I C E**

**C U T
O N C E**

We'd love to see your wonderful creations!
Why not share them with us on

Instagram

@_MeasureTwiceCutOnce

Twitter

@_MeasureTwice

See variations of The Darcy Boxer Shorts on Pinterest

Pinterest

measuretwicec1

and keep in touch via

www.measuretwicecutonce.com.au

