

The Dwelling Places of God on Earth

- The Wilderness Tabernacle – God present
 - *The Garments of the High Priest*
 - *The Temple Services – the Sacrifices*
- Solomon's Temple – The 1st Temple – God present
- Temple of Ezra & Zerubbabel – God not present
- Herod's Rebuilt Temple – The '2nd' Temple – God not present
- The Church – God present
- The Millennial Temple - Ezekiel 40-48 – God present

Dwelling Places of God in Scripture

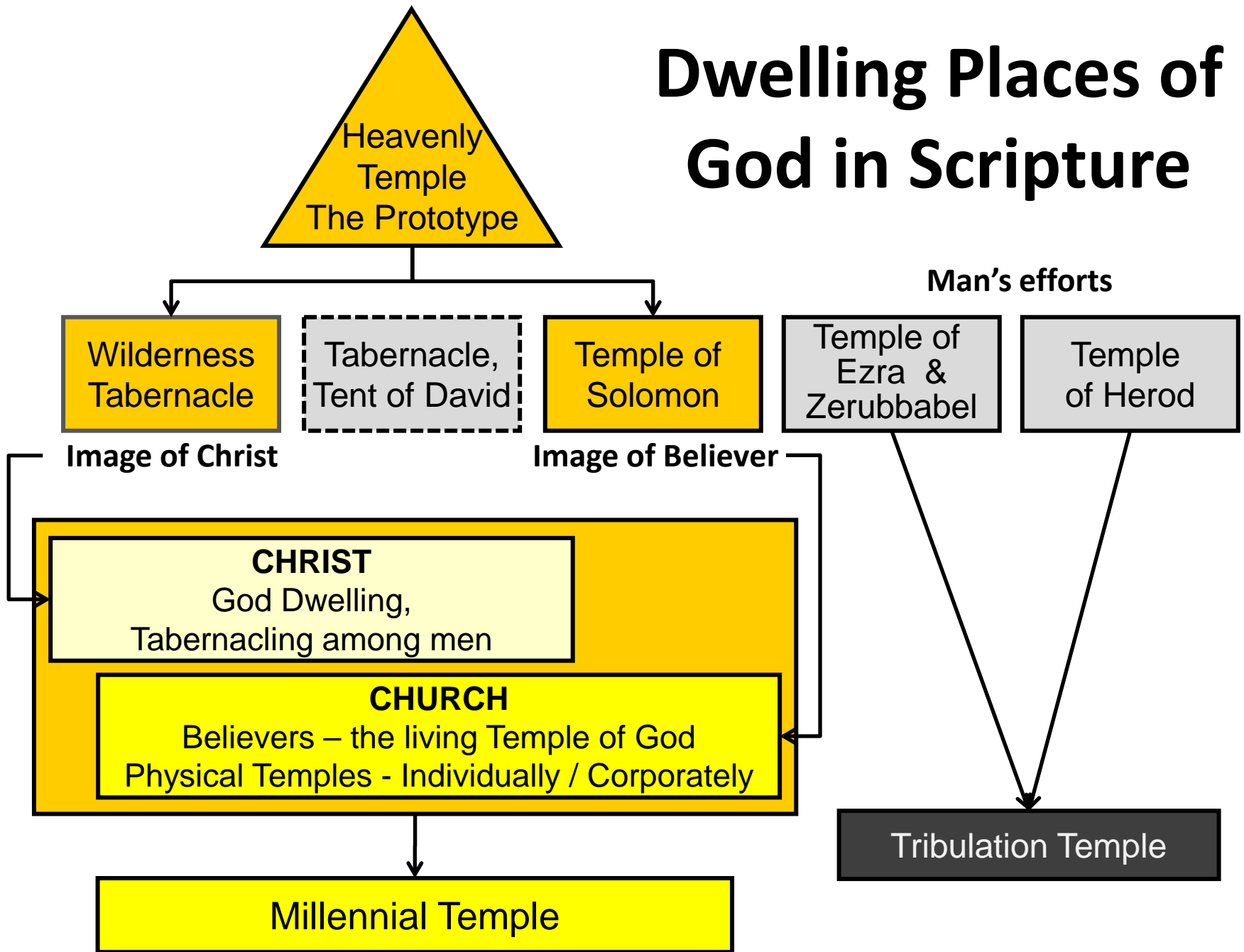

The Tabernacle



*“The Word was made flesh
and tabernacled among us...”*

John 1:14

The Tabernacle

Layer of Badger's Skin
Layer of Ram's Skin
(Ex. 26:14)

BRAZEN LAYER (basin)
Christ's cleansing truth (The Word)
(Ex. 30:18, Jn. 13:5)

BRAZEN ALTAR
OF BURNT OFFERING
(Christ's atonement)
(Ex. 27:1, Jn. 1:29)

175'

THE OUTER COURT
White Linen

90'

EAST'

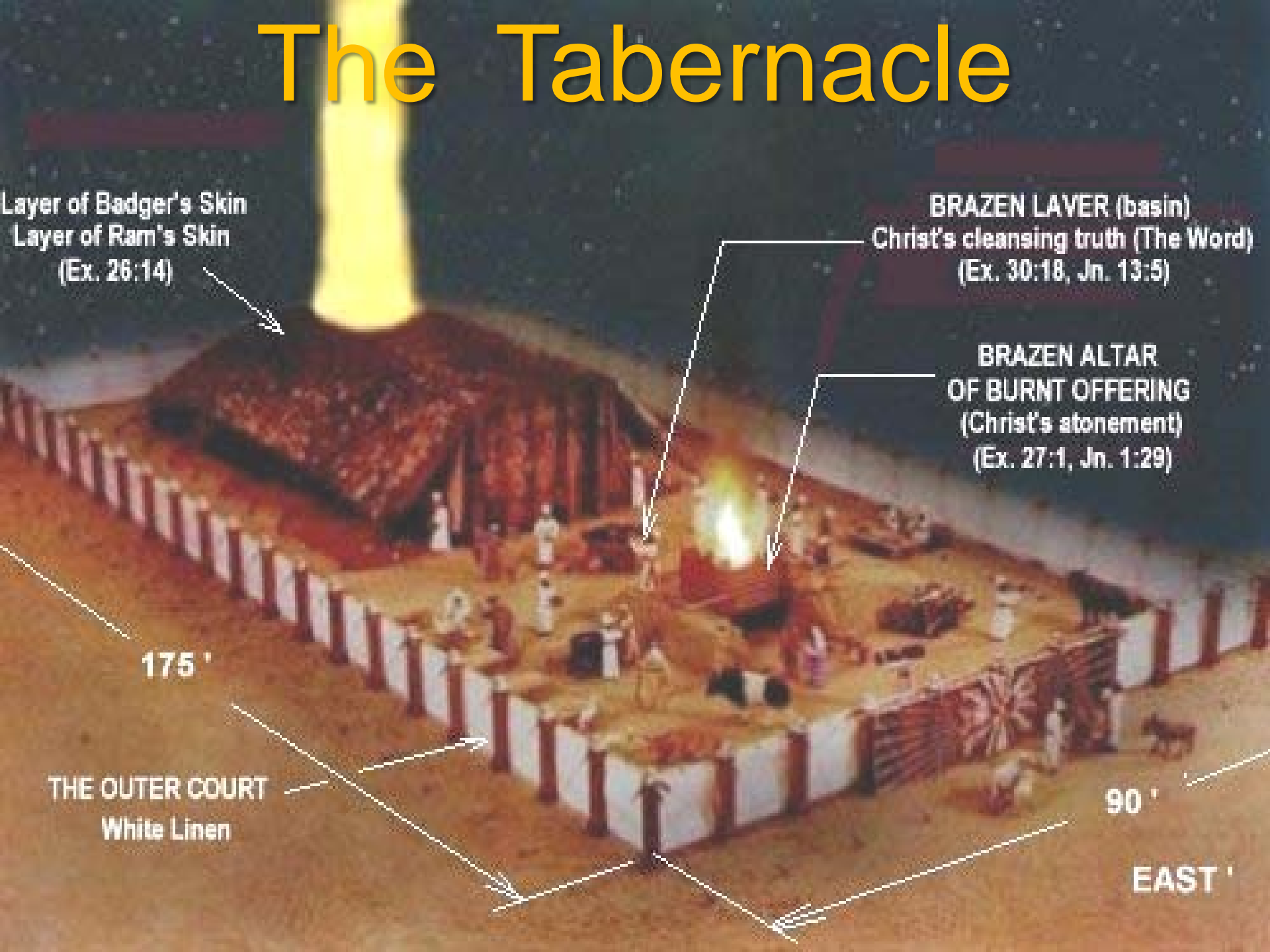

“WILDERNESS TABERNACLE”

Designed by God

1. Introduction
2. Fellowship of the Tabernacle
3. Relative Positions
4. General Construction
5. Silver Sockets
6. The Boards and Bars
7. The Curtains and Coverings
8. The Court and Gate
9. The Pillar of Cloud and Fire
10. The Bronze Altar
11. The Bronze Laver
12. The Golden Lampstand
13. The Table of Showbread
14. The Altar of Incense
15. The Veil
16. The Ark of the Covenant
17. The Mercy Seat
18. The Cheribim
19. The Shekinah
20. The Two Tablets of Stone
21. The Golden Pot of Manna
22. Aaron's Rod that Budded
23. The Journeys of the Ark
 1. From Sinai to Philistia
 2. From Philistia to the Temple

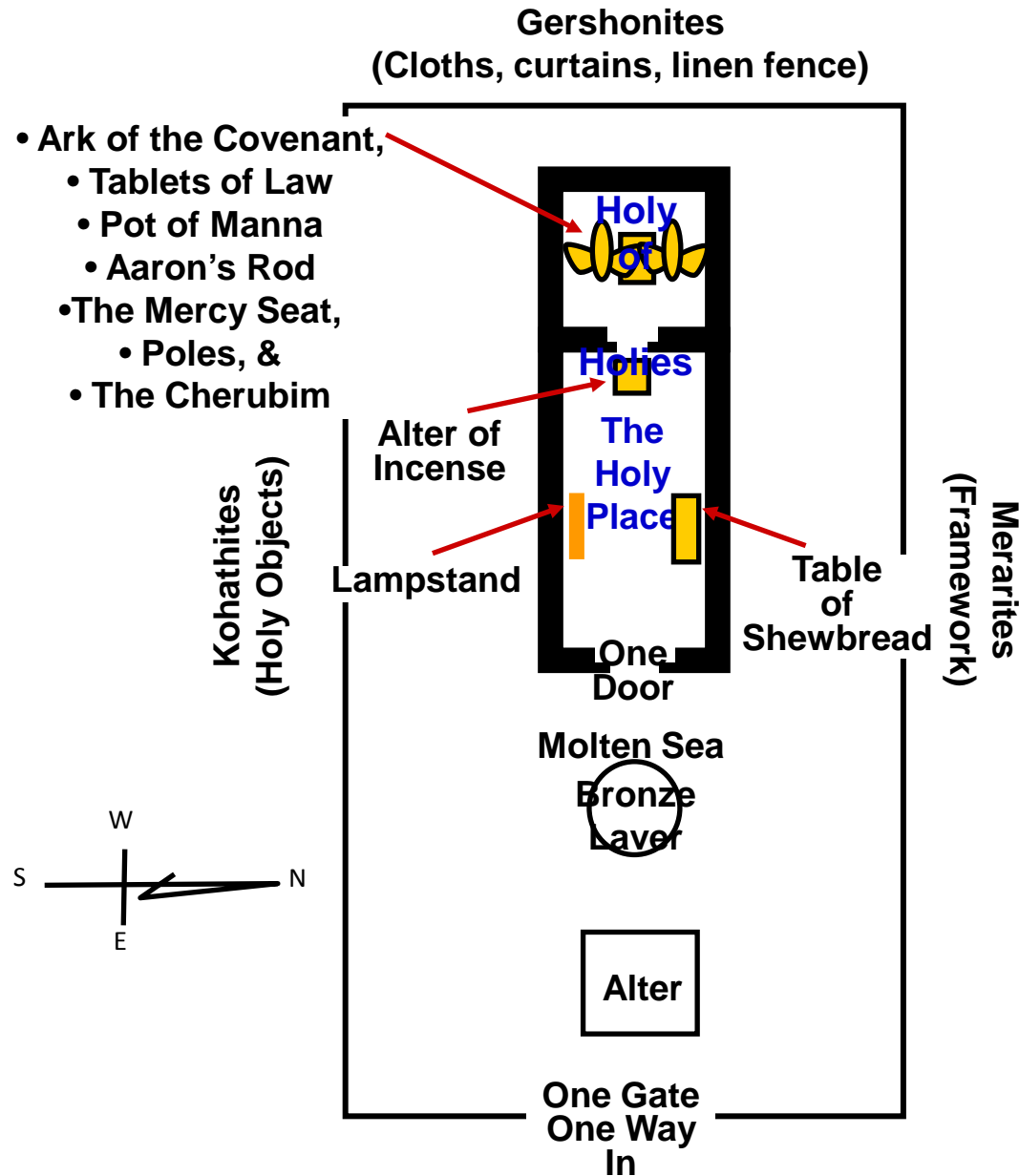

[Back to Layout](#)

Moses and the Priests

“The Word was made flesh and *tabernacled* among us...” John 1:14

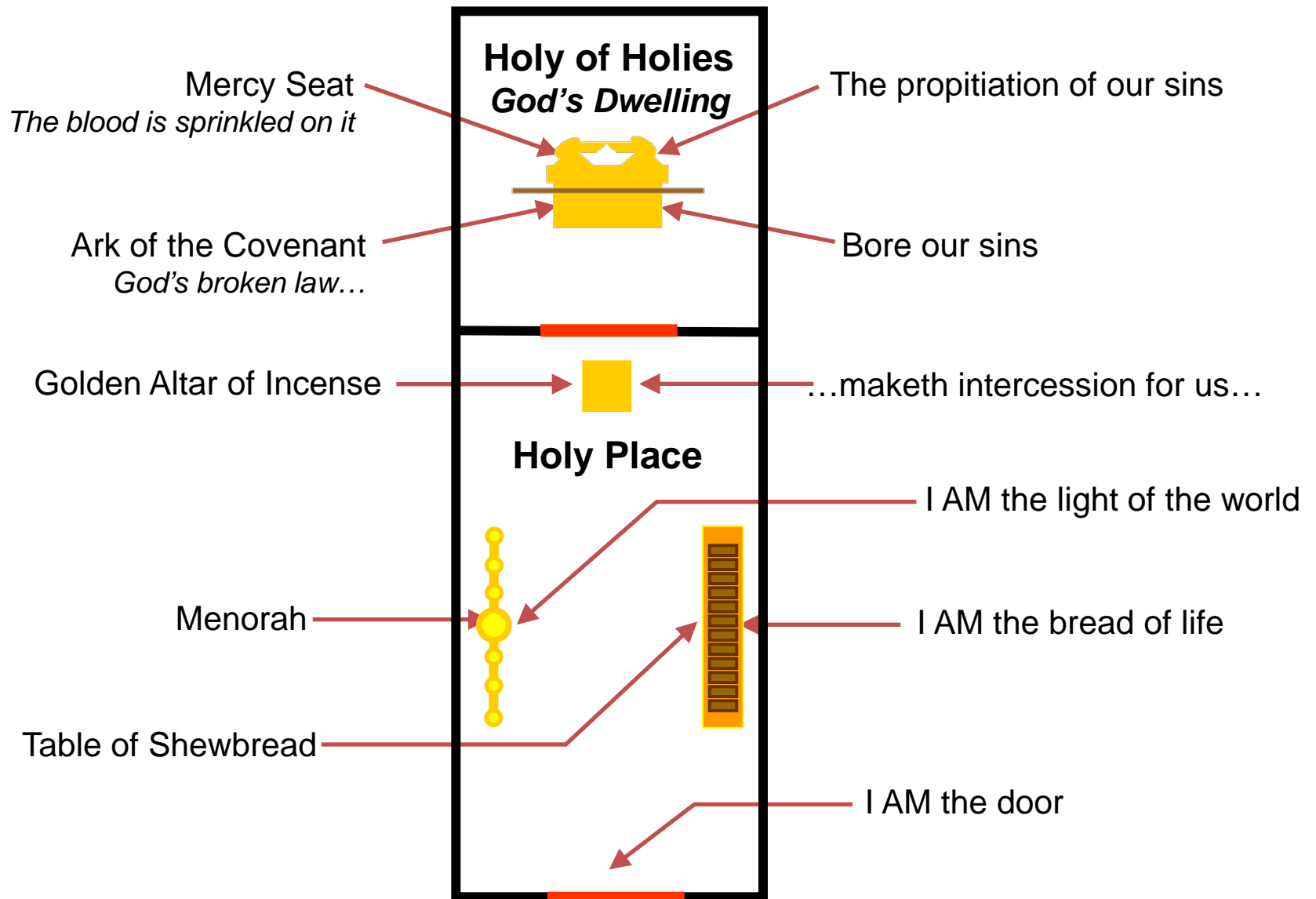

The Wilderness Tabernacle

The Tabernacle

The new religious observances taught by Moses in the desert centered on rituals connected with the tabernacle, and amplified Israel's sense of separateness, purity and oneness under the Lordship of Yahweh.

A few desert shrines have been found in Sinai, notably at Serabit el-Khadem and at Timnah in the Negev, and show marked Egyptian influence.

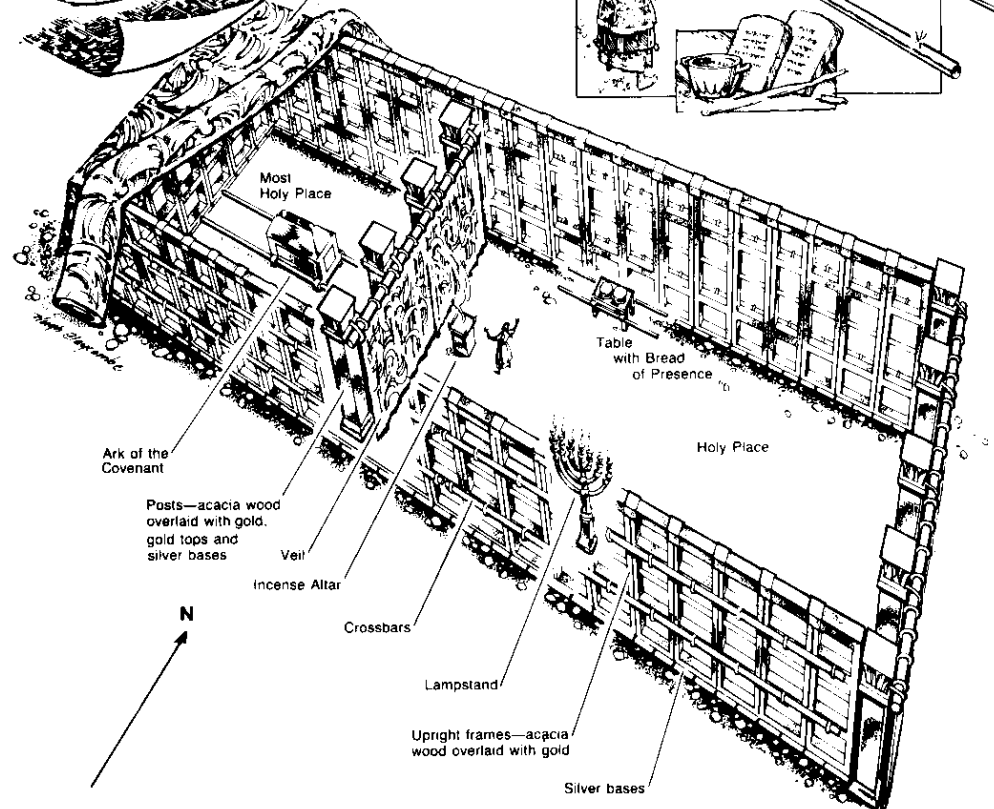
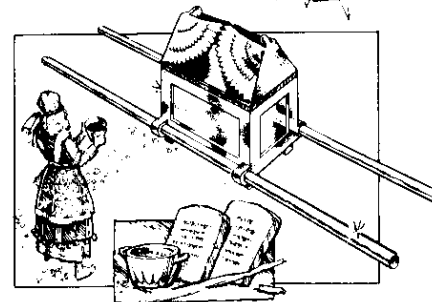
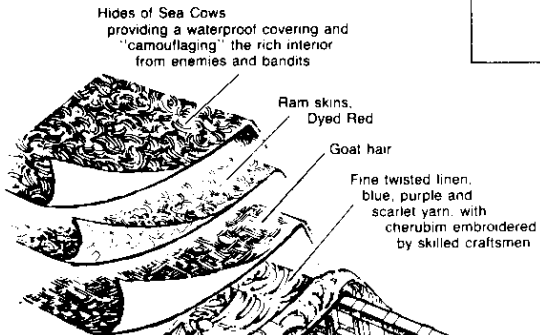
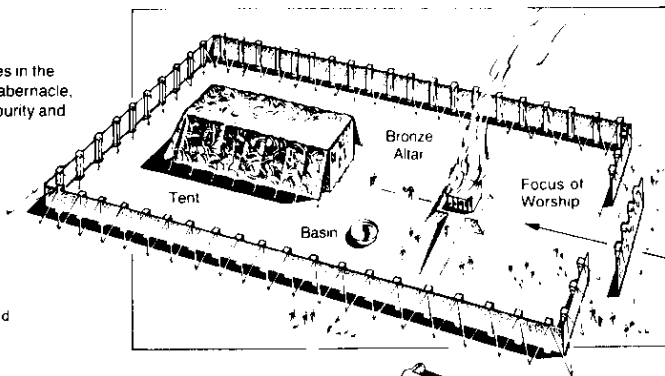

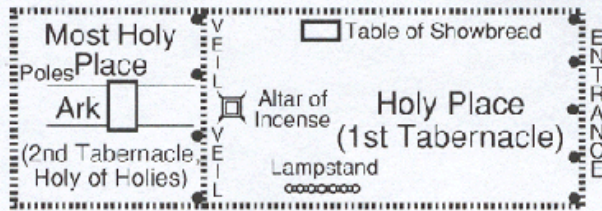

Tabernacle



Gate

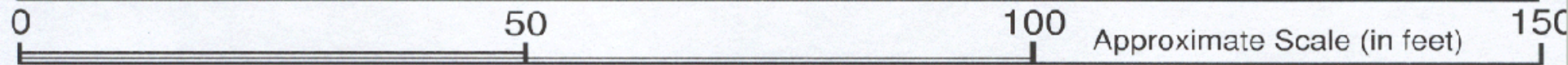

Drawn to Scale

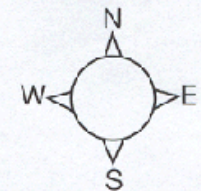

∞

The Wilderness Tabernacle

Copyright 1996 Son Light Publishers, Inc., Ft. Smith, Arkansas

5/11/2013

Wilderness Tabernacle

'every part and place has
a purpose and meaning...'

Kohathites
(Holy Objects)

75' x 150'
Perimeter = 450' =
Length of Ark (short cubit)

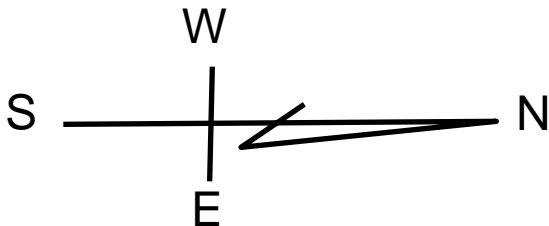

Gershonites
(Cloths, curtains, linen fence)

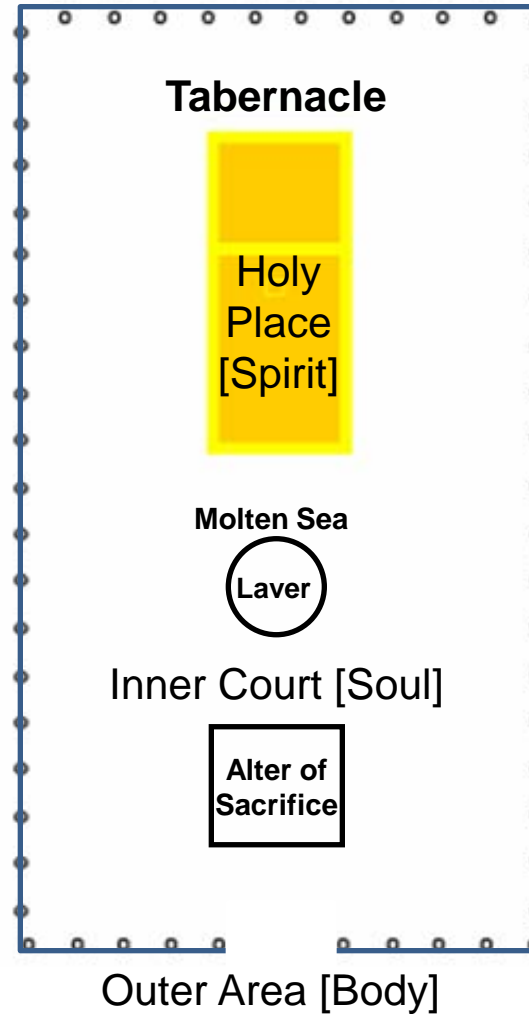

Merarites
(Framework)

Moses and the Priests

The Camp of Israel

Numbers 1-2

West The Camp of Ephraim (**Ox**)

Ephraim	40,500
Masasseh	32,200
Benjamin	35,400

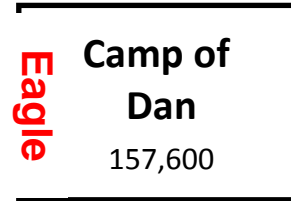
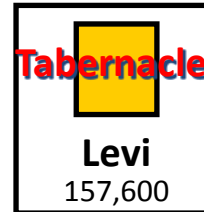
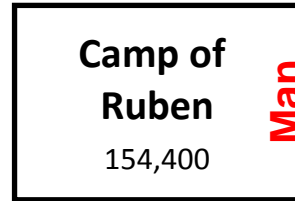
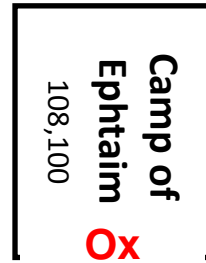

North

The Camp of Dan (**Eagle**)

Dan	62,700
Naphtali	53,400
Asher	41,500

Lion

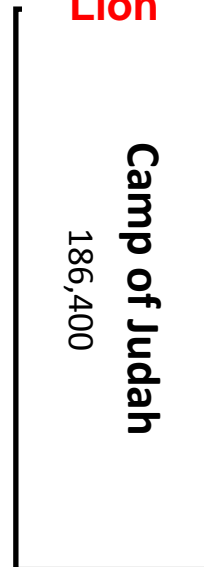

East The Camp of Judah (**Lion**)

Judah	74,600
Issachar	54,400
Zebulon	57,400

South

The Camp of Ruben (**Man**)

Ruben	46,500
Simeon	59,300
Gad	45,600

[Back to Layout](#)

The Bronze Altar - Sacrifice

Exodus 27:1-8. Exodus 38:1-7. Exodus 20:24-26.

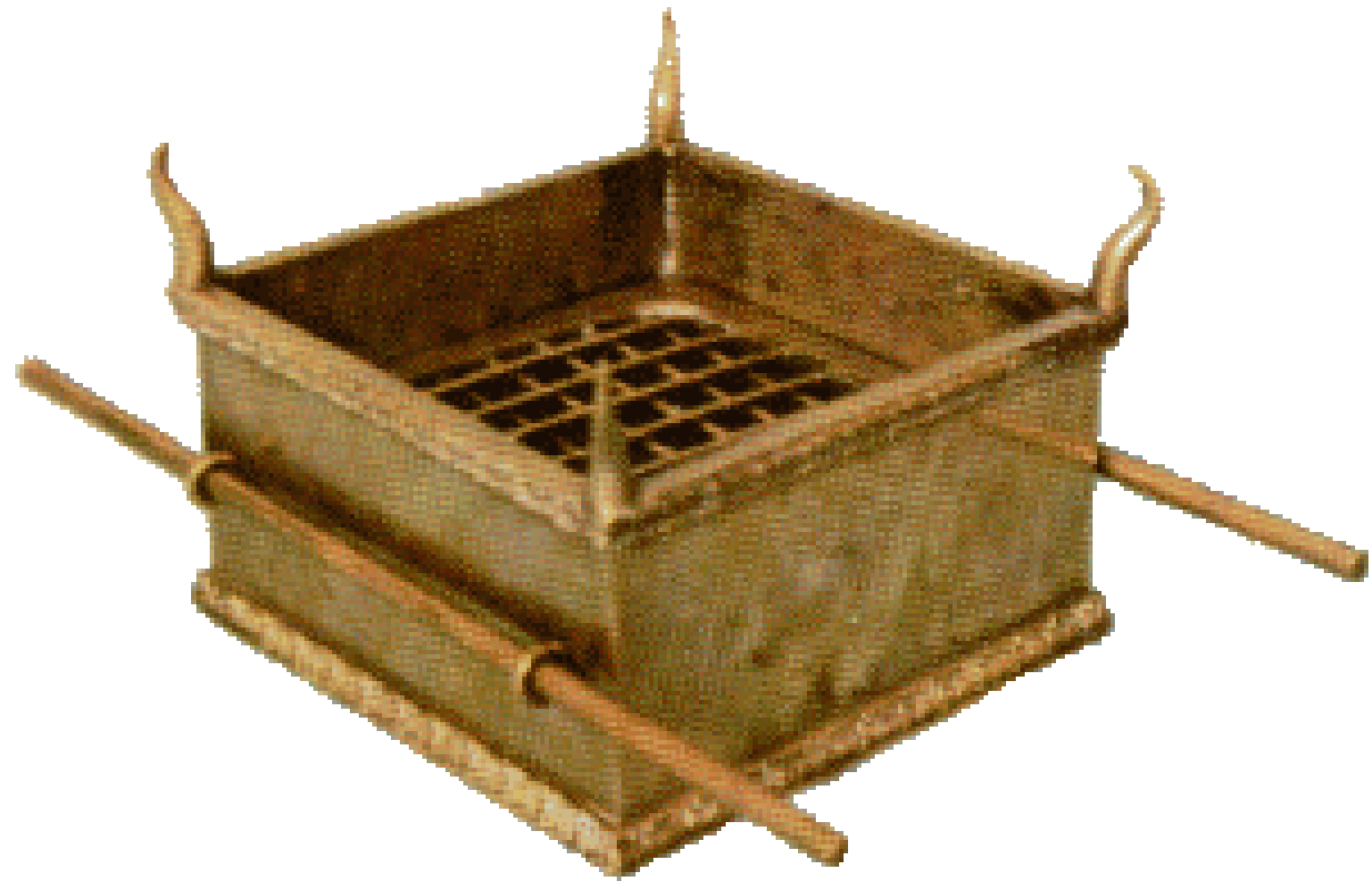

The Bronze Laver

Exodus 30:17-21. Exodus 38:8. Exodus 40:7.



The Golden Lampstand

Ex 25:31-40; 37:17-24; 39:37 Jer 52:19 Dan 5:2-5 Rev 1:12,20



One of ten Lampstands

[Back to Layout](#)

Spoils of Jerusalem carving

The Arch of Titus - Rome



The Menorah on the Arch of Titus, Rome

Spoils of Jerusalem carving

Menorah – Golden Lampstand

Alter of Incense – Golden Alter

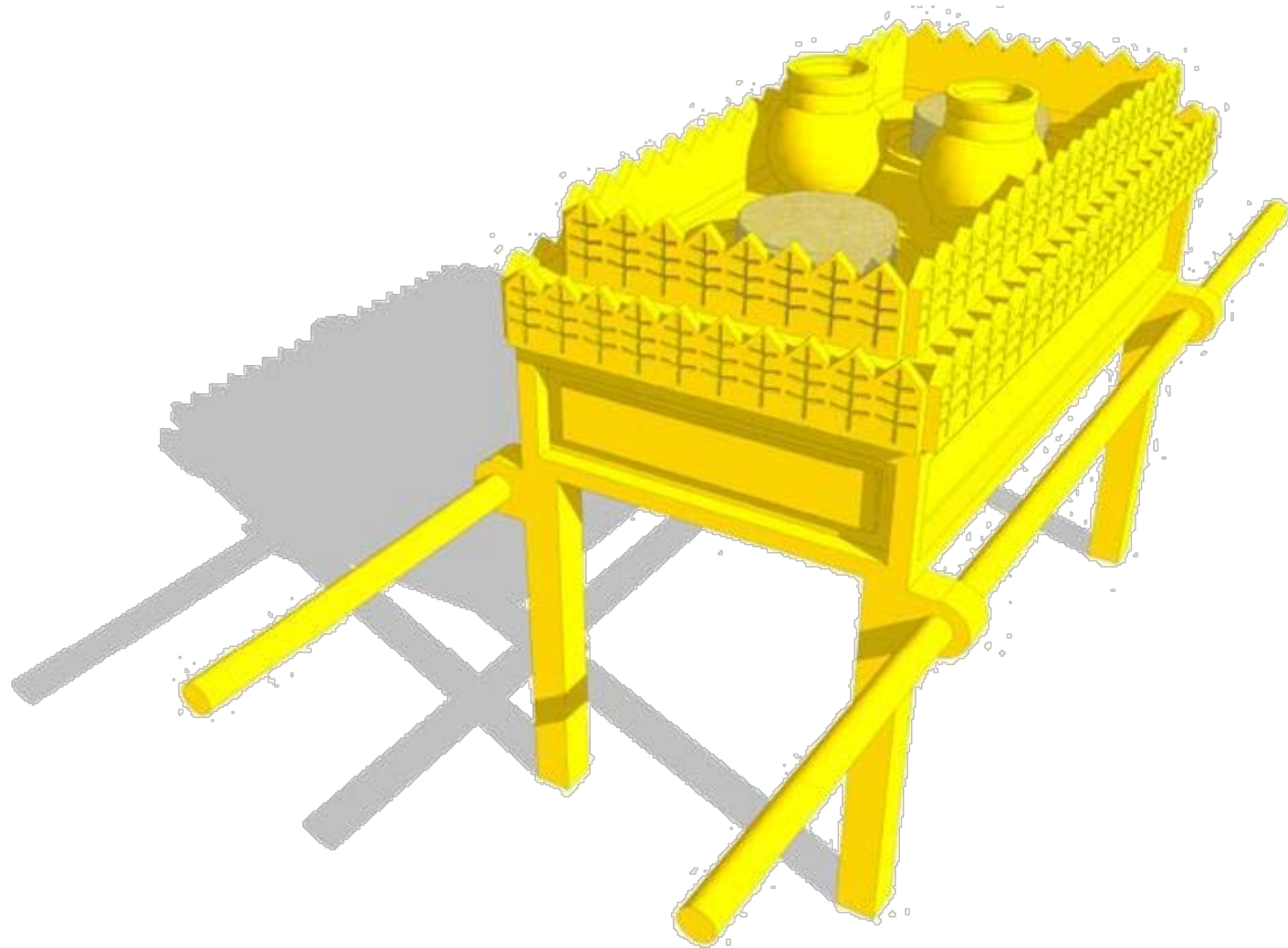

Table of ShewBread is in there somewhere

[Back to Layout](#)

The Table of Showbread

Exo 25:23-30; 31:8; 37:10-16 Lev 24:5-9 Heb 9:2



The Altar of Incense

Exodus 30:1-10; 37:25-29; 30:34-38.



[Back to Layout](#)

The Veil

Exodus 26:31-37. Mark 15:38. Hebrews 9 -10



[Back to Layout](#)

The Ark of the Covenant

The Mercy Seat The Cherubim

Exodus 25:10-22; 37:1-9.



Shekinah: God's Glory

Exodus 25:10-22; 37:1-9.



Contents of the Ark of the Covenant



The Two Tablets of Stone

Exodus 19; 20:1-17. Matthew 22:36-40.



The Golden Pot of Manna

Ex 16:11-36 Nu 11:1-9 Ps 78:24-25 John 6:31-58 Rev 2:17



Aaron's Rod that Budded

Numbers 16 and 17.



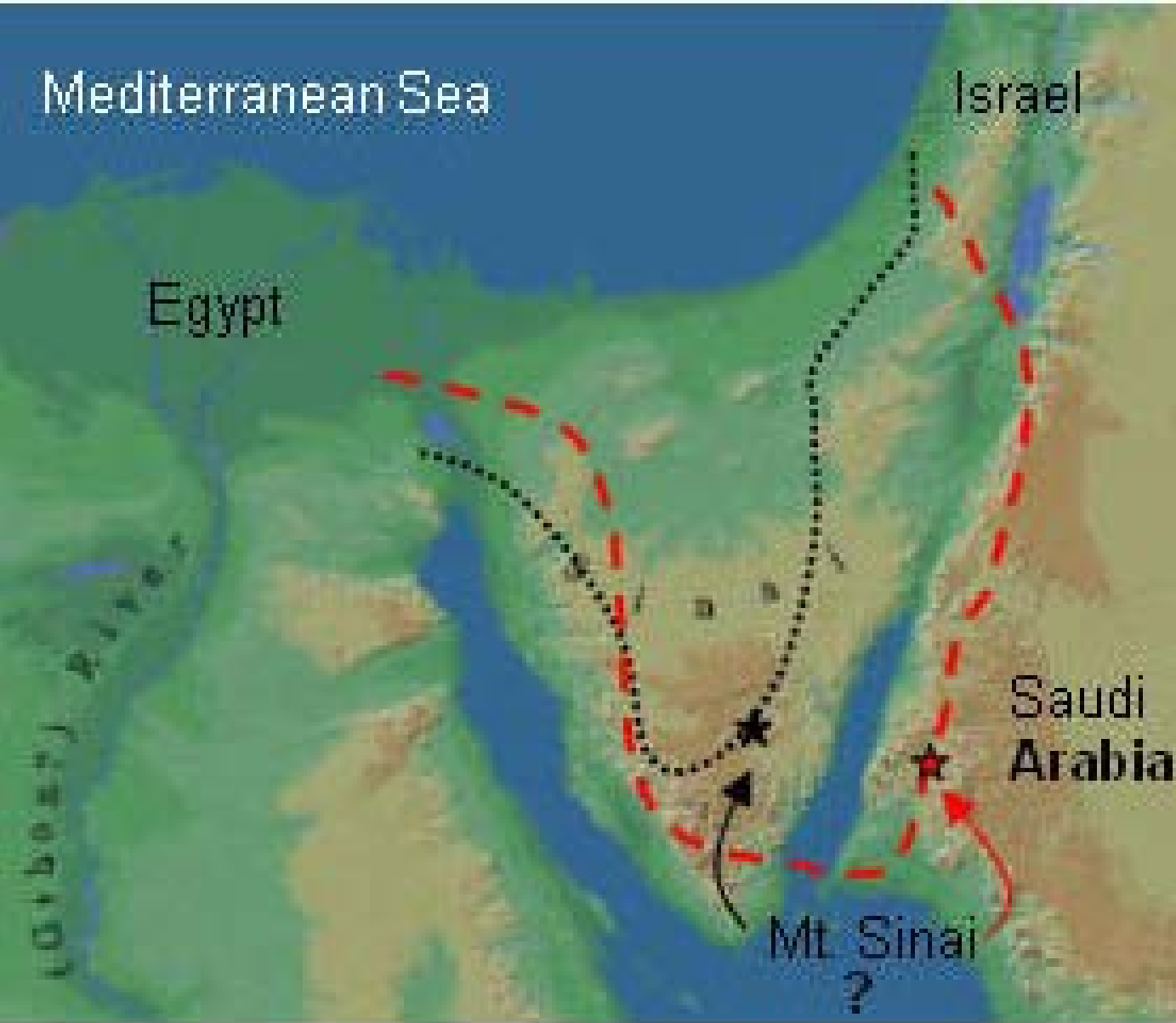

The Journeys of the Ark From Sinai to Philistia

*Exo 25, 40;
Nu 3-4, 10, 14;
Josh 3-4, 6-7;
1Sa 3-4; Ps 132*

- Traditional Route
- - - - - Alternate Route

Exodus Route Map

Steve Rudd
March 11, 2007

Mediterranean Sea

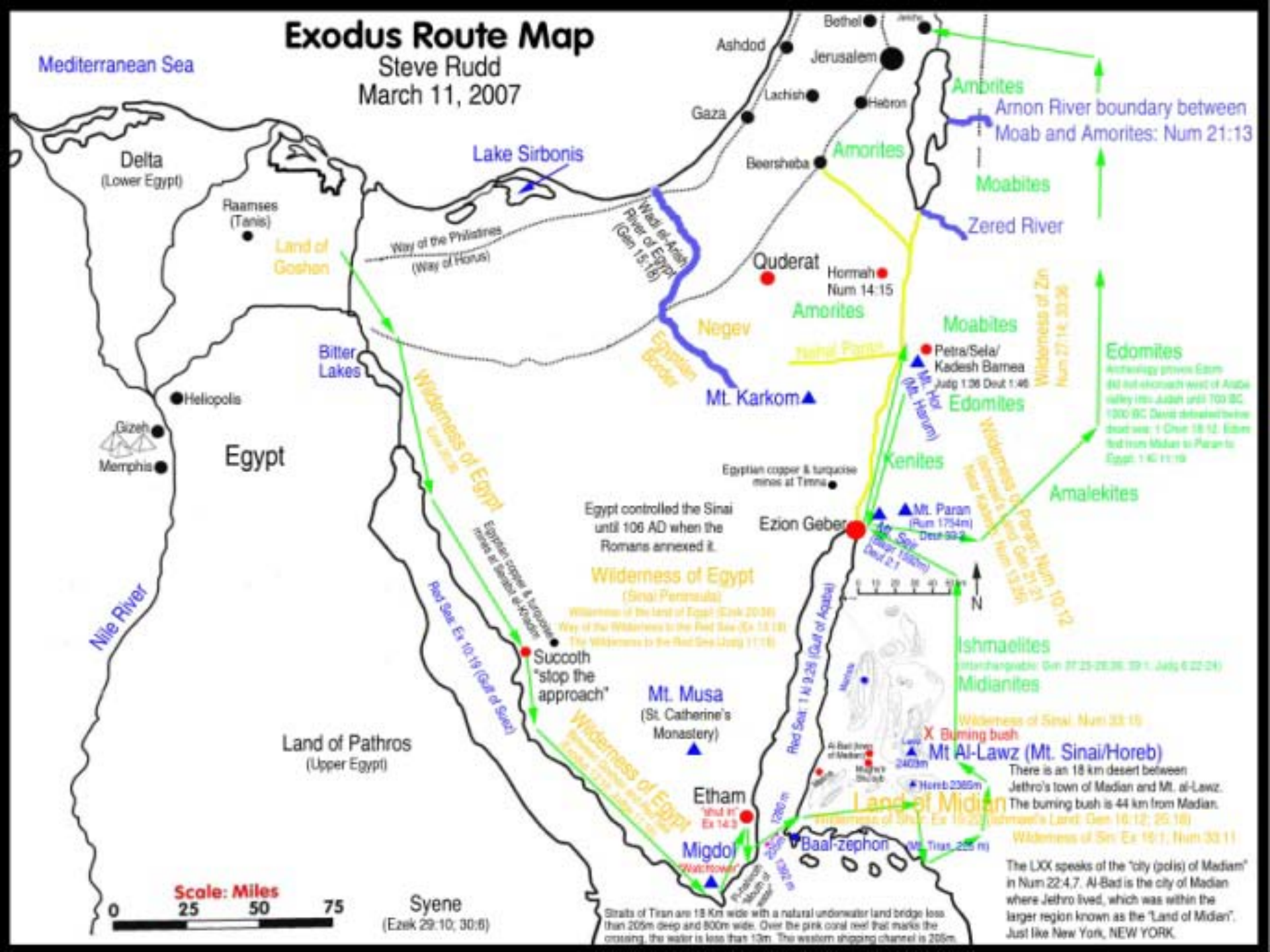

Delta (Lower Egypt)

Raamses (Tanis)

Land of Goshen

Way of the Philistines (Way of Horus)

Lake Sirbonis

Wadi of Ashdod (Pillar of Egypt) (Gen 15:18)

Ashdod
Jerusalem
Lachish
Gaza
Beersheba

Amrites

Arnon River boundary between Moab and Amorites: Num 21:13

Moabites

Zered River

Quderat

Hormah Num 14:15

Negev

Amorites

Moabites

Petra/Sela/ Kadesh Barnea

Jug 1:36 Deut 1:46

Edomites

Wilderness of Zin Num 27:14, 33:36

Edomites

Archaeology proves Edom did not stretch west of Arabah valley into Judah until 700 BC, 1200 BC David defeated twice: 1 Chr 18:12. Edom led from Midian to Paran to Egypt: 1 Ki 11:16

Gizeh

Memphis

Egypt

Bitter Lakes

Wilderness of Egypt

Egyptian copper & turquoise mines at Timna

Mt. Karkom

Egypt controlled the Sinai until 106 AD when the Romans annexed it.

Ezion Geber

Wilderness of Egypt (Sinai Peninsula)

Wilderness of the land of Egypt (Ex 20:36)
Wilderness of the land of Egypt (Ex 13:18)
Way of the Wilderness to the Red Sea (Ex 13:18)
The Wilderness to the Red Sea (Judg 11:16)

Mt. Paran (Sum 1754m) Deut 33:2

Mt. Sinai (Sum 2283m) Deut 2:1

Kenites

Amalekites

Ishmaelites

Midianites

Wilderness of Sinai: Num 33:16

X Burning bush

Mt Al-Lawz (Mt. Sinai/Horeb)

There is an 18 km desert between Jethro's town of Midian and Mt. al-Lawz. The burning bush is 44 km from Midian. The burning bush: Ex 16:25; Num 10:12; 25:10; 34:10; 35:10; 35:11

Wilderness of Sin: Ex 16:1; Num 33:11

The LXX speaks of the 'city (polis) of Midian' in Num 22:4,7. Al-Bad is the city of Midian where Jethro lived, which was within the larger region known as the 'Land of Midian'. Just like New York, NEW YORK.

Land of Pathros (Upper Egypt)

Mt. Musa (St. Catherine's Monastery)

Etham

'Midian' Ex 14:3

Migdol

Baal-zephon

Mt. Tiras 226 m

Strait of Tiran

Strait of Tiran

Scale: Miles 0 25 50 75

Syene (Ezek 29:10, 30:6)

Straits of Tiran are 18 Km wide with a natural underwater land bridge less than 205m deep and 800m wide. Over the pink coral reef that marks the crossing, the water is less than 13m. The western shipping channel is 205m.

Joshua and the conquest of Canaan

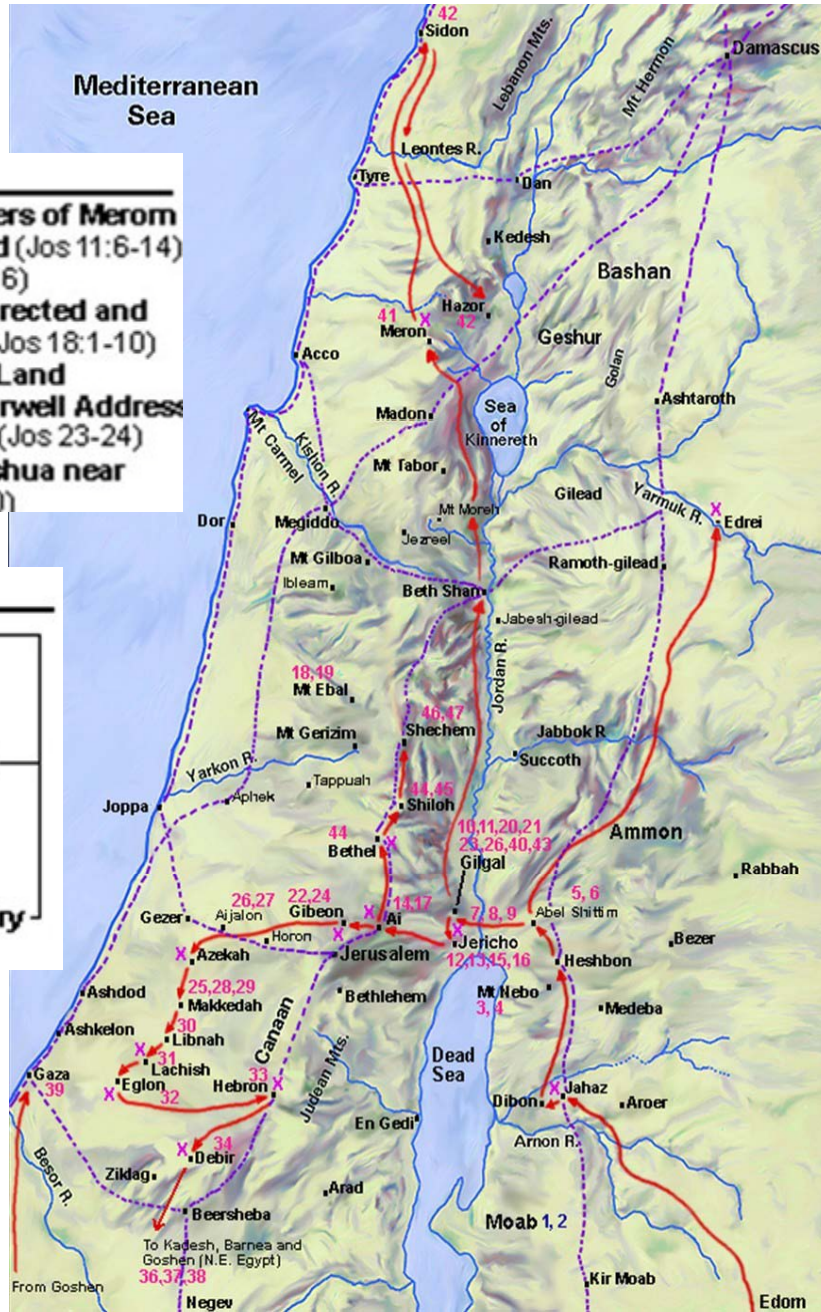

The Northern Campaign

- 41 From Gilgal to the Waters of Merom
- 42 Sidon, Hazor conquered (Jos 11:6-14)
- 43 Return to Gilgal (Jos 14:6)
- 44 To Shiloh- Tabernacle Erected and Allotments to Tribes (Jos 18:1-10)
- 45 Joshua's Men Map out Land
- 46 To Shechem-Joshua Farwell Address and Stone of Witness (Jos 23-24)
- 47 Death and Burial of Joshua near Shechem (Jos 24:29-30)

Early Journeys/Campaigns of Joshua

- 1 From Edom to Moab
- 2 Moses Appoints Joshua as Leader (Num 27:18-23)
- 3 From Plains of Moab to Mt. Nebo
- 4 Joshua Ordained as Successor to Moses (Deut 31:7-8,14)
- 5 To Shittim-God encourages Joshua (Jos 1:1-9)
- 6 Spies sent out (Jos 2:1)
- 7 To the Fords of Jordan-Orders Given About the Crossing (Jos 1:10-18)
- 8 Crossing the Jordan (Jos 3:14-17)
- 9 12 Men Bring Stones from the Riverbed (Jos 4:1-8)
- 10 To Gilgal (Jos 4:19-24)
- 11 Joshua Builds Memorial w/Stones
- 12 To Jericho-Joshua Met by the Lord Who Promises the Conquest of the Land (Jos 5:13-15 6:1-5)
- 13 Jericho Captured & Destroyed (6:6-27)
- 14 Jericho to Ai-Israel Defeated (Jos 7)
- 15 To Jericho-The Valley of Achor
- 16 Achan & Family Stoned for Disobedience (Jos 7:24-25)
- 17 To Ai-A Victorious Assault (Jos 8:1-29)
- 18 To Mt Ebal -Alter Erected
- 19 Law Written on Stone Alter (Jos 8:30-35)
- 20 To Gilgal
- 21 Gibeonites Sue for Peace (Jos 9:3-15)
- 22 To Gibeon -Treaty Made (Jos 9:16-27)
- 23 Return to Gilgal (Jos 10:6)
- 24 To Gibeon -protect them from the Amorites (Jos 10:6-10)
- 25 Joshua's Army drive Amorites to Makkedah-Lord Sends Hailstones (Jos 10:11)
- 26 To Gilgal-Valley of Aijalon
- 27 Joshua Commands Sun and Moon to Stand Still (Jos 10:12-14)
- 28 To Makkedah-Final Attack
- 29 Five Kings are Slain (Jos 10:18-28)

The Southern Campaign

- 30 To Libnah
 - 31 To Lachish
 - 32 To Gezer
 - 33 To Eglon
 - 34 To Hebron
 - 35 To Debir
 - 36 To Kadesh
 - 37 To Barnea
 - 38 To Goshen
 - 39 To Gaza and surrounding country
 - 40 Return to Gilgal (Jos 10:43)
- (Jos 10:31-42)

The Journeys of the Ark

From Philistia to the Temple

1Sa 5-7; 2Sa 6-7; 1Ki 8:1-11; 2Ki 24-25; Rev 11:19.

PASSAGE	EVENT	PLACE	APPROX DATE B.C.
1 Sam 3.3	Inside Temple	Shiloh	1145
4.3-5	Battle w/Philistines	Aphek	1105
4.11	Captured by Philistines	Aphek	1105
5.1		Ashdod	1105/04
5.8		Gath	1105/04
5.10		Ekron	1105/04
6.1		"in the fields"	1104
6.13	Philistines determine to return Ark to Israel	Beth-Shemesh	1104
7.1	Moved to House of Abinidab. His son Eleazar charged to care for it.	Kiriath-Jearim (Baal-Judah)	1104
14.18	Did it travel with Saul as he waged war?	Migron (14.2)	1027?
2 Sam 6.1	David determines to bring it to Jerusalem	Baal-Judah	1010?
6.10	After Uzzah incident, Stored for three months	House of Obededom the Gittite	1010?
6.15-23	David moves Ark to a special tent in Jerusalem	Jerusalem	1010?

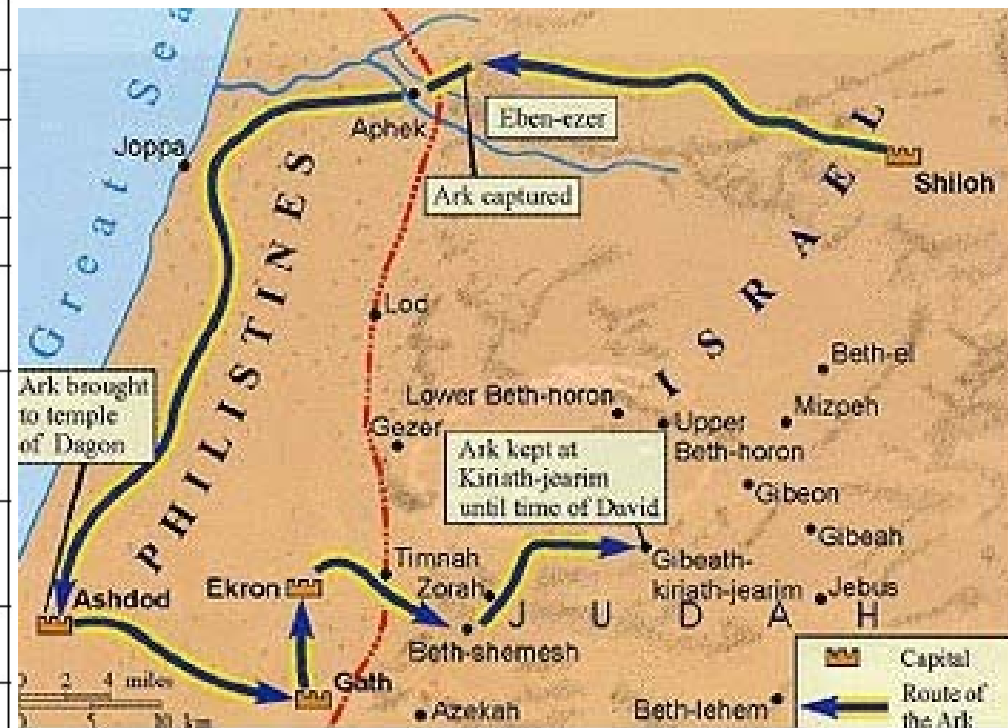

(Illustration from the book *From Sinai to Jerusalem* by Leen Ritmeyer.)

Garments of the High Priest

Exodus 28:4-42

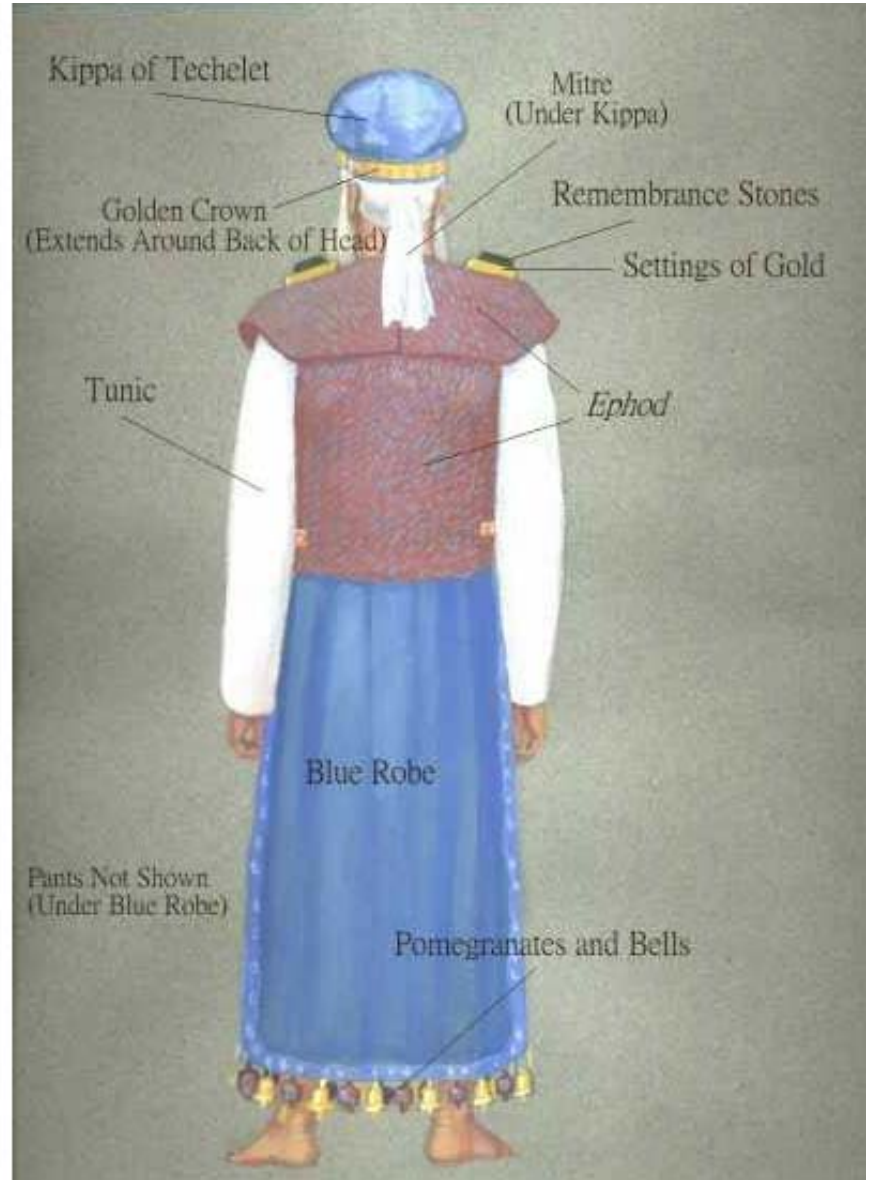

Garments of the High Priest

Breastplate.



THE TEMPLE SOLOMON BUILT

The 1st Temple

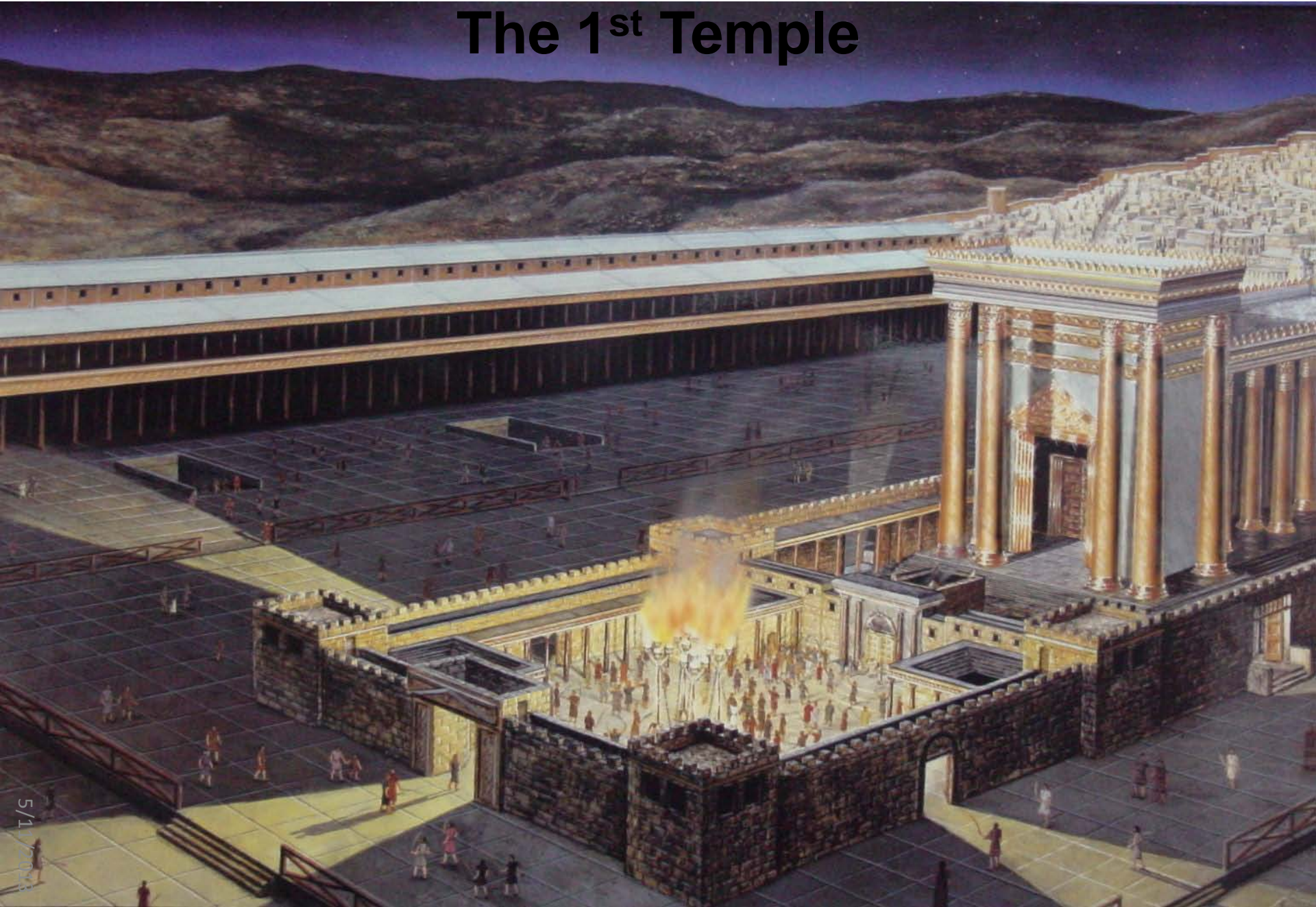

Solomon's Temple - SonLight

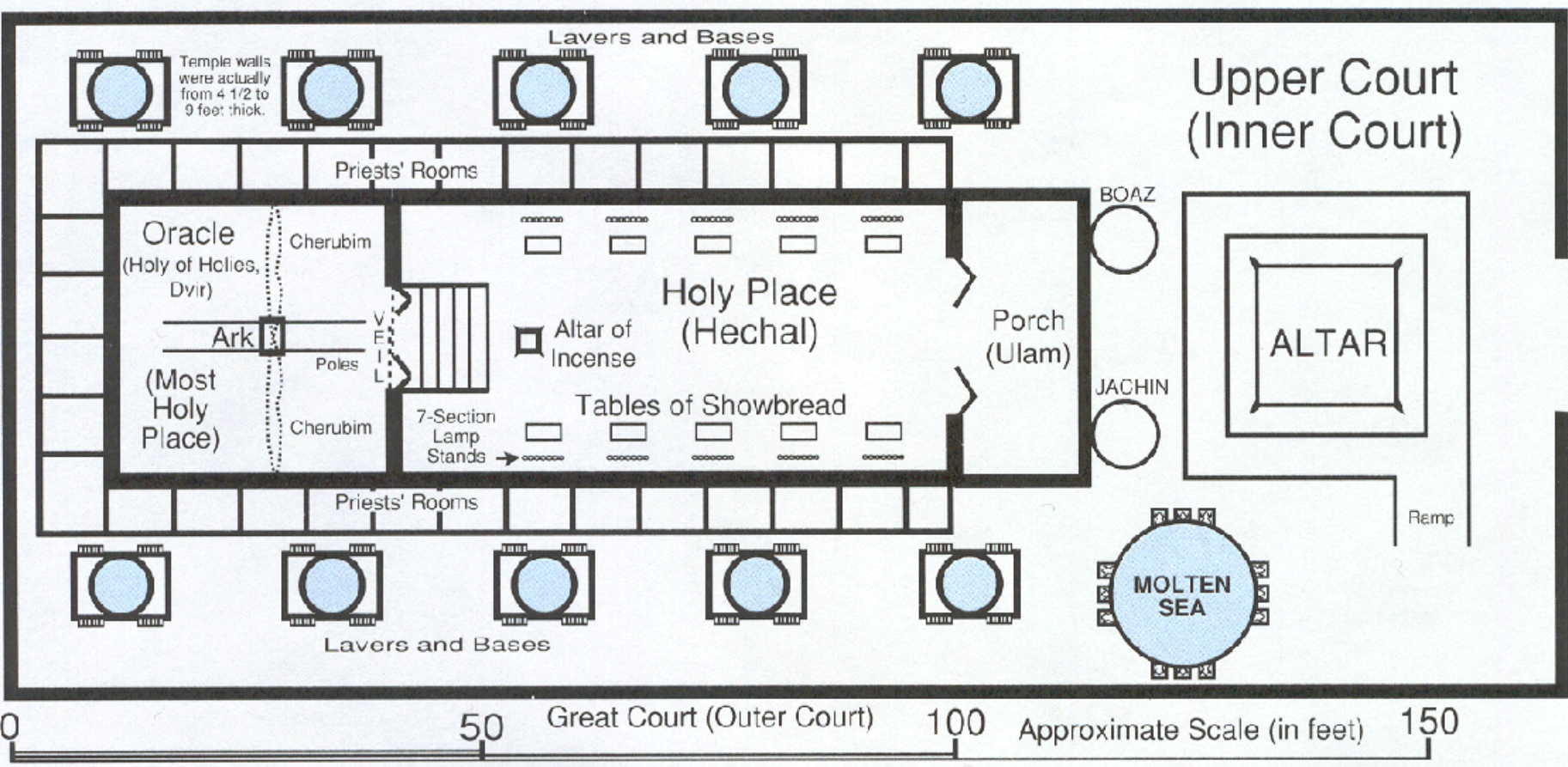

SOLOMON'S TEMPLE

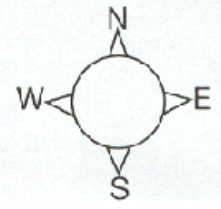

© 1998 Son Light Publishers, Ft. Smith, Arkansas

5/11/2013

Solomon's Temple

960-586 B.C.

The temple of Solomon, located adjacent to the king's palace, functioned as God's royal palace and Israel's national center of worship. The Lord said to Solomon, "I have consecrated this temple... by putting my Name there forever. My eyes and my heart will always be there" (1 K 9:3). By its cosmological and royal symbolism, the sanctuary taught the absolute sovereignty of the Lord over the whole creation and his special headship over Israel.

The floor plan is a type that has a long history in Semitic religion, particularly among the West Semites. An early example of the tripartite division into *'ulam*, *hekal*, and *debir* (portico, main hall, and inner sanctuary) has been found at Syrian Ebla (c. 2300 B.C.) and, much later but more contemporaneous with Solomon, at Tell Tainat in the Orontes basin (c. 900 B.C.). Like Solomon's, the later temple has three divisions, contains two columns supporting the entrance, and is located adjacent to the royal palace.

Solomon's Temple

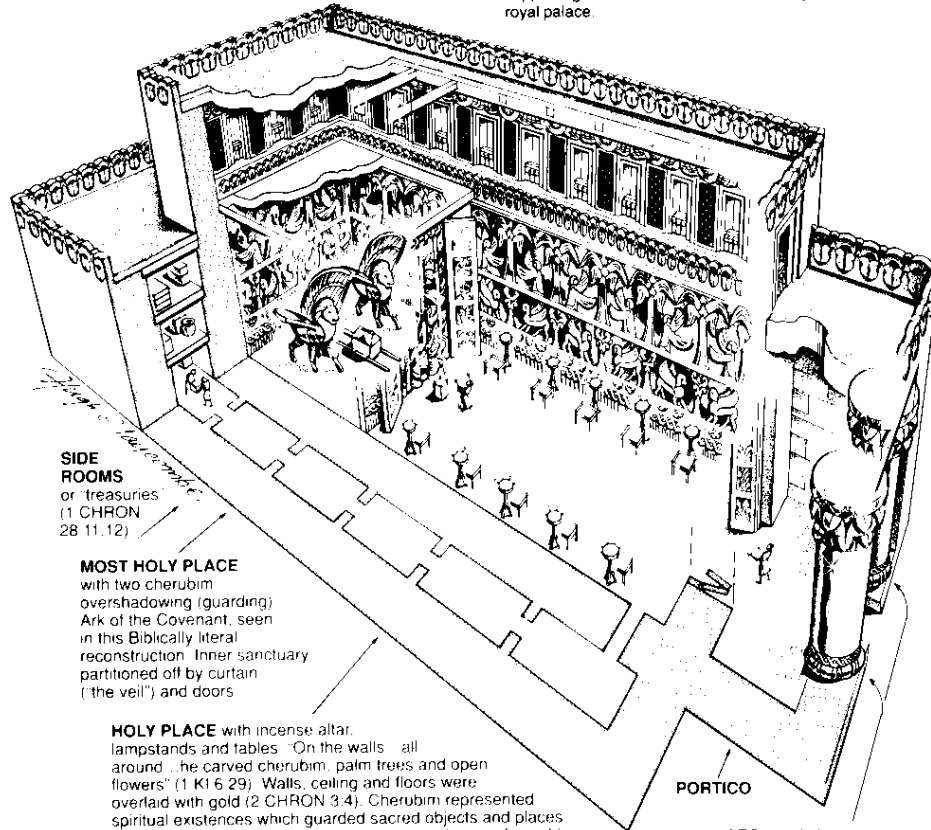

SIDE ROOMS
or 'treasuries'
(1 CHRON 28 11,12)

MOST HOLY PLACE
with two cherubim overshadowing (guarding) Ark of the Covenant, seen in this Biblically literal reconstruction. Inner sanctuary partitioned off by curtain ('the veil') and doors

HOLY PLACE with incense altar, lampstands and tables. "On the walls all around... he carved cherubim, palm trees and open flowers" (1 K 6 29). Walls, ceiling and floors were overlaid with gold (2 CHRON 3:4). Cherubim represented spiritual existences which guarded sacred objects and places. In light of Ex. 20:4 these cherubim were not objects of worship nor were they made to be seen by man, only by Yaweh (God). This art reconstruction recognizes archaeological attested Near Eastern art forms of Solomon's historical period and general region

PORTICO

PILLARS cast in bronze, named "Jacin and Boaz"

The artwork on these two pages has been drawn to the same scale for comparative purposes

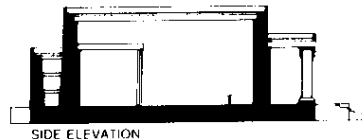
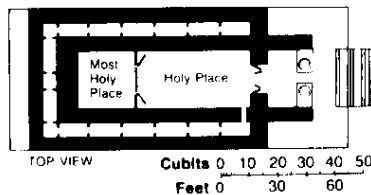

© Hugh Claycombe 1995

Court of the Gentiles

NORTH GATES OF INNER COURTS

Warning Inscriptions to Gentiles

Warning Inscriptions to Gentiles

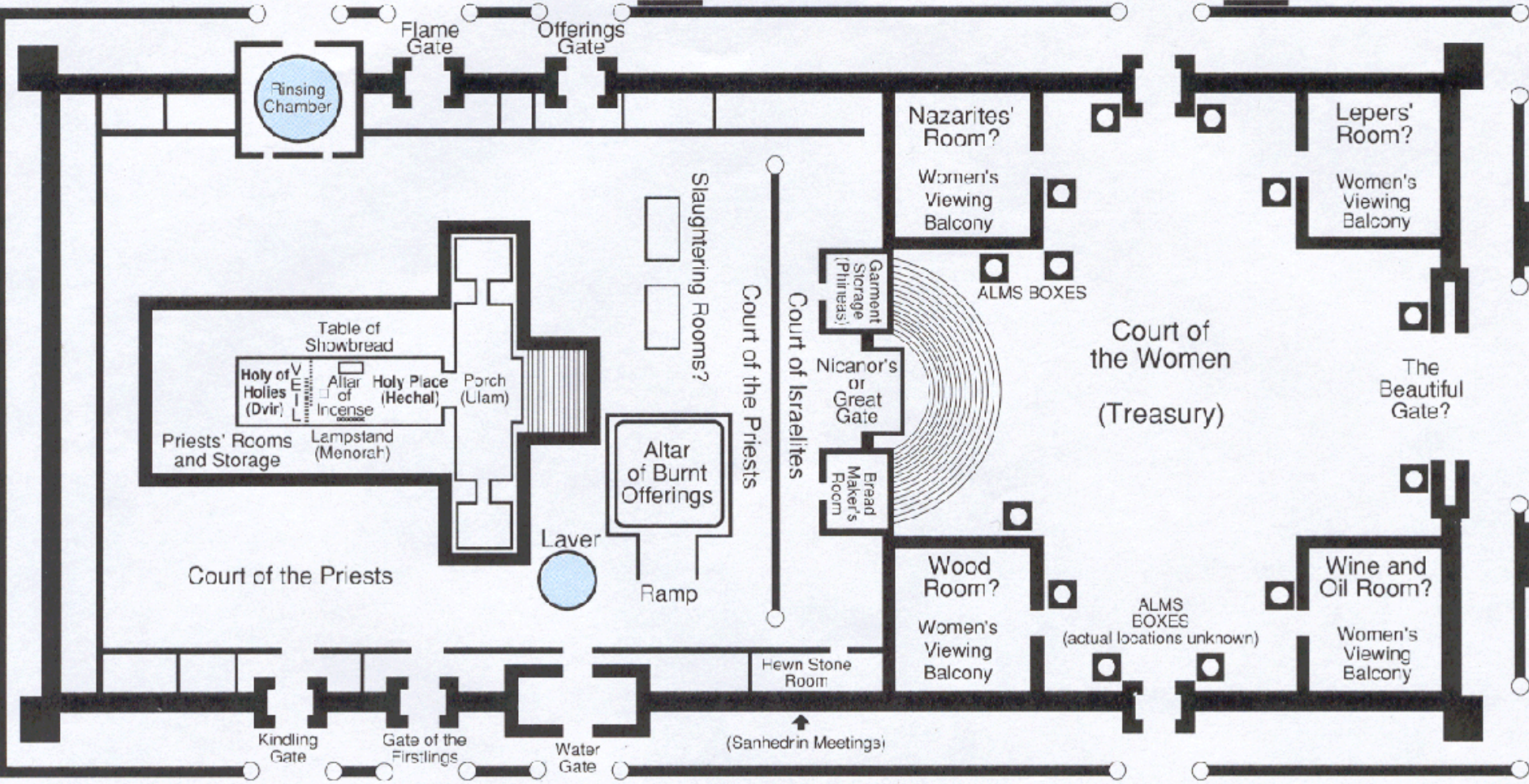

SOUTH GATES OF INNER COURTS

Court of the Gentiles

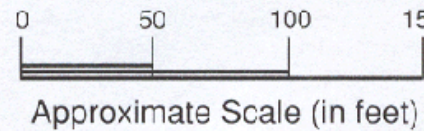
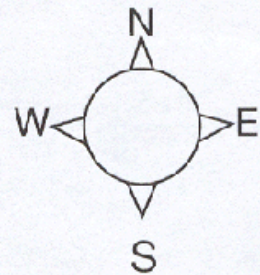

HEROD'S TEMPLE

Herod's Temple Graphic

Herod's Temple — 20 B.C.—A.D. 70

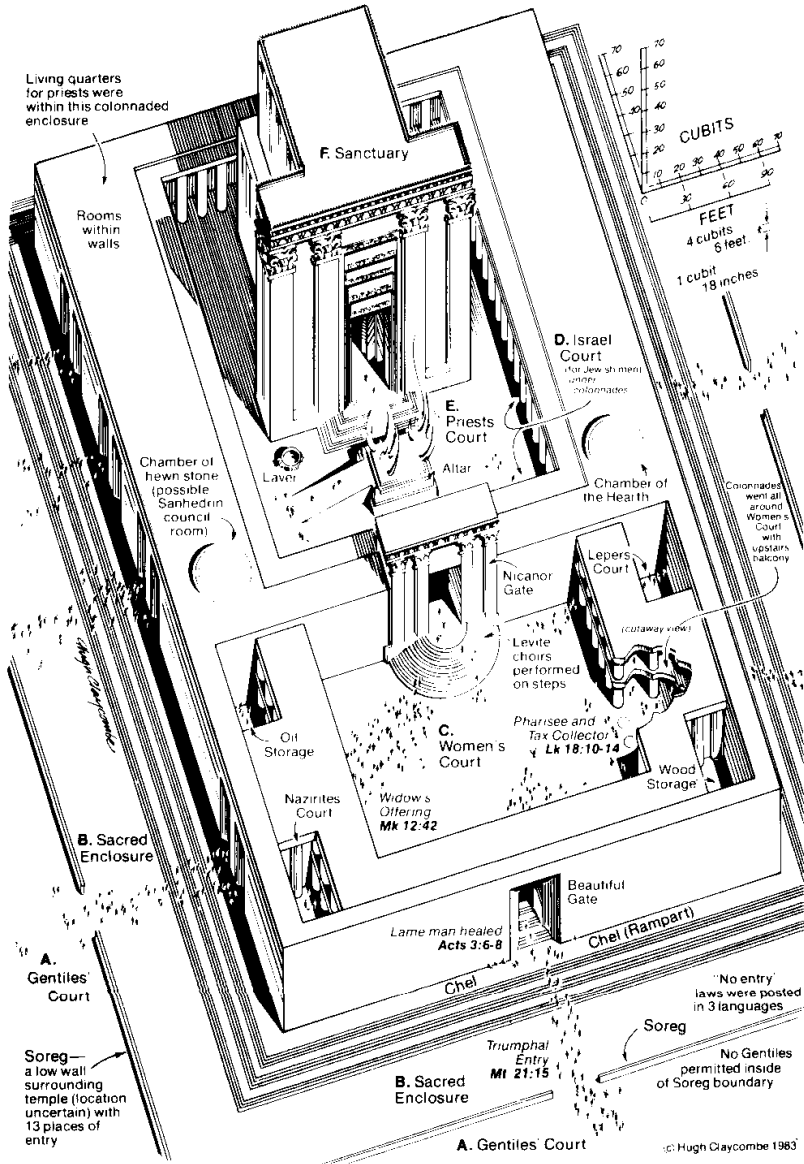

Herod's Temple

20 B.C.—A.D. 70

Begun in 20 B.C., Herod's new structure towered 15 stories high, following the floor dimensions of the former temples in the Holy Place and the Most Holy Place. The high sanctuary shown here in a cutaway view was built on the site of the former temples of Solomon and Zerubbabel, and was completed in just 18 months.

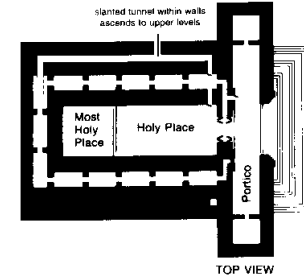
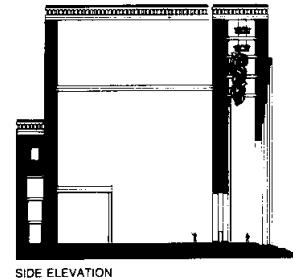
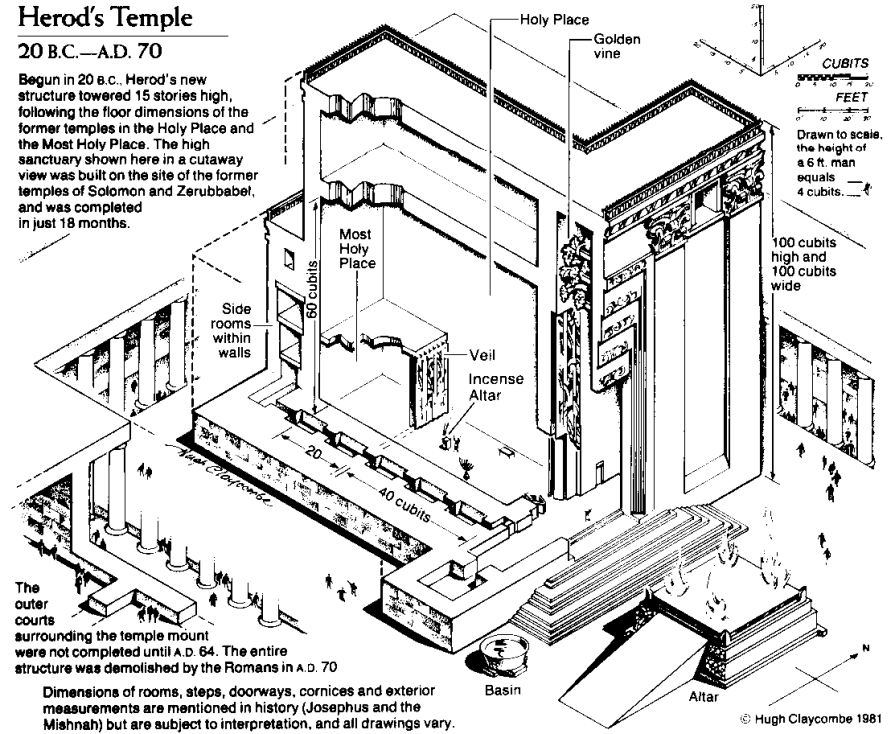

© Hugh Claycombe 1988-Photocopy by permission of the artist. FOR CLASSROOM USE ONLY
May not be sold, published, scanned into computer, transmitted by e-mail nor fax

The Temple's Five Gates

- The Chief Gate (East) Ezek 11:1
- On the N. near the altar Ezek 8:5
- The Higher Gate built by Jotham 2 Kgs 15:35
- The Gate of Foundation 2 Chr 23:5
- Solomon's Ascent 1 Kgs 10:5; 2 Chr 9:11; 2 Kgs 16:18





Solomon's Temple

Designed by God

Pillars
Yachin = God will establish
Boaz = God is strength

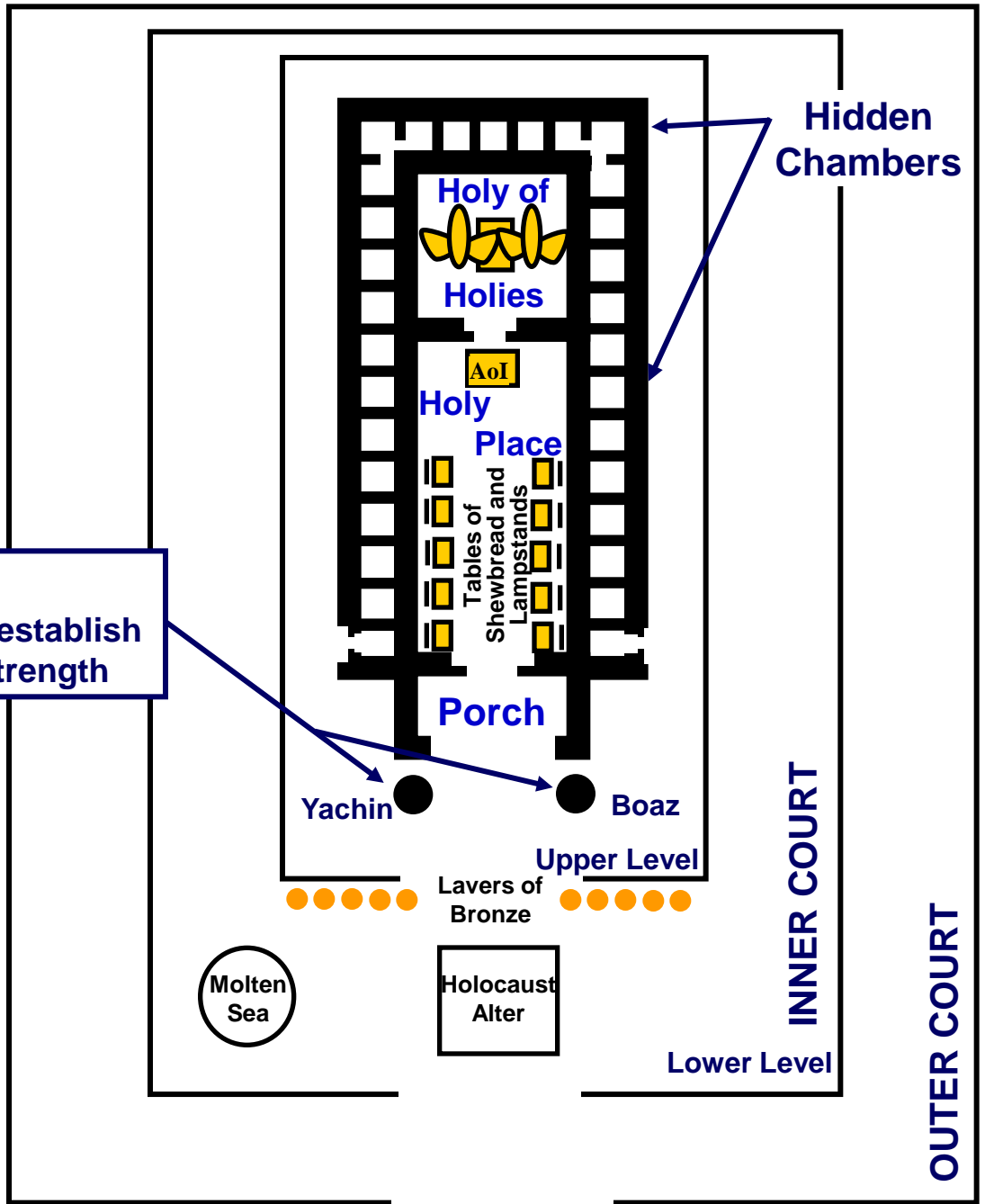
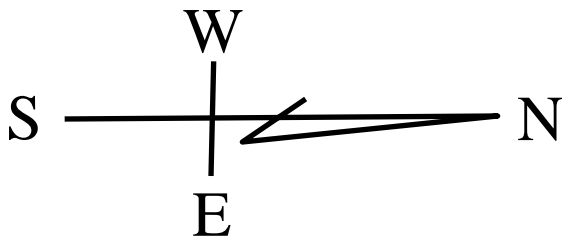

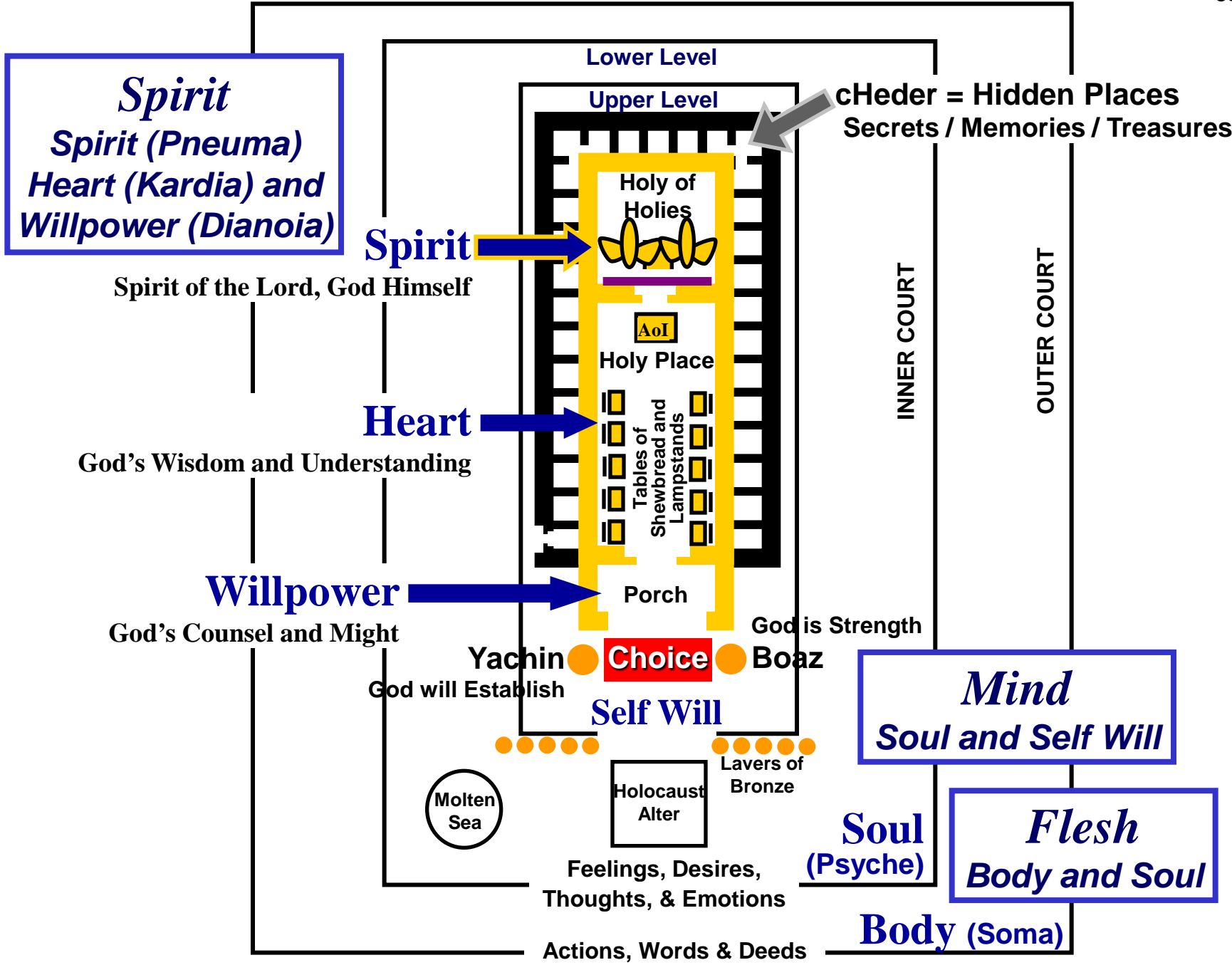



**Hidden Chambers
(Cheder)
Innermost Being
Secret Place**

**Old Hurts,
Resentment,
unDealt with Sin**

***Unbeliever's
Mind***

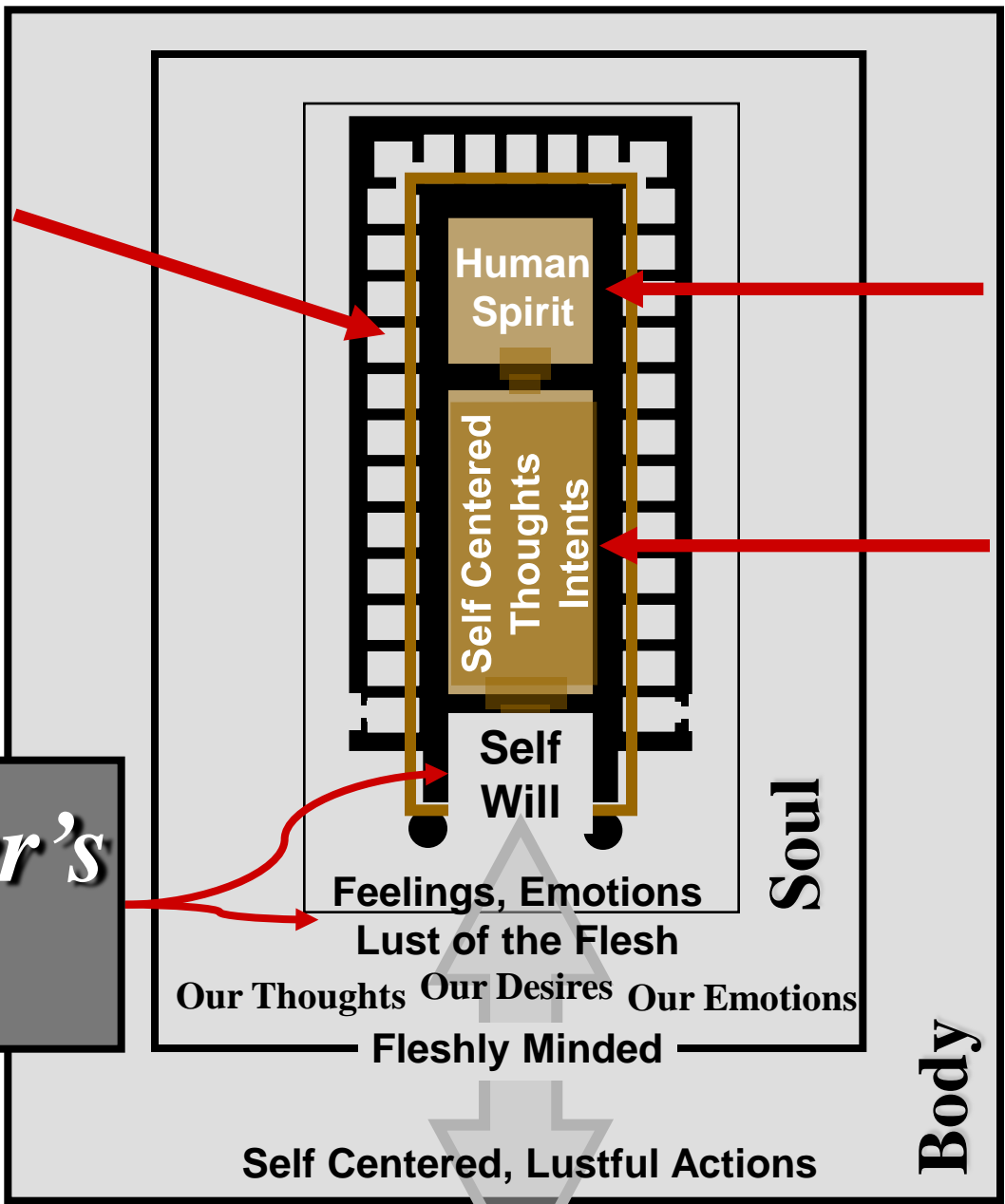

Spirit

Heart

Soul

Body

Self Centered, Lustful Actions



Romans 6:23

For the wages of sin is death;

but the gift of God is eternal life

through Jesus Christ our Lord.

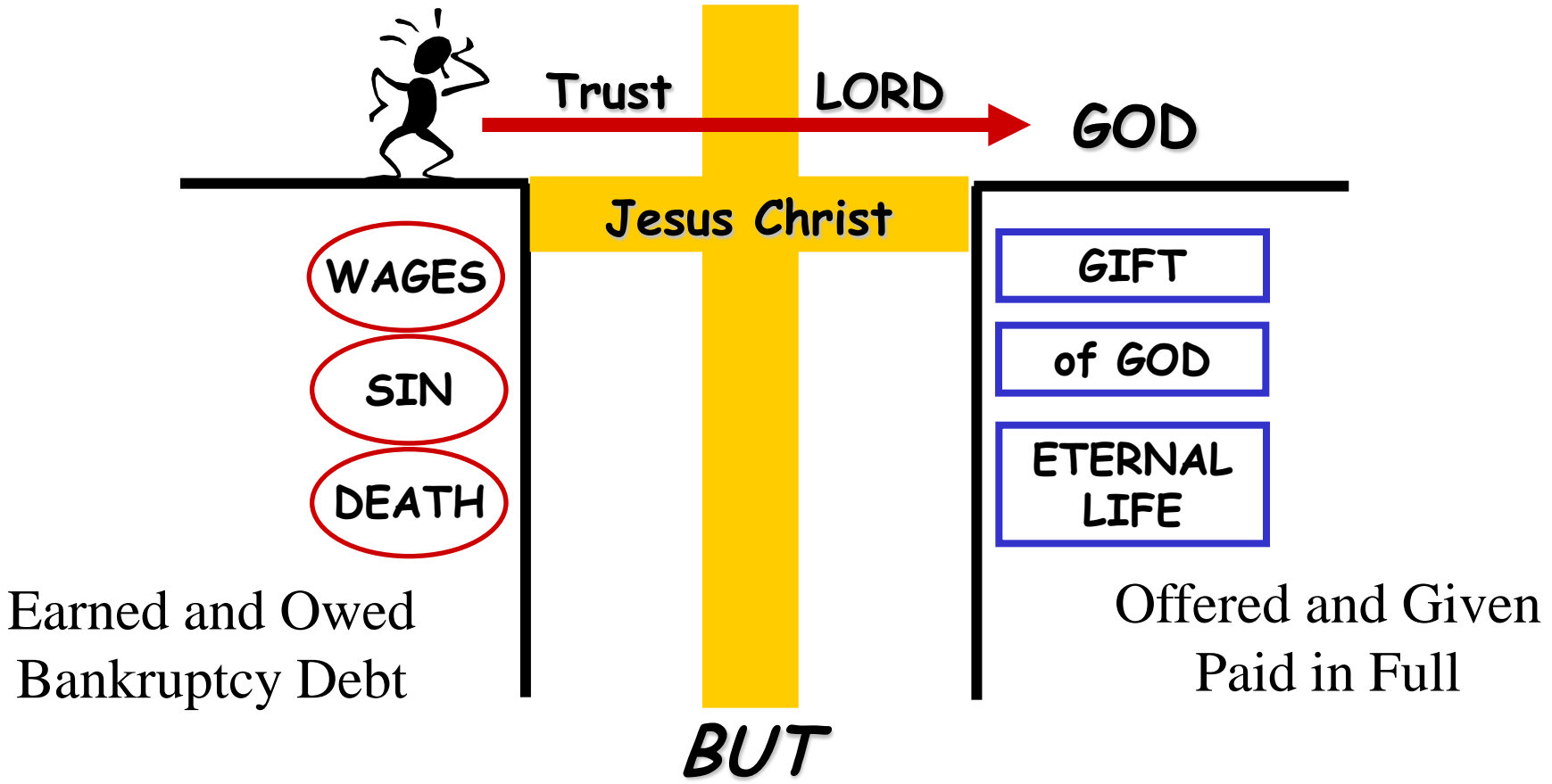

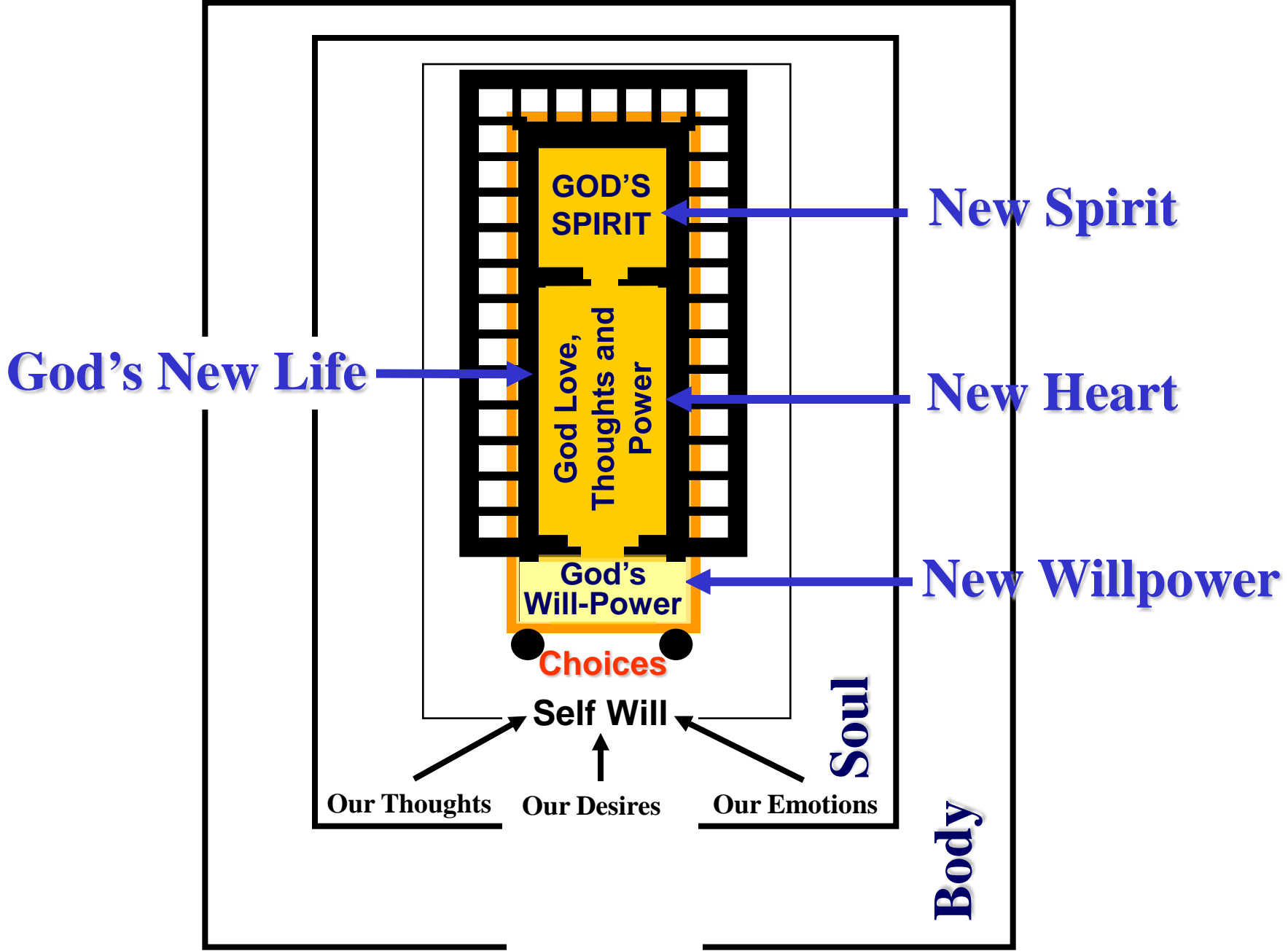



SOLOMON'S (DAVID'S) TEMPLE

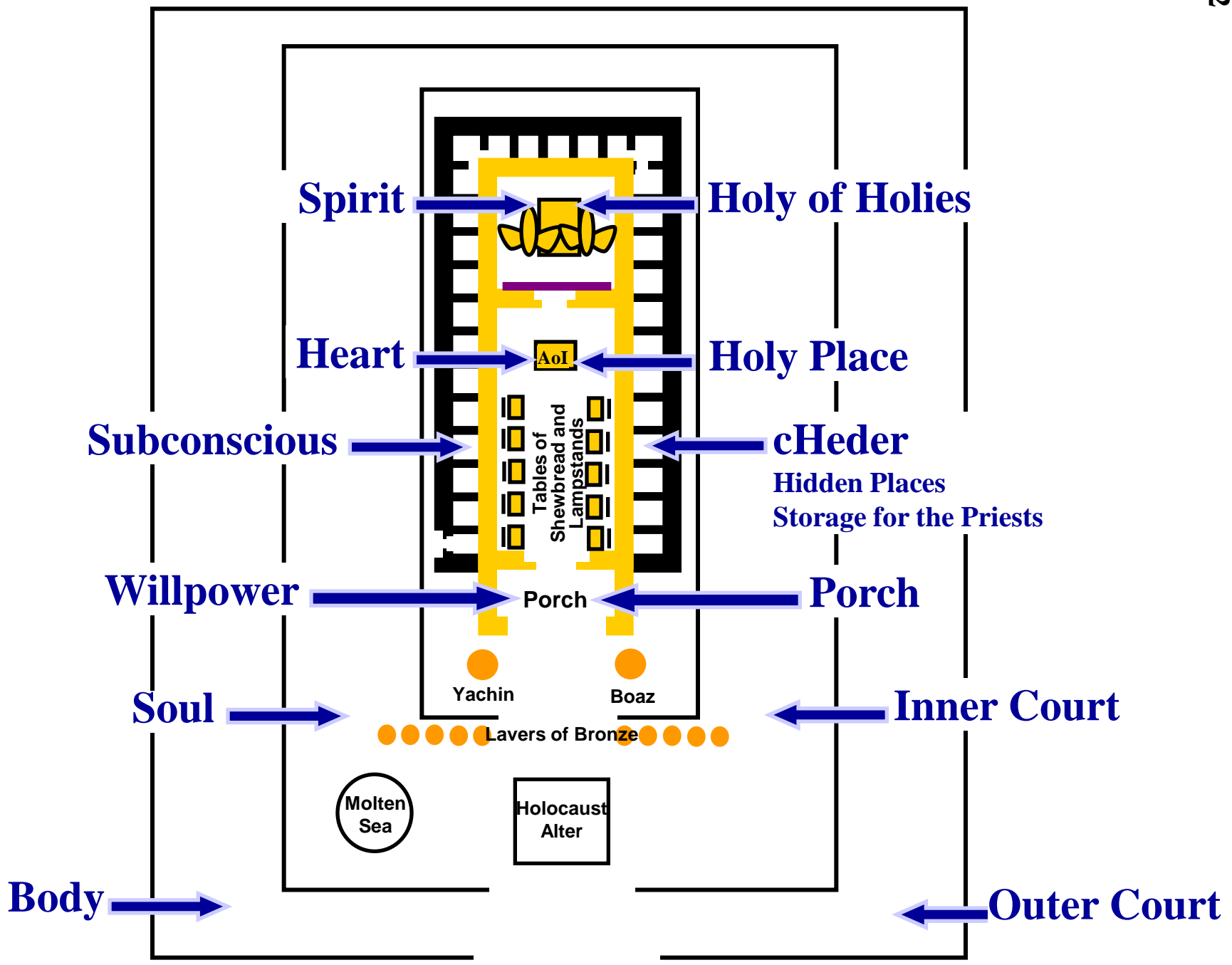



God's New Life

What I want to do...
How I want to walk...
How I want to talk...

MIND
- CHOICE -
Battleground

Old Self Life

What I do...
How I walk...
How I talk...

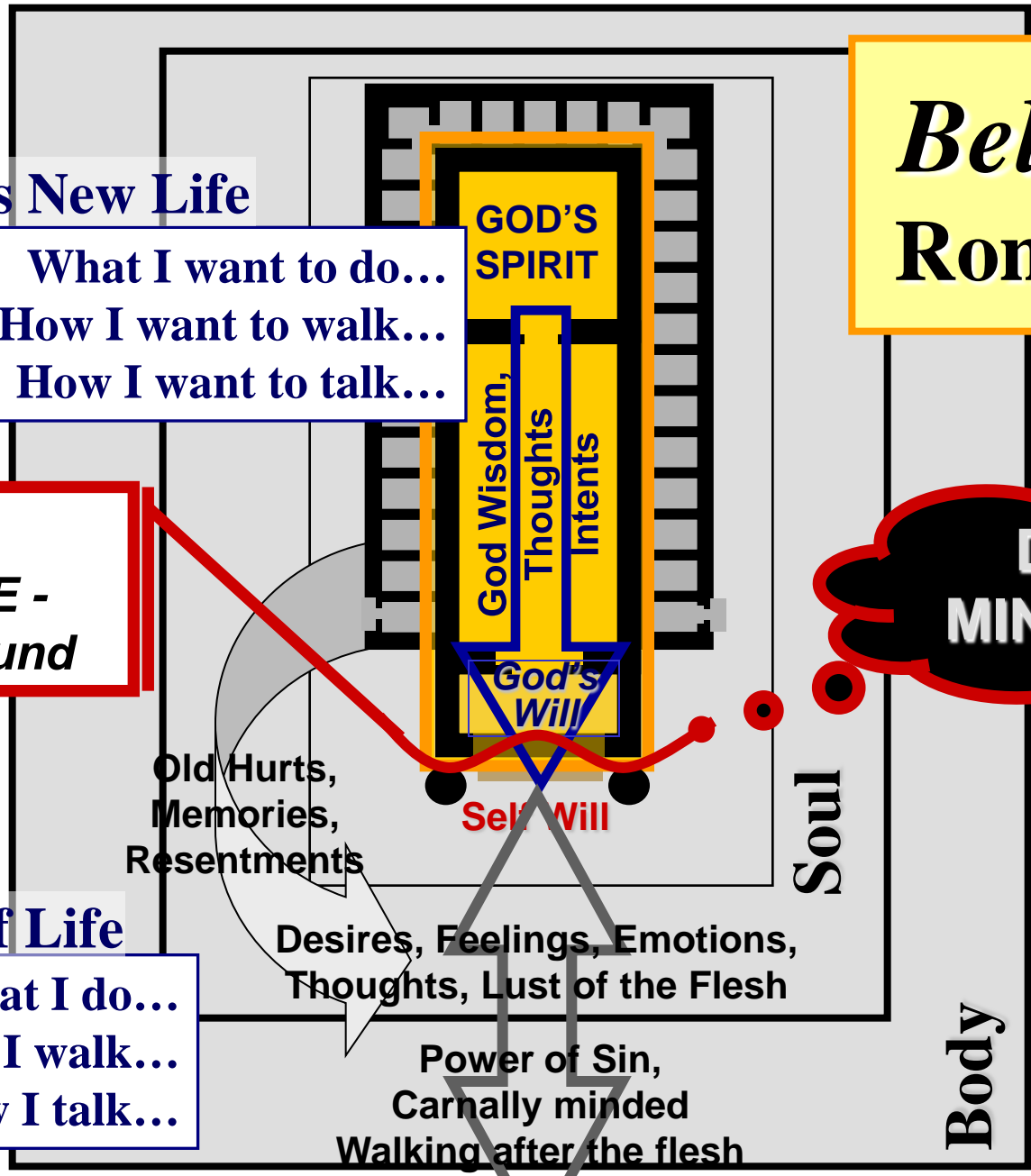

Believer
Romans 7

DOUBLE MINDEDNESS

Old Hurts, Memories, Resentments

Desires, Feelings, Emotions, Thoughts, Lust of the Flesh

Power of Sin, Carnally minded Walking after the flesh

Self Centered, Lustful Actions



- Become Salt and a Light to the World
- Deeds match Words
- Have (God's) Life Abundantly
- Worship God in Spirit and in Truth

Believer
 "SPIRIT FILLED"

God's Life

ReNewed Mind

Choosing God's Will
 Using God's Power

- Bring every thought into captivity
- Confess / Repent - Clean the hidden places as they are exposed

Rom 12:1-2



Agape Love; God Centered Actions

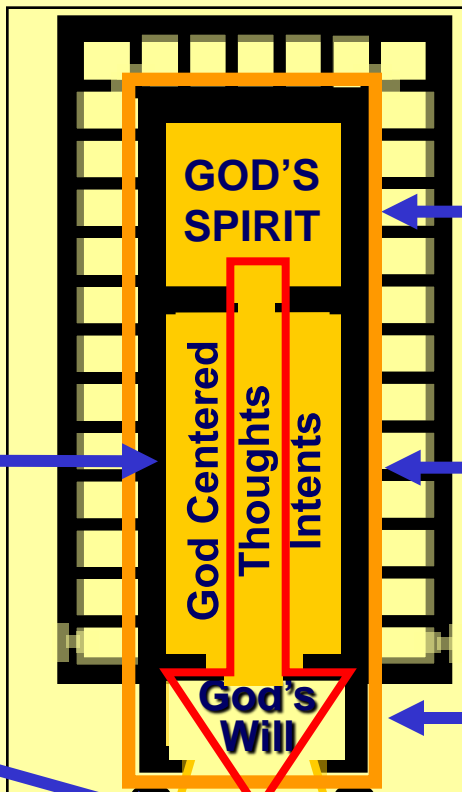

New Spirit

God's Life / Power
 My Source

New Heart

God's Plan / Purpose
 My Motivation

New Will

God's Will / Power
 God's Will for Me

Soul

Body

God's Thoughts
 Single Minded

God's Desires

Spiritually Minded
 Walk after the Spirit

1Co 9:27 But I keep under my body, and bring it into subjection: lest that by any means, when I have preached to others, I myself should be a castaway.



Holy of Holies

Spirit of the Lord

Holy Place

His Wisdom and Understanding

Porch

His Counsel and His Strength

Jachin



In His Counsel to make the right Choice

“Not My Will, But Thine”



Boaz

In His Strength to carry out the Choice

Daily Cleansing by the Washing of the Word

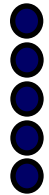

10 Lavers of Bronze
Washing of hands and feet of the Priests
Confess - Forgive

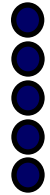

Complete immersion



Molten Sea



Holocaust Alter Sacrifices

Repentance

Cleansed and Sanctified, Washed in His Blood Immersed in Him

INNER COURT CLEANSING

Confess:

- See yourself as you are.
- Acknowledge your own sin
- Forgive those who have wronged you

Repent:

- Ask God to forgive you and to remove your sin from you
- To cleanse you from all unrighteousness

Wash:

- Immerse yourself in God's Word
- Ask God to change you; renew your mind
- Set yourself apart for His use

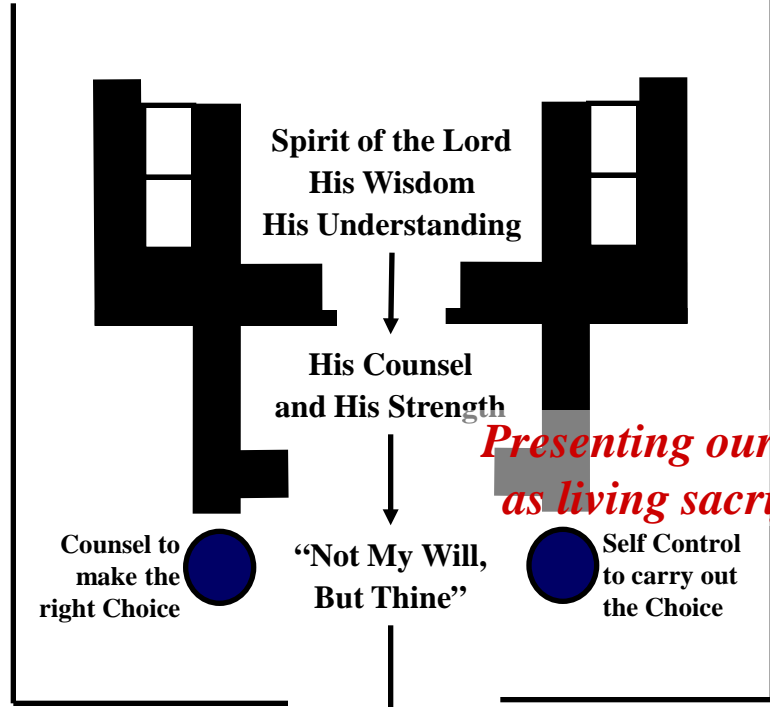
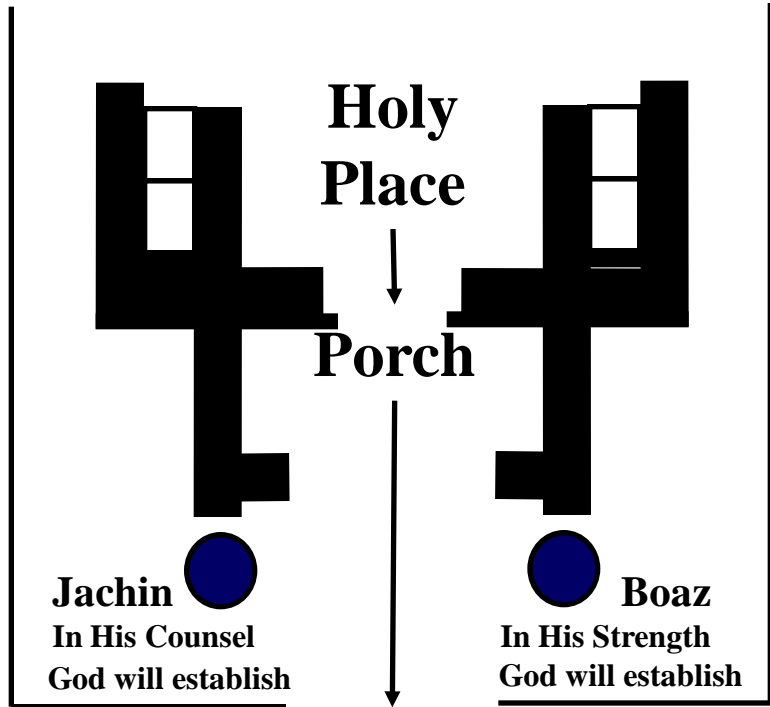

● ● ● ● ● ● ● ● ● ● ● ●

10 Lavers of Bronze
Washing of hands and feet of the Priests

● ● ● ● ● ● ● ● ● ● ● ●

● ● ● ● ● ● ● ● ● ● ● ●

Washed daily in the water of His Word

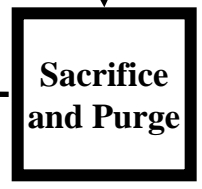
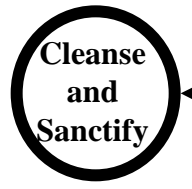
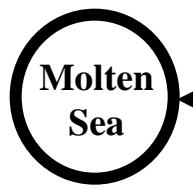

Complete emersion of the Priests

INNER COURT

Cleansed by His blood

Because of His sacrifice

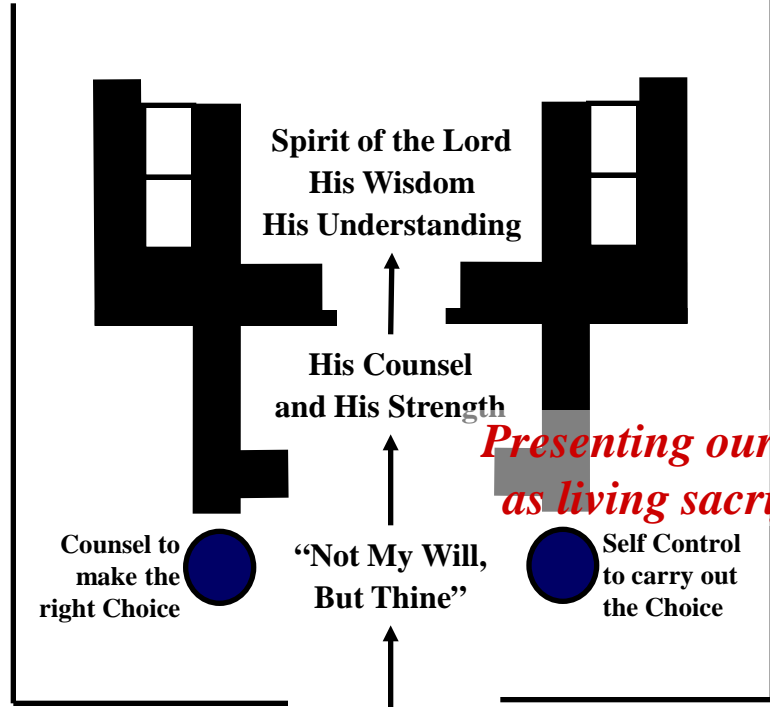
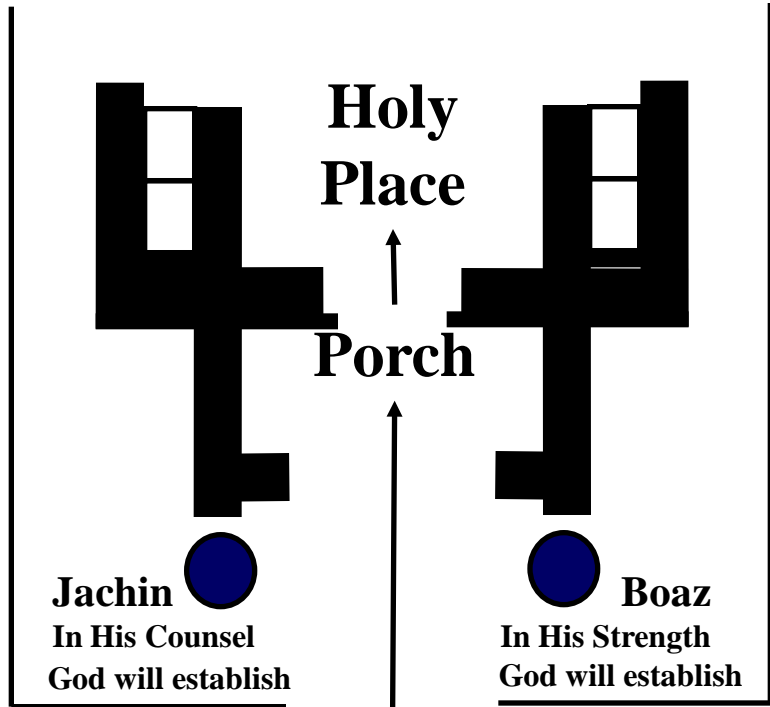

● 10 Lavers of Bronze
● Washing of hands and feet of the Priests

● Confess
● Repent
● Forgive

● *Washed daily in the water of His Word*



Complete emersion of the Priests

INNER COURT

Cleansed by His blood

Because of His sacrifice

Presenting ourselves as living sacrifices

Inner court cleansing

Confess:

- See yourself as you are.
- Acknowledge your own sin
- Forgive those who have wronged you

Repent:

- Ask God to forgive you and to remove your sin from you
- To cleanse you from all unrighteousness Rev 1:5

Wash:

- Washing daily in God's Word Eph 5:26-27
- Ask God to change you; renew your mind Rom 12:1-2
- Set yourself apart for His use Eph 2:8-10

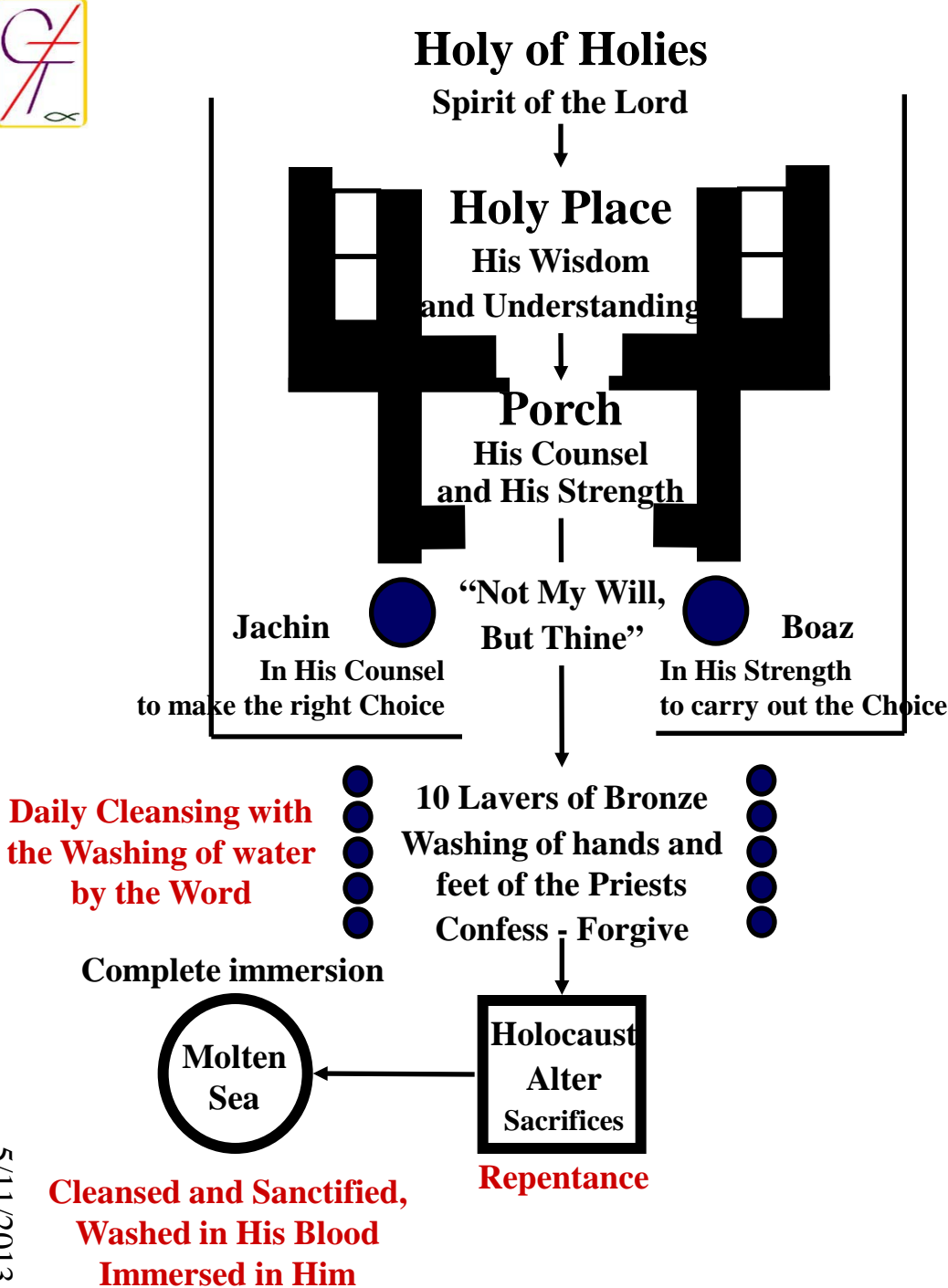

My SPIRIT is saved

THIS LIFE:
My choice,
Jesus' work

ATONEMENT: buying back, paying for, freeing from bondage to...
"Whosoever will may come"

Rejecting or Ignoring
Jesus Christ

Accepting and Belief
in Jesus Christ

REDEMPTION: payment applied

Saved; Born Again a NEW CREATION

JUSTIFICATION
FREE GIFT OF GOD
Paid in Full by Christ

My SOUL
(mind, will, emotions)
is being saved

THIS LIFE:
MY WALK

My choices, My work
Hearer only => "Lord, Lord,..."

LED BY SELF
Doing my own thing
My plans, my rights, my way

God's choices, My work
Obedient; doer as well as hearer

LED BY GOD'S SPIRIT
Set apart for God...Run the race...
work out your own salvation...
"bride making herself ready"

SANCTIFICATION
Process - My choices
Treasure in Heaven
Earned reward

My BODY
will be saved

THE LIFE TO COME:
RAPTURE → MILLENNIUM
GLORIFICATION

Unfaithful Servants
'OUTER DARKNESS'
"The Separate Place"
(Gizrah)

Overcomers: Joint Heirs
FELLOWSHIP WITH GOD
IN THE LIGHT OF HIS GLORY
Rewarded & Ruling w/ Christ

Eternal separation
from God
LAKE OF FIRE

ETERNITY

**NEW CREATION, NEW JERUSALEM,
NEW HEAVEN & NEW EARTH WITH GOD**



Salvation is a Lifelong Process

Heaven

New Birth



Salvation



Rapture

Justification

- Spirit is saved
- Receive Eternal Life
- Partaker 's *in* Christ

Sanctification

- Soul is being saved
- Live Christ's Life
- Partaker's *of* Christ

Glorification

- Bodies will be saved

Earth



Purpose of Our Salvation

Heaven

New Birth



Salvation

Rapture

Overcomer's Inherit the Kingdom

Second Coming

Millennium

Joint heirs with Christ to rule and reign over the world

Justification

- Spirit saved
- Receive Life

Sanctification

- Soul being saved
- Live Christ's Life by power of the Holy Spirit
- Learn to be Overcomers
- This is our "preparation" for ruling and reigning in the Kingdom

Glorification

- Bodies saved

Earth



Salvation of the Believer

1 Thess 5:23



Justification

Rom 3:26

Believing in the Lord

Declared Righteous – Rom 3:26

“Free Gift” – Eph 2:8

No “works” necessary – Eph 2:8-9

Sealed with the Holy Spirit – Eph 1:13

Receive Everlasting Life – John 3:16

A follower of Christ – Titus 1:16

Partaker in Christ – 1 Co 10:17

Betrothed – Hosea 2:19

Believers and Receivers – John 3:16

Enter the Kingdom – Gal 4:7

Spirit Saved – John 3:16

From the “*Penalty of sin*”

Salvation

Sanctification

1 Pet 1:15

Walking with the Lord

Making us Righteous – 1 Thes 4:3

Earned by Merit – Matt 7:21; Heb 3:14

“Fruit” necessary – Eph 2:10

Empowered by the Holy Spirit – 1 Pet 1:5

Experience Abundant Life – John 10:10

A true disciple of Christ – Luke 14:33

Partaker of Christ – Heb 12:10

Preparing for the Wedding – Rev 19:7-8

Overcomers – Rev 21:7

Inherit the Kingdom – Col 3:24

Soul Saved – 1 Peter 1:9

From the “*Power of sin*”

Glorification

1 Thes 4:16-17

Rapture

“Be with Him” – John 14:3

New Body – 1 Cor 15:51-53

Body Saved – Phil 3:10-21

From the “*Presence of sin*”

Judgment Seat of Christ



Judgment of Works

1 Cor 3:13-15



Who Will Inherit the Kingdom ??

- Those who are sanctified, transformed & prepared
- Those who partake of Christ
- Those who overcome
- Those who are “fruitful”
- Those who are obedient
- Those who are faithful
- Those who abide
- Those who deny themselves

Heaven

Judgment Seat of Christ



Inherit the Kingdom

- The Sanctified ones
- The “OVERCOMERS”

Marriage Supper of the Lamb

Enter the Kingdom

- The Justified ones
- The “OVERTAKEN”

New Birth



Salvation

Rapture

All Christians

Coming
Second

Justification Sanctification Glorification

Millennium

Earth

- Those who are “**Transformed**” into the image of Christ
- Those who are prepared to “**rule and reign**”



Running the Race

Heaven

New Birth



Salvation

Rapture

All Christians

Judgment Seat of Christ



The OVERCOMERS

The OVERTAKEN

Inherit the Kingdom

- Welcomed in
- Withstood the tests
- Fruitful works abide
- Won the “race” and “the prize”

1 Co 3:11-15 (Rev 3:18)
 1 Co 9:24-27
 Phil 3:7-14

Enter the Kingdom

- “Cast away”
- Failed the tests
- Fleshly works burned
- Lost the “race” and “the prize”

Earth



The OVERCOMERS

Vs.

The Overtaken

Heaven

Judgment Seat
of Christ

New Birth



Rapture

All Christians



Salvation

Earth

THE OVERCOMERS

‘Welcomed in’
Region of Light

- Experiencing intimacy
- Surrounding by Light
- The joy of His presence

THE OVERTAKEN

Cast out into a ‘separate’ place
Sphere of darkness

- Outside the Joy of the Lord
- Excluded from the light
- Weeping and gnashing of teeth



Defining the Kingdom

KINGDOM OF GOD

- Spiritual Kingdom
- Universal, unlimited in scope
 - Eternal
- Only door = Jesus Christ
- Focus = transformation of the individual
 - Inward, Invisible
- Mystical union of believer with Christ
 - Holiness deliverance from sin

KINGDOM OF HEAVEN

- Literal earthly sphere of the Kingdom of God
 - Physical Kingdom
 - Limited in scope
 - Rules over the Earth
 - Centered in Jerusalem
- Political kingdom – Jesus Christ is King

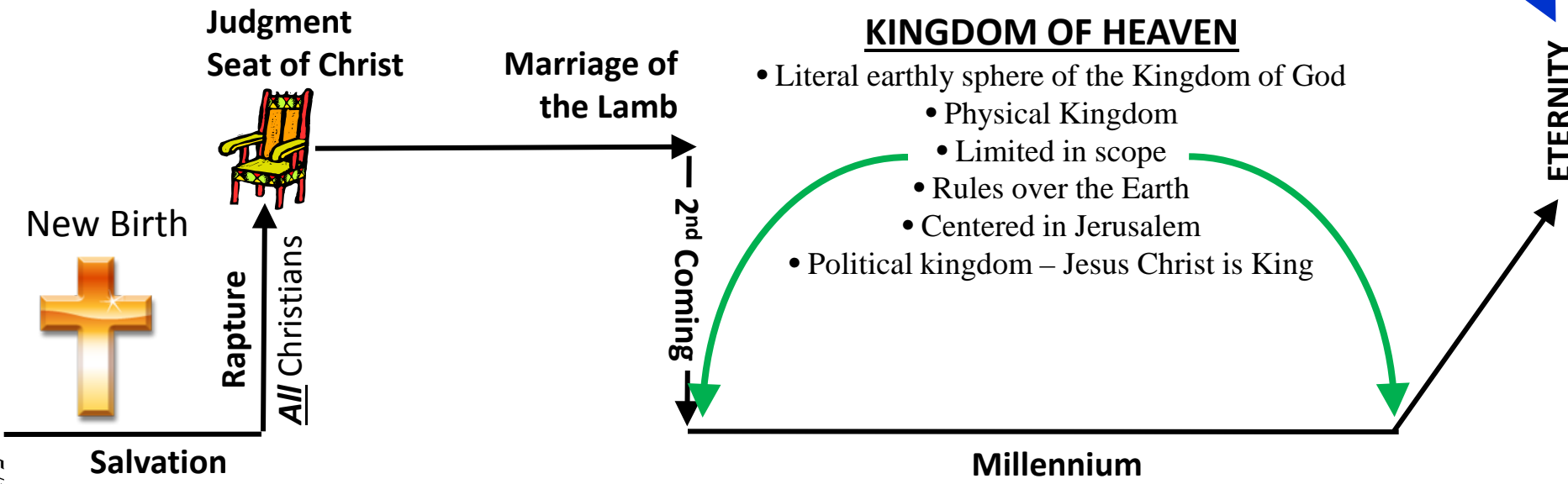

5/11/2013



What Happens After the Rapture

Heaven

Judgment Seat of Christ

1 Co 3:11-15
2 Co 5:10



Sanctified Christians
Inherit the Kingdom
Col 3:24; Mat 25:21

Unsanctified Christians
Enter the Kingdom
1 Co 3:15; Mat 25:12

Marriage of the Lamb
Rev 19:7-8

New Birth



Salvation

Rapture
1 Thes 4:13-18

Tribulation

Dan 12:1

Armageddon

Rev 16:16

2nd Coming
2 Thes 1:7-10
Rev 19:1-2

Millennium

Earth



Judgment Seat Criteria Gal 6:7

Heaven

Judgment Seat
of Christ

New Birth



Salvation

Rapture

All Christians



Gal 6:1

Earth

THE OVERCOMERS

The Overcomers inherit the Kingdom
- receive the reward of inheritance

- Works done by the Spirit of God – gold, silver, and precious stones
 - “Source” of their strength - God’s Spirit
- Their motivation - Love for God (1 John 4:17)
 - Constantly judge themselves (1 John 1:9)
- Clothed with brighteous deeds” (Rev 19:7-8)

THE OVERTAKEN

The Overtaken enter the Kingdom only
- suffer loss

- Works done in the “flesh” - wood, hay and stubble
 - “Source” of their strength - the flesh
 - Their motivation - self-centeredness
- Didn’t judge themselves here (1 Cor. 11:31)
 - Found to be “naked”

The Jewish Wedding Parallels to the Christian Life

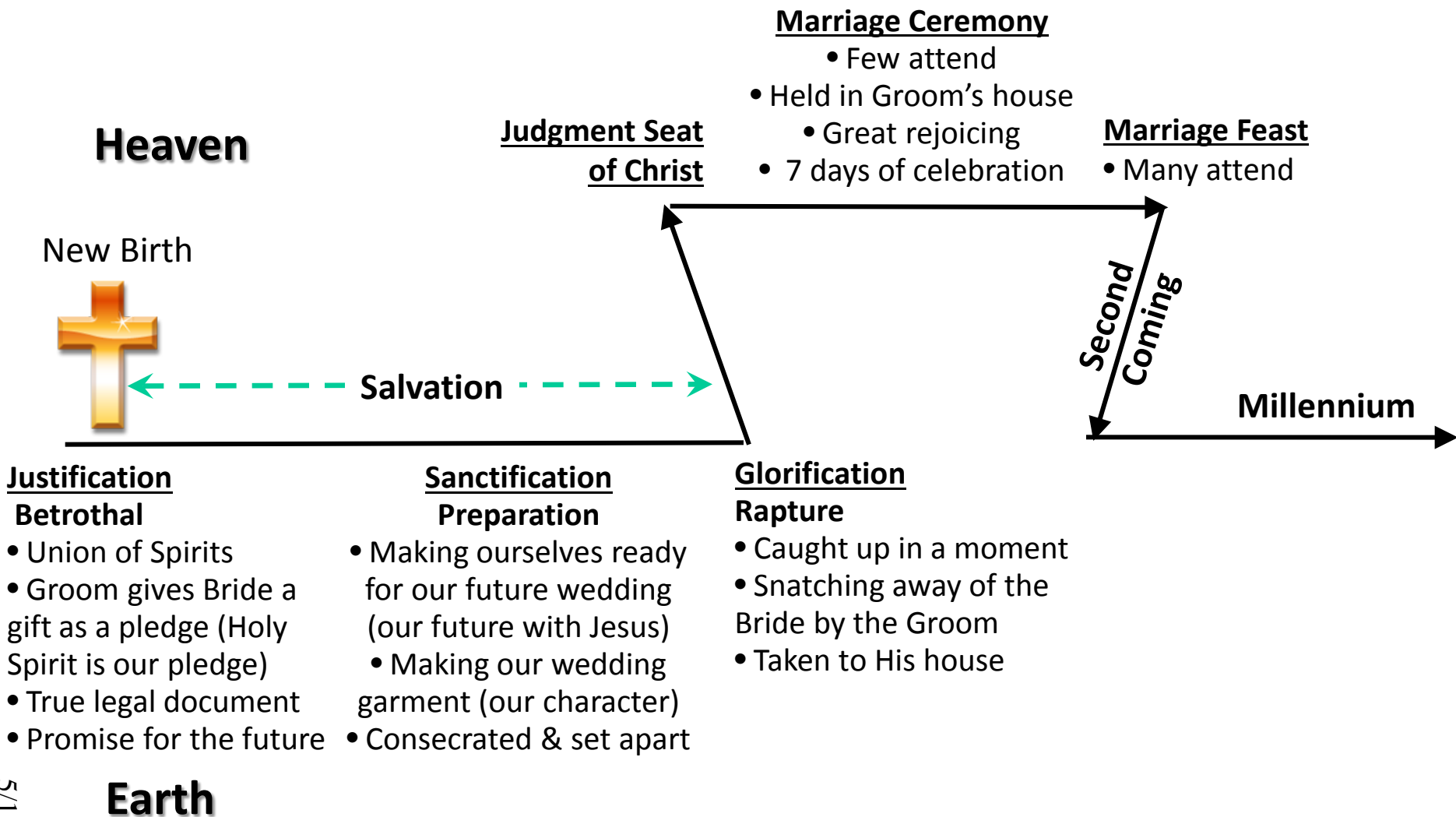



Reigning With Christ

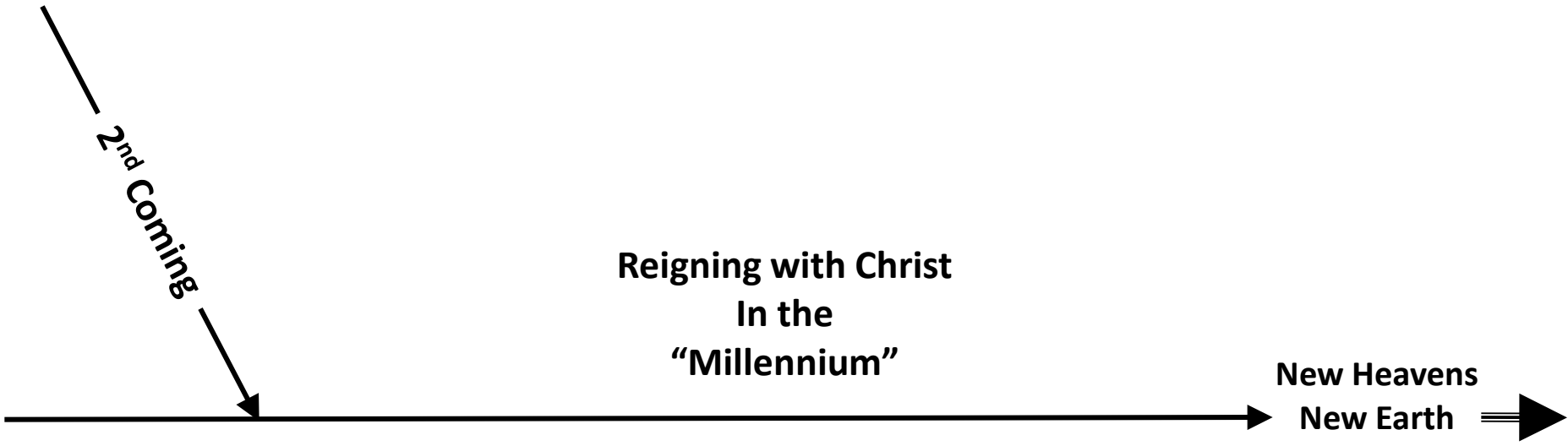

Depends Upon Our:

- Obedience
 - Faithfulness
 - Perseverance
- } Our "Personal Preparation"
- Overcoming world, flesh & devil
 - Bearing much "fruit" - works of the Spirit
 - Being a partaker of Christ's Life
 - Empowered by the Holy Spirit
 - Doing God's will



Walls of Separation

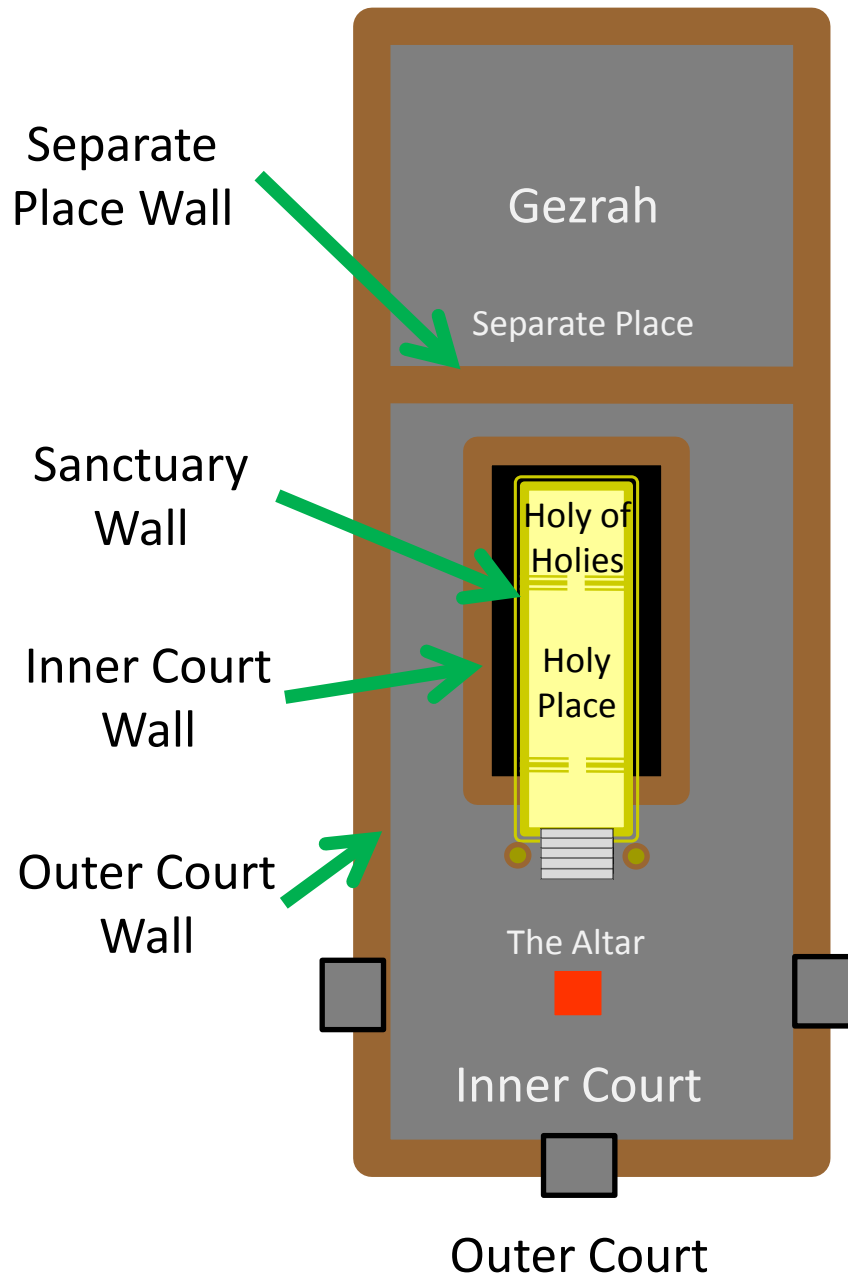



The Light of Christ's Presence

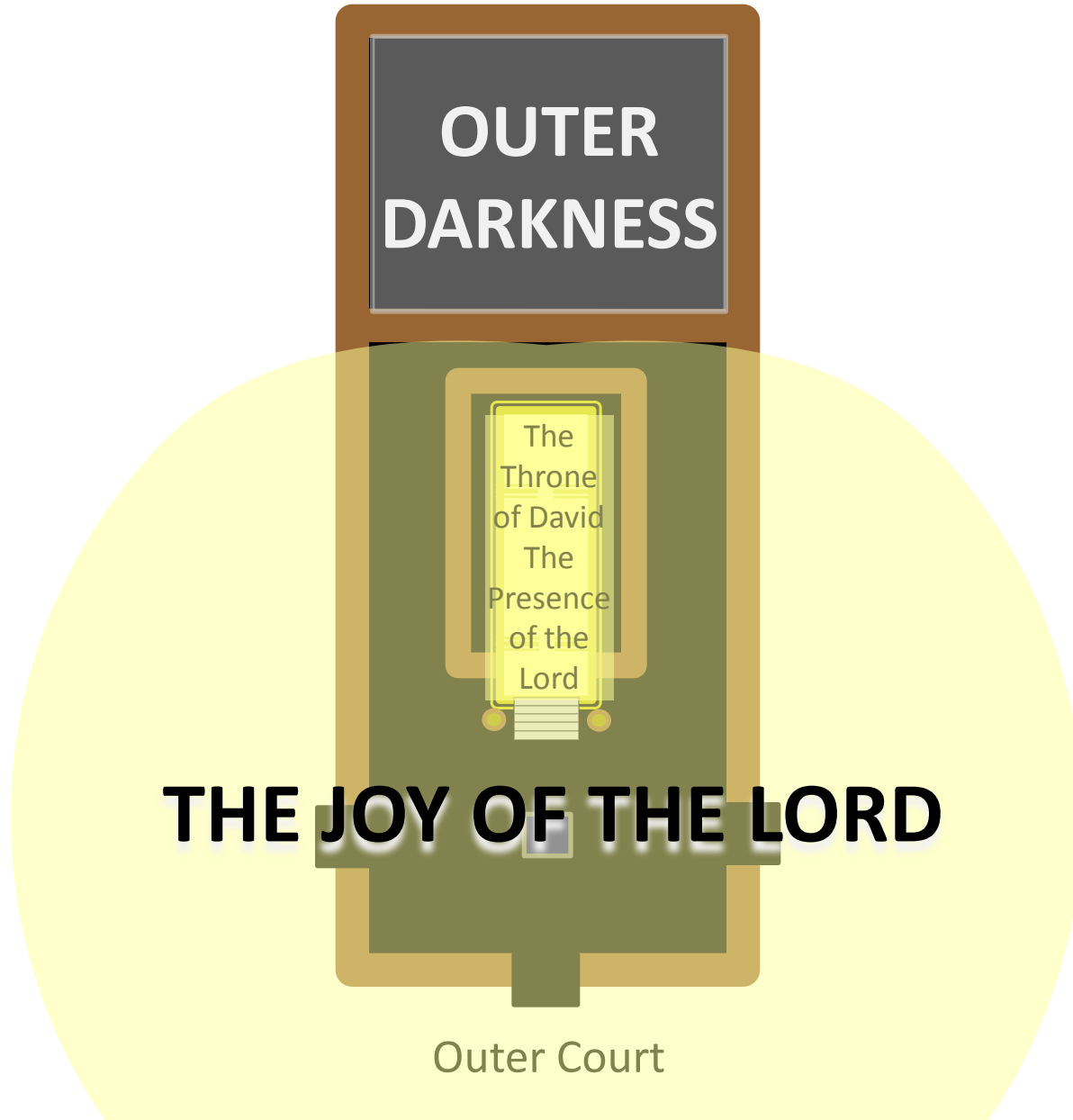



The Millennial Perspective

Heaven

Millennium Temple built on Earth - Ezek 40-48

Marriage of the Lamb
Rev 19:7-8

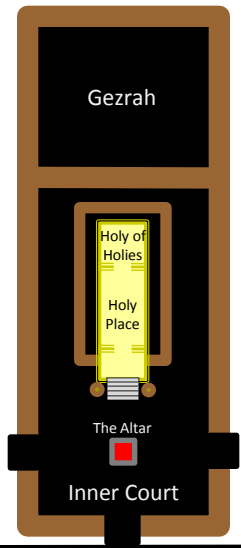

Gezrah – the ‘Outer Darkness’, a separate place for the **“Overtaken”** 1 Co 3:15

Christ on David’s Throne Luke 1:32

The Sanctuary -intimacy with Christ for the **“Overcomers”** Rev 2:17

2nd Coming
2 Thes 1:7-10
Rev 19:1-2

Tribulation Armageddon
Dan 12:1 Rev 16:16

1,000 Years – Millennium

- Marriage Supper of the Lamb - John 3:29; Rev 19:9
- Universal worship of Jesus Christ – Zech 14:9
- Christ rules the nations – Rev 2:27; Isa 2:4
- Israel restored / promises fulfilled – Amos 9:13-15

Great White Throne Judgment

New Heaven
New Earth
ETERNITY

Lake of Fire

Earth



LABORING TO ENTER IN

THE TWO GATES:

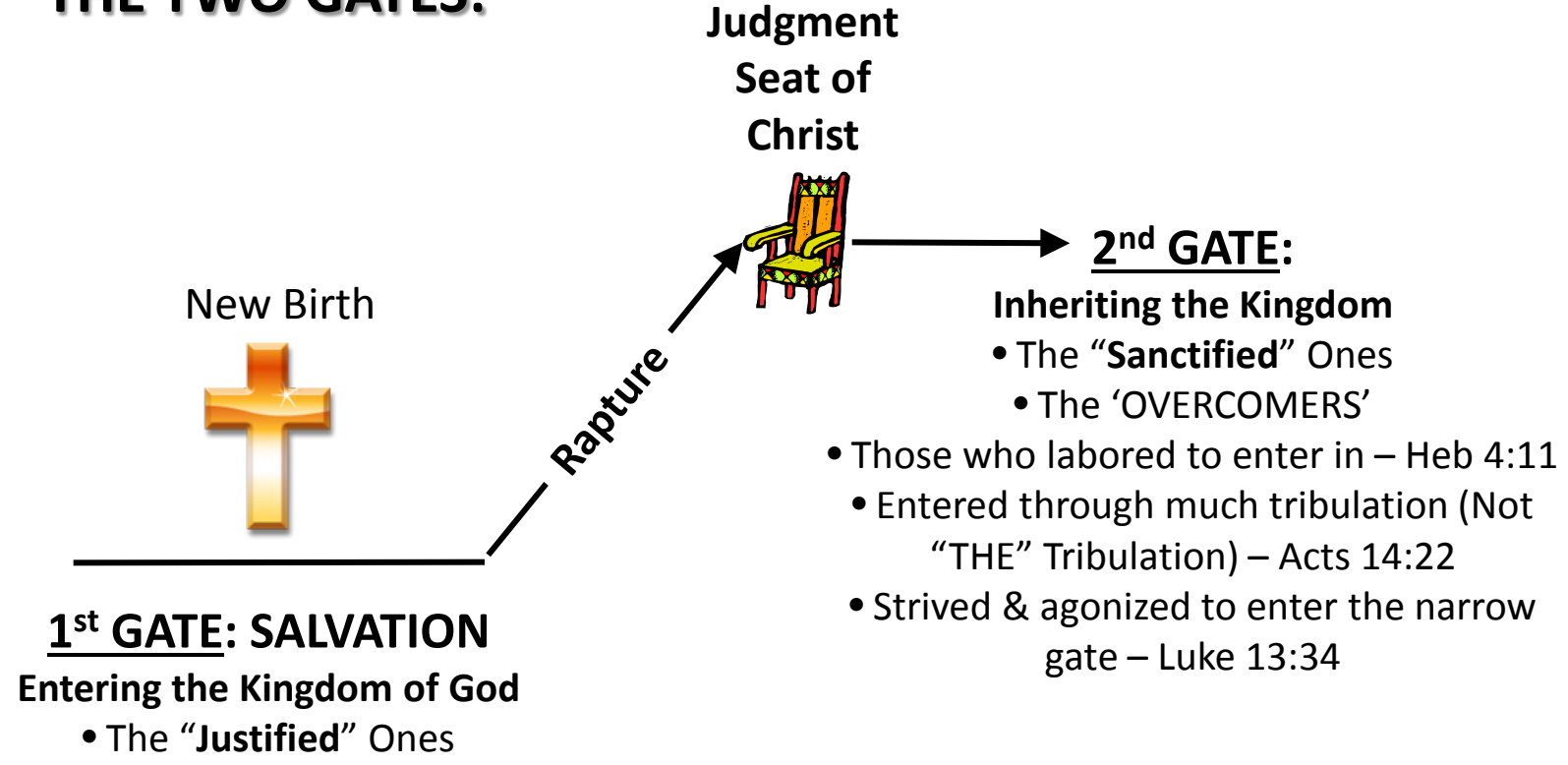



Dome of the Rock

STRUGGLE FOR PEACE IN THE MIDDLE EAST

Region

Israel

Old City

Key Issues

History

Dome of the Rock

The Dome of the Rock, also known as the Golden Dome, is built on the site Muslims believe the Prophet Muhammad ascended to Heaven one night on his horse Buraq. When the Muslims captured Jerusalem in 634, just two years after Muhammad's death, they ordered a shrine built on the site.

Jerusalem



Old City

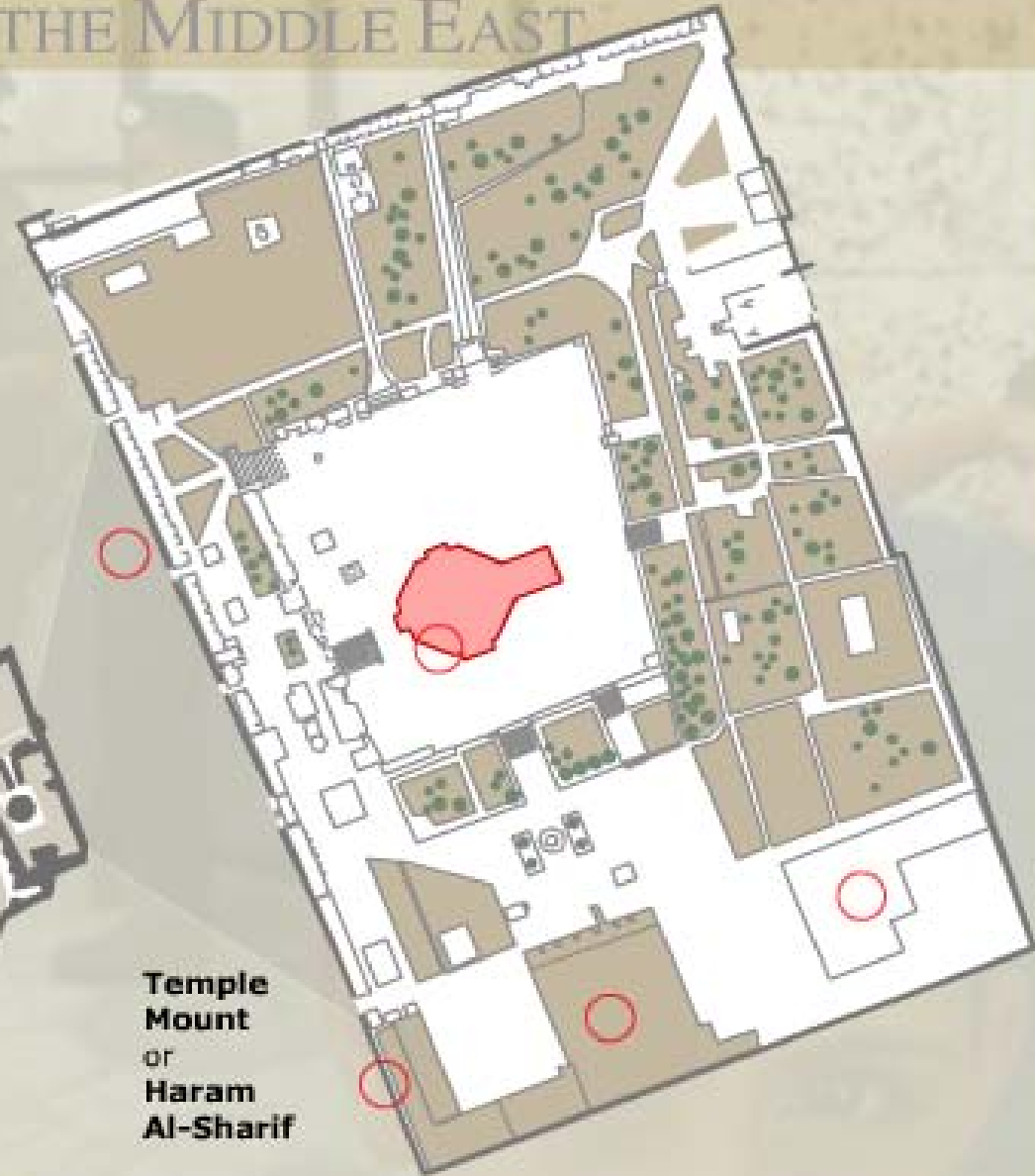

Temple Mount
or
Haram
Al-Sharif



Al-Aqsa

STRUGGLE FOR PEACE IN THE MIDDLE EAST

Region

Israel

Old City

Key Issues

History

Al-Aqsa

The Al Aqsa Mosque, located in the southern area of Al Haram Al Sharif, is a vast complex that can accommodate up to 5,000 worshippers at a time. The compound as a whole is regarded as the third most holy shrine in Islam, after Mecca and Medina in Saudi Arabia. For many Muslims, to see it under Israeli control is unacceptable.

Jerusalem



Old City

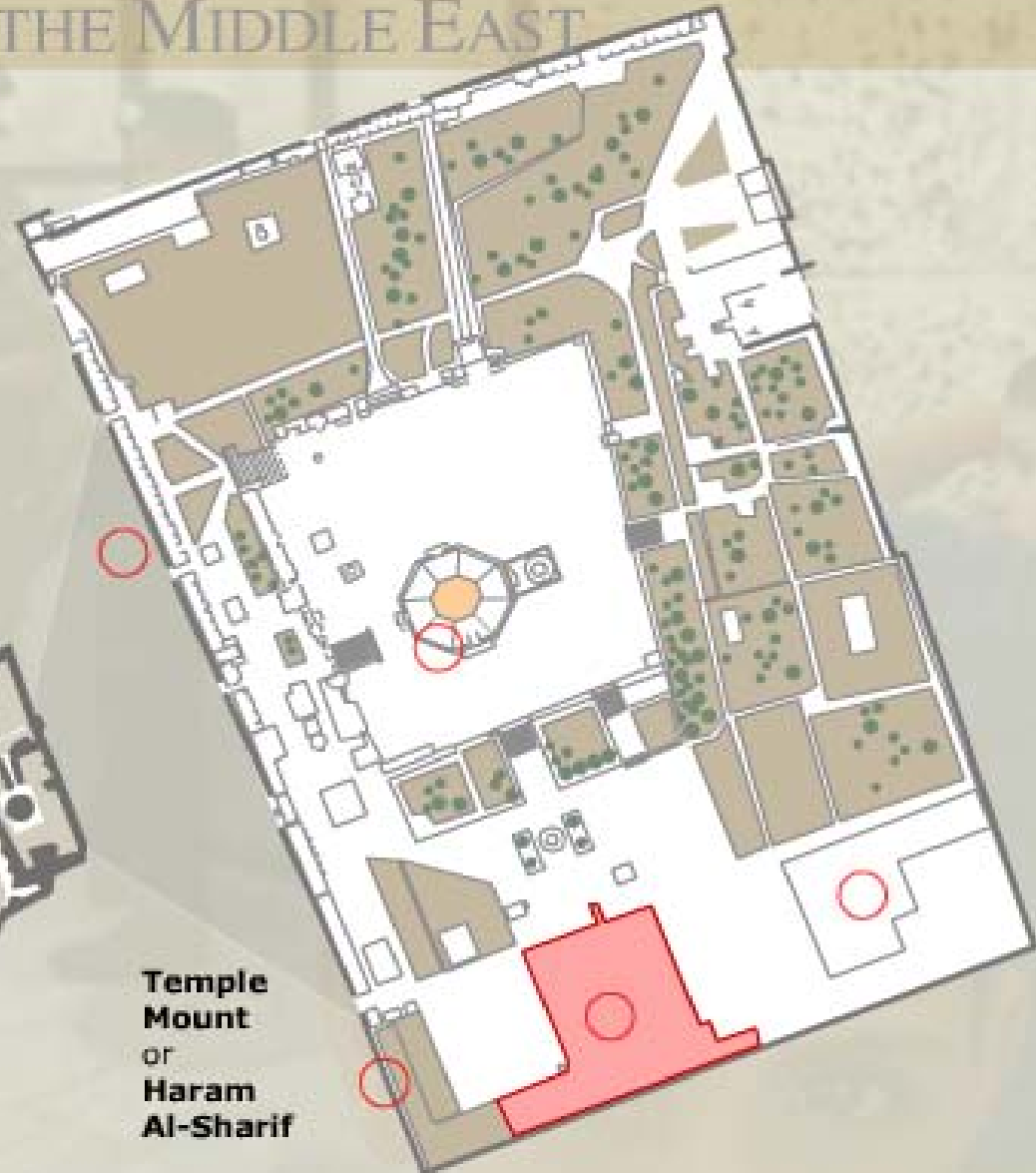

Temple Mount
or
Haram
Al-Sharif

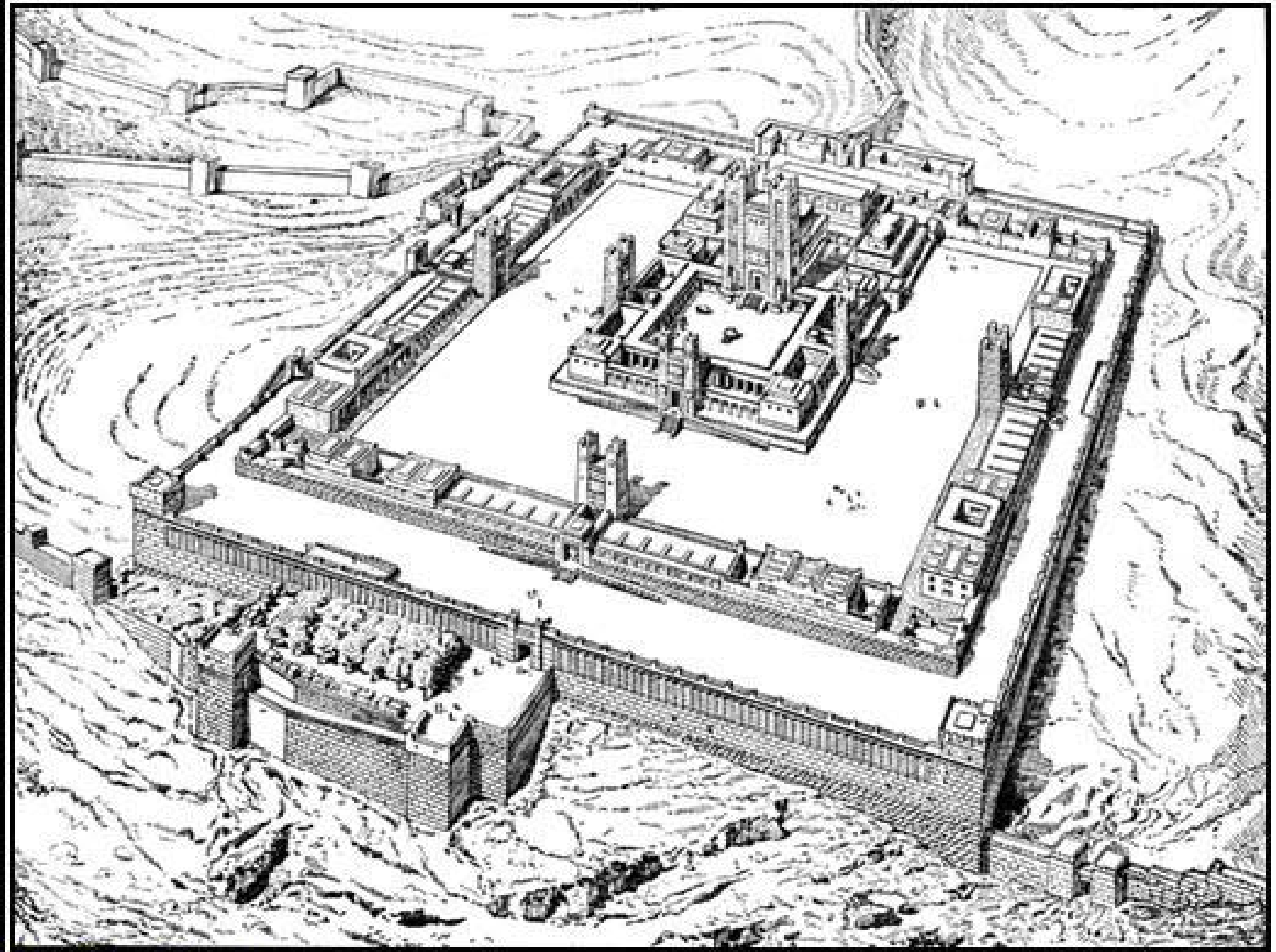

Ezekiel's Temple Complex

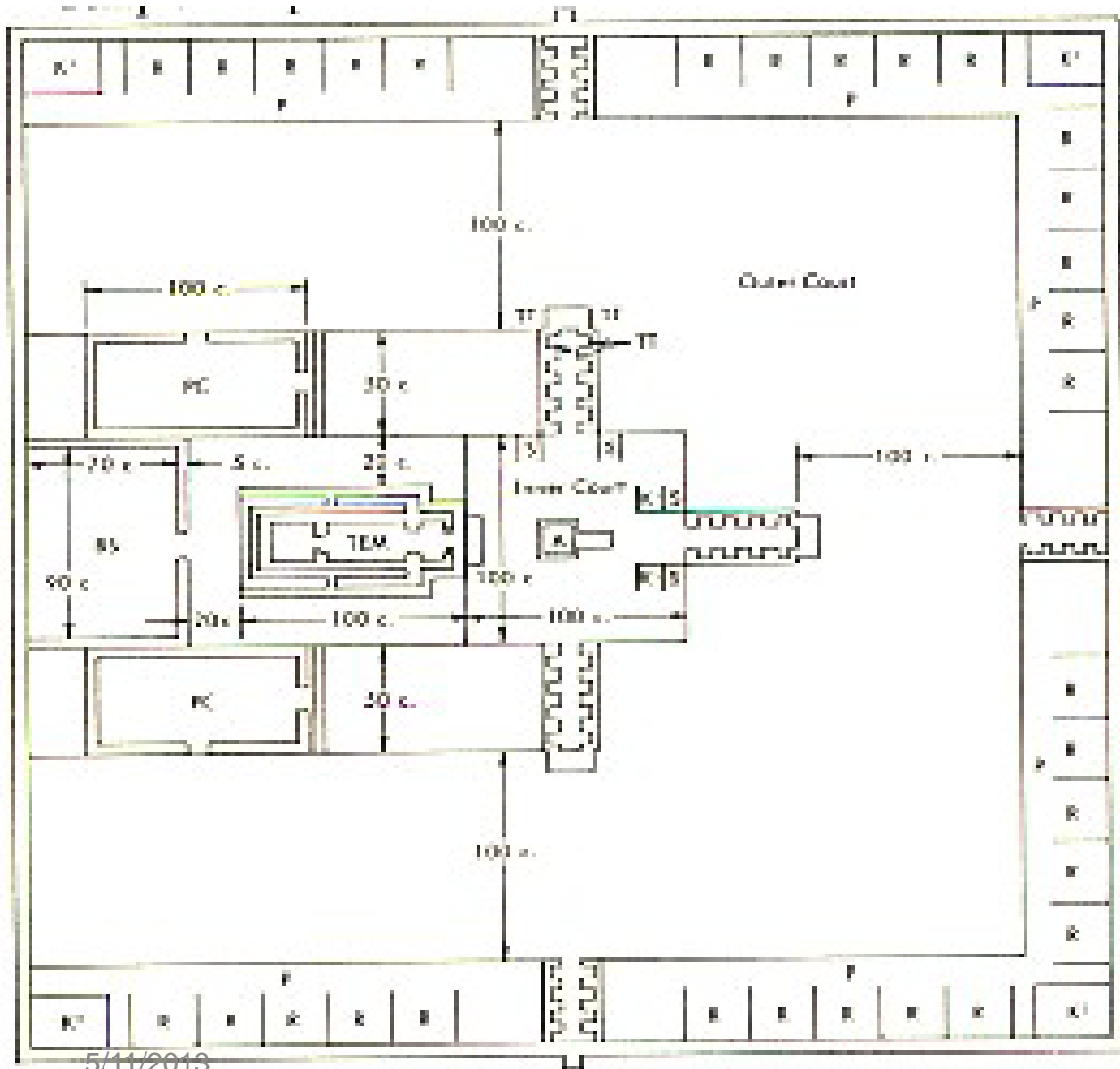

KEY

- A Altar (Eze 40-47b)
- BS Building of separation yard (Eze 41:12-13b, 15)
- K1 Kitchens for priests to boil sacrifices (Eze 46:19-20)
- K2 Kitchens for priests to boil peoples sacrifices (Eze 46:21.24)
- P Pavement (Eze 40:17-18)
- PC Priests chambers (Eze 42:1-14)
- R Rooms in outer court for storage or priests (Eze 40:17)
- S Rooms for singers (priests) (Eze 40:44-46)
- TT Tables for slaughter or sacrifices (Eze 40:39-43)
- TEM Temple proper (Eze 40:48-41:11, 13a, 14, 16, 23-26)
- Inner court (Eze 40:4-7a)
- Outer court (Eze 40:17-19, 23, 27, 39-43)
- Width from outer gates to inner gates (Eze 40:19, 23, 27)

EZEKIEL'S TEMPLE, COURTS, WALLS, AND GATES

Temple Courts, Walls and Gates

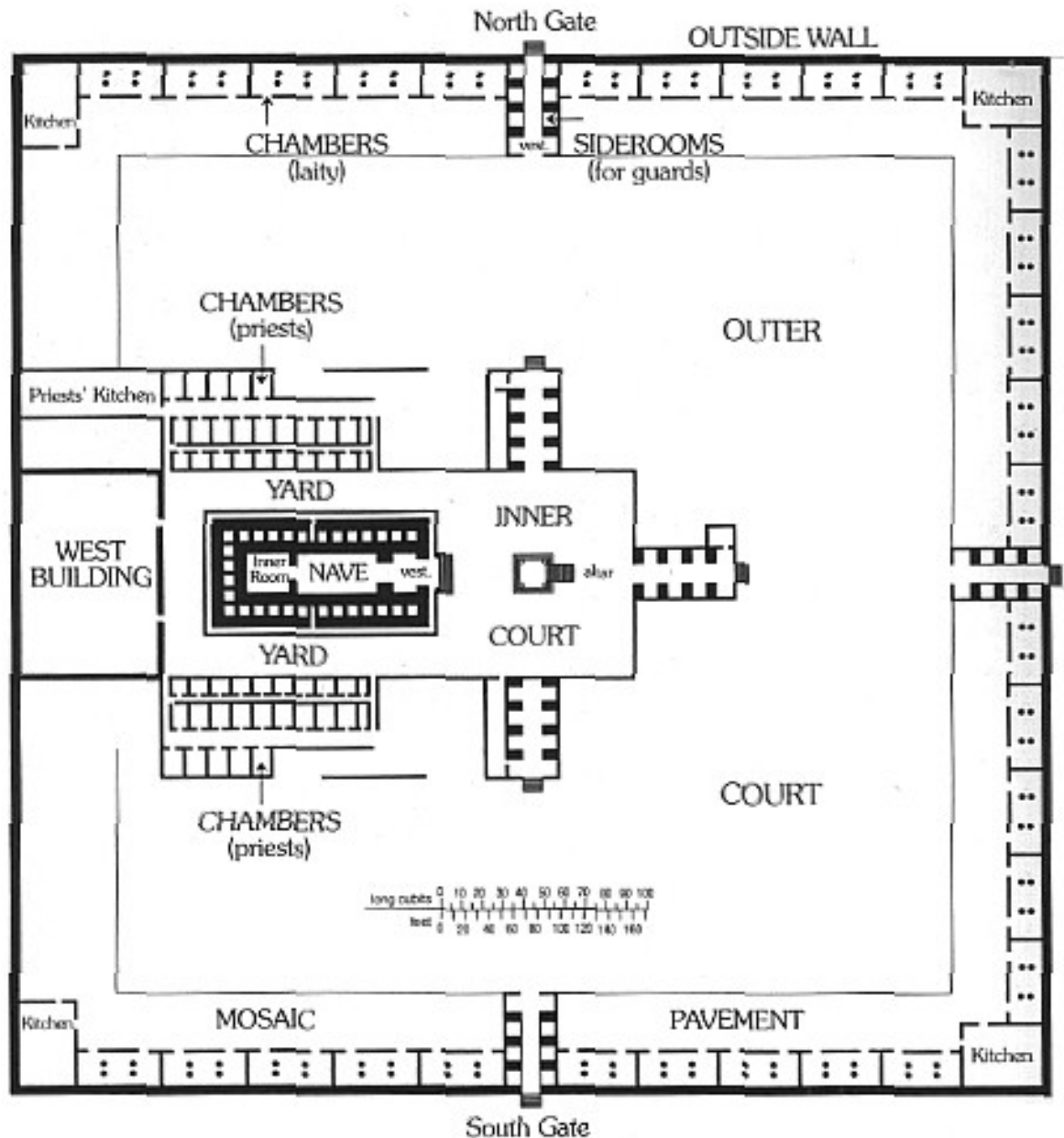

Ezekiel's Temple

Ezekiel 40-48

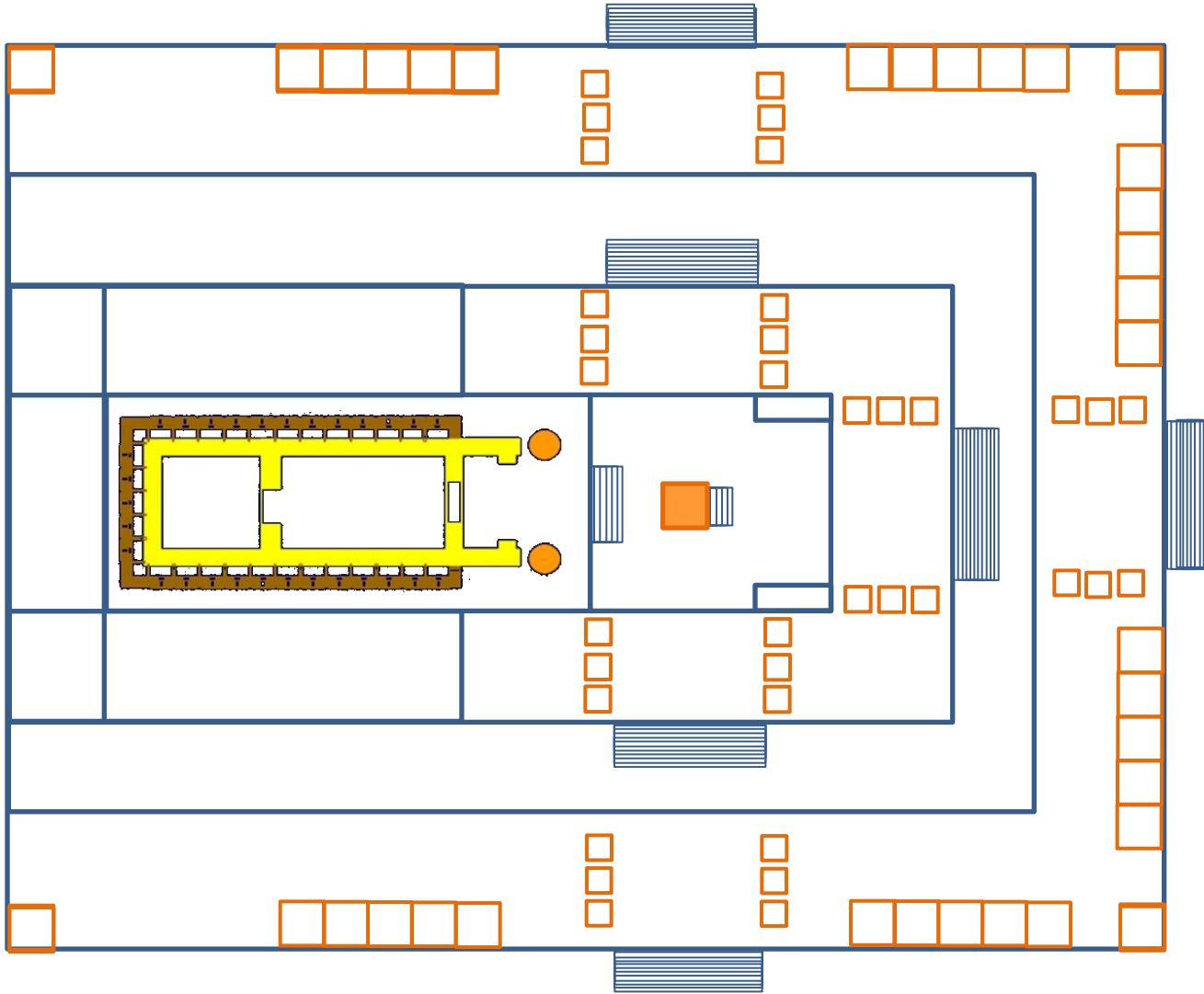

Ezekiel's Temple – Upper Terrace

Ezekiel 40-48

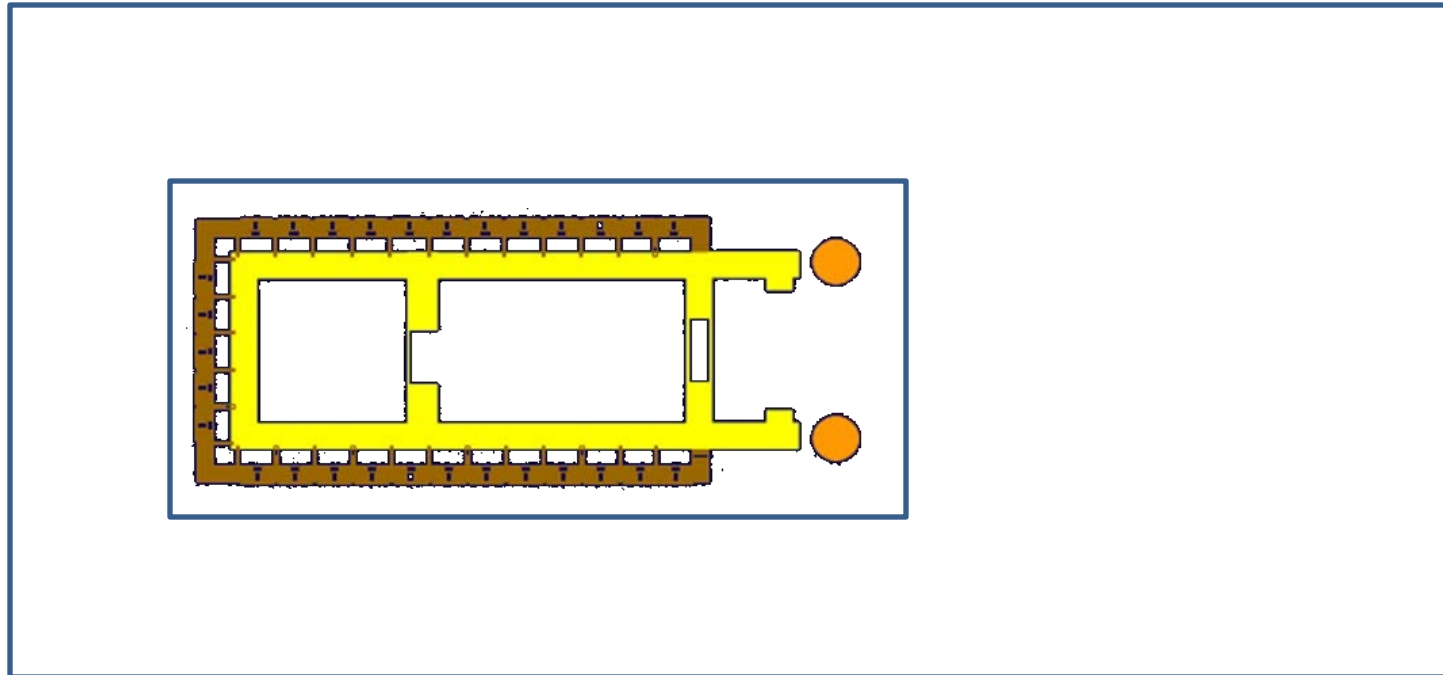

Ezekiel's Temple – Middle Terrace

Ezekiel 40-48

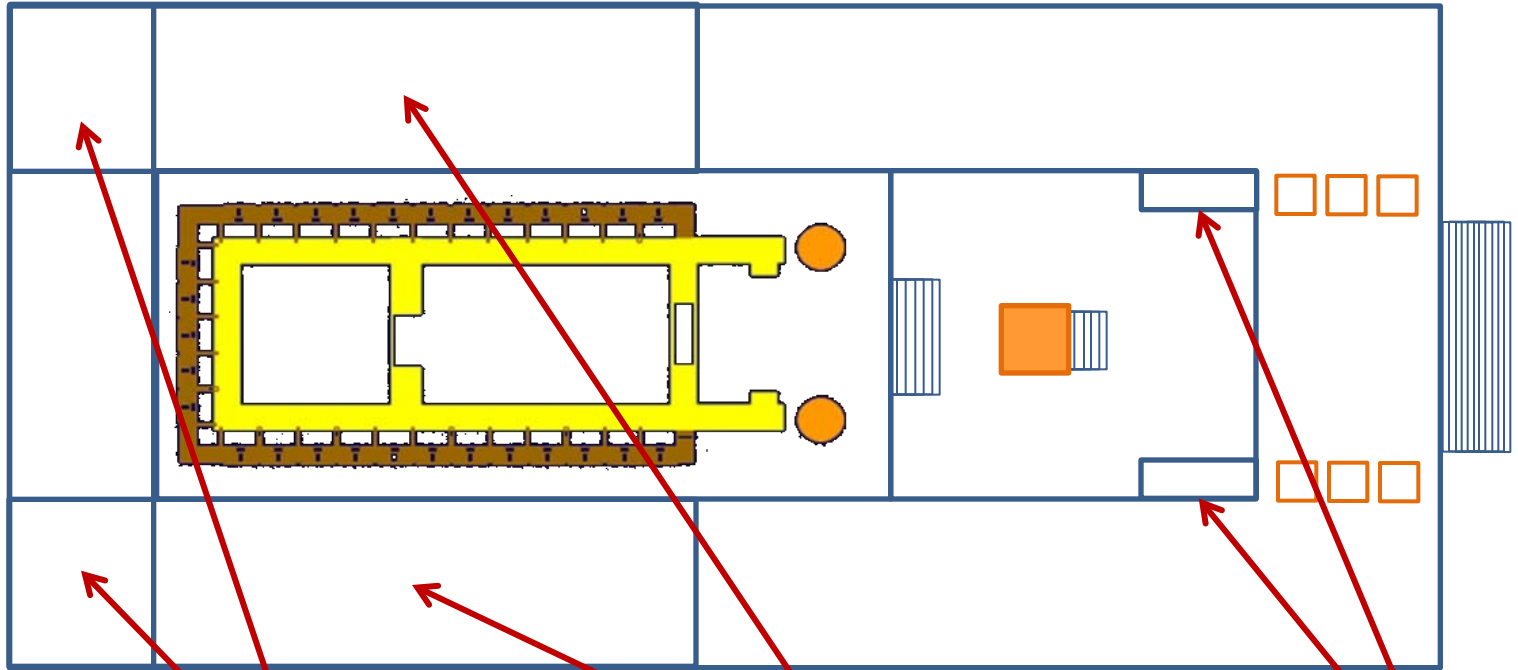

Priest's Kitchens
Ezekiel 46:19-20

Priest's Chambers
Ezekiel 42:1-14

Chambers for Singers
Ezekiel 40:4-46

Ezekiel's Temple – Middle Terrace

Ezekiel 40-48

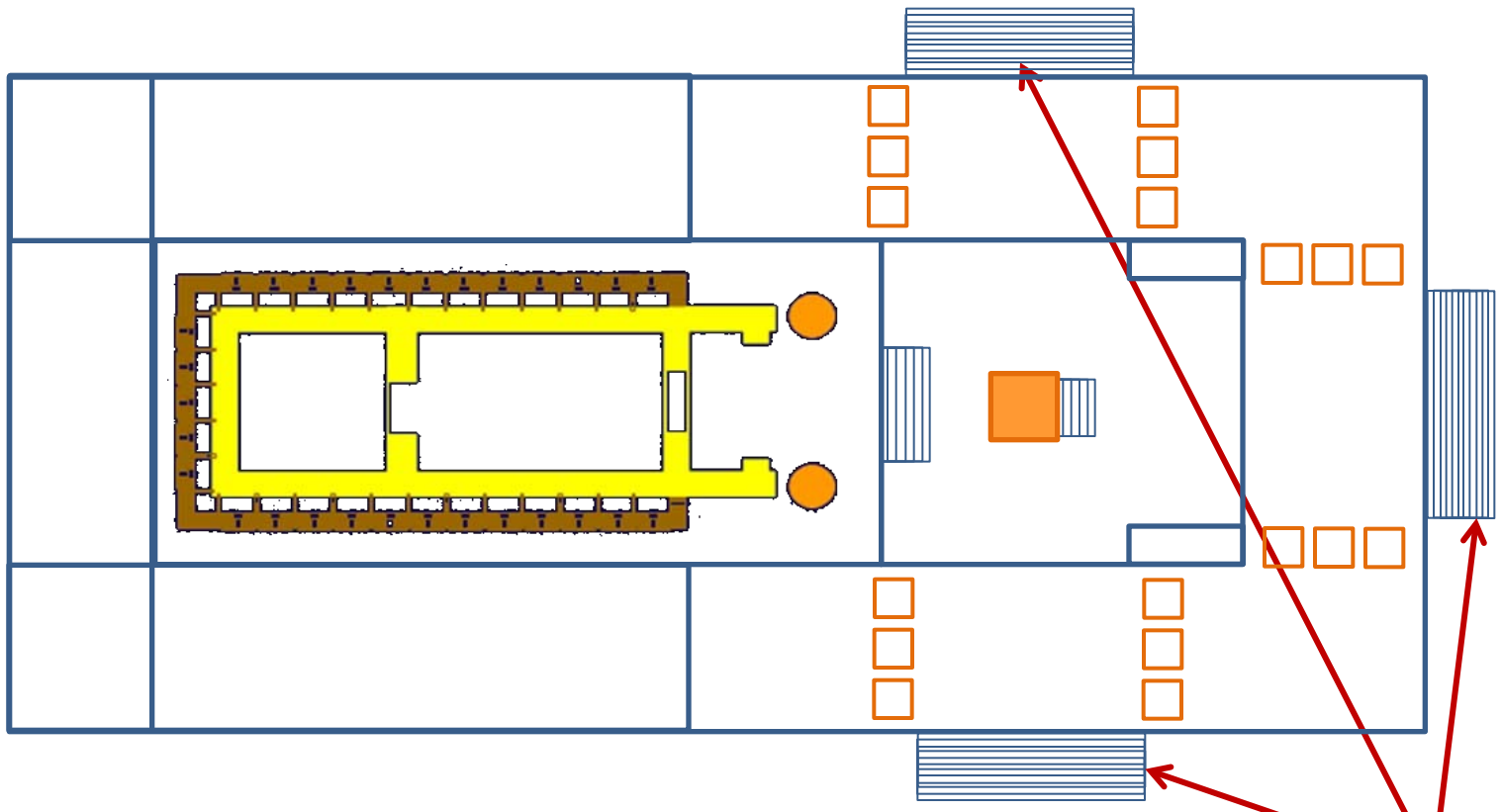

Inner Gates
Ezekiel 40:28-31;
40:32-34; 40:38-43

Ezekiel's Temple – Lower Terrace

Ezekiel 40-48

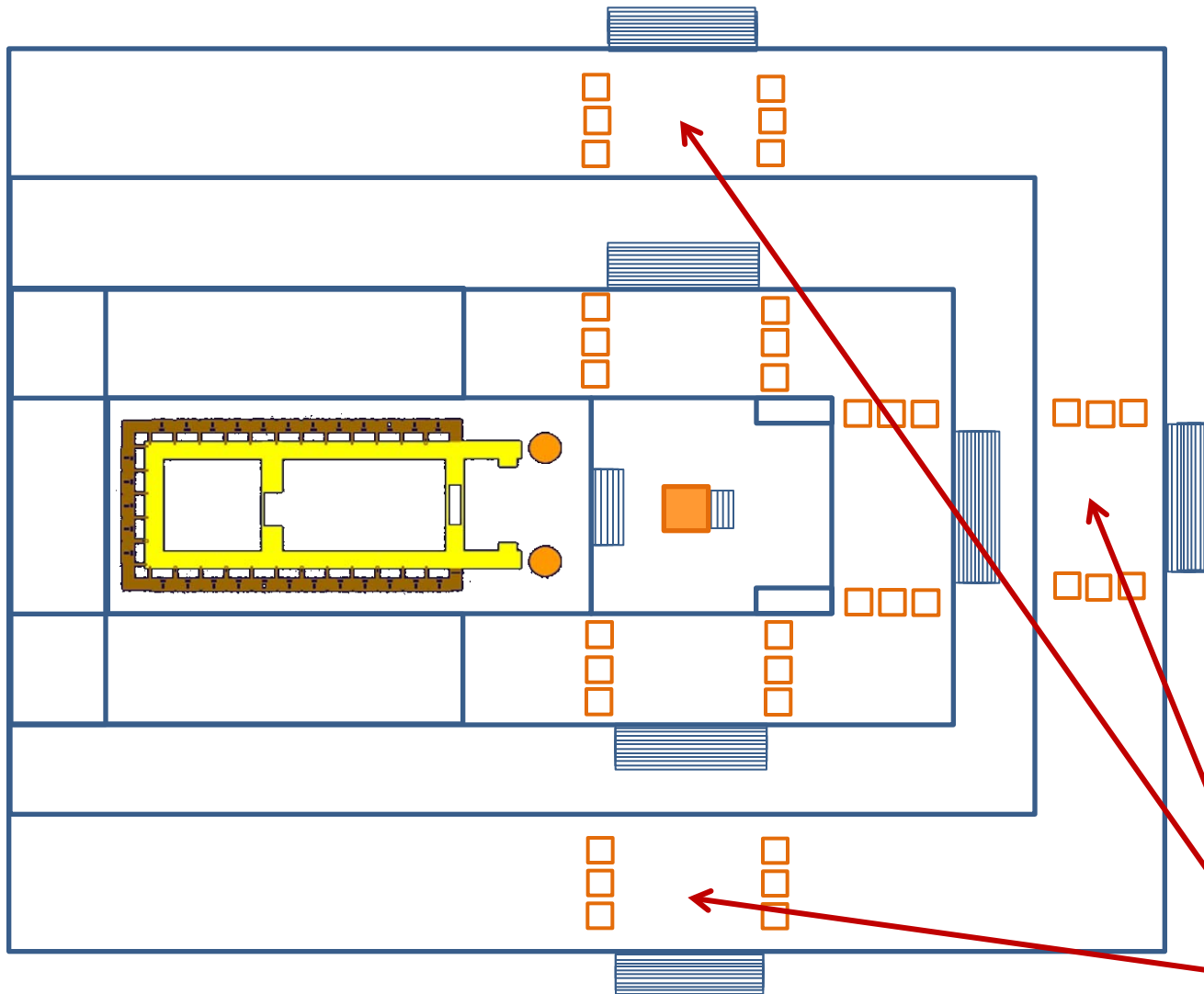

Outer Gates
Ezekiel 40:6-16;
40:20-27

Ezekiel's Temple – Lower Terrace

Ezekiel 40-48

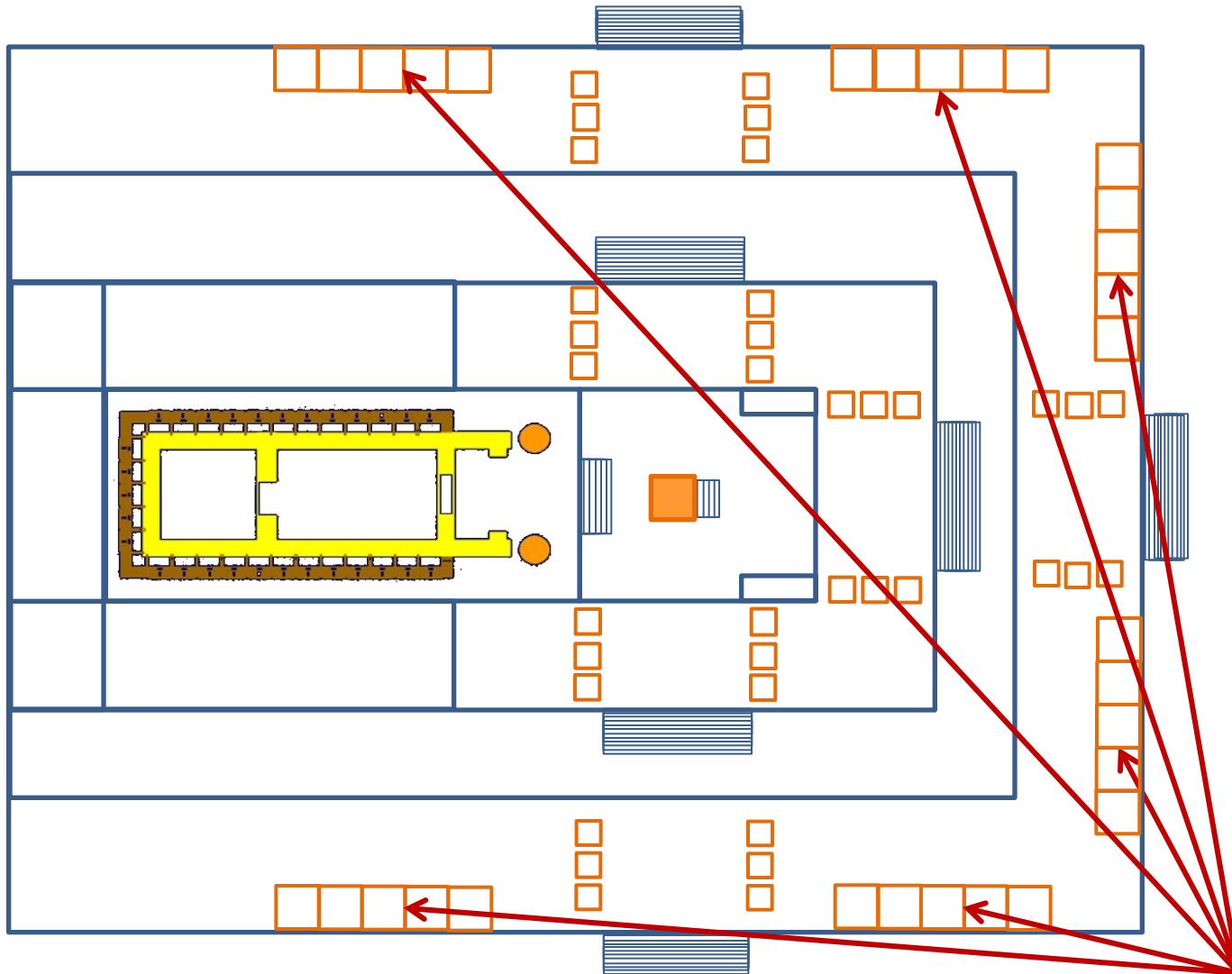

Chambers of
the Outer Court
Ezekiel 40:17-19,
41:5-11

Ezekiel's Temple – Lower Terrace

Ezekiel 40-48

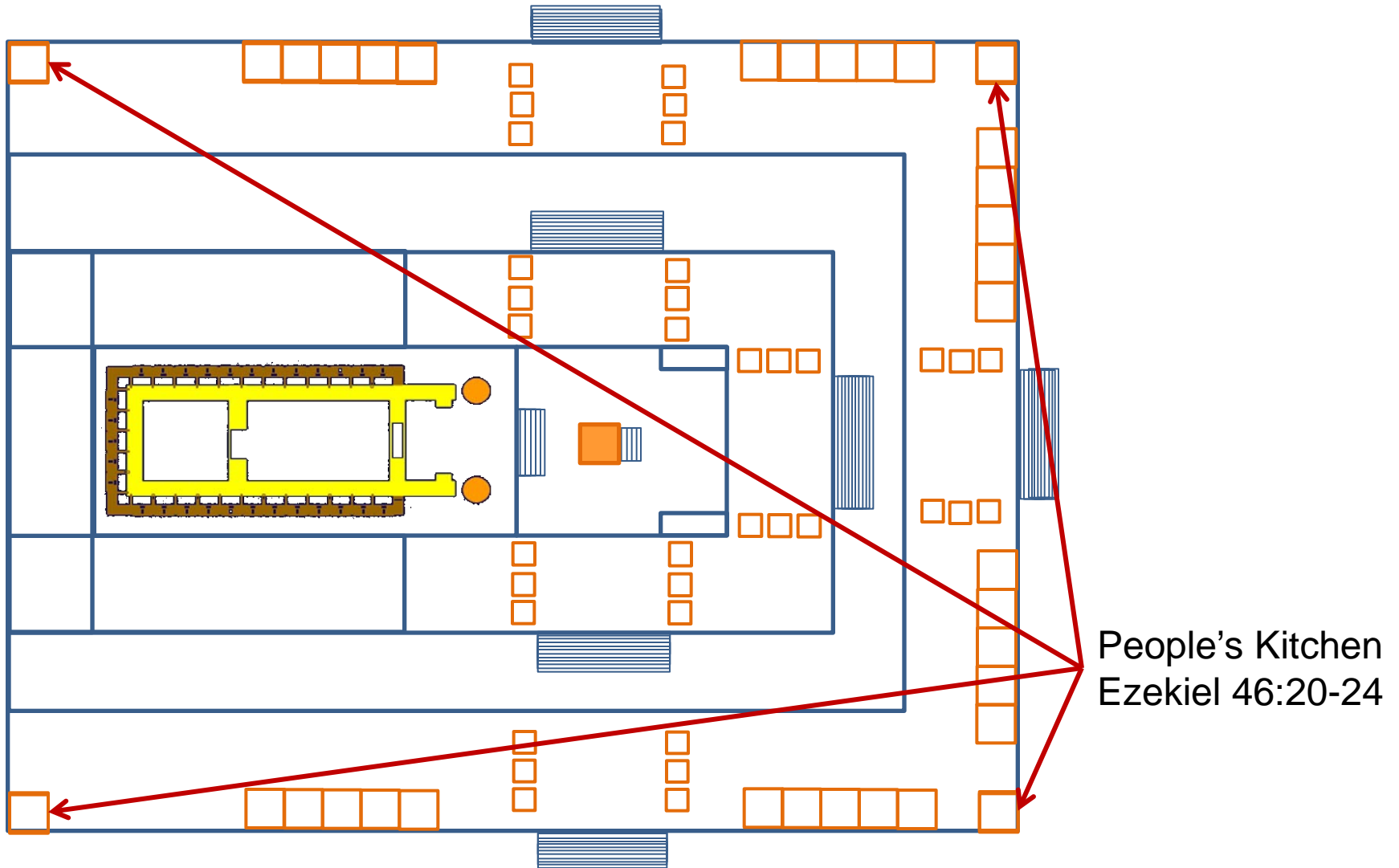

People's Kitchen
Ezekiel 46:20-24

The Gizrah
“separate place”

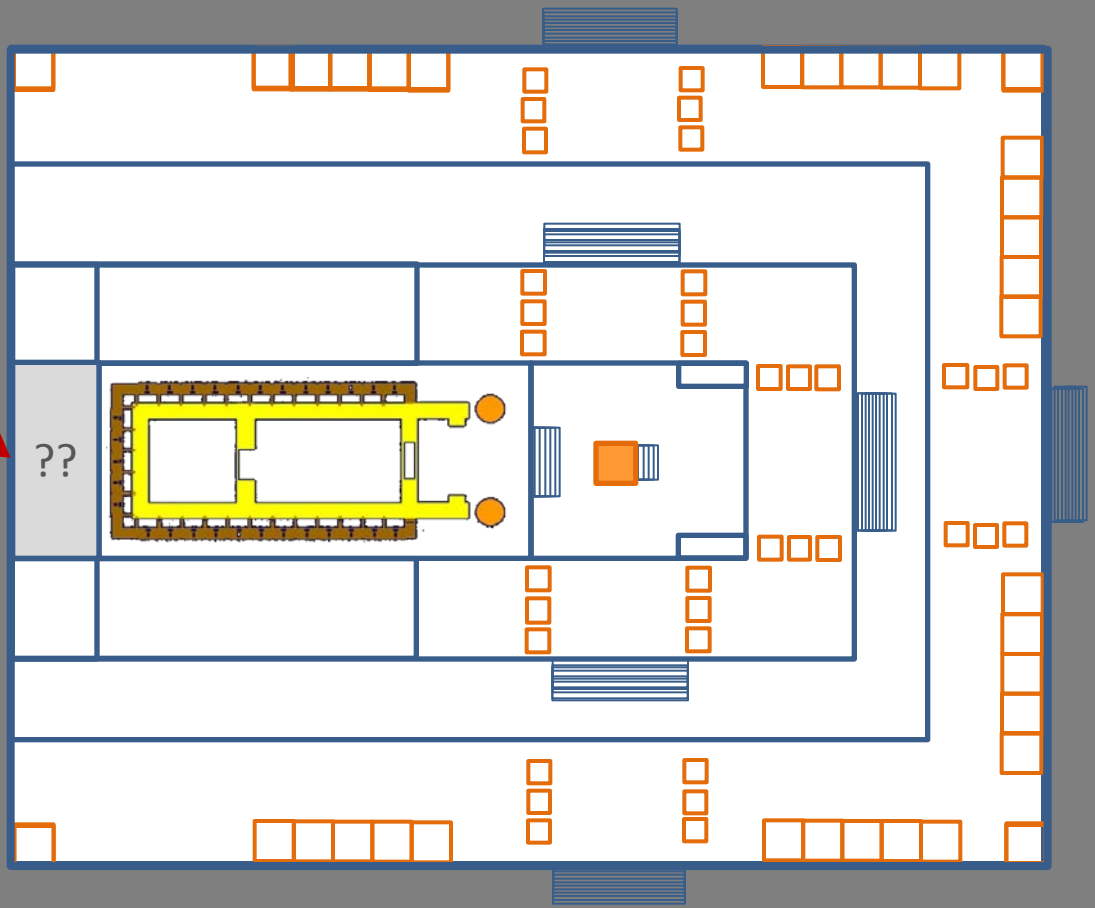
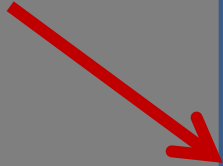

τὸ σκότος τὸ ἐξώτερον
The Darkness Outside

Millennial Temple

Gizrah → 'Separate Place' ??

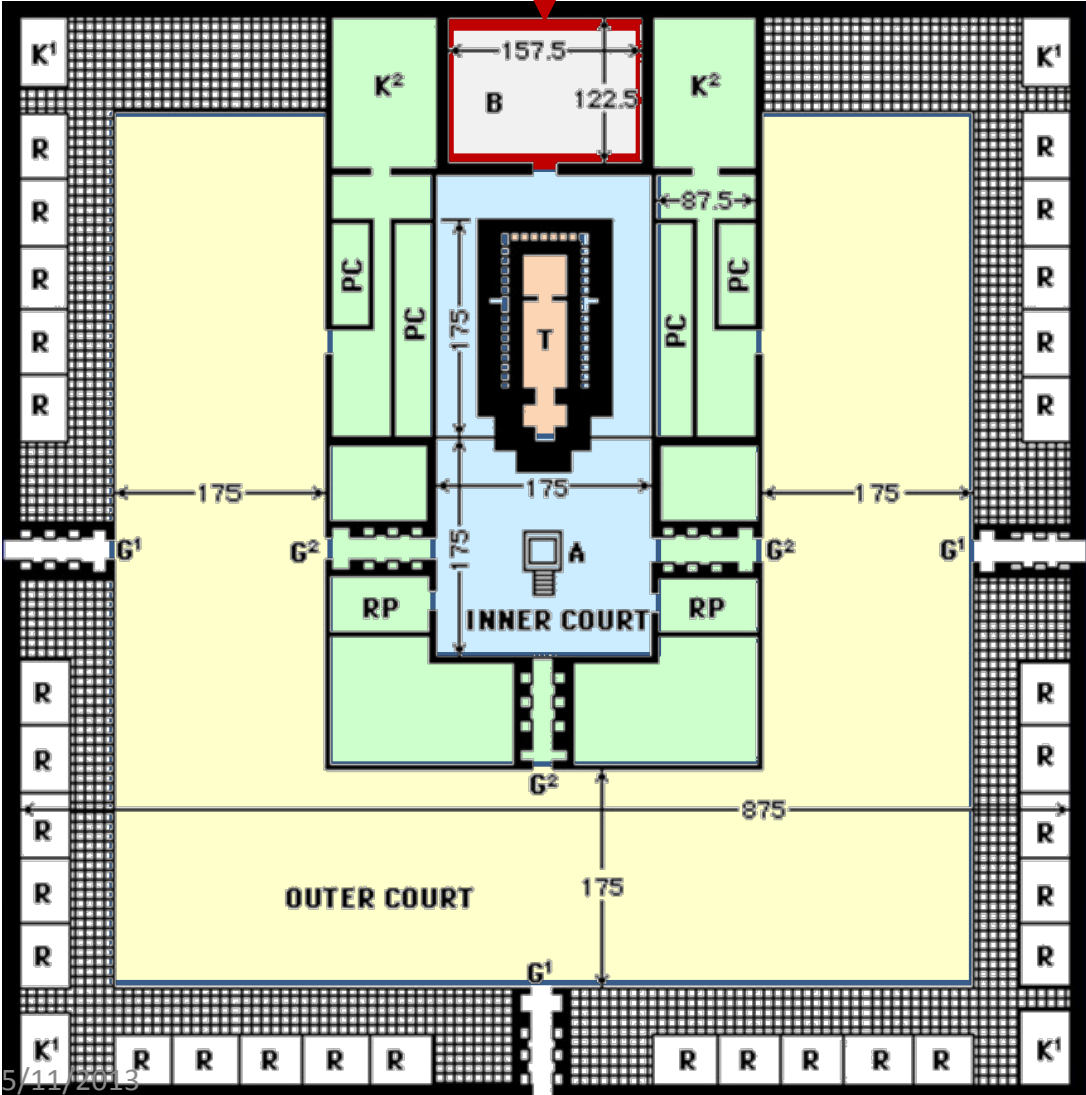

- A Altar 43:13-17
- B Building (not explained) 41:12**
- G1 Outer gates 40:6-17, 20-27
- G2 Inner Gates 40:28-37
- K1 Kitchens for people's sacrifices 46:21-24
- K2 Kitchens for priests 46:19-20
- PC Priests' chambers 42:1-14
- R 30 rooms in outer court 40:17
- RP Rooms for ministering priests 40:44-47
- T Temple Proper 40:48-41:11-26

(Dimensions in feet)

Bible Knowledge Dictionary

The Gates: Outer Court to Inner Court

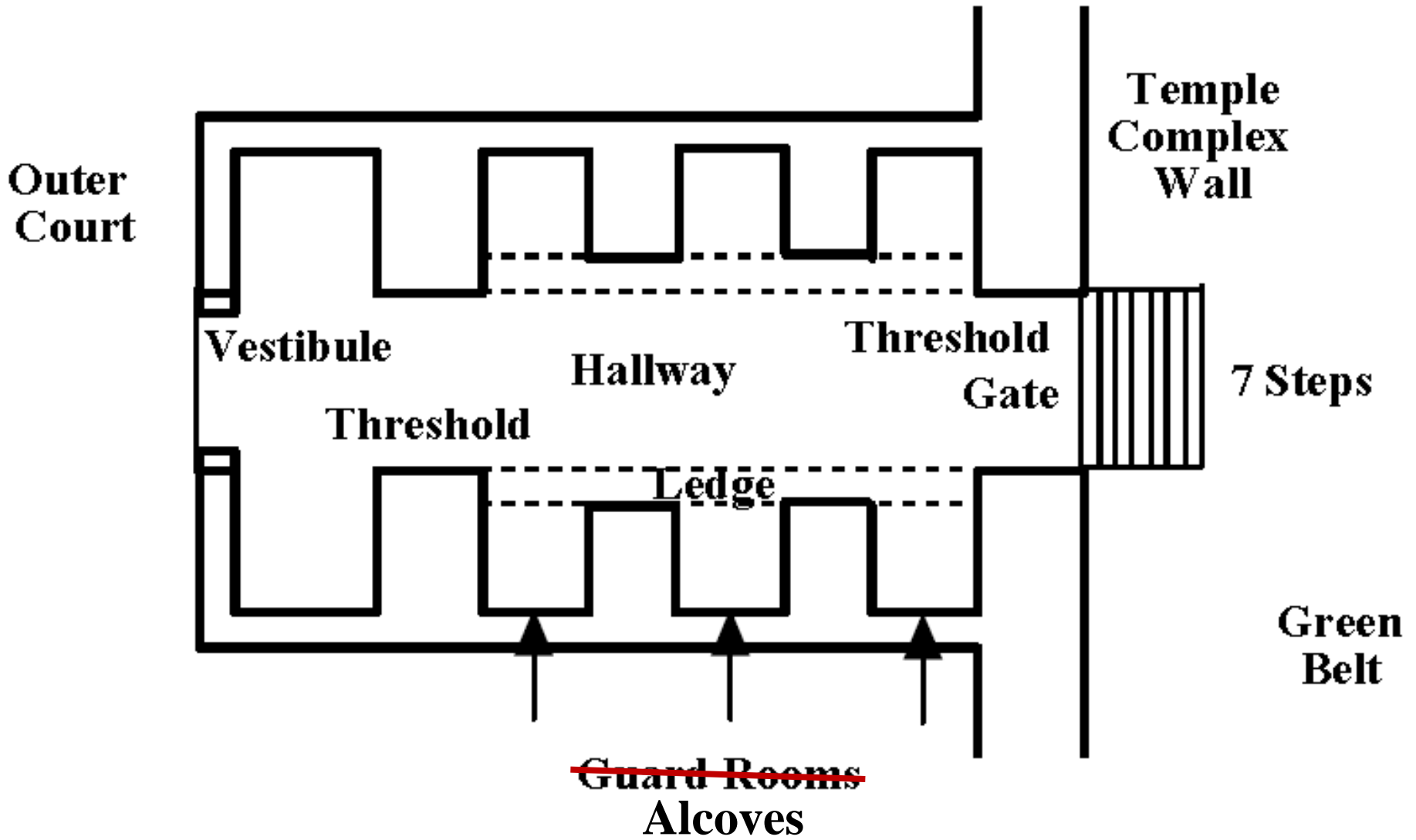

Temple Gate

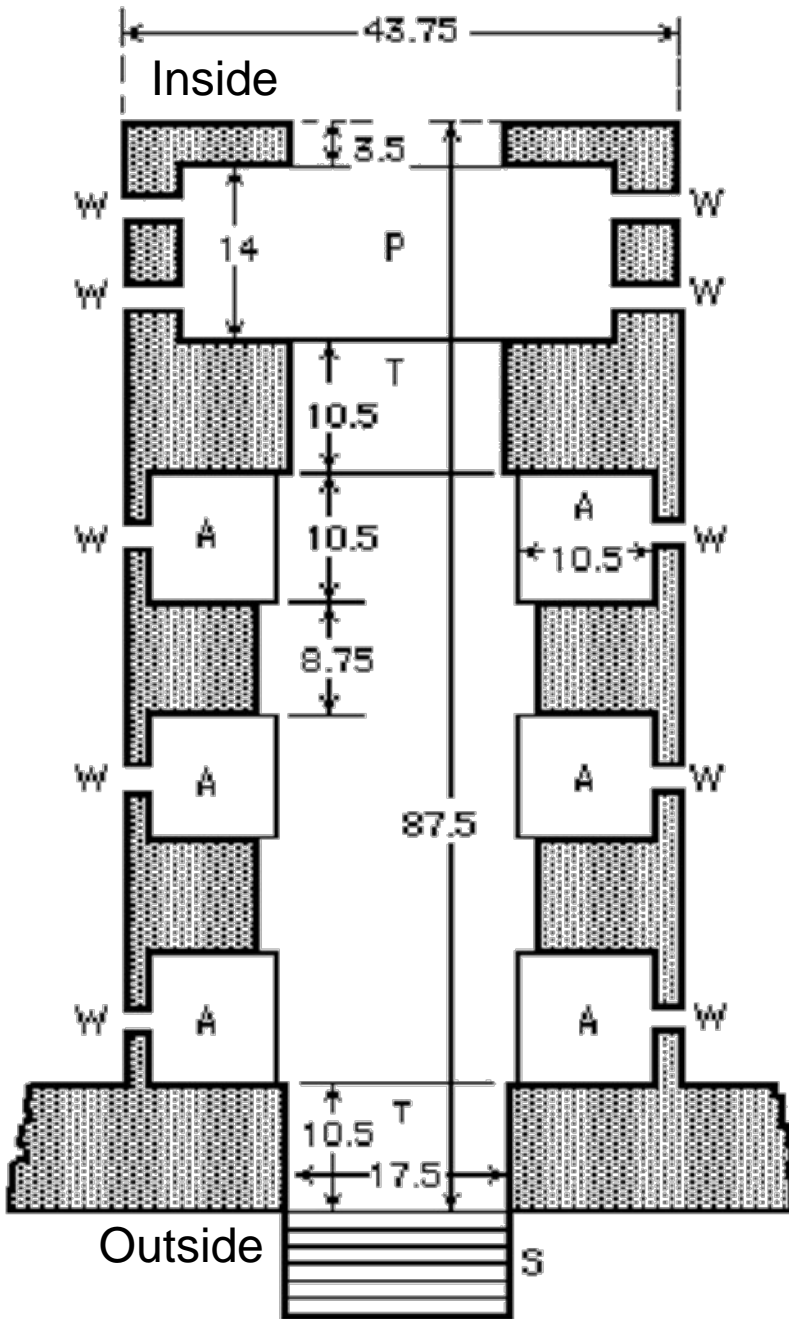

- A** Alcoves for the temple guards 40:7a,10,12
- P** Portico 40:8,9
- S** Steps 40:6a
- T** Thresholds 40:6b, 7b
- W** Windows 41:16

(Dimensions are in feet)

Bible Knowledge Dictionary

Temple Complex Outer Court

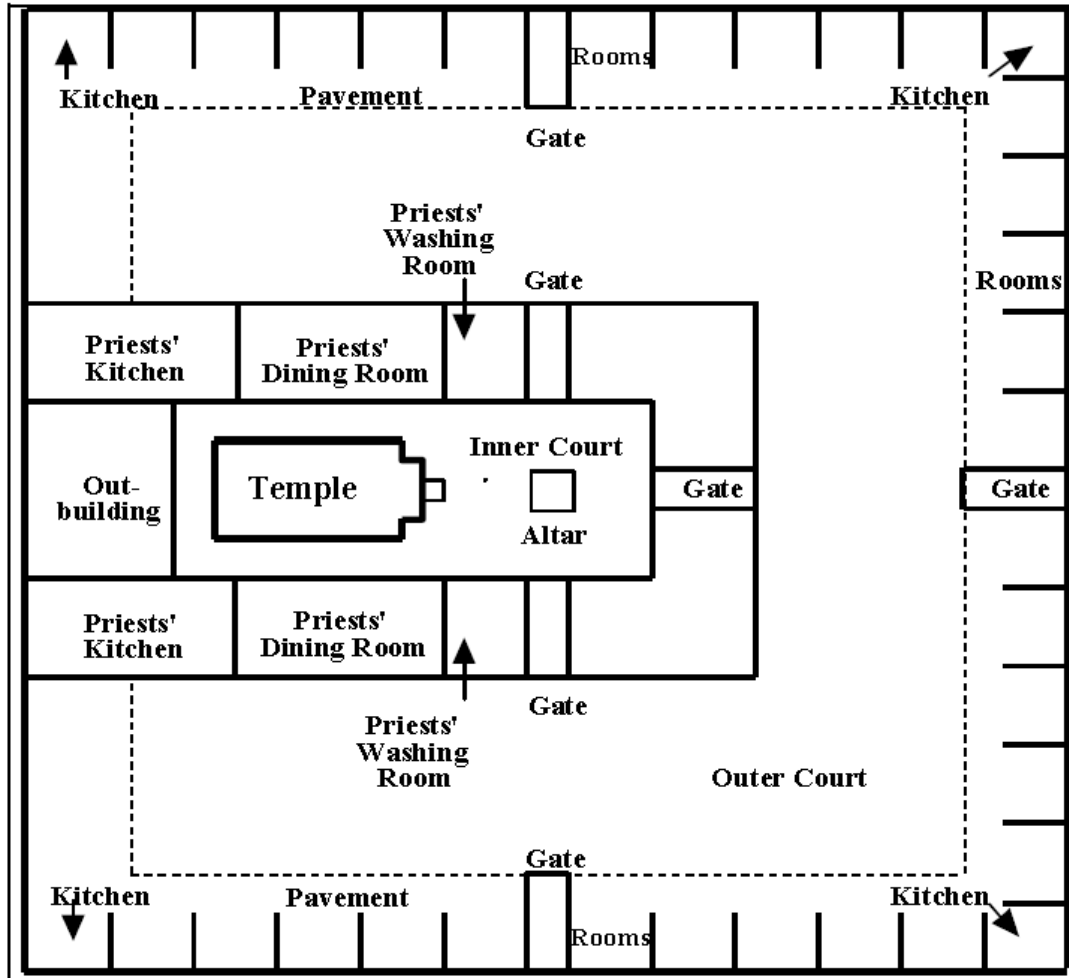

The passageway in the eastern gate complex led into a courtyard. This was the outer court that contained an inner court within it.

A pavement, probably mosaic (*2Chr 7:3; Est 1:6*), known as the lower pavement, formed a 50-cubit-wide (83 ft 4 inch) border around the outer edge of the outer courtyard (*v. 15*).

The Inner Gates

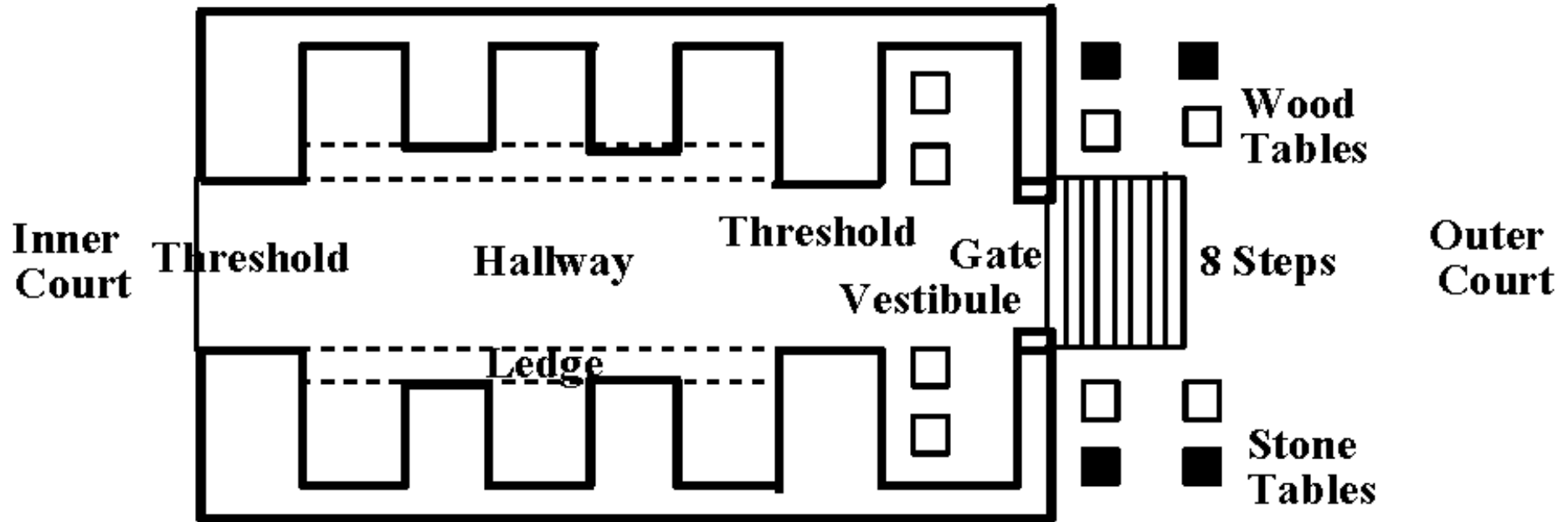

Temple Building

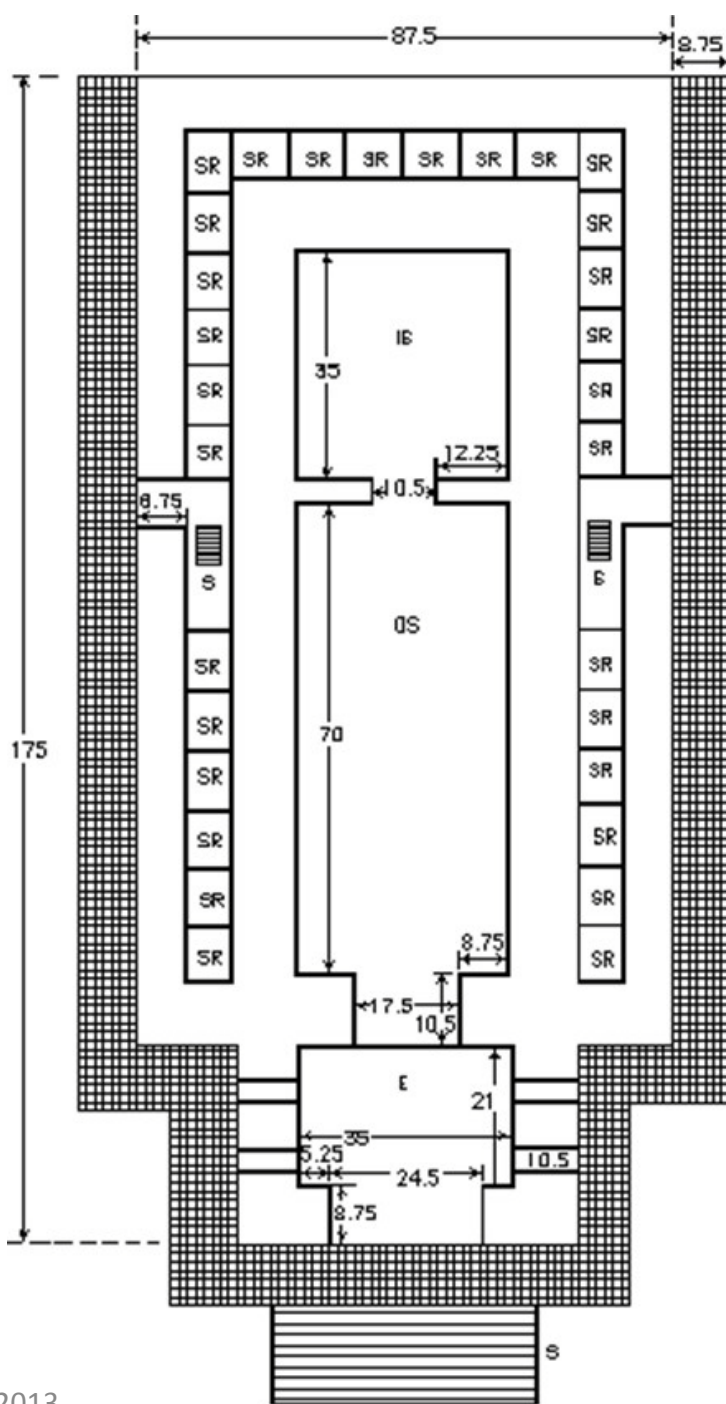

B	Base surrounding temple	41:11
E	Entrance to Temple Inner	40:48-49; 41:2a,26
IS	Sanctuary	41:3,4
OS	Outer Sanctuary	41:2b,21
P	Pillars	40:49b
SR	Sire Rooms	41:5-11
W	Windows	41:26

(Dimensions are in feet)

Bible Knowledge Dictionary

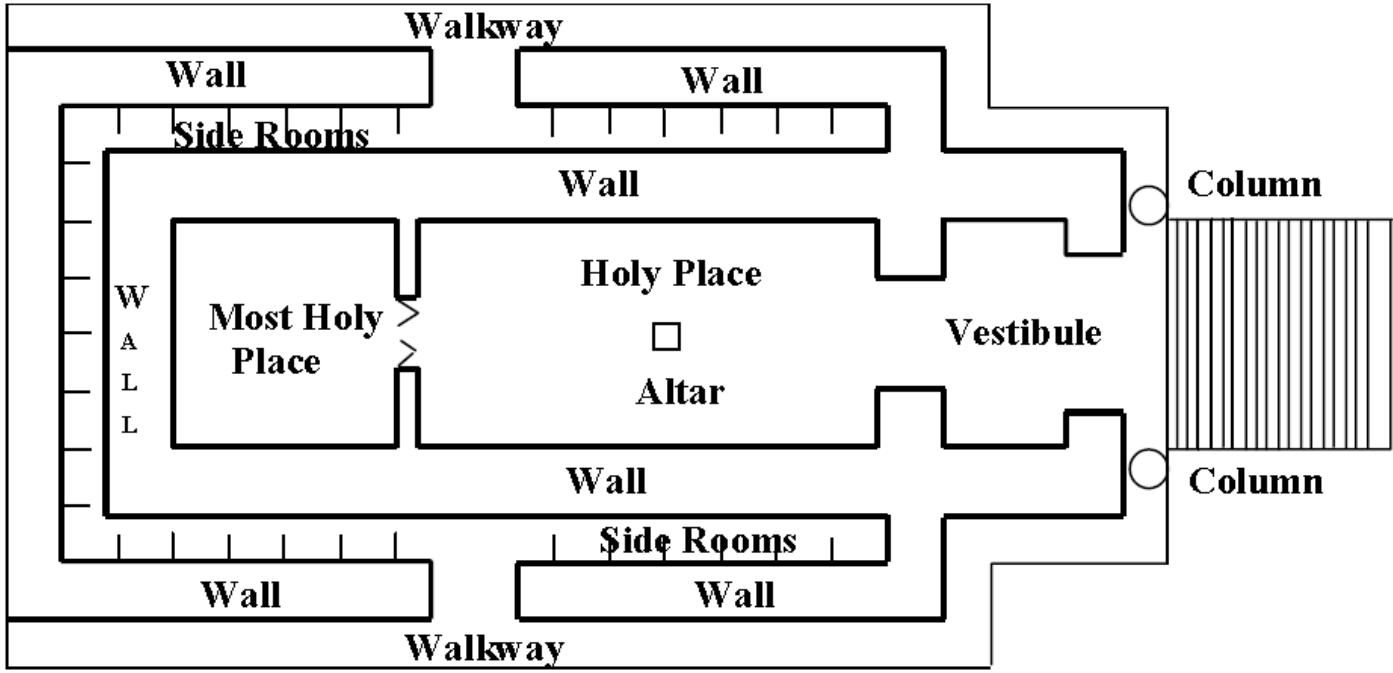

North Fascia facing the Outer Court

North Facade Facing the Outer Court

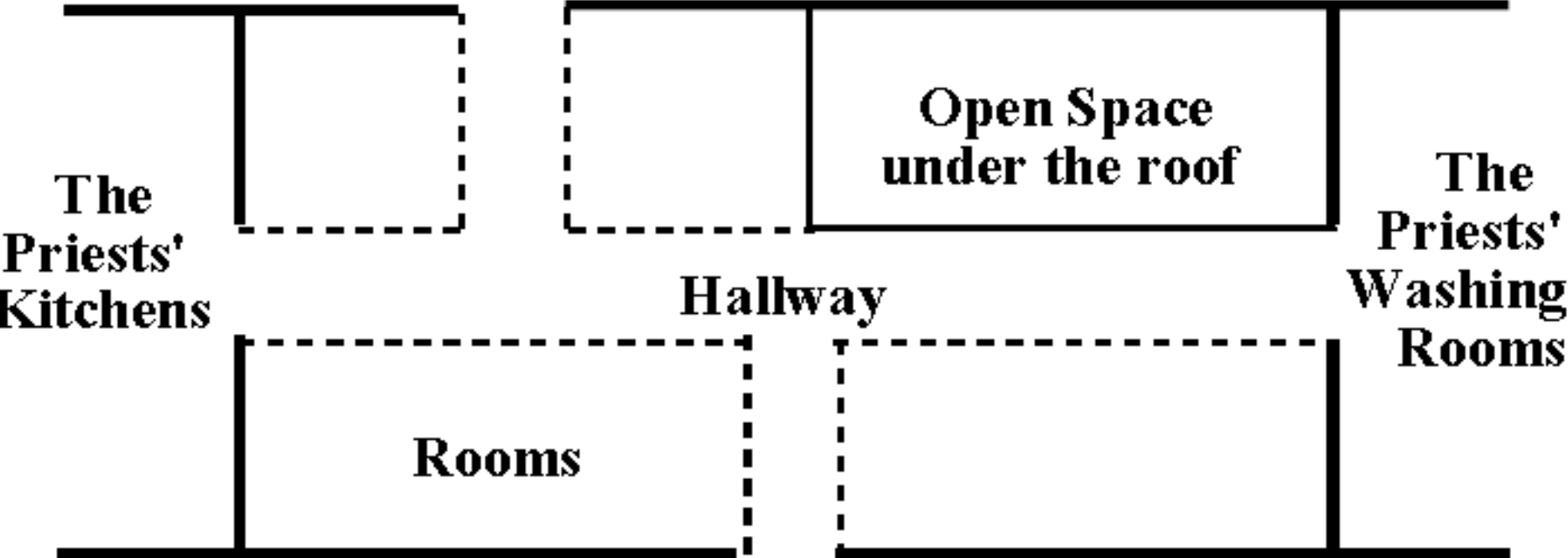

South Facade Facing the Temple

Gate System for All Gates of the Outer Court

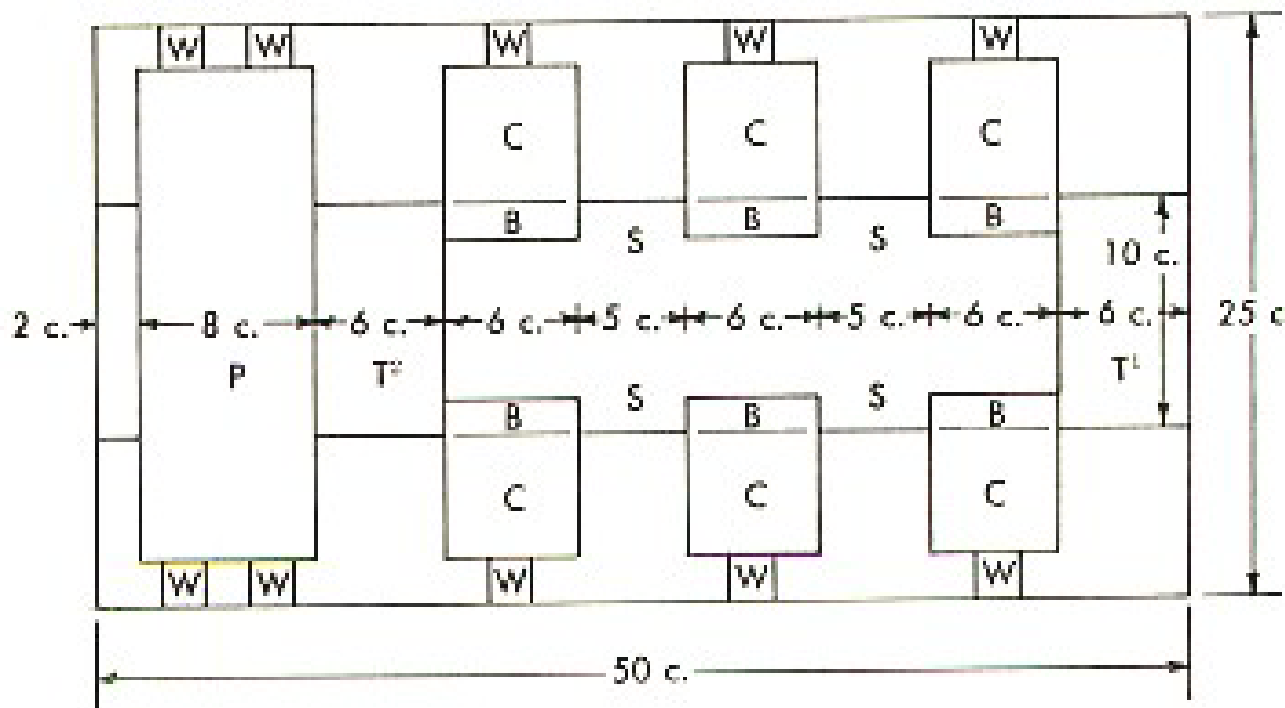

KEY

- B Borders (barriers, space) (Eze 40:12a)
 - C Chambers (side rooms, guard rooms) (Eze 40:7a, 10a)
 - P Porch (vestibule) (Eze 40:7c, 8-10b, 14)
 - S Space between chambers (Eze 40:7b, 12b)
 - T1 Threshold of the gate (Eze 40:6, 11)
 - T2 Threshold of the porch (Eze 40:7c)
 - W Windows (Eze 40:16)
- Overall height, length, and width of the gate (Eze 40:13-15)

The Plan of the Temple Sanctuary

- E1 Entry to the Temple (Eze 41:2a; 41:23.25)
- E2 Entry to the Holy of Holies (Eze 41:3; 41.23.75)

H Holy Place (sanctuary) (Eze 41:2b, 21b)

HH Holy of Holies (Eze 41:4)

P Porch (vestibule) (Eze 40:48-49)

PI Pillar (Eze 40:49)

PiH Pilaster [jamb, post]of the entry to the Holy of Holies (Eze 41:3-4)

PLP Pilaster of the porch (Eze 40:48)

PLT Pilaster of the Temple proper (Eze 41 :11)

SC Side chambers of the Temple sanctuary (Eze 41:5b-11a)

S Space left [platfotm around the Temple (Eze 41:11b)

W Wall of the house (Eze 41:5a)

Overall dimensions of the Temple with yard on either side Eze 21:13a, 14)

Windows (Eze 41:16-20) on the porch and side chambers and decorations (Eze 41:16-20)

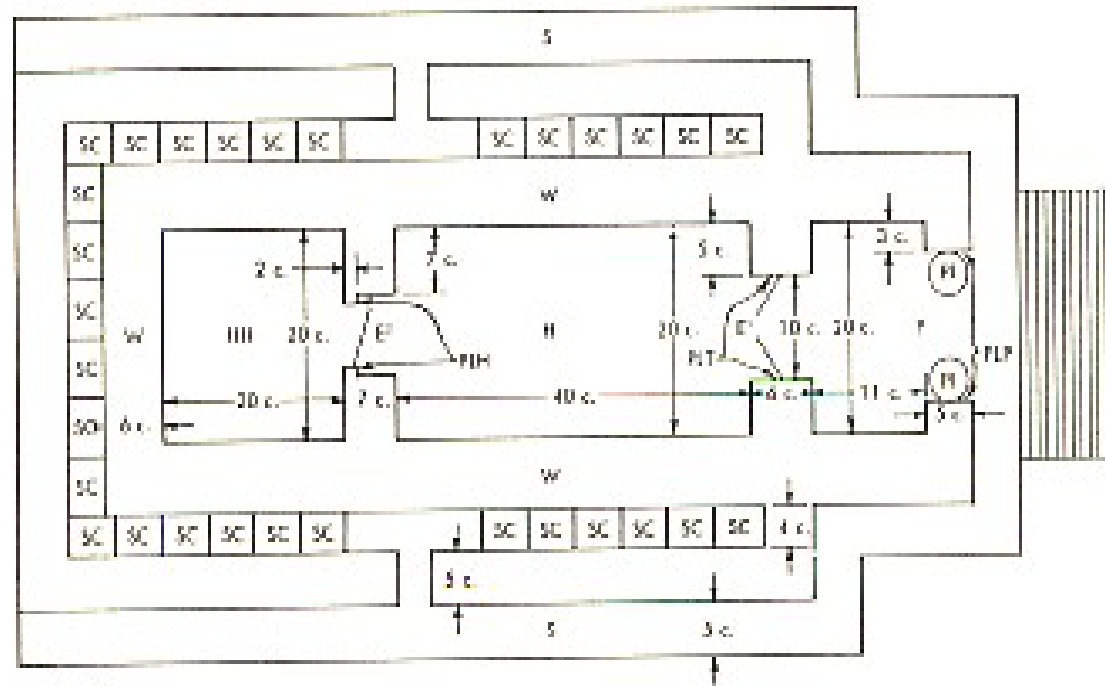

Ezekiel 43:13

13] And these are the measures of the altar after the cubits: The cubit is a cubit and an hand breadth; even the bottom shall be a cubit, and the breadth a cubit, and the border thereof by the edge thereof round about shall be a span: and this shall be the higher place of the altar.

These are “long” cubits: a cubit + a handbreadth: ~22 inches.

(Solomon had used “short” cubits: ~ 18 in.)

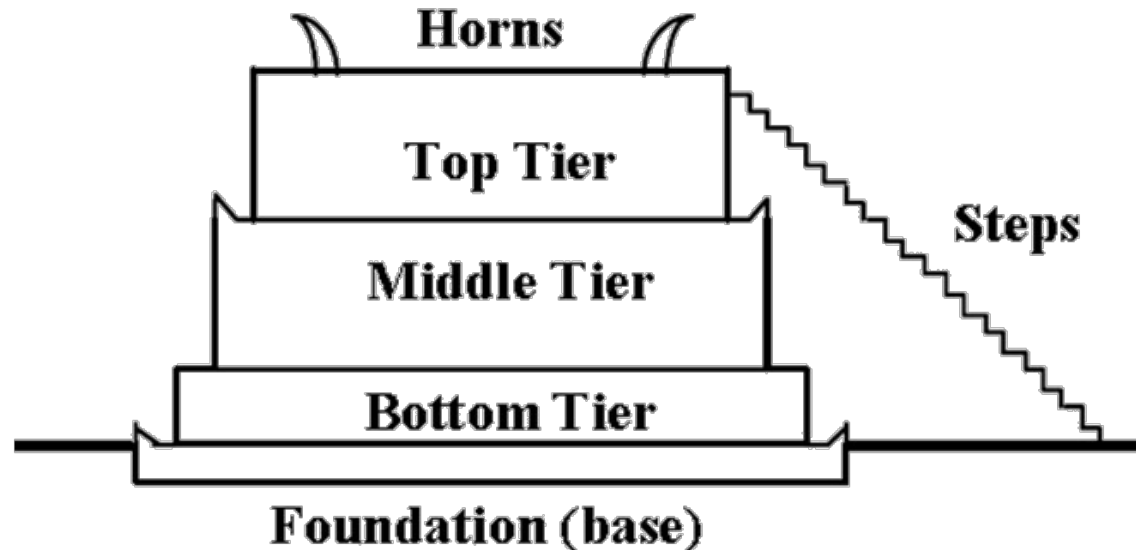

Millennial Alter

The total size of this altar was about 30 feet square at the bottom, 20 feet square at the top, and 16 feet 8 inches high.

Solomon's brazen altar had been smaller (2Ch 4:1).

This design made this altar resemble a small ziggurat.

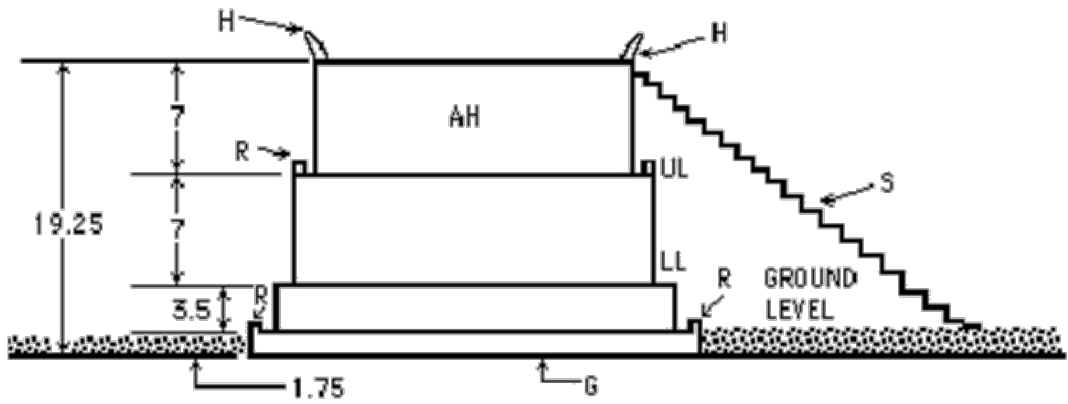
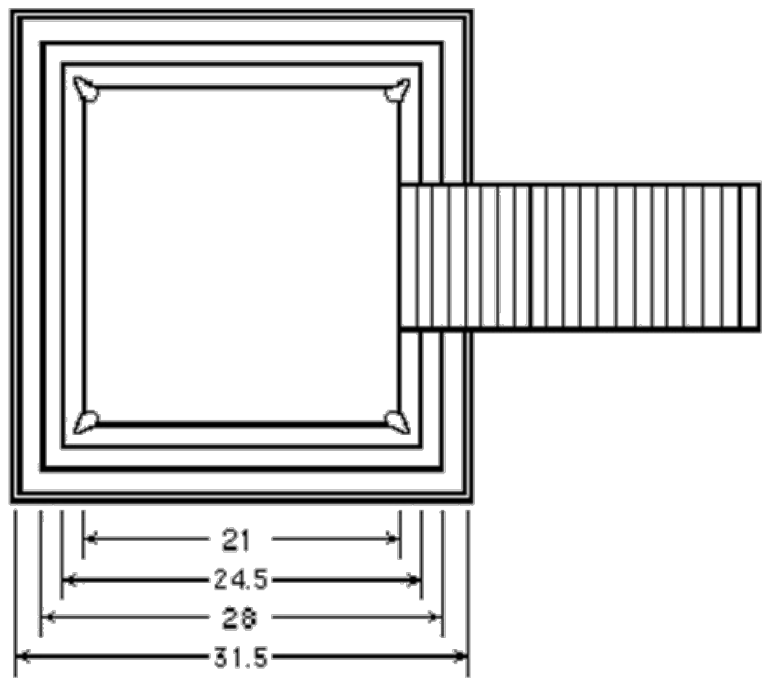

- AH Altar Hearth 43:16
- G Gutter 43:13-14
- H Horns 43:15
- LL Lower ledge 43:14
- R Rims 43:13,17
- S Steps 43:17b
- UL Upper ledge 43:17

(Dimensions are in feet)

Altar of Sacrifice

0606

ALTAR OF SACRIFICE

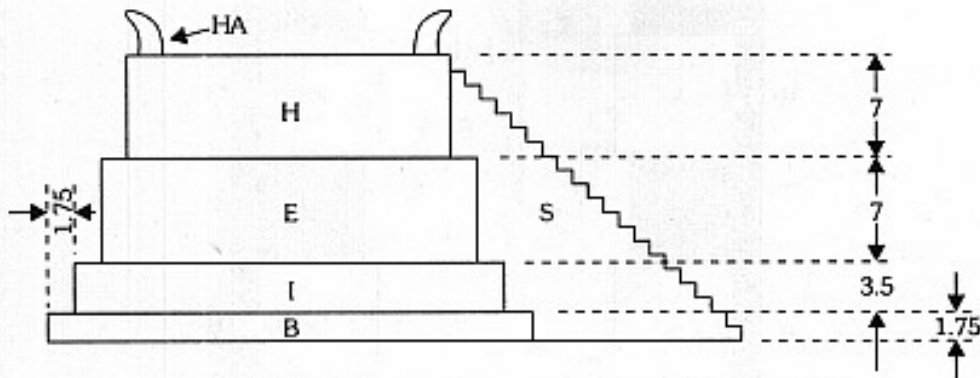
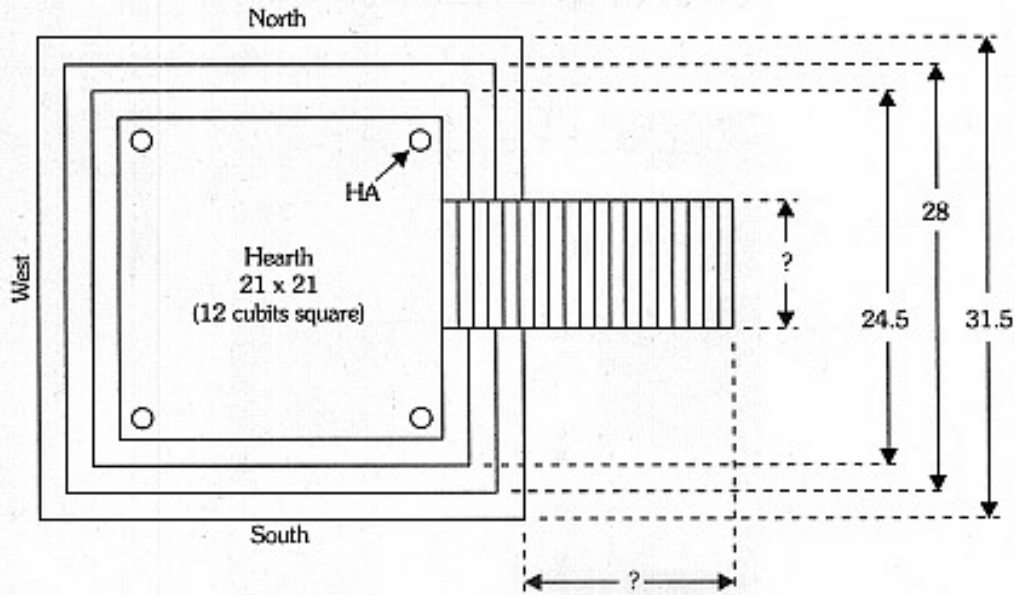

Dimensions are in feet. 1.75 feet = 1 long cubit.

- H Altar hearth (43:15-16)
- E Enclosure, supporting higher ledge (43:14, 17)
- I Interior, supporting lower ledge (43:14)
- B Base (43:13)
- HA Horns of the altar (43:15, 20)
- S Steps (43:17b; cf. 40:47b)

Source: Ezekiel, by Ralph Alexander, Moody Press, Chicago, 1976.

Chapter 45 The Temple Grounds

The Prince's Land to Judah's Territory

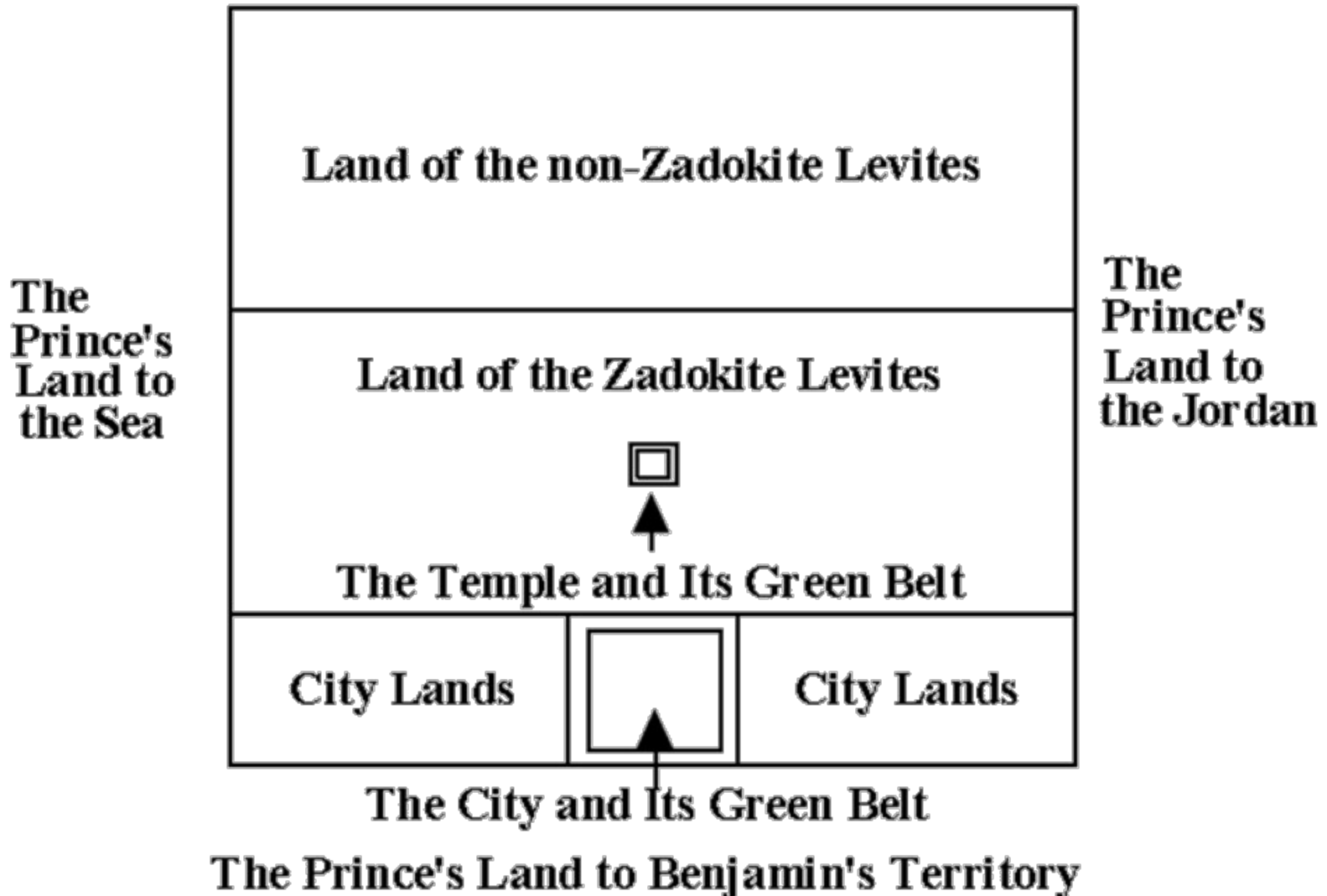

The Holy District Ezekiel 45

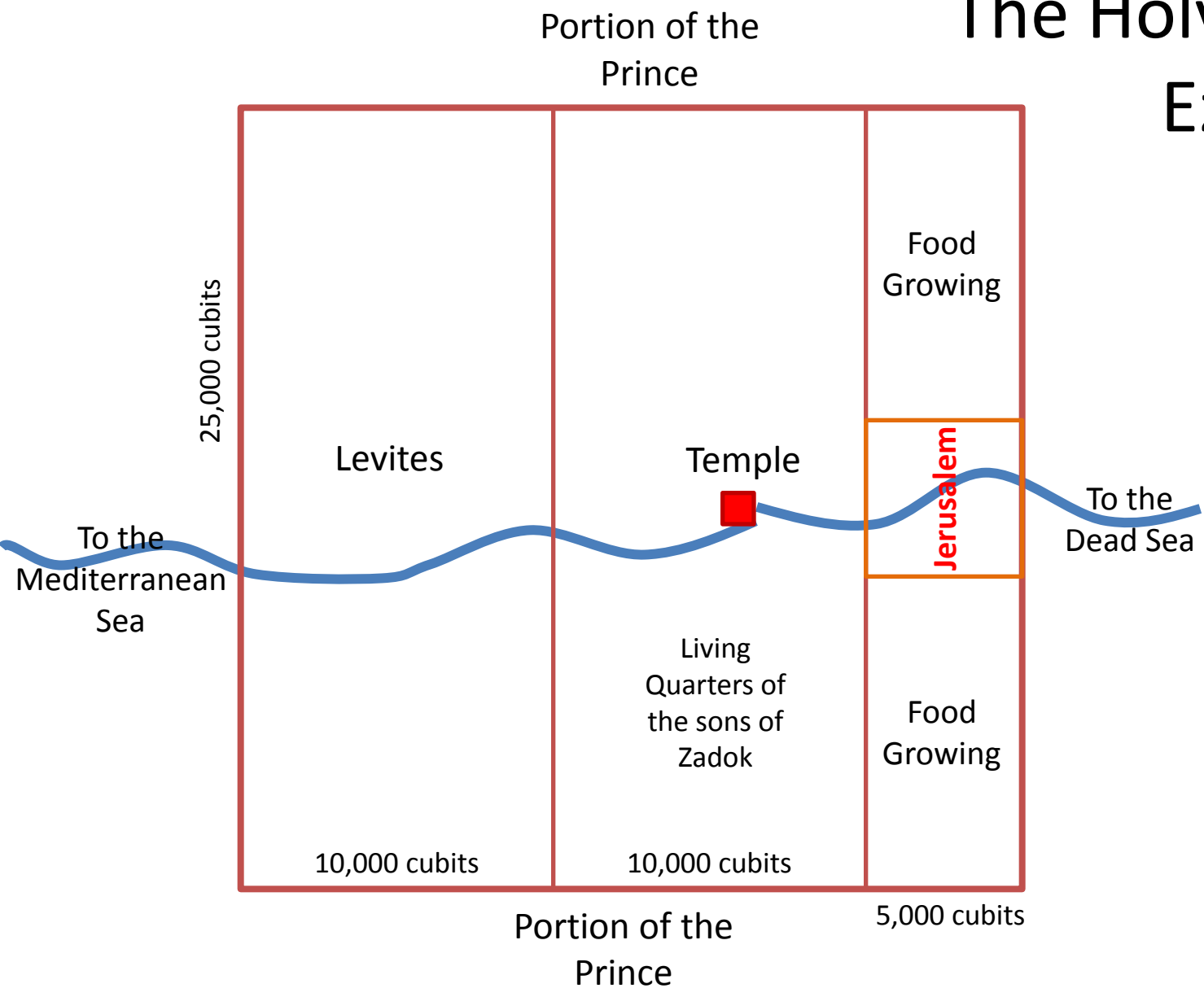

25,000 cubits by 10,000 cubits (~8.3 miles by ~3.3 miles)
 25,000 reeds by 10,000 reeds (~50 miles by ~20 miles)

Ezekiel 46:19-20

19] After he brought me through the entry, which was at the side of the gate, into the holy chambers of the priests, which looked toward the north: and, behold, there was a place on the two sides westward.

20] Then said he unto me, This is the place where the priests shall boil the trespass offering and the sin offering, where they shall bake the meat offering; that they bear them not out into the utter court, to sanctify the people.

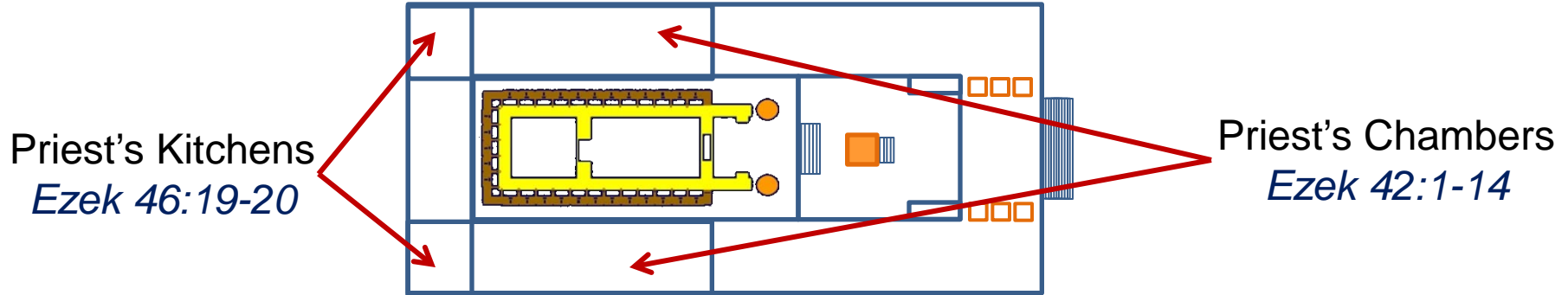

Ezekiel's guide, then took the prophet into the structure that housed the priests' rooms that were beside the south inner gate complex that faced north (40:44, 46).

This was evidently one of the two three-story structures in which the priests eat the sacrifices and change their clothes (42:1-14).

At the west side of this building there were kitchen facilities where the priests could boil the guilt and sin offerings and bake the grain offerings.

They were to prepare these offerings there so they would not have to enter the outer court and thus transmit holiness to the people.

Ezekiel's Temple – Lower Terrace

Ezekiel 40-48

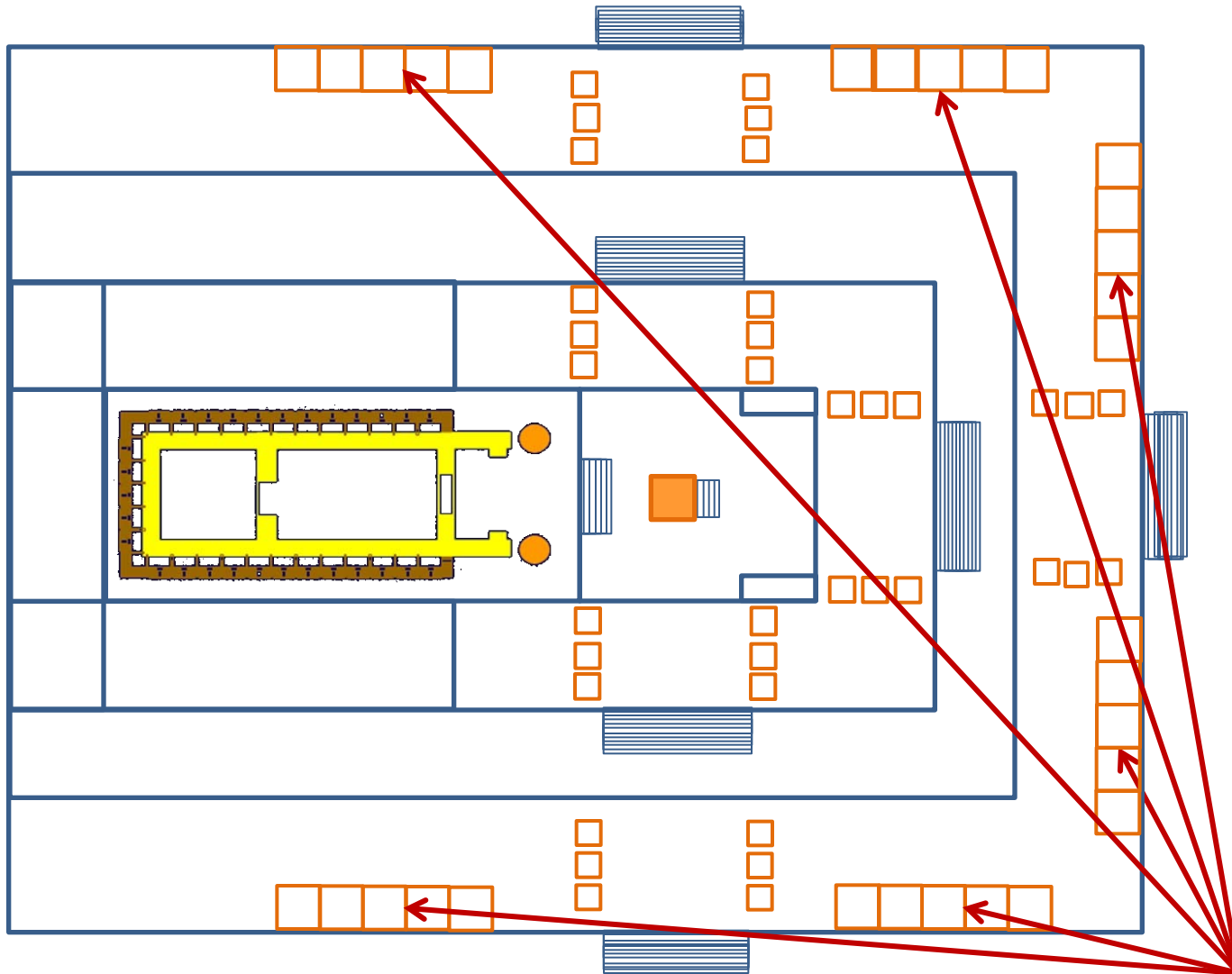

Chambers of
the Outer Court
Ezekiel 40:17-19,
41:5-11

Ezekiel's Temple – Lower Terrace

Chambers of the Outer Court
Eze 40:17-19, 41:5-11

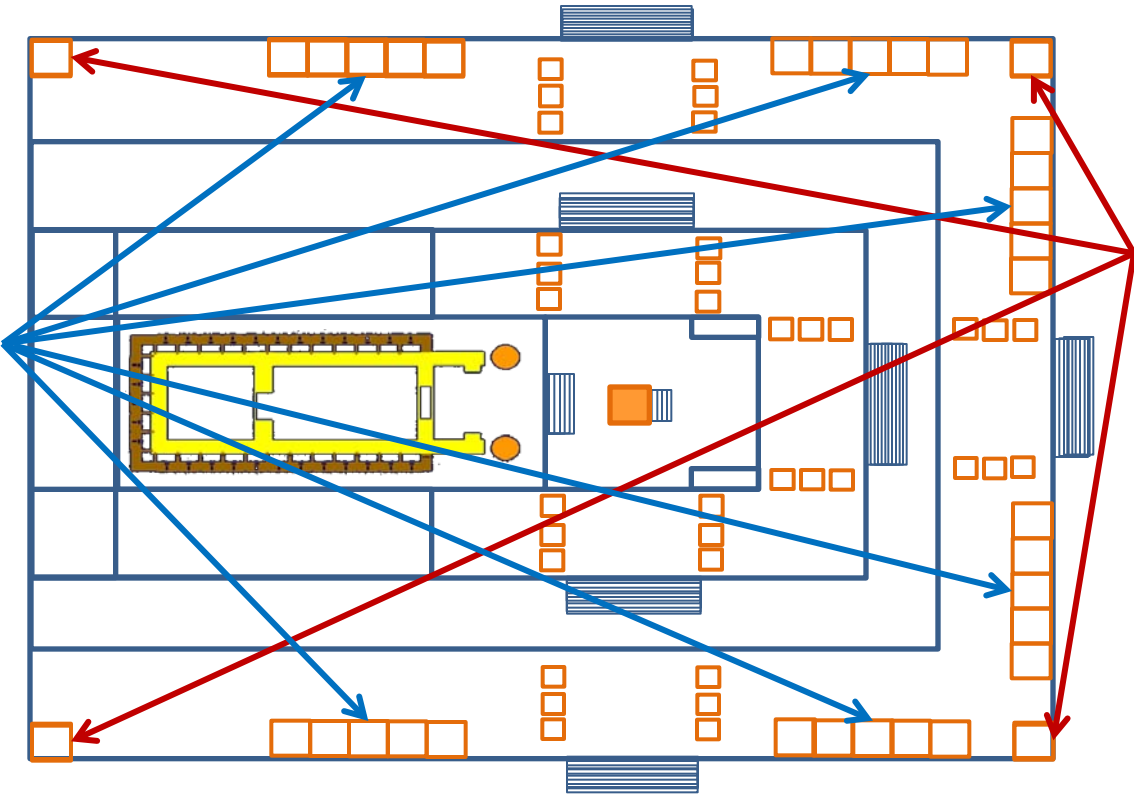

People's Kitchen
Ezekiel 46:20-24

Ezekiel was led out to the outer court and shown the 4 corners of that court.

In each of the 4 corners there was a courtyard 40 cubits (66' 8") by 30 cubits (50'). In each of these were ledges with fireplaces underneath that created cooking surfaces where the priests were to boil the sacrifices that the people brought to the temple.

Since the people would eat some of the sacrifices they brought, the outer court would be a place of both spiritual worship and social interaction where they would enjoy fellowship with other worshippers as well as fellowship with God.

The Special Portion – The Holy District

This special portion is for the Sanctuary, the priests, the Levites, and the prince would be the same size as the other allotments.

It is located between the 7 tribes in the north and the 5 tribes to the south. It is not divided into bands.

Picture a large band across for the prince. Inside that is a 25,000 reed square (about 50 miles square) and within it is a 10,000 reed band for the Levites and 10,000 reed band for the priests. In the middle of that is where the Sanctuary is, leaving a 5,000 reed band for the city.

The Temple is not in the City.

Between the Sanctuary and the City is a highway (*Isaiah 35*) and also the river.

The source of the river is the Sanctuary and it flows to Jerusalem and then splits into 2 directions going to the Mediterranean and toward the Dead Sea.

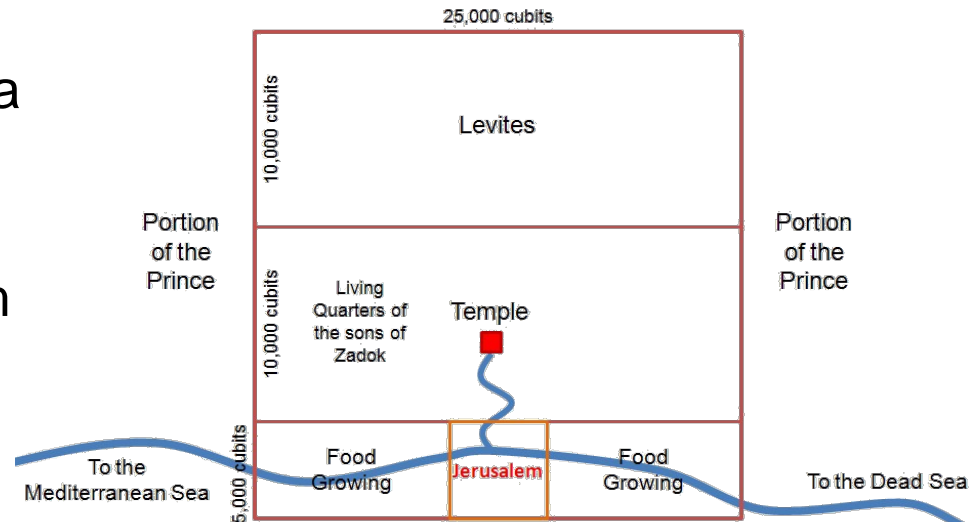
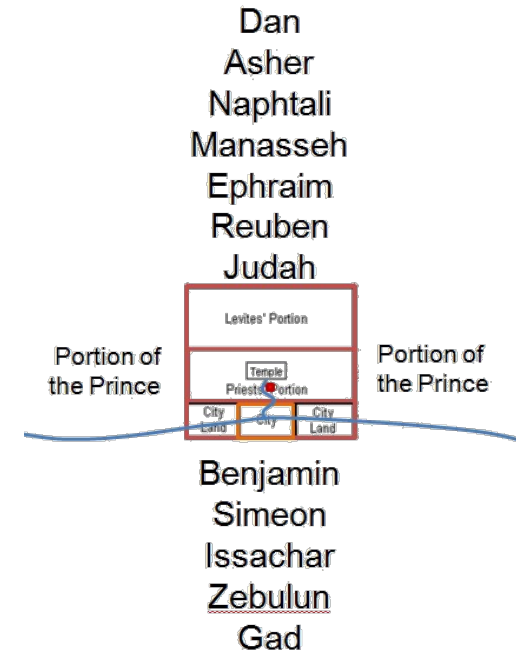

Division of the Land Ezekiel 45



- Dan
- Asher
- Naphtali
- Manasseh
- Ephraim
- Reuben
- Judah

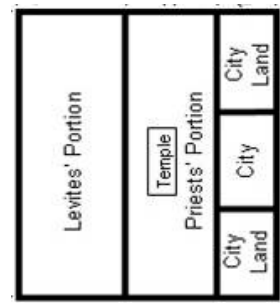

Portion of the Prince

Portion of the Prince

- Benjamin
- Simeon
- Issachar
- Zebulun
- Gad

Millennial division of the Land Ezek 47-48

