

Eastman®

THE EASTMAN®
Eagle
Automatic Cutting System
Model: Eagle C3
Installation Manual

Technical Support:
1-800-872-5595

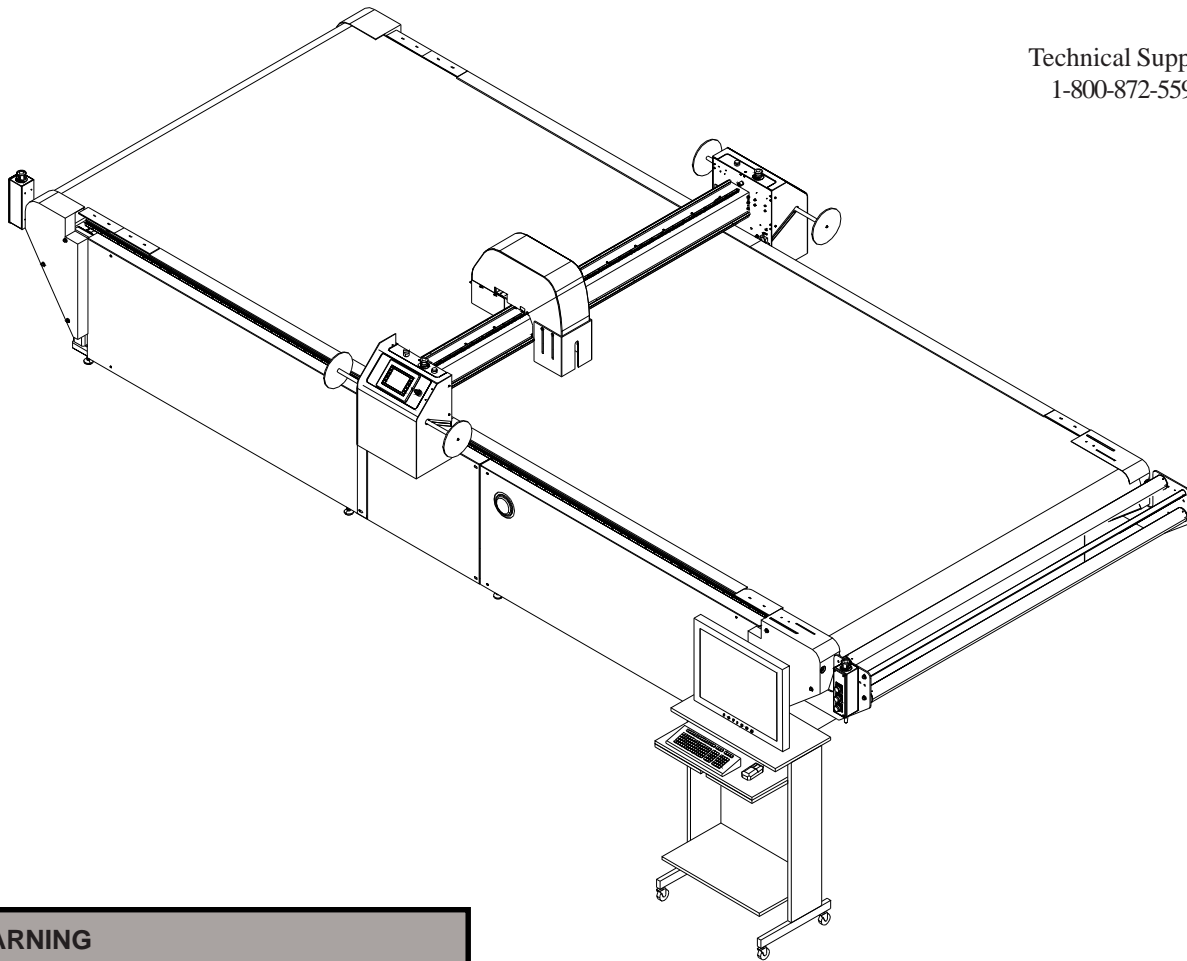

⚠ WARNING

This machine is equipped with a very sharp knife. Keep hands, arms, and hair away from the knife area at all times.

Misuse of this machine or failure to follow all safety instructions on this machine and in the instruction manual may result in serious personal injuries.

Eastman®

Over a Century of Cutting Expertise

779 Washington St., Buffalo, N.Y. 14203-1396 U.S.A. • (716)856-2200 • Fax (716)856-1140 or (716)856-2068
Manufacturers of Eastman Cloth Cutting and Cloth Spreading Machines
Website: www.EastmanCuts.com

Congratulations

Congratulations in selecting an Eastman Eagle Conveyor. With over 100 years of experience in the cutting room, Eastman is a world leader in cutting equipment. Every Eastman employee takes pride in each machine we build and back it with unprecedented support. Our Technical Service department is made up of a dedicated staff of professionals with years of experience installing, troubleshooting and servicing the Eagle Conveyor. Each technician is familiar with all aspects of the machine including mechanical, electrical and software.

Eastman Machine Company provides technical support and on-site service as required. We offer several affordable Extended Warranty plans that allow you to continue the superior technical support well after the machine is past our standard warranty. If you require on-site technical support or would like to schedule a preventive maintenance visit or need additional training, please call our headquarters in Buffalo, NY to arrange for a technician.

Technical Support

Eastman Machine Company
779 Washington Street
Buffalo, NY 14203
Phone: 716-856-2200
Fax: 716-856-2068

Limited Warranty. Eastman warrants to the buyer that the equipment shall be free from defects in materials or workmanship for a period of 180 days commencing on the date of invoice. Any goods or parts claimed by the buyer to be defective must be returned to Eastman, freight charges prepaid, within the 180 day warranty period. If Eastman determines that the goods or parts are defective in materials or workmanship, Eastman's sole obligation under this warranty shall be, at Eastman's sole option, to repair or replace the defective goods or parts or to provide the buyer credit equal to the portion of the purchase price allocable to the defective goods or parts. This warranty should not apply if defects are caused by product misuse or neglect, if the machine has been altered or modified by the buyer or if other than genuine Eastman parts are used in the machine. THIS WARRANTY IS APPLICABLE TO THIS PURCHASE ONLY. SELLER DISCLAIMS ALL OTHER WARRANTIES, EXPRESSED OR IMPLIED, INCLUDING, BUT NOT LIMITED TO, THE IMPLIED WARRANTIES OF MERCHANTABILITY AND FITNESS FOR A PARTICULAR PURPOSE.

Limitation of Liability. Eastman's liability to the buyer, and the buyer's remedies from Eastman whether in contract, negligence, under any warranty or otherwise, shall be limited to the remedies provided in the foregoing Limited Warranty. In no event shall Eastman have any responsibility or liability to the buyer for (a) any special, indirect, incidental, or consequential damages, including, but not limited to, loss of use, revenue, or profit even if Eastman has been advised of the possibility of such damages, or (b) any claim against the buyer by any third party. The price stated for the product sold is a consideration for limiting Eastman's liability.

IMPORTANT

The purchaser must instruct all operators on the proper use of this equipment. All standard industrial safety measures and equipment should be provided to protect the operator. Operators must be cautioned that improper or careless use of this equipment may cause personal injury. If you do not have qualified operators to instruct new persons, contact your EASTMAN sales representative or EASTMAN factory direct.

Electrical connections and servicing to this equipment should be made by a qualified electrician who is familiar with applicable codes and regulations. Disconnect this equipment from electrical power source before proceeding with any disassembly for adjustment or repair.

Your Eastman **Eagle C3 Conveyor** is designed to operate at a high rate speed. All personnel should be instructed to wear safety glasses and stand well clear of the **Eagle C3 Conveyor** when in operation.

Table of Contents

Site Preparation Requirements	4
Loading Dock	4
Floor space	4
Ventilation	4
Air-Pressure	4
Floor-Support	4
Floor-Leveling	5
Integration with Spreading Machines	5
Utilities (power outlets)	5
Machine Assembly Instructions	6
Preparation before Unpacking	6
Unpacking Instructions	6
Assembly and Mounting Instructions	7
Testing Procedure	23
Power and Pneumatic Installation Instructions	24
Connection details	24
Power requirement details	27
Cautions / Warnings	28
Environmental condition details	28
Check-out Procedure	29
Checks before Startup	29
Shipping, Handling, Moving Requirements	30
Shipping Instructions	30
Packing Instructions	31

Site Preparation Requirements

Loading Dock

In most cases the machine will be transported by common carrier freight truck. It is necessary to unload the truck which requires an unloading dock. If an unloading dock is not available then Eastman has to be contacted to make special preparations. Also it should be ensured that enough room and equipment is available to move the machine crates to the installation area. The freight door must accommodate 96 inches.

Floor space

The floor space required will be dependent on the machine size purchased. Typically for a standard machine the space required is 3 feet wider than the cutting width and 3 feet longer than the length. It is important to have this space available as parts / components of the machine travel at speed that can harm individuals if there is not enough room. Also additional space is required to accommodate accessories like power cradle, etc.

Ventilation

It is recommended that the machine should be installed in a clean and dry environment. This will extend it's useful life. The machine may not operate correctly if the surrounding environment is not clean. The room should be adequately ventilated to provide clean cool air as the machine will exhaust warm air into the room environment.

Air-Pressure

The machine requires clean and dry compressed air for operation. The air supply must be at least 15 CFM minimum. It should also have supply of Filtered and dry shop air w/75 – 100 PSI. The filter and dry air must remove 95% - 98% of all particles 40 microns or larger. All airlines must be in place at time of installation.

Floor-Support

The floor must be able to suspend loads greater than machine weight and additional working loads. Please consult factory to know the weight of the machine.

Floor-Leveling

It is important that the machine is installed on a leveled and stable floor. No deviation more than 1" from horizontal, (+/- 1/2") over the entire length is acceptable during installation. However the machine is outfitted with leveling feet which can handle irregular surfaces up to 1" per 16 foot grade.

Integration with Spreading Machines

The conveyor machine can be integrated to be used with a variety of material dispensing machines. Machines that can be incorporated with the conveyor include spreading machines, power feed, cradles and multi-bar roll stands. Eastman Machine Company can be consulted for assistance in configuring your specific needs.

Utilities (power outlets)

It is the responsibility of the customer to provide outlets for electrical and compressed air requirements for the below mentioned items

Electrical Requirements for Computer and Cutter

Contained within the electronics drawer are the electrical components including amplifier for the conveyor. The electronics drawer also provides power for the computer and computer monitor.

Eagle Conveyor Control Cabinet (Indicate desired 3 phase voltage)

Control Cabinet: (1) 200 (15 amp), 230(15 amp), 400(10 amp), 460(10 amp) or 575 volts (7.5 Amp) three phase - grounded dedicate line VAC, 3 Phase, 50/60 Hz.

Machine Assembly Instructions

Preparation before Unpacking

Before starting the unpacking the following items has to be reviewed with the customer.

- It is the responsibility of customer to hire a qualified electrician to wire the VFD or starter unit so that power can be supplied to the blower motor. The electrician needs to wire the incoming power to L1(R), L2(S), L3(T) and ground. He also has to provide wire or cable for outgoing power to blower motor i.e. T1(U), T2(V), T3(W) and ground. Eastman supplies a 3-phase plug for the power to the electronics drawer and it is the responsibility of the customer to provide the power cable to the electronics drawer.
- Compressed air requirements and location.
- Conveyor placement and orientation of conveyor.

Unpacking Instructions

Before starting the unpacking, the conveyor machine along with the gantry wooden pallet and the electronics drawer crate and any additional feeding systems like, power cradle, power feed, 'A' frame must be unloaded from the shipping trailer. The unloading is the responsibility of the customer / client. After unloading the following steps has to be followed.

- Carefully remove all the shrink wrap and tape on the conveyor using a utility knife.
- Remove all items found on the top of the conveyor surface and place it in a safe and convenient place.
- Remove the tri-wall cap and sleeve from the gantry wooden pallet.
- Cut the binding straps using utility knife and remove the boxes from gantry wooden pallet.
- Inspect the items in the boxes and verify that all components, hardware and accessories are included and undamaged.
- Leave the gantry on the wooden pallet and place the same in a safe and convenient place.

Assembly and Mounting Instructions

- Push the conveyor to the identified place or location as desired or chosen.
- Ensure that the machine is placed parallel to the wall or any fixed object.
- Ensure that when the machine is placed it is in compliance with safety regulations and hazards.
- Start mounting the leveling feet supplied by Eastman to the welded nuts below the frame.

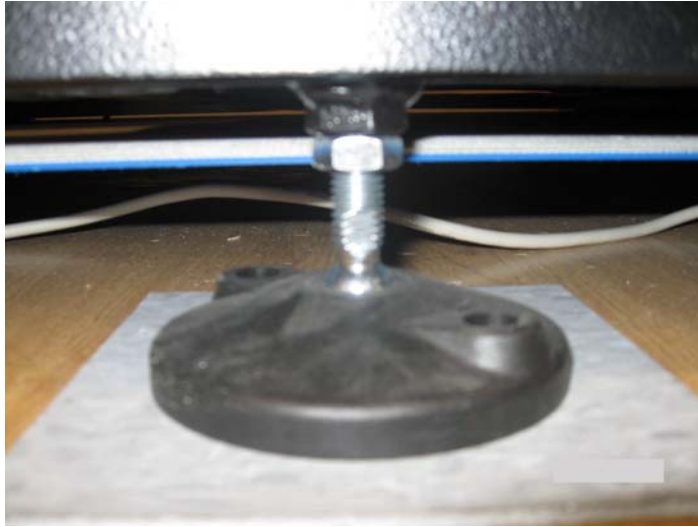

- Using fork lift pickup or raise the take-on end of the conveyor and remove the casters.
- After the casters are removed lower the take-on end of the conveyor to the floor.
- Using fork lift pickup or raise the take-off end of the conveyor and remove the casters.
- After the casters are removed lower the take-on end of the conveyor to the floor.
- The machine will now be supported by the leveling feet.

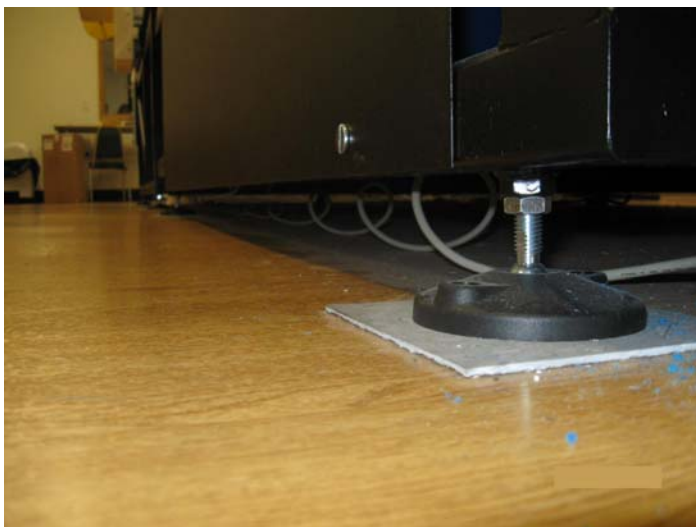

- Ensure again that the machine is parallel in reference to a fixed object.
- Level the frame by adjusting the leveling feet using leveling tools such as carpenter level, torpedo level or string until you achieve a level of +/- 1/32".
- Assemble the E-chain tray and mount the same to the frame on the non-operator side using mounting brackets.



- Remove the E-chain found in the gantry pallet and attach E-chain to E-chain tray using screws supplied by Eastman.



-
- Remove the rail, rack and rack plate from the end section of take-on side both on the operator side and non-operator side.



- Remove the operator side cover and non-operator side cover from the gantry.
- Remove the four THK linear bearings with the bearing blocks from the gantry found on both the operator side and non-operator side.



- Place the operator side THK linear bearing on the operator side rail facing towards the take-off side.

- Place the non-operator side THK linear bearing on the non-operator side rail facing towards the take-off side.
- Use three wooden pieces 2"x 4" stacked one upon the other on either side of the table.
- Using two persons remove the gantry from the wooden crate and place it on the two stacks of wood on top of conveyor table.
- Attach the E-chain mount and E-chain to the non-operator side of the gantry.
- Lift the gantry up and remove the wooden pieces, while holding the gantry in the same position drop it down to rest on the THK linear bearings, then slide the front bearings found on the take-on side both on the operator side and non-operator side.
- Ensure that the gantry is placed on the bearings / bearing blocks.



-
- Insert the screws to the bearing blocks so that it holds the bearings on the gantry.



- Slide the gantry to make room to put back the rack, rail and rack plate to its position both on the operator side and non-operator side of the take-on position.
- Adjust the back lash on the operator side and non operator side of the gantry using adjusting screws found on the back lash adjuster. Use a torpedo level to evenly raise the end plate and finally engage the spur gear into the rack and ensure there is no back lash.

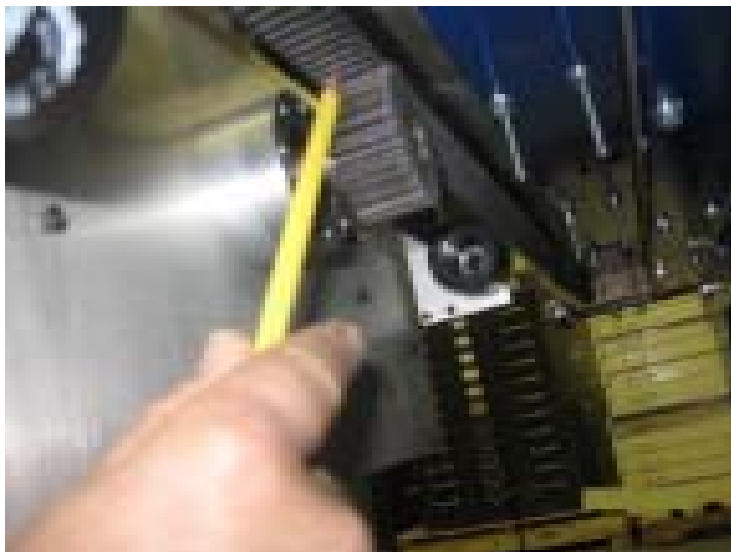

- Attach the E-chain cables to the bottom of the non-operator pan.



- Attach the other end of E-chain cables to the electronics drawer, including the cpu, computer monitor, key board and mouse.
- Remove the four mounting bolts which holds the reducer then slide it outwards towards the non-operator side and align it with outer holes and remount the mounting bolts.

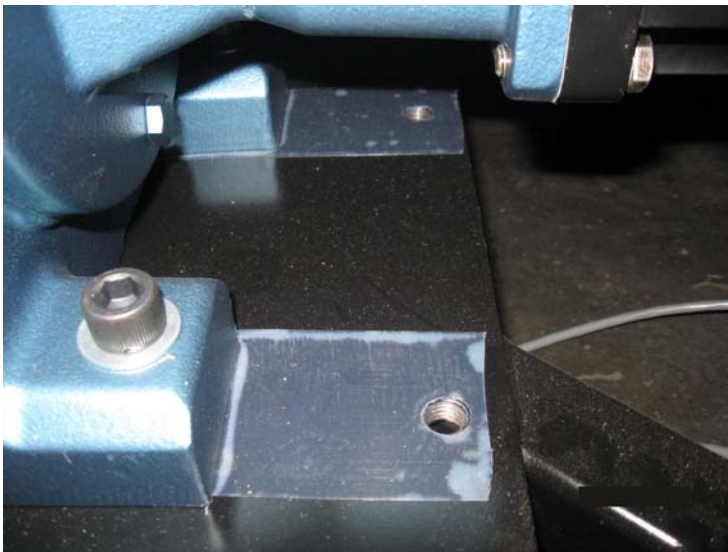

-
- Loosen the split color and shaft color on the drive shaft.



- Using Eastman's shaft extractor pull out the shaft.



- Align the drive shaft to the shaft of the reducer by measuring the distance from the face of reducer shaft to the side plate of drive end roller and also by measuring the distance from the face of the drive shaft to the side plate of drive end roller. Ensure that the distances are the same.
- Place the sprocket with key on to the drive shaft and then place the sprocket with key on the reducer shaft.
- Align the sprockets by measuring the distance from the face of reducer shaft to the side plate of drive end roller and also by measuring the distance from the face of the drive shaft to the side plate of drive end roller. Ensure that the distances are the same.
- Put on the chain tensioner and ensure it is in upper position.



-
- Put on the conveyor drive chain with master link around the sprockets.

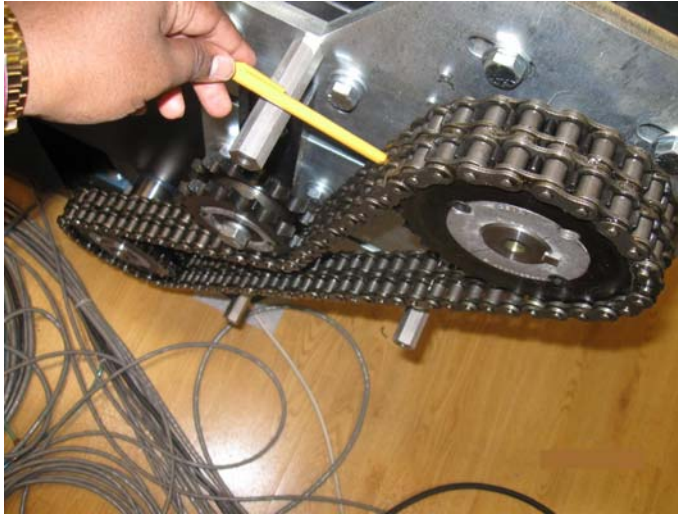

- Re-align the drive shaft sprocket and reducer shaft sprocket so that it is in alignment with the chain tensioner sprocket.
- Tighten the drive shaft sprocket and the reducer sprocket.

- Adjust the tension on the drive chain using the tension screw found on the chain tensioner.



- Tighten the split color and shaft color on the drive shaft.
- Mount the conveyor drive motor to the reducer by aligning the gear which is attached to the shaft of drive motor to the gear which is inside the reducer. Now put the four screws to hold the motor to the reducer.

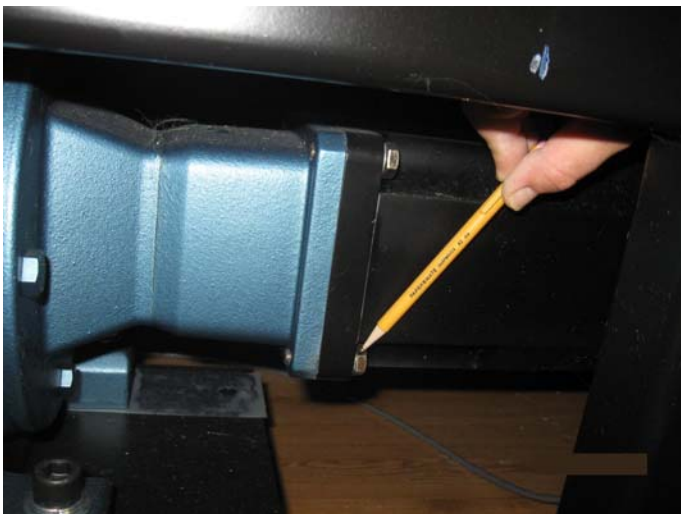

-
- Plug the power cable and haul / encoder cable to the conveyor drive motor.

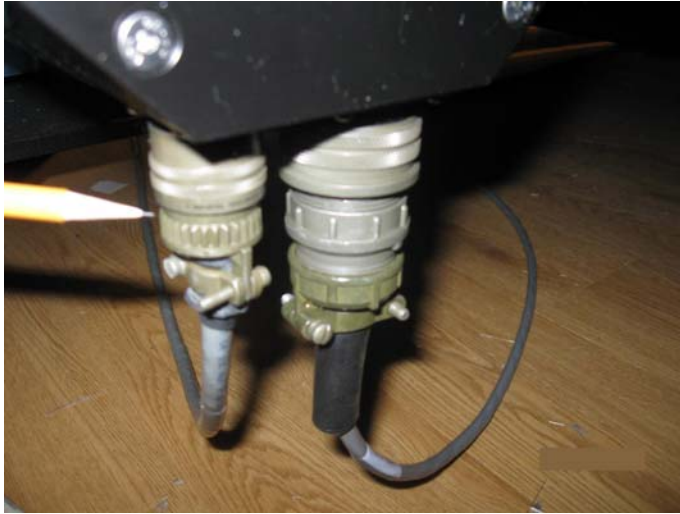

- Plug the other end of these cables to the electronics drawer.
- Mount the tension block to the tension plate on both the operator side and non-operator side.

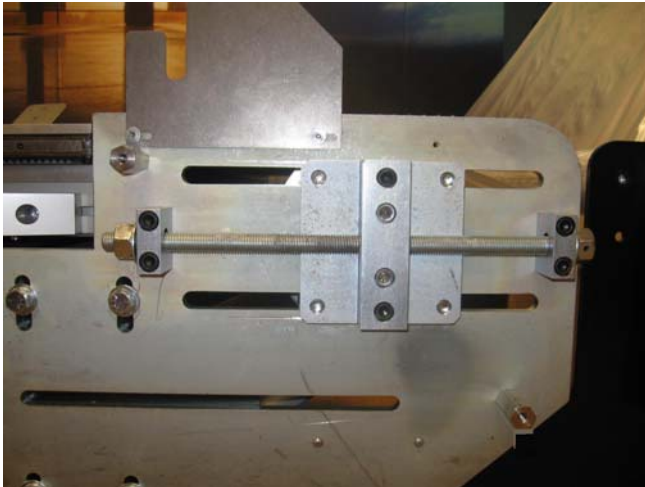

- Mount the S roller plates on both the operator side and non-operator side on the take-on side.



-
- Mount the two 3" roller tube assembly to the S roller plates and also mount the stay tube to the S roller plates.

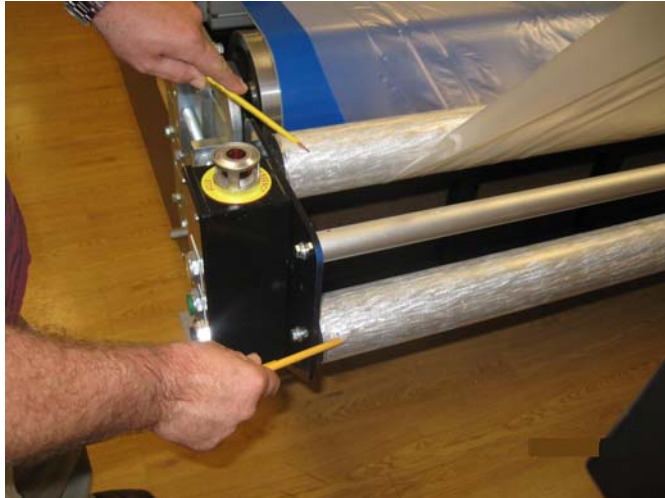

- Mount the E-stops on both ends of the operator side.



- Connect the two cables of the E-stop on the take-off side i.e. one cable to be connected with E-stop on the take-on side and the other cable to the electronics drawer.

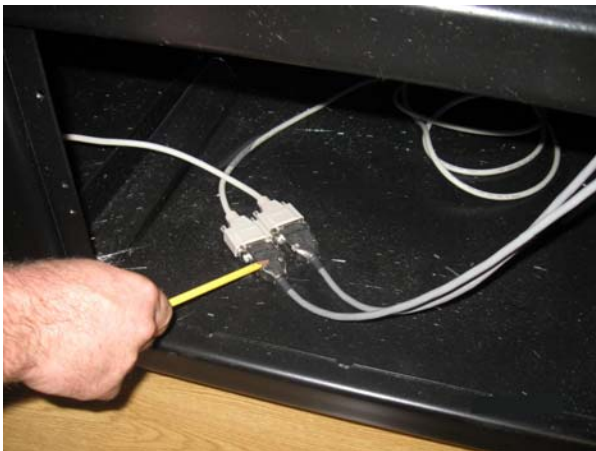
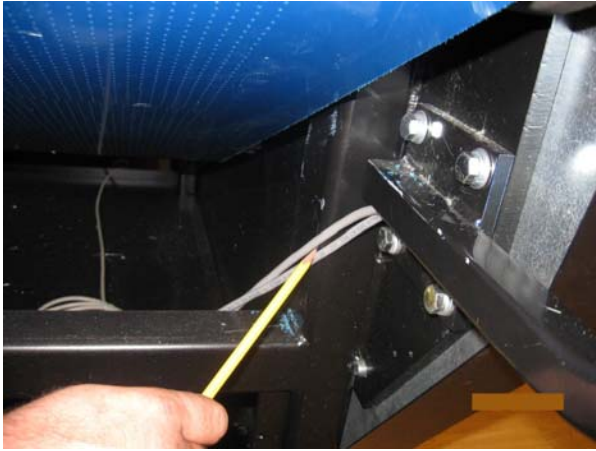

-
- Insert and assemble the stop discs into the operator side and non-operator side covers by ensuring that the groove on the stop disc rod is in alignment with limit switch.





- Put on the non-operator and operator side covers on the gantry.
- Install manual air regulator at the customer specified location.



- Plug in the ¼" air line to the air regulator.
- Plug in a 'T', section to the ¼" air line which runs from the air regulator and connect one line to the gantry and the other line to the steering roller regulator.

Testing Procedure

Note: The electrical and compressed air supply must be completed and ready to use prior to testing. Follow the instructions as mentioned below:

- Startup the machine using the recommended startup procedure provided Eastman.
- Establish the table limits.
- Track the conveyor belt and steering.
- After successful calibration and testing put on the conveyor side covers, end covers, gantry back cover, tool head cover and dust covers.

Power and Pneumatic Installation Instructions

Connection details

EAGLE C3 ELECTRONICS CONNECTION LAYOUT - POINT TO POINT CABLING

Table Drawer Connections	Cable Color	Source/ Destination
Main Power Inlet	Customer	From Building Supply
SynqNet In	Purple	From Gantry (Synq Out) thru X-Axis E-Chain
Conveyor Power	Orange	To Conveyor Motor
Conveyor Feedback	Green	To Conveyor Motor
SynqNet Out	Purple	To Computer (Synq in)
Gantry I/O	Grey	To (Gantry I/O) thru X-Axis E-Chain
Gantry Power	Green	To (Gantry Power) thru X-Axis E-Chain
Table Remote E-Stop	Grey	To Remote E-Stop Boxes

Computer Connections	Cable Color	Source / Destination
Computer Power	Black	From Computer Power Outlet at Table Drawer
SynqNet Out	Purple	To Gantry (Synq In) thru X-Axis E-Chain
SynqNet In	Purple	From Table Drawer (Synq Out)
UIT	Purple	To Gantry (UIT thru PoE) thru X-Axis E-Chain
Video Monitor Power	Black	From Computer Power Outlet at Table Drawer
Video Monitor Signal	Black	TO Video Monitor On Computer Stand
USB Cable	Black	TO Video Monitor On Computer Stand

Gantry Connection	Cable Color	Source / Destination
SynqNet In	Purple	From Computer (synq Out) thru X-Axis E-Chain
SynqNet Out	Purple	To Table Drawer (synq In) thru X-Axis E-Chain
Gantry Power	Green	From Table Drawer (Gantry Power) thru X-Axis E-Chain
Gantry I/O	Grey	From Table Drawer (Gantry I/O) thru X-Axis E-Chain
UIT	Purple	From Computer (UIT thru PoE) thru X-Axis E-Chain
Air Line	Blue	From Air Regulator thru X-Axis E-Chain

Conveyor Motor	Cable Color	Source / Destination
Motor Power	Orange	From Table Drawer (Conveyor Motor Power)
Encoder/Hall Sensor Plug	Green	From Table Drawer (Conveyor Feedback)

Operator Station	Cable Color	Source / Destination
Video Monitor	Black	To Computer - Video Output
Video Power	Black	To Computer Power Outlet at Table Drawer
USB	Black	To Computer USB Port
Keyboard	Black	To Video Monitor - USB Port (Local Connection)
Mouse	Black	To Video Monitor - USB Port (Local Connection)

VFD (Inverter)	Cable Color	Source / Destination
Main Power	Black	From VFD Disconnect (Fuse Box)
Blower Motor Power	Black	To Blower Motor On Machine
Blower Motor	Cable Color	Source / Destination
Blower Motor Power	Black	From VFD (Inverter)

Blower Motor	Cable Color	Source / Destination
Blower Main Power	Black	From VFD (Inverter)

Steering Roller	Cable Color	Source / Destination
Air Line	Blue	From Factory Supply Thru Pressure Regulator

Power requirement details

BLOWER MOTOR (VACUUM SYSTEM) ELECTRICAL REQUIREMENTS

Motor Horsepower	Motor Voltage	Motor Ampere	Size Breaker	Eastman VFD P/N	Size Wire (AWG)	Size Conduit	No VFD Setup	
							Size Starter	Heater Ampere
10	208-230	28	60	31-26389-4	10	3/4	2	32.2
10	460	14	30	31-26389-8	12	3/4	1	16.1

Note: In the case of 380 VAC, a special configuration can be used to control the blower motor with a VFD. Please consult Eastman if this is the case.

EAGLE C3 CUTTING CONVEYOR ELECTRICAL REQUIREMENTS

Machine Voltage	Machine Ampere	Size Wire (AWG)
208-240	20	12
380-480	10	14
575	8	14

Note: Eastman supplies a plug to connect to the Eagle Machine. An Electrician is required to supply power and cable.

Supply voltage should be from a Grounded Three-Phase dedicated line.

The electronics drawer has all required power outlets for the computer and monitor.

Any additional options purchased with machine will require a separate power connection. Consult Eastman for information.

Eastman®

Over a Century of Cutting Expertise

Cautions / Warnings

- Always disconnect power and follow lock out / tag out procedures prior to working on machine or opening covers.
- Never operate the machine with covers off.
- Never climb on machine with power on.
- Make sure machine surface is clear of obstructions (i.e. tools) prior to power up.
- Machine contains many pinch points, make sure operators are familiar with machine operation and hazards prior to use.
- Make sure all switches are in the “off” position prior to attaching power cards.
- Make sure air supply is turned on and cutting tools are raised prior to moving gantry else it may result in belt damage.

Environmental condition details

Condition	Normal Operating Condition	If Outside the Normal Condition
Temperature	55-100 degrees Fahrenheit	Cutter may not operate correctly
Humidity	20% and 80% relative humidity (non condensing)	Cutter may not operate correctly
High Altitude	Sea Level to 1000 feet above Sea Level	Blower Pressure Will be lower (material hold will be less)
Radio Frequency* Interference (RFI) (ie.RF Welding Equipment)	No Interference (Recomende 75 feet away)	Cutter may not operate correctly
Electrical Power Disturbance	No Disturbances	Cutter may not operate correctly
General Shop Cleanliness	Clean Environment	Cutter may not operate correctly
Clean/ Filter Shop Air	Clean Air	Cylinders may deteriorate if noty clean

* RF Interference:

For customers using RF welders or other equipment that emits RF, Eastman Machine Company recommends that this equipment be kept at least 70 feet away from the Eastman cutting system. High levels of RF emissions may cause the electronic controls in the system to malfunction. Please note that interference and damage, caused by RF emissions from equipment that is not stationed at least 70 feet away, may not be covered under the warranty of your Eastman cutting system.

Customer is responsible for installing and using earth grounds to protect machine from RF.

Check-out Procedure

Checks before Startup

- When air supply is on, tool should move to upper position on the tool head.
- All electrical cables are attached properly and secured.
- Ensure that table surface area is free from any obstructions.
- Ensure that the emergency stops are disengaged and the stop discs are in their neutral positions.
- Ensure that all safety covers (Tool head cover, Gantry cover, side panels) are secured.
- Ensure if gantry can be pushed easily (no binding).
- Check if the cam plates are properly installed on the table.
- Check limit switches if adjustments have to be made.
- Turn on the power of VFD, test run the blower motor and check for proper motor rotation. If motor runs backwards, 2 of the 3 incoming power wires need to be revised, consult a qualified electrician.
- Turn on main power to machine.
- Turn on computer.
- Follow start-up / operating instructions.

Shipping, Handling, Moving Requirements

Shipping Instructions

- Disconnect all 'X' axis cables from gantry.
- Disconnect all the cables from E-box.
- Remove the gantry from conveyor.
- Remove the drive end cover and take-on end cover and place it on the top of the conveyor surface.
- Remove the side covers and place it on the top of the conveyor surface.
- Remove the take-on and take-off side covers found on the operator's side and non-operator's side and put them in a cardboard box and then foam it in all sides to protect from any damage and then place this box on the conveyor surface.
- Remove the S-rollers and placed it on top of the conveyor surface.
- Place the E-chain trough on top of conveyor surface.
- Remove the chain tensioner.
- Remove the drive chain, drive sprocket, key, and then push the drive shaft inside until it is in flush with adjustable plate.
- Remove the drive motor.
- Slide the reducer inside and bolt the reducer in the alternate hole positions.
- Remove the take-on adjuster.
- Secure electronics drawer with shipping screws.
- Cover the whole table with card board.
- Shrink wrap the whole conveyor.
- Put the 'X' axis E-chain and cables, 25 ft of air line hose, stop discs, E-stop boxes in a cardboard box.
- This above box must be placed inside the wooden crate which accommodates the gantry.
- The gantry wooden crate should hold the gantry, drive motor, drive chain, drive sprocket, key, chain tensioner, computer, tools box, VFD terminal and cable protector.
- The complete conveyor which is shrink wrapped should be pushed on its wheels till it reaches the loading dock.

-
- The complete conveyor machine should be loaded in the trailer with the fork lift.
 - Place Air bags around the conveyor after it is loaded to the trailer to protect it from any damage and hold them in place during traveling.
 - Place a wooden separator right next to the conveyor end.
 - Bring the wooden crate which holds the gantry with the fork lift and place it right next to wooden separator.

Packing Instructions

- The complete conveyor machine must be shrunk wrapped in white plastic.
- The gantry must be secured placed in a wooden pallet with a tri-wall cap and sleeve.

Technical Data
EASTMAN® Eagle C3

Eagle C3

Maximum Gantry Speed*	60 in/sec. (152 cm/sec.)
Maximum Conveyor Speed*	10 in/sec. ² (25.4 cm/sec ² .)
Cut Accuracy *	+/- 0.015" (+/- 0.4 mm)
Gantry Weight	230 lbs (105 kg)
Machine Operating Voltage	208/220/400/440/575 VAC, 3 Phase 50/60 Hz
Blower Operating Voltage	220/440 VAC, 3 Phase 50/60 Hz
Minimum Operating Pressure	75 psi
Volume of Air Service	5 SCFM (15 SCFM w/Airbrush)

Information based on standard 78" wide machine size

* Relative to type and quality of fabric, cutting speed, pulling mode operational settings.etc.

* Conveyor pull accuracy to +/- 1/16" (+/- 1.6 mm).

Machine Size	Working Width	Table Width (including Rack and Rail)	Overall Machine Width
72" (183 cm)	70.6" (180 cm)	88-1/4" (224 cm)	99" (252 cm)
78" (198 cm)	76.6" (195 cm)	94-1/4" (240 cm)	105" (267 cm)
84" (213 cm)	82.6" (210 cm)	100-1/4" (255 cm)	111" (282 cm)
126" (320 cm)	124.6" (317 cm)	142-1/4" (362 cm)	153" (389 cm)
156" (396 cm)	154.6" (393 cm)	172-1/4" (483 cm)	183" (465 cm)

Please allow 3 ft working clearance on all sides.
 For all other sizes consult factory.