

Dodge®

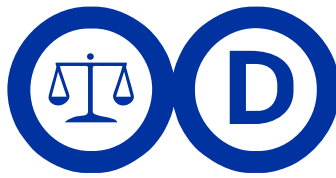

THE EMBALMING ROOM CATALOGUE 2019



www.dodge-uk.com/store

Contents

Product Category	Page		
Arterial Chemicals	6-11		
Co-Injection Chemicals	12-14		
Cavity Chemicals	15-18		
Accessory Chemicals	19-24		
Accessories	25-27		
Adhesives	25	Tape, Kalip & Inr-Seel	26
Eye Caps & Mouth Formers	27		
Embalming Powders	28-29		
Absorbent Products	30-33		
Disinfectant Products	34-35		
Deodorants Products	36-37		
Cosmetics	38-53		
Kalon	38-39	Kalochrome	40
Aquachrome	41	Perma Liquid & Powders	42
Complexion Spray	43	Liquid Cosmetics	43
Softouch, Lip Rouges & Waxes	44-45	Spatulas & Cosmetic Heads	46-47
Easyway	48	Silcolan & Undercoat	48
Brushes	49-51	Cosmetic Kits	52-53
Instruments	54-79		
Separators	54	Aneurysm, Needles & Hooks	55
Forceps	56-58/61/63	Injection/Drainage Tubes	63-64
Scissors	66-67	Scalpels, Needles & Syringes	68-70
Trocars & Accessories	71-77	Embalmer's Kits	78-79
Supplies & PPE	80-97		
Accessories	80	Disaster Pouches & Body Bags	81
Ligature	82-83	Charts & Signage	87
Garments	88-89	Personal Protective Equipment	90-97
Equipment	98-118		
Pumps & Embalming Machine	98-105	Aspiration & Pressure Tanks	106-107
Supports & Body/Head Rests	108-110	Embalming Tables & Stretchers	111-116
Bier & Bier Covers	117	Hydraulic Hoist & Loader	118
Cleaning Equipment	119-125		
Capital Equipment	126-133		

Distributors

The world's most respected name in death care supplies since 1893



Dodge Australia

29 Governor Macquarie Drive,
Unit 5, Chipping Norton 2170, NSW
Telephone: 02 8214 4655
Freephone: 1800 506 796
info@dodgeco.com.au
http://www.dodgeco.com.au



Dodge UK

Units 11/14-15 Ardglen Industrial
Estate, Whitchurch, Hampshire
RG28 7BB England
+44 (0)1256 893883
enquiries@dodge-uk.com
www.dodge-uk.com



Dodge Medenta Germany

Huckrieden Esch 9
49549 Ladbergen
Germany
Telephone: 0049 54852020
info@medenta.de
www.medenta.de

Our Exclusive Distributors



Belgium

Inter-Thanato
Chemin de la Masure, 160
7000 MONS
Belgium
Telephone: 00 32 475313432
info@interthanato.be



Czech Republic

Pohrebni ustav AURIGA® spol. s r. o.
B. Nemcove Street 1052/1
CZ 41201 Litomerice
Telephone: 00420 602 290 173
petr.rambousek@pohrebni-auriga.cz



France

EIHf Isofroid
Z A La Noyeraie
69490 Sarcey
France
Telephone: 0033 474 268724
contact@eihf-isofroid.com



Hungary

Hungary Kft
2500 Esztergom, Simor János u. 70.
Telephone: +36 20 9221 370
dodgekft@gmail.com
www.dodge.co.hu



Ghana

Lashibi Funeral Homes Limited
P.O Box SK 121, Sakumono -
Ashaiman Road,
Tema, Accra, Ghana
Telephone: +(233) (0)577 603 687
info@lashibifuneralhomes.com
http://www.lashibifuneralhomes.com



Ireland

Shepherds Mortuary and Funeral
Supplies
Unit 2A Royal Canal Business Park
Athlone Road, Longford, Eire
Telephone: 00353 433349702
sales@shepherds.ie
www.shepherds.ie



Japan

Cosmo Trade and Service Co., Ltd.
Hamamatsucho Building 7th Floor
1-1-1 Shibaura Minato-ku
Tokyo, 105-8325
Telephone: 03-3798-9315
masanori_sebe@cosmo-oil.co.jp
www.cosmo-trade.com



Netherlands

Hesselmans International
Poortmolenstraat 26
1333 MT
Almere-Buiten
Netherlands
Telephone: 0031 365290575
info@hesselmans.nl



Nigeria

TOS Funerals Ltd
33, Victoria Street
Ojota, Lagos
Nigeria
Telephone: +234 8033314755
admin@tosfunerals.com



Poland

Prosektor
Kościelna 1A
05-400 Otwock
NIP: PL 5322003840
Telephone: +48 509 570 306
Fax: +48 22 779 23 39
biuro@prosektor.pl



Romania

AXYS Tanato - Tehnic
Loc. Rusova Veche, nr. 32
Jud. Caras - Severin, România
Telephone: +40 734 082 422
+40 722 287 808
axys@tanatopraxie.ro
www.tanatotehnic.ro



Spain & Portugal

Sortem
Plaza de la Tecnología, 2 Nave 5
08223 Terrassa
Barcelona, Spain
Telephone: 0034 931 435 470
info@sortem.es
www.sortem.es

Our Story

Dodge®



The Dodge Company began in 1893 in Boston, Massachusetts under the stewardship of A. Johnson Dodge. From that day to this Dodge Company has become one of the most widely known names in the Funeral Service Profession. The history of a company is constantly being written and so has been with Dodge as well. Over the years, 3 service centres and a division in Canada were added, followed in 1986 by the addition of Dodge UK in one small warehouse on an industrial estate in Whitchurch, Hampshire.

In the following 33 years, Dodge UK has become a leader in the field of manufacture and supply of embalming chemicals, equipment and supplies which reach over Europe and other continents in the world. Today in the UK we remain in Whitchurch, Hampshire, where we now occupy three large premises containing an office, manufacturing and warehouse/shipping facilities.

The profession of Funeral Directing and Embalming has seen a great many changes over the past 100 or more years and Dodge is proud to have evolved to overcome many of these challenges. We appreciate the ever-changing needs and expectations of you, our customers, as you care for the bereaved and the deceased in your communities which is no easy task. We at Dodge understand the magnitude of this challenge and accept our responsibility as your partner.

A deep understanding of the embalming process is one key to our success and why Dodge places such importance on having professionally qualified company representatives. Dodge appointed its first research chemist in 1926 to work on new and improved embalming chemical formulas. The third generation of Dodge's, Arnold (Jake) and George (Mike) realised the importance of continued professional education and further developed the Dodge Sunshine Seminars into what they are known and recognised as today.

Debbie Dodge and her sister Kristie are the fourth generation of the Dodge family to run the business and continue the tradition of quality and service that the Dodge Company was founded on. As a family, Mike, Debbie and Kristie have overseen the company during the several significant developments including the formulation, testing and release of the first formaldehyde free arterial and cavity fluids, the first embalming machine with automatic pressure control and a waterless aspirator.

Since the formation of Dodge UK, we have been privileged to work with a great number of funeral directors and embalmers in one way or another. We value the trust placed in us just as the bereaved place their trust in you. As a team we work to ensure that we help you, so you can help others!

The Quality and Service that everyone has come to know and expect from Dodge will continue, built on the foundation on which our company was founded - Helping you to help others.

Placing Orders & T&C's

When placing a phone, fax or email order

For the most efficient ordering process we suggest the following tips:

1) Please write a list of what you want:

Even if you plan to call us, this will save you time and ensure that you get everything you need.

2) On your list write down:

A) Each item's 6 digit catalogue number.

B) The quantity you want.

C) The description (this is helpful because we have so many similar products). If you do not have the catalogue number a good description will help us find the right products.

3) Please give us your account number:

It's recommended that you write this on your catalogue. Alternatively, you can find this on any Dodge invoice. Please keep a record to simplify ordering in the future.

4) If faxing your order:

On your fax sheet, please include your firm's name, address, telephone number and the name of the person ordering.

5) Non-stock items take longer:

There are some items in our catalogue that come from other manufacturers or our factory in America. When placing an order we will advise you of any delays and endeavour to supply your requirements as soon as possible. Some items can take up to 6 weeks for delivery.

Free Phone: 0800 8815 654
Phone: 0044 (0) 1256 893883
Fax: 0044 (0) 1256 893868
Email: enquiries@dodge-uk.com
Website: www.dodge-uk.com

Please note that some items and packaging may vary slightly from the descriptions of this catalogue.

Please check the number of boxes received with the number of boxes shipped before signing for the delivery. Note the discrepancy on the driver's papers and call Dodge as soon as possible.

Short Shipments

Before signing for any delivery, please make sure that you count the number of boxes, or cartons being delivered. If there is a discrepancy, indicate it on the delivery driver's copy and initial before signing. This will allow Dodge to make a claim for the missing items. This notification on the driver's paperwork needs to be made to receive the replacement goods without charge.

Returns Policy & Procedure

We realise that every now and then, you may place an order for a particular item and when it arrives, it is not what you wanted or has been damaged in shipping. We want to be as helpful as possible when this happens. In order to expedite the return process, please call our office to authorise a return then your account will be noted and any problems alleviated.

Visual Damage

Check the outside of the shipping boxes before signing for them. If there is damage to a box, refuse the order and have the delivery company return the order. Please call the Dodge office to arrange for a replacement order. If you do keep the order, please keep the box as most shippers will need to see the packaging for claim purposes.

Concealed Damage

If there is no visible damage to the box, but when you open it, the item is damaged, contact the Dodge office immediately. We cannot accept concealed damage claims after 3 days from your signed delivery. We will contact the delivery company and start a claim process to determine when and how the damages occurred. Once determined, a call tag will be sent to return the item and a replacement will be sent.

Please remember that if your claim is made after 3 days from delivery, our shipping agents may refuse responsibility and a credit may not be extended. Please keep the box as most carriers will need to see the packaging for claim purposes.

Missing Items

Occasionally an item that you ordered may not be in the box. Please contact the Dodge office within 48 hours of your signed delivery. In this situation, we will investigate the short shipment and if required we will ship a replacement to you with no added carriage charge.

Items Being Returned

Please call the Dodge office to work out arrangements for all returns. Products must be returned in good, unused condition, preferably in the original packaging.

For items from outside manufacture, PLEASE notify Dodge within 48 hours of receipt of the item to arrange for Return Call Tags (item will be returned to manufacturer pending approval from that manufacturer) Credit will not be issued until the item is received by the manufacture.

For returns other than for defects, damages or shipping errors, restocking fees (which range from 10-25%) and shipping fees will be deducted from your refund/ credit.

Arterial Chemicals

Formaldehyde Free



Freedom Art

The Freedom Art process will not yield the same degree of firmness you would normally expect with traditional arterial chemicals. For optimum results, the following guidelines are recommended minimums.

Instructions For Use

For a case weighing up to 200 lb or 90 kg:

- 2.83 litres of Freedom Art
- 1.5 litres of Metaflow
- 0.5 litres of Rectifiant
- Enough water to make 8 litres of solution

Should you require additional fluid for embalming larger cases, the quantities can be halved and used to make 4 litres of arterial solution for additional injection procedures.

For difficult or challenging bodies, it is recommended that a stronger solution be used by reducing the water content of the solution and increasing the quantity of Freedom Art, Metaflow and Rectifiant. The best results have been achieved with the use of a drain tube and intermittent drainage although Freedom Art can be used with any injection technique. Following the arterial injection and aspiration, the cavities should be treated with 1 litre of Freedom Cav distributed equally between the thoracic and abdominal cavities. Any less fluid may lead to embalming failure.

Freedom Art Complete Kit

SKU: 241810

Size: 1 x 2.83 litre bottle of Freedom Art,
1 x litre bottle of Rectifiant,
1 x litre bottle of Freedom Cav
2 x litre bottles of Metaflow

Freedom Art

SKU: 241811

Size: 4 x 2.83 litre





Chroma Pink 5

Chroma Pink 5 offers the embalmer an effective arterial chemical with a low formaldehyde content. With less firming, yet a high level of disinfection and a pleasantly appearing cosmetic finish, this will become a favourite for the safety conscious embalmer who demands the highest standards day after day, week after week.

SKU: 109025
Size: 12 x 1 litre
Index: 5



Intro 5

Intro 5 has all the characteristics of Introfiant but is a low fuming, low index fluid. Provides dependable results in the most challenging of cases, whilst reducing the operators exposure to formaldehyde and improving working conditions in the embalming room.

SKU: 105013
Size: 12 x 1 litre
Index: 5



Plasdo-5

Plasdo-5 offers the embalmer an effective humectant based arterial chemical with a low formaldehyde content resulting in less firming and yet a high level of disinfection. Plasdo-5 is an opaque, non-fatty, non-emulsified chemical and will impart a natural translucence to the skin and dispel putty grey colourations post embalming must for the embalmer seeking a versatile, safe and trouble free low level arterial embalming chemical.

SKU: 107027
Size: 12 x 1 litre
Index: 5



Arterial Chemicals



Introfiant

Introfiant, identifiable by its distinctive deep tone Dynachrome colouring, is an ultra-potent arterial embalming medium intensified by the addition of powerful Dodge 'Introfiers' for penetrating and preserving circulation - resistant bodies. Although initially formulated to cope with 'problem case' conditions, this arterial has found widespread favour as a general - purpose embalming medium because its excess strength relieves the embalmer of all doubts concerning the efficacy of the arterial injection - regardless of vascular and tissue conditions. Many leading establishments consider Introfiant an invaluable time-saver and specify its use on extreme and normal cases alike.

Performance Highlights:

- Reduces yellow staining in most cases - achieves total clearance in many jaundice instances.
- Bleaches out bile pigments only. Will not alter normal skin pigments.
- Requires no special techniques beyond ordinary pre-embalming treatments.
- Tinctorial content may be intensified by the addition of Icterine dyes.

SKU: 105028
Size: 12 x 1 litre
Index: 30



Chromatech Pink & Original

With exclusive Chromatan Dye. For those who want a high intensity colouration in a red-brown or pink hue.

Today, funeral service professional's demand that a high degree of natural colouration be imparted to the tissues from within, by the dye in the arterial chemical itself. This is not just to save time that might otherwise be spent on cosmetic application. Technically proficient embalmers know that colouration from within looks more natural than anything that can be applied externally.

Dodge Chromatech is also particularly useful when treating dehydrated or emaciated cases and with the addition of a sufficient amount of Dodge Restorative, facial features and depth may be restored without the need of time consuming tissue building procedures.

Performance Highlights:

- Provides medium firming.
- With Plasdoform - Dodge's patented embalming breakthrough.
- Contains its own humectant. Soluble, not animal based.
- With the exclusive Chromatech dye system. Not available in any other arterial.

Chromatech Original

SKU: 109005
Size: 12 x 1 litre
Index: 21.5



Chromatech Pink

SKU: 109020
Size: 12 x 1 litre
Index: 21.5



Plasdopake & Plasdo 25

Plasdopake is identifiable as a humectant arterial formula by its opaque, flesh toned characteristics. Although seemingly viscous in appearance, it is actually just as free flowing as our non- humectant arterials. Plasdopake is a non - fatty, non-emulsified chemical compound with Dodge vasculin substituted as the humectant factor.

Like other Dodge Humectant Arterial chemicals Plasdopake and Plasdo 25 are particularly useful when treating dehydrated or emaciated cases. The addition of Dodge Restorative will help to restore natural facial contours without the need for tissue building procedures.

Performance Highlights:

- Monitored firming. Molecular screening controls rate of firming acceleration. Releases formaldehyde as needed.
- Clot Dispersal. Plasdoform base peptizes and diffuses clots, clumped cells, nutrient gels.
- Neutralizes antibiotic drug effects.
- Rehydrates tissue cells. Penetrates cell membrane. Moisturizes cell proteins. Restores lifelike plasticity.
- Dispels death pallor. Imparts natural translucence to the skin. Dispels dull putty grey colour.
- Water soluble formula. Contains no emulsified animal fats. Won't settle out of suspension and block circulation.
- Disinfects as it preserves. Powerfully active against pathogens. Stabilizes proteins. Halts decomposition.
- Polarizes cell proteins. Binds tinctorial undertones to the tissues by polar attraction. Imparts colour vibrancy.
- Operationally simple. Permits fast, trouble free injection. No complex procedures.



Plasdopake
SKU: 107016
Size: 12 x 1 litre
Index: 18



Plasdo 25
SKU: 107024
Size: 12 x 1 litre
Index: 25



Regal 30

By combining a powerful preservative foundation with Dodge's non-fat based humectant Vasculin, Regal provides the embalmer with an arterial formula capable of increased firming capability, without the concerns of dehydrating delicate tissues. It's specialised dye system provides natural tissue colouration, while minimising the change of inconsistent or blotchy distribution.

Performance Highlights:

- Index 30 dependable firming in the medium to high range.
- Controlled release of preservative.
- Natural cosmetic effect.
- Water soluble humectant.
- Uniformly distributing dye system.

SKU: 107029
Size: 12 x 1 litre
Index: 30



Arterial Chemicals



Metasyn

Metasyn offers the embalmer an all-purpose medium of remarkable flexibility and precise operational control. This formula gives the progressive practitioner every desirable feature of a premium performance arterial chemical - and more! Plasdoform embalming takes the doubts and guesswork out of injection procedures and insures exceptional levels of embalming results on all types of cases. A popular choice for effortless excellence.

Performance Highlights:

- All-purpose arterial with monitored firming rate. Gives working solutions the molecular weight of human blood.
- Produces exceptional cosmetic refinements.
- Leaves tissue pliant with fine-textured skin tone.
- Antimetabolite action dispels jaundice and post mortem discolorations.
- Preserves completely with gentle, progressive firming and natural tissue plasticity.
- Peptizing constituents insure free circulation and complete protein fixation.
- Contains lab-measured, self-adjusting tinctorials.

SKU: 121021
Size: 12 x 1 litre
Index: 30



Jaundofiant Basic & Control

Basic: This element of the two part Jaundofiant system contains the basic chemical constituents for protein fixation and jaundice stain reduction.

Performance Highlights:

- Provides medium firming.
- With Plasdoform - Dodge's patented embalming breakthrough.
- Contains its own humectant. Soluble, not animal based.
- With the exclusive Chromatech dye system. Not available in any other arterial.

Control: This element of the dual Jaundofiant system contains the chemical catalyst which activates and intensifies the stain reducing components of the basic arterial. The control unit must be intermixed with basic for maximum jaundice embalming effectiveness. It is bottled separately to maintain the dual components at full chemical capacity.

Performance Highlights:

- Reduces yellow staining in most cases - achieves total clearance in many jaundice instances.
- Bleaches out bile pigments only. Will not alter normal skin pigments.
- Requires no special techniques beyond ordinary pre-embalming treatments.
- Tinctorial content may be intensified by the addition of Icterine dyes.



Jaundofiant Basic

SKU: 106013
Size: 24 x 473 ml (16 oz)



Jaundofiant Control

SKU: 106021
Size: 24 x 473 ml (16 oz)



Jaundofiant Kit

SKU: 106021
Size: 24 x 473 ml (16 oz)
(12 bottles of each chemical)

Arterial Chemicals & Dyes



Standard Arterial

A pale pink coloured fluid, suitable for use as a general purpose embalming fluid for problem free cases. Universally applicable in arterial and hypodermic injections.

SKU: 108031

Size: 12 x 1 litres

Index: 26



Icterine Regular

SKU: 552026

Size: 473 ml (16 oz)



Icterine Peach

SKU: 552075

Size: 473 ml (16 oz)



Icterine Red

SKU: 552139

Size: 473 ml (16 oz)



Icterine Suntan

SKU: 552117

Size: 473 ml (16 oz)



Icterine Tan

SKU: 552036

Size: 473 ml (16 oz)



Icterine

Icterine is our most modern, concentrated arterial dye. It is a super concentrated, non-dehydrating tinctorial additive specifically formulated to give the embalmer selective and precise control over tissue colouring in an infinite range of ethnic tissue tints.

Performance Highlights:

- Regular: Red tones. Recommended for infants and light completions.
- Suntan: For dark complexions.
- Peach: Reddish-orange tone. As popular as regular Icterine. Also intended for elderly cases, naturally yellowish complexions and Asian types.
- Tan: For somewhat weathered complexions. As the name suggests, similar to Suntan, but has only the brown tones without the reddish colouration.

Every embalmer will have their own preferences when it comes to the addition of dye additives. We recommend starting with a small amount of dye added to your embalming solution. The amount of dye used can be increased as you progress, if the colouration is not to your satisfaction.

Co-Injection Chemicals



Restorative

Dodge Restorative is carefully formulated to carry moisture and humectant conditioners directly into the dried protein substance of dehydrated tissue cells. The action is purely biophysical.

Performance Highlights:

- Controls dehydration.
- Halts syneresis of protein gels.
- Rebuilds tissue physically.
- Restores cellular hydration.
- Prevents tissue shrinkage.
- Moisturises from within.
- Velvetizes skin texture.
- Restores natural contours.
- Stimulates drainage.
- Intensifies arterial diffusion.
- Restores drawn features.
- Enhances illusion of repose.
- Treats frozen, refrigerated and dehydrated cases.

SKU: 360022
Size: 12 x 1 litre

SKU: 360018
Size: 2 x 1 litre



Edemaco

Embalmers are seeing an increase in bodies swollen from oedema with consistently increasing frequency due to new medications and hospital techniques. After years of rigorous testing, our laboratories have developed the Edemaco formula which achieves startling results in its ability to reduce swollen tissue with a unique combination of moisture controlling components.

Performance Highlights:

- Ultra effective in reducing oedematous conditions.
- Reduces swollen tissues without extra procedures.
- Thoroughly field tested.
- Potent in small quantities.
- Creates temporary additional firmness.

SKU: 506005
Size: 12 x 1 litre

SKU: 506006
Size: 2 x 1 litre



Co-Injection Chemicals



Proflo

Proflo is Dodge's newest pre/ co-injection chemical and represents the largest achievement in embalming technology since the introduction of 'Plasdoform-based' chemicals. The advanced action of Proflo is produced using Cosolvent technology. This new formula greatly increases the lubrication in the vessels, functions in a wider pH range as well as water hardness conditions, and aids in penetration of the arterial solution into the tissues. Recommended use is 473 ml per 3.7 litres or 16 oz per gallon.

Performance Highlights:

- Fully compatible with all Dodge arterial and co-injection chemicals.
- A proprietary blend of Dodge Cosolvent technology, including high performance wetting agents, and humectants provide optimum flow, perfusion and colour distribution.
- Provides excellent performance in emaciated and medicated bodies.
- Free from oils, silicone, lanolin and other outdated raw materials.
- Provides good results in varying pH and water hardness conditions.
- Does not contain formaldehyde, phenol or other toxic or highly flammable ingredients.

SKU: 107031
Size: 12 x 1 litres

Metaflow

Metaflow is a Plasdoform-based pre/ co-injection chemical specifically formulated to intensify embalming chemical receptiveness within the vascular system. Used in routine pre and co-injection procedures, Metaflow speeds up injection operations, saves time and contributes importantly to superior, more predictable embalming results.

Performance Highlights:

- Restores permeability to cell membranes. Replaces moisture balance. Releases antibiotic deposits from cells.
- Speeds flow by lubricating blood cell surfaces. Accelerates drainage.
- Detoxifies residues of addictive drugs and chemotherapeutic agents which impair preservation.
- Reduces viscosity of coagulated blood. Disperses vascular obstacles.
- Inhibits precipitation of blood in aged cases. Reduces agglutination. Dissolves fatty gel deposits.
- Prevents cell clumping and clot formation.
- Restores emaciated cases by creating natural moisture balance in tissue cells.
- Dispels jaundice and other post-mortem discolouration.

SKU: 340080
Size: 12 x 1 litres

Co-Injection Chemicals



Halt GX

Halt GX is a new accessory co-injection chemical which will 'halt gas production. Tissue gas cases can generally be classified as 'extreme' cases, this is where the 'X' came from in the name. It Halts Gas in eXtreme cases. The product should be used on any case which:

- Exhibits advanced decomposition.
- Drowning is the cause of death.
- Has experienced injury to the abdominal area.
- Has signs of distension or crepitation.
- Has visible bubbling in the drainage or distended veins.
- Exhibits active tissue gas formation.
- Has had abdominal surgery immediately prior to death.
- Is septic.

Performance Highlights:

- Effective when hypodermically injected into tissue.
- Compatible with all Dodge chemicals and all brands of embalming machines.
- Shows effectiveness during embalming by inhibiting gas production immediately.
- Formaldehyde-free and Phenol-free.
- The only chemical on the market which has been independently inhibition tested for 100% effectiveness against active tissue gas.

SKU: 505076

Size: 12 x 1 litre

SKU: 505075

Size: 2 x 1 litre



Rectifiant

Purifying chemicals, dissolved minerals and gases which are found naturally in water supply sources today are taking a heavy toll in embalming chemical and disinfectant performance. You can keep such interference down to safe levels by treating your tap water with Rectifiant when diluting injection chemicals to working strengths.

Performance Highlights:

- Corrects and conditions tap waters for embalming.
- Neutralises water purifying chemicals, minerals and gases.
- Counteracts jaundice– activating effects of chemotherapeutics.
- Penetrates bacterial "calcium-barrier" defences.
- Stabilises pH values, prevents chemical precipitation.
- Steps up working power of arterials.
- Screens out ionic adulterants bypassed by mechanical water softening equipment.
- Helps clear post– mortem and jaundice discolouration.
- Defibrinates clotted blood.
- Keeps fluid lines and tanks clean.
- Softens and helps to remove vascular blocks.

SKU: 320018

Size: 12 x 1 litre



C
O
I
J
E
C
T
I
O
N



Dri-Cav Cavity

Containing a special drying ingredient not found in any other cavity formulation, Dri-Cav Cavity was developed for use on bodies which would otherwise require reaspiration. In the course of extensive field testing, our chemists learned that they had succeeded not only in that objective, but had as well come up with a formula which our field testers found superior in many other ways.

Performance Highlights:

- Dodge's (and therefore the world's) best selling cavity chemical.
- Use one litre between the abdominal and thoracic cavities for best results.
- Excellent for cavities with unusual amounts of liquid or gas and for everyday conditions.
- Has a wintergreen odour which helps in overcoming unpleasant odours of putrefaction.
- Firms like an ultra high index cavity-but releases far less formaldehyde into the air.
- Greatly reduces liquids found upon reaspiration.

SKU: 225005
Size: 12 x 1 litre
Index: 21



Freedom Cav

Freedom Cav is the first formaldehyde free injectable preservative introduced to the funeral profession by The Dodge Company.

This Formula Works!

You can expect distinct firmness, slightly more than with SynCav, on case after case. The preservation lasts, day after day, week after week. No gas build up, no liquid build up, no odours.

Performance Highlights:

- Keeps down formaldehyde levels. Helps with regulatory compliance.
- Complete user comfort. No fumes at all.
- Field tested on hundreds of cases. Proven preservation.
- Readily detectable firmness.
- Reaspiration not a requirement. Gases and liquids won't build up.
- No odours during use... or later!

SKU: 241801
Size: 12 x 1 litre



Cavity Chemicals



Syn-Cav Cavity

Syn-Cav makes no sacrifice of functional performance for the sake of working ease alone. Allergic and fume sensitive embalmers prefer this unique synergistic full power formula because it yields maximum cavity preservation with minimal working discomfort in application. Syn-Cav takes the terror out of low index embalming - lets you breath freely without going soft on cavity treatment.

Performance Highlights:

- Top favourite of the fume-sensitive embalmer.
- Synergistic formula insures positive preservation with full working comfort.
- Fortified with patented Plasdoform.
- Penetrates deeply, preserves, deodorises, disinfects.
- Suppresses fungi, yeast and viruses. Kills cavity bacteria.
- Inhibits cavity gas formation.

SKU: 250104
Size: 12 x 1 litre
Index: 5



Spectrum Cavity

Spectrum covers the spectrum of features you need in a cavity chemical... gives you all the comfort of Syn-Cav and firming which far surpasses that of any other low fuming chemical ever sold. Spectrum combines the best features of the worlds top selling cavity chemical, Dri Cav, with those of the world's top selling low fuming cavity, SynCav. Contains no more formaldehyde than SynCav (5%) yet it delivers real 20% plus firming action.

Performance Highlights:

- Great for allergic and fume-sensitive embalmers.
- Fortified with Plasdoform and synergism.
- Contains Dri-Cav's unique drying components.
- First and only truly firming "fumeless" cavity.
- No worries about gas build up.
- Kills viruses, bacteria and fungi.
- Special deodorising properties... Clean fresh odour.

SKU: 245018
Size: 12 x 1 litre
Index: 5





Metafix Cavity

Initially formulated for correlated use with the advanced Plasdoform based arterial chemicals. Metafix has since proved itself to be a highly effective universal cavity treatment medium, with a truly remarkable performance record in producing greatly enhanced embalming results.

Performance Highlights:

- Plasdoform based cavity chemical.
- Fortified with a powerful quaternary disinfectant to secure ultra-disinfection.
- Kills infective pathogens, viruses and fungi on contact.
- Extends unique preservative features of Plasdoform to include cavity treatment.
- Little offensive chemical odour.
- Deep-penetrating, powerful.
- Non-bleaching, non-shrinking, non-cauterant.
- Firms visceral tissue without rock-like rigidity.
- Suppresses gas formation.
- Helpful in treating jaundice cases.

SKU: 210017
Size: 12 x 1 litre
Index: 20.5



Permacav 50

Permacav 50 is especially formulated for embalmers who want to know they are getting the maximum formaldehyde percentage modern chemistry can place in a bottle. For professionals who want the absolute utmost in firming!

Performance Highlights:

- Highest index available to modern embalmers.
- Petrifies visceral tissue to rock-like hardness.
- Positive, rapid reacting, powerfully penetrative.
- Bleaches and cauterises on contact.
- May be used in external applications when wrapped.

SKU: 235001
Size: 24 x 473 ml (16 oz)
Index: 50



Cavity Chemicals



Cav-5

The Dodge Cav-5 covers a range of features that you would expect from a cavity fluid... with a reduced level of formaldehyde. With many of the benefits of Dri-Cav and the low fuming qualities of Syn-Cav, you will find that it delivers 20% plus firming action with only a 5.25% formaldehyde level.

Performance Highlights:

- Great for the fume-sensitive or allergenic embalmer.
- Reduces worries about gas build-up.
- Fumeless firming cavity chemical.
- Kills bacteria, viruses and fungi.
- Has unique drying components.
- Benefits from Plasdoform and Synergism.
- Clean fresh odour.

SKU: 260070

Size: 12 x 1 litre

Index: 5.25



Standard Cavity

Although this traditional cavity chemical does not offer the advanced chemical refinements of more recent formulations, its constituents have been modified to conform to more modern performance standards. It is still favoured by many embalmers and delivers fast, dependable results. There is nothing delicate about Standard Cavity, but it does its work with commendable effectiveness and outstanding economy.

Performance Highlights:

- Fully fuming.
- Strongly permeates visceral tissue and organs.
- Deodorises and disinfects as it preserves.
- Cauterises and bleaches upon contact.
- May be used in all standard cavity embalming applications where firming control and working comfort are not essential factors.
- Suitable for use as a cavity pack when used with cotton wool and plastic wrap.

SKU: 260031

Size: 12 x 1 litre

Index: 22.5



Accessory Chemicals



**1 Litre
Trigger Spray**
SKU: 703935
Each



Dis-Spray

Formaldehyde-free, fortified with Mold-x, this new formula provides all the power you need. Dis-Spray is still an exceptional preserving and deodorising topical embalming spray.

Performance Highlights:

- Cuts through surface dirt and body-oil film. Helpful in removing oily exudate when a high fever has occurred prior to death.
- Exceptional preserving and deodorising topical embalming spray.
- Enhanced with Mold-x.
- Can be used on even the most delicate tissues including infant cases and the most tender facial areas.
- Very useful as an additive to arterial solution when treating cases of tissue gas.
- Use 100 ml of Dis-Spray per litre of solution to help eradicate gas bacillus.

SKU: 505070
Size: 2 x 1 litre

SKU: 505074
Size: 12 x 1 litre



Dryene II

Works at the same rate as Basic Dryene as well as bleaching and cauterising in the same manner. No irritating odour.

SKU: 515041
Size: 1 litre

SKU: 515042
Size: 12 x 1 litre



Dryene II Gel

Dryene II Gel is the next generation in cauterising and bleaching products from Dodge. A departure from the standard formaldehyde osmotic gels, containing no phenol. Dryene II Gel can be used without experiencing formaldehyde exposure or the pervasive odour of phenol. The improved thicker consistency of Dryene II Gel allows the product to stay in contact with the affected tissue, allowing better penetration and cauterisation.

Performance Highlights:

- Phenol and formaldehyde-free.
- Cauterises raw or donated tissue areas.
- Bleaches bruised areas.
- Gel consistency stays in place on vertical surfaces.
- Easily applied with brush.
- Insoluble in water, use Feature Builder Solvent to clean off.

SKU: 515051
Size: 350 g



Accessory Chemicals



Dry Wash II

Specially formulated for mortuary hairdressing, Dry Wash II is fast drying de-greasing shampoo that won't change hair colour or interfere with permanents or natural curls. It can be used on a clean pad to remove unabsorbed massage cream, clean brushes, thin cosmetics and feather wax during restorative procedures.

Performance Highlights:

- Leaves hair manageable, soft and lustrous.
- Revives permanent waves.
- Removes grease, dandruff and 'cradle cap'.
- Dries quickly-saves hairdressing time.
- Thins cosmetics and cleans brushes.
- Excellent solvent, removes creams, helps smooth wax during restorative procedures.
- Removes stains from fabric (always test fabric first).
- Contains no trichloroethylene.

SKU: 520072
Size: 500 ml

SKU: 520071
Size: 6 x 500 ml



Syn-Gel HV

Dodge SynGel allows a very low concentration of formaldehyde to do the work which otherwise requires very high concentrations. The preservative-disinfectant action of SynGel results in fumeless comfort with thorough preservation. SynGel also incorporates another Dodge breakthrough: The Plasdoform molecule, which prevents "walling off", replaces jaundice pigments and affords quaternary disinfection potency.

Performance Highlights:

- Great on hands, face or anywhere, where more surface penetration is required.
- Paint on and cover with plastic wrap.
- For autopsied cases, paint or pour liberally onto surfaces inside the thoracic and abdominal cavities and onto ribcage and flaps.
- For cranial autopsies, SynGel treats the floor of the cranial vault and inside the scalp.
- In cases of skin slip, ulceration, bed sores etc., use as a pack.
- Good for treating newly amputated areas and areas where skin has been removed for grafts.

SKU: 509101
Size: 440 g

SKU: 509102
Size: 1 kg

SKU: 509103
Size: 4 kg



Basic Dryene

Dodge Dryene has earned its reputation as one of the most useful and versatile chemicals in the funeral profession. With almost infinite technical applications in embalming this cauterant merits a place in every embalming room. Dryene more than pays its way in operational ease, professional convenience and outstanding embalming performance.

Performance Highlights:

- Treats broken skin areas.
- Effectively dries, bleaches, cauterises and deodorises.
- Effective as a cavity chemical in cases where tissue gas is evident.
- Basic Dryene is formulated to bleach strongly.

SKU: 515032
Size: 1 litre

SKU: 515034
Size: 12 x 1 litre





Formaldegone

Formaldegone, a formaldehyde gas eliminator, has no odour of its own. It contains no dangerous chemicals, yet it immediately eliminates formaldehyde gas odours.

Performance Highlights:

- Formaldegone combines chemically with formaldehyde rather than masking it.
- A terrific aid in complying with COSHH regulations.
- Can be re-used if the source continues to generate odours.
- Repeated spraying can cause some floors to become slippery or tacky. Use caution when walking. A damp paper towel quickly and easily removes any undesirable film.

SKU: 550002

Size: 1 litre

SKU: 550001

Size: 473 ml (16 oz)



1 Litre Trigger Spray

SKU: 703935

Each



Kaloform

Kaloform, an emollient massage cream containing formaldehyde, achieves external preservation of areas not reached by arterial injection.

Performance Highlights:

- Easy to apply.
- Aids in treating "soft" areas.
- Will not wrinkle tissue.

SKU: 690116

Size: 440 g

Accessory Chemicals

Feature Builder Accessories



Hypodermic Needle Luer Lock 1.5" Fine

Unit Size: 22 gauge x 38 mm
SKU: 704316



Hypodermic Needle Luer Lock 2.5" Medium Fine

Unit Size: 20 gauge x 63.5 mm
SKU: 704318



Hypodermic Needle Luer Lock 2.25"

Unit Size: 18 gauge x 86 mm
SKU: 705145



Hypodermic Needle Luer Lock 6" Coarse

Unit Size: 15 gauge x 150 mm
SKU: 704322

Hypodermic Syringes



Hypodermic Nylon Syringe 20 ml Luer Lock

SKU: 705110



Hypodermic Glass Syringe 10 ml Luer Lock

SKU: 705011



Hypodermic Glass Syringe 20 ml

SKU: 705019

Hypodermic Needles

The Dodge Company is please to offer a full range of hypodermic needles which can be used for a variety of different tasks in the embalming room. All of the needles will function with luer lock syringes for added safety when injecting strong preservative, cauterant or tissue building chemicals. Images not shown to scale.



Hypodermic Needle Luer Lock 4" Coarse

Unit Size: 14 gauge x 100 mm
SKU: 705140



Hypodermic Needle Luer Lock 10" Coarse

Unit Size: 13 gauge x 254 mm
SKU: 704336



Hypodermic Needle Luer Lock 8" Coarse

Unit Size: 13 gauge x 200 mm
SKU: 704335



Hypodermic Plastic Syringe 20 ml

SKU: 705007

Size: Pack of 10

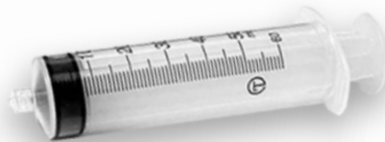

Hypodermic Plastic Syringe 50 ml

SKU: 705008



Disposable Needles for use with Syringes

SKU: 705006

Size: Pack of 100



Accessory Chemicals

Feature Builder

One of the most versatile and useful accessory chemicals we know of. This fast-setting tissue-filling gel rebuilds characteristic facial features and helps restore normal appearance to dehydrated and emaciated cases. Fills, firms and plumps without risk of after-set shrinkage. Improves and accentuates the illusion of repose in the final presentation. Available in two types: Regular for normal tissue filling and Firming for areas that need preservation as well as filling.



Regular
SKU: 507013
Size: 110 ml



Firming
SKU: 507078
Size: 110 ml



Solvent
SKU: 507130
Size: 110 ml



Regular/Firming

Performance Highlights:

- Free flowing for fast, easy hypodermic injection.
- Sets rapidly, remains stable. Won't shrink.
- Restores natural expression, normal tissue contours.
- Seals needle punctures.
- Masks facial muscle shadow, repels spotting, mottling.

Solvent

Feature builder Solvent is used for cleaning procedures after completion of tissue building and removes feature builder from hypodermic needles and syringes.

As a note of caution, we recommend that eye protection be used whenever the injection of chemicals is being undertaken. When injecting feature building products, we not only advocate the use of eye protection but also the use of luer lock needles and syringes to prevent the risk of spraying chemicals under pressure.

Accessory Chemicals



Pore Closer

Pore closer has an exceptional broad range of practical uses throughout the embalming room. Pore closer can be used to seal exposed applications of Inr-Seel, surface lacerations, deep wounds, diseased lesions, surgical excisions, burns, sores and abrasions.

Performance Highlights:

- Restores a natural surface in every category of broken-skin conditions. Prevents leakage and forms an excellent base for artful cosmetic finishing.
- Adheres firmly, creates a naturally contoured, safely sealed and stable surface which is highly receptive to all standard restorative procedures and cosmetic components.
- Acts as its own solvent.

SKU: 525261

Size: 385 ml bottle & brush



Perma-Seel

Perma-Seel is a versatile sealing medium that can be applied by brush or sprayed on to form a quick drying and transparent chemical "skin" of great strength. It won't crack, glaze, blister or peel. Available as a handy aerosol spray or in a wide mouth container for application by brush.

Performance Highlights:

- Seals seeping lesions, cuts, amputations.
- Secured external packs and bandage bindings.
- Dries rapidly to form a smooth flexible "Skin".
- Adheres firmly to tissue and fabric.
- Impervious to body fluids and embalming chemicals.
- Speeds and simplifies many prep room operations.
- Requires a separate solvent for clean up.

Aerosol

SKU: 525295

Size: 200 ml



Liquid

SKU: 525310

Size: 225 ml (8 oz) & brush

Solvent

SKU: 525404

Size: 385 ml (13 oz)



SKU: 525303

Size: 385 ml (13 oz) & brush



Adhesives



Zip Lip

Zip Lip is a fast setting liquid adhesive for immobilising lips and eyelids. It is truly superior to all other cements of this type on the market.

Performance Highlights:

- Prevents unsightly partings.
- Holds well, yet remains invisible.
- Sets firmly and can be separated and re-set if adjustments are necessary.
- For those who prefer a bond considerably less tenacious than that created by the cyanocrylates.
- Brush applicator attached to cap.

SKU: 690020

Size: 15 ml (0.5 oz)



Aron Alpha

This unique adhesive has become the choice of many operators in the embalming room. Chemically, Aron Alpha is composed mainly of alpha cyanoacrylate monomer in a liquid state. When this monomer is applied in a single thin coating to a bonding surface, it instantly solidifies through polymerisation to produce an extra high strength bond. Perhaps you should see why so many embalmers choose Aron Alpha.

Performance Highlights:

- Closes mouths, seals incisions and I.V. holes.
- Produces an extra high strength bond, up to 5,000lbs per square inch.
- Low viscosity permits easy spreading over surfaces to be bonded, the bond is colourless and transparent.
- Sets very rapidly (within 10 to 45 seconds).

Solvent

SKU: 920166

Size: 29 ml (1 oz)



Gel

SKU: 920167

Size: 20 g tube



3M Scotch Weld

AC11 Accelerator Spray

SKU: 921165

Size: 200 ml



PR100 Nozzle

SKU: 921169

PR100

SKU: 920160

Size: 1 x 20 g bottle

SKU: 920165

Size: 10 x 20 g tube



Accessories

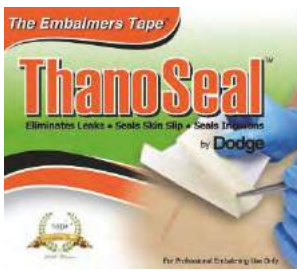

ThanoSeal™

ThanoSeal™ tape is a clear occlusive film sealant which is designed to seal incisions, lacerations, abrasions, puncture and leaking wounds. It should not be used under any circumstances on living tissue. Available in different sized rolls, allowing the operator to cut the tape to the desired length.

SKU: 035206
Size: 2 x 20" roll

SKU: 035207
Size: 4 x 20" roll



Triple Cut Adhesive Tape

Hardworking and versatile, 3-in-1 plastic-spooled design. Makes measuring, cutting, and application easy. The roll combines three available sizes.

SKU: 761320
Size: 2" x 5 yard spool



White Duct Tape

Known for its surprisingly strong adhesive properties, even under moist conditions.

SKU: 761312
Size: 60 yard roll

Kalip Stay Cream

Kalip Stay Cream is a light coloured, firm bodied blend of rich tissue emollients contained in an adhesive base. Its consistency is heavy enough to give dependable holding action without the rigidity, skin "drawing" and surface dehydrating effects of ordinary cement like adhesives.

Performance Highlights:

- Fully workable and easily applied.
- Can be used on the delicate tissues of the eyes, lips and nostrils.
- Smooths unsightly wrinkles and folds in place.
- Useful for filling the tiny separation which can occur between lips - as well as small fissures on a lip.

SKU: 680021
Size: 56 g

SKU: 680026
Size: 440 g



Inr-Seel

Specifically formulated to safeguard against troublesome post-embalming upsets, these mastic moulding and holding compounds are numbered among the most versatile and useful in the embalming room. When either of these compounds is exposed to the air, it should be coated with Pore Closer or Perma Seel to avoid shrinkage that would otherwise occur.

Performance Highlights:

- Soluble in cold water, clean up is easy.
- Fills out eye lids and seals hypo punctures, bullet holes and ear leakage. Can be used to align crooked noses and fill mouth contours in lieu of cotton wool.
- Excellent for use on eye enucleation and cranial autopsy cases.

SKU: 555011
Size: 1 lb 3 oz

SKU: 555029
Size: 6 lb 3oz



A
C
C
E
S
S
O
R
I
E
S

Round Plain Eye Caps

SKU: 751412
Pack of 100



Oval Perforated Clear Eye Caps

Small

SKU: 751340
Pack of 100

Large

SKU: 751345
Pack of 100



Multi Size Expressions

SKU: 760496
Pack of 12

Dodge Oval Perforated Clear Eye Caps

Small

SKU: 751608
Box of 144

Large

SKU: 751610
Box of 144



Dodge Oval Perforated Flesh Eye Caps

Small

SKU: 751606
Box of 144

Large

SKU: 751605
Box of 144



Dental Simulator Former

SKU: 760520
Pack of 12



Perfection Round Perforated Clear Eye Caps

Small

SKU: 751505
Pack of 144

Medium

SKU: 751506
Pack of 144

Large

SKU: 751504
Pack of 144



Pierce Armstrong Mouth Former

SKU: 760510
Pack of 12

Perfection Round Perforated Flesh Eye Caps

Small

SKU: 751508
Pack of 144

Medium

SKU: 751509
Pack of 144

Large

SKU: 751507
Pack of 144



Clear Plastic Mouth Plates

SKU: 760553
Pack of 24

Identification Bracelet Insert

SKU: 720517
Pack of 100



Identification Bracelet Write On

SKU: 720510
Pack of 100



White Wrist Bands

SKU: 720514
Pack of 1000



Suction Cup Tube Holder

SKU: 703306



Metal Screw Skull Clamps

SKU: 750680
Pack of 20

Embalming Powder



Sanisorb

A must have in any embalming room, Dodge Sanisorb can be used in any situation where a dependable absorptive product with a pleasant scent is required.

Performance Highlights:

- Absorbs copious amounts of moisture.
- Perfect inside plastic garments where leakage or oedema may cause problems.
- Excellent for use in coffins of repatriation cases.
- Use in coffins stored in vaults or mausoleums.
- Cleans up any embalming room spills instantly.
- Absorbs moisture in the cavities of autopsy cases as well as inside bone donation incisions.
- Uses for Sanisorb are limited only by your imagination.

SKU: 530450
Size: 500 g

SKU: 530451
Size: 2 kg

QS Sealer

Performance Highlights:

- Forms powerful, positive and dependable closures.
- Contains highly effective deodorising and preserving chemicals.
- Pleasant to use, does not create dust in the air.
- Will not cake or turn gummy, Q-S Powder lasts for years if container is kept closed.
- Excellent for incisions, wounds, open lesions, suture, needle holes, body orifices and autopsy cases.
- Works virtually on contact. No waiting around for a seal to develop.

SKU: 560111
Size: 500 g

SKU: 560140
Size: 3.5 kg



Viscerock FF

New from the Dodge Company, Viscerock FF (Formaldehyde Free). This product is nearly dustless, free flowing and will not cake in any environment. Viscerock FF will dry and firm moist tissues and adhere to all tissue surfaces. It can be used in plastic garments to dry oedematous limbs and inside the cavities of autopsied cases. Pleasant in use, Viscerock FF is great for use by fume sensitive embalmers and will create no unpleasant odours during use.

SKU: 535115
Size: 2.25 kg



As with all products containing Formaldehyde, the operator should be sure to use them in a well ventilated area. For more difficult situations, please see our range of Formaldehyde respirators.

Embalming Powder



Action Powder

A real must have for any and every embalming room. Dodge Action powder delivers fast dependable preservation to areas not receiving fluid through arterial injection. Action powder may be used freely on autopsy cases for treating the trunk walls or cranial vault. Action may also be used for cases requiring deodorising and preservative treatment which are beyond arterial injection.

Performance Highlights:

- Assured performance on cases where arterial injection could be difficult if not impossible.
- Excellent inside caskets, grave vaults, mausoleums and crypts.
- Very useful for treating bed sores, cancerous or putrefactive areas.
- Effective in lieu of hypo work on wet or dry decomposed cases or autopsy cases where trunk walls do not receive adequate fluid during injection.
- Use with plastic undergarments to preserve and dry oedematous limbs.
- Useful for treating infant cases where traditional treatments would be impracticable.
- Used by many for the treatment of exhumed or disinterred cases.

SKU: 536098

Size: 4 kg



Paraformaldehyde Prills

A convenient way of applying Paraformaldehyde to the surfaces or cavities of a body in a relatively dust free manner. Paraformaldehyde Prills can be used in lieu of Hypo work on autopsies and difficult cases, or applied to bodies where decomposition has rendered arterial injection impossible. Paraformaldehyde Prills fume heavily and care should always be taken to apply in a well ventilated area.

SKU: 910205

Size: 3.5 kg

Absorbents

Dodgesorb Absorbent Sheets

Each sheet consists of three layers: a top fabric layer, a Dodgesorb-impregnated middle layer and a plastic bottom layer. Even after exposure to moisture, they retain integrity and can be removed from their area of use.

White sheet 25" x 72"

- For use over or under the body.
- Absorbs approximately 4.6 litres of fluid.

SKU: 038346

Size: 25" x 72" Single



White sheet 63" x 90"

- For use in wrapping the entire body.
- Absorbs approximately 6.2 litres of fluid.

SKU: 038341

Size: 63" x 90"

Single



Dodge Disposable Sheets

Hardwearing, absorbent sheets - removal sheets. Perfect for use during first calls.

SKU: 760842

Size: 61.5" x 85.5"

Box of 50



Dodgesorb Absorbent Liners

These liners consist of an exposed layer of Dodgesorb impregnated material, which will turn to loose gel in the presence of moisture. Once in place, this sheet must remain there.

Performance Highlights:

- Idea for insurance for oedematous cases or those being repatriated by road, air or sea.
- White sheet 24" x 86".
- For use inside coffins and caskets being repatriated or entombed.
- Absorbs approximately 5 litres of fluid.

SKU: 038376

Size: 24" x 86"

Single



As with all products containing Formaldehyde, the operator should be sure to use them in a well ventilated area. For more difficult situations, please see our range of Formaldehyde respirators.

Dodgesorb Absorbent

Performance Highlights:

- Fluid impervious white plastic sleeves and stockings have an inner liner that contains a layer of DodgeSorb to provide added protection by capturing and containing fluids.
- All openings are elasticated to provide a good fit and reduce leakage.

Sleeves

SKU: 760882

Pair



Stockings

SKU: 760885

Pair

Dodgesorb Absorbent Inserts

These are smaller absorbent pads, with a DodgeSorb layer inside two fabric layers.



Small Insert 3.25" x 10.5"

- Absorbs approximately 232 ml of fluid.
- Use for packing cranial thoracic and tracheal stomata.

SKU: 038331

Size: 3.25" x 10.5"

Pack of 5

Medium Insert 3.25" x 14"

- Absorbs approximately 478 ml of fluid.
- A tube like pad through which a pipe prosthetic can be inserted, or use.

SKU: 038326

Size: 3.25" x 14"

Pack of 5

Large Insert 3.25" x 37.5"

- Absorbs approximately 1 litre of fluid.
- Also tube like, fits around long bone prosthetics.

SKU: 038321

Size: 3.25" x 37.5"

Pack of 5

Superabsorbent Sachets

Sold in boxes of 50 individual sachets, this absorbent product can be used to seal leaking incisions, pack the nose and throat of the deceased and even to close anal and vaginal orifices. Dodge Superabsorbent is applied in the same way as cotton wool or cellulose wadding. This product will absorb a remarkable amount of fluid and form a leak proof seal.

SKU: 750991

Box of 50 Sachets



Absorbents



Dodgesorb Cranial Caps

Cranial caps are designed to absorb seepage due to autopsied or mutilated heads. Inside the cap is absorbent, while the outside is fluid impervious. Conveniently conforms to the shape of the head. Slide under the head and the cap sinks into the coffin or casket pillow. Absorbs approximately 3 litres of fluid.

SKU: 750594
Pack of 12



Cranial Caps

These caps are easy to conceal and can be adjusted by the user to suit individual cases. Designed to divert leakage from the back of the head, these caps help to prevent staining of the deceased clothing and the interior of the coffin or casket.

SKU: 750596
Box of 12

Spill Kits

These are nice shelf contained kits as you can use the buckets lined with the biohazard bag to hold the contents of the spill.

Small Spill Kit

SKU: 042751

Contents:

- 6 oz bottle of Dodgesorb (this will work on a gallon or more liquid, depending on the type).
- A scooper.
- Pair of Nitrile gloves.
- 2 oz bottle of Quick San.
- Disposable wipes.
- Biohazard bag and bucket.

Large Spill Kit

SKU: 754007

Contents:

- 2 x 3 metre socks
- 15 x Pads
- 1 x Disposal bag & tie
- 1 x Formaldegone liquid
- 1 x Trigger spray
- 1 x 25 litre container





Incontinence Pads

- Intended to be placed under the deceased during removal.
- Absorbs large quantities of liquid.
- Protects staff, equipment and home furnishings from leakage.
- Useful lining of the cavities of autopsy cases before returning the treated viscera.

SKU: 750730
Size: 60 x 90 cm
Case of 180



Disposable Briefs

Disposable unisex briefs provide comfortable and dignified underwear for users. They are manufactured from durable non-woven material, which is softer and stronger than paper alternatives, particularly when wet. Packed in easy-dispense packs of 100 briefs.

SKU: 750990
Size: XL (one size)
Pack of 100



Disposable Nappies

- Added protection against leakage from embalmed and un-embalmed cases before dressing and placing in the coffin.
- Use in conjunction with Dodge Sanisorb or D-12 powder to overcome offensive odours.

SKU: 750726
Size: 70 x 110 cm
Pack of 15

Disinfectant Products

Dodge Hand & Body Wash

For disinfecting and decontaminating hands and skin. This 3 in 1 lathering hand and body wash leaves hands and skin clean with a fresh fragrance and provides protection against infection.

SKU: 777007
Size: 500 ml

SKU: 777008
Size: 5 litre refill



Dodge Foaming Hand Rub

Pump decontaminating foam directly on to hands, rub together and get the benefit of disinfected and visibly clean hands.

SKU: 777010
Size: 500 ml

SKU: 777011
Size: 5 litre refill



Dodge Hand Rub Tottle

Keep in your coat pocket or purse to disinfect your hands when soap and water are not available. Comes with a loop and clip so you can place it on your belt or scrubs.

SKU: 777003
Size: 50 ml



Dodge All Purpose Wipes

Clean and disinfect with these simple to use all purpose wipes. Use on all hard and soft surfaces as well as the skin. Especially useful for cleaning removal equipment after making transfer or Coroner's Removals.

SKU: 777012
Size: 225 wipes



Dodge Sterilisation Mist

This innovative product allows the user to disinfect and sterilise embalming rooms, autopsy rooms, dissection rooms, cold rooms, refrigerators and even ventilation systems and ducts. Application of this chemical is achieved using a fogging machine. The fogging machine creates a super fine mist which is able to diffuse into areas that can not be reached by traditional cleaning methods. This product is particularly effective at removing unpleasant odours and ensuring the highest levels of hygiene especially after treatment of infectious or high risk cases.

SKU: 777015
Size: 5 litre



Fogging Machine 2600

Used in conjunction with Dodge Sterilising Mist the fogging machine generates an ultra fine mist which allows the sterilisation chemical to reach areas unreachable by conventional cleaning methods. This allows for the thorough cleaning and sterilising of large and small areas alike, as well as treating ventilation ducts, downdraft autopsy and embalming tables as well as ensuring staff safety after the autopsy or embalming of infectious cases.

For more information please contact your Dodge Representative.

SKU: 761217



Disinfectant Products

Dodge Disinfectant and Hygiene products offer a single solution to your disinfection and sanitation needs with consideration to safety of use, non-toxicity, and the environment. These products address a wide spectrum of bacterial activity and effectiveness against both gram positive and negative. In fact they are 99.999% effective against the widest spectrum of Bacteria, Viruses, Fungi Spores and Yeast. There is no Formaldehyde, Gluteraldehyde, Chlorine or other harmful chemicals in the formulations.

Performance Highlights:

- Active against odour
- Active against yeast
- Fast rate of kill at low levels
- Non-corrosive
- Non-staining
- No Smell
- Safe for use on hard and soft surfaces

Dodge Disinfectant Concentrate

Antimicrobial and cleansing. This product can be applied to hard and soft surfaces and equipment to be cleaned and disinfected. Either leave to dry and wipe off or rinse with clean water.



Citrus
SKU: 777002
Size: 5 litre

Cherry
SKU: 777000
Size: 5 litre

Non-Fragranced
SKU: 777001
Size: 5 litre



Dodge Phosphoric Cleaner

SKU: 761216
Size: 1 litre



Thick Bleach

10% thick bleach.

SKU: 922493
Size: 5 litre



Dodge Surface Sanitiser

Safe to use on all hard and soft surfaces. Cleans and disinfects in single action. Ready to use spray or wipe onto the surface.

Cherry Fragranced
SKU: 777009
Size: 750 ml

Non-Fragranced
SKU: 777004
Size: 750 ml

SKU: 777005
Size: 5 litre

SKU: 777006
Size: 5 litre



Dodge Clean All

An excellent cleaning product for use on everything from vehicles to the most stubborn of stains in the embalming room prior to disinfection. Use on all hard and soft surfaces.

SKU: 777017
Size: 750 ml

SKU: 777018
Size: 5 litre



Deodorant Products

Exclusive EU Supplier of Neutrolene Products



NeutrOlene Spray

NeutrOlene spray is available in a 32 oz bottle and a new 8 oz portable size. Keep one in the post mortem room, fridge room and anywhere where the risk of odour exists.

SKU: 921885

Size: 8 oz (237 ml)

SKU: 921880

Size: 32 oz (946 ml)



NeutrOgran Granules

NeutrOgran Deodorising Granules are packaged in a handy 8 lb shaker jug. Use this product on spills and the odour will be eliminated. Can also be applied inside the cavities of decomposed cases or over the case in a body bag to eliminate odours.

SKU: 921890

Size: 8 lb (3.63 kg)



NeutrOHang Sock & Mini Hang

NeutrOHang uses natural ingredients to hold the powerful & effective concentrated neutraliser. Works excellent in coolers or refrigeration systems. Each NeutrOHang will provide neutralisation for 30-45 days, in a 100 sq. ft. area.

Performance Highlights:

- Decomposition & odour neutraliser.
- Prevents lingering odours.
- Ideal for fridges and cold rooms.
- Unique cloth mesh bag for even distribution of odour counteractant.
- Convenient mounting loop.
- Air-controlled odour counteractant.
- 100% organic carrier.

Sock

SKU: 921851

Each



3" Mini

SKU: 921852

Each



Deodorant Products

Nil aqua Towel Off Shampoo

Nil aqua Towel Off Shampoo is the new way to get fresh clean hair without using water! Nil aqua wets your hair like traditional shampoo and cleans without leaving any streaks or sticky residues. It's mild formula leaves hair soft and clean. No rinsing required.

SKU: 521000
Size: 65 ml

SKU: 521001
Size: 200 ml

SKU: 521002
Size: 500 ml



Nil aqua Towel Off Body Wash

Nil aqua Towel Off Body Wash gently and effectively cleanses and moisturises your skin leaving the body fresh and clean without using water. No rinsing required.

SKU: 521005
Size: 65 ml

SKU: 521006
Size: 200 ml

SKU: 521007
Size: 500 ml



D-12 Deodorant Powder

- Disperses odours, freshens public rooms, chapels and offices.
- Many embalmers apply D-12 to cancerous, ulcerated and gangrenous cases.
- May be applied dry near or directly on the source of offensive odours.
- May be used in aqueous solution as a deodorant spray and room freshener.
- Destroys and suppresses offensive odours.
- Leaves no after-scent of its own.
- Gives long-lasting deodorising effectiveness.
- Will not cake or harden in the container.

SKU: 502013
Size: 14 oz (414 ml)



AirFresh Med Air Cleaner

- Cleans the air from dust and germs.
- Specially formulated for use in dental clinics, hospitals, nursing homes and doctor surgeries.
- Uses odour absorbing technology.
- Lasting fresh scent.
- Biodegradable according to OECD guidelines.

SKU: 921563
Size: 75 ml

SKU: 921562
Size: Case of 6



Flying Insect Spray

Contains an advanced formulation that eliminates wasps, mosquitoes and other flying insects. Targets and eliminates fleas, cockroaches and other types of crawling insects.

SKU: 921592
Size: 300 ml



Citrus II Natural Air Deodoriser

- Eliminates harsh odours in the funeral home.
- Non-toxic, hypo allergenic and biodegradable.
- Safe for asthmatics and allergy-sensitive individuals.

SKU: 910563
Size: 7 oz (207 ml)



Cosmetics

Kalon Pigments

Designed to be a fast and effortless system for complexion matching and application, The Kalon system is widely favoured as one of the most flexible and versatile cosmetic systems of the funeral profession. The Kalon System produces an excellent, natural looking cosmetic finish and is economical in use.



Performance Highlights:

- Available in 21 dense covering shades for blending and for masking blemishes.
- Used with the Kalon creams, they produce an infinite range of intermediate skin tones.



Light Flesh

SKU: 640300
Size: 1 oz (28 g)



Brunette

SKU: 640201
Size: 1 oz (28 g)



Tan

SKU: 640375
Size: 1 oz (28 g)



Peach

SKU: 640714
Size: 1 oz (28 g)



Natural

SKU: 640755
Size: 1 oz (28 g)



Infant

SKU: 640615
Size: 1 oz (28 g)



Light Suntan

SKU: 640417
Size: 1 oz (28 g)



Suntan

SKU: 640458
Size: 1 oz (28 g)



Deep Flesh

SKU: 640920
Size: 1 oz (28 g)



Light Copper

SKU: 640953
Size: 1 oz (28 g)



Ivory

SKU: 640268
Size: 1 oz (28 g)



Lip Colour

SKU: 640634
Size: 1 oz (28 g)



Youthful

SKU: 640656
Size: 1 oz (28 g)



Light Brown

SKU: 640490
Size: 1 oz (28 g)



Dark Brown

SKU: 640532
Size: 1 oz (28 g)



Dark Suntan

SKU: 640433
Size: 1 oz (28 g)



Dark Flesh

SKU: 640342
Size: 1 oz (28 g)



Adult

SKU: 640573
Size: 1 oz (28 g)



Old Age

SKU: 640680
Size: 1 oz (28 g)



Dark Copper

SKU: 640979
Size: 1 oz (28 g)



Rose

SKU: 640730
Size: 1 oz (28 g)

Kalon Massage Cream

- Available in white for cosmetic massage and foundation treatment.
- Also in eight non-masking tinting shades.
- Richly emollient, smooth, non-caking.



White

SKU: 910746
Size: 56 g (2 oz)

SKU: 910753
Size: 440 g

SKU: 910754
Size: 1 kg

SKU: 910756
Size: 2.25 kg (5 lb 10 oz)



Blonde

SKU: 620054
Size: 56 g (2 oz)



Brunette

SKU: 620096
Size: 56 g (2 oz)

SKU: 620100
Size: 411 g (14.5 oz)



Tan

SKU: 620120
Size: 56 g (2 oz)



Suntan

SKU: 620151
Size: 15 g (0.5 oz)

SKU: 620153
Size: 56 g (2 oz)

SKU: 620154
Size: 411 g (14.5 oz)



Pink

SKU: 620187
Size: 56 g (2 oz)

SKU: 620195
Size: 411 g (14.5 oz)



Deep Flesh

SKU: 620211
Size: 56 g (2 oz)

SKU: 620229
Size: 411 g (14.5 oz)



Brown

SKU: 620230
Size: 56 g (2 oz)



Copper

SKU: 620232
Size: 56 g (2 oz)



Kalon Powders

- Available in white and four standard tints for fast, natural looking drying and finishing.



White

SKU: 642800
Size: 100 g



Flesh

SKU: 642835
Size: 28 g (1 oz)

SKU: 642834
Size: 100 g



Brunette

SKU: 642861
Size: 28 g (1 oz)

SKU: 642860
Size: 100 g

SKU: 642862
Size: 400 g (14 oz)



Suntan

SKU: 642890
Size: 100 g



Orchid

SKU: 642933
Size: 100 g

Please note: The colour samples shown indicate the colour of the cosmetic in the jar. In the case of opaque cosmetics, this is also the colour you'll see when the cosmetic is applied to the skin. This is not necessarily so for translucents. Kalon Cream Blond, Pink and Deep Flesh are three shades which do not look the same in the jar and on the skin. Blond for example is not at all orange when applied; it simply imparts a warm flesh tone. Also please understand that some of the colours shown here will be imperfect reproductions of the colours of the cosmetics. This is a function of the limitations of modern four-colour printing, but will serve as reasonable guides. These matches are still relatively close.

Cosmetics

Kalochrome Cream



Kalochrome Creams can be spread heavily (opaquely) over areas requiring covering, and then thinly (translucently) over other areas on the same body where covering is not required. When applied at medium thickness the Kalochrome cream tends to be semi opaque.

Remarkable lifelike duplication of natural complexion characteristics may be quickly and easily achieved by interblending and applying these smooth, rich tinted creams with Kalochrome Cosmetic Powder. Non-caking and easily blended, these creams are a cosmetic medium of great versatility for creating truly artistic cosmetology.

	#1 Infant Basic SKU: 650010 Size: 15 g (0.5 oz)			#12 Tan SKU: 650127 Size: 15 g (0.5 oz)	SKU: 650325 Size: 28 g (1 oz)
	#2 Brunette Basic SKU: 650028 Size: 15 g (0.5 oz)	SKU: 650226 Size: 28 g (1 oz)		#13 Yellow SKU: 650135 Size: 15 g (0.5 oz)	SKU: 650333 Size: 28 g (1 oz)
	#3 Blonde Basic SKU: 650036 Size: 15 g (0.5 oz)	SKU: 650234 Size: 28 g (1 oz)		#14 Blue SKU: 650143 Size: 15 g (0.5 oz)	SKU: 650341 Size: 28 g (1 oz)
	#4 Latin Basic SKU: 650044 Size: 15 g (0.5 oz)	SKU: 650242 Size: 28 g (1 oz)		#15 Purple SKU: 650150 Size: 15 g (0.5 oz)	SKU: 650358 Size: 28 g (1 oz)
	#5 Light Brown SKU: 650051 Size: 15 g (0.5 oz)	SKU: 650259 Size: 28 g (1 oz)		#16 Crimson SKU: 650168 Size: 15 g (0.5 oz)	
	#6 Dark Brown SKU: 650069 Size: 15 g (0.5 oz)	SKU: 650267 Size: 28 g (1 oz)		#17 Black SKU: 650176 Size: 15 g (0.5 oz)	SKU: 650374 Size: 28 g (1 oz)
	#8 Youthful SKU: 650085 Size: 15 g (0.5 oz)	SKU: 650283 Size: 28 g (1 oz)		#18 Dense Covering SKU: 650184 Size: 15 g (0.5 oz)	
	#9 Adult SKU: 650093 Size: 15 g (0.5 oz)	SKU: 650291 Size: 28 g (1 oz)		#19 Mulberry SKU: 650195 Size: 15 g (0.5 oz)	
	#10 Old Age SKU: 650101 Size: 15 g (0.5 oz)	SKU: 650309 Size: 28 g (1 oz)		Rouge Light SKU: 650515 Size: 15 g (0.5 oz)	
	#11 Ivory SKU: 650119 Size: 15 g (0.5 oz)	SKU: 650317 Size: 28 g (1 oz)		Rouge Dark SKU: 650531 Size: 15 g (0.5 oz)	



Rose Blending Powder

Subtle blending finishing powder for use after cosmetic application.

SKU: 642955
Size: 100 g

Aquachrome

Aquachrome cosmetics are water-based like the cosmetics available over the counter, however they are formulated specifically for use in our field. It's translucent, so it imparts a natural no masking tone to the skin. Included in the formula are:

- Natural moisturisers and softening agents, derived from lanolin and cholesterol, which are similar to the lipids in the fat of the skin.
- Hygroscopic materials which penetrate the skin, absorb moisture and leave no greasy feel.
- Materials which form water-resistant skin films with a fine texture and a non-drying effect.

Performance Highlights:

- Every ingredient in Aquachrome is non-toxic and non-irritating to the skin.
- Special ingredients give stability of viscosity and emulsion for long shelf life.
- Ingredients are cosmetic grade, including the pigments which are accepted for use on living skin.
- Preservative system is a broad spectrum one, effective against gram negative bacteria such as pseudomonads and against yeast and moulds.



Light Blending

SKU: 660003
Size: 28 g (1 oz)

SKU: 660043
Size: 113 g (4 oz)

Highlight

SKU: 660006
Size: 28 g (1 oz)

SKU: 660046
Size: 113 g (4 oz)

Light Suntan

SKU: 660002
Size: 28 g (1 oz)

SKU: 660042
Size: 113 g (4 oz)

Dark Blending

SKU: 660004
Size: 28 g (1 oz)

SKU: 660044
Size: 113 g (4 oz)

Suntan

SKU: 660001
Size: 28 g (1 oz)

SKU: 660041
Size: 113 g (4 oz)

Brown

SKU: 660007
Size: 28 g (1 oz)

SKU: 660047
Size: 113 g (4 oz)

Peach

SKU: 660005
Size: 28 g (1 oz)

SKU: 660045
Size: 113 g (4 oz)

Ebony

SKU: 660008
Size: 28 g (1 oz)

SKU: 660048
Size: 113 g (4 oz)

Complexion Cream

A particular favourite of The Dodge Magazine author Dennis Daulton, these cosmetics offer true versatility and can be applied to provide translucent or opaque coverage.

Performance Highlights:

- Complexion Creams are to an extent dual purpose and depending on the thickness of the application can be translucent or opaque.
- Complexion Creams tend towards translucency more than Kalochromes. Apply a light to moderate amount over normal skin, then apply a heavier layer to cover razor burn or ecchymosis.
- Testers recommend the flesh shade on male or female Caucasians of average skin colour.



Light Flesh

SKU: 610600
Size: 1 oz (28 g)

Flesh

SKU: 610592
Size: 1 oz (28 g)

Dark Flesh

SKU: 610618
Size: 1 oz (28 g)



Perma Liquid

The Perma concept of embalming cosmetology was specifically developed to extend the scope of the embalmer's art beyond that of ordinary cosmetic preparations. The Perma pigments and powders simplify and accelerate the cosmetic procedure. You'll find that they function with exceptional effectiveness even under the most difficult post-mortem conditions. Intermixable, fast drying, non-caking. These cosmetics will not crack or peel and provide an infinite colour range with superb marking qualities.



Light Basic

SKU: 670018
Size: 1 oz (28 g)



Dark Basic

SKU: 670026
Size: 1 oz (28 g)



Light Flesh

SKU: 670034
Size: 1 oz (28 g)



Medium Flesh

SKU: 670042
Size: 1 oz (28 g)



Dark Flesh

SKU: 670059
Size: 1 oz (28 g)



Suntan

SKU: 670067
Size: 1 oz (28 g)



Dark Suntan

SKU: 670075
Size: 1 oz (28 g)



Youthful

SKU: 670083
Size: 1 oz (28 g)



Adult

SKU: 670091
Size: 1 oz (28 g)



Old Age

SKU: 670109
Size: 1 oz (28 g)



Male

SKU: 670117
Size: 1 oz (28 g)



Light Brown

SKU: 670133
Size: 1 oz (28 g)



Dark Brown

SKU: 670199
Size: 1 oz (28 g)



Peach

SKU: 670174
Size: 1 oz (28 g)



Natural

SKU: 670182
Size: 1 oz (28 g)



Brunette

SKU: 670137
Size: 1 oz (28 g)



Perma Thinner

SKU: 670711
Size: 110 ml (13 oz)



Perma Finishing Powders

Perma Powders are inter-mixable with Perma Pigments and are fast drying and non caking. They will not crack or peel. Mixing both the Perma Pigments and Powders result in an infinite colour range with superb masking qualities.



#17 White

SKU: 670505
Size: 4 oz (100g)



#18 Infant

SKU: 670513
Size: 4 oz (100g)



#19 Blonde

SKU: 670521
Size: 4 oz (100g)



#20 Brunette

SKU: 670539
Size: 4 oz (100g)



#21 Suntan

SKU: 670547
Size: 4 oz (100g)



#22 Peach

SKU: 670555
Size: 4 oz (100g)



Brown

SKU: 670557
Size: 4 oz (100g)



Dark Brown

SKU: 670568
Size: 4 oz (100g)



Cinnamon







SKU: 670569
Size: 4 oz (100g)

French Rose Tint and Complexion Spray are translucent liquid cosmetics made from almost exactly the same base of solvents. It is the dyes used in each shade of the two products that account for the subtle differences in the seven tones. These tints enhance tissue colouration from the arterial fluid and help the embalmer to product a faultless and life like finish to the facial tissues and hands of the deceased. Applied by brush or atomiser these tints produce a delicate, natural looking glow which is transparent and non-masking. Used routinely French Rose Tint and Complexion Spray will help to recreate the true tones of living skin on a wide range of complexion types.







Complexion Spray

- Easily applied by atomiser or brush.
- Complexion Sprays produces delicate, natural looking glow of transparent non-masking colour.
- Help recreate the true tones of living flesh on a wide range of complexion types.

	Light SKU: 690603 Size: 110 ml
	Medium SKU: 690637 Size: 110 ml
	Dark SKU: 690611 Size: 110 ml
	Suntan SKU: 690629 Size: 110 ml
 	

French Rose Tint

- Easily applied by atomiser or brush.
- French Rose Tint produces delicate, natural looking glow of transparent non-masking colour.
- Help recreate the true tones of living flesh on a wide range of complexion types.

	Light SKU: 690843 Size: 110 ml
	Medium SKU: 690875 Size: 110 ml
	Dark SKU: 690859 Size: 110 ml
 	

Please note: The three colour swatches look alike because all three shades of French Rose Tint look alike in the bottle. There is a slight difference in darkness between each shade when applied.

Cosmetics



Light Flesh
SKU: 690147
Size: 110 ml



Dark Flesh
SKU: 690157
Size: 110 ml



Suntan
SKU: 690163
Size: 110 ml



Brunette
SKU: 690173
Size: 110 ml



Softouch

Old fashioned liquid powders separate out of suspension almost between brush strokes, thus requiring constant recapping and agitation, but Softouch Liquid Powder stays in suspension longer.

- Accelerated drying time is another advantage.
- Far less costly than other liquid powders.
- Packaged in convenient plastic bottles for easy decanting.
- Formulated to simulate natural skin tone, creating a complexion colouring that seems to radiate from within the skin.
- Transparent quality of the liquid powder suspension prevents any masking effect from covering the natural marking and skin pigmentations.
- Creates a truly lifelike appearance.

Cream Lip Rogues

- Finely formulated lip colourings.
- Brush on smoothly, producing a very natural looking lip finish totally free of artificial "painted" appearance.
- Will not crack, chip or peel.
- Will not obliterate normal skin texture.



Light
SKU: 690404
Size: 0.5 oz (15 g)



Medium
SKU: 690412
Size: 0.5 oz (15 g)



Dark
SKU: 670420
Size: 0.5 oz (15 g)



Light
SKU: 690461
Size: 0.5 oz (15 g)



Medium
SKU: 690479
Size: 0.5 oz (15 g)



Dark
SKU: 690487
Size: 0.5 oz (15 g)





Lip Wax

- For treating small discolourations, fever blisters, parched, cracked or dehydrated lip surfaces.
- Also used in treating shallow wounds, or soft and moist tissue areas.
- Apply over the mucous membranes.
- Seals blemishes and desocccayed surfaces - imparting a base foundation for the application of lip cosmetics.
- Use a precaution against dehydration and lip separation.



Pink/Ivory

SKU: 685735
Size: 2 oz (56 g)



Youthful

SKU: 685743
Size: 2 oz (56 g)



Adult

SKU: 685750
Size: 2 oz (56 g)

Modelling Wax

- Modelling Wax expressly created for use in restoration of facial features.
- Pliable, elastic consistency - moulds easily to form and hold its shape.
- Remains firm after moulding.
- Forms a smooth, receptive cosmetic base.
- Will not crack or draw.



SKU: 685400
Size: 12 oz

Surface Restorer



- Formulated for maximum pliability and workability in treating surfaces, and re-contouring shallow wounds, superficial lesions, sores and shallow mutilations.
- Holds in soft and moist tissue.
- Adheres firmly and holds its form - yet remains flexible and workable.
- Cosmetically compatible and available in complexion co-ordinated shades.



Pink

SKU: 685057
Size: 2 oz (56 g)

SKU: 685220
Size: 12 oz (340 g)



Tan

SKU: 685016
Size: 2 oz (56 g)

SKU: 685214
Size: 12 oz (340 g)



Light Brown

SKU: 685131
Size: 2 oz (56 g)

SKU: 685132
Size: 12 oz (340 g)



Straw

SKU: 685081
Size: 2 oz (56 g)

SKU: 685082
Size: 12 oz (340 g)



Dark Pink

SKU: 685024
Size: 2 oz (56 g)



Red

SKU: 685115
Size: 2 oz (56 g)



Dark Brown

SKU: 685149
Size: 2 oz (56 g)

Wound Filler

- Formulated for maximum pliability and workability in treating surfaces, and re-contouring shallow wounds, superficial lesions, sores and shallow mutilations.
- Holds in soft and moist tissue.
- Adheres firmly and holds its form - yet remains flexible and workable.
- Cosmetically compatible available in complexion co-ordinated shades.

Pink

SKU: 685529
Size: 2 oz (56 g)



Dark Pink

SKU: 68511
Size: 2 oz (56 g)



Red

SKU: 685503
Size: 2 oz (56 g)



Cosmetics

Wood & Stainless Steel Spatulas

- This pair of fine professional instruments is machined to meet all technical requirements.
- Handles are high quality rosewood and blades are stainless steel.
- Smaller blades is 2.25" and the longer blade measures 3.5".

SKU: 703876
Size: 2.25" blade

SKU: 703884
Size: 3.5" blade



Stainless Steel Spatulas

- Available separately or as a set of two.
- One blade is tempered firm, the other is more flexible.
- Non-slip handles, 2" blades, 5" knurled grips.

Firm
SKU: 703926
Size: 2" blade

Flexible
SKU: 703918
Size: 2" blade

Firm & Flexible Pack
SKU: 703900
1 of each



Powder Blower



- A squeeze of the bulb sends a gentle spurt of powder out of the nozzle.
- Gives precise control of coverage.
- See-through container base removes for easy filling.
- Helpful time saver.
- Excellent when used with any of the Dodge cosmetic powders.
- Guaranteed for 6 months by the manufacturer.

SKU: 703751
Each

Liquid Atomiser



- High quality liquid atomiser is perfect for the application of Dodge French Rose Tints and Complexion Sprays.
- Chrome metal spraying parts, clear glass jar and plastic sprays.
- Removable nozzle for thorough and easy cleaning.

SKU: 701300
Each

Silicone Rubber Cosmetic Heads



Dodge is pleased to offer three faces for Cosmetic and Restoration Training. The faces are removable for easy cleaning.

One head is free of restoration challenges yet allow practising on cosmetic applications and shadowing. The other two have various injuries that will require some degree of wax restoration and cosmetics. The injuries are consistent with what you would expect from a motor vehicle accident ranging from missing section of ears, damaged facial features including noses and lips, and scalps with large incisions.

All types of cosmetics can be applied to the silicone faces as well as wax. When done, the faces are cleaned with soap and water

- The angled base is made of hard rubber and measures 6" wide x 6.5" deep and 10.5" high.
- Each face when placed on the base is approximately 7.5" wide x 9" deep and 11" high.

Male head with no injuries

SKU: 680108

Male Head with injuries

SKU: 680106

Damage to ears, chin, lips, nose, scalp, eyebrows and cheeks.

Female Head with injuries

SKU: 680107

Damage to ears, chin, lips, nose, scalp, eyebrows and cheeks.

Cosmetics

Silcolan

Silcolan is a clear emollient spray which can be applied to all viewable surfaces of the body before, during and after embalming. Silcolan will seem to soak in as it dries leaving a clear film. Silcolan is excellent when sprayed onto the facial features of the deceased prior to refrigerated storage before preparation.



- Unique blend superior to all similar spray emollients currently available. Contains silicone, lanolin derivatives, emollient esters and jojoba oil (as well as other ingredients).
- Creates a smoother texture and will prevent moisture loss, lubricates and maintains tissue pliancy.
- Compatible with all types of cosmetic application.
- Can be sprayed as a lubricant on arterial tubes, drainage tubes and trocars. Allows ease of entry and can prevent vessels from being ruptured. Applying Silcolan to the embalming table will assist with transferring the deceased from the tray or stretcher and prevent drainage from adhering.
- Environmentally preferred pump style, recyclable container.

Pump

SKU: 619001
Size: 150 ml



Aerosol

SKU: 619000
Size: 6 oz (170 g)



Undercoat

Undercoat is an opaque cosmetic meant to cover discoloured areas without creating a painted effect. Used over discolourations caused by injury, ecchymosis, intravenous punctures, burns as well as over waxed areas and areas of extensive restorative work.



Light

SKU: 691000
Size: 200 ml



Medium

SKU: 691002
Size: 200 ml



Dark

SKU: 691001
Size: 200 ml



- Even in cases where bleaching chemicals can't remove a stain, Undercoat will cover it.
- Undercoat will not crack or peel after drying when applied in thin layers, nor will it lift off when touched. It is intended that further cosmetics be applied over Undercoat after application.
- Equally valuable in covering stains of the hands as well as the face.
- No powder required to set Undercoat and there's no waste.
- The propellant in Undercoat contains no fluorocarbons.
- Undercoat will create no dehydration problems as some spray cosmetics can.

Easyway



- Easyway, a non wax product, is a system of components requiring mixing.
- Less likely to be dislodged by touching from a family member.
- Regular kit is 4 oz of powder, 4 oz of liquid, mixing cups, a spatula and directions.
- Toner kit contains four 1.5 oz bottles of pigment which can be mixed with Easyway components to achieve specific colours.
- Accepts regular cosmetics after curing.

Regular

SKU: 531400

Includes: 4 oz powder, 4 oz liquid, mixing cups, a spatula and directions.

Easyway Toner Kit

SKU: 531402

Includes: Four 1.5 oz bottles of Pigment.

Brushes - Spreading & Tinting

Brush measurements are stated in terms of the length across the bristles to the end of the ferrule. That is, the measurement is taken at the point where the bristles unite with the metal sleeve. Brushes shown are not to scale.

Spreading Brushes

1" Cream Spreader

A high quality white bristle brush designed for fast, easy application of standard cosmetic creams. Tapered bristles permit smooth uniform distribution.

SKU: 701938

Length: 9.25"



0.5" Liquid Spreader

Full - bodied, flexible bristles for applying liquid pigments and light creams to small areas.

SKU: 701987

Length: 8.25"



1" Tint Spreader

High grade, long bristled brush is specially designed for distributing liquid tints over large areas. May also be used with light creams and "tamping" powder into cosmetics.

SKU: 701821

Length: 7.25"



Tinting Brushes

0.25" Round Tinting

Fine pointed, springy brush designed for depositing and distributing liquid pigments over confined areas. Gives precision linear and edge control. Bristles closely resemble human hair and may be used in restorative replacement of eyebrows and eyelashes.

SKU: 701748

Length: 8"



0.75" Tinting

Broad, flat profile for brushing liquid cosmetic pigments or light bodied creams over extensive areas.

SKU: 701961

Length: 8.5"



0.75" Feature Tinting

Velvety soft bristles in a flat short haired brush, recommended for applying cosmetic tints to the mouth, eyes and cheeks. A premium quality brush.

SKU: 701896

Length: 8.625"



Cosmetics

Brushes - Stippling & Dusting

Initial cost is seldom the primary determining factor in practical, economical brush selection. A cheap brush used for critical cosmetic procedures may prove to be the most expensive one you own. Brushes shown are not to size.

0.5" Stippling

Flat brush recommended for brushing on tints and stippling coarser pores around the mouth.

SKU: 701805

Length: 7.5"



0.5" Coarse Stippling

Standard grade flat white bristle brush. Recommended for stippling areas characterised by coarse pores or deep lines.

SKU: 701862

Length: 6.625"



0.5" Fine Stippling

Superb stippling brush specially bristled to produce ultra-fine pore simulation on delicate facial tissue. Excellent for use on eyelids. A premium quality cosmetic instrument.

SKU: 701839

Length: 6.75"

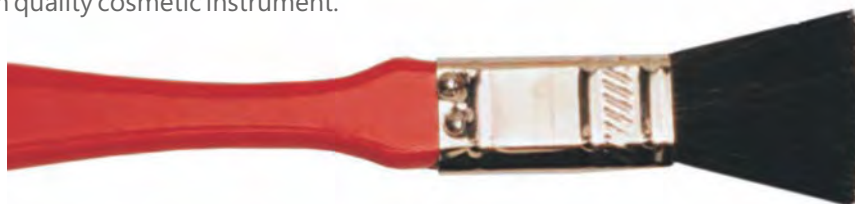

1" Fine Stippling

Fully bristled. Excellent for stippling large areas. Produce a realistic simulation of fine, delicate pores on cosmeticised surfaces.

SKU: 701854

Length: 7.25"



0.75" Powder Dusting

Short handled, full bristled in a medium sized dusting brush. Perfect for applying finishing talcums over waxed areas and for general powder dusting uses.

SKU: 701797

Length: 5.5"



1" Utility Dusting

Long handled bristled brush with flat oval profile. Serves as a fine general purpose duster. May be used in all application except on waxed surfa

SKU: 701995

Length: 9.75"



1/16" Fine Lining

Very responsive fine pointed brush. Gives perfect control in the most delicate cosmetic applications. Springy, full bristled with ample colour carrying capacity.

SKU: 701888

Length: 7



1/2" Hairline Blending

Imported black bristle brush. Full bodied square cut and firm for blending in cosmetic creams of heavier consistency into the hair-line and around the eyes and temples. Has half inch circular contact areas.

SKU: 701722

Length: 6"



3/16" Lip & Eye Lining

Short handled brush gives precise marginal control for applying lip rouge or eye shadow. Plastic sleeve protects brush when not in use.

SKU: 701946

Length: 4 1/2"



1/8" Lip Lining

Chise-point. Long handled. Deposits sharp edged line of colour. Gives pin point control for lip lining, shading and highlighting. Excellent for blending in narrow delineations too.

SKU: 701870

Length: 7"



1/4" Lip Lining

Standard width chisel-point lip liner with fine bristles.

SKU: 701813

Length: 7 1/2"



1/2" Highlighting

Soft bristle for smooth, fully controlled highlighting. May be used to apply liquid tints and light cosmetic creams.

SKU: 701771

Length: 6 3/4"



1/4" Fine Detailing

Long bristled for applying cosmetic tints in hard to reach, confined areas.

SKU: 701730

Length: 6 1/2"



1/8" Ultra Fine Detailing

For especially delicate work, such as treating incisions with adhesive, fine modelling etc.

SKU: 701714

Length: 6 1/4"





Complete Cosmetician Kit

By far our best selling kit, the Complete Cosmetician Kit is different from any other kit Dodge has to offer. It contains a combination of cosmetics for almost all the different lines that are produced. Three of Dodge's expert cosmetic demonstrators selected each component of the kit based on their own preferences and each shades popularity as indicated by sales volume.

- **Performance Highlights:**
- You'll find just about everything you need to handle any case in this kit.
- Available in two different versions. Cosmetic shades to suit light and darker complexions.
- Both kits contain: three 2 oz Kalon Creams, six 1 oz Kalon Pigments, eight 1/2 oz Kalochromes, five 1 oz Aquachromes, three 1 oz Perma Liquids, two 2 oz waxes, a 1/2 oz nail varnish, two 1/2 oz soft rouges, six brushes, a forceps, a spatula and a pair of scissors.

Ligher Complexion

SKU: 690010

Size: 17" x 14 1/2" x 3 1/2"

Darker Complexion

SKU: 690012

Size: 17" x 14 1/2" x 3 1/2"



Junior Kalochrome Kit

This compact professional kit gives the embalmer a practical working assortment of essentials contained in a neatly organised, durable carrying case. A handsome, economical cosmetic unit, adequate for most standard cosmetic applications.

Performance Highlights:

- Available in two different versions. Cosmetic shades to suit lighter and darker complexions.
- Both kits contain: 14 shades of 1/2 oz Kalochrome Cream, two 2 oz waxes, two 2 oz Kalochrome Powders, a 2 oz White Kalon Cream, two 1/2 oz rouges, three brushes and a spatula.

Ligher Complexion

SKU: 650804

Size: 17" x 14 1/2" x 3 1/2"

Darker Complexion

SKU: 650820

Size: 17" x 14 1/2" x 3 1/2"

Airbrush Kit

From the embalming supplier you can rely on, at last there is a reliable and trouble free airbrush system available. This system allows for the delicate application of cosmetics and is especially useful when applying cosmetics to cases that have undergone reconstruction using waxes or other materials.

Performance Highlights:

- Includes an air compressor - 6" x 5.75".
- Airbrush applicator.
- Instructional DVD.
- Twelve 0.5 oz bottles of water based cosmetic spray.
- Airbrush sprayer cleaning solution.



Dodge Deluxe Airbrush Kit

SKU: 680102

Airbrush Cleaner

SKU: 680126

Size: 4 oz bottle

Airbrush Nozzle Stand

SKU: 680103



Dodge Stock	Dodge Cosmetic Name	Deluxe Kit	Complete Colour Selection
680110	Light Basic		
680112	Ivory		
680113	Adult		
680114	Light Complexion		
680115	Dark Brown		
680116	Brunette		
680117	Dark Suntan		
680118	Light Brown		
680119	Light Suntan		
680120	Suntan		
680121	Peach		
680122	Dark Basic		
680123	Tan		
680124	Tangerine		

Perma Safe Cosmeite Bib

Use to protect the clothing of deceased, when cosmetics need to be applied after dressing or coffining procedures have already been completed. An excellent item to have to prevent accidental staining of clothing when performing cosmetic applications.

SKU: 755074

Pack of 1



Instruments

Separators, Dissectors & Directors



Double Ended Separator

- Stainless Steel.
- Available in two versions.
- Used for all standard dissection procedures.

Flexible

SKU: 705700

Rigid

SKU: 705701



MacDonald's Separator

- Stainless Steel.
- Ideal for use in all derma surgery applications.
- Well suited for raising delicate arteries and veins.

SKU: 705705



White Nylon Separator

- 6" nylon separator.
- Ideal for cutting against when incising arteries and veins.

SKU: 705715



Curved Separator

- Stainless steel.
- Curved dissector tip for delicate work.
- 6" curved separator.

SKU: 705707



Freer's Elevator

- Stainless steel.
- Has many embalming room uses.
- Non-slip convex and concave, Freer's elevator tips on a sure grip handle.

SKU: 702258



Grooved Vein Director

- Stainless steel director/grooved fascia needle.

SKU: 702209



Probe Point Vein Director

- Stainless steel probe point director/grooved.

SKU: 702217

Aneurysm Needles, Hooks & Elevators



Aneurysm Hook

- Blunt point.
- Available with or without eye of ligating operations.
- Quality stainless steel instrument.

No Eye

SKU: 703338

With Eye

SKU: 703339



Aneurysm Hook/Cradle

- Specially designed handle cradles vein or artery during incision and intubation.
- Has separator/ director tip.
- Quality stainless steel instrument.

SKU: 703389



Aneurysm Hook Smooth Grip

- Small right-angled hook, concave handle.
- Tip formed for modelling, separating and dissecting.
- Quality stainless steel instrument.

SKU: 703397



Aneurysm Hook Probe Handle

- Large curved hook. Heavy corrugated handle.
- Multi purpose tips at both ends.
- Quality stainless steel instrument.

SKU: 703355



Aneurysm Needle

- Extra heavy handle, small tip with eye.
- Broad flat separator.
- Chrome plated.

SKU: 703348



Expander/Aneurysm Needle

- Expander and aneurism needle.
- Quality stainless steel.

SKU: 702274

Please note that instruments are not shown at actual size.

Instruments

Forceps



6 1/2" Forcep Dissector

- One of the most versatile forceps ever designed for embalming use.
- Idea for delicate eye and restorative work.
- Has multi-purpose dissector handle.

SKU: 702597



8" Curved Tip Forceps

- Companion instrument to the 6 1/2" forceps.
- Made for more rugged usage in autopsy operations, mouth and nostril cleaning, inserting eye caps and mouth formers.

SKU: 702654



Blunt Dissecting Forceps

- Stainless spring steel construction.
- Available in 4 different lengths.

5"

SKU: 702720

8"

SKU: 702696

10"

SKU: 702688

12"

SKU: 702670



Tilley's Nasal Forceps

A quality stainless steel instrument which is very useful for delicate packing procedures around the nose, mouth and even ears.

SKU: 702940



Packing Forceps

Ideal for all heavy duty packing applications during or after embalming or preparation of the deceased.

SKU: 702886

Instruments

Forceps & Clamps



6" McIndoe Plain Forceps

- Stainless steel construction.
- Ideal for delicate dissection and reconstruction work.
- Fine point is perfect for locating delicate facial arteries when embalming autopsy cases.

SKU: 702781



4 1/2" Fine Point Curved Arterial Forceps

- Stainless steel construction.
- 4 1/2" overall length.

SKU: 702753



Dissecting Forceps

- Stainless steel construction.
- Ideal for delicate dissection and reconstruction work.
- Fine point is perfect for locating delicate facial arteries when embalming autopsy cases.

6" Fine Point

SKU: 702700

6" Blunt Point

SKU: 702702

7" Medium Point

SKU: 702698

8" Fine Point

SKU: 702697



4" Curved Dieffenbach Clamps

- Ideal for clamping arteries without causing damage to the vessel.
- Particularly useful when clamping the arteries of the cranial vault when embalming autopsied cases.

SKU: 702617



5 1/2" Fine Point Curved Arterial Forceps

- Stainless steel construction.
- 5 1/2" overall length.

SKU: 702779



4" Straight Dieffenbach Clamps

- Ideal for clamping arteries without causing damage to the vessel.
- Particularly useful when clamping the arteries of the cranial vault when embalming autopsied cases.

SKU: 702614

Instruments

Fixation Forceps

Designed to hold metal arterial tubes in place, while under pressure, these forceps simplify injection procedures during the embalming of both straight and autopsy cases. Available in differing sizes, some of these forceps feature angled heads which aid in clamping arteries in difficult to reach areas.



Three Hole Fixation Forceps

- Stainless Steel.

SKU: 702894

Size: 2.35 mm, 4.75 mm & 3.15 mm Ø



Two Hole Fixation Forceps - (Carotid/Large size)

- Stainless Steel.

SKU: 702564

Size: 6.0 mm & 4.5 mm Ø



Two Hole Fixation Forceps - (Medium/Small size)

- Stainless Steel.

SKU: 702565

Size: 4.0 mm & 3.0 mm Ø



Two Hole Fixation Forceps - (Baby/Maxillary size)

- Stainless Steel.

SKU: 702566

Size: 2.0 mm & 1.5 mm Ø



Two Hole Fixation Forceps - (Large/Small size)

- Stainless Steel.

SKU: 702555

Size: 1/4" & 1/8" Ø

Safety Note: When using these forceps to hold tubes in place while embalming a straight case, a ligature should also be used to act as an additional safety measure and also allow for the vessel to be tied off after injection to prevent leakage.

Metal Arterial Tubes

Manufactured in the United Kingdom to the highest standards, these slip hub arterial tubes follow a traditional design and are produced from quality chrome plated brass. They are free of any knurls or occlusions which make them easy to clean and maintain and ensure constant flow while in use. They attach directly to the tubing from the injection equipment by simply pushing the hub of the arterial tube into the hose.

Curved Tubes Taper Mount

Curved Carotid Arterial Tube

SKU: 707450

Large Curved Arterial Tube

SKU: 707460

Medium Curved Arterial Tube

SKU: 707470

Small Curved Arterial Tube

SKU: 707480

Set of 4 Curved Arterial Tubes

SKU: 707713

Set of 9 Arterial Tubes (excludes baby straight double length)

SKU: 707715



Straight Tubes Taper Mount

Large Straight Arterial Tube

SKU: 707610

Medium Straight Arterial Tube

SKU: 707615

Small Straight Arterial Tube

SKU: 707625

Baby Straight Arterial Tube

SKU: 707700

Baby Straight Double Length Arterial Tube

SKU: 707701

Maxillary Straight Arterial Tube

SKU: 707710

Set of 5 Straight Arterial Tubes (excludes baby straight double length)

SKU: 707714



As well as individual arterial tubes, we are able to provide complete sets of tubes for your convenience.

Instruments

Metal Taper Fit Arterial Tubes

These high quality arterial tubes represent a new concept in tube design. They allow for a quick connect/disconnect system without loss of bore or flow. The selected arterial tube is attached to the female connector by simultaneously inserting and twisting. The female connector is permanently attached to the injection source. For other metal injection tubes, plastic injection tubes or hypodermic trocar kits that do not have taper fittings the male taper adaptor can be used in conjunction with Vinyl 14H injection tubing (SKU: 761980) and a plastic connector (SKU: 709317). When the female connector is not in use, a plug is available to protect against dirt entering the socket, it also provides protection against leakage of fluid should the stop tap fail or the female socket be left on a countertop or instrument trolley. As with all the Dodge arterial tubes, they may be purchased individually or in sets as detailed below.



Taper Fit Curved Arterial Tubes

Curved Carotid Arterial Tube
SKU: 707725

Large Curved Arterial Tube
SKU: 707726

Medium Curved Arterial Tube
SKU: 707727

Small Curved Arterial Tube
SKU: 707728

Set of 4 Curved Arterial Tubes
SKU: 707738

Female Taper Socket
SKU: 707735



Male Taper Adaptor
SKU: 707736



Male Taper Plug
SKU: 707737



Taper Fit Straight Arterial Tubes

Large Straight Arterial Tube
SKU: 707729



Medium Straight Arterial Tube
SKU: 707730



Small Straight Arterial Tube
SKU: 707731



Baby Straight Arterial Tube
SKU: 707732



Baby Straight Double Length Arterial Tube
SKU: 707741



Maxillary Straight Arterial Tube
SKU: 707733

Set of 5 Straight Arterial Tubes (excludes baby straight double length)
SKU: 707739

Complete Set of 9 Arterial Tubes (excludes baby straight double length)
SKU: 707734

Instruments

Locking Forceps



Straight Spencer Wells Forceps

Straight Blunt Point Forceps

5" SKU: 702830 6" SKU: 702831 7" SKU: 702832

Straight Halstead/Mosquito Forceps



5" Mosquito Straight Forceps
SKU: 702879



Kelly's 5 1/2" Fine Artery Straight Forceps
SKU: 702860

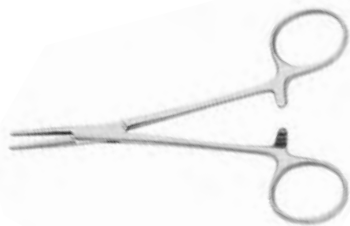

Halsteads 7" Fine Pointed Straight Forceps
SKU: 702853



Curved Spencer Wells Forceps

Fine Curved Forceps

5" SKU: 702847 7" SKU: 702846 8" SKU: 702850

Curved Halstead/Mosquito Forceps



5" Mosquito Curved Forceps
SKU: 702878



Kelly's 5 1/2" Fine Artery Curved Forceps
SKU: 702861



Halsteads 7" Fine Pointed Curved Forceps
SKU: 702856

Instruments

Metal Threaded Hub Arterial Tubes

Designed to work exclusively with the Dodge range of embalming machines. These high quality metal arterial tubes come with threaded hubs so that they can be screwed directly into the stop tap of the injection line. For ease of use, we are able to provide male and female luer lock adaptors which allow arterial tubes to be removed and changed by the operator in seconds. With the luer lock adaptors, the male adaptor is screwed into the stop tap of the injection line, where it remains. A female adaptor is then screwed onto the threaded end of every arterial tube to facilitate quick and easy connection and disconnection. As with all Dodge arterial tubes, they may be purchased individually or in sets as detailed below.



Threaded Hub Curved Arterial Tubes

Curved Carotid Arterial Tube
SKU: 707750

Large Curved Arterial Tube
SKU: 707751

Medium Curved Arterial Tube
SKU: 707752

Small Curved Arterial Tube
SKU: 707753

Set of 4 Curved Arterial Tubes
SKU: 707759

Threaded Hub Straight Arterial Tubes



Large Straight Arterial Tube
SKU: 707754



Medium Straight Arterial Tube
SKU: 707755



Small Straight Arterial Tube
SKU: 707756



Baby Straight Arterial Tube
SKU: 707757



Maxillary Straight Arterial Tube
SKU: 707758

Set of 5 Straight Arterial Tubes
SKU: 707760

Complete Set of 9 Arterial Tubes
SKU: 707761

Female Luer Lock Adaptor
SKU: 701061



Male Luer Lock Adaptor
SKU: 707048



Artery Tube UK Washer
SKU: 709353





Angular Vein & Dissector Forceps

- Stainless steel construction.
- Available in 3 sizes.
- 5" & 2 1/2" working length is good for infant drainage.

4.75"

SKU: 702591

6"

SKU: 702589

11"

SKU: 702571



Drainage Forceps

- Practical drainage simulator, particularly useful in the removal of heavy, clotted blood.
- Expands the vein to maximum diameter, yet takes up little space within the vessel itself.
- Stainless steel.
- Working length of 7".

7" working length

SKU: 702837

Drainage Tubes

Designed to facilitate the removal of blood from the venous system while arterial injection takes place, these high quality drainage tubes help to remove superior amounts of drainage from the deceased. With high quality slip hubs, these drain tubes can be connected to flexible plastic tubing so that drainage can be diverted to a covered receptacle or table drain for disinfection and disposal. This system of closed drainage helps to reduce exposure of the operator to potential sources of infection and maintain the highest standards of cleanliness in the embalming room. (OD - Outside Diameter).



Multi-Slot Drain Tubes

- Working length approximately 7".
- The multiple slots aid in achieving a superior volume of drainage.
- Highly recommended.

Small - 1/4" OD

SKU: 707543

Medium - 5/16" OD

SKU: 707542

Large - 3/8" OD

SKU: 707541

XL - 7/16" OD

SKU: 707540



Infant Tube

- Working length approximately 5".

Small - 1/8" OD

SKU: 707208



Curved Standard Drain Tube

- Working length approximately 8 1/2".

Small - 3/16" OD

SKU: 708636

Large - 1/4" OD

SKU: 708628

Instruments

Injection/Drainage Tubes

A low cost set of injection and drainage tubes, designed to be used when a flexible plastic injection tube is preferred to metal ones. These tubes are not designed to withstand high pressures. In use they should be ligated into the artery being injected. It is not recommended that these tubes be held in place with metal fixation forceps.

Set of Plastic Injection and Drainage Tubes

SKU: 708950

Includes the following below:



D & I tube 8 (blue mount)	SKU: 708971
D & I tube 24 (blue mount)	SKU: 708955
D & I tube 16 (orange mount) long	SKU: 708957
D & I tube 10 (black) 38 cm	SKU: 708960
D & I tube 16 (orange mount) short	SKU: 708967
D & I tube 12 (white mount)	SKU: 708968
D & I tube 10 (black) 23 cm	SKU: 708970
D & I tube spigot - plastic	SKU: 708951
On/off tube clamps - econ type	SKU: 704868
Connector (D & I set)	SKU: 709314
'Y' connector for D & I tube set	SKU: 709316

Tubing-vinyl 14 H drainage
SKU: 761980
Size: 1 metre

Tubing-vinyl 12 H
SKU: 761970
Size: 1 metre

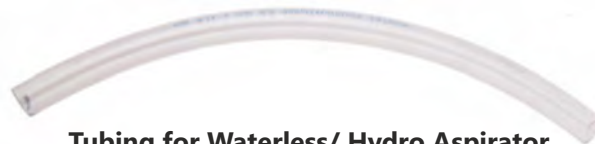

Tubing for Waterless/ Hydro Aspirator

SKU: 761992

Size: 12.5 mm ID x 18.5 mm OD



Tubing-Vinyl 14 H Drainage

SKU: 761980

Size: 7 mm ID x 10.5 mm OD

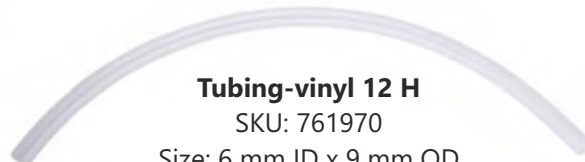

Tubing-vinyl 12 H

SKU: 761970

Size: 6 mm ID x 9 mm OD

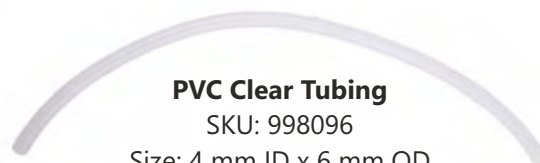

PVC Clear Tubing

SKU: 998096

Size: 4 mm ID x 6 mm OD

OD - Outside Diameter
ID - Inner Diameter

Retractors & Needle Holders

Adjustable Retractor

- Idea for holding incisions open when working in restricted areas.
- Helps to prevent incisions becoming over stretched while dissection is performed.

Regular

SKU: 703978

Large

SKU: 703979



Spring Retractor

- Easy to clean and maintain after use.
- Ideal for use in femoral or abdominal incisions.

SKU: 703967

Mayo Hegar Needle Holder Forceps

- Available in two sizes, 6" and 8".
- Locking mechanism provides positive grip of all suture needles in difficult conditions.
- Ideal for delicate suturing operations.

6"

SKU: 702936

8"

SKU: 702859



Mathieu Spring Needle Holder Forceps

- Available in two sizes, 5½" and 8".
- Locking mechanism provides positive grip of all suture needles in difficult conditions.
- Ideal for delicate suturing operations.
- Fits in the palm of the hand for sensitive control during suturing operations.

5 ½"

SKU: 702938

8"

SKU: 702939

Gillies Needle Holder/Scissor Forceps

- Quality stainless steel construction.
- In built scissor saves time and reduces instrument use by providing cutting for ligature during suturing operations.
- Designed to be comfortably held by thumb and middle finger.

SKU: 702941



Instruments



Gathering Forceps

- Ideal for holding the edges of long incisions together while suturing.
- Ensures both incision edges match before suturing is carried out.

With Balls

SKU: 702901

Without Balls

SKU: 702902



Post Mortem Incision Clip

- Ideal for holding the skin flaps together when suturing the incisions of post mortem cases.
- Ensures both incision edges match before suturing is carried out.

SKU: 702905



Lister Bandage Scissors

- Available in two different sizes.
- Ideal for removing bandages or cutting clothing during dressing procedures.
- Stainless steel for durability.

5 ½"

SKU: 704576

7 ½"

SKU: 704577



Heavy Duty Embalming Room Scissors

- Ideal for cutting thick or heavy clothing during dressing procedures.
- Will cut wadding and cotton wool with ease.
- Stainless steel for durability.

9"

SKU: 704817



Artery & Wire Cutting Scissors

4 ½" Universal
SKU: 704528



Standard Blunt/Blunt Point

6"
SKU: 704774



Sharp/Blunt Point Scissors

5" Standard
SKU: 704653

5" Premium
SKU: 704652

6" Standard
SKU: 704671

6" Premium
SKU: 704670



Sharp/Sharp Point Scissors

5" Standard
SKU: 704711

5" Premium
SKU: 704710

6" Standard
SKU: 704721

6" Premium
SKU: 704720



Curved Blade Sharp/Sharp Point Scissors

6"
SKU: 704619

Instruments

Disposable Scalpels

Designed for single usage, these scalpels assist in maintaining hygiene levels as they can be incinerated after use. A must have for infectious cases.

Scalpels 22

SKU: 701497

Pack of 10

Scalpels 10

SKU: 701498

Pack of 10



Disposable Scalpels Blades

Blade No. 26

SKU: 701496



Blade No. 24

SKU: 701484



Blade No. 23

SKU: 701476



Blade No. 22A

SKU: 701471



Blade No. 22

SKU: 701468



Blade No. 21

SKU: 701460



Blade No. 20

SKU: 701443



Blade No. 15

SKU: 701435



Blade No. 12

SKU: 701427



Blade No. 11

SKU: 701418



Blade No. 10A

SKU: 701416



Blade No. 10

SKU: 701411



Size: Pack of 100
(blades individually wrapped)

Blades No. 10 - No. 15 will fit handle No. 3

Blades No. 20 - No. 26 will fit handle No. 4

Swann Morton Handles

Swann Morton No. 3 Stainless Scalpel Handle

SKU: 703156



Swann Morton No. 4 Stainless Scalpel Handle

SKU: 703174



Post Mortem Blades/Handles

For use with the popular PM40 or PM40B blades, the blue handle is the standard handle for post mortem or dissection use while the silver, deluxe handle is designed to withstand intensive use and autoclaving. For infectious cases, or improved safety in the post mortem room, there is a disposable option, where by the whole unit, blade and handle can be incinerated after use.

Standard PM40 Handle

SKU: 720060



Deluxe PM40 Handle

SKU: 720062



Bull End Blade

SKU: 720071

Pack of 10



Sharp End Blade

SKU: 720070

Pack of 10



Disposable PM40 Sharp Nose

SKU: 720075

Each

Disposable PM40 Bull Nose

SKU: 720076

Pack of 50



Half Curved Needles

3"
SKU: 704276
Pack of 12

4"
SKU: 704273
Pack of 12

5.5"
SKU: 704271
Pack of 12

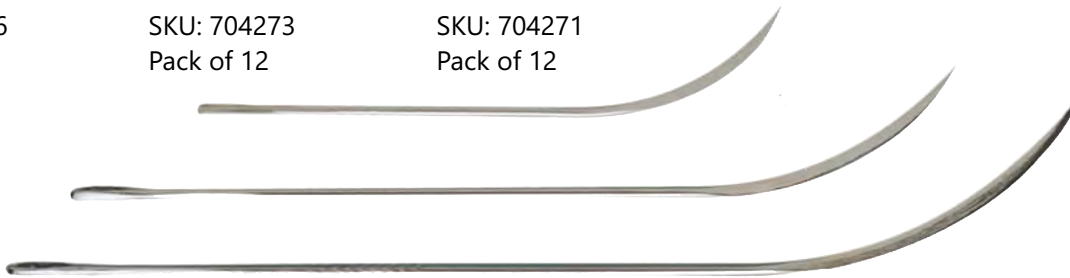

Double Curved Serpentine Needles

3.25"
SKU: 704295
Pack of 12

4.25"
SKU: 704293
Pack of 12

5.25"
SKU: 704291
Pack of 12



Crescent Suture Needles

1.5"
SKU: 704259
Pack of 12

2"
SKU: 704255
Pack of 12

2.5"
SKU: 704250
Pack of 12

4"
SKU: 704241
Pack of 12



Half Curved Suture Needles

1.5"
SKU: 704137
Pack of 12

2"
SKU: 704135
Pack of 12

2.5"
SKU: 704132
Pack of 12

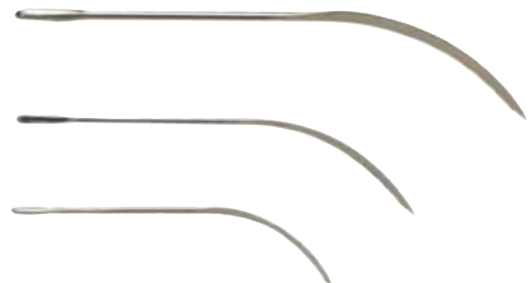

Half Circle Needles

3"
SKU: 704230
Pack of 12

4"
SKU: 704235
Pack of 12



Instruments

Hypodermic Needles

The Dodge Company is please to offer a full range of hypodermic needles which can be used for a variety of different tasks in the embalming room. All of the needles will function with luer lock syringes for added safety when injecting strong preservative, cauterant or tissue building chemicals. Images not shown to scale.



Hypodermic Needle Luer Lock 1.5" Fine

Unit Size: 22 gauge x 38 mm
SKU: 704316



Hypodermic Needle Luer Lock 2.5" Medium Fine

Unit Size: 20 gauge x 63.5 mm
SKU: 704318



Hypodermic Needle Luer Lock 2.25"

Unit Size: 18 gauge x 86 mm
SKU: 705145



Hypodermic Needle Luer Lock 6" Coarse

Unit Size: 15 gauge x 150 mm
SKU: 704322



Hypodermic Needle Luer Lock 4" Coarse

Unit Size: 14 gauge x 100 mm
SKU: 705140



Hypodermic Needle Luer Lock 10" Coarse

Unit Size: 13 gauge x 254 mm
SKU: 704336



Hypodermic Needle Luer Lock 8" Coarse

Unit Size: 13 gauge x 200 mm
SKU: 704335

Hypodermic Syringes



Hypodermic Nylon Syringe 20 ml Luer Lock

SKU: 705110



Hypodermic Plastic Syringe 20 ml

SKU: 705007
Size: Pack of 10



Hypodermic Glass Syringe 10 ml Luer Lock

SKU: 705011

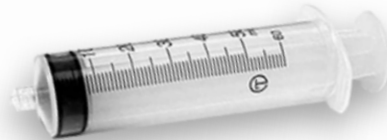

Hypodermic Plastic Syringe 50 ml

SKU: 705008



Hypodermic Glass Syringe 20 ml

SKU: 705019



Disposable Needles for use with Syringes

SKU: 705006
Size: Pack of 100



Hypodermic Trocar Set

This quality hypodermic trocar set will allow the operator to treat areas of the body not receiving sufficient fluid during arterial injection due to poor circulation, circulatory disruption or trauma. With its luer lock fittings, the operator can use either the supplied trocar or any luer lock hypodermic needle. The luer lock fitting offers increased protection from chemical sprays as the trocar or hypodermic needle is securely fitted to the valve and unable to detach itself under higher pressures.

Performance Highlights:

- Allows for simple and fast treatment of areas of the body not receiving sufficient arterial fluid.
- Particularly useful for treating flaps of autopsy cases.
- Luer lock fittings secure trocars and hypodermic needles in place and protect against chemical splashes.
- Valve handle accepts hypo trocars or luer lock hypodermic needles.

SKU: 706318



Hypodermic Trocar Stop Tap Connector

This connector allows the Hypodermic Trocar to attach directly to the stop-tap of any Dodge Embalming Machine for added safety when injecting fluids under pressure.

SKU: 701046



Dodge Chuck Action Trocar Handle

Designed to provide increased grip on the trocar shaft for the embalmer when performing aspiration procedures. The implement will increase the embalmers control and help to prevent slipping.

SKU: 706098



Dodge Trocar Cleaning Set

Comprising one nylon brush, one bronze brush and a collapsible handle, this unit will help you to ensure your trocar remains clean and disinfected between each case.

Trocar Cleaning Set

SKU: 706099

Includes: Cleaning rod & two brushes.

Cleaning Rod Handle Only

SKU: 706104

Spare Nylon Brush

SKU: 706100

Spare Bronze Brush

SKU: 706110



Instruments

Evolution Trocar

Developed in collaboration with Instrument Design & MFG. and the research team at Dodge. The Evolution Injector™ combines our Chemical Cavity Injector and Comfort Grip Trocar™ into one new product. Designed to bring the process of cavity injection down to one hand for advanced manoeuvrability.

Performance Highlights:

- Sleek, lightweight Delrin and durable stainless steel design.
- Quick release bottle attachment for easy bottle insertion and removal.
- Comes with one 7" adapter.
- Additional adapter available separately.

Evolution Injector™ (7" adapter included)

SKU: 703420

5" Adapter

SKU: 703425

7" Adapter

SKU: 703427

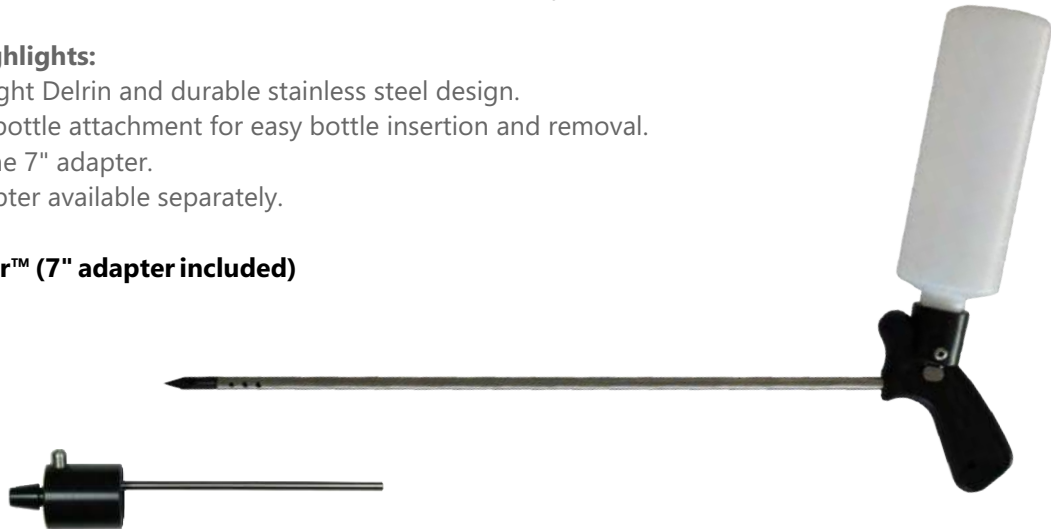

Comfort Grip Trocar

The Dodge Comfort Grip Trocar has a uniquely machined handle for easier use and improved grip. Offering an alternative to traditional trocars this features the first truly ergonomic grip on the market. The light weight plastic handle sits comfortably in the palm of the hand and allows the operator to firmly grip the trocar with the whole hand, not just the finger tips. Diameter is 5/16".

18"

SKU: 035002



Trocar & Stilettes

Dodge Trocars are supplied with cap and points and are made to the highest standard. There are 5 sizes available as well as an infant trocar which is also supplied with a cap and point. Stilettes are available for 18", 16" and 14" trocars.

22" Trocar with Cap & Point

SKU: 706095

Baby Trocar with Cap & Point SKU: 706015

18" Trocar with Cap & Point

SKU: 706092

18" Stilette SKU: 706093

16" Trocar with Cap & Point

SKU: 706082

16" Stilette SKU: 706083

14" Trocar with Cap & Point

SKU: 706072

14" Stilette SKU: 706073

12" Trocar with Cap & Point

SKU: 706018

Trocar Points

Choose from a stainless steel point or blunt attachment to help with all aspiration procedures in the embalming room.

Stainless Steel Trocar Point

SKU: 706096



5/16" Blunt Trocar Attachment

SKU: 706094



Post Mortem Aspirator UK Model

This chrome-plated unit has been completely redesigned with a removable chamfered filter head and hexagonal multi diameter tubing mount.

SKU: 701174



Non-Clogging Post Mortem Aspirator

Drains cavities completely. The head can be removed for thorough cleaning. Works with tubing for Waterless/Hydro Aspirator.

SKU: 701151



Throat/Nasal Aspirator UK Model

A high quality chrome-plated unit with a multi diameter tubing mount and a removable tip for ease of cleaning.

SKU: 708810

Spare Tip

SKU: 708811



Nasal Tube

Essential for purging cases. Evacuates liquid from nasal cavities and the throat. Works with tubing for Waterless/Hydro Aspirator, SKU 761992.

SKU: 708800

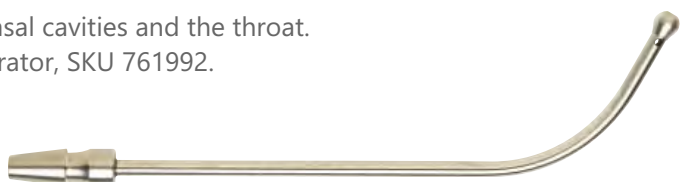

Dodge 'Y' Tube

A quality chrome plated brass injection tube. This device permits the injection of two arteries simultaneously.

SKU: 709312



Instruments



Dodge Bulb Syringe

A quality all rubber bulb syringe, which can be used for the injection of fluids into the arteries or cavities of the deceased or to decant fluid from larger containers to smaller ones. The disconnecting valve housings are metal, whilst the valves are neoprene.

This is normally used with a filter based sinker, which can be purchased separately.

Dodge Bulb Syringe

SKU: 705404

Complete with metal valves

Filter Based Sinker

SKU: 705410

Spare Metal Valve

SKU: 705403

2 per syringe



Metal Cavity Injector

Designed to provide trouble free and simple injection of cavity chemicals into the cavities of the deceased after aspiration procedures. This device will fit either 16 oz or 1 litre Dodge chemical bottles.

Metal Cavity Injector

SKU: 703577

Complete with bottle and tubing

Metal Cavity Injector

SKU: 703578

Without bottle and tubing

Spare 1 Litre Bottle and Cap

SKU: 992080

Spare Cavity Injector Washer

SKU: 703583

Spare Vinyl Tubing 14 H

SKU: 761980

Size: 1 metre

Metal Stop Tap Connector

Used to control the flow of fluid from the injection equipment, this connector features ball operation to ensure no leakage from the connector when the tap is closed.

SKU: 704860





Dodge Trocar Buttons

SKU: 740019
Pack of 144



Multi-Trocar Buttons

Multi-Closure buttons to close openings caused by I.V. lines, hypodermic incisions, trocars, tracheotomies, and feeding tubes. Compatible with 2-prong trocar button applicator.

SKU: 750550
Pack of 50

Trocar Button Applicator

Handle is made from stainless steel.

Because of handle design it will not roll down embalming tables or off counter tops.
Double pronged end is compatible with most styles of trocar buttons available.

SKU: 701129



A-V Closure

- Used to seal the anus and/or vagina.
- The A-V Closure makes sealing orifices easier.
- Insures against both odours and liquid leakage.
 - Won't tear tissues.
- Won't wick moisture out of the body like cotton will.
 - Can be used with Q-S Powder or Sanisorb.

SKU: 750122
Each



Needle Injector

- Easier to squeeze than the earlier, chrome model.
- More durable.
- Larger, more comfortable finger rings.

SKU: 703489

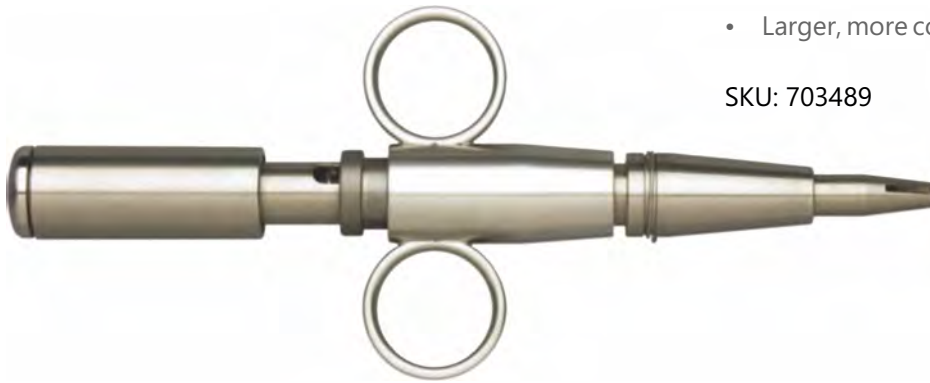

Needle Injector Handle

Makes life easier for people with small hands to operate the needle injector.

SKU: 703496



Injector Needles

- Provides secure closure of the mouth.
- Regular wire.

SKU: 820019

Pack of 144



Magnetic Needle Rack

This attractive magnetic needle rack protects the operator from being stabbed in the fingers while hunting through draws or cupboards for suture needles. It is much more hygienic than sticking needles into polystyrene or sponge blocks, which can prematurely dull the needle tip. This unit is easily cleaned and can be mounted on the counter top or screwed onto the wall after removing the rubber feet. The unit comes with pre drilled holes, however three screws will be required.

Magnetic Needle Holder

SKU: 704000

Complete with cover

Needle Holder Cover

SKU: 704001



The Dodge Tissue Reducer

The Dodge Tissue Reducer dries moist tissue, smoothes out wrinkles, recreates obliterated facial characteristics and reduces swelling from oedematous conditions or over-injection of arterial fluid by the external application of heat. It delivers just the right amount of heat for treating human tissue and maintains a constant ideal temperature even after continual use over cold tissue. The tips have been designed so that the desired effects can be achieved quickly and with a limited number of passes. A note of caution however, excess contact with a reducing iron will tend to leatherise the treated area.

Performance Highlights:

- Reduces swelling caused by injuries or over injection of arterial chemicals.
- Recreates facial lines.
- Fitted with insulated handle and supplied with one large and one small interchangeable tips.

Dodge Tissue Reducer (240v UK & European)

SKU: 705605

Complete with tips

Large Tip

SKU: 705606

Small Tip

SKU: 705607



Rubber Water Collar

- An essential embalming room aid, given the greater number of swollen cases encountered.
- Made of heavy duty rubber to withstand repeated use.
- May be filled with water or sand.
- Use following arterial injection for approximately 25 minutes depending upon severity of swelling.
- Wrinkles, if any, should be removed with a tissue reducer.
- After treatment any excess tissue can be gathered to the back of the neck using the Jack Adams 'Neck Lock' stitch.

SKU: 702084



Instruments

Embalmer's Kit

A comprehensive collection of instruments.

- Perfect for an embalmer starting work at a new funeral home, or for a funeral home looking to replace older instruments.
- An ideal present for a student embalmer who has completed their training.

SKU: 700100

Includes:

- 1 Disposable Scalpel
- 1 Hardwood Separator
- 1 Aneurism Hook
- 1 Fixation Forcep
- 1 Forcep 5"
- 1 Forcep 8"
- 1 Hemostat 5½"
- 1 Scissors 4½"
- 1 Scissors 5½"
- 1 Curved Arterial Tube 3/32"
- Curved Arterial Tube 1/8"
- Curved Arterial Tube 3/16"
- Drain Tube 1/4"
- Drain Tube 5/16"
- Curved Suture Needle
- Serpentine Suture Needle



Embalming Instrument Roll

Replacements items can be order for the set.



SKU: 910193

Includes:

- **Disposable Scalpel Blade No. 22**
- **4" Dieffenbach Clamp Straight**
- **7" Medium Point Dissecting Forceps**
- **5" Straight Dissecting Forceps**
- **6" Spencer Wells Blunt Straight Point Forceps**
- **7" Spencer Wells Blunt Straight Point Forceps**
- **Kelly's 5 ½" Fine Artery Forceps**
- **Swann Morton No. 4 Stainless Scalpel Handle**
- **Aneurysm Hook No Eye**
- **5" Premium Sharp/Blunt Point Scissors**
- **6" Premium Sharp/Sharp Point Scissors**
- **Double Ended Rigid Separator**
- **McDonald's Separator**
- **Instrument Roll**

SKU: 701468 (pack of 100)

SKU: 702614

SKU: 702698

SKU: 702720

SKU: 702831

SKU: 702832

SKU: 702860

SKU: 703174

SKU: 703338

SKU: 704652

SKU: 704720

SKU: 705701

SKU: 705705

SKU: 910194

Instruments

Embalmer's Stackable Kit Case

Embalmer's stackable kit cases. Two suitcases with drawers and space for all of your embalming kit. The bottom case is on wheels with a pull up handle for easy transportation.

SKU: 910178



Supplies

Accessories

Round Plain Eye Caps

SKU: 751412
Pack of 100



Oval Perforated Clear Eye Caps

Small

SKU: 751340
Pack of 100

Large

SKU: 751345
Pack of 100



Multi Size Expressions

SKU: 760496
Pack of 12

Dodge Oval Perforated Clear Eye Caps

Small

SKU: 751608
Box of 144

Large

SKU: 751610
Box of 144



Dodge Oval Perforated Flesh Eye Caps

Small

SKU: 751606
Box of 144

Large

SKU: 751605
Box of 144



Dental Simulator Former

SKU: 760520
Pack of 12



Perfection Round Perforated Clear Eye Caps

Small

SKU: 751505
Pack of 144

Medium

SKU: 751506
Pack of 144

Large

SKU: 751504
Pack of 144



Pierce Armstrong Mouth Former

SKU: 760510
Pack of 12

Perfection Round Perforated Flesh Eye Caps

Small

SKU: 751508
Pack of 144

Medium

SKU: 751509
Pack of 144

Large

SKU: 751507
Pack of 144



Clear Plastic Mouth Plates

SKU: 760553
Pack of 24

Identification Bracelet Insert

SKU: 720517
Pack of 100



Identification Bracelet Write On

SKU: 720510
Pack of 100



White Wrist Bands

SKU: 720514
Pack of 1000



Suction Cup Tube Holder

SKU: 703306



Metal Screw Skull Clamps

SKU: 750680
Pack of 20

Disaster Pouches & Body Bags

A full range of pouches and body bags are available to suit a wide variety of applications. Details are given of each item, however for further information please do not hesitate to contact your Dodge Representative. (µm - Microns)

Disaster Pouch - EVA with U shaped zip

Size: (XL) 220 x 105 cm - 150 µm

SKU: 760821



Disaster Pouch - Black, with 6 handles & U shaped zip

Size: (L) 222 x 100 cm - 320 µm

SKU: 760823



Ambulance Body Pouch - White, no zip

Size: 220 x 75 cm - 100 µm

SKU: 760820



Medium Weight Body Bag

SKU: 755650

Size: 91.4 x 228.6 cm

Pack of 10



Heavy Weight Body Bag

SKU: 755657

Size: 91.4 x 228.6 cm

Each

Infant Pouch

SKU: 760837

Size: 75 x 50 cm - 130 µm



Baby Pouch

SKU: 760838

Size: 30 x 40 cm - 130 µm



Heavy Duty Pouch

Made of heavy gauge opaque black reinforced vinyl. Liner sheet prevents leakage and adds strength of a double layer. C shaped zipper and 10 sturdy handles.

SKU: 755067

Size: 99 x 226 cm



Blue Cadavar Cover

This cover is designed for the safekeeping and protection of anatomical cadavers where dissection has not been performed. It allows for dignified storage and helps prevent dehydration.

SKU: 760850

Size: 39 x 225 x 44 cm



White Bariatric Bag

Made from heavy gauge plastic with a U shaped heavy duty zip. The zip has two pulls allowing the bag to be opened and closed at any point. 8 handles, A4 document pouch.

SKU: 760840

Size: 218 x 109 cm - 460 µm



HD Bag Within A Bag

Suitable for safe and environmentally friendly recovery and transportation of infectious human remains directly to cremation. Packed with a shroud to wrap deceased remains prior to transfer to the pouch.

Outer Pouch: 304 µm HD "super-tuff" silver colour to reflect sun rays to maintain cooler interior temperature. Eliminates possible leakage in the event either the inner liner or the outer pouch is punctured or breached.

Inner Pouch: 250 µm, will not deteriorate or mildew under normal conditions. Impervious to blood or normal body fluids.

SKU: 760845

Size: 92 x 240 cm



Viscera Bags

A safe, professional way to hold visceral organs on autopsied cases. Made of heavy 4 gauge polyethylene, these 20 x 30" see through bags hold viscera securely, even when treated with full strength chemicals.

SKU: 755620

Size: 20" x 30"

Pack of 10



Supplies

Ligature



Fine Cosmetic Suture Thread

SKU: 761670
Size: 60 metre reel



Ligature Reel

3 Cord
SKU: 761601
Size: 50 g

4 Cord
SKU: 761610
Size: 50 g



Waxed Linen Thread Cop

4 Cord
SKU: 761504
Size: 454 g (1 lb)

7 Cord
SKU: 761507
Size: 454 g (1 lb)



4 Cord Ligature Cop

SKU: 761620
Size: 250 g



5 Cord Ligature Cop

SKU: 761630
Size: 250 g



Post Mortem Twine No.4 Cop

SKU: 761650
Size: 250 g



Black Braided Cotton Cop

5 Cord
SKU: 761495
Size: 454 g (1 lb)

7 Cord
SKU: 761496
Size: 454 g (1 lb)



White Braided Cotton Cop

5 Cord
SKU: 761455
Size: 454 g (1 lb)

7 Cord
SKU: 761460
Size: 454 g (1 lb)

10 Cord
SKU: 761486
Size: 454 g (1 lb)



7 Cord Waxed Polyester Natural Thread Cop

- Moisture repellent.
- Won't stretch or shrink after tying.

SKU: 761403
Size: 453 g

Thread Passer & Spool



- An easy method for passing thread under a vessel to be ligated. The probe is passed under the vessel and the proper length of ligature is withdrawn and cut on the built in blade.
- Helps to prevent contamination of clean ligature by dirty gloves.
- Prevents too much thread being cut for manual ligation of vessels.

Set

SKU: 705558

Includes: Thread passer, 2 spools & 2 blades.

Replacement Spool

- Braided five cord thread.

SKU: 761346

Size: 1 oz

Replacement Blades

SKU: 705566

Pack of 3

Wire Snare (Threader)

SKU: 705574

Dodge Thread Station

- Maintains cleanliness and professionalism in your embalming room.
- Removes the need to handle spools of ligature with contaminated gloves.
- Keeps ligatures in their place.
- Allows for the easy removal of proper lengths of ligature.
- Allows the technician to use more than one kind of ligature (e.g heavy ligature for closing autopsy incisions, thinner ligature for cosmetic sutures).
- Units not supplied with ligature.

Ebony

SKU: 922102

Pearl

SKU: 922100

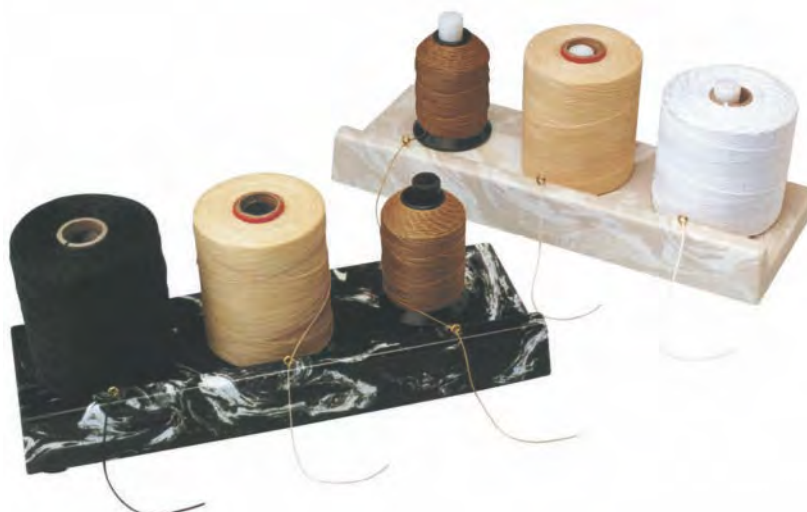

Supplies

Webril Bandages

- Lint free cotton.
- Same material as Webril Towels, but in 2" wide rolls.

SKU: 750539
Size: Pack of 5



Dodge Cotton Wool

- Non-sterile cotton wool.
- Highly absorbent.

SKU: 750705
Size: 500 g roll



Webril Towel

- Lint free cotton towelling.
- Absorbs up to ten times its own weight in liquid.
- Perforated sheets are 8" x 15".

Webril Towel

SKU: 761759
Each



Latex Bandage

- Adheres only to itself.
- Elastic and stretchable.
- Holds wet packs in place.
- Suppresses swellings.
- Adjusts for greater or lesser pressure.
- 3" in width by 5 yards.

SKU: 761304



Plastic Wrap & Handle

Plastic Wrap Roll

- Use plastic film to secure bandages and dressings in place.
- Film adheres to itself.
- Excellent for use under clothing when you don't want to create a bulky look.
- Sold by the roll.

SKU: 920647

Plastic Wrap Handle

- For use with plastic film roll.
- Eases application of plastic film.
- Reduces waste.

SKU: 920648



Crem Film

- Can be used as a disposable removal sheet or for lining coffins and caskets.
- Available in two convenient sizes.

48" Crem Film No Fold Roll

SKU: 760852

48" Crem Film Centre Fold Roll

SKU: 760851





Jumbo Blue Roll

- 2 ply, 370 mm - 400 mts.
SKU: 921901

Stand

SKU: 921950



Hand Towel Centre Feed Roll

- 2 ply, 190 mm - 150 mts.
SKU: 921909
Pack of 6

10" Centre Feed Roll Dispenser

SKU: 921910

Interfold Towels

- V-fold, 1 ply.
SKU: 921902
Case of 20 (5000 sleeves)



Towel Dispenser

- Lockable paper towel dispenser.
• High impact cover.
SKU: 921930



Small Hand Towels 10" Roll

SKU: 921905
Pack of 18

Small Hand Towel Dispenser

SKU: 921907



Large Hand Towels 20" Roll

SKU: 921906
Pack of 12

Large Hand Towel Dispenser

SKU: 921908

Supplies

Cones

'Funeral No Parking' cones, available in two sizes. Sleeves available for existing cones or for replacing old ones.

18" Cone 'Funeral No Parking'

SKU: 920829

18" Sleeve only 'Funeral No Parking'

SKU: 920830

30" Cone 'Funeral No Parking'

SKU: 920831

30" Sleeve only 'Funeral No Parking'

SKU: 920832



Pedal Operated Refuse Bag Stand

Designed to hold refuse and clinical waste bags, this freestanding unit offers increased levels of hygiene as the lid of the unit is opened by the foot of the technician.

Pedal Operated Refuse Bag Stand

SKU: 921980

Heavy Duty Bio Hazard Bags

SKU: 755676

Size: 10 kg

Each



Spring Loaded Sack Tie Tool

For the hygiene and easy way to close refuse sacks, body bags and clinical waste sacks.

Spring Loaded Sack Tie Tool

SKU: 755675

Sack Ties

SKU: 755670

Pack of 100





Arterial System Wall Chart

- 23 x 36" with hangers for wall mounting.
- Rolls up for storage.
- Details the complete human arterial system.

SKU: 920173



Venous System Wall Chart

- 23 x 36" with hangers for wall mounting.
- Rolls up for storage.
- Details the complete human venous system.

SKU: 920199

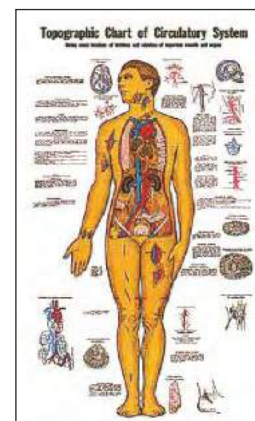

Circulatory System Wall Chart

- 18 x 30" with hangers for wall mounting.
- Rolls up for storage.
- Surgically accurate illustrations for embalming guidance.

SKU: 920215

Health & Safety Signs

Available in self adhesive vinyl (SAV) or Semi Rigid PVC (SR PVC) these signs help to warn of potential dangers or risks and fulfill health and safety requirements.



Dangerous Chemicals Sign

SAV SKU: 753048
SR PVC SKU: 753049
Size: 150 x 200 mm



Bio Hazard Sign

SAV SKU: 753061
SR PVC SKU: 753062
Size: 150 x 200 mm



Danger Hazardous Substances Sign

SAV SKU: 753076
SR PVC SKU: 753077
Size: 300 x 100 mm



Protective Clothing Sign

SAV SKU: 753065
SR PVC SKU: 753066
Size: 150 x 200 mm



Wear Gloves Sign

SAV SKU: 753054
SR PVC SKU: 753055
Size: 150 x 200 mm



Wear Goggles Sign

SAV SKU: 753056
Size: 200 x 150 mm

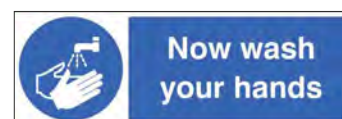

Now Wash Your Hands Please Sign

SAV SKU: 753059
SR PVC SKU: 753060
Size: 300 x 100 mm



Keep This Door Closed Sign

SAV SKU: 753057
SR PVC SKU: 753058
Size: 200 x 200 mm



Unauthorised Persons Prohibited Sign

SAV SKU: 753052
SR PVC SKU: 753053
Size: 150 x 200 mm



No Smoking, No Drinking, No Eating Sign

SAV SKU: 753072
SR PVC SKU: 753073
Size: 200 x 150 mm



No Smoking Sign

SAV SKU: 753050
SR PVC SKU: 753051
Size: 148 x 210 mm

Supplies

Garments



Shroud

An economical shroud for the dignified covering of the deceased. Ideal for use before preparation or following post mortem examination.

SKU: 923701
Quantities of 50



Coverallalls

All these garments represent the finest grade of plastic craftsmanship and materials. Thickness exceeds 4 mm. Full cut from tough, high tensile strength vinyl with impervious heat sealed seams and strong elastic bands. Waterproof and easily fitting. Resistant to embalming chemicals and body fluids. Individually packed in poly envelopes for long storage life.

White	Small SKU: 755223	Medium SKU: 755215	Large SKU: 755207	XL SKU: 755231
Clear	Small SKU: 755202	Medium SKU: 755203	Large SKU: 755204	XL SKU: 755205

White Unionalls

Small
SKU: 755728
Medium
SKU: 755710
Large
SKU: 755702
XL
SKU: 755736
XXL
SKU: 755744
XXXL
SKU: 755749



Clear Unionalls

Small
SKU: 755774
Medium
SKU: 755765
Large
SKU: 755756
XL
SKU: 755783
XXL
SKU: 755794
XXXL
SKU: 755799



White Capri Pants

Small
SKU: 755427
Medium
SKU: 755418
Large
SKU: 755409
XL
SKU: 755436



Clear Capri Pants

Small
SKU: 755473
Medium
SKU: 755464
Large
SKU: 755455
XL
SKU: 755482



Garments



White Pants

Small
SKU: 755322

Medium
SKU: 755314

Large
SKU: 755306

XL
SKU: 755297



Clear Pants

Small
SKU: 755373

Medium
SKU: 755365

Large
SKU: 755357

XL
SKU: 755342



White Stockings

- Sold in pairs.

Small
SKU: 755520

Medium
SKU: 755512

Large
SKU: 755504

XL
SKU: 037239



Clear Stockings

- Sold in pairs.

Small
SKU: 755573

Medium
SKU: 755564

Large
SKU: 755555

XL
SKU: 037234



White Sleeves

- White sleeves sold in pairs.
- One size fits all.

SKU: 755959
Pairs



Clear Sleeves

- Clear sleeves sold in pairs.
- One size fits all.

SKU: 755962
Pairs

Personal Protective Equipment



Economy Safety Glasses
SKU: 753007



Lightweight Face Guard
SKU: 753010



Safety Goggles
SKU: 753006



- Disposable Face Mask**
- 3-ply, spunbonded polypropylene non-woven fabric with an integral plastic coated wire strip above the nose for optimum fit.
 - Latex free elasticated loops to minimise allergic reactions.
 - Fibreglass free.



SKU: 753003
Pack of 50



Formaldehyde Mask
SKU: 753014



Nuisance Odour Mask
SKU: 753005
Pack of 10



FFP3 Valved Mask
SKU: 753028



White Disposable Adult Aprons

Size: 27 x 46", 16 micron
SKU: 755041
Pack of 100

Size: 27 x 53", 16 micron
SKU: 750270
Pack of 100



Apron on a Roll
SKU: 750275
Roll of 50



Apron Roll Dispenser
SKU: 750276



Disposable Oversleeves
SKU: 750841
Pack of 100



Re-usable Oversleeves
SKU: 750840
Pair



Disposable Overshoes
SKU: 750831
Pack of 100



Disposable Mob Caps
SKU: 753021
Pack of 100

Personal Protective Equipment

Gloves

Paragon+ Nitrile

Extended cuff, chemical tested, chemotherapy drug tested, purple, medical grade, heavy weight nitrile examination gloves, washed offline for a softer, more comfortable finish.

Small	SKU: 751705
Medium	SKU: 751706
Large	SKU: 751707
XL	SKU: 751708

Box of 50
Case of 500



Select Black Nitrile

Black, chemical tested, medical grade, medium weight nitrile examination gloves.

Small	SKU: 751715
Medium	SKU: 751716
Large	SKU: 751717
XL	SKU: 751718

Box of 100
Case of 1000



Unicare Soft Nitrile

Blue, powder-free, medical-grade, nitrile examination gloves you can trust for protection. An affordable glove offering enhanced tactile sensitivity for everyday tasks and price sensitive customers, a great alternative if you are prone to skin irritation and allergic reactions. Unicare gloves offer the same strong durability and superior level of protection as traditional latex gloves with increased tactile sensitivity, tear resistance, and a more comfortable fit.

Small	SKU: 751725
Medium	SKU: 751726
Large	SKU: 751727
XL	SKU: 751728

Box of 200
Case of 2000



Pro.Tect Latex HD

Extended cuff, chemical tested, blue, ultra-heavy weight latex single use gloves. PRO.TECT Latex HD (HD refers to Heavy Duty) has an ultra-heavy weight construction which is very tough, durable and long lasting. This construction is suitable for tougher applications where extra durability is required.

Small	SKU: 751750
Medium	SKU: 751751
Large	SKU: 751752
XL	SKU: 751753

Box of 50
Case of 500



Heat & Cut Resistant Gloves



PVC Coated Gauntlets

Size: 14"
SKU: 752245



Size: 18"
SKU: 752249

Hot Grip Gloves

SKU: 750735



Heat Retardant Gloves

SKU: 750741



Bladeshade™ Cut Resistant Gloves

SKU: 752214

Personal Protective Equipment



First Aid Pack
SKU: 920643



Eye Wash Station
SKU: 920631
Includes: 2 x 500 ml Eye Wash Bottles
& 2 x Eye Pads.



Eye Wash Bottle Wall Bracket Holder
SKU: 920633

Eye Wash Solution
SKU: 920632
Size: 500 ml

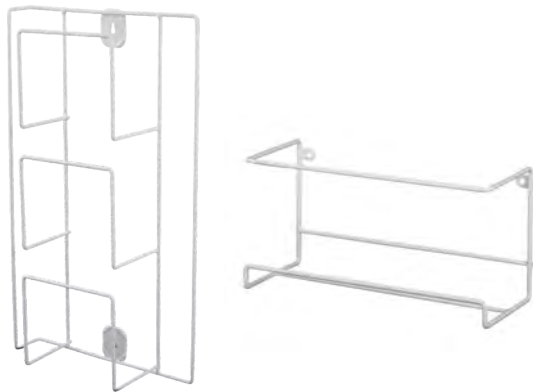

Tripe Glove Wall Dispenser
SKU: 751659

Single Glove Wall Dispenser
SKU: 751559

Hands Free Overshoes Dispenser

Step in and the hands-free overshoe dispenser instantly snaps a disposable shoe cover onto your shoe. No need to bend down, sit down or even touch your toes! Overshoe disposable shoe covers are elasticated to fit all shoe sizes.

SKU: 751100

Overshoes Dispenser Refills
SKU: 751101
Pack of 1000

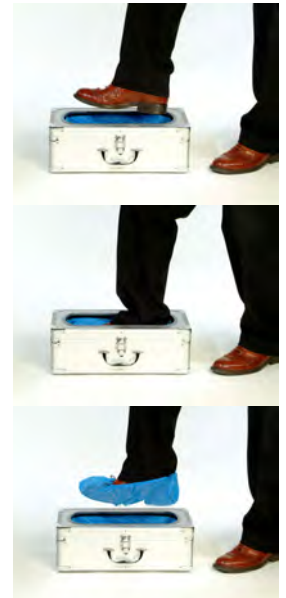

Sharps Container
SKU: 701686
Volume (please state size):
0.5 litres, 1 litre, 2.5 litres, 5 litres, 7 litres & 11.5 litres



Lapel Holder for Tubes
The Dosi-Tube is easily clipped into the holder which is worn on a garment of clothing.
SKU: 754005

Insectocutor
Compact yet robust, simple wall, ceiling or desk mounting.

SKU: INS001
Area Coverage 45 m²
SKU: INS002
Area Coverage 90 m²



Formaldehyde Tubes
Formaldehyde Gastec Passive Sampling Dosi-Tubes. The Dosi-Tube system allows an operator to evaluate the level of gas a worker is exposed to over a time period.

SKU: 754000



Personal Protective Equipment

Personal Protective Clothing

Tyvek Safety Suit

White disposable coveralls with hood from Dupont Tyvek. Ergonomic-protective design. Stitched external seams. Elasticated wrists, ankles and face. Elasticated waist (glued-in). Tyvek® zipper and flap. For all over protection of individuals when removing, preparing or embalming high risk cases.

Large	SKU: 750804
XL	SKU: 750806
XXL	SKU: 750803
XXXL	SKU: 750807



Standard Safety Suit

White safety suit for all over protection of individuals when removing, preparing or embalming high risk cases. Offers type 5/6 particle and limited hazardous splash protection.

Performance Highlights:

- Conforms to EN 13982-1, EN 13034.
- Type 5/6 protection.
- Limited hazardous splash protection.
- Particle protection.
- Zip front with cover.
- Elasticated wrist/ankle closure.
- Elasticated hood.
- Individually wrapped.

Large	SKU: 750810
XL	SKU: 750811
XXL	SKU: 750812



Personal Protective Equipment

Personal Protective Clothing



Washable Surgical Gown

Intended to offer the embalmer, mortuary technician, medical student or pathologist an additional level of protection over surgical scrubs or normal house clothes when embalming, preparing or dissecting the deceased. This gown comes in one size fits all. It will withstand frequent washing and disinfecting. If additional protection is required this gown should be used along with disposable aprons and disposable arm sleeves. Complete with elasticated cuffs and back ties.

SKU: 750867

Size: Large (one size)



Operators Coat

Intended to offer protection to the technician when transferring the deceased from stretcher to embalming table, fridge, coffin, dressing, cosmetising or 'laying out'. This coat features press stud fastening at the front and press stud fastening wrist cuffs.

Chest size 34"	SKU: 750851
Chest size 36"	SKU: 750850
Chest size 38"	SKU: 750852
Chest size 40"	SKU: 750854
Chest size 42"	SKU: 750856
Chest size 44"	SKU: 750858
Chest size 46"	SKU: 750860
Chest size 48"	SKU: 750861
Chest size 52"	SKU: 750869
Chest size 54"	SKU: 750853



Disposable Gown

High protection without compromising comfort. EN13795 Standard Performance (standard) and High Performance (reinforced). May be disposed of after use to prevent contamination and reduce laundry costs. One size fits all.

Performance Highlights:

- Fluid and alcohol repellent.
- Good strength characteristics and low linting.
- Ultrasonic bonded seams.
- For medium (standard) to high (reinforced) fluid exposure.
- Lightweight and comfortable with generous length.
- Adjustable neckline and overlapping back.

SKU: 750863

Size: (one size)

Personal Protective Equipment

Scrubs

Basic Scrub Suits

A comfortable and easily maintained scrub suit which offers a base layer of protective clothing for the embalmer or mortuary technician. These cotton polyester scrubs feature a V-neck and pockets both inside and out for ease of changing. They can be worn under a surgical gown, aprons or lab coats and can be boiled washed after use to ensure hygiene levels are maintained. Available in blue or green and in sizes small to extra, extra large.



Blue

Small	SKU: 750871
Medium	SKU: 750872
Large	SKU: 750873
XL	SKU: 750874
XXL	SKU: 750882

Green

Small	SKU: 750876
Medium	SKU: 750877
Large	SKU: 750878
XL	SKU: 750879
XXL	SKU: 750881

Cherokee Scrub Suits

The Cherokee 4700 scrubs top features a V-neck, dolman sleeves, side seam vents, two hip patch pockets and a pen slot.

The Cherokee 4100 unisex trousers feature a drawstring waste, one back pocket and a cargo pocket with pen slot inside. Both items are made from a hard wearing fabric with a soil release finish for easy laundering.

Fabric: 65% Polyester, 35% Cotton, 145 gsm.



Cherokee Scrubs Suit (Black)

Small	SKU: 750903
Medium	SKU: 750904
Large	SKU: 750903
XL	SKU: 750904
XXL	SKU: 750904

Cherokee Scrubs Suit

XL & below	SKU: 750903
XXL & above	SKU: 750904

Cherokee Scrubs Top

XL & below	SKU: 750916
XXL & above	SKU: 750917

Cherokee Scrubs Trousers

XL & below	SKU: 750918
XXL & above	SKU: 750919

Black	Caribbean	Galaxy
Khaki	Navy	Olive
Grape	Grey	Hunter
Pewter	Red	Royal
Shocking Pink	Surgical Green	Teal
Turquoise	White	Wine
Ciel	Orchid	

Special order item.
Please state size and colour when ordering.



Personal Protective Equipment

Footwear

Classic Klog

This classic clog has stood the test of time and continues to appeal to those that prefer a wooden footbed.

Performance Highlights:

- Coated leather uppers make it easy for you to keep them clean.
- Enjoy the firm wooden footbeds that give your body correct anatomical support.
- Unisex antistatic option also available - code 020W.



Colour: Black
Size: 3-12
Code: 310BK



Colour: Red
Size: 3-12
Code: 310R



Colour: Navy
Size: 3-12
Code: 310N



Colour: White
Size: 3-12
Code: 020W

SKU: 750957

(Please state colour, size & code)

Flexi Klog

FlexiKlog has a built-in arch support that holds them securely on your feet, and helps keep your body in the correct anatomical position.

Performance Highlights:

- The high toe box gives room for your toes to spread.
- Soft leather insole cushioned for ultimate comfort.
- Antistatic soles.
- PU coated easy-to-clean leather uppers.
- The fully flexible sole is ergonomically designed to provide day-long comfort.



Colour: Sky Blue
Size: 3-8
Code: 0723SB



Colour: Black
Size: 3-12
Code: 0723BK



Colour: White
Size: 3-12
Code: 0723W



Colour: Navy
Size: 3-12
Code: 0747N



Colour: Black
Size: 3-12
Code: 310BK



Colour: Butterfly
Size: 3-8
Code: 0724BUP



Colour: Blue Flower
Size: 3-8
Code: 0724BFL

Plain

SKU: 750964

(Please state colour, size & code)

Pattern

SKU: 750966

(Please state colour, size & code)

UK Sizes	3	4	5	6	6.5	7	8	9	10	10.5	11	12
Euro Sizes	36	37	38	39	40	41	42	43	44	45	46	47

Personal Protective Equipment

Footwear

Ultra Lite

UltraLite gives you even better comfort and support using lightweight E-tech sole material technology. Grip-safe slip resistant outsoles will ensure that every step you take is a safe one. The soft leather uppers and insoles will help give you all-day comfort. All come with adjustable heel straps.

Performance Highlights:

- Clever design enables your toes enough room to spread naturally.
- Soft leather insoles relive your tired feet.
- Antistatic, slip resistant soles keep you on the straight and narrow.
- Easy-to-clean leather uppers with a special coating to keep your feet spick and span.
- Also available with side vent holes to keep the feet cool.

SKU: 750948
(State colour, size & code)



Colour: Black
Size: 3-12
Code: 0699BK



Colour: White
Size: 3-12
Code: 0699W



Colour: Navy (+vents)
Size: 3-12
Code: 0698N



Colour: White (+vents)
Size: 3-12
Code: 0698W



Colour: Shiny Blue
Size: 3-12
Code: 0696SBL



Colour: Shiny Purple
Size: 3-8
Code: 0696SPR



Colour: Shiny Hot Pink
Size: 3-12
Code: 0696SHP



Colour: Shiny Silver
Size: 3-12
Code: 0696SSI

Ergo Boot

Unisex washable wellington boots offering you the best protection from fluids. Specially designed for use in clean rooms and for professionals working in medical and food industries.

Performance Highlights:

- Lightweight PVC material.
- Non-marking soles.
- Washable to 50°C.

Half Boot

SKU: 750819
Colour: White
Size: 3-15



Full Boot

Size:	SKU:
3	750820
4	750821
5	750822
6	750823
7	750833
8	750834
9	750835
10	750836
11	750837
12	750838

Safety Wellington

A practical and functional safety boot with a steel toe and midsole for protection from sharp objects and toe injuries. These boots feature a shock-absorbing heel and anti-static properties.

Performance Highlights:

- Standard EN ISO 20345:2011 S5 SRA.
- Toe and mild sole protection
- Slip resistant outsole.
- Resistant to minerals, animal and plant oils, fats, various disinfectants and chemicals.



SKU: 750824
Size: 3-12

Equipment

Are you thinking of updating your embalming room or do you simply need to replace some out dated equipment? Dodge has the answers your looking for!



Let the Dodge Company help you. With over a hundred years of experience, we have invested considerable time and effort in selecting products that make life easier. In simple terms, products chosen by embalmers, for embalmers.

From embalming tables to body hoists, removal stretchers, instrument trolleys and many other invaluable items we are pleased to be able to fulfil any requirements that you may have. If there is an item of equipment that you need and it can't be found in the catalogue, please contact us. We are only too happy to help, and if we can find it, we will supply it for you.

In recent years there has been much emphasis placed on health and safety in the work place and in particular the control of environments deemed to be potentially hazardous to the health of the workforce. Control of potential sources of infection, good standards of hygiene and control of substances hazardous to health. In planning a safe and practical embalming room, there are many factors that need to be considered including use of floor space, ventilation, work surfaces, tables, safe storage of the deceased and containment of chemicals and storage. We can help. Whether you just want to consider your options or a refurbishment is well overdue and you need it as soon as possible, we are well placed to help. Typically we offer a six to eight week lead time on most of our capital equipment and delivery to your facility direct from the manufacturers, we can meet your demands in realistic time frames. Put our experience to work for you, we can help in all aspects of redesigning and equipping your facility and ensuring that it will more than meet its requirements for many years to come.



The Standard Single Motor Unit

This is an economy unit, housed in a stainless steel case. It has a pressure gauge and twin bleed valves to control pressure and vacuum.

SKU: 709406
Size: 20.2 x 20 x 18.3 cm
Weight: 3.35 kg

Vinyl Tubing
SKU: 761980
Size: Per metre
(sold separately)



The Standard Twin Motor Unit

This unit is the ultimate of its type. It is housed in a stainless steel case and has twin motors, each with independent gauges, pressure and vacuum controls. This allows for continuous and simultaneous injection and drainage as each function is controlled by its own motor.

SKU: 709411
Size: 23 x 27 x 18.3 cm
Weight: 5.3 kg

Vinyl Tubing
SKU: 761980
Size: Per metre
(sold separately)

Equipment

User Guidelines

Dodge Embalming Machine with Automatic Pressure Control

The Dodge Embalming machine with Automatic Pressure Control is a breakthrough in the control offered to the embalmer, when injecting arterial fluid into the deceased. With unique features, The Dodge APC Embalming machine can be relied upon to produce consistently excellent penetration and distribution of embalming fluid.

Using the machine is simple and we would recommend taking a few moments to become familiar with its operating features. The Dodge Embalming machine with APC is designed to control the flow rate of embalming fluid and automatically adjust the pressure to ensure the rate of flow is maintained. The machine also offers both direct and pulsating injection. The machine features two gauges to show the level of fluid in the tank as well as the rate of flow. There is also a dial on the front of the machine to adjust the rate of flow.

Start by unpacking the machine and placing it in a convenient location in your embalming room. For ease of operation, we suggest either a countertop near to an electrical and water supply or a mobile trolley. Once the machine is in the correct location connect the electricity supply and tuck any excess cable out of the way behind the machine.

The machine features a mix cycle, which will mix your selected fluid without needing the injection hose to be attached. This can be very useful if you wish to prepare your chosen fluid before attaching the injection hose. The machine can be fitted with a clip which holds the hose, which can be fitted to the front of the machine, or two cleats on the right hand side on which the injection hose can be coiled round when not in use.

Prior to first use, we recommend trying the machine with some plain water, to become used to its working action. Remove the lid of the fluid reservoir and add two or three litres of cold tap water. turn the dial on the left hand side of the machine to 'mix'. If you look inside the tank you will see that the machine circulates the fluid in the tank to mix all chemicals together. At this time please ensure that the injection hose is attached. now, pointing the injection hose into the fluid reservoir, turn the on/ off dial to direct injection and gently open the flow dial by turning it from left to right.

Once you have set the desired rate of flow, the machine will do the rest. If any blockages are encountered, that reduce the rate of flow, the machine will increase the pressure to ensure the desired rate of flow is maintained. With this a note of caution should be added. The diameter of both the artery being injected and the injection tube fitted will impact the rate of flow at the end of the machine hose. If the machine senses any restriction in the rate of flow, it will increase the pressure. If the injection tube is changed and the flow rate remains the same, the pitch of the machine may change as it works to maintain the same rate of flow through a much smaller diameter tube. Due to the high quality components and workmanship supporting this machine, the pump should in no way be damaged, however some operators may find it unnerving. Also, the operator may be surprised at how quickly delicate facial tissues embalm using tiny maxillary tubes if the flow rate has not been adjusted.

Another useful addition to the features of this machine is the pulsation setting. This allows fluid to be delivered into the circulatory system one "spurt" at a time. This "spurt" is similar to the manner in which blood is pumped around the body by the heart. The pulsing mechanism allows for deeper and better diffusion of arterial fluid around the body and assists in clearing cases where discolouration is evident, and helps ensure more thorough preservation on long term or shipping cases. throughout the embalming procedure, the flow of the injected arterial solution can be adjusted and the injection can be switched between direct or pulsation. The operator really is in control of the entire procedure internally and externally.

When injection has been completed, the machine should be washed out with fresh water, to prevent the arterial chemicals damaging the internal components. Once you have completed the injection, any fluid remaining in the tank should be drained away before fresh water is added for rinsing purposes. Once the hose has been rinsed clean, it can be used to rinse the fluid reservoir. When doing this, remember to turn the flow down to prevent excessive splashes. If any residues remain Dis-Spray and Webril towel or disposable paper will effectively remove it. The outside of the machine can also be cleaned in this way.

When filling the machine, avoid excess splashing of chemicals or diluted solutions. Should excessive foaming become a problem, a couple of sprays of Dis Spray to the foam will reduce it without any adverse effect to the fluid.

The Dodge Embalming Machine - Automatic Pressure Control

The next Generation of Dodge Embalming machines. With the advanced technology of Automatic Pressure Control capability that automatically self-adjusts to manage various sources of vascular resistance.

Performance Highlights:

- Ultra quiet operation while injecting.
- Built in rate of flow meter.
- Choose between pulsation or continuous injection.
- Complete stainless steel cabinet with Dodge quality components and construction along with a comprehensive Dodge warranty.
- Exterior cabinet dimensions are: H14" x W17" x D19".
- Pump is industrial duty with magnetic drive.
- Quick release injection tubing. Easy to detach, drain and coil for storage.
- Auto-mix cycle mixes your solution without even requiring the hose to be attached.
- Easy access to the in-line filter.
- Recessed carrying handles allow the machine to be moved easily.
- Hose complete with adapter and stopcock to accommodate threaded or luer-lock arterial tubes.



SKU: 924201

Size: 17" x 19" x 14"

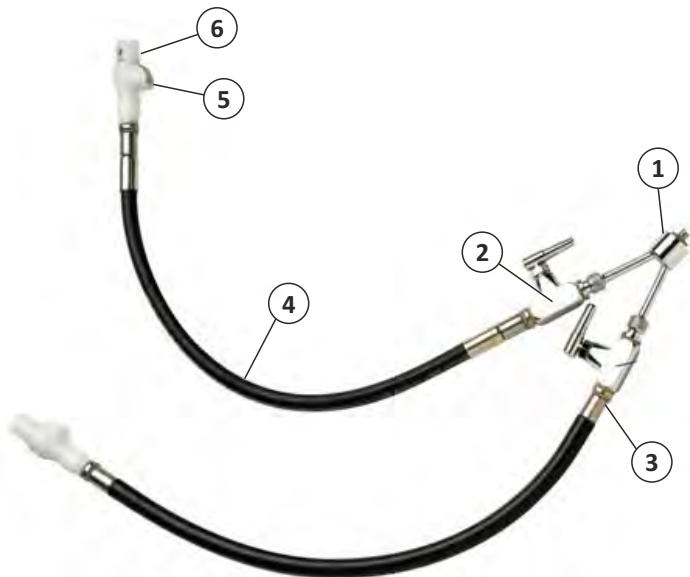

Extra Parts

Quick Disconnect "O" Rings

SKU: 924327

Size: Pack of 6

Replacement High Pressure Hose with fittings

SKU: 924019

Size: 3 metres

Extension High Pressure Hose

SKU: 924017

Size: 500 mm

High Pressure 'Y' Assembly for Dodge APC Machine

The next Generation of Dodge Embalming machines. With the advanced technology of Automatic Pressure Control capability that automatically self-adjusts to manage various sources of vascular resistance.

High Pressure "Y" Assembly Set

SKU: 924329

"Y" Assembly includes:

1. One Male "Y" with Male Thread

SKU: 709309

2. Two Stopcocks for High Pressure "Y" Injector Assembly

SKU: 924320

3. Four Double Male Threaded Adapters

SKU: 701055

4. Two Dodge Machine 12" Tubes for "Y" Injector Assembly

SKU: 924323

5. Two Quick Disconnects - Female for Dodge Machine

SKU: 924325

6. Two Quick Disconnects - Male for Dodge Machine

SKU: 924326

Equipment

User Guidelines Original Dodge Embalming Machine

The Original Dodge Embalming machine is a breakthrough in the control offered to the embalmer, when injecting arterial fluid into the deceased. With all the features that every embalming machine should have, but none do, the Original Dodge Embalming machine can be relied upon to produce consistently excellent penetration and distribution of embalming fluid.

Using the machine is simple and we would recommend taking a few moments to become familiar with its operating features. The Original Dodge Embalming machine is designed to control pressure and flow simultaneously as well as offering both direct and pulsating injection. The machine features two gauges to show the level of fluid in the tank as well as the rate of flow. There are also two dials located on the front of the machine to control the rate of flow and the pressure.

Start by unpacking the machine and placing it in a convenient location in your embalming room. For ease of operation, we suggest either a countertop near to an electrical and water supply or a mobile trolley. Once the machine is in the correct location connect the electricity supply and tuck any excess cable out of the way behind the machine. The machine features a mix cycle, which will mix your selected fluid without needing the injection hose to be attached. This can be very useful if you wish to prepare your chosen fluid before attaching the injection hose. The machine can be fitted with a clip which holds the hose, which can be fitted to the front of the machine, or two cleats on the right hand side, which the injection hose can be coiled round when not in use.

Prior to first use, we recommend trying the machine with some plain water, to become used to its working action. Remove the lid of the fluid reservoir and add two or three litres of cold tap water. Turn the dial on the left hand side of the machine to 'mix'. If you look inside the tank you will see that the machine circulates the fluid in the tank to mix all chemicals together. At this time please ensure that the injection hose is attached. Starting with the pressure control dial, turn it gently as far to the left as possible, to ensure that the pressure is at the lowest setting.

With the pressure control at its lowest setting, now turn the flow control dial as far to the right as possible. The flow will now be at its lowest setting. You can now set the rate of flow and pressure independently of one and other to your desired setting. We suggest setting the pressure first, as this increases the rate of flow. Once the desired pressure has been set, open the flow valve and watch as the pressure decreases. You can then turn the pressure up or down and adjust the flow as you wish. Because of the design of this machine you can embalm with any combination of pressure or flow. For bodies dead for a short period of time, a moderate rate of pressure and flow will produce exceptional results. For bodies dead for longer periods or those that are circulation resistant higher rates of pressure and lower rates of flow will produce distribution and penetration of arterial fluids previously thought impossible.

Another useful addition to the features of this machine is the pulsation setting. This allows fluid to be delivered into the circulatory system a "spurt" at a time. This "spurt" is similar to the manner in which blood is pumped around the body by the heart. The pulsing mechanism allows for deeper and better diffusion of arterial fluid around the body and assisting in clearing cases where discolouration is evident as well as helping to ensure more thorough preservation on long term or shipping cases.

Throughout the embalming procedure, the pressure and flow of the injected arterial solution can be adjusted and the injection can be switched between direct or pulsation. The operator really is in control of the entire procedure internally and externally.

When injection has been completed, the machine should be washed out with fresh water, to prevent the arterial chemicals damaging the internal components. Once you have completed the injection, any fluid remaining in the tank should be drained away before fresh water is added for rinsing purposes. Once the hose has been rinsed clean, it can be used to rinse the fluid reservoir. When doing this, remember to turn the pressure and flow down to prevent excessive splashes. If any residues remain after rinsing, Dis-Spray and Webril towel or disposable paper will effectively remove it. The outside of the machine can also be cleaned in this way.

When filling the machine, avoid excess splashing of chemicals or diluted solutions. Should excessive foaming become a problem, a couple of sprays of Dis-Spray to the foam will reduce it without any adverse effect to the fluid.

The Original Dodge Embalming Machine

Finally an embalming machine you can depend on. This one has all of the features that every machine should have, but none do!

Performance Highlights:

- Inject at low pressures, if that's your preference, or use high pressures to overcome blockages.
- Built in rate of flow metre.
- Choose between pulsation or continuous flow.
- Completely stainless steel cabinet. Dodge quality components and construction along with a comprehensive Dodge Warranty.
- Pump is industrial duty with magnetic drive.
- Quick release injection tubing. Easy to detach, drain, coil and store in the fluid reservoir or use the hose clip on the front of the machine.
- Auto-mix cycle mixes your solution without even requiring the hose to be attached.
- Recessed carrying handles allow the machine to be moved more easily.
- Hose complete with adapter and stopcock to accommodate threaded or luer-lock arterial tubes.
- Easy access to in-line filter.
- Convenient hose holder cleats on the side of the machine.



SKU: 924001

Size: 17" x 19" x 14"

The Dodge Embalming Machine Parts

1. Tank level gauge
2. Flowmeter.
3. Pressure gauge.
4. Selector switch-off, mix, pulse and direct.
5. Pressure adjustment.
6. Flow adjustment.
7. Red indicator light.
8. Injection tube quick disconnect.
9. Rubber feet.
10. Tank cover.
11. Handle.



Equipment

User Guidelines Dodge Waterless Electric Aspirator

The Dodge Waterless Electric Aspirator is supplied with both suction and discharge hoses and a 5/16" diameter 18" Slaughter Trocar. Set up is easy and the machine can be ready for use in a few moments.

Place the machine on a trolley or worktop close to the drain or sluice that it will discharge into. There should also be a power point near by. Connect the discharge hose to the port marked 'D'. The machine is supplied with a weight that should be pushed onto the discharge hose, about six inches above the end of the hose that will rest in the drain, sink or sluice. This weight will help to keep the discharge hose in place. With new embalming rooms or refurbishment projects, it may be best to have an additional drain pipe installed next to the embalming table or station so that the machine may discharge directly into the sewer line. Next connect the suction hose to the port marked 'S'. When in use the discharge hose may jump about slightly and we would advise testing the machine first with some water to become familiar with the action of the pump.

The unit can be placed on a worktop, trolley or even the floor. The position of the machine will in no way affect its performance. Testing has found that the unit will work very well if left on the floor next to the embalming station, sluice or drain and being operated by the embalmer with his or her foot. At this time, it is worth noting that some thought should be given to the position of the machine and the length of suction and discharge hoses. The aspirator is supplied with six metres of hose, that can be cut to suit the individual situation of the purchaser. We would recommend allowing two metres of hose for the discharge and four for the suction. If the machine is to discharge into an embalming station with a strainer basket, or a sluice that has a grating for a bucket, a cable tie can be used to hold the hose in place and avoid it falling from place. If the sluice in your embalming room is a modified toilet with the seat still in place, insert the discharge hose and close the seat to guard against splashes and prevent the hose from falling out.

It may take a few days to get used to the action of the machine, however after a day or two we are sure that you will wonder how you ever managed without it. For those who currently use a Hydro Aspirator, the process of aspiration is exactly the same except for the reduction in the amount of water used in the embalming room. For those who are currently using a vacuum pump and aspiration jars, you will need to monitor the suction hose and the material entering it as you work through the cavities of the body. Our testers agreed that the best procedure is to start with atrial drainage and then relocate the trocar when no further fluid enters the suction hose. Aspiration is then performed until no more material enters the suction hose. While aspirating it is advisable to periodically rinse the trocar and hoses with a disinfectant solution. This helps to prevent a build up of material in the trocar, hoses and pump head and also helps to disinfect the material discharged into the sewer system during the aspiration process.

After the aspiration is completed, clean disinfectant solution should be run through the suction and discharge hoses and the outside of the hoses and the machine should be cleaned with a clean cloth, which has been dampened with disinfectant. Periodically you may want to draw disinfectant solution through the machine and let it sit for a while before flushing through with clean water. This will help to ensure that your machine remains in top condition. The outside of the machine can be wiped down and even sprayed with disinfectant, however it should never be immersed in liquid and must be disconnected from the mains electricity first.

There is only one part of the machine that can be replaced, the tube inside the pump head and this can be undertaken by the embalmer. There is a video showing how this is done on the Dodge UK website. The screws in the pump head are simply undone, the old tube removed, the new tube inserted and the screws replaced.

The suction generated by the machine is ample for aspirating the most difficult case and the procedure is more pleasant. Embalmers will appreciate not having to handle aspirated material, or clean and disinfect dirty aspiration jars. They will also be spared the problems when Hydro Aspirators block or require dismantling for cleaning and maintenance. There are significant time savings made, not having to deal with aspiration jars or stopping half way through the aspiration procedure to empty jars due to high volumes of fluid in the cavities. The Waterless Aspirator takes the labour out of aspiration and assists the busy embalmer in maintaining the highest standard of embalming practice as well as personal and environmental hygiene while working.



The Dodge Waterless Electric Aspirator

The Dodge Waterless Electric Aspirator is the first electric aspirator available to the funeral profession which utilises the technology of the peristaltic pump.

The peristaltic pump, which is primarily used in the medical field in dialysis and heart/lung bypass devices, eliminates the need for aspirated materials to pass through a motorised mechanism or impellor. The aspirator creates a vacuum by compressing flexible tubing, using a series of three rollers which rotate in a housing at a high rate of speed. This allows the isolation of the aspirated material from any moving part of the mechanism, thus eliminating the possibility of contamination or clotting, a common problem with all other electric aspirating devices.

By creating the vacuum necessary for aspiration through electricity, The Dodge Waterless Electric Aspirator eliminates the need for large volumes of water to be wasted during the aspirating process. The device also eliminates the need for the operator to handle the aspirated material collected in glass or plastic aspiration jars. The risk of these jars imploding or being dropped is also removed. Material removed from the deceased during the aspiration process is simply discharged directly into the sluice, foul sink or drain without the operator ever being exposed to it. This machine has been thoroughly tested and will work all day every day, year after year with no need for time consuming maintenance or risk of mechanical failure.

This machine will allow for thorough and easy aspiration of the deceased, while helping to improve the hygiene standards in the embalming room and protecting the embalmer from exposure to potentially harmful and infectious material.

Performance Highlights:

- Uses quick disconnect fittings for both intake and discharge lines, ensuring ease of use, cleaning and storage.
- Stainless steel motor housing and high impact plastic pump housing provide durability and a professional appearance.
- Supplied with a 18" Slaughter Trocar and 6 metres of suction/discharge hose re-inforced tubing 12.5 mm ID, OD 18.5 mm.
- One year warranty for parts and labour and two year warranty for the motor.
- Use in areas where poor water pressure prevents the use of a Hydro Aspirator.

Dodge Waterless Electric Aspirator

SKU: 924060

Includes: 6 metres of hose & 1 x 18" Trocar

Vinyl Tubing

SKU: 761992

Size: Per metre

Internal Tubing

SKU: 924061

Each

Trocar

SKU: 706614

Size: 18"

Equipment

5 & 10 Litre Calibrated Pressure Tanks

Here at Dodge we are pleased to introduce to you a new range of 5 and 10 litre pressure tanks for arterial injection. These tanks offer enhanced features to support the busy embalmer in their work. A sturdy base ensures that the tank will not tip over either when empty or full, and the threaded lid makes it easier to fill with chemicals or water without spills or leaks. The tank is also fitted with our chemical resistant 14H injection and drainage hose and a stop tap. A back flow valve ensures that no liquid can ever enter the motor pump, even if the tank is over filled. We have also featured a manual pump and pressure gauge so that the pressure tank can be used with or without an electric motor pump. This feature is particularly valuable for the busy trade embalmer or in cases of mechanical failure. This compact and sturdy unit will offer years of trouble free service and can be relied upon in the busiest of facilities.



Performance Highlights:

- Impact resistant, calibrated polyethylene pressure tank.
- Supplied with all required injection and pressure hoses.
- Injection line fitted with stop tap to control fluid flow.
- Fitted with pressure relief valves, which doubles as safety valve when in use.
- 5 litre ideal for use in locations where space is at a premium.

5 Litre Pressure Tank Complete

SKU: 705544

Size: 5 litre

10 Litre Pressure Tank Complete

SKU: 705545

Size: 10 litre

Vinyl Tubing

SKU: 761980

Size: Per metre

Heavy Duty Aspiration Jars

Easy to clean and re-usable, our new reinforced impact resistant jar withstands high negative pressure when aspirating. It can be linked to additional jars for increased capacity. The ball float valve feature helps to reduce the risk of flooding your motor pump. The jars will fit into the Dodge Carry Cradle.

2 Litre Aspiration Jar

SKU: 705845

Size: 2 litre

2 Litre Carry Cradle

SKU: 705475

4 Litre Aspiration Jar

SKU: 705942

Size: 4 litre



Aspiration Goosenecks

Standard

The standard chrome plated brass gooseneck for all aspiration procedures.

SKU: 703090



Deluxe

The deluxe chrome plated brass gooseneck for all aspiration procedures. Disassembles for easy cleaning.

SKU: 703100





Hydro Aspirator

The finest Hydro Aspirator on the market. Equipped with a sight glass to monitor fluid flow and an automatic vacuum breaker to prevent contamination of the water supply. This unit can be completely disassembled for cleaning and disinfection, which we recommend take place regularly to prevent contamination of cases. To provide adequate vacuum pressure for aspiration procedures a water supply of 60 psi is recommended.

**Complete Hydro Aspirator without Clearview
USA to GB Thread Adapter
Backflow Preventer**

SKU: 701199
SKU: 701238
SKU: 701284

Dodge Aspiration/Injection Hand Pump

Without doubt, this unit is the finest available on the market today. Constructed from Chrome plated brass, this hand pump can be used to pressurise injection tanks or create vacuum for aspiration jars. A valuable back-up for such occasions as power failures or mechanical faults with electric pumps.

Dodge Aspiration/Injection Hand Pump
SKU: 703780

Spare Valve
SKU: 703781
Pack of 2

Vinyl Tubing (Sold separately)
SKU: 761980
Size: 1 metre



Kidney Dishes

Available in two sizes, these stainless steel kidney dishes are ideal for holding instruments or used as a receptacle for soiled absorbent products when cleaning the facial features.



8" Kidney Dish
SKU: 923230



10" Kidney Dish
SKU: 923229



Stainless Steel Bucket

This stainless steel bucket is hard wearing, easy to clean and disinfect. Can be used to hold the viscera of autopsy cases or hung on the end of many embalming tables to capture drainage.

SKU: 923210
Size: 12 litres

Lotin Bowls

Stainless steel lotion bowls are ideal for containing items like eye caps or for decanting products like Feature Builder or Basic Dryene for easy loading of syringes or swabs.



Small
SKU: 923240
Size: 3" (8 oz)



Large
SKU: 923235
Size: 6"

Equipment

Dodge Body Rests

Performance Highlights:

- Sold in sets of four for use at the heels, buttocks, shoulders and under a head block.
- Less obstruction to waste drainage.
- Facilitates hypodermic treatment to the backs of autopsy cases.
- Non-slip rubber feet.
- Redesigned so that they will no longer hold water after immersion while cleaning.
- Solid anodized aluminium construction.
- Now with stronger, thicker posts inside the rubber feet.
- Resists breakage due to heavy use.
- Raises the body 2" above the table surface.
- Aids circulation over the posterior surfaces of the body.

Body Rest Set

SKU: 910260

Includes: 1 x short & 3 long rests.

Pack of 4

Short Rest

SKU: 910261

Size: 8.75" x 3.75"

Each

Long Rest

SKU: 910262

Size: 17.75" x 3.75"

Each



Lower Body Positioner

Designed to be an embalmer's second pair of hands in the embalming room. The lower body positioner assists the embalmer in all aspects of preparation of the lower aspects of the body including packing, wrapping and dressing.

Performance Highlights:

- Helps the operator during the embalming process, as well as during dressing.
- Rugged construction - made of high impact plastic.
- Minimises points of contact between the body and embalming table. Assists with fluid distribution.
- Both table and positioner stay cleaner since waste flows freely into the drain.
- Lightweight and easily sanitised.

SKU: 999900

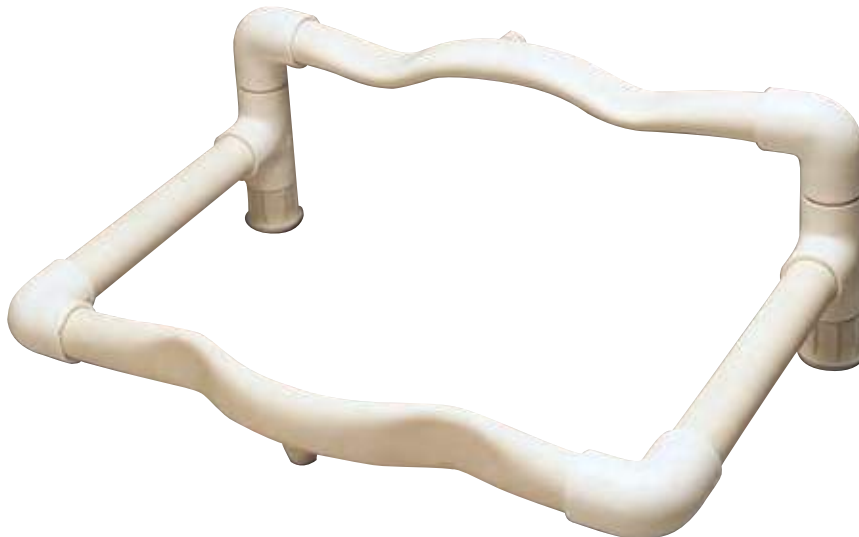



Adjusto Block Exclusive to Dodge

Performance Highlights:

- Extra deep curvatures.
- Molded in resilient, impervious rubber.
- Non-skid texture.

Large

SKU: 910224
Each

Medium

SKU: 910237
Each

Small

SKU: 910244
Each



Multi Position Head Block

Performance Highlights:

- Our best selling head block.
- Economical.
- Easy to clean, durable rubber.

SKU: 910228
Each



Polystyrene Headrest

Performance Highlights:

- Inexpensive, convenient and disposable polystyrene head rests.

SKU: 910233
Pack of 100



Aluminium Headrest

Performance Highlights:

- Allows for head and neck positioning far superior to any rubber head block.
- Elevating adjustment from 3" to 7".
- Pivotal head cradle.
- Suction cup feet prevent slippage.
- Easy to clean and sterilise.
- Light weight.

Aluminium Headrest

SKU: 921379
Each

Suction Cup Foot Part

SKU: 921387
Each



Dodge Arm Positioners

Performance Highlights:

- Creates a truly natural looking placement during the fixation of the arms and hands.
- Chrome plated steel. Extends up and down to accommodate all body sizes.
- Bases covered in rubber.
- Easy to clean and disinfect.
- Can overcome the hand that refuses to stop sliding down.
- Works equally well under the legs.
- Can be used to help drain oedematous limbs.
- Sold as a pair.

SKU: 910154
Pair



Dodge Cross Chest Arm Support

Performance Highlights:

- Allows for easier cleaning of the table, since these arm rests do not sit on the table.
- Adjusts to the height of the arm by loosening or tightening the strap.
- Straps can be removed, washed and disinfected.
- Replacement straps are available.
- Stainless steel portion is easy to clean and sterilise.
- Less expensive than two head rests (which are sometimes used to position the arms).

SKU: 910155
Pair

Replacement Strap
SKU: 910516



Extremities Positioner

Performance Highlights:

- Made of 1" wide velcro.
- Assures the hands will stay in the correct place, even on very obese cases.

SKU: 910157

The Dodge Folding Embalming Table with Pedal

The lift assist Dodge Folding Embalming Table has a unique lifting system allowing the table to be raised or lowered to various height positions at either end with the push of a foot pedal. The specially designed struts give assistance when raising the table with a maximum load of 280 kg. When not in use the table simply folds up for storage and is finished in high quality stainless steel with locking castors on each corner.

Performance Highlights:

- Top/ base constructed from 304 grade stainless steel.
- Folding mechanism constructed from lightweight aluminium.
- Comes complete with 4 stainless steel body supports.
- Fully height adjustable at either end.
- Drain hole and bucket hook at foot end.
- Push pedal to raise and lower.
- Unique lift assist locking struts.



Technical Data:

Length: 198 cm
Width: 75 cm
Max Height: 95 cm
Min Height: 83 cm
Folded Depth: 20 cm
Max Load: 280 kg
Weight: 45 kg

The Dodge Folding Embalming Table with Pedal Assist

SKU: AUD001

Set of Three Perforated Trays to fit table top

SKU: AUD005

The Dodge Folding Embalming Table with Pedal Assist and Set of 3 Perforated Trays

SKU: AUD007

Embalming Table with Adjustable Ram

All stainless steel mortuary embalming table that has an adjustable ram allowing the operator to adjust the drain angle when required. It has a built in drainage hole with bucket hook or can be connected directly to drain via pipework (not included). Comes complete with 4 x body supports and 4 x locking wheels.

Technical Data:

Length: 78.5" / 200 cm
Width: 30" / 76 cm
Height: 32.5" / 83 cm
Max Load: 200 kg

SKU: AUD002



Equipment

Stretchers



The Multilevel XL300

The Multilevel XL300 funeral trolley has been designed to carry out safe and dignified removal of larger bodies.

The fold down locking sides greatly increase surface area allowing body mass to be contained. This trolley can also be fitted with our easy-out system which eliminates the need to lift when exiting your vehicle. The XL300 also benefits from our Roll in Roll out system allowing it to fit into very small nursing home lifts in an upended position without the operator having to take the weight.

Specifications/ Dimensions:

Length: 193 cm
Loading Wheel Width: 58 cm
Max Width (Arm-sides Out): 89 cm
Height Mattress: 78 cm
(inc foot stop): 92cm
Min Height: 27 cm
Loading Wheel Height: 58.5 cm
Weight: 31 kg
Max Load: 318 kg (50 st)

Options:

Choice of cover/mattress colour & fixed wheel options.
Also available with multi directional wheels.

SKU: AUD13

Includes: Mattress, 3 Straps, 2 Soft Polyester Body Covers (1 Standard Size & 1 Extra Large)



The Multilevel AT200

The Multilevel AT200 has been designed and manufactured to move easily over cobble stones, gravel, uneven surfaces, door thresholds, grass, snow and ice. Its large pneumatic tyres and tread pattern minimise surface vibration.

The stretcher can be moved between height positions without assuming the full weight. The multilevel facility allows for body transfers without lifting and when folded flat, it fits into the same space as a conventional trolley.

Specifications/ Dimensions:

Length: 193 cm
Width: 58 cm
Maximum Height: 83 cm
Minimum Height: 27 cm
Loading Wheel Height: 60 cm
Weight: 34 kg
Maximum Load Weight: 200 kg

Options:

Choice of cover/mattress colour. Also available with multi directional wheels.

SKU: AUD004

Includes: Mattress, 2 Straps, 1 Soft Polyester Cover (Standard Size)



The Multilevel ISP

The Multilevel ISP funeral trolley is a compact and lightweight unit that offers excellent maneuverability throughout the removal process. Its multi-height facility allows easy sideways body transfers. An interchangeable removable First Call Stretcher makes removals in space restrictive areas easier. The Multilevel ISP also benefits from our Roll in Roll out system allowing it to fit into very small nursing home lifts in an upended position without the operator having to take the weight.

Specifications/Dimensions:

Length: 193 cm
Loading Wheel Width: 51.5 cm
Height – Mattress: 84 cm
Min Height: 27cm
Loading Wheel Height: 58.5 cm
Weight: 31 kg
Max Load: 200 kg (31 st)

Options:

Available with brakes, steering, cover/mattress colour & fixed wheel options. Also available with multi directional wheels.

SKU: AUD24

Includes:



Combination Stretcher

The Combination Stretcher gives the operator the choice of using the First Call One Man Loader with Folding Footend or First Call Stretcher with footstop individually or combining both to offer an advanced removal package.

Specifications/Dimensions:

Length: 193cm
Width: 61cm
Height including Footstop: 90.5cm
Min Height: 28cm
Loading Wheel Width: 58.5cm
Weight: 33 kg
Max Load: 200 kg (31 st)

Options:

Available with brakes, steering, cover/mattress colour & fixed wheel options. Also available with multi directional wheels.

SKU: AUD388

Includes: First Call Stretcher with foot-stop, 3 Straps & 1 Soft Polyester Body Cover (Standard Size).

Equipment

Stretchers



The Compact Stretcher

The Compact Stretcher is the smallest folding first call stretcher in its class. Designed to be used when space is a premium, the Compact Stretcher is securely housed in a heavy duty padded Cordura Bag and is guaranteed to give a professional impression whether used at a care facility or private home.

Specifications/ Dimensions:

Length: 187 cm
Fold Length: 46 cm
Width: 51 cm
Height: 19 cm
Weight: 8 kg
Maximum Load Weight: 165 kg (26 st)

SKU: AUD14

Includes: 2 straps and standard cover.



The First Call Stretcher

A simple and effective folding foot-stop has been fitted to the First Call funeral stretcher. This will assist the operator when wheeling and transporting remains up or down stairs. The wheels and legs fold away and it also folds in half for neat storage.

Specifications/ Dimensions:

Length: 187 cm
Length Folded: 91 cm
Width: 51 cm
Height: 19 cm
Weight: 7.5 kg
Maximum Load Weight: 165 kg (26 st)

Options:

Available with multi directional wheels.

SKU: AUD11D (complete with folding foot stop)

SKU: AUD11C (without folding foot stop)

Includes: 2 straps (Fits in standard storage bag).

First Call Stretcher Storage Bag

A wipe clean PVC coated polyester bag with carrying handle and single zip for closure. Contains and protects first call stretchers when not in use and enhances professional image when used in public.

Colour Option:

Maroon & Black

SKU: AUD11



Stretchers



First Call Flexible Stretcher

The First Call Flexible Funeral Stretcher is constructed from hard wearing wipe clean PVC with built in wooden slats. The Flexible Stretcher is welded throughout and features six carry handles and three internal straps.

Specifications/ Dimensions:

Length: 196 cm
Weight: 7 kg
Max Load: 165 kg / (26 st)
3 Internal Straps

Options:

Cover colour and zip placement centre or perimeter

SKU: AUD387



Heavy Duty First Call Flexible Stretcher

The First Call Flexible Stretcher HD is a heavy duty flexible stretcher constructed from heavier PVC with thick wooden slats and is longer than the standard version. The five internal straps and large zip make containment easier.

Specifications/ Dimensions:

Length: 213 cm
Weight: 13 kg
Max Load: 230 kg (36 st)

Options:

Cover colour and zip placement centre or perimeter

SKU: AUD390



Small Remains Carrier

The discreet and unobtrusive removal of infant remains is absolutely essential. The Small Remains Carrier offers the solution to this most sensitive of removals. Manufactured in a wipe clean vinyl, the carrier features short strap handles and a sturdy twin zip closure. The Carrier also has a removable internal pouch to aid in cleaning.

Specifications/ Dimensions:

Length: 61 cm
Width: 35.5 cm
Height: 30.4 cm

Colour Option:

Maroon & Black

SKU: AUD386



The Body Lifter

Designed to minimise unnecessary handling, this cleverly designed stretcher is fitted with snap locks at the head and foot ends which allow the stretcher to be separated into two halves. Simply place one half either side of the deceased and slide both halves together until the locks snap closed. The concave surface cradles the remains and prevents lateral movement.

Specifications/ Dimensions:

Length: 200 cm
Min Length: 167 cm
Width: 431 cm
Height: 9 cm
Weight: 9 kg
Max Load: 165 kg (26 st)

SKU: AUD15
(Includes Straps)

Equipment

Covers

These durable stretcher covers will fit the entire range of removal stretchers offered by Dodge and are designed and manufactured to be durable, hard wearing and easily cleaned. They are intended to enhance the removal of the deceased by providing a dignified covering of the body and upper part of the stretcher, reducing any distress caused to family members, nursing home staff and residents as well as members of the public. Available in different fabrics and colours, these covers withstand frequent cleaning and heavy use.

Standard Covers

This soft polyester stretcher cover is completely elasticated, light weight and machine washable.

Colour Option:

Black & Maroon



SKU: AUD325



Cordura Covers

The fabric cover is a high quality and fully elasticated. The fabric cover is water resistant and machine washable.

Colour Option:

Black, Maroon, Navy & Green



SKU: AUD321



Corduroy Covers

The Corduroy cover is the highest quality cover available. Lined with a tear and water resistant material.

Colour Option:

Black, Maroon & Navy



SKU: AUD320



Fixed Height Coffin Bier

This fixed height coffin bier provides a stable and easy to move platform for coffins to rest on either in the chapel of rest after preparation or in the workshop while preparation procedures are completed. This bier is fitted with brakes for extra security.

Specifications/ Dimensions:

Length: 91 cm
Width: 48 cm
Height: 63.5 cm
Weight: 7.5 kg
Max Load: 200 kg (31 st)
4 x Braking 6" castors



Fixed Height Coffin Bier 6" Castors

SKU: AUD010

Fixed Height Coffin Bier 5" Castors

SKU: AUD016



Velveteen Bier Cover

The Velvet Bier Cover is a high quality cotton velvet cover. By adding the cover it quickly becomes a stylish viewing bier for use in the chapel.

Specifications/ Dimensions:

High quality cotton velvet covers to fit our bier.

Colour Options:

Purple, Maroon, Black, Navy & Green



SKU: AUD011



Velveteen Pall Cover

A high quality velvet pall available in several different colours. All finished with gold braid and trim. Intended to be slipped over the frame of the fixed bier to enhance its appearance when used in the chapel of rest.

Specifications/ Dimensions:

9ft x 4ft
Length: 274 cm
Width: 121cm

Colour Options:

Purple, Maroon, Black, Navy & Green



SKU: AUD012

Equipment



Hydraulic Body Hoist

Made from 12 gauge 1½" square steel tubing, with 4" braked castors, a robust hydraulic bottle jack and fully adjustable nylon straps with locking buckles, this hoist allows for safe and easy transfer of the deceased body from embalming table, fridge tray or removal stretcher to coffin or casket. Designed for ease of operation this unit can be operated by one person and eliminated manual handling in the embalming room or mortuary. The nylon straps can be easily washed and disinfected to ensure levels of hygiene are maintained.

Specifications/Dimensions:

Length: 40"

Width: 25"

Minimum Height: 20 5/8"

Maximum Height: 47"

Lift: 27 1/4"

Finish: White Epoxy Coating

Safe Working Load: 159 kg

SKU: TWI007



Universal Hydraulic Loader

Designed to assist in the safe loading and unloading of coffins, stretchers and body trays from vehicles, storage racks and refrigerators. With electronic controls this unit allows for lone working, without the risk of injury from manual handling.

Performance Highlights:

- 24 volt actuator with integral charger and push button switch, spare batteries and wall charger can be supplied separately.
- Manufactured in 1.5" square tube epoxy powder coated, cream colour.
- 6" Braked castors.
- 2" diameter grooved rubber roller, groove at 14" centres.
- Integral folding handle for moving.
- Safe working load 26 stone.
- CE Safety Certified.

Optional extras:

- Retainer for first call stretcher
- Spare batteries
- Wall charger

Specifications/Dimensions:

Length: 40"

Width: 25"

Minimum height: 20 5/8"

Maximum height: 47"

Lift 27 1/4"

SKU: TWI063

Cleaning Equipment

Mopping Systems



25 Litre Buffalo Bucket & Wringer

Made from hardwearing polypropylene with dirt retaining sump and unique curved shape to avoid spillage. Sturdy, effective handle-operated wringer. Available in 4 colours - blue, red, green and yellow.

SKU: 761225



Caution Wet Floor/Cleaning In Progress Sign

A great value double sided A frame sign to warn against potential hazards from wet floor surfaces during and after cleaning or spillages. Made from vivid yellow plastic with bright red/black graphics.

SKU: 761371



Abbey Handle & Plastic Kentucky Fitting

A lightweight aluminium handle with plastic fitting suitable for use with Kentucky mop heads. Available in four colours, plus white.

SKU: 761226



Kentucky Fitting

Plastic mop holder suitable for use with kentucky mop heads. Available in 5 colours - blue, red, yellow, green and grey.

SKU: 761227



Twine Scratchback Stayflat Kentucky Mop Head

450 g looped twine kentucky mops with an abrasive scratchback centre band for removing dirt whilst mopping. The stayflat band keeps the yarn flat on the floor, enabling the mop to cover a larger floor area, whilst the looped end yarn reduces linting and avoids the yarn tangling in use. Supplied colour - natural.

SKU: 761228

Cleaning Equipment

Battery, Wet & Dry Vacuum Cleaners

Valet Battery Upright II

A light weight, powerful, battery operated vacuum cleaner for quick and efficient cleaning when needed. This machine is ideal for quick cleaning of public areas, service chapels and chapels of rest between use. No cable reduces the risk of trips and falls, while the rechargeable lithium battery provides an impressive 50 minute run time between charges. This machines weighs only 5 kg and has a self adjusting floor head, battery condition indicator and easy to change dust bag.

SKU: TRU001	Replacement Bags SKU: TRU100 Pack of 10	Replacement/Second Battery SKU: TRU102 Each
-------------	---	---

Power WD 22 P

A small capacity, high performance wet/ dry vacuum cleaner, which is ideal for use in the embalming room, mortuary or garage. Supplied complete with wet and dry filters and a wide selection of accessories to tackle all cleaning tasks.

SKU: TLK128	Paper Filter Bags SKU: TLK129 Size: 7 litre Pack of 10
-------------	---

Power WD 36 P

A larger version of the Power WD 22P, this machine offers a larger capacity for cleaning in larger facilities. Supplied complete with wet and dry filters and a wide selection of accessories to tackle all cleaning tasks.

SKU: TLK132	Paper Filter Bags SKU: TLK133 Size: 16 litre Pack of 10
-------------	--

Power WD 80.2 P

The biggest wet/dry cleaner that we offer, the WD 80.2P is equipped with two suction motors, for the most arduous cleaning tasks to be undertaken in the biggest environments. This machine has a wet capacity of 56 litres, reducing the time spent emptying it when cleaning. This machine is supplied with both wet and dry filters as well as a full set of cleaning tools, allowing a wide range of cleaning tasks to be carried out.

SKU: TLK130	Paper Filter Bags with Cap SKU: TLK131 Size: 19 litre Pack of 10
-------------	---

For more information or to arrange an onsite demonstration, please contact our cleaning equipment specialist.



C
L
E
A
N
I
N
G

E
Q
U
I
P
M
E
N
T

Cleaning Equipment

Carpet & Steam Cleaners

Bissell BG10 Carpet Cleaner

The Bissell BG10 is the answer to cleaning large and small areas of carpet alike. With edge to edge suction, independent brush and suction motors and the Bissell Dirt Lifter power brush, the Bissell BG10 is the answer to any mess, big or small, and ensures that your carpets always look clean and brand new. Fitted with large capacity water tanks, the BG10 allows for long periods of cleaning between refills. The BG10 can clean in both forwards and backwards directions and can be supplied with an optional hose and hand tool for cleaning upholsteries if needed.

SKU: TLK006

Commercial Hose with Upholstery Tool

SKU: TLK012

Size: 10' long hose. 5.5" wide



Power Steam 6.3 ER I

With a run time of up to 4 hours between refills, and operating temperatures of up to 175 0°c the Power Steam 6.3 ER I offers an effective way of deep cleaning all surfaces and equipment within the embalming room and mortuary. Supplied with a full set of cleaning tools, this machine is ideal for cleaning walls, floors, drains and almost all equipment. The inbuilt vacuum system recovers all dirt and water, leaving surfaces hygienically clean and dry to the touch.

SKU: TLK127

For more information or to arrange an onsite demonstration, please contact our cleaning equipment specialist.



Power Extra 7 P

A powerful spray extraction cleaner for cleaning all types of hard and soft floor coverings as well as textile upholsteries. Supplied with large and small cleaning head, dual spray and extraction hose and extension tubes, this machine has a powerful pump and vacuum motor to ensure excellent results and fast drying times.

SKU: TLK009

Cleaning Equipment

Floor Scrubbing Machines

For deep cleaning of all types of hard floors, we are pleased to offer a range of traditional scrubbing machines.



SB 133

A compact model for applications that require superior, professional equipment, which is light weight and easy to handle. This machine is suitable for most cleaning duties and is well matched for scrubbing and stripping non slip floors. This machine features a strong induction motor and high transmission gear box for low noise levels in use and a long service life. Depending on floor type, it can be used with scrubbing brushes or floor pads.

SKU: TLK134



SB 143 L 10

With a working width of 430 mm, this machine is suitable for larger areas of floor. This machine has a perfect balance of motor weight, speed and size for all cleaning tasks and will excel when used for scrubbing or stripping on non slip flooring. This machine features a strong induction motor and high transmission gear box for low noise levels in use and a long service life. Depending on floor type, it can be used with scrubbing brushes or floor pads.

SKU: TLK135



For deep cleaning of non slip floors, we recommend the use of:

Prochem Ultrapac Renovate

SKU: 922209

Size: 5 litres

For more information or to arrange an onsite demonstration, please contact our cleaning equipment specialist.

Cleaning Equipment

Floor Scrubber Dryers

For facilities where floors need to be cleaned daily and in the least amount of time possible, we are pleased to provide a range of scrubber driers. These machines allow floors to be washed and dried at the same time. These machines have both clean and dirty water tanks which enhance hygiene levels and reduce time spent cleaning.



Rolly 7.5 E 33

Featuring a unique twin squeegee system, with variable brush pressure and a cylindrical brush, the Roller 7 1/2 E 33 cleans in all directions and offers superior cleaning and drying results on all types of hard floor. With separate clean and dirty water tanks and a capacity of 7.5 litres, the Rolly allows for large or small areas of floor to be cleaned and dried quickly and effectively. The machine is also very quiet, allowing for use at any time of the day. Supplied with 15 metres of cable, the machine covers a large area of floor and is simple to use. Its intuitive control panel reduces the need for training and helps all staff achieve professional results every time.

SKU: TLK125



Rolly 7.5 M 33 BC 20 AH

Offering all of the features of the Rolly 7.5 E 33 but as a battery powered unit. This machine boasts a two hour run time between charges, allowing for effective cleaning of large and small areas alike. The battery system reduces the risk of trips and falls and allows for floors to be clean and dry in one operation. These machines are very quiet in operation and suitable for use at any time of day. Its intuitive control reduces the need for training and helps staff achieve professional results every time.

SKU: TLK126



For deep cleaning of non slip floors, we recommend the use of:

Prochem Ultrapac Renovate

SKU: 922209

Size: 5 litres

For more information or to arrange an onsite demonstration, please contact our cleaning equipment specialist.

Cleaning Equipment

i-mop & Accessories



The i-mop is the result of 3 years research into floor cleaning machines! This new machine is truly amazing! it is like nothing else. No other machine can clean inside a toilet cubicle but the i-mop can. This is the first floor cleaning machine which offers the cleaning performance and speed of large ride on floor scrubbers whilst giving the flexibility of a flat mop. The i-mop can clean under beds and tables, clean right up to the edge of floors, and also clean inside washrooms and even toilet cubicles. This is the future of floor cleaning!

The 18 inch cleaning width which is equal to large 60 litre walk behind machines means you can clean large areas and small areas super fast. The patented system where the i-mop has no functional wheels in contact with the floor gives the machine a hovercraft feel, this is what gives the manoeuvrability. As there are no wheels taking the weight this means the brush pressure is 22 kg equal to large ride on machines resulting in the best floor cleaning results we have ever seen.

The i-mop weighs only 22 kg making it easy to carry upstairs or transport to other areas. When in the storage position the i-mop takes up minimal room in your cleaning cupboard. The brushes and squeegee can be changed in seconds to be cleaned or if you wish to have different sets for multiple areas. This really is a revolutionary cleaning machine and will change the cleaning industry as we know it.

SKU: TLK001

Includes: batteries, charger and standard blue scrubbing brushes.

For more information or to arrange a demonstration, please contact our cleaning equipment specialist.

i-mop Batteries

Left and right side battery, colour-coded, designed for simultaneous installation to the i-mop with its grey-coded counterpart. This powerful, lithium-ion battery benefits from over an hour of continuous use, from its quick one hour recharge function.



Left Battery - Blue
SKU: TLK013

Right Battery - Grey
SKU: TLK014

i-mop Standard Blue Medium Brush

This pair of teal-coloured medium scrubbing brushes, each with a 9" diameter, for a total working width of 18", is designed for use with the revolutionary i-mop. Powerful yet gentle, they are perfect for scrubbing hard floor surfaces.



SKU:
Pair

i-mop Red Hard Brush

Hard bristle brushes designed for use with the revolutionary i-mop scrubber-dryer. Measuring 9" in diameter, for a total working width of 18".



SKU: TLK015
Pair

i-mop Light Blue Soft Brush

Soft bristle brushes designed for use with the revolutionary i-mop scrubber-dryer. Measuring 9" in diameter, for a total working width of 18".



SKU: TLK020
Pair

i-mop Pads

These distinctive 9" floor pads, tough yet gentle, are designed for use with the i-mop scrubber dryer machine.



Black Pads
SKU: TLK016
Pack of 10

Green Pads
SKU: TLK017
Pack of 10

Red Pads
SKU: TLK018
Pack of 10

i-mop Complete Squeegee Assembly

Tough and sturdy i-mop Squeegee Assembly, for use with the i-mop - covers a total working width of 18".



SKU: TLK021

C
L
E
A
N
I
N
G

E
Q
U
I
P
M
E
N
T

Cleaning Equipment

Prochem Chemicals

Multi Pro

- Professional general purpose pre-spotter and traffic lane pre-spray for carpets.
- Excellent for draught marks and greasy areas.
- Apply by sprayer to all heavily soiled areas before machine cleaning.
- Turquoise blue liquid with citrus mint fragrance.

SKU: 922200
Size: 5 litre



Trafficlean

- Industrial strength high concentrate formula with extra water soluble solvents for grease removal.
- Pre-test for colour fastness and apply to all heavily soiled and greasy areas of carpet prior to extraction cleaning.
- Turquoise green liquid with mint fragrance.

SKU: 922201
Size: 5 litre



Extraclean

- Advanced micro-encapsulation extraction cleaner for carpets, rugs and upholstery.
- Anti-resoiling formula with odour neutraliser.
- WoolSafe approved maintenance product for wool carpets and rugs.
- Yellow green liquid with lemon breeze fragrance.

SKU: 922202
Size: 5 litre



Fresh Breeze Odour Neutraliser

- New technology odour neutraliser concentrate for carpets, fabrics and professional restoration cleaning.
- Can be diluted with water and applied by sprayer or added to cleaning solutions.
- Micro-encapsulation formula with odour absorber.
- Clear blue tinted liquid with fresh fragrance.

SKU: 922203
Size: 5 litre



Prespray Gold

- A high concentrate professional strength pre-spray cleaner for wool, wool-mix, stain resistant nylon and other pH sensitive, wet-cleanable carpets, rugs and upholstery fabrics.
- WoolSafe approved maintenance product for wool carpets and rugs.
- Amber liquid with floral lemon fragrance.

SKU: 922204
Size: 5 litre



Fibre & Fabric Rinse

- A professional acidic rinse agent or post spray for neutralising alkaline pre-sprays, stabilising colours and preventing browning.
- WoolSafe approved maintenance product for wool carpets and rugs.
- Prevents most colour bleed, yellowing and browning.
- Orange liquid with fresh orange peel fragrance.

SKU: 922205
Size: 5 litre



Contract Carpet Defoamer

- An economical anti-foam agent for carpet extraction machine recovery tanks.
- Off-white liquid with mild odour.

SKU: 922206
Size: 5 litre



Citrus Gel

- A citrus solvent and detergent based liquid gel spot remover for oil, grease, tar, gum and other oily spots on carpet and fabrics.
- Can be used safely on many spots and stains and is formulated to work on the fibre surface avoiding problems to latex and bitumen backings which commonly occur with other citrus based solvents.

SKU: 922207
Size: 1 litre



Solvex

- A water-rinseable, non-volatile blend of penetrating solvents and detergents for gloss and emulsion paints, nail polish, varnish and solvent soluble inks on carpets, fabrics and other surfaces.
- Clear solvent with aromatic odour.

SKU: 922208
Size: 1 litre



Equipment

Refrigeration Storage Cabinets



The Dodge purpose designed and high specification modular cabinets offer the ability to custom design your own specific configuration. Complete with all essential components and energy efficient cooling plant the cabinet provided a fully functional cold storage facility. Available in single or multi door formats and built to meet individual requirements.

Cabinet:

- Panels finished with anti bacterial silver ion finish.
- The 'Silverprotec' prevents transfer or harmful bacteria.
- High density 80 mm polyurethane insulation, CFC free.
- Total panel mechanical locked for perfect seals **(A)**.
- Hygiene panel design avoids need for silicone grouting.
- Finished in white powder coated steel RAL 90116.
- Panel cut edges are sealed to avoid corrosion.
- All panels (including floor) use corrosion resistant camlocks **(B)**.
- Cabinets can be readily disassembled for future transfer.
- Stainless floor covering over reinforced load bearing floor.
- Easy operated door lever with lock and internal release **(C)**.
- Door hinged to suit clients needs.
- Self closing adjustable door hinges giving up at 180° opening **(D)**.
- Magnetic PVC replaceable door gaskets.
- Gaskets rebated to prevent damage by tray withdrawal.
- Option for temperature gauge, switch, vent port and floor drain **(E,F)**.
- Wipe clean nameplates **(G)**.

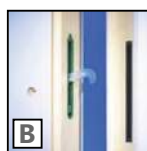
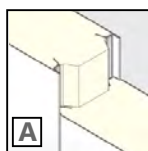

Cabinet:

- Stainless steel racking with simple height adjustment **(H)**.
- Open modular system for efficient cooling.
- Up to 5 tier storage using stub rollers for compact storage.
- Or full width (FW) PVC coated removable rollers.
- Range of stainless steel trays, both style and width options.
- Cabinet design allows coffin storage with FW rollers.

Options:

- Semi obese, obese or bariatric trays.
- Reduced height, side loading and pass through styles.
- Individual compartments, extra wide doors.
- Internal drainage, covered flooring, stainless steel finished.
- Door and wall protection.

Cooling:

- Choice of side, roof or remote cooling plant.
- Electronic control with digital display.
- Internal lighting and local alarm system.
- Environmentally friendly refrigerants.

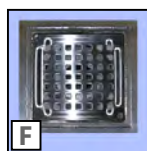

For more information, please contact our Capital Equipment Specialist.

Capital Equipment

Body & Coffin Storage Racking

Intended to offer the most flexible body storage system possible, this racking can be tailored to suit just about any application. Racks can be fitted with stub rollers that allow them only to accept the body storage trays, or full length rollers that allow coffins to be conveniently stored as well.

For larger facilities with cold rooms, the racking can be made to measure and a combination of regular, semi-obese and obese racks used in conjunction with storage trays of differing sizes to offer a complete solution for the safe keeping of the deceased. All racking, constructed of stainless steel box section, is easy to maintain and will provide years of trouble free service. For new installations cold rooms and fridges can be constructed with floor drainage to simplify cleaning procedures.



Body storage for smaller facilities can be an issue and for such locations, it may be possible to retro fit cooling equipment and utilise one or more mobile body racks to improve the environment in which the deceased is kept prior to the funeral taking place.

Mobile racking can be fitted with stub rollers for tray based storage of full length rollers to accommodate coffins as well.



Body Storage Trays

Available in differing widths these body trays can be fitted with or without drainage and offer a complete solution to the safe storage and preparation of the deceased. The tray can be used for storage, preparation, embalming or autopsy and if used with the multipurpose hydraulic trolley can eliminate lifting in the mortuary facility.

Pressed trays are available in a brushed satin finish and have 20 mm radiused perimeter for fluid control.

The fabricated trays have a shiplap perimeter, which is slightly creased to channel fluids to the drain where fitted.

Trays can be fitted with or without drainage, depending on the intended use.

For more information, please contact our Capital Equipment Specialist.

Equipment

Stacking Trolleys

The Dodge range of stacking trolleys are available with a choice of either manual or powered hydraulic pump. Designed for reliable mortuary operation Dodge Scissor action trolleys are fabricated using a fully welded 40mm chassis creating a robust and stable platform compatible with most fridge cabinets. Finished in battleship grey powder coat paint our textured finish is much more durable than a gloss or matt coat. These 5 tier trolleys are available with a variety of options to enhance their versatility.



Manual Pump Trolley - MSTM

The Dodge manual unit employs a high pressure hydraulic hand pump coupled to a heavy duty ram and fail safe valve. A local release handle allows control of the descent rate.

A new addition to this reliable trolley is an innovative tray retractor roller. This powered roller withdraws the body storage tray from the cabinet and also charges it into the cabinet after the patient has been transferred to the tray. This function is controlled by push buttons located on the handle.



Hydraulic Powered Unit - MSTP

Based on the same chassis but featuring an onboard single speed 12v battery powered hydraulic pump with push button operation. The pump motor and battery are fitted in a discrete steel housing under the chassis, keeping the trolley compact to work in smaller spaces. With voltmeter giving the battery condition, the compact wall mounted electronic low voltage charger plugs into the control box in plain sight avoiding user damage by moving the trolley when plugged in, also avoiding mains power within the trolley chassis, which can then be classed as a low voltage and intrinsically safe device. A tray tilt device can be added to either unit and offers a simple means to secure the tray handle and incline the tray for embalming/washing.

Typical Trolley Dimensions

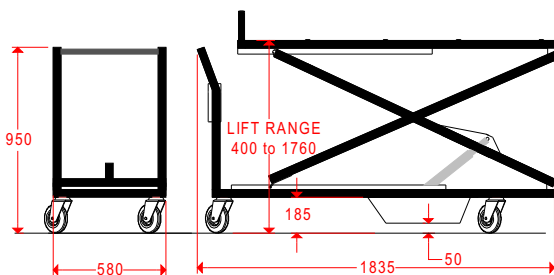

Bespoke Options:

- CL - Coffin roller lock.
- HD - Heavy duty version to 40 st (250 kg).
- EHD - Extra heavy duty to 65 st (415 kg).
- R - Rollers raised to coffin/grooved.
- ER - Extended reach/range options.
- DW - Digital weighing attachment.
- SL - Side loading adaption/ side mounted handle.
- T - Tray tilt plate.
- S - Stainless steel fabrication.



For more information, please contact our Capital Equipment Specialist.

C
A
P
I
T
A
L

E
Q
U
I
P
M
E
N
T

Ritual Washing Tables

Dodge is pleased to offer a range of ritual washing/preparation tables, that offer the user a choice of a simple fixed, mobile platform, through to a variable height trolley. Each table is designed for a specific application and incorporates a range of practical features to allow for trouble free, ease of use.

Fixed Height Wash Trolley

A fixed height trolley, which is built on a fully welded, stainless steel frame and mounted on 150 mm braked castors. The trolley is fitted with a semi-obese 660 mm fabricated tray and incorporates a nominal 50 mm fall, leading to the drain outlet.

Three perforated trays secure the one piece splash shield in place and offer practical water containment, without being obstructive in use. A lower shelf provides for convenient storage of a collection vessel to accept water from the drain, or for required equipment or sundries. This table can be used in conjunction with our range of foul sinks, or be supplied with flexible pipework, to allow connection directly to a waste drain.



Variable Height Wash Trolley

This stainless steel, variable height trolley is fitted with a one piece, stainless steel platform, featuring a deep profile worktop and under drainage.

A scissor lift action is used to enable the variable height function of this trolley and the table top can be raised or lowered to any convenient height at the push of a button. As with our other washing tables, a three piece, sectional, perforated worktop can be provide and drainage facilities can be adapted to suit the needs of the end user.

The trolley is designed to work in conjunction with our range of autopsy/ embalming sink units, to simplify disposal of table drainage and add the benefit of a thermostatically controlled, flexible wash hose.

Tilt Embalm/Prep Trolley

With a deep formed, profiled perimeter to the worktop, this unit is designed specifically to provide a variable tilt platform.

A simple push button controls the electric actuator which lifts one end of the table up to an incline of 300 mm.

To ensure even drainage during use, the worktop can be fitted with a sectional, perforated worktop and drain outlets can be provided centrally, or at one end, either leading to a hook and bucket for collection or permanently connected to waste pipework.



For more information, please contact our Capital Equipment Specialist.

Equipment

Combination Trolley

This innovative, dual purpose stainless steel trolley performs exactly as a traditional stacking trolley, but also functions as a height adjustable, stable, autopsy or embalming platform, with one person operation. Useful in confined areas, it avoids the need for additional transfer equipment and helps to reduce lifting and body handling in all facilities.



Typical Trolley Dimensions

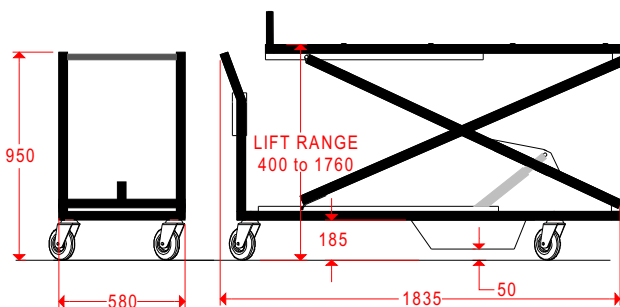

Bespoke Options:

- L - Coffin roller lock.
- HD - Heavy duty version to 256 kg, 40 st SWL.
- EHD - Extra heavy duty to 65 st (415 kg).
- FR - Choice of flat or coffin rollers.
- WD - Weighing device.

Combination Trolley - MSTC

Using the same tray for the storage, procedures and preparation, the 'one-tray' concept is designed to greatly reduce and even eliminate the need for body transfer and arduous lifting in the mortuary, autopsy room, funeral home and embalming room.

Although some will prefer the traditional methods, employing the 'one-tray' concept, reduces the floor space required and at the same time enables one person operation and obviates the need for separate autopsy or embalming tables.

Once a body storage tray is loaded, it can then be secured on the handle at a predetermined height and then the tray can be tilted using the push button up/down mechanism to provide any desired gradient.

Our unique feature is an optional automatic tray lift, which collects the tray handle and lifts it by 150 mm at the push of a button. This allows for variable tilt with the upper frame adjustable to any operator height.

Featuring an on board single speed 12 v battery powered hydraulic pump operated with push button precision. The pump and battery are fitted in a discreet stainless steel housing with a volt metre mounted on the front giving battery condition.

Battery condition can be monitored with the visible on board indicator. Once connected, the remote electronic battery charger ensures automatic charging. In the event of a battery failure, a 240 v connector provided enables short term use.

With a fully welded stainless steel fabrication, providing a wide and stable platform, the design is intended for use with our range of autopsy and embalming foul sinks, and can be manufactured with some useful options to extend and enhance its versatility in a busy facility.

Performance Highlights:

- Rated to 180 kg, 28 st SWL. 400 mm to 1760 mm standard lift range.
- Fully welded 304 grade stainless steel construction.
- Electrically powered twin heavy duty rams.
- 4 no 125 mm castors, 2 braked with edge buffers.
- PVC coated rollers with raised section for coffin handling.

For more information, please contact our Capital Equipment Specialist.

Capital Equipment

Autopsy & Embalming Trolleys

Dodge is pleased to be able to provide a range of autopsy/embalming trolleys, that offer the user a choice of styles, suited to their operation. Employing a similar robust fabrication, each model is designed for its specific application, whilst allowing the end user an element of customisation.

Fixed Top Trolley - MSGW

A conventional fixed height trolley, built on a fully welded and rigid stainless steel frame, fitted with either a fabricated or pressed (crevice free) work top. These tables are designed to operate in conjunction with our sinks.

Mounted on 125 mm castors, the trolley's are usually built with a nominal fall to a drain point, or can be provided as a level surface (without a drain) for use as a dressing/examination table. Optional body supports are available for all units (B).

The standard 660 mm width provides a useful and convenient size, but can be increased for obese and bariatric requirements. The fabricated worktops allow for a choice of perimeter or edge profiles with depths from 30 to 80 mm deep (A). Body supports for tray tops are available (C) or a 3 piece perforated top that can lift out (D).

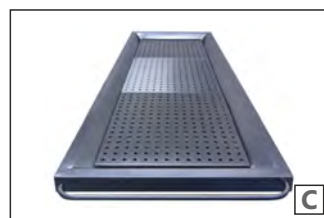
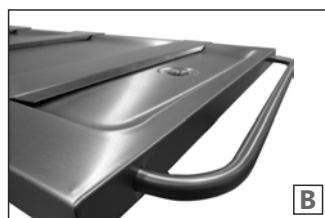
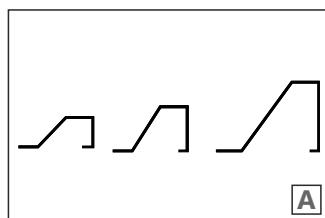

Portable Table - MSGP

Fitted with a drain and an inbuilt fall, this collapsible table offers a convenient and portable solution for embalming or autopsy, which folds down for transport and/or storage.

The centre rail is secured to the hinged legs with four hand wheels, to form a rigid and wobble free platform. These wheels are also used when collapsed to secure the hinged legs in place. Available with a wall bracket for handy storage when not in use.

Roll On/Roll Off Trolley - MSGR

This simple stainless trolley is fitted with four, full width, pvc easy clean rollers and is designed to accept a fridge tray from both ends using a simple lateral transfer.

Once the tray is loaded on the upper frame the dual purpose handle/tilt is simply pushed down (E) lifting and inducing the fall necessary for drainage over a suitable sink.

A multi purpose trolley with uses as a bier, embalming dressing or viewing trolley.

Bespoke Options:

- Tubular or square sectional steel.
- Perforated tops - body supports.
- Hinged platform - splash guards.
- Electric. Screw or hydraulic lift operation.
- Various platform widths and depth profiles.
- Casters, drainage and wall brackets.



For more information, please contact our Capital Equipment Specialist.

Equipment

Sinks & Sluices

The embalming room should be considered as one of the most important rooms in the funeral home. The successful preparation of the deceased human body brings comfort to the families of those you serve and a well equipped and comfortable embalming room assists you in performing your embalming's and preparations.

Over time we have forged strong working relationships with manufactures of mortuary and embalming room fixtures and fittings, to allow us to offer a comprehensive range of items to our clients. Whatever your needs, we can help. From individual items to enhance your existing embalming rooms or mortuaries to complete refurbishments, put our experience to work for you.



Embalming Sinks

These sinks allow for an embalming table or fridge tray with drainage to be parked over the lower sink, where any fluid is directed into the foul sewer. These sinks provide hot and cold water to the embalming tray or table via a flexible hose and mixer tap for washing procedures or for filling the embalming machine or pressure tank. The upper sink provides for washing and cleaning of equipment and even holding the bagged viscera of an autopsied case while arterial injection takes place. They are simple to maintain and help to improve hygiene standards by removing the need to capture table waste in a bucket, prior to disposal and when used in conjunction with tray transfer equipment help to reduce manual handling of the deceased in the funeral home or mortuary.

For smaller facilities where space is at a premium, a single, foul sink is available which hangs from the wall of the embalming room or mortuary and allows for the table to connect. This unit is fitted with a flexible spray hose and mixer tap.

Single Embalming Sink

SKU: 410205

Double Embalming Sink

SKU: 410200



Sluice

For fast and efficient disposal of liquid waste generated during the embalming, autopsy or cleaning procedure. Aspiration jars and buckets are simply emptied into the hopper before depressing the flush handle. The stainless steel hoppers allow for easy and simply cleaning and disinfecting and grates can be supplied to rest jars or buckets on. If an electric aspirator is used, the discharge hose can be placed directly into the sluice hopper for simple hygienic operation during the embalming process.

SKU: 410201

For more information, please contact our Capital Equipment Specialist.

C
A
P
I
T
A
L

E
Q
U
I
P
M
E
N
T

Capital Equipment

Combination Sink/Sluice Unit

An elegant solution for the cost conscious funeral home looking to improve existing facilities while at the same time being mindful of available space. This unit combines a sluice hopper and cistern, upper sink and work bench/draining area, mixer tap, spray hose with thermostatic mixer and lower foul sink to catch drainage from the embalming table or body tray. Provision is made for all cleaning and disinfection procedures as well as disposal of liquid wastes generated throughout the embalming process.



This all purpose unit is available as shown, and the upper sink, foul sink and sluice hopper can be fitted on the left or right of the unit, at no additional cost, to suit either an existing room layout or the needs and wishes of the end user.

Alternatively, this unit can be made as a completely bespoke item, and the width of the unit can be extended or reduced to suit available space. The sluice hopper can be relocated as needed or removed completely and the upper work station can be changed to provide more workspace, to accommodate embalming or autopsy equipment.

For embalming use, this unit can be supplied with shelving or under counter storage cupboards for chemicals and sundries. For autopsy use, the upper work surface can be fabricated to form an integral dissection area, with linear ventilation. The lower foul sink is designed to work in conjunction with both mobile embalming and autopsy tables as well as the 'one-tray' body handling system and can be fitted with a coarse strainer basket, to catch drain blocking wastes, or a commercial macerator unit, which will help to prevent blocked or clogged drains from table wastes. The wash hose is supplied in a 3 meter length as standard, but we are able to offer longer lengths of hose, to suit individual requirements.

SKU: MOR014

For more information, please contact our Capital Equipment Specialist.

Dodge UK

Units 11/14-15 Ardglen Industrial Estate, Whitchurch,
Hampshire, RG28 7BB, UK

www.dodge-uk.com

+44 (0)125 6893 883

Freephone: +44 (0)800 8815 654

enquiries@dodge-uk.com

Dodge Medenta Product GmbH

Huckrieden Esch 9

49549 Münster

Germany

www.medenta.de

info@medenta.de

Dodge Australia Pty Ltd

29 Governor Macquarie Drive,
Unit 5, Chipping Norton 2170, NSW

www.dodgeco.com.au

+61 (0)2 8214 4655

Freephone: +61 (1)8 0050 6796

info@dodgeco.com.au

Dodge Representative:

Contact Number:

Customer Number: