



THE FORD METER BOX COMPANY, INC.
CERTIFIED TO ISO 9001:2015
10004466

Section G

Ford® Curb Stops and Meter Valves



Contents

	PAGE
Information	
Secura-Lok™ Locking Valves	3
Product Numbering System	4
Features of Ball Valves	5
Options Available.	6
Ford Ball Valve Curb Stops	
Ball Valves for Iron Pipe or Flared Copper	7 - 9
Ball Valves with Pack Joints	10 - 14
'BH' Ball Valves.	15
Ford Inverted Key Curb Stops	
Features of the Ford Inverted Key Valve.	16
Curb Stops for Iron Pipe and Flared Copper.	16 & 17
Curb Stops with Pack Joints for Plastic or Copper Tubing	18 & 19
Ford Straight Meter Valves	
Straight Ball Meter Valves	20 & 21
1-1/2" and 2" Straight Ball Meter Valves	22 & 23
Straight Compression Globe Meter Valves	23
Ford Angle Valves	
Angle Ball Meter Valves	24
Padlock Wings on Valves	24
1-1/2" and 2" Flanged Angle Ball Meter Valves.	25
Blow-Off Ball Valves	25
Angle Compression Globe Meter Valves.	26
Angle Inverted Key Meter Valves	26
1-1/2" and 2" Flanged Key Meter Valves.	27
Branch Valve Assemblies	
Key Valve Branch Valve Assemblies.	28 & 29
Ball Valve Branch Valve Assemblies.	30 & 31
Service Valves	
5/8" Ball Valves	31 - 33
5/8" Ball Service Valves with Drain	33
Straight and Angle Compression Globe Service Valves	34
Angle Inverted Key Service Valves	35
Angle Ball Service Valves	36
Options Available	
Handles Available for the Complete Line of Ford Valves	37 & 38
Ball Valve Lock Caps.	38
2" Gate Valve Operating Nut	38
Key Valve Lock Caps	38
Pack Joint Connections.	39
Types of Plastic Pipe and Tubing	39
Dimensions Comparison Table for Plastic, Copper and Galvanized Iron	39
Insert Stiffeners	39
Warranty	41

Ford offers many products that are classified to ANSI/NSF Standard 61. To verify if a product is classified to ANSI/NSF Standard 61, contact the Ford Meter Box Customer Service Department at 260-563-3171 or visit fordmeterbox.com. Ford Meter Box meets your need for ANSI/NSF Standard 61 approved items with products that are proven and reliable.

Due to design improvements, product images in the catalog do not always reflect the most current design detail.

Ford Meter Box no-lead brass products manufactured from UNS/CDA No. 89833 alloy shall contain no more than 0.25% total lead content by weight. United States federal and state laws allow the use of products manufactured from UNS C83600 85-5-5-5 brass alloy for only non-potable water systems within the United States.

Parties responsible for monitoring and maintaining proper water system design must exercise full responsibility in understanding and upholding the full intent and scope of applicable lead laws.

Ford, Ford Meter Box and Uni-Flange are trademarks of The Ford Meter Box Company, Inc. registered in the U.S.

Secura-Lok™ Locking Valves

(Patent 10,794,514)

The Secura-Lok™ is a patented design that incorporates an integral locking mechanism on Ford Ball Valves. You can lock your valve in the open, closed, or operational position.

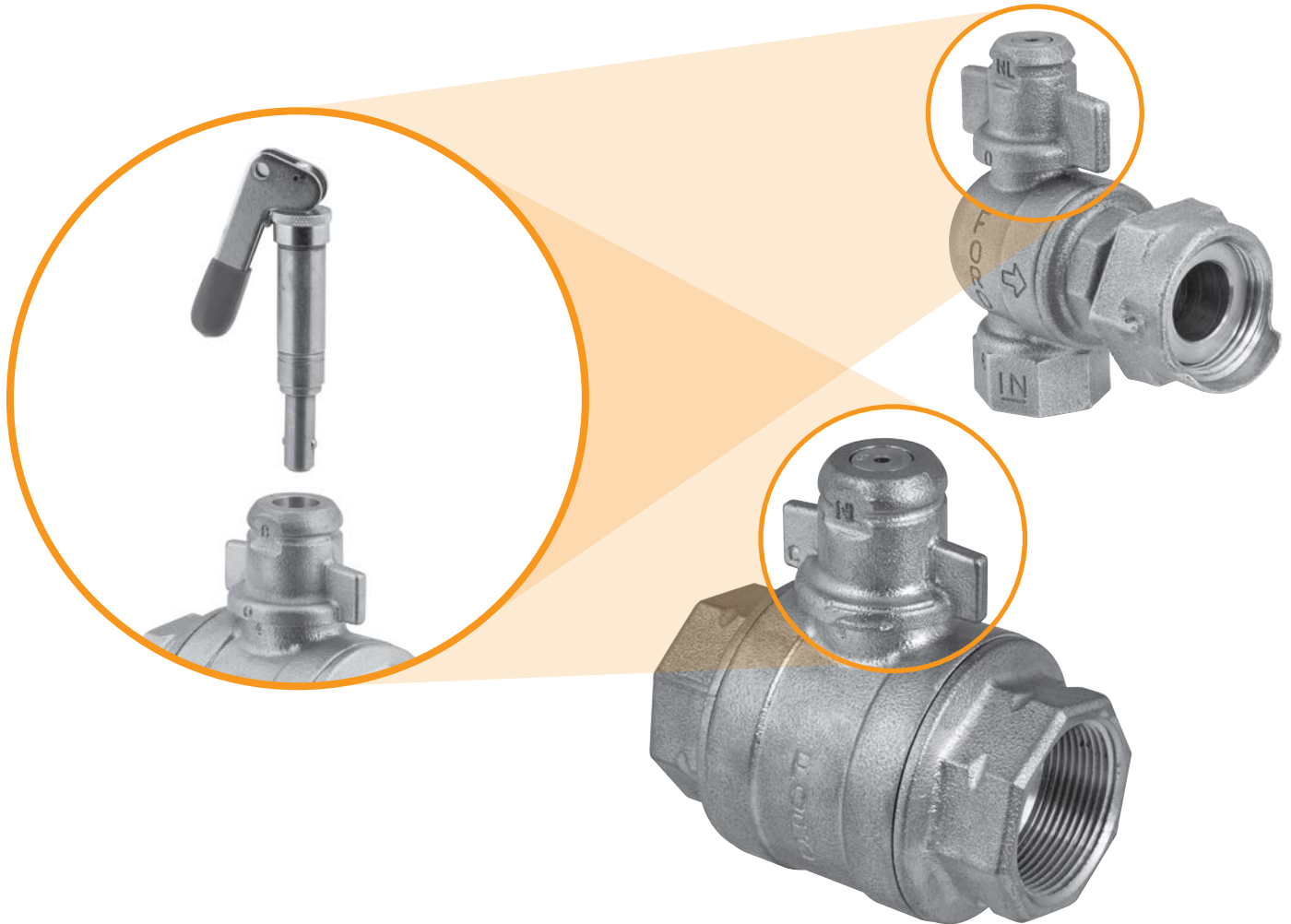

How to Order Secura-Lok

Ford Secura-Lok™ valves feature two types of integral locking tee-heads to secure a valve in the desired setting. Secura-Lok is available on 5/8" – 2" straight ball valves and 5/8" – 1", and 2" angle ball valves. To order, add the appropriate code to the catalog number.

To Order Secura-Lok Valves:

PART NUMBERCODE	DESCRIPTION	EXAMPLE
-SLB*	Barrel-style Secura-Lok for straight 5/8" – 2" and 5/8" – 1", and 2" angle ball valves	B11-777SLB-NL BA13-332SLB-NL
-SLC	Cap-style lock for straight 5/8" – 1" ball valves	B11-444SLC-NL

* 5/8"–1" valves use a custom barrel lock and require KEY-234-SLB. 1-1/2"–2" valves require KEY-567-SLB for operation.

Secura-Lok Options and Accessories

CATALOG NUMBER	DESCRIPTION
CRIMPTOOL-SLC	Crimp Tool for Seal Cap
CAP-234-SLC	Protective Lock Cap Seal
KEY-567-SLB	Barrel Lock Key (1-1/2"–2" straight valves)
KEY-234-SLB**	Barrel Lock Key (5/8"–1" angle valves)
KEY-234-SLC	Lockcap Key (5/8"–1" straight valves)
PLUG-234-SLB	Plastic Protective Barrel Lock Plug (5/8"–1")
PLUG-567-SLB	Plastic Protective Barrel Lock Plug (1-1/2"–2")

** KEY-234-SLB is required to operate any 5/8"–1" barrel lock valves.

CATALOG SECTION G NUMBERING SYSTEM

TYPE OF VALVE

- AV = Angle Key Yoke Valve or Service Valve
- B = Ball Valve
- BA = Angle Ball Valve
- BF = Flanged Ball Valve
- BFA = Flanged Angle Ball Valve
- BL = Ball Valve (long)
- BLA = Blow-Off Ball Valve
- BH = 5/8" Ball Valve with a Heavy Tee-Head
- BRW = Reclaimed Water Tee-Head
- FV = Flanged Angle Key Valve
- KV = Angle Key Meter Valve
- SG = Straight Compression Valve
- SV = Straight Key Valve
- UV = Branch Key Valve Assembly
- UAV = Angle Branch Key Valve Assembly
- UVB = Branch Ball Valve Assembly
- UAVB = Angle Branch Ball Valve Assembly
- UVZS = Branch Key Curb Stop Assembly
 - Z = Curb Stop (standard)
 - ZL = Curb Stop (long)
 - ZS = Curb Stop (short)
 - ZX = 1/2" Curb Stop (plug style)

VALVE SIZE

- 1 = 1/2"
- 2 = 5/8"
- 3 = 3/4"
- 4 = 1"
- 5 = 1-1/4"
- 6 = 1-1/2"
- 7 = 2"

SIZE OF INLETS - OUTLETS

(one end - other end)

- 1 = 1/2" (or 5/8" meter nut)
- 2 = 5/8" (or 5/8" x 3/4" and 3/4" meter nut)
- 3 = 3/4"
- 4 = 1"
- 5 = 1-1/4"
- 6 = 1-1/2"
- 7 = 2"
- 8 = 2-1/2"

METER NUTS

- 1 = 5/8"
- 2 = 5/8" x 3/4" and 3/4"
- 4 = 1"

METER FLANGES

- 6 = 1-1/2"
- 7 = 2"

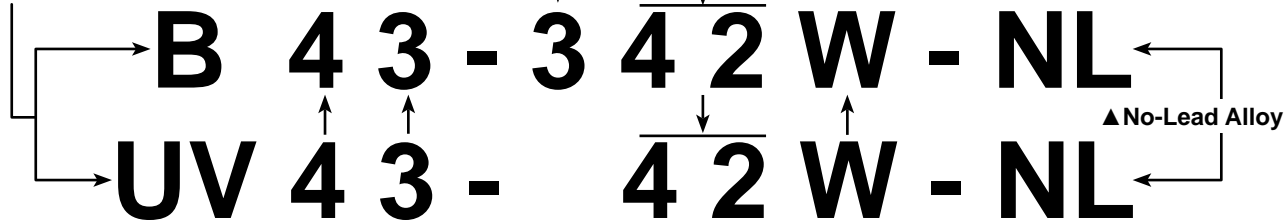

▲ No-Lead Alloy

TYPE OF INLETS - OUTLETS

(one end - other end)

- 1 = Female Iron Pipe Threads
- 2 = Flare Copper Tube Nut
- 3 = Meter Nut or Flange
- 4 = Pack Joint for Plastic or Copper Tube (CTS)
- 5 = Pack Joint for Iron Pipe
- 6 = Pack Joint for PE Pipe
- 7 = Pack Joint for PVC Pipe (Schedule 40 and 80)
- 8 = Male Iron Pipe Threads
- 9 = Yoke Nose
- 0 = Female Copper Tube Nut Thread or 'Special'

OPTIONAL FEATURES

- D = Test/Drain Valve
- G = Grip Joint (for 3/4" - 2" CTS and 3/4" and 1" PEP)
- IDR7 = Inner Dimension Ratio for 1-1/2" and 2" PE Pipe
- M = Minneapolis Pattern
- NE = New England Threads
- OR = Open Right
- Q = Quick Joint
- R = 360° Tee-head Rotation
- SW = Stop and Waste
- TW-Q = CTS Quick Joint with Tracer Wire Terminal
- U-AWT = Ultra-Tite (components assembled watertight)
- W = Padlock Wing

▲ Ford Meter Box no-lead brass products manufactured from UNS/CDA No. 89833 alloy shall contain no more than 0.25% total lead content by weight. United States federal and state laws allow the use of products manufactured from UNS C83600 85-5-5-5 brass alloy for only non-potable water systems within the United States.

Parties responsible for monitoring and maintaining proper water system design must exercise full responsibility in understanding and upholding the full intent and scope of applicable lead laws.

Note: See item listings in catalog section to assure that desired sizes and options are available.

Please Note:

Consult the Ford Meter Box Company, Inc. website (www.fordmeterbox.com) for the most recent catalog information. The Ford Meter Box Company considers the information in this catalog to be correct at the time of publication. Items and option availability, including specifications, are subject to change without notice. Please verify that your product information is current.

Information

Features of the Ford Ball Valve

Ford Ball Valve Curb Stops are ideal for use in water service lines. Watertight in either direction at pressures up to 300 psi, easy turning, nonbinding, and minimum pressure loss — these characteristics are added to superb design, quality, and precise manufacturing.

Standard Ford Ball Valve

Ford Ball Valves are designed to withstand working pressures up to **300 psi**.

Stop-and-Waste Ball Valves are rated to 150 psi

Variety of end connections available — for copper, iron, plastic, or direct to meter. Ends are integral or secured with adhesive to prevent unintentional disassembly

A bronze or plastic ring locks the stem solidly into the body of the valve

Solid one piece tee-head and stem

Sturdy stops allow 90° motion and are enclosed and protected

EPDM O-rings in the stem ensure permanent watertight seal at top

Stainless steel reinforcing ring molded into seats

Molded EPDM seat(s) support the ball. Valve is watertight and is a non-directional valve

*Heavy cast brass body is engineered to withstand pipe stresses

Fluorocarbon-coated brass ball provides maximum flow capacity and ease of turning

* All Ford Meter Box brass conforms to AWWA Standard C800 (UNS No. C89833 - no-lead alloy — ASTM B62 and ASTM B584).

PRESSURE REQUIREMENTS

The AWWA Standard C800 specifies normal pressure service line valves shall be suitable for use with water at 100 psi for 1" and smaller sizes, and 80 Psi for 1-1/4" through 2" sizes. Ford Key Style Valves are designed for normal service line pressure conditions. Use Ford Ball Valves for higher pressure requirements.

NOTE: Flange Inverted Key Angle Valves should not be used as customer shut-off on the customer side of the meter.

Information

Features of the Ford Ball Valve

COMPRESSION OPTIONS

Pack Joint Nut



Grip Joint Nut



Quick Joint Nut



Ultra-Tite



Padlock Wings

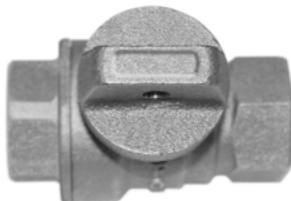

360° Tee-head Rotation



Reclaimed Water Tee-head



Valve Lock Caps



Gate Valve Operating Nut



Minneapolis Pattern Valve



Stop and Waste Feature

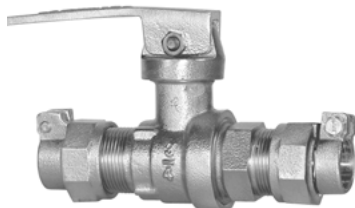

Handles for Valves



Drain/Test Valve Option



Tracer Wire Terminal

Options Available

ALL TYPES OF CONNECTIONS

Ford Curb Stops and Meter Valves are available with a wide variety of connections. Make your selection from compression, flare, female or male style fittings for copper, iron, polyethylene, PVC and lead.

- **Pack Joint** is the standard offering for all compression fittings. Other options may be available. See below for details
- **Grip Joint instead of Pack Joint for CTS** (for all sizes) or **PEP** (3/4" or 1") can be ordered by adding "-G" to the catalog number. Example: B41-333-G-NL
- **Quick Joint** is available for items indicated with a ♦. Add a "-Q" to the catalog number. Example: B41-333-Q-NL
- **Ultra-Tite** is available for items indicated with a ►, add "-U-AWT" to the catalog number. Example: B44-334-U-AWT-NL. For items indicated with a *, add "-U" to the catalog number. Example: B41-343-NL

PADLOCK WINGS

Most valves are available with padlock wings (except for Minneapolis Valve or where noted). Add "W" to catalog number. Example: B11-333W-NL. "W" in a listed catalog number indicates that the valve is available with padlock wings only.

360° TEE-HEAD ROTATION

Standard tee-head stops on the body to permit 90° turn *only*. Full 360° tee-head rotation is available. Add "R" to catalog number. Example: B21-333R-NL.

RECLAIMED WATER BALL VALVE TEE-HEAD

A distinctive tee-head with "Reclaimed Water" lettering for easy identification is available on 5/8" through 2" Ball Valves. Insert "RW" into the catalog number. Example: BRW11-333W-NL. Tee-head sold only with padlock wings.

VALVE LOCK CAPS

Lock caps are available for 5/8" through 2" Ball Valves and 3/4" Angle Key Valves. See page 38 to order.

2" GATE VALVE OPERATING NUT

Adapts tee-head on 1-1/4", 1-1/2" and 2" Ball Valves (listed on pages 6 - 13) for operation with standard gate valve wrenches. See page 38 to order.

MINNEAPOLIS PATTERN VALVE

Threads are available around the valve body in order to attach Minneapolis style curb boxes. 3/4" and 1" valves have 1-1/2" threads; 1-1/4", 1-1/2" and 2" valves have 2" threads. If an additional size is required other than the sizes listed, please contact the factory for availability.

STOP-AND-WASTE FEATURE

Stop-and-waste valves allow the downstream service line to drain when in the closed position. This feature is typically used to avoid damage to the service line caused by freezing. See catalog listing for details and availability.

HANDLES FOR VALVES

Handles for valves are available. Ordering information and descriptions are found on pages 37 and 38.

DRAIN/TEST VALVE OPTION

For Ford Ball Service Valves. See page 33.

TRACER WIRE TERMINAL

Available on 3/4", 1", 1-1/4", 1-1/2" and 2" CTS Quick Joint Nuts, add "-TW-Q" to the catalog number.

Ford Ball Valve Curb Stops

Ball Valves with Iron Pipe Threads

B11-333-NL



Female Iron Pipe Threads Both Ends

CATALOG NUMBER	VALVE SIZE	INLET SIZE	OUTLET SIZE	APPROX. WT. LBS.
*B11-333-NL	3/4"	3/4"	3/4"	1.5
B11-343-NL	3/4"	1"	3/4"	1.6
B11-344-NL	3/4"	1"	1"	1.7
BL11-344-4-5-NL	3/4"	1"	1"	2.2
*B11-444-NL	1"	1"	1"	2.0
B11-454-NL	1"	1-1/4"	1"	2.0
B11-455-NL	1"	1-1/4"	1-1/4"	2.1
B11-555-NL	1-1/4"	1-1/4"	1-1/4"	4.0
B11-566-NL	1-1/4"	1-1/2"	1-1/2"	4.3
**B11-666-NL	1-1/2"	1-1/2"	1-1/2"	4.7
**B11-676-NL	1-1/2"	2"	1-1/2"	5.0
**B11-677-NL	1-1/2"	2"	2"	5.3
*B11-777-NL	2"	2"	2"	7.1
B11-788-NL	2"	2-1/2"	2-1/2"	8.3

B11-333M-NL

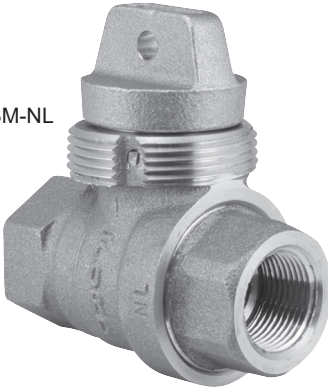

Female Iron Pipe Threads Both Ends Minneapolis Pattern Valve

CATALOG NUMBER	VALVE SIZE	INLET SIZE	OUTLET SIZE	APPROX. WT. LBS.
*B11-333M-NL	3/4"	3/4"	3/4"	1.8
B11-343M-NL	3/4"	1"	3/4"	2.0
*B11-444M-NL	1"	1"	1"	2.4
B11-455M-NL	1"	1-1/4"	1-1/4"	2.5
B11-555M-NL	1-1/4"	1-1/4"	1-1/4"	4.4
**B11-666M-NL	1-1/2"	1-1/2"	1-1/2"	5.7
B11-676M-NL	1-1/2"	2"	1-1/2"	6.2
B11-677M-NL	1-1/2"	2"	2"	6.5
**B11-777M-NL	2"	2"	2"	8.6
B11-788M-NL	2"	2-1/2"	2-1/2"	10.0

B81-777-NL



Male Iron Pipe Thread by Female Iron Pipe Thread

CATALOG NUMBER	VALVE SIZE	MIP END	FIP END	APPROX. WT. LBS.
B81-333-NL	3/4"	3/4"	3/4"	1.6
B81-343-NL	3/4"	1"	3/4"	1.9
B81-444-NL	1"	1"	1"	2.6
B81-455-NL	1"	1-1/4"	1-1/4"	3.0
**B81-666-NL	1-1/2"	1-1/2"	1-1/2"	5.0
B81-676-NL	1-1/2"	2"	1-1/2"	5.3
B81-677-NL	1-1/2"	2"	2"	7.6
*B81-777-NL	2"	2"	2"	9.2

B88-333-NL



Male Iron Pipe Thread Both Ends

CATALOG NUMBER	VALVE SIZE	INLET SIZE	OUTLET SIZE	APPROX. WT. LBS.
B88-333-NL	3/4"	3/4"	3/4"	2.0
B88-344-NL	3/4"	1"	1"	2.1
B88-444-NL	1"	1"	1"	3.1
B88-454W-NL	1"	1-1/4"	1"	2.2
B88-455W-NL	1"	1-1/4"	1-1/4"	2.3
B88-666W-NL	1-1/2"	1-1/2"	1-1/2"	5.7
B88-777-NL	2"	2"	2"	8.1

Options available - See bottom of page 8.

Ford Ball Valve Curb Stops

Ball Valves with Iron Pipe and Flared Copper Ends

B21-333-NL

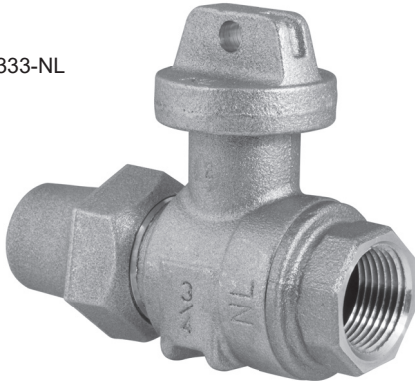

Flare Copper by Female Iron Pipe Threads

CATALOG NUMBER	VALVE SIZE	FLARE END	FIP END	APPROX. Wt. LBS.
*B21-333-NL	3/4"	3/4"	3/4"	2.2
BL21-333-4-5-NL	3/4"	3/4"	3/4"	2.7
B21-343-NL	3/4"	1"	3/4"	2.6
B21-334-NL	3/4"	3/4"	1"	2.5
B21-344-NL	3/4"	1"	1"	2.8
BL21-344-5-187-NL	3/4"	1"	1"	3.2
*B21-444-NL	1"	1"	1"	3.3
B21-445-NL	1"	1"	1-1/4"	4.5
B21-455-NL	1"	1-1/4"	1-1/4"	4.7
B21-555-NL	1-1/4"	1-1/4"	1-1/4"	5.9
B21-566-NL	1-1/4"	1-1/2"	1-1/2"	6.9
**B21-666-NL	1-1/2"	1-1/2"	1-1/2"	7.8
B21-667-NL	1-1/2"	1-1/2"	2"	8.2
B21-676-NL	1-1/2"	2"	1-1/2"	10.9
B21-677-NL	1-1/2"	2"	2"	11.6
*B21-777-NL	2"	2"	2"	12.4

B21-333M-NL

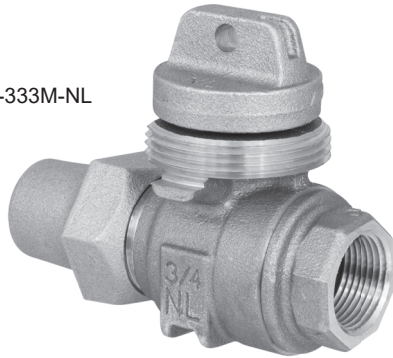

Flare Copper by Female Iron Pipe Threads Minneapolis Pattern Valve

CATALOG NUMBER	VALVE SIZE	FLARE END	FIP END	APPROX. Wt. LBS.
*B21-333M-NL	3/4"	3/4"	3/4"	2.8
*B21-444M-NL	1"	1"	1"	3.6
B21-455M-NL	1"	1-1/4"	1-1/4"	5.0
B21-555M-NL	1-1/4"	1-1/4"	1-1/4"	6.2
**B21-666M-NL	1-1/2"	1-1/2"	1-1/2"	9.2
**B21-676M-NL	1-1/2"	2"	1-1/2"	11.5
**B21-777M-NL	2"	2"	2"	13.4

B82-333-NL

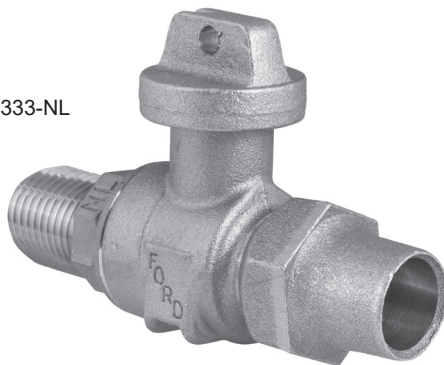

Male Iron Pipe Thread by Flare Copper

CATALOG NUMBER	VALVE SIZE	MIP END	FLARE END	APPROX. Wt. LBS.
B82-333-NL	3/4"	3/4"	3/4"	2.0
B82-444-NL	1"	1"	1"	3.1
B82-555-NL	1-1/4"	1-1/4"	1-1/4"	6.0
B82-666-NL	1-1/2"	1-1/2"	1-1/2"	9.0
B82-777-NL	2"	2"	2"	13.6

Options Available

* For **Stop-and-Waste** feature on these 3/4", 1" and 2" ball valves, change "B" to "BC" and add "SW" to the catalog number.

Example: BC21-333SW-NL.

** **Stop-and-Waste feature** is available for 1-1/2" ball valves. Add "SW" to the catalog number. Examples: B21-666SWM-NL.

Reclaimed Water Tee-head is available. Insert "RW" into the catalog number. Example: BRW21-333W-NL. Tee-head sold only with padlock wing.

Padlock Wings - All valves are available with padlock wings (except for Minneapolis pattern valve). Add "W" to catalog number.

Standard tee-head stops on the body to permit 90° turn *only*. **Full 360° tee-head rotation** is available. Add "R" to catalog number.

Example: B21-333R-NL.

Curb Box Base - Catalog number CB-7 for 1-1/4", 1-1/2" and 2" ball valve curb stops is listed in catalog section GA.

2" Gate Valve Operating Nut is available for 1-1/4", 1-1/2" and 2" ball valves and can be ordered from page 38.

Lock Caps are available for 5/8" through 2" ball valves and can be ordered from page 38.

Handles are available for ball valves; see page 37.

Minneapolis Pattern Valves are available in a variety of sizes. For sizes other than those in the above tables, please contact the factory.

Ford Ball Valve Curb Stops

Ball Valves with Flared Copper

B22-333W-NL

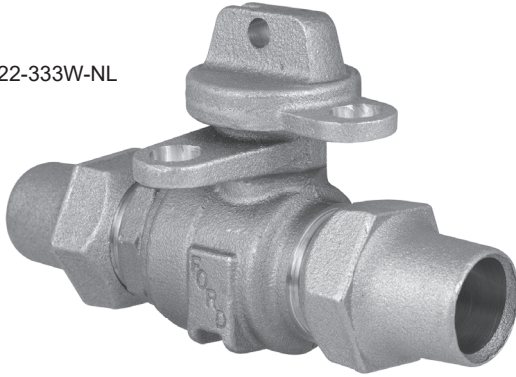

Flare Copper Both Ends

CATALOG NUMBER	VALVE SIZE	INLET SIZE	OUTLET SIZE	APPROX. WT. LBS.
*B22-333-NL	3/4"	3/4"	3/4"	2.5
B22-343-NL	3/4"	1"	3/4"	2.8
B22-344-NL	3/4"	1"	1"	3.8
*B22-444-NL	1"	1"	1"	3.8
B22-454-NL	1"	1-1/4"	1"	4.2
B22-455-NL	1"	1-1/4"	1-1/4"	5.5
B22-555-NL	1-1/4"	1-1/4"	1-1/4"	7.0
B22-566-NL	1-1/4"	1-1/2"	1-1/2"	8.5
**B22-666-NL	1-1/2"	1-1/2"	1-1/2"	10.5
B22-676-NL	1-1/2"	2"	1-1/2"	12.9
B22-677-NL	1-1/2"	2"	2"	15.1
**B22-777-NL	2"	2"	2"	16.9

B22-333M-NL

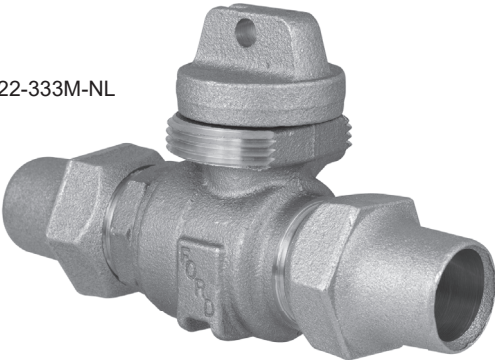

Flare Copper Both Ends Minneapolis Pattern Valve

CATALOG NUMBER	VALVE SIZE	INLET SIZE	OUTLET SIZE	APPROX. WT. LBS.
*B22-333M-NL	3/4"	3/4"	3/4"	2.9
B22-343M-NL	3/4"	1"	3/4"	3.1
B22-344M-NL	3/4"	1"	1"	4.1
*B22-444M-NL	1"	1"	1"	4.2
B22-454M-NL	1"	1-1/4"	1"	4.7
B22-455M-NL	1"	1-1/4"	1-1/4"	5.6
B22-555M-NL	1-1/4"	1-1/4"	1-1/4"	4.2
B22-566M-NL	1-1/4"	1-1/2"	1-1/2"	8.2
**B22-666M-NL	1-1/2"	1-1/2"	1-1/2"	11.0
**B22-777M-NL	2"	2"	2"	17.4

Options Available

* For **Stop-and-Waste** feature on these 3/4", 1" and 2" ball valves, change "B" to "BC" and add "SW" to the catalog number.
Example: BC22-333SW-NL.

** **Stop-and-Waste feature** is available for 1-1/2" ball valves. Add "SW" to the catalog number. Example: B22-666SWM-NL.

Reclaimed Water Tee-head is available. Insert "RW" into the catalog number. Example: BRW22-333W-NL. Tee-head sold only with padlock wing.

Padlock Wings - All valves are available with padlock wings (except for Minneapolis pattern valve). Add "W" to catalog number.

Standard tee-head stops on the body to permit 90° turn *only*. **Full 360° tee-head rotation** is available. Add "R" to catalog number.
Example: B22-333R-NL.

Curb Box Base - Catalog number CB-7 for 1-1/4", 1-1/2" and 2" ball valve curb stops is listed in catalog section GA.

2" Gate Valve Operating Nut is available for 1-1/4", 1-1/2" and 2" ball valves and can be ordered from page 38.

Lock Caps are available for 5/8" through 2" ball valves and can be ordered from page 38.

Handles are available for ball valves; see page 37.

Minneapolis Pattern Valves are available in a variety of sizes. For sizes other than those in the above tables, please contact the factory.

Ford Ball Valve Curb Stops

Ball Valves with Pack Joints

TYPES OF PIPE AND TUBING – EXPLANATION OF ABBREVIATIONS AND CODES FOR COMPRESSION COUPLINGS

Copper Tube - CTS - copper tubing is widely used as a service line and the outside diameter is closely held by manufacturers. The outside diameter of copper tubing has become a standard in the industry and is known as "copper tube size". (Pack Joint coded **CTS**.)

Plastic Tubing - CTS - flexible water service tubing in what is referred to as "copper tube size". Plastic tube refers to any plastic with the same outside diameter as corresponding sizes of copper tube such as PET - polyethylene tubing. (Pack Joint coded **CTS**.)

Plastic Pipe - PEP - flexible water service pipe in what is referred to as "pipe size". Plastic pipe refers to any pipe having the same inside diameter as corresponding sizes of standard iron pipe such as PEP - polyethylene pipe. (Pack Joint coded **PEP**.)

PVC Pipe - PVC - polyvinyl chloride rigid plastic pipe. PVC pipe refers to polyvinyl chloride rigid plastic pipe having the same outside diameter as corresponding sizes of standard iron pipe. (Pack Joint coded **PVC**.)

NOTE: Ford Pack Joints for PVC are only recommended for Schedule 40 and Schedule 80 PVC. Abbreviations, dimensions and insert stiffeners for plastic tubing are listed on page 39. Consult pipe or tubing manufacturer for specific installation requirements.

Pack Joint for Copper or Plastic Tubing (CTS) by Female Iron Pipe Thread

B41-333-NL



CATALOG NUMBER	VALVE SIZE	CTS END	FIP END	APPROX. WT. LBS.
◆ * B41-333-NL	3/4"	3/4"	3/4"	2.0
▶◆ B41-334-NL	3/4"	3/4"	1"	2.1
◆ B41-343-NL	3/4"	1"	3/4"	2.2
▶◆ B41-344-NL	3/4"	1"	1"	2.4
◆ BL41-344-4-875-NL	3/4"	1"	1"	3.1
▶◆ * B41-444-NL	1"	1"	1"	2.8
◆ B41-454-NL	1"	1-1/4"	1"	3.2
◆ B41-455-NL	1"	1-1/4"	1-1/4"	3.7
◆ B41-555-NL	1-1/4"	1-1/4"	1-1/4"	5.6
◆ **B41-666-NL	1-1/2"	1-1/2"	1-1/2"	7.0
B41-677-NL	1-1/2"	2"	2"	9.6
◆ * B41-777-NL	2"	2"	2"	11.1

Pack Joint for Copper or Plastic Tubing (CTS) by Female Iron Pipe Thread Minneapolis Pattern Valve

B41-333M-NL



CATALOG NUMBER	VALVE SIZE	CTS END	FIP END	APPROX. WT. LBS.
▶◆ * B41-333M-NL	3/4"	3/4"	3/4"	2.3
B41-334M-NL	3/4"	3/4"	1"	2.4
▶ B41-343M-NL	3/4"	1"	3/4"	2.7
▶ B41-344M-NL	3/4"	1"	1"	2.8
▶◆ * B41-444M-NL	1"	1"	1"	3.4
◆ B41-454M-NL	1"	1-1/4"	1"	3.5
B41-455M-NL	1"	1-1/4"	1-1/4"	4.6
B41-555M-NL	1-1/4"	1-1/4"	1-1/4"	5.5
◆ **B41-666M-NL	1-1/2"	1-1/2"	1-1/2"	8.4
B41-677M-NL	1-1/2"	1-1/2"	2"	9.8
◆ **B41-777M-NL	2"	2"	2"	12.3

Options Available

Grip Joint for CTS (3/4" - 2") and PEP (3/4" and 1") is available. Add "-G" to the catalog number. Example: B41-333-G-NL.

* For **Stop-and-Waste** feature on these 3/4", 1" and 2" ball valves, change "B" to "BC" and add "SW" to the catalog number. Example: BC41-333SW-NL

****Stop-and-Waste feature** is available for 1-1/2" ball valves. Add "SW" to the catalog number. Example: B41-666SWM-NL.

◆ **Quick Joint** is available by adding a "-Q" to the catalog number.

▶ **Ultra-Tite** is available. Add "-U-AWT" to the catalog number. (Consists of components assembled watertight.)

● **Ultra-Tite** is available. Add "-U" to the catalog number.

Tracer Wire Terminal available on 3/4", 1", 1-1/4", 1-1/2" and 2" CTS Quick Joint Nuts, add "-TW-Q" to the catalog number.

Reclaimed Water Tee-head is available. Insert "RW" into the catalog number. Example: BRW41-333W-NL. Tee-head sold only with padlock wing.

Padlock Wings - All valves are available with padlock wings (except for Minneapolis pattern valve). Add "W" to catalog number.

Standard tee-head stops on the body to permit 90° turn *only*. **Full 360° tee-head rotation** is available. Add "R" to catalog number. Example: B41-333R-NL.

2" Gate Valve Operating Nut is available for 1-1/4", 1-1/2" and 2" ball valves and can be ordered from page 38.

Lock Caps are available for 5/8" through 2" ball valves and can be ordered from page 38.

Handles are available for ball valves; see page 37.

Minneapolis Pattern Valves are available in a variety of sizes. For sizes other than those in the above tables, please contact the factory.

Ford Ball Valve Curb Stops

Ball Valves with Pack Joints - Continued

Pack Joint for Iron Pipe by Female Iron Pipe Thread

CATALOG NUMBER	VALVE SIZE	IP END	FIP END	APPROX. WT. LBS.
B51-333-NL	3/4"	3/4"	3/4"	2.2
B51-343-NL	3/4"	1"	3/4"	2.5
B51-344-NL	3/4"	1"	1"	2.7
B51-444-NL	1"	1"	1"	3.3
** B51-666-NL	1-1/2"	1-1/2"	1-1/2"	7.2
* B51-777-NL	2"	2"	2"	11.1

B51-333-NL

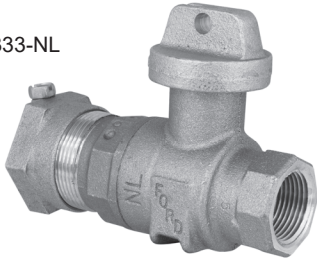

Pack Joint for Iron Pipe by Female Iron Pipe Thread Minneapolis Pattern Valve

CATALOG NUMBER	VALVE SIZE	IP END	FIP END	APPROX. WT. LBS.
B51-333M-NL	3/4"	3/4"	3/4"	2.3
B51-344M-NL	3/4"	1"	1"	3.1
** B51-666M-NL	1-1/2"	1-1/2"	1-1/2"	7.0

Pack Joint for Plastic Pipe (PEP) by Female Iron Pipe Thread

CATALOG NUMBER	VALVE SIZE	PEP END	FIP END	APPROX. WT. LBS.
• ♦ B61-333-NL	3/4"	3/4"	3/4"	2.3
▶ B61-343-NL	3/4"	1"	3/4"	2.7
▶ B61-344-NL	3/4"	1"	1"	2.9
▶ ♦ B61-444-NL	1"	1"	1"	3.5
B61-555-NL	1-1/4"	1-1/4"	1-1/4"	8.7
** B61-666-IDR7-NL	1-1/2"	1-1/2"	1-1/2"	9.2
** B61-777-IDR7-NL	2"	2"	2"	10.5

B61-333-NL

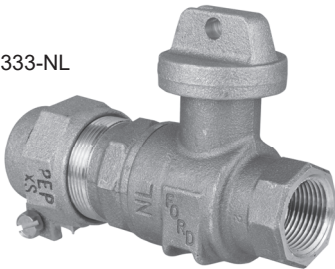

Pack Joint for Plastic Pipe (PEP) by Female Iron Pipe Thread Minneapolis Pattern Valve

CATALOG NUMBER	VALVE SIZE	PEP END	FIP END	APPROX. WT. LBS.
▶ B61-333M-NL	3/4"	3/4"	3/4"	3.0
▶ B61-344M-NL	3/4"	1"	1"	3.8
▶ ♦ B61-444M-NL	1"	1"	1"	4.4
B61-555M-NL	1-1/4"	1-1/4"	1-1/4"	6.6
** B61-666M-IDR7-NL	1-1/2"	1-1/2"	1-1/2"	9.2
** B61-777M-IDR7	2"	2"	2"	13.3

B61-444M-Q-NL



Shown with Quick Joint option

Pack Joint for PVC Pipe*** by Female Iron Pipe Thread

CATALOG NUMBER	VALVE SIZE	PVC END	FIP END	APPROX. WT. LBS.
B71-333-NL	3/4"	3/4"	3/4"	2.1
B71-343-NL	3/4"	1"	3/4"	2.5
B71-344-NL	3/4"	1"	1"	2.6
B71-444-NL	1"	1"	1"	2.9
B71-555-NL	1-1/4"	1-1/4"	1-1/4"	5.5
† ** B71-666-NL	1-1/2"	1-1/2"	1-1/2"	6.3
* B71-777-NL	2"	2"	2"	10.5

B71-333-NL



*** Ford Pack Joints for PVC are only recommended for Schedule 40 and Schedule 80 pipe.

Pack Joint for PVC Pipe*** by Female Iron Pipe Thread Minneapolis Pattern Valve

CATALOG NUMBER	VALVE SIZE	PVC END	FIP END	APPROX. WT. LBS.
B71-333M-NL	3/4"	3/4"	3/4"	2.4
B71-343M-NL	3/4"	1"	3/4"	2.8
B71-444M-NL	1"	1"	1"	3.5
B71-555M-NL	1-1/4"	1-1/4"	1-1/4"	5.8
† ** B71-666M-NL	1-1/2"	1-1/2"	1-1/2"	7.3
** B71-777M-NL	2"	2"	2"	12.0

B71-444M-NL



*** Ford Pack Joints for PVC are only recommended for Schedule 40 and Schedule 80 pipe.

Ford Ball Valve Curb Stops

Ball Valves with Pack Joints - Continued



B44-333-Q-NL

Shown with Quick Joint option



B44-333M-NL



B55-444-NL

Pack Joint for Copper or Plastic Tubing (CTS) Both Ends

CATALOG SECTION	DESCRIPTION			APPROX. WT. LBS.
	VALVE SIZE	INLET SIZE	OUTLET SIZE	
◆ ♦ * B44-333-NL	3/4"	3/4"	3/4"	2.4
▶♦ B44-343-NL	3/4"	1"	3/4"	2.5
◆ ♦ B44-344-NL	3/4"	1"	1"	3.1
▶♦ * B44-444-NL	1"	1"	1"	3.1
B44-445-Q-NL	1"	1"	1-1/4"	3.7
◆ ♦ B44-455-NL	1"	1-1/4"	1-1/4"	5.0
◆ B44-555-NL	1-1/4"	1-1/4"	1-1/4"	6.0
◆ ** B44-666-NL	1-1/2"	1-1/2"	1-1/2"	9.0
B44-677-NL	1-1/2"	2"	2"	11.1
◆ * B44-777-NL	2"	2"	2"	13.8

Pack Joint for Copper or Plastic Tubing (CTS) Both Ends Minneapolis Pattern Valve

CATALOG NUMBER	DESCRIPTION			APPROX. WT. LBS.
	VALVE SIZE	INLET SIZE	OUTLET SIZE	
▶▶ * B44-333M-NL	3/4"	3/4"	3/4"	2.6
▶♦ B44-343M-NL	3/4"	1"	3/4"	2.6
▶♦ B44-344M-NL	3/4"	1"	1"	3.2
▶▶ * B44-444M-NL	1"	1"	1"	3.4
◆ B44-455M-NL	1"	1-1/4"	1-1/4"	5.2
◆ B44-555M-NL	1-1/4"	1-1/4"	1-1/4"	6.9
◆ ** B44-666M-NL	1-1/2"	1-1/2"	1-1/2"	9.4
◆ ** B44-777M-NL	2"	2"	2"	14.1

Pack Joint for Iron Pipe Both Ends

CATALOG NUMBER	DESCRIPTION			APPROX. WT. LBS.
	VALVE SIZE	INLET SIZE	OUTLET SIZE	
B55-333-NL	3/4"	3/4"	3/4"	2.4
B55-444-NL	1"	1"	1"	3.6
** B55-666-NL	1-1/2"	1-1/2"	1-1/2"	7.0
* B55-777-NL	2"	2"	2"	12.3

Options Available

Grip Joint for CTS (3/4" - 2") and PEP (3/4" and 1") is available. Add "-G" to the catalog number. Example: B44-333-G-NL.

* For **Stop-and-Waste** feature on these 3/4", 1" and 2" ball valves, change "B" to "BC" and add "SW" to the catalog number. Example: BC44-333SW-NL.

****Stop-and-Waste feature** is available for 1-1/2" ball valves. Add "SW" to the catalog number. Example: B44-666SW-NL.

◆ **Quick Joint** is available by adding a "-Q" to the catalog number.

▶ **Ultra-Tite** is available. Add "-U-AWT" to the catalog number. (Consists of components assembled watertight.)

• **Ultra-Tite** is available. Add "-U" to the catalog number.

Tracer Wire Terminal available on 3/4", 1", 1-1/4", 1-1/2" and 2" CTS Quick Joint Nuts, add "-TW-Q" to the catalog number.

† Uses Ballcorp style Pack Joint nut.

Reclaimed Water Tee-head is available. Insert "RW" into the catalog number. Example: BRW44-333W-NL. Tee-head sold only with padlock wing.

Padlock Wings - All valves are available with padlock wings (except for Minneapolis pattern valve). Add "W" to catalog number.

Standard tee-head stops on the body to permit 90° turn *only*. **Full 360° tee-head rotation** is available. Add "R" to catalog number. Example: B44-333R-NL.

Curb Box Base - Catalog number CB-7 for 1-1/4", 1-1/2" and 2" ball valve curb stops is listed in catalog section GA.

2" Gate Valve Operating Nut is available for 1-1/4", 1-1/2" and 2" ball valves and can be ordered from page 38.

Lock Caps are available for 5/8" through 2" ball valves and can be ordered from page 38.

Handles are available for ball valves; see page 37.

Minneapolis Pattern Valves are available in a variety of sizes. For sizes other than those in the above tables, please contact the factory.

Ford Ball Valve Curb Stops

Ball Valves with Pack Joints - Continued

B66-444-Q-NL

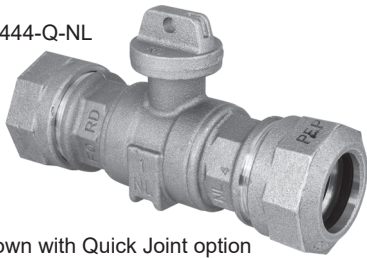

Shown with Quick Joint option

Pack Joint for Plastic Pipe (SIDR7 PEP) Both Ends

CATALOG NUMBER	DESCRIPTION			APPROX. WT. LBS.
	VALVE SIZE	INLET SIZE	OUTLET SIZE	
▶♦ B66-333-NL	3/4"	3/4"	3/4"	3.2
▶ B66-344-NL	3/4"	1"	1"	4.0
▶♦ B66-444-NL	1"	1"	1"	5.0
B66-555-NL	1-1/4"	1-1/4"	1-1/4"	8.0
B66-666-IDR7-NL	1-1/2"	1-1/2"	1-1/2"	13.6
B66-777-IDR7-NL	2"	2"	2"	15.4

B66-444M-NL



Pack Joint for Plastic Pipe (SIDR7 PEP) Both Ends Minneapolis Pattern Valve

CATALOG NUMBER	DESCRIPTION			APPROX. WT. LBS.
	VALVE SIZE	INLET SIZE	OUTLET SIZE	
♦ B66-333M-NL	3/4"	3/4"	3/4"	3.4
▶♦ B66-444M-NL	1"	1"	1"	5.3
B66-666M-IDR7-NL	1-1/2"	1-1/2"	1-1/2"	12.6
B66-777M-IDR7-NL	2"	2"	2"	15.9

B77-444-NL

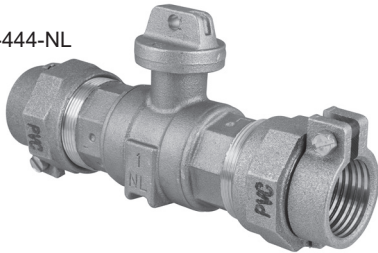

Pack Joint for PVC Pipe*** Both Ends

CATALOG NUMBER	DESCRIPTION			APPROX. WT. LBS.
	VALVE SIZE	INLET SIZE	OUTLET SIZE	
B77-333-NL	3/4"	3/4"	3/4"	3.2
B77-344-NL	3/4"	1"	1"	4.0
B77-444-NL	1"	1"	1"	5.2
B77-555-NL	1-1/4"	1-1/4"	1-1/4"	6.7
† **B77-666-NL	1-1/2"	1-1/2"	1-1/2"	8.0
*B77-777-NL	2"	2"	2"	14.3

*** Ford Pack Joints for PVC are only recommended for Schedule 40 and Schedule 80 pipe.

B77-444M-NL

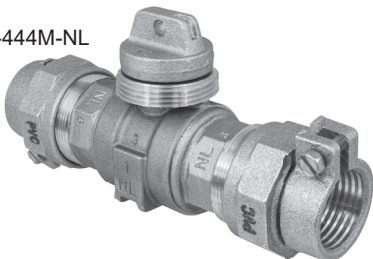

Pack Joint for PVC Pipe*** Both Ends Minneapolis Pattern Valve

CATALOG NUMBER	DESCRIPTION			APPROX. WT. LBS.
	VALVE SIZE	INLET SIZE	OUTLET SIZE	
B77-333M-NL	3/4"	3/4"	3/4"	3.4
B77-444M-NL	1"	1"	1"	5.3
† **B77-666M-NL	1-1/2"	1-1/2"	1-1/2"	10.6
*B77-777M-NL	2"	2"	2"	16.1

*** Ford Pack Joints for PVC are only recommended for Schedule 40 and Schedule 80 pipe.

B46-333-NL

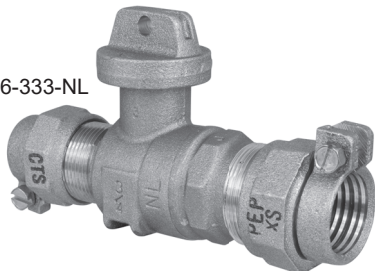

Pack Joint for Copper or Plastic Tubing (CTS) by Pack Joint for Plastic Pipe (SIDR7 PEP)

CATALOG NUMBER	DESCRIPTION			APPROX. WT. LBS.
	VALVE SIZE	CTS END	PEP END	
▶♦ B46-333-NL	3/4"	3/4"	3/4"	2.3
▶♦ B46-444-NL	1"	1"	1"	3.2
**B46-666-IDR7-NL	1-1/2"	1-1/2"	1-1/2"	8.1
**B46-777-IDR7-NL	2"	2"	2"	12.8

B47-333-NL

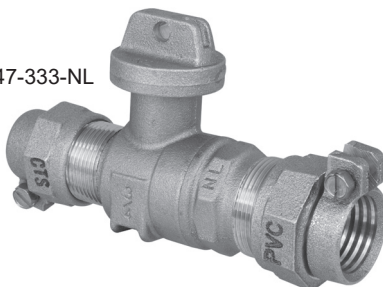

Pack Joint for Copper or Plastic Tubing (CTS) by Pack Joint for PVC Pipe***

CATALOG NUMBER	DESCRIPTION			APPROX. WT. LBS.
	VALVE SIZE	CTS END	PEP END	
▶♦ B47-333-NL	3/4"	3/4"	3/4"	2.6
▶♦♦ B47-444-NL	1"	1"	1"	3.8

*** Ford Pack Joints for PVC are only recommended for Schedule 40 and Schedule 80 pipe.

♦♦ Quick Joint for CTS is only available with padlock wing option. Add "W-Q" to the catalog number.

Ford Ball Valve Curb Stops

Ball Valves with Pack Joints - Continued



Male Iron Pipe Thread by Pack Joint for Copper or Plastic Tubing (CTS)

CATALOG NUMBER	DESCRIPTION			APPROX. WT. LBS.
	VALVE SIZE	MIP END	CTS END	
◆ B84-333-NL	3/4"	3/4"	3/4"	1.8
▶◆ B84-444-NL	1"	1"	1"	2.3
B84-455-NL	1"	1-1/4"	1-1/4"	3.4
◆ B84-666-NL	1-1/2"	1-1/2"	1-1/2"	6.4
◆ B84-777-NL	2"	2"	2"	9.7
B84-788-NL	2"	2-1/2"	2-1/2"	14.3



Male Iron Pipe Thread by Pack Joint for PVC Pipe***

CATALOG NUMBER	DESCRIPTION			APPROX. WT. LBS.
	VALVE SIZE	MIP END	PVC END	
B87-333-NL	3/4"	3/4"	3/4"	2.3
B87-334-NL	3/4"	3/4"	1"	2.7
B87-444-NL	1"	1"	1"	3.2
* B87-777-NL	2"	2"	2"	11.2

*** Ford Pack Joints for PVC are only recommended for Schedule 40 and Schedule 80 pipe.

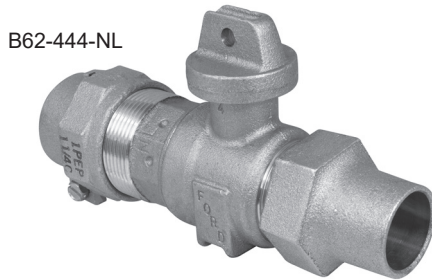

Pack Joint for Plastic Pipe (PEP) by Flare Copper

CATALOG NUMBER	DESCRIPTION			APPROX. WT. LBS.
	VALVE SIZE	PEP END	FLARE END	
▶◆ B62-333-NL	3/4"	3/4"	3/4"	2.6
▶◆ B62-444-NL	1"	1"	1"	3.4
** B62-666-IDR7-NL	1-1/2"	1-1/2"	1-1/2"	8.5
** B62-777-IDR7-NL	2"	2"	2"	12.5



Flare Copper by Pack Joint for Copper or Plastic Tubing (CTS)

CATALOG NUMBER	DESCRIPTION			APPROX. WT. LBS.
	VALVE SIZE	FLARE END	CTS END	
▶ B24-334-NL	3/4"	3/4"	1"	2.3
▶◆ B24-444-NL	1"	1"	1"	3.0

Options Available

Grip Joint for CTS (3/4" - 2") and PEP (3/4" and 1") is available. Add "-G" to the catalog number. Example: B84-333-G-NL.

* For **Stop-and-Waste** feature on these 3/4", 1" and 2" ball valves, change "B" to "BC" and add "SW" to the catalog number. Example: BC87-777SW-NL.

** **Stop-and-Waste feature** is available for 1-1/2" ball valves. Add "SW" to the catalog number. Example: B62-666SW-IDR7-NL. (Stop and Waste available on flare side only.)

◆ **Quick Joint** is available by adding a "-Q" to the catalog number.

▶ **Ultra-Tite** is available. Add "-U-AWT" to the catalog number. (Consists of components assembled watertight.)

• **Ultra-Tite** compression is available. Add "-U" into the catalog number. Example: B84-333-U-NL.

† Uses Ballcorp style Pack Joint Nut.

Tracer Wire Terminal available on 3/4", 1", 1-1/4", 1-1/2" and 2" CTS Quick Joint Nuts, add "-TW-Q" to the catalog number.

Reclaimed Water Tee-head is available. Insert "RW" into the catalog number. Example: BRW84-333W-NL. Tee-head sold only with padlock wing.

Padlock Wings - All valves are available with padlock wings (except for Minneapolis pattern valve). Add "W" to catalog number.

Standard tee-head stops on the body to permit 90° turn *only*. **Full 360° tee-head rotation** is available. Add "R" to catalog number.

Example: B84-333R-NL.

Curb Box Base - Catalog number CB-7 for 1-1/4", 1-1/2" and 2" ball valve curb stops is listed in catalog section GA.

2" Gate Valve Operating Nut is available for 1-1/4", 1-1/2" and 2" ball valves and can be ordered from page 38.

Lock Caps are available for 5/8" through 2" ball valves and can be ordered from page 38.

Handles are available for ball valves; see page 37.

Minneapolis Pattern Valves are available in a variety of sizes. For sizes other than those in the above tables, please contact the factory.

Ford "BH" Ball Valves

BH Ball Valves have a full 5/8" round water passage with excellent flow characteristics. Designed for use as a curb stop, the BH valve is strong and rugged, offering a fine replacement for inverted key and plug style valves.



BH11-233-NL

Female Iron Pipe Thread Both Ends

CATALOG NUMBER	DESCRIPTION			APPROX. WT. LBS.
	VALVE SIZE	INLET SIZE	OUTLET SIZE	
BH11-211-NL	5/8"	1/2"	1/2"	1.4
BH11-231-NL	5/8"	3/4"	1/2"	1.4
BH11-233-NL	5/8"	3/4"	3/4"	1.3



BH21-233-NL

Flare Copper by Female Iron Pipe Thread

CATALOG NUMBER	DESCRIPTION			APPROX. WT. LBS.
	VALVE SIZE	FLARE END	FIP END	
BH21-231-NL	5/8"	3/4"	1/2"	1.7
BH21-233-NL	5/8"	3/4"	3/4"	1.7
BH21-233M-NL	5/8"	3/4"	3/4"	2.0

NOTE: Length of valve for flare copper is measured *less* the copper tube nut.



BH22-233-NL

Flare Copper Both Ends

CATALOG NUMBER	DESCRIPTION			APPROX. WT. LBS.
	VALVE SIZE	INLET SIZE	OUTLET SIZE	
BH22-233-NL	5/8"	3/4"	3/4"	2.3
BH22-233M-NL	5/8"	3/4"	3/4"	2.5

NOTE: Length of valve for flare copper is measured *less* the copper tube nut.



BH41-233-NL

Pack Joint for Copper or Plastic Tubing (CTS) by Female Iron Pipe Thread

CATALOG NUMBER	DESCRIPTION			APPROX. WT. LBS.
	VALVE SIZE	CTS END	FIP END	
▶ BH41-231-NL	5/8"	3/4"	1/2"	1.6
▶◆ BH41-233-NL	5/8"	3/4"	3/4"	1.7
▶ BH41-233M-NL	5/8"	3/4"	3/4"	1.9



BH44-233-NL

Pack Joint for Copper or Plastic Tubing (CTS) Both Ends

CATALOG NUMBER	DESCRIPTION			APPROX. WT. LBS.
	VALVE SIZE	INLET SIZE	OUTLET SIZE	
▶◆ BH44-233-NL	5/8"	3/4"	3/4"	2.1
▶ BH44-233M-NL	5/8"	3/4"	3/4"	2.3



BH64-233-NL

Pack Joint for Plastic Pipe (PEP) by Pack Joint for Copper or Plastic Tubing (CTS)

CATALOG NUMBER	DESCRIPTION			APPROX. WT. LBS.
	VALVE SIZE	PEP END	CTS END	
▶ BH64-233-NL	5/8"	3/4"	3/4"	2.2

NOTE: Padlock wing option is **not** available on BH style ball valves.

Options Available

- ▶ **Grip Joint** for CTS (3/4" - 2") and PEP (3/4" and 1") is available. Add "-G" to the catalog number. Example: BH44-233-G-NL.
 - ◆ **Quick Joint** is available by adding a "-Q" to the catalog number.
 - ▶ **Tracer Wire Terminal** available on 3/4", 1", 1-1/4", 1-1/2" and 2" CTS Quick Joint Nuts, add "-TW-Q" to the catalog number.
 - ▶ **Ultra-Tite** is available. Add "-U-AWT" to the catalog number. (Consists of components assembled watertight.)
- Standard tee-head stops on the body to permit 90° turn *only*. **Full 360° tee-head rotation** is available. Add "R" to catalog number. Example: BH44-233R-NL.
- Lock Caps** are available for 5/8" through 3/4" ball valves and can be ordered from page 38.
- Handles** are available for ball valves; see page 37.
- Minneapolis Pattern Valves** are available in a variety of sizes. For sizes other than those listed, please contact the factory.

Ford Inverted Key Curb Stops

Features of the Ford Inverted Key Valve

The photo at right shows a Z21-333-NL inverted key valve with flare copper inlet and female iron pipe outlet.

Inverted key curb stops are available with the stop-and-waste feature.

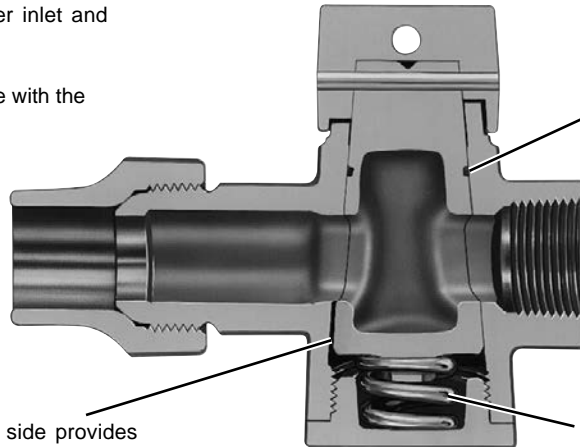

An NBR (Buna-N) rubber O-ring near the top of the inverted key offers extra protection against leaks.

A water passage on the inlet side provides upward pressure on the key, helping to hold it in the proper position.

A bronze coil spring exerts a constant upward force on the bottom of the key. If the tee-head requires tapping to free a stuck key, the spring automatically reseats the key in a watertight position.

Curb Stops with Female Iron Pipe Threads and Flare Copper Ends

Z11-333-NL



1/2" Solid Tee Head Plug Valve Curb Stops

CATALOG NUMBER	DESCRIPTION			APPROX. WT. LBS.
	VALVE SIZE	INLET SIZE AND TYPE	OUTLET SIZE AND TYPE	
ZX11-111-NL	1/2"	1/2" FIP	1/2" FIP	0.7

NOTE: ZX style valves are plug-style rather than inverted key style.

Female Iron Pipe Thread Both Ends

CATALOG NUMBER	DESCRIPTION			APPROX. WT. LBS.
	VALVE SIZE	INLET SIZE	OUTLET SIZE	
** Z11-333-NL	3/4"	3/4"	3/4"	2.1
** ZS11-333-NL	3/4"	3/4"	3/4"	2.0
** ZL11-333-NL	3/4"	3/4"	3/4"	2.3
** Z11-444-NL	1"	1"	1"	3.6

Options Available

** **Stop-and-Waste feature** is available. Add "SW" to the catalog number. Example: Z11-333SW-NL. (Note: Stop-and-waste feature drains the outlet side of the valve.)

Standard tee-head stops on the body to permit 90° turn *only*. **Full 360° tee-head rotation** is available. Add "R" to catalog number. Example: Z11-333R-NL.

Ford Inverted Key Curb Stops

Curb Stops with Female Iron Pipe Threads and Flare Copper Ends - Continued

Z21-333-NL



Flare Copper by Female Iron Pipe Thread

CATALOG NUMBER	DESCRIPTION			APPROX. WT. LBS.
	VALVE SIZE	FLARE SIZE	FIP SIZE	
** Z21-333-NL	3/4"	3/4"	3/4"	2.5
** Z21-444-NL	1"	1"	1"	4.2

NOTE: Stop-and-Waste feature drains the FIP side of valve.

Z21-333M-NL



Flare Copper by Female Iron Pipe Thread Minneapolis Pattern Valve

CATALOG NUMBER	DESCRIPTION			APPROX. WT. LBS.
	VALVE SIZE	FLARE SIZE	FIP SIZE	
Z21-333M-NL	3/4"	3/4"	3/4"	2.5
Z21-444M-NL	1"	1"	1"	4.3

NOTE: Minneapolis pattern curb box threads for inverted key curb stops are 1-1/2" for 3/4" valves and 2" for 1" valves.

Z22-333-NL



Flare Copper Both Ends

CATALOG NUMBER	DESCRIPTION			APPROX. WT. LBS.
	VALVE SIZE	INLET SIZE	OUTLET SIZE	
** Z22-111-NL	1/2"	1/2"	1/2"	1.5
** Z22-322-NL	3/4"	5/8"	5/8"	2.7
** Z22-333-NL	3/4"	3/4"	3/4"	2.9
** Z22-444-NL	1"	1"	1"	4.6

Z22-333M-NL



Flare Copper Both Ends Minneapolis Pattern Valve

CATALOG NUMBER	DESCRIPTION			APPROX. WT. LBS.
	VALVE SIZE	INLET SIZE	OUTLET SIZE	
** Z22-333M-NL	3/4"	3/4"	3/4"	2.9
** Z22-444M-NL	1"	1"	1"	4.8

NOTE: Minneapolis pattern curb box threads for inverted key curb stops are 1-1/2" for 3/4" valves and 2" for 1" valves.

Options Available

** **Stop-and-Waste feature** is available. Add "SW" to the catalog number. Examples: Z22-333SW-NL and Z22-444SWM-NL. (Note: Stop-and-waste feature drains the outlet side of the valve.)

Standard tee-head stops on the body to permit 90° turn *only*. **Full 360° tee-head rotation** is available. Add "R" to catalog number. Example: Z21-333R-NL.

Minneapolis Pattern Valves are available in a variety of sizes. For sizes other than those in the above tables, please contact the factory.

Ford Inverted Key Curb Stops

Curb Stops with Pack Joints

TYPES OF PIPE AND TUBING – EXPLANATION OF ABBREVIATIONS AND CODES FOR COMPRESSION COUPLINGS

Copper Tube - CTS - copper tubing is widely used as a service line and the outside diameter is closely held by manufacturers. The outside diameter of copper tubing has become a standard in the industry and is known as "copper tube size". (Pack Joint coded **CTS**.)

Plastic Tubing - CTS - flexible water service tubing in what is referred to as "copper tube size". Plastic tube refers to any plastic with the same outside diameter as corresponding sizes of copper tube such as PET - polyethylene tubing. (Pack Joint coded **CTS**.)

Plastic Pipe - PEP - flexible water service pipe in what is referred to as "pipe size". Plastic pipe refers to any pipe having the same inside diameter as corresponding sizes of standard iron pipe such as PEP - polyethylene pipe. (Pack Joint coded **PEP**.)

PVC Pipe - PVC - polyvinyl chloride rigid plastic pipe. PVC pipe refers to polyvinyl chloride rigid plastic pipe having the same outside diameter as corresponding sizes of standard iron pipe. (Pack Joint coded **PVC**.)

NOTE: Ford Pack Joints for PVC are recommended for use only with Schedule 40 and Schedule 80 PVC. Abbreviations, dimensions and insert stiffeners for plastic tubing are listed on page 39. Consult pipe or tubing manufacturer for specific installation requirements.



Pack Joint for Copper or Plastic Tubing (CTS) by Female Iron Pipe Thread

CATALOG NUMBER	DESCRIPTION			APPROX. WT. LBS.
	VALVE SIZE	CTS SIZE	FIP SIZE	
▶** Z41-333-NL	3/4"	3/4"	3/4"	2.4
▶** Z41-444-NL	1"	1"	1"	3.9



Pack Joint for Copper or Plastic Tubing (CTS) by Female Iron Pipe Thread Minneapolis Pattern Valve

CATALOG NUMBER	DESCRIPTION			APPROX. WT. LBS.
	VALVE SIZE	CTS SIZE	FIP SIZE	
▶ Z41-333M-NL	3/4"	3/4"	3/4"	2.5
▶ Z41-444M-NL	1"	1"	1"	4.2

NOTE: Minneapolis pattern curb box threads for inverted key curb stops are 1-1/2" for 3/4" valves and 2" for 1" valves.



Pack Joint for Plastic Pipe (PEP) by Female Iron Pipe Thread

CATALOG NUMBER	DESCRIPTION			APPROX. WT. LBS.
	VALVE SIZE	PEP SIZE	FIP SIZE	
▶ Z61-333-NL	3/4"	3/4"	3/4"	2.5
▶♦ Z61-444-NL	1"	1"	1"	4.3

Pack Joint for Plastic Pipe (PEP) by Female Iron Pipe Thread Stop and Waste Feature

CATALOG NUMBER	DESCRIPTION			APPROX. WT. LBS.
	VALVE SIZE	PEP SIZE	FIP SIZE	
▶ Z61-333SW-NL	3/4"	3/4"	3/4"	2.5
▶ Z61-444SW-NL	1"	1"	1"	4.3

NOTE: Stop-and-waste feature drains the FIP side of valve.

Options Available

** **Stop-and-Waste feature** is available. Add "SW" to the catalog number. Example: Z41-333SW-NL. (Note: Stop-and-waste feature drains the outlet side of the valve.)

Grip Joint for CTS (3/4" - 2") and PEP (3/4" and 1") is available. Add "-G" to the catalog number. Example: Z61-333-G-NL.

♦ **Quick Joint** is available by adding a "-Q" to the catalog number.

▶ **Ultra-Tite** is available. Add "-U-AWT" to the catalog number. (Consists of components assembled watertight.)

Tracer Wire Terminal available on 1" CTS Quick Joint Nuts, add "-TW-Q" to the catalog number.

Standard tee-head stops on the body to permit 90° turn *only*. **Full 360° tee-head rotation** is available. Add "R" to catalog number.

Example: Z41-333R-NL.

Minneapolis Pattern Valves are available in a variety of sizes. For sizes other than those in the above table, please contact the factory.

See page 5 for specific details on above options.

Ford Inverted Key Curb Stops

Curb Stops with Pack Joints - Continued

Z44-333-NL



Pack Joint for Copper or Plastic Tubing (CTS) Both Ends

CATALOG NUMBER	DESCRIPTION			APPROX. WT. LBS.
	VALVE SIZE	INLET SIZE	OUTLET SIZE	
◆** Z44-111-NL	1/2"	1/2"	1/2"	1.6
◆** Z44-322-NL	3/4"	5/8"	5/8"	2.9
▶** Z44-333-NL	3/4"	3/4"	3/4"	2.8
▶◆** Z44-444-NL	1"	1"	1"	4.0

Z44-333M-NL



Pack Joint for Copper or Plastic Tubing (CTS) Both Ends Minneapolis Pattern Valve

CATALOG NUMBER	DESCRIPTION			APPROX. WT. LBS.
	VALVE SIZE	INLET SIZE	OUTLET SIZE	
▶** Z44-333M-NL	3/4"	3/4"	3/4"	2.8
▶** Z44-444M-NL	1"	1"	1"	4.7

NOTE: Minneapolis pattern curb box threads for inverted key curb stops are 1-1/2" for 3/4" valves and 2" for 1" valves.

Z66-333-NL



Pack Joint for Plastic Pipe (PEP) Both Ends

CATALOG NUMBER	DESCRIPTION			APPROX. WT. LBS.
	VALVE SIZE	INLET SIZE	OUTLET SIZE	
▶** Z66-333-NL	3/4"	3/4"	3/4"	3.0
▶** Z66-444-NL	1"	1"	1"	5.1

Z77-333-NL



Pack Joint for PVC Pipe*** Both Ends

CATALOG NUMBER	DESCRIPTION			APPROX. WT. LBS.
	VALVE SIZE	INLET SIZE	OUTLET SIZE	
** Z77-333-NL	3/4"	3/4"	3/4"	2.9
** Z77-444-NL	1"	1"	1"	5.1

*** Ford Pack Joints for PVC are only recommended for Schedule 40 and Schedule 80 pipe.

Options Available

** **Stop-and-Waste feature** is available. Add "SW" to the catalog number. Example: Z44-333SW-NL and Z44-444SWM-NL. (Note: Stop-and-waste feature drains the outlet side of the valve.)

Grip Joint for CTS (3/4" - 2") and PEP (3/4" and 1") is available. Add "-G" to the catalog number. Example: Z44-333-G-NL.

◆ **Quick Joint** is available by adding a "-Q" to the catalog number.

▶ **Ultra-Tite** is available. Add "-U-AWT" to the catalog number. (Consists of components assembled watertight.)

Tracer Wire Terminal available on 1" CTS Quick Joint Nuts, add "-TW-Q" to the catalog number.

Standard tee-head stops on the body to permit 90° turn *only*. **Full 360° tee-head rotation** is available. Add "R" to catalog number. Example: Z44-333R-NL.

Minneapolis Pattern Valves are available in a variety of sizes. For sizes other than those in the above table, please contact the factory.

See page 5 for specific details on above options.

Ford Ball Meter Valves

Straight Ball Meter Valves by FIP, MIP and Flared Copper

TYPES OF PIPE AND TUBING – EXPLANATION OF ABBREVIATIONS AND CODES FOR COMPRESSION COUPLINGS

Copper Tube - CTS - copper tubing is widely used as a service line and the outside diameter is closely held by manufacturers. The outside diameter of copper tubing has become a standard in the industry and is known as "copper tube size". (Pack Joint coded **CTS**.)

Plastic Tubing - CTS - flexible water service tubing in what is referred to as "copper tube size". Plastic tube refers to any plastic with the same outside diameter as corresponding sizes of copper tube such as PET - polyethylene tubing. (Pack Joint coded **CTS**.)

Plastic Pipe - PEP - flexible water service pipe in what is referred to as "pipe size". Plastic pipe refers to any pipe having the same inside diameter as corresponding sizes of standard iron pipe such as PEP - polyethylene pipe. (Pack Joint coded **PEP**.)

PVC Pipe - PVC - polyvinyl chloride rigid plastic pipe. PVC pipe refers to polyvinyl chloride rigid plastic pipe having the same outside diameter as corresponding sizes of standard iron pipe. (Pack Joint coded **PVC**.)

NOTE: Ford Pack Joints for PVC are recommended for use only with Schedule 40 and Schedule 80 PVC. Abbreviations, dimensions and insert stiffeners for plastic tubing are listed on page 39. Consult pipe or tubing manufacturer for specific installation requirements.

Female Iron Pipe Thread by Meter Swivel Nut

CATALOG NUMBER	DESCRIPTION			APPROX. WT. LBS.
	VALVE SIZE	SERV. LINE SIZE	METER SIZE	
B13-211W-NL	5/8"	1/2"	5/8"	1.2
B13-212W-NL	5/8"	1/2"	5/8"x3/4" & 3/4"	1.2
B13-231W-NL	5/8"	3/4"	5/8"	1.2
B13-232W-NL	5/8"	3/4"	5/8"x3/4" & 3/4"	1.3
▼ B13-232WW-NL	5/8"	3/4"	5/8"x3/4" & 3/4"	1.3
B13-331W-NL	3/4"	3/4"	5/8"	1.9
B13-332W-NL	3/4"	3/4"	5/8"x3/4" & 3/4"	2.0
B13-341W-NL	3/4"	1"	5/8"	2.1
B13-342W-NL	3/4"	1"	5/8"x3/4" & 3/4"	2.2
B13-344W-NL	3/4"	1"	1"	2.4
B13-444W-NL	1"	1"	1"	2.8
B13-454W-NL	1"	1-1/4"	1"	3.1

B13-332W-NL

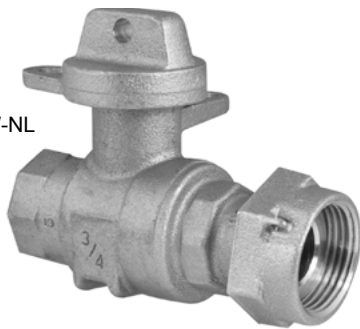

Male Iron Pipe Thread by Meter Swivel Nut

CATALOG NUMBER	DESCRIPTION			APPROX. WT. LBS.
	VALVE SIZE	SERV. LINE SIZE	METER SIZE	
B83-231W-NL	5/8"	3/4"	5/8"	1.2
B83-232W-NL	5/8"	3/4"	5/8"x3/4" & 3/4"	1.3
B83-242W-NL	5/8"	1"	5/8"x3/4" & 3/4"	1.4
B83-332W-NL	3/4"	3/4"	5/8"x3/4" & 3/4"	1.9
B83-444W-NL	1"	1"	1"	2.8

B83-332W-NL



Flare Copper by Meter Swivel Nut

CATALOG NUMBER	DESCRIPTION			APPROX. WT. LBS.
	VALVE SIZE	SERV. LINE SIZE	METER SIZE	
B23-231W-NL	5/8"	3/4"	5/8"	1.7
B23-232W-NL	5/8"	3/4"	5/8"x3/4" & 3/4"	1.8
B23-331W-NL	3/4"	3/4"	5/8"	2.2
B23-332W-NL	3/4"	3/4"	5/8"x3/4" & 3/4"	2.8
B23-341W-NL	3/4"	1"	5/8"	3.2
B23-342W-NL	3/4"	1"	5/8"x3/4" & 3/4"	2.8
B23-344W-NL	3/4"	1"	1"	3.3
B23-444W-NL	1"	1"	1"	3.5
B23-454W-NL	1"	1-1/4"	1"	5.4

B23-332W-NL



Options Available

Reclaimed Water Tee-head is available on 5/8" and 1" ball valves, insert "RW" into the catalog number. Example: BRW13-332W-NL. Tee-head sold only with padlock wing.

Standard tee-head stops on the body to permit 90° turn *only*. **Full 360° tee-head rotation** is available. Add "R" to the catalog number. Example: B13-332WR-NL.

Lock Caps are available for 5/8" through 1" ball valves and can be ordered from page 38.

Handles are available for ball valves; see page 37.

▼ "WW" indicates double padlock wings for locking in either on or off position.

Ford Ball Meter Valves

Straight Ball Meter Valves with Pack Joints

Pack Joint for Copper or Plastic Tubing (CTS) Inlet by Meter Swivel Nut

B43-231W-NL



CATALOG NUMBER	DESCRIPTION			APPROX. WT. LBS.
	VALVE SIZE	SERV. LINE SIZE	METER SIZE	
B43-211W-NL	5/8"	1/2"	5/8"	1.4
B43-212W-NL	5/8"	1/2"	5/8"x3/4" & 3/4"	1.5
▶♦ B43-231W-NL	5/8"	3/4"	5/8"	1.6
•♦ B43-232W-NL	5/8"	3/4"	5/8"x3/4" & 3/4"	1.7
▶ B43-331W-NL	3/4"	3/4"	5/8"	2.1
•♦ B43-332W-NL	3/4"	3/4"	5/8"x3/4" & 3/4"	2.4
▶♦ B43-334W-NL	3/4"	3/4"	1"	2.3
▶ B43-341W-NL	3/4"	1"	5/8"	2.7
•♦ B43-342W-NL	3/4"	1"	5/8"x3/4" & 3/4"	2.4
•♦ B43-344W-NL	3/4"	1"	1"	2.7
▶♦ B43-444W-NL	1"	1"	1"	3.2
B43-454W-NL	1"	1-1/4"	1"	3.4

B53-232W-NL



Pack Joint for Iron Pipe by Meter Swivel Nut

CATALOG NUMBER	DESCRIPTION			APPROX. WT. LBS.
	VALVE SIZE	SERV. LINE SIZE	METER SIZE	
B53-212W-NL	5/8"	1/2"	5/8"x3/4" & 3/4"	1.6
B53-232W-NL	5/8"	3/4"	5/8"x3/4" & 3/4"	1.7
B53-332W-NL	3/4"	3/4"	5/8"x3/4" & 3/4"	2.4

B63-332W-NL



Pack Joint for Plastic Pipe (PEP) by Meter Swivel Nut

CATALOG NUMBER	DESCRIPTION			APPROX. WT. LBS.
	VALVE SIZE	SERV. LINE SIZE	METER SIZE	
▶ B63-231W-NL	5/8"	3/4"	5/8"	1.8
▶♦ B63-232W-NL	5/8"	3/4"	5/8"x3/4" & 3/4"	1.8
▶ B63-331W-NL	3/4"	3/4"	5/8"	2.3
▶♦ B63-332W-NL	3/4"	3/4"	5/8"x3/4" & 3/4"	2.5
▶ B63-342W-NL	3/4"	1"	5/8"x3/4" & 3/4"	3.0
▶ B63-344W-NL	3/4"	1"	1"	3.4
▶♦ B63-444W-NL	1"	1"	1"	3.8

B73-332W-NL



Pack Joint for PVC Pipe*** by Meter Swivel

CATALOG NUMBER	DESCRIPTION			APPROX. WT. LBS.
	VALVE SIZE	SERV. LINE SIZE	METER SIZE	
B73-231W-NL	5/8"	3/4"	5/8"	1.8
B73-232W-NL	5/8"	3/4"	5/8"x3/4" & 3/4"	1.8
B73-331W-NL	3/4"	3/4"	5/8"	2.1
B73-332W-NL	3/4"	3/4"	5/8"x3/4" & 3/4"	2.6
B73-342W-NL	3/4"	1"	5/8"x3/4" & 3/4"	2.9
B73-344W-NL	3/4"	1"	1"	3.4
B73-444W-NL	1"	1"	1"	3.8

*** Ford Pack Joints for PVC are only recommended for Schedule 40 and Schedule 80 pipe.

NOTE: "W" indicates valve is standard with padlock wings *only*.

Options Available

Grip Joint for CTS (3/4" - 2") and PEP (3/4" and 1") is available. Add "-G" to the catalog number. Example: B63-332W-G-NL.

♦ **Quick Joint** is available by adding a "-Q" to the catalog number.

▶ **Ultra-Tite** is available. Add "-U-AWT" to the catalog number. (Consists of components assembled watertight.)

• **Ultra-Tite** is available. Add "-U" to the catalog number.

Reclaimed Water Tee-head is available on 5/8" and 1" ball valves, insert "RW" into the catalog number. Example: BRW63-332W-NL. Tee-head sold only with padlock wing.

Standard tee-head stops on the body to permit 90° turn *only*. **Full 360° tee-head rotation** is available. Add "R" to the catalog number. Example: B63-332WR-NL.

Lock Caps are available for 5/8" through 2" ball valves and can be ordered from page 38.

Handles are available for ball valves; see page 37.

Ford Ball Meter Valves

Straight Ball Flanged Meter Valves - for 1-1/2" and 2" Meters

BF13-777W-NL



Female Iron Pipe Thread by Meter Flange

CATALOG NUMBER	DESCRIPTION			APPROX. WT. LBS.
	VALVE SIZE	SERV. LINE SIZE	METER SIZE	
BF13-666W-NL	1-1/2"	1-1/2"	1-1/2"	7.8
BF13-676W-NL	1-1/2"	2"	1-1/2"	8.3
BF13-777W-NL	2"	2"	1-1/2" or 2"	10.3
BF13-787W-NL	2"	2-1/2"	1-1/2" or 2"	10.6

BF83-777W-NL



Male Iron Pipe Thread by Meter Flange

CATALOG NUMBER	DESCRIPTION			APPROX. WT. LBS.
	VALVE SIZE	SERV. LINE SIZE	METER SIZE	
BF83-666W-NL	1-1/2"	1-1/2"	1-1/2"	8.1
BF83-777W-NL	2"	2"	1-1/2" or 2"	10.6

BF23-777W-NL



Flare Copper by Meter Flange

CATALOG NUMBER	DESCRIPTION			APPROX. WT. LBS.
	VALVE SIZE	SERV. LINE SIZE	METER SIZE	
BF23-666W-NL	1-1/2"	1-1/2"	1-1/2"	9.7
BF23-676W-NL	1-1/2"	2"	1-1/2"	11.8
BF23-777W-NL	2"	2"	1-1/2" or 2"	13.6

BF43-777W-NL



Pack Joint for Copper or Plastic Tubing (CTS) by Meter Flange

CATALOG NUMBER	DESCRIPTION			APPROX. WT. LBS.
	VALVE SIZE	SERV. LINE SIZE	METER SIZE	
◆ BF43-666W-NL	1-1/2"	1-1/2"	1-1/2"	8.9
◆ BF43-676W-NL	1-1/2"	2"	1-1/2"	9.8
◆ BF43-777W-NL	2"	2"	1-1/2" or 2"	12.2
◆ BF43-787W-NL	2"	2-1/2"	1-1/2" or 2"	12.8

Standard features include: Flat drop-in gaskets for 1-1/2" and 2" flanged valves. Slotted holes are standard on 2" flanged valves, adapting them for connection to either 1-1/2" or 2" flanged meters.

NOTE: "W" indicates valve is standard with padlock wings *only*.

Options Available

Grip Joint for CTS (3/4" - 2") and PEP (3/4" and 1") is available. Add "-G" to the catalog number. Example: BF43-666W-G-NL.

◆ **Quick Joint** is available by adding a "-Q" to the catalog number.

Reclaimed Water Tee-head is available. Insert "RW" into the catalog number. Example: BFRW43-666W-NL. Tee-head sold only with padlock wing.

Standard tee-head stops on the body to permit 90° turn *only*. **Full 360° tee-head rotation** is available. Add "R" to catalog number.

Example: BF13-666WR-NL.

Steel Bolts and Nuts (5/8"x2-1/2", zinc plated) for attaching 1-1/2" and 2" valves to meters are available, but must be ordered separately. Steel bolt catalog number: PSB

2" Gate Valve Operating Nut is available for 1-1/4" through 2" ball valves and can be ordered from page 38.

Lock Caps are available for 5/8" through 2" ball valves and can be ordered from page 38.

Handles are available for ball valves; see page 37.

Meter Support Brackets to support the meter during installation are available on flanged valves at additional cost.

Add "MSB" to the catalog number. Example: BF13-666W-MSB-NL.

See page 5 for specific details on above options.

Ford Ball Meter Valves

Straight Ball Flanged Meter Valves - for 1-1/2" and 2" Meters - Continued

BF53-777W-NL



Pack Joint for Iron Pipe by Meter Flange

CATALOG NUMBER	DESCRIPTION			APPROX. WT. LBS.
	VALVE SIZE	SERV. LINE SIZE	METER SIZE	
BF53-666W-NL	1-1/2"	1-1/2"	1-1/2"	9.1
BF53-777W-NL	2"	2"	1-1/2" or 2"	12.3

BF63-777W-IDR7-NL



Pack Joint for Plastic Pipe (PEP) by Meter Flange

CATALOG NUMBER	DESCRIPTION			APPROX. WT. LBS.
	VALVE SIZE	SERV. LINE SIZE	METER SIZE	
BF63-666W-IDR7-NL	1-1/2"	1-1/2"	1-1/2"	11.4
BF63-777W-IDR7-NL	2"	2"	1-1/2" or 2"	12.9

BF73-777W-NL



Pack Joint for PVC Pipe*** by Meter Flange

CATALOG NUMBER	DESCRIPTION			APPROX. WT. LBS.
	VALVE SIZE	SERV. LINE SIZE	METER SIZE	
† BF73-666W-NL	1-1/2"	1-1/2"	1-1/2"	9.5
BF73-777W-NL	2"	2"	1-1/2" or 2"	13.3

*** Ford Pack Joints for PVC are only recommended for Schedule 40 and Schedule 80 pipe.

Standard features include: Flat drop-in gaskets for 1-1/2" and 2" flanged valves. Slotted holes are standard on 2" flanged valves, adapting them for connection to either 1-1/2" or 2" flanged meters.

NOTE: "W" indicates valve is standard with padlock wings *only*.

† Uses Ballcorp style Pack Joint Nut.

Options Available

For Reclaimed Water Tee-head for Ball Valves, insert "RW" into the catalog number. Example: BFARW43-666W-NL. Tee-head sold only with padlock wing. Example: BFA13-777WR-NL.

Reclaimed Water 2" Gate Valve Operating Nut is available for 1-1/4" through 2" ball valves and can be ordered from page 38.

Lock Caps are available for 5/8" through 2" ball valves and can be ordered from page 38.

Handles are available for ball valves; see page 37.

Meter Support Brackets to support the meter during installation are available on flanged valves at additional cost.

Add "MSB" to the catalog number. Example: BFA43-777W-MSB-NL.

Steel Bolts and Nuts (5/8"x2-1/2", zinc plated) for attaching 1-1/2" and 2" valves to meters are available, but must be ordered separately. Steel bolt catalog number: PSB

See page 5 for specific details on above options.

Straight Compression Globe Meter Valves

Female Iron Pipe Thread by Meter Swivel Nut

CATALOG NUMBER	DESCRIPTION			APPROX. WT. LBS.
	VALVE SIZE	SERV. LINE SIZE	METER SIZE	
SG13-331-NL	3/4"	3/4"	5/8"	1.6
SG13-332-NL	3/4"	3/4"	5/8"x3/4" & 3/4"	1.6
SG13-444-NL	1"	1"	1"	2.4

SG13-444-NL



Flare Copper by Meter Swivel Nut

CATALOG NUMBER	DESCRIPTION			APPROX. WT. LBS.
	VALVE SIZE	SERV. LINE SIZE	METER SIZE	
SG23-331-NL	3/4"	3/4"	5/8"	1.9
SG23-332-NL	3/4"	3/4"	5/8"x3/4" & 3/4"	1.9

Pack Joint for Copper or Plastic Tubing (CTS) by Meter Swivel Nut

CATALOG NUMBER	DESCRIPTION			APPROX. WT. LBS.
	VALVE SIZE	SERV. LINE SIZE	METER SIZE	
▶ SG43-332-NL	3/4"	3/4"	5/8"	1.9

Grip Joint for CTS is available. Add "-G" to the catalog number.

▶ **Ultra-Tite** is available. Add "-U-AWT" to the catalog number. (Consists of components assembled watertight.)

Ford Angle Ball Meter Valves



Female Iron Pipe Thread Inlet by Meter Swivel Nut Outlet

CATALOG NUMBER	DESCRIPTION			APPROX. WT. LBS.
	VALVE SIZE	SERV. LINE SIZE	METER SIZE	
BA13-231W-NL	5/8"	3/4"	5/8"	1.2
BA13-232W-NL	5/8"	3/4"	5/8"x3/4" & 3/4"	1.3
▼ BA13-232WW-NL	5/8"	3/4"	5/8"x3/4" & 3/4"	1.4
BA13-331W-NL	3/4"	3/4"	5/8"	1.9
BA13-332W-NL	3/4"	3/4"	5/8"x3/4" & 3/4"	2.0
▼ BA13-332WW-NL	3/4"	3/4"	5/8"x3/4" & 3/4"	2.1
BA13-334W-NL	3/4"	3/4"	1"	2.1
BA13-341W-NL	3/4"	1"	5/8"	2.3
BA13-342W-NL	3/4"	1"	5/8"x3/4" & 3/4"	2.3
BA13-344W-NL	3/4"	1"	1"	2.4
BA13-444W-NL	1"	1"	1"	3.1
▼ BA13-444WW-NL	1"	1"	1"	3.2

▼ Double padlock wings for locking in either "on" or "off" position.

Flare Copper Inlet by Meter Swivel Nut Outlet

CATALOG NUMBER	DESCRIPTION			APPROX. WT. LBS.
	VALVE SIZE	SERV. LINE SIZE	METER SIZE	
BA23-231W-NL	5/8"	3/4"	5/8"	1.6
BA23-232W-NL	5/8"	3/4"	5/8"x3/4" & 3/4"	1.7
BA23-241W-NL	5/8"	1"	5/8"	2.0
BA23-242W-NL	5/8"	1"	5/8"x3/4" & 3/4"	2.0
BA23-331W-NL	3/4"	3/4"	5/8"	2.2
BA23-332W-NL	3/4"	3/4"	5/8"x3/4" & 3/4"	2.3
BA23-334W-NL	3/4"	3/4"	1"	2.7
BA23-341W-NL	3/4"	1"	5/8"	2.6
BA23-342W-NL	3/4"	1"	5/8"x3/4" & 3/4"	2.7
BA23-344W-NL	3/4"	1"	1"	2.8
BA23-444W-NL	1"	1"	1"	3.8

Pack Joint for Copper or Plastic Tubing (CTS) Inlet by Meter Swivel Nut Outlet

CATALOG NUMBER	DESCRIPTION			APPROX. WT. LBS.
	VALVE SIZE	SERV. LINE SIZE	METER SIZE	
▶▶ BA43-231W-NL	5/8"	3/4"	5/8"	1.5
▶▶ BA43-232W-NL	5/8"	3/4"	5/8"x3/4" & 3/4"	1.6
▶▶ BA43-241W-NL	5/8"	1"	5/8"	1.6
▶▶ BA43-242W-NL	5/8"	1"	5/8"x3/4" & 3/4"	1.7
▶▶ BA43-331W-NL	3/4"	3/4"	5/8"	2.1
●▶ BA43-332W-NL	3/4"	3/4"	5/8"x3/4" & 3/4"	2.2
▶▶ BA43-334W-NL	3/4"	3/4"	1"	2.2
▶▶ BA43-341W-NL	3/4"	1"	5/8"	2.2
▶▶ BA43-342W-NL	3/4"	1"	5/8"x3/4" & 3/4"	2.3
▶▶ BA43-344W-NL	3/4"	1"	1"	2.4
▶▶ BA43-444W-NL	1"	1"	1"	2.9

Pack Joint for Plastic Pipe (PEP) Inlet by Meter Swivel Nut Outlet

CATALOG NUMBER	DESCRIPTION			APPROX. WT. LBS.
	VALVE SIZE	SERV. LINE SIZE	METER SIZE	
▶▶ BA63-231W-NL	5/8"	3/4"	5/8"	1.6
▶▶ BA63-232W-NL	5/8"	3/4"	5/8"x3/4" & 3/4"	1.7
▶▶ BA63-332W-NL	3/4"	3/4"	5/8"x3/4" & 3/4"	2.5
▶▶ BA63-342W-NL	3/4"	1"	5/8"x3/4" & 3/4"	2.8
▶▶ BA63-444W-NL	1"	1"	1"	4.0

Pack Joint for PVC Pipe *** Inlet by Meter Swivel Nut Outlet

CATALOG NUMBER	DESCRIPTION			APPROX. WT. LBS.
	VALVE SIZE	SERV. LINE SIZE	METER SIZE	
BA73-232W-NL	5/8"	3/4"	5/8"x3/4" & 3/4"	1.8

*** Ford Pack Joints for PVC are only recommended for Schedule 40 and Schedule 80 pipe.

Note: The 5/8" Port Angle Ball Valve is a one-directional valve designed for the inlet side of the meter and should not be used as a customer shut-off on the customer side of the meter.

Padlock Wings on Angle Meter Valves

Inverted key meter valves and ball meter valves include padlock wings for locking the valve in a closed position. The "W" at the end of the catalog number indicates the valve is standard with padlock wings.

Top view of the valve in the open position. Padlock holes are normally 7/16"

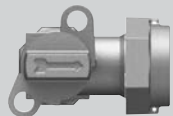

Options Available

- **Grip Joint** for CTS (3/4" - 2") and PEP (3/4" and 1") is available. Add "-G" to the catalog number. Example: BA63-332W-G-NL.
- **Quick Joint** is available by adding a "-Q" to the catalog number.
- **Ultra-Tite** is available. Add "-U-AWT" to the catalog number. (Consists of components assembled watertight.)
- **Ultra-Tite** is available. Add "-U" to the catalog number.
- **Handles** are available for ball valves; see page 37.
- Standard tee-head stops on the body to permit 90° turn *only*. **Full 360° tee-head rotation** is available. Add "R" to catalog number. Example: -332WR-NL.
- **Reclaimed Water Tee-head** is available on 3/4" and 1" ball valves. Insert "RW" into the catalog number. Example: BARW63-332W-NL. Tee-head sold only with padlock wing.

Ford Angle Ball Flanged Meter Valves

For 1-1/2" and 2" Meters



BFA13-777W-NL

Female Iron Pipe Thread by Meter Flange

CATALOG NUMBER	DESCRIPTION			APPROX. WT. LBS.
	VALVE SIZE	SERV. LINE SIZE	METER SIZE	
BFA13-666W-NL	1-1/2"	1-1/2"	1-1/2"	7.0
BFA13-677W-NL	1-1/2"	2"	1-1/2" and 2"	7.6
BFA13-777W-NL	2"	2"	1-1/2" and 2"	9.1

Flare Copper by Meter Flange

CATALOG NUMBER	DESCRIPTION			APPROX. WT. LBS.
	VALVE SIZE	SERV. LINE SIZE	METER SIZE	
BFA23-666W-NL	1-1/2"	1-1/2"	1-1/2"	8.0
BFA23-777W-NL	2"	2"	1-1/2" and 2"	12.2

Pack Joint for Copper or Plastic Tubing (CTS) by Meter Flange

CATALOG NUMBER	DESCRIPTION			APPROX. WT. LBS.
	VALVE SIZE	SERV. LINE SIZE	METER SIZE	
◆ BFA43-666W-NL	1-1/2"	1-1/2"	1-1/2"	7.8
◆ BFA43-777W-NL	2"	2"	1-1/2" and 2"	10.7

1-1/2" and 2" angle ball meter valves are suitable for a customer side shut off (outlet side of meter) up to 300 psi.

Standard features include: Flat drop-in gaskets for 1-1/2" and 2" flanged valves. Slotted holes are standard on 2" flanged angle valves, adapting them for connection to either 1-1/2" or 2" flanged meters.

Options Available

Grip Joint for CTS is available. Add "-G" to the catalog number.

◆ **Quick Joint** is available by adding a "-Q" to the catalog number.

Handles are available for Ball Valves; see page 37.

For Reclaimed Water Tee-head for Ball Valves, insert "RW" into the catalog number. Example: BFA43-777W-RW-NL. Tee-head sold only with padlock wing.

Meter Support Brackets to support the meter during installation are available on flanged valves at additional cost. Add "MSB" to the catalog number. Example: BFA43-777W-MSB-NL.

Standard tee-head stops on the body to permit 90° turn *only*. **Full 360° tee-head rotation** is available. Add "R" to catalog number. Example: BFA13-777WR-NL.

Steel Bolts and Nuts (5/8"x2-1/2", zinc plated) for attaching 1-1/2" and 2" valves to meters are available, but must be ordered separately. Steel bolt catalog number: PSB

2" Gate Valve Operating Nut is available for 1-1/4" through 2" ball valves and can be ordered from page 38.

Lock Caps are available for 5/8" through 2" ball valves and can be ordered from page 38.

See page 5 for specific details on above options.

Ford Blow-Off Ball Valves

Typically installed at the end of a water pipeline, blow-off valves provide a simple solution for line flushing.



BLA18-777-TA-NL

Female Iron Pipe Thread by Male Iron Pipe Thread

CATALOG NUMBER	VALVE SIZE	INLET SIZE	OUTLET SIZE	APPROX. WT. LBS.
BLA18-677-TA-NL	1-1/2"	2"	2"	5.6
BLA18-777-TA-NL	2"	2"	2"	9.3

Flare Copper by Male Iron Pipe Thread

CATALOG NUMBER	VALVE SIZE	INLET SIZE	OUTLET SIZE	APPROX. WT. LBS.
BLA28-443-TA-NL	1"	1"	3/4"	2.7
† BLA28-677-TA-AWT-NL	1-1/2"	2"	2"	10.6

† This product is manufactured from components assembled watertight.

Angle Compression Globe Meter Valves



Female Iron Pipe Thread by Meter Swivel Nut

CATALOG NUMBER	DESCRIPTION			APPROX. WT. LBS.
	VALVE SIZE	SERV. LINE SIZE	METER SIZE	
GA13-331-NL	3/4"	3/4"	5/8"	1.4
GA13-332-NL	3/4"	3/4"	5/8"x3/4" & 3/4"	1.5
GA13-444-NL	1"	1"	1"	2.1

Flare Copper by Meter Swivel Nut

CATALOG NUMBER	DESCRIPTION			APPROX. WT. LBS.
	VALVE SIZE	SERV. LINE SIZE	METER SIZE	
GA23-331-NL	3/4"	3/4"	5/8"	1.7
GA23-332-NL	3/4"	3/4"	5/8"x3/4" & 3/4"	1.8

Pack Joint for Copper or Plastic Tubing (CTS) by Meter Swivel Nut

CATALOG NUMBER	DESCRIPTION			APPROX. WT. LBS.
	VALVE SIZE	SERV. LINE SIZE	METER SIZE	
▶ GA43-331-NL	3/4"	3/4"	5/8"	1.8
▶ GA43-332-NL	3/4"	3/4"	5/8"x3/4" & 3/4"	1.8

▶ Ultra-Tite is available. Add "-U-AWT" to the catalog number. (Consists of components assembled watertight.)

Grip Joint for CTS (3/4" - 2") is available. Add "-G" to the catalog number. Example: GA43-332-G-NL

Angle Inverted Key Meter Valves



Female Iron Pipe Thread by Meter Swivel Nut

CATALOG NUMBER	VALVE SIZE	SERVICE LINE	METER SIZE	APPROX. WT. LBS.
KV13-331W-NL	3/4"	3/4"	5/8"	1.2
KV13-332W-NL	3/4"	3/4"	5/8"x3/4" & 3/4"	1.3
KV13-342W-NL	3/4"	1"	5/8"x3/4" & 3/4"	1.4
KV13-444W-NL	1"	1"	1"	1.9
KV13-454W-NL	1"	1-1/4"	1"	2.1

Flare Copper by Meter Swivel Nut

CATALOG NUMBER	VALVE SIZE	SERVICE LINE	METER SIZE	APPROX. WT. LBS.
KV23-331W-NL	3/4"	3/4"	5/8"	1.6
KV23-341W-NL	3/4"	1"	5/8"	1.7
KV23-332W-NL	3/4"	3/4"	5/8"x3/4" & 3/4"	1.6
KV23-342W-NL	3/4"	1"	5/8"x3/4" & 3/4"	1.9
KV23-444W-NL	1"	1"	1"	2.4
KV23-454W-NL	1"	1-1/4"	1"	2.9

Pack Joint for Copper or Plastic Tubing (CTS) by Meter Swivel Nut

CATALOG NUMBER	VALVE SIZE	SERVICE LINE	METER SIZE	APPROX. WT. LBS.
▶ KV43-331W-NL	3/4"	3/4"	5/8"	1.4
▶ KV43-341W-NL	3/4"	1"	5/8"	1.4
▶♦ KV43-332W-NL	3/4"	3/4"	5/8"x3/4" & 3/4"	1.5
▶♦ KV43-342W-NL	3/4"	1"	5/8"x3/4" & 3/4"	1.7
▶♦ KV43-444W-NL	1"	1"	1"	2.1
KV43-454W-NL	1"	1-1/4"	1"	2.7

Pack Joint for Plastic Pipe (PEP) by Meter Swivel Nut

CATALOG NUMBER	VALVE SIZE	SERVICE LINE	METER SIZE	APPROX. WT. LBS.
▶ KV63-331W-NL	3/4"	3/4"	5/8"	1.5
▶♦ KV63-332W-NL	3/4"	3/4"	5/8"x3/4" & 3/4"	1.6
▶♦ KV63-342W-NL	3/4"	1"	5/8"x3/4" & 3/4"	2.2
▶ KV63-444W-NL	1"	1"	1"	2.7

NOTE: "W" indicates valve is standard with padlock wings only.

Options Available

Grip Joint for CTS (all sizes) and PEP (3/4" and 1") is available. Add "-G" to the catalog number. Example: KV63-332W-G-NL.

♦ Quick Joint is available by adding a "-Q" to the catalog number.

▶ Ultra-Tite is available. Add "-U-AWT" to the catalog number. (Consists of components assembled watertight.)

Lock Caps are available for "old style" non-padlock wing 5/8", 5/8"x3/4", and 3/4" angle meter valves. Order by catalog number [AV-LOCKCAP-23](#).

Handles are available for key valves; see page 38.

Ford Angle Meter Valves

1-1/2" and 2" Flanged Key Meter Valves

FV13-777W-MSB-NL



FV23-777W-NL



FV43-777W-NL



FV53-777W-NL



FV63-777W-NL



FV73-666W-NL



*Female Iron Pipe Thread by Meter Flange

CATALOG NUMBER	DESCRIPTION			APPROX. WT. LBS.
	VALVE SIZE	SERV. LINE SIZE	METER SIZE	
FV13-666W-NL	1-1/2"	1-1/2"	1-1/2"	6.8
FV13-676W-NL	1-1/2"	2"	1-1/2"	6.2
FV13-777W-NL	2"	2"	1-1/2" or 2"	7.5

*Flare Copper by Meter Flange

CATALOG NUMBER	DESCRIPTION			APPROX. WT. LBS.
	VALVE SIZE	SERV. LINE SIZE	METER SIZE	
FV23-666W-NL	1-1/2"	1-1/2"	1-1/2"	7.6
FV23-777W-NL	2"	2"	1-1/2" or 2"	10.9

*Pack Joint for Copper or Plastic Tubing (CTS) by Meter Flange

CATALOG NUMBER	DESCRIPTION			APPROX. WT. LBS.
	VALVE SIZE	SERV. LINE SIZE	METER SIZE	
FV43-666W-NL	1-1/2"	1-1/2"	1-1/2"	7.1
FV43-777W-NL	2"	2"	1-1/2" or 2"	9.8

*Pack Joint for Iron Pipe by Meter Flange

CATALOG NUMBER	DESCRIPTION			APPROX. WT. LBS.
	VALVE SIZE	SERV. LINE SIZE	METER SIZE	
FV53-666W-NL	1-1/2"	1-1/2"	1-1/2"	6.4
FV53-777W-NL	2"	2"	1-1/2" or 2"	8.2

*Pack Joint for Plastic Pipe (SIDR7 PEP) by Meter Flange

CATALOG NUMBER	DESCRIPTION			APPROX. WT. LBS.
	VALVE SIZE	SERV. LINE SIZE	METER SIZE	
FV63-666W-IDR7-NL	1-1/2"	1-1/2"	1-1/2"	7.2
FV63-777W-IDR7-NL	2"	2"	1-1/2" or 2"	9.5

*Pack Joint for PVC Pipe*** by Meter Flange

CATALOG NUMBER	DESCRIPTION			APPROX. WT. LBS.
	VALVE SIZE	SERV. LINE SIZE	METER SIZE	
† FV73-666W-NL	1-1/2"	1-1/2"	1-1/2"	6.7
FV73-777W-NL	2"	2"	1-1/2" or 2"	9.1

*** Ford Pack Joints for PVC are only recommended for Schedule 40 and Schedule 80 pipe.

† Uses Ballcorp style Pack Joint Nut.

* Flange Inverted Angle Key Valves should not be used as a customer shut-off on the customer side of the meter.

Standard features include: Flat drop-in gaskets for 1-1/2" and 2" flanged valves. Slotted holes are standard on 2" flanged angle valves, adapting them for connection to either 1-1/2" or 2" flanged meters.

NOTE: "W" indicates valve is standard with padlock wings *only*.

Options Available

Grip Joint for CTS (3/4" - 2") and PEP (3/4" and 1") is available. Add "-G" to the catalog number. Example: FV43-666W-G-NL.

Steel Bolts and Nuts (5/8"x2-1/2", zinc plated) for attaching 1-1/2" and 2" valves to meters are available, but must be ordered separately. Steel bolt catalog number: PSB

Meter Support Brackets to support the meter during installation are available on flanged valves at additional cost. Add "MSB" to the catalog number. Example: FV13-777W-MSB-NL.

See page 5 for specific details on above options.

Key Valve Branch Assemblies

UV13-42W-NL



**Female Iron Pipe Thread Inlet
by Two Meter Swivel Nut Outlets**

CATALOG NUMBER	DESCRIPTION		SPACING	APPROX. WT. LBS.
	SERV. LINE SIZE	METER SIZE		
UV13-31W-NL	3/4"	5/8"	7-1/2"	4.3
UV13-32W-NL	3/4"	5/8"x3/4" or 3/4"	7-1/2"	4.3
UV13-41W-NL	1"	5/8"	7-1/2"	4.3
UV13-41W-65-NL	1"	5/8"	6-1/2"	4.3
UV13-42W-NL	1"	5/8"x3/4" or 3/4"	7-1/2"	4.4
UV13-42W-65-NL	1"	5/8"x3/4" or 3/4"	6-1/2"	4.5

UV83-42W-NL



**Male Iron Pipe Thread Inlet
by Two Meter Swivel Nut Outlets**

CATALOG NUMBER	DESCRIPTION		SPACING	APPROX. WT. LBS.
	SERV. LINE SIZE	METER SIZE		
UV83-31W-NL	3/4"	5/8"	7-1/2"	4.1
UV83-31W-65-NL	3/4"	5/8"	6-1/2"	3.8
UV83-32W-NL	3/4"	5/8"x3/4" or 3/4"	7-1/2"	4.3
UV83-32W-65-NL	3/4"	5/8"x3/4" or 3/4"	6-1/2"	4.2
UV83-41W-NL	1"	5/8"	7-1/2"	4.0
UV83-41W-65-NL	1"	5/8"	6-1/2"	4.2
UV83-42W-NL	1"	5/8"x3/4" or 3/4"	7-1/2"	4.2
UV83-42W-65-NL	1"	5/8"x3/4" or 3/4"	6-1/2"	4.2

UV23-42W-NL



**Flare Copper Inlet
by Two Meter Swivel Nut Outlets**

CATALOG NUMBER	DESCRIPTION		SPACING	APPROX. WT. LBS.
	SERV. LINE SIZE	METER SIZE		
UV23-31W-NL	3/4"	5/8"	7-1/2"	4.4
UV23-32W-NL	3/4"	5/8"x3/4" or 3/4"	7-1/2"	4.6
UV23-41W-NL	1"	5/8"	7-1/2"	4.7
UV23-42W-NL	1"	5/8"x3/4" or 3/4"	7-1/2"	4.8

UV43-42W-NL



**Pack Joint for Plastic or Copper Tubing (CTS) Inlet
by Two Meter Swivel Nut Outlets**

CATALOG NUMBER	DESCRIPTION		SPACING	APPROX. WT. LBS.
	SERV. LINE SIZE	METER SIZE		
▶ UV43-31W-NL	3/4"	5/8"	7-1/2"	4.4
▶ UV43-31W-65-NL	3/4"	5/8"	6-1/2"	4.3
▶ UV43-32W-NL	3/4"	5/8"x3/4" or 3/4"	7-1/2"	4.6
▶ UV43-32W-65-NL	3/4"	5/8"x3/4" or 3/4"	6-1/2"	4.4
▶♦ UV43-41W-NL	1"	5/8"	7-1/2"	4.4
▶ UV43-41W-65-NL	1"	5/8"	6-1/2"	4.3
▶♦ UV43-42W-NL	1"	5/8"x3/4" or 3/4"	7-1/2"	4.6
▶ UV43-42W-65-NL	1"	5/8"x3/4" or 3/4"	6-1/2"	4.5
UV43-62W-NL	1-1/2"	5/8"x3/4" or 3/4"	7-1/2"	5.7

UV63-42W-NL



**Pack Joint for Plastic Pipe (SIDR7 PEP) Inlet
by Two Meter Swivel Nut Outlets**

CATALOG NUMBER	DESCRIPTION		SPACING	APPROX. WT. LBS.
	SERV. LINE SIZE	METER SIZE		
▶ UV63-31W-NL	3/4"	5/8"	7-1/2"	4.4
▶ UV63-32W-NL	3/4"	5/8"x3/4" or 3/4"	7-1/2"	4.7
▶ UV63-41W-NL	1"	5/8"	7-1/2"	5.0
▶ UV63-41W-65-NL	1"	5/8"	6-1/2"	4.8
▶ UV63-42W-NL	1"	5/8"x3/4" or 3/4"	7-1/2"	5.1
▶ UV63-42W-65-NL	1"	5/8"x3/4" or 3/4"	6-1/2"	4.9
UV63-51W-NL	1-1/4"	5/8"	7-1/2"	5.3
UV63-52W-NL	1-1/4"	5/8"x3/4" or 3/4"	7-1/2"	5.4

Angle Key Valve Branch Assemblies

UAV43-42W-65-NL



**Pack Joint for Copper or Plastic Tubing (CTS)
Inlet by Two Meter Swivel Nut Outlets**

CATALOG NUMBER	DESCRIPTION		SPACING	APPROX. WT. LBS.
	SERV. LINE SIZE	METER SIZE		
UAV43-41W-65-NL	1"	5/8"	6-1/2"	4.6
UAV43-42W-65-NL	1"	5/8"x3/4" or 3/4"	6-1/2"	4.8

Ball Valve Branch Assemblies

UVB13-42W-65-NL



**Female Iron Pipe Thread Inlet
by Two Meter Swivel Nut Outlets**

CATALOG NUMBER	DESCRIPTION		SPACING	APPROX. WT. LBS.
	SERV. LINE SIZE	METER SIZE		
UVB13-31W-NL	3/4"	5/8"	7-1/2"	4.4
UVB13-32W-NL	3/4"	5/8"x3/4" or 3/4"	7-1/2"	4.6
UVB13-41W-NL	1"	5/8"	7-1/2"	4.4
UVB13-41W-65-NL	1"	5/8"	6-1/2"	4.5
UVB13-42W-NL	1"	5/8"x3/4" or 3/4"	7-1/2"	4.5
UVB13-42W-65-NL	1"	5/8"x3/4" or 3/4"	6-1/2"	4.6

UVB83-42W-NL



**Male Iron Pipe Thread Inlet
by Two Meter Swivel Nut Outlets**

CATALOG NUMBER	DESCRIPTION		SPACING	APPROX. WT. LBS.
	SERV. LINE SIZE	METER SIZE		
UVB83-31W-NL	3/4"	5/8"	7-1/2"	4.3
UVB83-31W-65-NL	3/4"	5/8"	6-1/2"	4.2
UVB83-32W-NL	3/4"	5/8"x3/4" or 3/4"	7-1/2"	4.4
UVB83-32W-65-NL	3/4"	5/8"x3/4" or 3/4"	6-1/2"	4.4
UVB83-41W-NL	1"	5/8"	7-1/2"	4.0
UVB83-41W-65-NL	1"	5/8"	6-1/2"	4.4
UVB83-42W-NL	1"	5/8"x3/4" or 3/4"	7-1/2"	4.3
UVB83-42W-65-NL	1"	5/8"x3/4" or 3/4"	6-1/2"	4.5

UVB23-42W-NL



**Flare Copper Inlet
by Two Meter Swivel Nut Outlets**

CATALOG NUMBER	DESCRIPTION		SPACING	APPROX. WT. LBS.
	SERV. LINE SIZE	METER SIZE		
UVB23-31W-NL	3/4"	5/8"	7-1/2"	4.7
UVB23-32W-NL	3/4"	5/8"x3/4" or 3/4"	7-1/2"	4.8
UVB23-41W-NL	1"	5/8"	7-1/2"	4.9
UVB23-42W-NL	1"	5/8"x3/4" or 3/4"	7-1/2"	5.0

Options Available

- ▶ **Grip Joint** for CTS (3/4" - 2") and PEP (3/4" and 1") is available. Add "-G" to the catalog number. Example: UV43-32W-65-G-NL.
- ▶ **Ultra-Tite** is available. Add "-U-AWT" to the catalog number. (Consists of components assembled watertight.)
- ▶ **Quick Joint** is available by adding a "-Q" to the catalog number.
- ▶ **Handles** for key meter valves are shown on page G-38.

See page 5 for specific details on above options.

Ball Valve Branch Assemblies - Continued

Pack Joint for Plastic or Copper Tubing (CTS) Inlet by Two Meter Swivel Nut Outlets



CATALOG NUMBER	DESCRIPTION		SPACING	APPROX. WT. LBS.
	SERV. LINE SIZE	METER SIZE		
▶ UVB43-31W-NL	3/4"	5/8"	7-1/2"	4.3
▶ UVB43-31W-65-NL	3/4"	5/8"	6-1/2"	4.4
▶ UVB43-32W-NL	3/4"	5/8"x3/4" or 3/4"	7-1/2"	4.8
▶ UVB43-32W-65-NL	3/4"	5/8"x3/4" or 3/4"	6-1/2"	4.6
▶ UVB43-41W-NL	1"	5/8"	7-1/2"	4.5
▶ UVB43-41W-65-NL	1"	5/8"	6-1/2"	4.8
▶♦ UVB43-42W-NL	1"	5/8"x3/4" or 3/4"	7-1/2"	4.7
▶ UVB43-42W-65-NL	1"	5/8"x3/4" or 3/4"	6-1/2"	4.7
▶ UVB43-62W-NL	1-1/2"	5/8"x3/4" or 3/4"	7-1/2"	5.8

Pack Joint for Plastic Pipe (PEP) Inlet by Two Meter Swivel Nut Outlets



CATALOG NUMBER	DESCRIPTION		SPACING	APPROX. WT. LBS.
	SERV. LINE SIZE	METER SIZE		
▶ UVB63-31W-NL	3/4"	5/8"	7-1/2"	4.4
▶ UVB63-32W-NL	3/4"	5/8"x3/4" or 3/4"	7-1/2"	4.6
▶ UVB63-41W-NL	1"	5/8"	7-1/2"	4.7
▶ UVB63-41W-65-NL	1"	5/8"	6-1/2"	5.0
▶ UVB63-42W-NL	1"	5/8"x3/4" or 3/4"	7-1/2"	5.3
▶ UVB63-42W-65-NL	1"	5/8"x3/4" or 3/4"	6-1/2"	5.0
▶ UVB63-51W-NL	1-1/4"	5/8"	7-1/2"	5.0
▶ UVB63-52W-NL	1-1/4"	5/8"x3/4" or 3/4"	7-1/2"	5.2

Ball Valve Angle Branch Assemblies



Female Iron Pipe Thread Inlet by Two Meter Swivel Nut Outlets

CATALOG NUMBER	DESCRIPTION		SPACING	APPROX. WT. LBS.
	SERV. LINE SIZE	METER SIZE		
▶ UAVB13-42W-65-NL	1"	5/8"x3/4" or 3/4"	6-1/2"	4.8

Pack Joint for Copper or Plastic Tubing (CTS) Inlet by Two Meter Swivel Nut Outlets

▶ UAVB43-41W-65-NL	1"	5/8"	6-1/2"	4.7
▶ UAVB43-42W-65-NL	1"	5/8"x3/4" or 3/4"	6-1/2"	5.0

Options Available

- ▶ **Grip Joint** for CTS (3/4" - 2") and PEP (3/4" and 1") is available. Add "-G" to the catalog number. Example: UV43-32W-65-G-NL.
- ▶ **Ultra-Tite** is available. Add "-U-AWT" to the catalog number. (Consists of components assembled watertight.)
- ♦ **Quick Joint** is available by adding a "-Q" to the catalog number.
- Handles** for key meter valves are shown on page G-38.

See page 5 for specific details on above options.

Ball Valve Straight Branch Assemblies

Female Iron Pipe Thread Inlet by Two Meter Swivel Nut Outlets



UVBS43-31W-NL

CATALOG NUMBER	DESCRIPTION		SPACING	APPROX. WT. LBS.
	SERV. LINE SIZE	METER SIZE		
UVBS13-42W-NL	1"	5/8"x3/4" or 3/4"	7-1/2"	4.5

Pack Joint for Copper or Plastic Tubing (CTS) Inlet by Two Meter Swivel Nut Outlets

CATALOG NUMBER	DESCRIPTION		SPACING	APPROX. WT. LBS.
	SERV. LINE SIZE	METER SIZE		
UVBS43-31W-NL	3/4"	5/8"	7-1/2"	4.6
▶♦ UVBS43-42W-NL	1"	5/8"x3/4" or 3/4"	7-1/2"	4.8

Options Available

- ◆ **Grip Joint** for CTS (3/4" - 2") and PEP (3/4" and 1") is available. Add "-G" to the catalog number. Example: UVBS43-42W-G-NL.
- ▶ **Ultra-Tite** is available. Add "-U-AWT" to the catalog number. (Consists of components assembled watertight.)
- ◆ **Quick Joint** is available by adding a "-Q" to the catalog number.

See page 5 for specific details on above options.

Ford Ball Service Valves

5/8" Ball Valves

When used in a 3/4" service line, this compact, well-designed valve offers the many advantages of Ford Ball Valves at a lower cost. The smooth, tapered water passages result in excellent flow characteristics. Construction features are shown on page 5. Some styles are available in special, longer lengths.



B11-233-NL



Padlock wings as shown above are available on most 5/8" ball valves.

Female Iron Pipe Thread Both Ends

CATALOG NUMBER	DESCRIPTION			APPROX. WT. LBS.
	VALVE SIZE	INLET SIZE	OUTLET SIZE	
B11-211-NL	5/8"	1/2"	1/2"	1.0
B11-231-NL	5/8"	3/4"	1/2"	1.1
B11-233-NL	5/8"	3/4"	3/4"	1.1
▼ B11-233WW-NL	5/8"	3/4"	3/4"	1.2
BL11-233-NL	5/8"	3/4"	3/4"	1.3
BL11-233-3-5-NL	5/8"	3/4"	3/4"	1.2

▼ "WW" indicates double padlock wings for locking in either on or off position.



B21-233-NL

Flare Copper Inlet by Female Iron Pipe Thread Outlet

CATALOG NUMBER	DESCRIPTION			APPROX. WT. LBS.
	VALVE SIZE	FLARE COPPER SIZE	FIP SIZE	
B21-231-NL	5/8"	3/4"	1/2"	1.5
B21-233-NL	5/8"	3/4"	3/4"	1.5
BL21-233-4-375-NL	5/8"	3/4"	3/4"	1.7



B22-233-NL

Flare Copper Both Ends

CATALOG NUMBER	DESCRIPTION			APPROX. WT. LBS.
	VALVE SIZE	INLET SIZE	OUTLET SIZE	
B22-233-NL	5/8"	3/4"	3/4"	2.5

Options Available

- ◆ **Grip Joint** for CTS (3/4" and 1") and PEP (3/4" and 1") is available. Add "-G" to the catalog number. Example: B61-233-G-NL.
- ◆ **Quick Joint** is available on this valve with the padlock wing feature. Add "W-Q" to the catalog number. Example: B41-233W-Q-NL.
- ▶ **Ultra-Tite** is available. Add "-U-AWT" to the catalog number. (Consists of components assembled watertight.)

See page 5 for specific details on above options.

Ford Ball Service Valves - Continued

5/8" Ball Valves

B41-233-NL



B51-233-NL



B61-233-NL



B71-233-NL



B81-233-NL



B84-233-NL



B44-233-NL



B66-233-NL



Pack Joint for Copper or Plastic Tubing (CTS) by Female Iron Pipe Thread Outlets

CATALOG NUMBER	DESCRIPTION			APPROX. WT. LBS.
	VALVE SIZE	CTS SIZE	FIP SIZE	
B41-211-NL	5/8"	1/2"	1/2"	1.2
▶ B41-231-NL	5/8"	3/4"	1/2"	1.4
▶♦ B41-233-NL	5/8"	3/4"	3/4"	1.4
♦ BL41-233-NL	5/8"	3/4"	3/4"	1.6

Pack Joint for Iron Pipe Inlet by Female Iron Pipe Outlet

CATALOG NUMBER	DESCRIPTION			APPROX. WT. LBS.
	VALVE SIZE	PJ/IP SIZE	FIP SIZE	
B51-211-NL	5/8"	1/2"	1/2"	1.3
B51-233-NL	5/8"	3/4"	3/4"	1.4

Pack Joint for Plastic Pipe (PEP) Inlet by Female Iron Pipe Outlet

CATALOG NUMBER	DESCRIPTION			APPROX. WT. LBS.
	VALVE SIZE	PEP SIZE	FIP SIZE	
▶ B61-231-NL	5/8"	3/4"	1/2"	1.5
▶ B61-233-NL	5/8"	3/4"	3/4"	1.5

Pack Joint for PVC Pipe*** Inlet by Female Iron Pipe Outlet

CATALOG NUMBER	DESCRIPTION			APPROX. WT. LBS.
	VALVE SIZE	PVC SIZE	FIP SIZE	
B71-233-NL	5/8"	3/4"	3/4"	1.6

*** Ford Pack Joints for PVC are only recommended for Schedule 40 and Schedule 80 pipe.

Note: Length of valve is measured less the flare nut or pack joint nut.

Male Iron Pipe Thread by Female Iron Pipe Outlet

CATALOG NUMBER	DESCRIPTION			APPROX. WT. LBS.
	VALVE SIZE	MIP SIZE	FIP SIZE	
B81-231W-NL	5/8"	3/4"	1/2"	1.1
B81-233-NL	5/8"	3/4"	3/4"	1.0

Male Iron Pipe Thread by Pack Joint for Copper or Plastic Tubing (CTS)

CATALOG NUMBER	DESCRIPTION			APPROX. WT. LBS.
	VALVE SIZE	MIP SIZE	CTS SIZE	
▶♦ B84-233-NL	5/8"	3/4"	3/4"	1.4

Pack Joint for Copper or Plastic Tubing (CTS) Both Ends

CATALOG NUMBER	DESCRIPTION			APPROX. WT. LBS.
	VALVE SIZE	INLET SIZE	OUTLET SIZE	
B44-211-NL	5/8"	1/2"	1/2"	1.5
♦ B44-233-NL	5/8"	3/4"	3/4"	1.8

Pack Joint for Plastic Pipe (PEP) Both Ends

CATALOG NUMBER	DESCRIPTION			APPROX. WT. LBS.
	VALVE SIZE	INLET SIZE	OUTLET SIZE	
▶ B66-233-NL	5/8"	3/4"	3/4"	2.0

Ford Ball Service Valves - Continued

5/8" Ball Valves

B77-233-NL



B87-233-NL



B42-233-NL



B11-233D-NL



B21-233D-NL



B41-233D-NL



Pack Joint for PVC Pipe*** Both Ends

CATALOG NUMBER	DESCRIPTION			APPROX. WT. LBS.
	VALVE SIZE	INLET SIZE	OUTLET SIZE	
B77-233-NL	5/8"	3/4"	3/4"	2.2

*** Ford Pack Joints for PVC are only recommended for Schedule 40 and Schedule 80 pipe.

Male Iron Pipe Thread by Pack Joint for PVC Pipe***

CATALOG NUMBER	DESCRIPTION			APPROX. WT. LBS.
	VALVE SIZE	MIP SIZE	PVC SIZE	
B87-233-NL	5/8"	3/4"	3/4"	1.6

*** Ford Pack Joints for PVC are only recommended for Schedule 40 and Schedule 80 pipe.

Pack Joint for Copper or Plastic Tubing (CTS) by Flare Copper Outlet

CATALOG NUMBER	DESCRIPTION			APPROX. WT. LBS.
	VALVE SIZE	CTS SIZE	FL. COP. SIZE	
▶ B42-233-NL	5/8"	3/4"	3/4"	2.0

Female Iron Pipe Thread Both Ends with Drain

CATALOG NUMBER	DESCRIPTION			APPROX. WT. LBS.
	VALVE SIZE	INLET SIZE	OUTLET SIZE	
B11-211D-NL	5/8"	1/2"	1/2"	1.2
B11-231D-NL	5/8"	3/4"	1/2"	1.1
B11-233D-NL	5/8"	3/4"	3/4"	1.1

Flare Copper Inlet by Female Iron Pipe Outlet with Drain

CATALOG NUMBER	DESCRIPTION			APPROX. WT. LBS.
	VALVE SIZE	FLARE SIZE	FIP SIZE	
B21-231D-NL	5/8"	3/4"	1/2"	1.8
B21-233D-NL	5/8"	3/4"	3/4"	1.8

Pack Joint for Copper or Plastic Tubing (CTS) Inlet by Female Iron Pipe Thread Outlet with Drain

CATALOG NUMBER	DESCRIPTION			APPROX. WT. LBS.
	VALVE SIZE	CTS SIZE	FIP SIZE	
▶ B41-233D-NL	5/8"	3/4"	3/4"	1.6

Options Available

Grip Joint for CTS (3/4" - 2") and PEP (3/4" and 1") is available. Add "-G" to the catalog number. Example: B66-233-G-NL.

- ◆ **Quick Joint** is available on this valve with the padlock wing feature. Add "W-Q" to the catalog number.
- ▶ **Ultra-Tite** is available. Add "-U-AWT" to the catalog number. (Consists of components assembled watertight.)

Tracer Wire Terminal available on 3/4" CTS Quick Joint Nuts, add "-TW-Q" to the catalog number.

Padlock Wings - All valves are available with padlock wings. Add "W" to catalog number.

Standard tee-head stops on the body to permit 90° turn *only*. **Full 360° tee-head rotation** is available. Add "R" to catalog number. Example: B84-233R-NL.

Lock Caps are available for 5/8" through 2" ball valves and can be ordered from page 38.

Handles are available for ball valves; see page 37.

See page 5 for specific details on above options.

Ford 3/4" Straight Female Iron Pipe Compression Service Valves

G11-333-NL



Female Iron Pipe Thread Both Ends

CATALOG NUMBER	DESCRIPTION			APPROX. WT. LBS.
	VALVE SIZE	INLET SIZE	OUTLET SIZE	
G11-333-NL	3/4"	3/4"	3/4"	1.5

Ford 3/4" Straight Pack Joint Compression Service Valves

Cut-in Type with Detachable Pack Joint Assemblies

Pack Joint for Copper or Plastic Tubing (CTS) Both Ends

CATALOG NUMBER	DESCRIPTION			APPROX. WT. LBS.
	VALVE SIZE	INLET SIZE	OUTLET SIZE	
G44-311-NL	3/4"	1/2"	1/2"	2.5
▶ G44-333-NL	3/4"	3/4"	3/4"	2.6
▶ G44-344-NL	3/4"	1"	1"	2.7

G44-344-NL



Grip Joint for CTS is available. Add "-G" to the catalog number.

Pack Joint for Iron Pipe Both Ends

CATALOG NUMBER	DESCRIPTION			APPROX. WT. LBS.
	VALVE SIZE	INLET SIZE	OUTLET SIZE	
G55-311-NL	3/4"	1/2"	1/2"	2.3
G55-333-NL	3/4"	3/4"	3/4"	2.4
G55-344-NL	3/4"	1"	1"	3.5

Less Pack Joint Assemblies **

CATALOG NUMBER	DESCRIPTION		APPROX. WT. LBS.
	VALVE SIZE	INLET SIZE AND OUTLET SIZE	
G00-300-NL	3/4"	3/4" Male Korkerhorn Threads	1.4

** To purchase pack joint assemblies for PET, PEP, PVC and iron pipe, refer to section B under pack joint assemblies for KH-1, KH-2 and KH-3 style Korkerhorn.

- ▶ **Ultra-Tite** is available. Add "-U-AWT" to the catalog number. (Consists of components assembled watertight.)

Ford Angle Compression Globe Service Valves

GA21-333-NL



Flare Copper Inlet by Female Iron Pipe Thread Outlet

CATALOG NUMBER	DESCRIPTION			APPROX. WT. LBS.	STD. PKG. QTY.
	VALVE SIZE	FLARE SIZE	FIP SIZE		
GA21-333-NL	3/4"	3/4"	3/4"	1.7	6

Female Iron Pipe Thread Inlet by Female Iron Pipe Thread Outlet

CATALOG NUMBER	DESCRIPTION			APPROX. WT. LBS.	STD. PKG. QTY.
	VALVE SIZE	INLET SIZE	OUTLET SIZE		
GA11-444-NL	1"	1"	1"	1.9	8

Ford Angle Inverted Key Service Valves

With Female Iron Pipe Outlet Thread

AV11-333W-NL



Female Iron Pipe Thread Inlet by Female Iron Pipe Thread Outlet

CATALOG NUMBER	DESCRIPTION			APPROX. WT. LBS.
	VALVE SIZE	INLET SIZE	OUTLET SIZE	
AV11-333W-NL	3/4"	3/4"	3/4"	1.2
AV11-444W-NL	1"	1"	1"	1.7

Flare Copper Inlet by Female Iron Pipe Thread Outlet

AV21-333W-NL



CATALOG NUMBER	DESCRIPTION			APPROX. WT. LBS.
	VALVE SIZE	FLARE SIZE	FIP SIZE	
AV21-333W-NL	3/4"	3/4"	3/4"	1.5
■ AV21-444-NL	1"	1"	1"	2.1

Flare Copper Inlet by Male Iron Pipe Thread Outlet

CATALOG NUMBER	DESCRIPTION			APPROX. WT. LBS.
	VALVE SIZE	FLARE SIZE	MIP SIZE	
AV28-333W-NL	3/4"	3/4"	3/4"	1.3
AV28-444W-NL	1"	1"	1"	1.9
▼ AV28-444WW-NL	1" Dbl. Locking	1"	1"	2.0

Pack Joint for Copper or Plastic Tubing (CTS) Inlet by Female Iron Pipe Thread Outlet

AV41-333W-NL



CATALOG NUMBER	DESCRIPTION			APPROX. WT. LBS.
	VALVE SIZE	CTS SIZE	FIP SIZE	
▶ AV41-333W-NL	3/4"	3/4"	3/4"	1.4
▶■ AV41-444-NL	1"	1"	1"	1.8

Pack Joint for Polyethylene Pipe (PEP) Inlet by Male Iron Pipe Thread Outlet

CATALOG NUMBER	DESCRIPTION			APPROX. WT. LBS.
	VALVE SIZE	PEP SIZE	MIP SIZE	
▶ AV68-333W-NL	3/4"	3/4"	3/4"	1.4

NOTE: "W" indicates valve is standard with padlock wings only.

▼ "WW" indicates double padlock wings for locking in either "on" or "off" position.

■ Indicates valve is not available with padlock wings.

▶ **Ultra-Tite** is available. Add "-U-AWT" to the catalog number. (Consists of components assembled watertight.)

Options Available

Grip Joint for CTS (3/4" - 2") and PEP (3/4" and 1") is available. Add "-G" to the catalog number. Example: AV41-333W-G-NL.

Handles for key valves are on page G-38.

See page 5 for specific details on above options.

Ford Angle Ball Service Valves

Female Iron Pipe Thread Inlet and Outlet

CATALOG NUMBER	DESCRIPTION			APPROX. WT. LBS.
	VALVE SIZE	INLET SIZE	OUTLET SIZE	
BA11-233W-NL	5/8"	3/4"	3/4"	1.0
BA11-333W-NL	3/4"	3/4"	3/4"	1.5
BA11-343W-NL	3/4"	1"	3/4"	1.6
BA11-344W-NL	3/4"	1"	1"	1.8
BA11-444W-NL	1"	1"	1"	2.0
BA11-666W-NL	1-1/2"	1-1/2"	1-1/2"	5.3
BA11-777W-NL	2"	2"	2"	7.6

Flare Copper Inlet by Female Iron Pipe Thread Outlet

CATALOG NUMBER	DESCRIPTION			APPROX. WT. LBS.
	VALVE SIZE	FLARE SIZE	FIP SIZE	
BA21-333W-NL	3/4"	3/4"	3/4"	1.8
BA21-344W-NL	3/4"	1"	1"	2.3
BA21-444W-NL	1"	1"	1"	2.6

Pack Joint for Copper or Plastic Tubing (CTS) Inlet by Female Iron Pipe Thread Outlet

CATALOG NUMBER	DESCRIPTION			APPROX. WT. LBS.
	VALVE SIZE	CTS SIZE	FIP SIZE	
▶♦ BA41-233W-NL	5/8"	3/4"	3/4"	1.4
●♦ BA41-333W-NL	3/4"	3/4"	3/4"	2.0
▶♦ BA41-444W-NL	1"	1"	1"	3.1

Female Iron Pipe Thread Inlet by Flare Copper Outlet

CATALOG NUMBER	DESCRIPTION			APPROX. WT. LBS.
	VALVE SIZE	FIP SIZE	FLARE SIZE	
BA12-333W-NL	3/4"	3/4"	3/4"	2.3
BA12-343W-NL	3/4"	1"	3/4"	2.9
BA12-344W-NL	3/4"	1"	1"	2.8

Flare Copper Inlet and Outlet

CATALOG NUMBER	DESCRIPTION			APPROX. WT. LBS.
	VALVE SIZE	INLET SIZE	OUTLET SIZE	
BA22-333W-NL	3/4"	3/4"	3/4"	2.6
BA22-444W-NL	1"	1"	1"	4.1

Pack Joint for Copper or Plastic Tubing (CTS) Inlet and Outlet

CATALOG NUMBER	DESCRIPTION			APPROX. WT. LBS.
	VALVE SIZE	INLET SIZE	OUTLET SIZE	
▶ BA44-333W-NL	3/4"	3/4"	3/4"	2.4
▶ BA44-344W-NL	3/4"	1"	1"	2.6
▶♦ BA44-444W-NL	1"	1"	1"	3.5

NOTE: "W" indicates valve is standard with padlock wings only.

NOTE: Angle ball service valves are designed for flow from inlet (bottom) to outlet as indicated above.

Options Available

Grip Joint for CTS (3/4" - 2") and PEP (3/4" and 1") is available. Add "-G" to the catalog number. Example: BA41-233W-G-NL.

♦ **Quick Joint** is available by adding a "-Q" to the catalog number.

▶ **Ultra-Tite** is available. Add "-U-AWT" to the catalog number. (Consists of components assembled watertight.)

● **Ultra-Tite** is available. Insert "-U" into the catalog number. Example: BA41-333W-U-NL

Reclaimed Water Tee-head is available on 3/4" and 1" Ball Valves. Insert "RW" into the catalog number. Example: BARW11-333W-NL. Tee-head sold only with padlock wing.

Handles are available for ball valves; see page 37.

See page 5 for specific details on above options.

Ford Valve Handles

Handles Available for the Complete Line of Ford Ball Valves

All handles are cast from waterworks brass (AWWA Standard C800, ASTM B62 UNS/CDA No. C83600 85-5-5-5). Ball valve handles and the RHT-3/RHT-4 angle key valve handle may be attached by the customer using bolt holes already in the tee head of the valve. Other handles are factory-assembled with the valve. **All handles** may be ordered factory-assembled on valves if specified.

Handles for Ball Valves

CATALOG NUMBER	DESCRIPTION AND USAGE OF HANDLE	APPROX. WT. LBS.
HB-2	Straight Lever Handle (3-3/8" long) for 5/8" Straight and Angle Ball Valves	0.2
HB-34	Straight Lever Handle (4-3/8" long) for 3/4" and 1" Straight and Angle Ball Valves	0.3
HB-34-RW	"Reclaimed Water" Straight Lever Handle (4-1/4" long) for 3/4" and 1" Straight and Angle Ball Valves	0.3
HB-34S	Straight Lever Handle (3-3/8" long) for 3/4" and 1" Straight and Angle Ball Valves	0.2
HH-34	High Lever Handle for 3/4" and 1" Straight and Angle Ball Valves	0.4
HB-67	Straight Lever Handle (9-1/2" long) for ALL 1-1/4", 1-1/2" and 2" Straight and Angle Ball Valves	1.2
HB-67S	Straight Lever Handle (4-7/8" long) for ALL 1-1/4", 1-1/2" and 2" Straight and Angle Ball Valves	1.2
HH-67	High Lever Handle (8-7/8" long) for ALL 1-1/4", 1-1/2" and 2" Straight and Angle Ball Valves	1.2
HP-4	Special Angled Lever Handle for 3/4" and 1" Ball Valves for Pitometer Service	0.3
HS-4	High Lever Handle for 1-1/4", 1-1/2" and 2" Straight and Angle Ball Valves	0.8
HT-2	Combination Tee-head Cap and Lever Handle for 5/8" Ball Valves. Padlock Wing not available with HT-2 Handle. (factory assembled only)	0.4
HT-34	Combination Tee Head Cap and High Lever Handle for 3/4" and 1" Ball Valves. Padlock Wing not available with HT-34 Handle. (factory assembled only)	2.0
HT-67S	High Lever Handle for 1-1/2" and 2" Straight Ball Valves - (factory assembled only)	0.8



HB-2 for 5/8" Straight and Angle Ball Valves



HB-34 (4-3/8" long) and HB-34S (3-3/8" long) for 3/4" and 1" Straight and Angle Ball Valves



HH-34 for 3/4" and 1" Straight and Angle Ball Valves



HS-4 for 1-1/4", 1-1/2" and 2" Straight and Angle Ball Valves

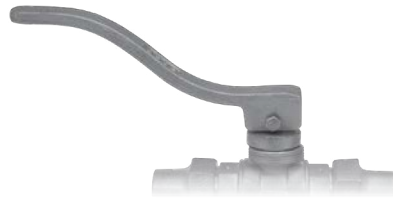

HH-67 for 1-1/4", 1-1/2" and 2" Straight and Angle Ball Valves



HB-67 (9-1/2" long) and HB-67S (4-7/8" long) for 1-1/4", 1-1/2" and 2" Ball Valves



HP-4 for use on Ball Valves for Pitometer service



HT-34 for 3/4" and 1" Angle Ball Valves and 3/4" and 1" Straight Ball Valves. **(factory assembled only)**



HT-67S for 1-1/2" and 2" Straight Ball Valves **(factory assembled only)**

Ford Valve Handles

Handles Available for the Complete Line of Ford Inverted Key Valves

Handles for Inverted Key Valves

CATALOG NUMBER	DESCRIPTION AND USAGE OF HANDLE	APPROX. WT. LBS.
HS-4	High Lever Handle for 1" "SV" type Straight Key Valve - (factory assembled only)	0.8
HT-3	Combination Tee Head and Lever Handle for 3/4" "KV" Angle Key Meter Valves and 3/4" "AV" Angle Key Service Valves - (factory assembled only)	0.6
HT-4	Combination Tee Head and Lever Handle for 1" "KV" Angle Key Meter Valves and 1" "AV" Angle Key Service Valves - (factory assembled only)	0.5
RHT-3	Straight Lever Handle for attachment to Tee Head of ALL 3/4" Angle Key Valves	0.2
RHT-4	Straight Lever Handle for attachment to Tee Head of ALL 1" Angle Key Valves	0.2



RHT-3 for 3/4" and RHT-4 for 1" Angle Key Valve



HT-3 and HT-4 for KV Meter Valves and AV Service Valves **(factory assembled only)**

Ford Valve Lock Caps

Lock Caps Available for the Complete Line of Ford Valves

BV-LOCKCAP-2



Ball Valve Lock Caps

CATALOG NUMBER	DESCRIPTION	APPROX. WT. LBS.
BV-LOCKCAP-2	Lock Cap and Pin for 5/8" Ball Valve	0.6
BV-LOCKCAP-2-PIN	Pin only for BV-LOCKCAP-2	0.1
BV-LOCKCAP-34	Lock Cap and Pin for 5/8" BH, 3/4" and 1" Ball Valves	1.0
BV-LOCKCAP-34-PIN	Pin only for BV-LOCKCAP-34	0.1
BV-LOCKCAP-567	Lock Cap and Pin for 1-1/4", 1-1/2" and 2" Ball Valves	1.4
BV-LOCKCAP-567-PIN	Pin only for BV-LOCKCAP-567	0.1

Key Valve Lock Caps

KV-LOCKCAP-3



CATALOG NUMBER	DESCRIPTION	APPROX. WT. LBS.
AV-LOCKCAP-23	Lock Cap and Pin for 5/8" and 5/8"x3/4" and 3/4" Angle Key Valves	0.7
AV-LOCKCAP-PIN-23	Pin only for AV-LOCKCAP-23	0.1
KV-LOCKCAP-3	Split Body Lock Cap and Pin for 3/4" Key Valve with Meter Nut	1.0

QT67



Gate Valve Operating Nut

CATALOG NUMBER	DESCRIPTION	APPROX. WT. LBS.
QT67	2" Gate Valve Operating Nut for 1-1/4", 1-1/2" and 2" Ball Valves	1.0



Seal Wire Hole In Padlock Wings

To order seal wire hole, add "-SEAL" to catalog number.
Example: KV13-332W-SEAL-NL.

Ford Insert Stiffeners

TYPES OF PIPE AND TUBING – EXPLANATION OF ABBREVIATIONS AND CODES FOR COMPRESSION COUPLINGS

Copper Tube - CTS - copper tubing is widely used as a service line and the outside diameter is closely held by manufacturers. The outside diameter of copper tubing has become a standard in the industry and is known as "copper tube size". (Pack Joint coded **CTS**.)

Plastic Tubing - CTS - flexible water service tubing in what is referred to as "copper tube size". Plastic tube refers to any plastic with the same outside diameter as corresponding sizes of copper tube such as PET - polyethylene tubing. (Pack Joint coded **CTS**.)

Plastic Pipe - PEP - flexible water service pipe in what is referred to as "pipe size". Plastic pipe refers to any pipe having the same inside diameter as corresponding sizes of standard iron pipe such as PEP - polyethylene pipe. (Pack Joint coded **PEP**.)

PVC Pipe - PVC - polyvinyl chloride rigid plastic pipe. PVC pipe refers to polyvinyl chloride rigid plastic pipe having the same outside diameter as corresponding sizes of standard iron pipe. (Pack Joint coded **PVC**.)

NOTE: Ford Pack Joints for PVC are recommended for use only with Schedule 40 and Schedule 80 PVC.
Consult pipe or tubing manufacturer for specific installation requirements.



Ford Pack Joint

PACK JOINT CODING

Type of service line coded on Ford Pack Joint Nut.

CTS = copper, polyethylene (PET) tubing

PEP = polyethylene (PEP) pipe

PVC = polyvinyl chloride (PVC) pipe (Schedule 40 and 80)

Insert Stiffeners

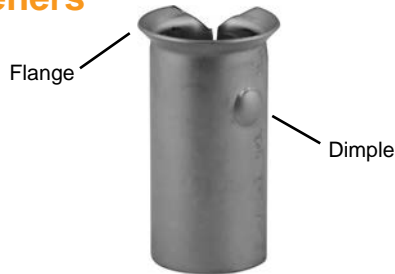

Ford Insert Stiffeners are a solid tubular 304 stainless steel design, dimpled and flanged to retain placement within the service line.

Before using Ford insert stiffeners, be sure inside tubing or pipe dimensions correspond to the table below.

Note: Consult pipe or tubing manufacturer for specific installation requirements.

Ford recommends using insert stiffeners when using plastic pipe or tubing, except for Ultra-Tite compression fittings.

50 Series For Polyethylene Tubing (PET)

CATALOG NUMBER	NOMINAL SIZE	PET ID	APPROX. WT. LBS.*	STD. PKG. QTY.
INSERT-51	3/4"	0.681	4.8	200
INSERT-52	1"	0.875	4.2	100
** INSERT-53-72	1-1/4"	1.069	2.9	50
***♦INSERT-53-72-Q	1-1/4"	1.069	2.9	50
INSERT-54	1-1/2"	1.263	3.1	25
INSERT-55	2"	1.653	6.0	40
♦INSERT-54-Q	1-1/2"	1.263	2.6	30
♦INSERT-55-Q	2"	1.653	5.8	50

70 Series For Polyethylene Pipe (PEP)

CATALOG NUMBER	NOMINAL SIZE	PEP ID	APPROX. WT. LBS.*	STD. PKG. QTY.
INSERT-71	3/4"	0.824	4.4	100
** INSERT-53-72	1"	1.049	2.9	50
***♦INSERT-53-72-Q	1"	1.049	2.9	50
INSERT-73	1-1/4"	1.380	5.8	75
INSERT-74	1-1/2"	1.610	5.5	45
INSERT-75	2"	2.067	9.7	50

Inserts For OD Controlled DR11 High Density Polyethylene (HDPE) Pipe with PVC O.D.

CATALOG NUMBER	NOMINAL SIZE AND PIPE TYPE	DR	HDPE OD	NOMINAL ID
** INSERT-53-72	1" IPS	11	1.315	1.06
INSERT-73-DR11	1-1/4" IPS	11	1.660	1.34
INSERT-74-DR11	1-1/2" IPS	11	1.900	1.53
INSERT-75-DR11	2" IPS	11	2.375	1.92

* Weights for insert stiffeners are for standard package quantities.

** INSERT-53-72 fits 1-1/4" plastic tubing (1.069 I.D.), 1" plastic pipe (1.049 I.D.) and 1" IPS HDPE (1.055 I.D.).

*** INSERT-53-72-Q fits 1-1/4" plastic tubing (1.069 I.D.) and 1" plastic pipe (1.049 I.D.).

♦ These inserts are specially designed and required for quick joint fittings. They are **not** interchangeable with other compression fittings.

DIMENSION COMPARISON TABLE FOR PLASTIC, COPPER AND GALVANIZED IRON

PIPE AND TUBING TYPE	PSI	SDR	CONTROL	O.D.						I.D.					
				1/2"	3/4"	1"	1-1/4"	1-1/2"	2"	1/2"	3/4"	1"	1-1/4"	1-1/2"	2"
Copper	-	-	OD	0.625	0.875	1.125	1.375	1.625	2.125	-	-	-	-	-	-
PET	200 250	SDR9	OD	0.625	0.875	1.125	1.375	1.625	2.125	-	0.681	0.875	1.069	1.263	1.653
PEP	200 250	SIDR7	ID	-	1.060	1.349	1.774	2.070	2.657	-	0.824	1.049	1.380	1.610	2.067
PVC	-	-	OD	0.840	1.050	1.315	1.660	1.900	2.375	-	-	-	-	-	-
Galv IP	-	-	OD	0.840	1.050	1.315	1.660	1.900	2.375	-	-	-	-	-	-

Ford Pack Joints for PVC are recommended for use only with Schedule 40 and Schedule 80 PVC.

Section G

Ford® Curb Stops and Meter Valves

Warranty

All merchandise is warranted to be free from defects in material and factory workmanship for one year from date of shipment from our factory. We will provide, free of charge, new products in equal quantities for any that prove defective within one year from date of shipment from our factory. Manufacturer shall not be liable for any loss, damage, or injury, direct or consequential, arising out of the use of or the inability to use the product. Before using, user shall determine the suitability of the product for user's intended use and user assumes all risk and liability whatever in connection therewith. No claims for labor or consequential damage will be allowed. The foregoing may not be changed except by agreement signed by an officer of the manufacturer.

No other warranties are applicable or may be implied, including the implied warranty of merchantability and the implied warranty of fitness for particular purpose and any warranty relating to infringement or the like, all of which are disclaimed.

Please Note:

Consult the Ford Meter Box Company, Inc. website (www.fordmeterbox.com) for the most recent catalog information. The Ford Meter Box Company considers the information in this catalog to be correct at the time of publication. Items and option availability, including specifications, are subject to change without notice. Please verify that your product information is current.

