

The Importance of Slab Edge & Balcony Thermal Bridges

Report # 1 : Impact of Slab Thermal Breaks on Effective R-Values and Energy Code Compliance

rdhbe.com



Making Buildings Better

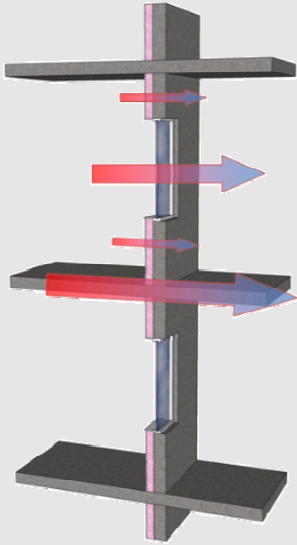
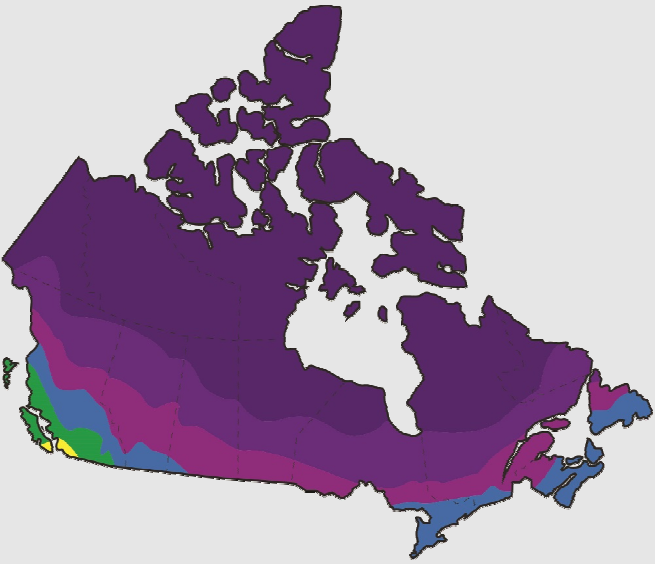
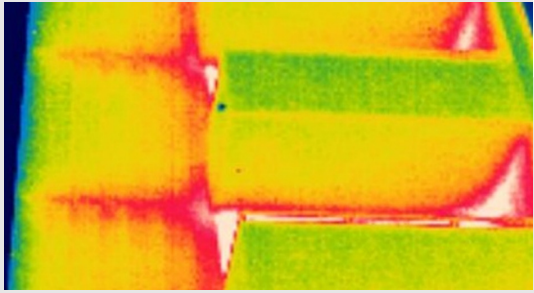
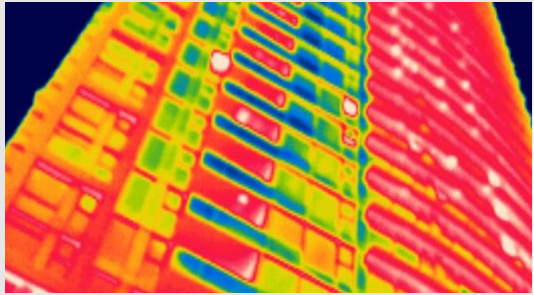

Prepared by
RDH Building Engineering Ltd.

Date
September 24, 2013

The Importance of Slab Edge & Balcony Thermal Bridges

Report # 1 - Impact on Effective R-Values and Energy Code Compliance

Thermal bridging occurs when heat flow bypasses the insulated elements of the building enclosure. Bridging occurs through structural components such as the studs/plates, framing, and cladding supports as well as the larger columns, shear walls, and exposed floor slab edges and protruding balconies. While thermal bridging occurs through the roofs, floors, and below-grade assemblies, it is often most pronounced in above-grade wall assemblies.

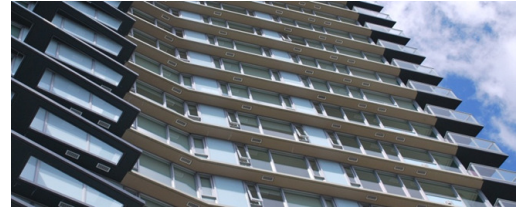

The heat flow through thermal bridges is significant and disproportionate to the overall enclosure area so that a seemingly well insulated building can often fail to meet energy code requirements, designer intent, or occupant expectations.

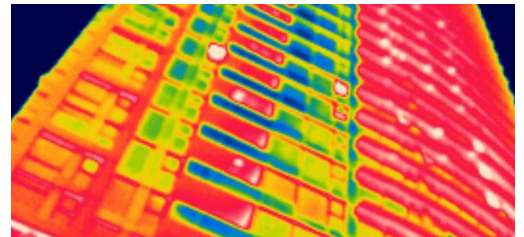

Windows are often seen as the largest thermal bridge in buildings, as the thermal performance is often quite low compared to the surrounding walls (i.e., an R-2 metal frame window within an R-20 insulated wall); however, exposed concrete slab edges and balconies can have almost as large of an influence having effective R-values of approximately R-1. After accounting for windows and doors, exposed concrete slab edges and balconies can account for the second greatest source of thermal bridging in a multi-storey building.

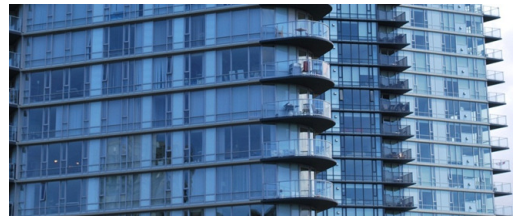

With a better understanding of the impacts of thermal bridging, the building industry has started to thermally improve building enclosures; for example, the use of exterior continuous insulation in walls is becoming more common.

Unfortunately the impact of floor slab edges and balconies is still often overlooked. At the same time, the architectural look of exposed slab edges and protruding balconies or “eyebrow” elements is becoming more common. Many designers believe that these relatively small elements have a negligible impact on the overall performance of the building or see them as an unavoidable compromise to achieve a certain appearance. Unfortunately, the impact of exposed slab edges and balconies is very significant, as this report will demonstrate. The relative impact of these elements also increases as more highly insulated walls are required by upcoming building code changes or sustainable building programs.

The Importance of Slab Edge & Balcony Thermal Bridges

Report # 1 - Impact on Effective R-values and Energy Code Compliance

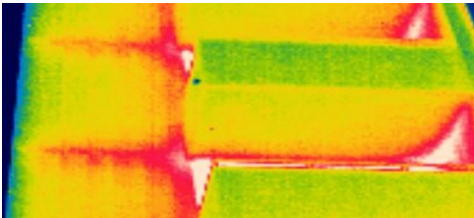
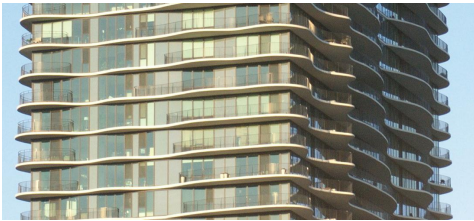
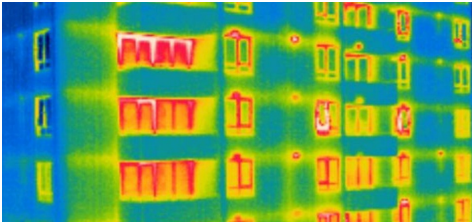

While the industry’s understanding of thermal bridging has improved in recent years, current North American building codes and energy standards—including the National Building Code of Canada, National Energy Code for Buildings (Canada), International Energy Conservation Code (US), ASHRAE 90.1 (Canada and US)—have no specific prescriptive requirements for thermally broken slabs. Moreover, these codes and standards do not explicitly address how thermal bridges at interfaces between assemblies such as exposed slab edges and balconies should be addressed in thermal transmittance calculations (U-values) that are necessary when assessing code compliance. In addition, some codes and standards may be interpreted to allow for designers to ignore the impact of structural slabs if the cross-sectional area of the projection meets specific criteria. The lack of clarity and consistency often leads to the impact of concrete balconies to be largely overlooked in practice.

Some of the omissions appear to be based on:

- The belief that the details do not have a significant impact on the overall thermal performance and on whole-building energy use because they make up a small area of the total enclosure.
- Experiences that suggest it would take too much effort to quantify all thermal bridges, which often have complex three-dimensional heat flow paths.
- The lack of comprehensive thermal transmittance data for standard details such as balcony slab edges.

Fortunately there are solutions available in the marketplace that help minimize the thermal bridging impact at slab edges and balconies and allow for continued architectural design freedom under increasingly more stringent energy code requirements and occupant demands.

RDH performed a study to research the thermal control, comfort, energy, and cost impacts of exposed slab edges and balconies. It provides proven solutions and discussion of their implications with respect to these parameters. This first report specifically addresses the impact of balcony and slab edge thermal bridges and solutions on effective R-values and North American energy code compliance.

Exposed Slab Edge & Balcony Thermal Bridge Research Study

A research study was undertaken by RDH to quantify the thermal impact of exposed slab edges and balconies in mid- to high-rise residential buildings across climate zones in Canada.

The impact of exposed slab edges and balconies on the effective wall R-values, indoor temperatures, and indoor thermal comfort was assessed. Space heating and cooling loads were also modeled in each climate zone for an archetypal multi-unit residential building to quantify the energy loss through exposed slab edges and balconies and to determine the space conditioning savings that could be achieved in typical scenarios when balcony and slab edge thermal break products are used.

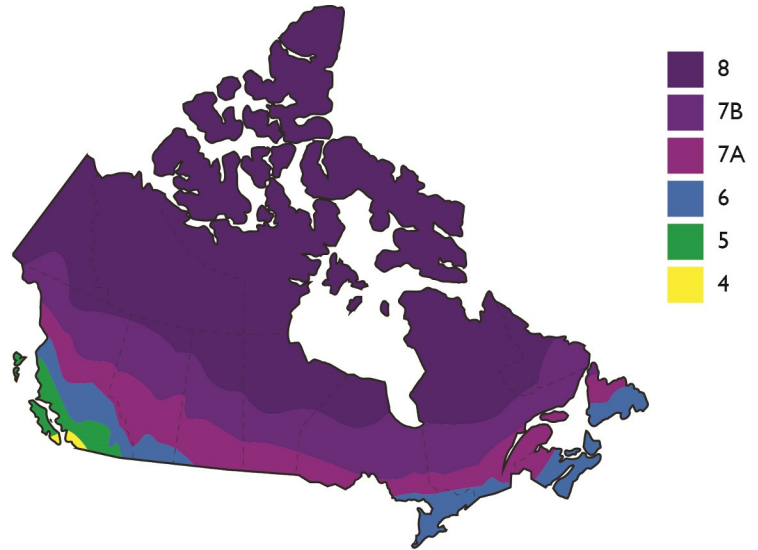

Canadian climate map showing Climate Zones 4 through 8 per the 2011 NECB. ASHRAE 90.1-2010 uses a similar climate zone map however Zone 4 is bumped into Zone 5 due to differences in reference climate data between NECB and ASHRAE.

The study addresses the following topics:

- Quantification of effective R-values, linear transmittance values (ψ), and indoor surface temperatures for various typical North American wall assemblies with and without exposed slab edges and balconies and with various balcony thermal break solutions.
- Assessment of various thermal modeling parameters including floor finishes, in-slab heating, and balcony depth.
- Comparison of the effective thermal performance of several alternate balcony thermal break solutions, insulation strategies, and manufactured thermal break products.
- Comparison of the space conditioning (heating and cooling) energy consumption for multi-unit residential buildings with exposed slab edges and balconies and with the various thermal break solutions.

This Report #1 of 4 specifically covers the impact of balcony and slab edge thermal break products on effective R-values and energy code compliance. Report #2 covers thermal comfort and Report #3 covers energy consumption and cost savings. Report #4 covers thermal modeling considerations for balconies and compares alternate thermal break strategies.

Methodology: Thermal Modeling of Exposed Concrete Slab Edges and Balconies within North American Wall Assemblies

Thermal bridging at concrete slab edges results in heat bypassing the wall insulation, reducing the effective R-value of the entire wall. Not only does this result in thermal discomfort near the exterior wall, but the effective R-values matter for:

- Building Code Compliance
- Energy Code Compliance & Potential Trade-off Path Options (Prescriptive, Building Envelope Trade-off, or Whole-Building Energy Modeling)
- Building Space Conditioning Loads (Heat and Cooling)
- Whole-Building Energy Consumption

As part of this study, the effect of exposed slab edges and balconies was thermally modeled for several different wall assemblies commonly constructed within North America and for varying thicknesses of insulation (as shown on the following page).

The effective R-values were calculated using the three-dimensional finite element thermal modeling software Heat3. This program has been validated to ISO 10211 standards and is widely used by researchers and consultants to perform advanced thermal simulations to calculate 3D effective R-values of building enclosure assemblies and details. RDH has also performed in-house confirmation of the software results with published guarded hot-box laboratory testing and ASHRAE 90.1 thermal data.

To calculate R-values, a variety of different inputs were used within the Heat3 software. The models were created using published material properties and standard boundary conditions. Heat3 performs a finite difference calculation to determine the heat flow through the assembly, which is then divided by the temperature difference to determine the U-value. The inverse of the U-value is the R-value. Further information can be found within the Appendix.

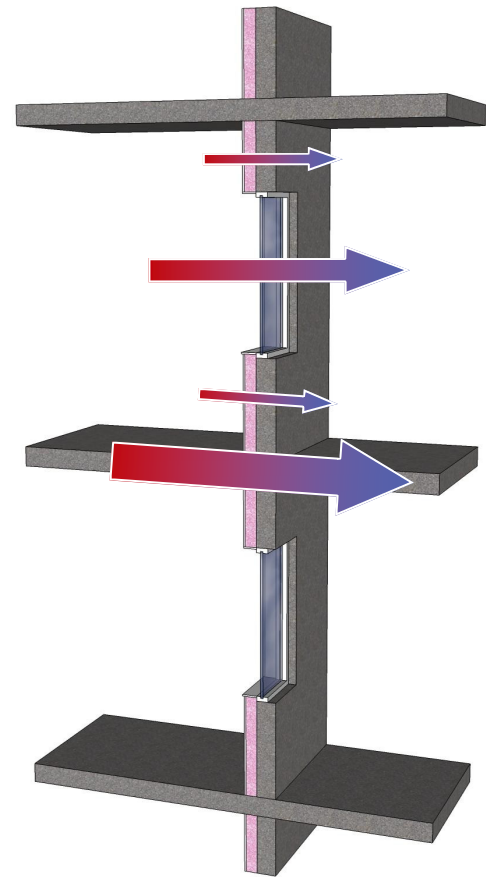

Thermal bridging paths through the wall assemblies of a concrete multi-storey building with balconies (or exposed slab edges and other features like eyebrows).

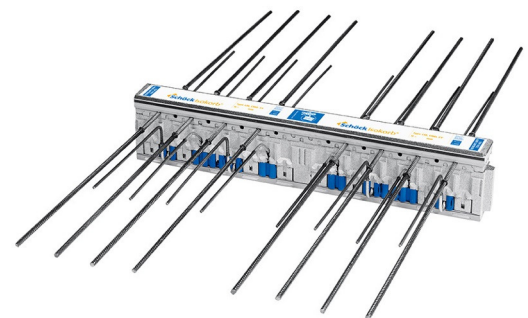

The thermal impact of purpose-built cast-in-place concrete thermal breaks such as this Schoeck Isokorb® product were evaluated within this study.

Methodology: Assessment of Balcony and Slab Edge Thermal Break Solutions

As part of the study, the thermal- and cost-effectiveness of various concrete balcony and slab edge thermal break solutions were evaluated. This included:

- Structural slab cut-outs with beam reinforcement.
- Concentrated slab reinforcement with insulation inserts.
- Full and partial balcony slab insulation wraps.
- Manufactured purpose-built concrete slab thermal breaks.

The modeling demonstrated that the thermal- and cost-effectiveness of structural slab cut-outs, concentrated slab reinforcement, and full balcony insulation wraps is relatively poor compared to manufactured slab thermal breaks and therefore were not pursued further within the study. Further information, including costing and the analysis of the various options, is provided within report #4.

A range of cast-in-place concrete balcony and slab edge thermal breaks are available on the market in Europe, with some products (including Schoeck Isokorb®) available in North America. These products incorporate an expanded polystyrene insulation thermal break with stainless-steel tension reinforcing and special polymer concrete compression blocks and have a range of effective conductivity (or effective component R-value) depending on the structural requirements and insulation thickness.

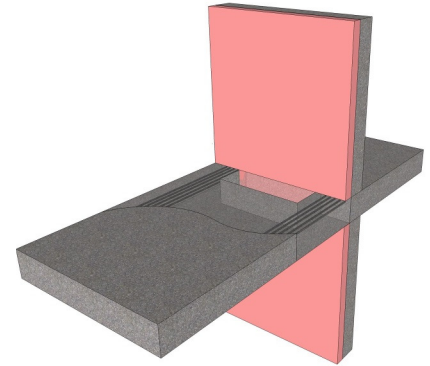

Structural slab cut-outs with beam reinforcement

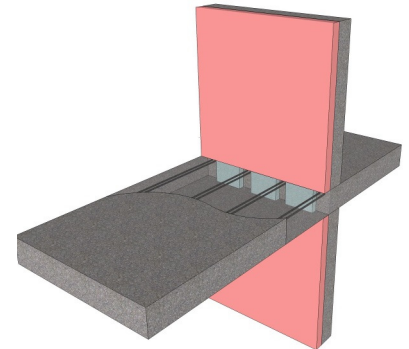

Concentrated reinforcement with and without insulation

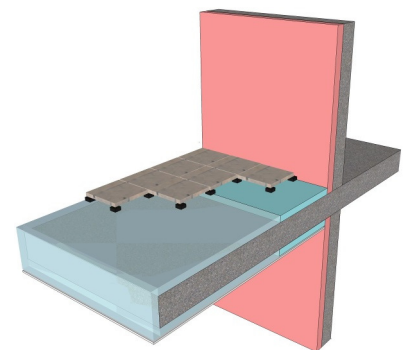

Insulation wrap (varying depth of coverage)

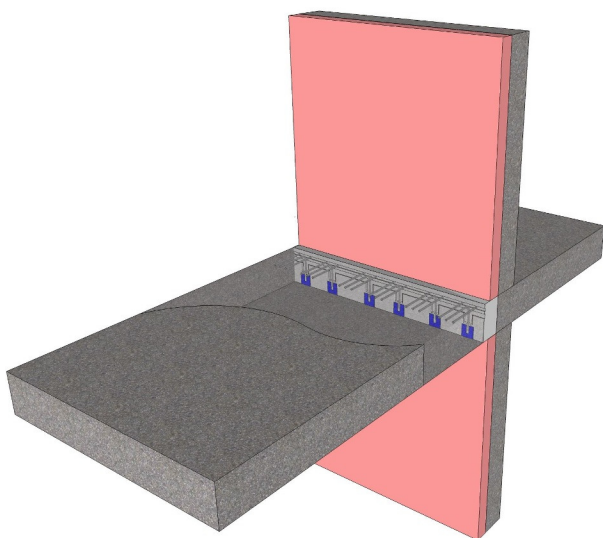

To simplify the analysis within this report and show a range of performance, a standard thermal break with normal reinforcing (R-2.5 effective for a 3.25" deep product) and high-performance thermal break with light reinforcing (R-5.0 effective for a 5" deep product) were chosen as a bounding range here.

Manufactured balcony/slab edge thermal break - R-2.5 and R-5.0 options simulated within this report to show a range of possible performance.

Thermal Modeling: Typical North American Wall Assemblies

Effective R-values for the following wall assemblies with and without balconies and exposed slab edges are provided within this report.

- Interior-Insulated Exposed Concrete
- Exterior-Insulated Cast-in-place Concrete
- Insulated Steel Stud Infill Wall
- Exterior Insulated (Girt & Intermittent Clip Supported Claddings)

Additional information on the procedure for calculation of R-values is provided in the appendix.

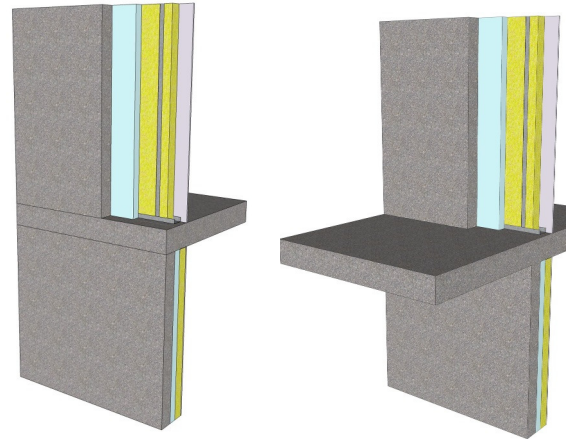

Interior-Insulated Exposed Concrete

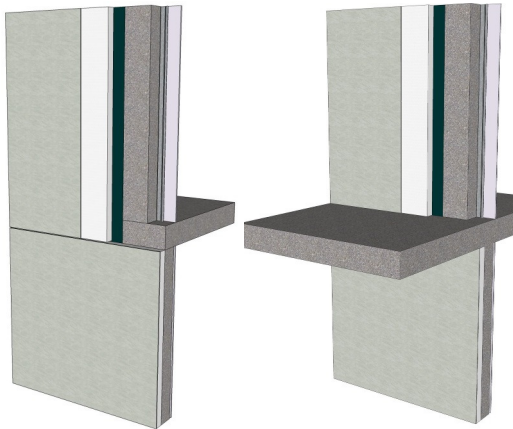

Exterior-Insulated Cast-in-Place Concrete

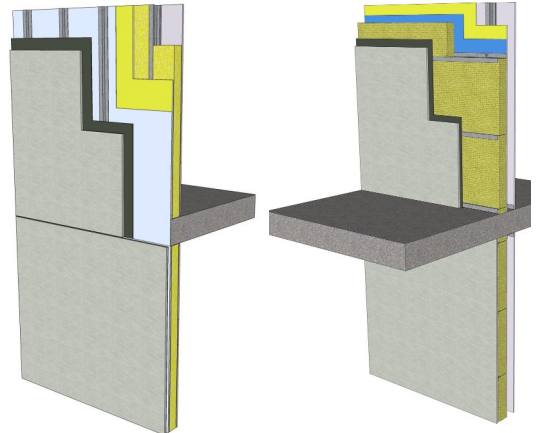

Steel Stud-Insulated

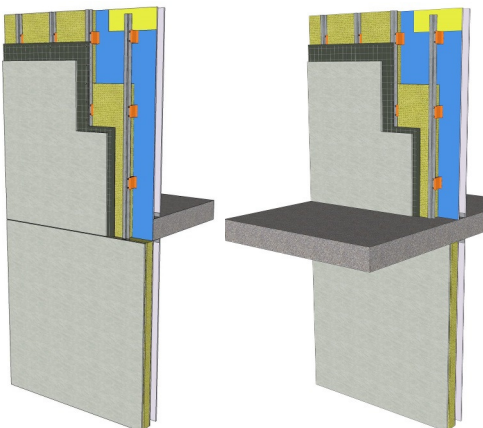

Exterior-Insulated - Various Cladding Supports

Interior-Insulated Exposed Concrete Walls: Effective R-values

An interior-insulated exposed concrete wall is very common in the mid- to high-rise residential construction sector, as it is relatively economical to construct and the cast-in-place concrete provides the exterior cladding and finish. Insulation is placed on the interior of the walls and typically consists of fiberglass batts with some foam insulation against the concrete for moisture control. As the insulation is placed at the interior, the slab edges are uninsulated and thus are large thermal bridges. The performance characteristics of balconies are similar to exposed slab edges. Thermal break products are available for both the balcony thermal bridge (common throughout Europe) and the interior of the slab edge. Effective R-values presented here are for an 8'-8" tall wall with 8" slabs (8' floor to ceiling). Effective R-values with shorter walls will be lower due to the larger proportional impact of the slab edges. R-value in IP and SI units are provided.

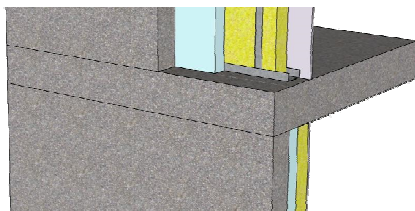

Exposed Concrete Wall

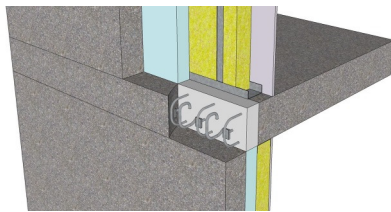

Exposed Concrete Wall with Slab Thermal Break

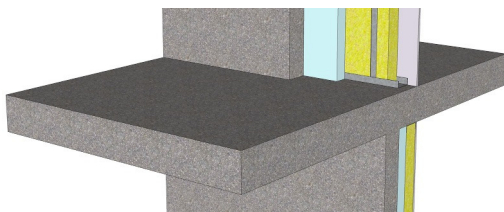

Exposed Concrete Wall with Balcony

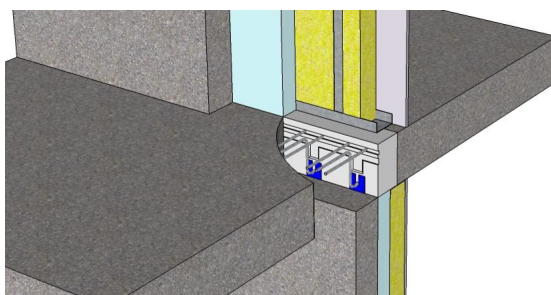

Exposed Concrete Wall with Balcony Slab Thermal Break

R-Values for Wall with Exposed Slab Edge - No Slab Edge Thermal Break

Insulation Strategy	Effective R-Value (RSI)
1" XPS (R-5) + R-12 batts/steel studs @ 16" o.c.	R-7.4 (RSI-1.30)
2" XPS (R-10) + R-12 batts/steel studs @ 16" o.c.	R-8.7 (RSI-1.53)
3" XPS (R-15) + R-12 batts/steel studs @ 16" o.c.	R-9.8 (RSI- 1.72)

R-Values for Wall with Exposed Slab Edge - 3.25" (R-2.5) Thermal Break

Insulation Strategy	Effective R-Value (RSI)
1" XPS (R-5) + R-12 batts/steel studs @ 16" o.c.	R-10.8 (RSI-1.91)
2" XPS (R-10) + R-12 batts/steel studs @ 16" o.c.	R-14.2 (RSI-2.51)
3" XPS (R-15) + R-12 batts/steel studs @ 16" o.c.	R-16.9 (RSI-2.97)

R-Values for Wall with 6' Balcony - No Slab Edge Thermal Break

Insulation Strategy	Effective R-Value (RSI)
1" XPS (R-5) + R-12 batts/steel studs @ 16" o.c.	R-7.5 (RSI-1.32)
2" XPS (R-10) + R-12 batts/steel studs @ 16" o.c.	R-8.9 (RSI-1.56)
3" XPS (R-15) + R-12 batts/steel studs @ 16" o.c.	R-10.0 (RSI-1.77)

R-Values for Wall with 6' Balcony - 3.25" (R-2.5) and 5" (R-5) Thermal Break

Insulation Strategy	Effective R-values (RSI)	
	R-2.5 Thermal Break	R-5.0 Thermal Break
1" XPS (R-5) + R-12 batts/ steel studs @ 16" o.c.	R-11.0 (RSI-1.94)	R-12.1 (RSI-2.13)
2" XPS (R-10) + R-12 batts/ steel studs @ 16" o.c.	R-14.4 (RSI-2.53)	R-16.6 (RSI-2.93)
3" XPS (R-15) + R-12 batts/ steel studs @ 16" o.c.	R-17.0 (RSI-2.99)	R-19.5 (RSI-3.44)

Exterior-Insulated Cast-in-Place Concrete Walls: Effective R-values

An exterior-insulated cast-in-place concrete wall is somewhat common in new mid- to high-rise residential construction, particularly where exterior shear walls are used instead of steel-stud infill. This assembly could also be representative of a retrofit of an older 1960s to 1970s exposed concrete building. Exterior insulation may consist of any number of products and cladding support strategies. For simplicity, a range of insulation R-values in the form of non-thermally bridged, adhered EIFS are provided for reference. Many other solutions are possible, several of which are provided in the following pages. As the insulation is placed on the exterior of the concrete wall, the slab edges are also insulated; however, balconies and eyebrows would be thermal bridges. Thermal break products are available for the balcony thermal bridge. Effective R-values presented here are for an 8'-8" tall wall with 8" slabs (8' floor to ceiling). Effective R-values with shorter walls will be lower due to the larger proportional impact of the slab edges. R-value in IP and SI units are provided.

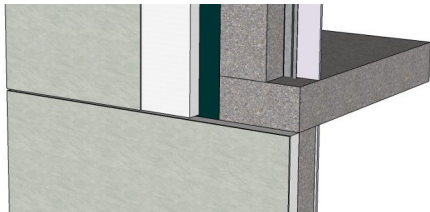

Exterior Insulated Concrete Wall

R-Values for Typical Wall - No Balcony or Exposed Slab Edge

Insulation Strategy	Effective R-Value (RSI)
3" EPS (R-12), Adhered EIFS	R-13.9 (RSI-2.44)
4" EPS (R-16), Adhered EIFS	R-18.0 (RSI-3.16)
6" EPS (R-24), Adhered EIFS	R-25.8 (RSI-4.55)

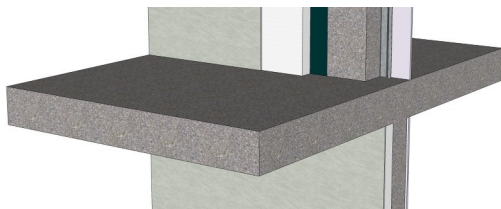

Exterior Insulated Concrete Wall with Balcony

R-Values for Wall with Balcony - No Slab Edge Thermal Break

Insulation Strategy	Effective R-Value (RSI)
3" EPS (R-12), Adhered EIFS	R-7.4 (RSI-1.31)
4" EPS (R-16), Adhered EIFS	R-8.6 (RSI-1.51)
6" EPS (R-24), Adhered EIFS	R-10.6 (RSI-1.86)

Effective R-value reductions range from 47% for the 3" EPS case up to 59% for the 6" EPS case

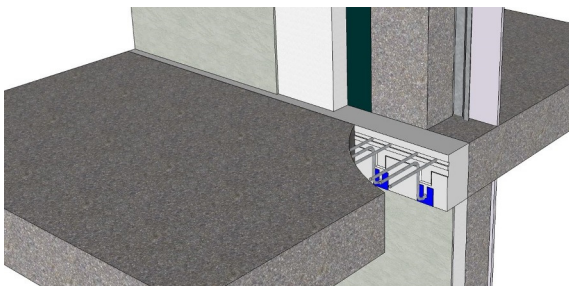

Exterior Insulated Concrete Wall with Balcony Thermal Break

R-values for Wall with Balcony - 3.25" (R-2.5) and 5" (R-5) Thermal Break

Insulation Strategy	Effective R-Value (RSI)	
	R-2.5 Thermal Break	R-5 Thermal Break
3" EPS (R-12), Adhered EIFS	R-11.5 (RSI-2.02)	R-12.6 (RSI-2.22)
4" EPS (R-16), Adhered EIFS	R-13.8 (RSI-2.43)	R-15.7 (RSI-2.76)
6" EPS (R-24), Adhered EIFS	R-17.7 (RSI-3.12)	R-20.9 (RSI-3.68)

Effective R-value improvements (from non-thermally broken baseline) range from 50% up to 100% (e.g. R-20.9 vs R-10.6 for 6" EPS with R-5 thermal break)

Exterior-Insulated Steel Stud Walls: Effective R-values

An exterior insulated steel stud frame wall is very common in new mid to high-rise residential construction. Exterior insulation may consist of any number of products and cladding support strategies. In general intermittently supported claddings using low-conductivity or small metal clips to support girts outside of the insulation provide the highest thermal performance. Continuous girts, whether in a vertical, horizontal or crossing pattern provide relatively poor performance. For simplicity, a range of insulation R-values with two alternate cladding support strategies are provided for reference. Many other solutions are possible. As the insulation is placed on the exterior, the slab edges are insulated; however, balconies and eyebrows would be thermal bridges. Thermal break products are available for the balcony thermal bridge. Effective R-values presented here are for a 8'-8" tall wall with 8" slabs (8' floor to ceiling). Effective R-values with shorter walls will be lower due to the larger proportional impact of the slab edges. R-value in

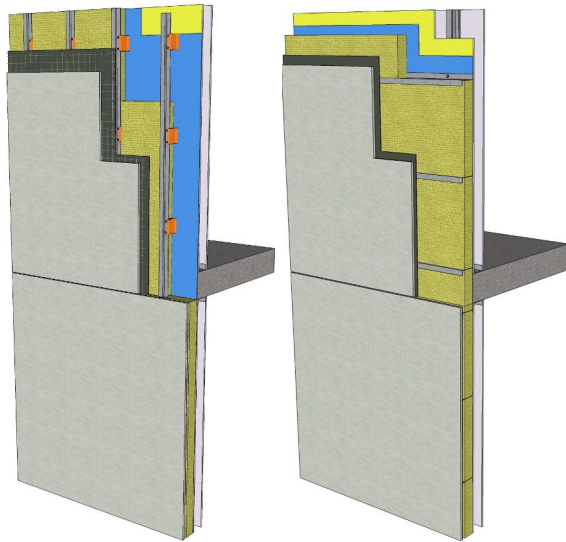

Exterior-Insulated Steel Wall Assemblies with Alternate Cladding Support Strategies (Fiberglass Clips to left and horizontal girts to right)

R-Values for Typical Walls - No Balcony or Exposed Slab Edge

Cladding Support & Insulation Strategy	Effective R-value (RSI)
Fiberglass Clips @16"x24" spacing, 4" MW (R-16) exterior + no insulation in steel studs @ 16" o.c.	R-15.7 (RSI-2.76)
Fiberglass Clips @16"x24" spacing, 4" MW (R-16) exterior + R-12 insulation in steel studs @ 16" o.c.	R-19.5 (RSI-3.43)
Horizontal Z-girts @24" vertically, 4" MW (R-16) exterior + no insulation in steel studs @ 16" o.c.	R-9.0 (RSI-1.58)
Horizontal Z-girts @24" vertically, 4" MW (R-16) exterior + R-12 insulation in steel studs @ 16" o.c.	R-12.2 (RSI-2.15)

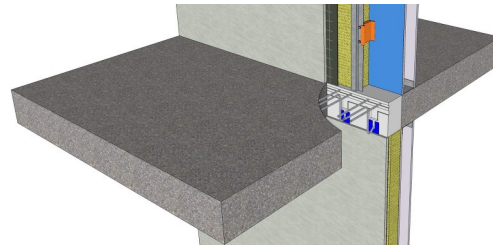

Balcony thermal break within exterior insulated wall assembly

R-Values for Wall with Balcony - Without Thermal Break and with 3.25" (R-2.5) and 5" (R-5) Thermal Break

Cladding Support & Insulation Strategy	Effective R-Value (RSI)		
	No Thermal Break - Exposed Slab	R-2.5 Thermal Break	R-5 Thermal Break
Fiberglass clips 16"x24" spacing, 4" MW (R-16) exterior + no insulation in steel studs @ 16" o.c.	R-8.5 (RSI- 1.50)	R-13.2 (RSI-2.33)	R-14.2 (RSI-2.50)
Fiberglass clips 16"x24" spacing, 4" MW (R-16) exterior + R-12 FG in steel studs @ 16" o.c.	R-9.5 (RSI- 1.67)	R-14.9 (RSI-2.62)	R-16.9 (RSI-2.97)
Horizontal Z-girts @ 24" vertically, 4" MW (R-16) exterior + no insulation in steel studs @ 16" o.c.	R-6.5 (RSI- 1.15)	R-8.2 (RSI-1.44)	R-8.6 (RSI-1.52)
Horizontal Z-girts @ 24" vertically, 4" MW (R-16) exterior + R-12 FG in steel studs @ 16" o.c.	R-8.4 (RSI- 1.48)	R-11.2 (RSI-1.97)	R-11.9 (RSI-2.10)

Interior-Insulated Steel Stud Walls: Effective R-values

An interior insulated steel stud wall is still somewhat common in mid- to high-rise residential construction in many parts of North America even as it provides relatively poor thermal performance due to thermal bridging through the steel studs. The slab edges are also uninsulated, resulting in large thermal bridges and lower effective R-values. Thermal break products are available for the balcony thermal bridge; however, they will have a diminished impact due to the relatively poor wall thermal performance. Effective R-values presented here are for an 8'-8" tall wall with 8" slabs (8' floor to ceiling). Effective R-values with shorter walls will be lower due to the larger proportional impact of the slab edges. R-value in IP and SI units are provided.

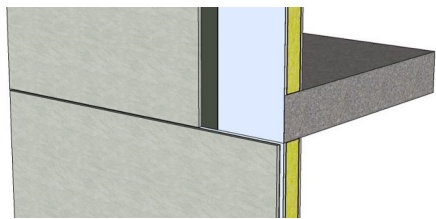

Steel Stud Insulated Wall
(Note discontinuous insulation at the slab edge.)

R-Values for Typical Wall - No Balcony or Exposed Slab Edge

Insulation Strategy	Effective R-Value (RSI)
3 5/8" Steel studs without insulation (empty)	R-2.9 (RSI-0.51)
3 5/8" steel studs with R-12 batt insulation	R-5.5 (RSI-0.98)
6" steel studs with R-20 batt insulation	R-6.4 (RSI-1.13)

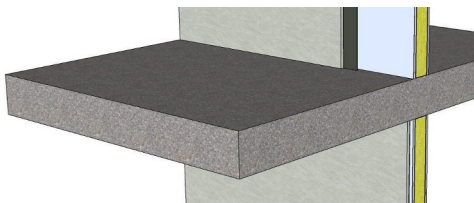

Steel Stud Insulated Wall with Balcony

R-Values for Wall with Balcony - No Slab Edge Thermal Break

Insulation Strategy	Effective R-Value (RSI)
3 5/8" steel studs with R-12 batt insulation	R-3.6 (RSI-0.64)
6" steel studs with R-20 batt insulation	R-4.2 (RSI-0.74)

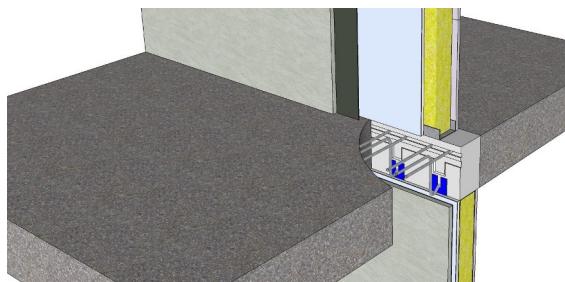

Steel Stud Insulated Wall with
Balcony Thermal Break

R-Values for Wall with Balcony - 3.25" (R-2.5) and 5" (R-5) Thermal Break

Insulation Strategy	Effective R-Value (RSI)	
	R-2.5 Thermal Break	R-5 Thermal Break
3 5/8" steel studs with R-12 batt insulation	R-4.1 (RSI-0.72)	R-4.2 (RSI-0.74)
6" steel studs with R-20 batt insulation	R-4.7 (RSI-0.82)	R-4.8 (RSI-0.85)

Impact of Exposed Slab Edges & Balconies on Energy Code Compliance

In Canada and the USA, ASHRAE Standard 90.1 is the most commonly referenced energy standard within building codes. Other energy standards, including the NECB in Canada and IECC in the USA, are also referenced and follow similar procedures to ASHRAE 90.1 for determining energy code compliance for building enclosure systems. In general, there are three pathways by which the thermal performance of the building enclosure is assessed for compliance, including a **prescriptive path**, a **building enclosure trade-off path**, and an **energy modeling path**. Each of these compliance paths relies on the effective R-values of the building enclosure assemblies.

As demonstrated in this report and reiterated in the plot to the right, uninsulated slab edges and balconies will have a profound impact on the effective R-value of the opaque wall assemblies which they penetrate. Likewise, balcony and slab edge thermal breaks will have a significant contribution toward improving wall R-values in order to meet energy code compliance requirements.

When following a prescriptive path toward building enclosure compliance, the effective R-values of all of the wall assemblies (which includes the slab area) must be greater than a minimum effective R-value (typically in the range of R-10 to R-20, depending on climate zone and building type). When exposed slab edges or balconies are incorporated in a building design, it can be almost impossible to achieve prescriptive compliance without the use of some sort of slab edge thermal break. This is demonstrated in the adjacent graphs where the percentage of wall area occupied by slab/balcony detail (uninsulated and thermally broken) is plotted against the overall effective R-value for that combined wall (R-18.2 baseline wall shown). Typical percentages for the exposed slab edge for different window-to-wall ratios and floor-to-ceiling heights are provided in the table below. Where slab edges/balconies are uninsulated, they have a profound impact on the overall wall R-value. Balcony thermal breaks improve the overall R-value significantly. This simple analysis can be used as a preliminary design tool to estimate the effective R-value of a wall based on the balcony-to-opaque wall ratio and determine whether prescriptive compliance can be met.

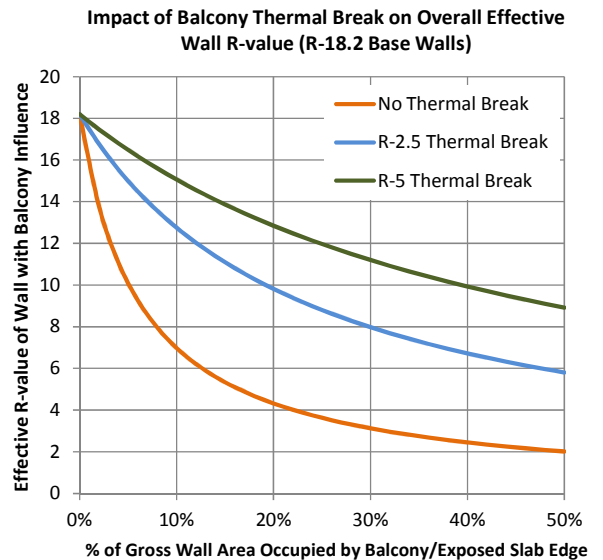
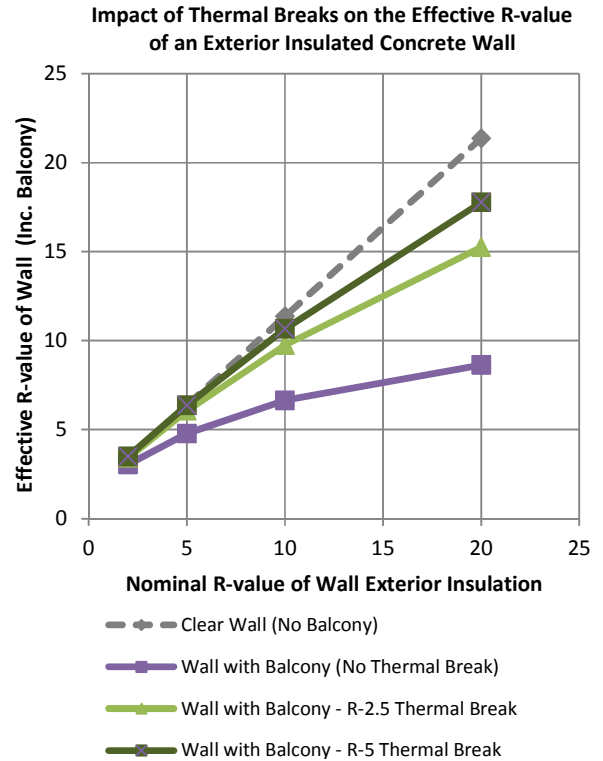

Exposed Slab Edge Percentage for Different WWR and ceiling heights	100% wall: 0% windows	60% wall: 40% windows	50% wall: 50% windows	40% wall: 60% windows	20% wall: 80% windows
8" slab, 8' floor-to-ceiling	7.7%	12.8%	15.4%	19.2%	38.5%
8" slab, 9' floor-to-ceiling	6.9%	11.5%	13.8%	17.2%	34.5%

Impact of Exposed Slab Edges & Balconies on Energy Code Compliance

Prescriptive energy code compliance for the building enclosure can be very difficult to achieve where uninsulated exposed slab edges, eyebrows, or balconies are present in a building design. As a result, many architects and engineers will instead choose to follow either the building enclosure trade-off or whole-building energy modeling compliance paths.

In both of these alternate compliance paths, the effective R-values for every assembly and detail is determined and then an overall effective R-value for the whole building enclosure is determined. In the **building enclosure trade-off path**, the calculated effective R-value for the building (plus some allowance for solar heat gain and daylighting through the windows) is compared to that for a minimally code-compliant building.

This allows for designers to trade-off non-prescriptively compliant thermally performing elements with higher thermally performing ones. As an example, window areas may be adjusted or higher performance windows selected to compensate for high enclosure losses. In addition, small areas of uninsulated slab edges or balconies may be traded-off with extra insulation somewhere else, such as in the wall; however, the effectiveness of this approach is minimal due to the large thermal bridge and low R-value at the slab edge. This phenomenon is demonstrated in the above plot, and it can be shown in similar analyses that no reasonable amount of insulation can be added to the walls (or roofs) in some buildings to offset the losses at the uninsulated slab areas. As a result, the incorporation of slab edge or balcony thermal breaks are often required in order to make the enclosure comply with the building enclosure trade-off path.

In the **whole-building energy modeling compliance path**, the effective R-values for the building enclosure (including slab edge details) are input into a whole-building energy model and the total energy consumption is determined. Compliance is assessed based on the energy use and cost as compared to a baseline building with minimally compliant enclosure assemblies. Similar to the other trade-off analyses, slab edge and balcony details play a significant role, often the second most important after window selection.

Impact of Uninsulated Slab Edge/Balcony on Overall Effective Wall R-value

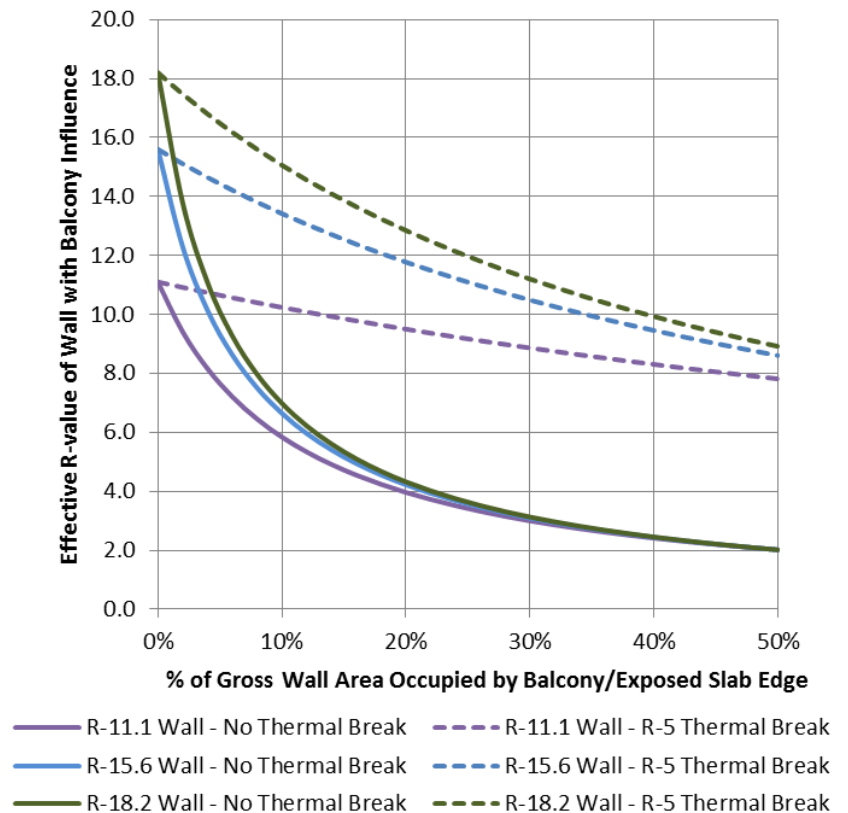

Conclusions: Effective R-values and Energy Code Compliance

Thermal bridging in building enclosure systems often significantly reduces the effective R-value of wall assemblies. As the industry moves toward higher R-value assemblies to meet more stringent building codes, energy standards, and occupant expectations, the reduction of this thermal bridging will be necessary. In many buildings, exposed slab edges, balconies, and eyebrows are one of the most significant thermal bridging elements.

Several typical North American wall assemblies have been examined here to determine the impact of concrete balconies and slab edges on the thermal effectiveness of building enclosure assemblies. The benefits of balcony and slab edge thermal break products were also demonstrated.

As shown within this report, thermal bridges caused by uninsulated concrete slab edges and balconies can reduce the effective R-value of full-height wall assemblies by up to 60% and therefore have a profound impact on the performance of the opaque wall assemblies they penetrate. Likewise, incorporating balcony and slab edge thermal breaks will improve the effective R-values by up to 100% over non-thermally broken slabs and therefore have a significant contribution toward improving wall R-values in order to meet energy code compliance requirements.

In general, there are three pathways by which the thermal performance of the building enclosure is assessed for energy code compliance including a: prescriptive path, building enclosure trade-off path, and a whole-building energy modeling path. Each of these compliance paths relies on effective R-value inputs of the building enclosure assemblies. When following the prescriptive path, it can be very challenging to achieve energy code compliance where building designs incorporate exposed slab edges or balconies unless thermal break systems are used.

Overall, balcony slab edge thermal break systems provide architectural freedom to designers while maintaining the thermal performance characteristics of the building to reduce building energy consumption, improve thermal comfort, and meet increasingly stringent building code requirements. While these systems are currently uncommon in typical North American construction, as the industry develops, the incorporation of these systems in to building design will likely become increasingly commonplace.

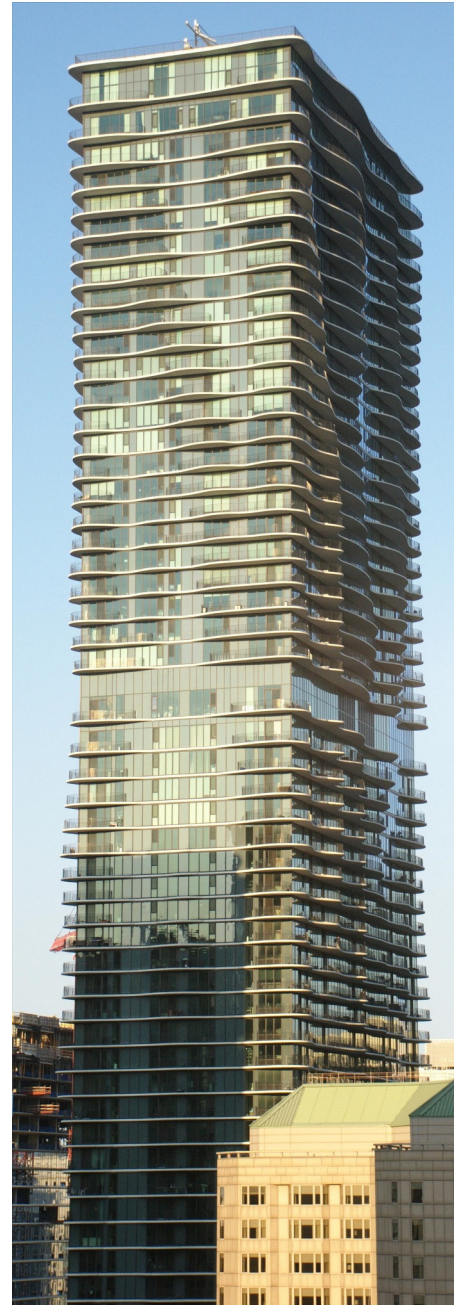

Appendix: Thermal Modeling Inputs & Material Data

Thermal Modeling: Determination of R-Values, U-Values, and Linear Transmittance

The effective R-values for several typical wall assemblies with varying insulation levels were calculated using the three-dimensional finite element thermal modeling software, Heat3. This program has been validated to ISO 10211 standards and is widely used by researchers and consultants to perform advanced thermal simulations to calculate 3D effective R-values of building enclosure assemblies and details. RDH has also performed in-house confirmation of the software results with published guarded hot-box laboratory and ASHRAE 90.1 thermal data.

To calculate R-values a variety of different inputs were used within the Heat3 software. The models were created using the material properties provided on the following page and the boundary conditions as defined in the table below and illustrated in the image to the right. The exterior temperature was changed from the standard -17.8 °C to -10° C to be more indicative of typical exterior conditions for the calculation of surface temperatures. Heat3 performs a finite difference calculation to determine the heat flow through the assembly, which is then divided by the temperature difference to determine U-value. The inverse of the U-value is the R-value.

Linear transmittance was calculated by first modeling the wall without a slab edge or balcony, and then modelling it with the slab edge or balcony detail to determine their respective U-values. Then, the formula below was used to calculate linear transmittance (ψ).

$$\Psi = \frac{(U_{Wall - WithSlabEdge} - U_{Wall - NoSlabEdge}) \cdot A_{wall}}{L_{slab}}$$

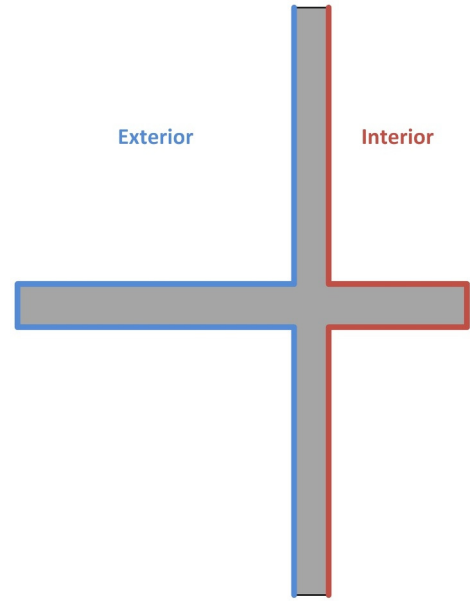

Boundary Conditions - R-value Models

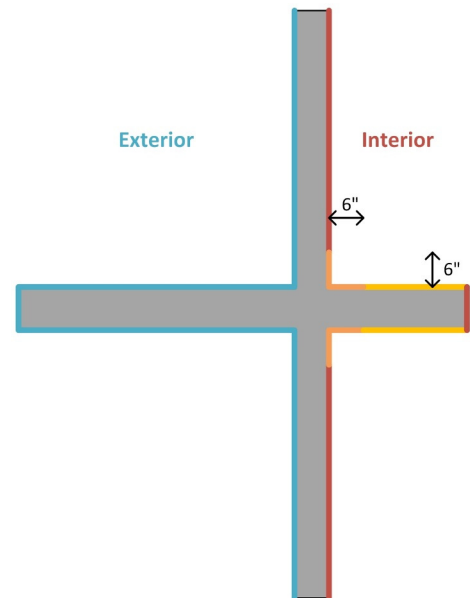

Boundary Conditions- Surface Temperature Models

Boundary Condition	Temperature (°C)	Surface Film Coefficient (W/m ² ·K)
Exterior - R-Values	-17.8	23
Exterior - For Surface Temperatures	-10	23
Interior - R-Values	21	7.7
Interior - For Surface temperatures - Corner of Floor to Ceiling	21	4
Interior - For Surface Temperatures - Floor and Ceiling	21	6
Interior - For Surface Temperatures - Wall	21	7.7

Material Properties for Thermal Modeling

The following material properties were used within the Heat3 thermal models used to calculate effective R-values and temperatures to assess thermal comfort. These properties are based on published material data from numerous industry sources including ASHRAE, NRC, and product manufacturers.

Material Description		Thermal Conductivity, k (W/m · K)
Mineral Fiber or Fiberglass Insulation	R-3.0/inch Batts	0.048
	R-3.4/inch Batts	0.042
	R-3.6/inch Batts	0.040
	R-3.8/inch Batts	0.038
	R-4.2/inch Cavity Insulation	0.034
Extruded Polystyrene	R-5/inch Board	0.029
Expanded Polystyrene	R-4/inch standard board	0.030
	R-4.6/inch graphite enhanced	0.031
Closed-Cell Sprayfoam	R-6/inch	0.024
Concrete (Temperature Steel Reinforced)		2.000
Concrete (Light Beam Reinforced)		3.000
Concrete (Heavy Beam Reinforced)		4.700
Steel	Galvanized Sheet (studs/girts)	62.000
	Stainless (ANSI 304)	14.300
	Rebar	50.000
Gypsum Sheathing/Drywall		0.160
Ventilated Airspace		0.450
Wood	Framing	0.140
	Plywood	0.110
Stucco (Cement-Lime)		0.720
Brick (North American Clay Brick)		0.450
Balcony/Slab Edge Thermal Break - Schoeck Isokorb, Range of values for standard products. Actual project values will depend on structural requirements for balcony support.	R-2.5 (80 mm, 3.25")	0.181
	R-3.4 (80 mm, 3.25")	0.134
	R-3.4 (120 mm, 5")	0.200
	R-4.5 (120 mm, 5")	0.151
	R-5.0 (120 mm, 5")	0.135
	R-5.7 (120 mm, 5")	0.120

