

The Molecular Biology of Memory Storage: A Dialog Between Genes and Synapses

Eric R. Kandel¹

The biology of learning, and short-term and long-term memory, as revealed by *Aplysia* and other organisms, is reviewed.

KEY WORDS: *Aplysia*; learning; memory; serotonin.

INTRODUCTION

One of the most remarkable aspects of an animal's behavior is the ability to modify that behavior by learning, an ability that reaches its highest form in human beings. For me, learning and memory have proven to be endlessly fascinating mental processes because they address one of the fundamental features of human activity: our ability to acquire new ideas from experience and to retain these ideas in memory. In fact, most of the ideas we have about the world and our civilization we have learned so that we are who we are in good measure because of what we have learned and what we remember. However, not all learning experiences are positive. Many psychological and emotional problems result at least in part from our experiences. In addition, specific disorders of learning and memory haunt both the infant and the adult. Down syndrome, fragile X mental retardation, age-related loss of memory, and the devastation of Alzheimer's disease are only the familiar examples of a large number of disorders that affect memory.

Throughout my career I have been interested in the biology of learning. I have been curious to know: What changes in the brain when we learn? And, once something is learned, how is that information retained in the brain? I have tried to address these questions by developing a reductionist approach that would allow me to investigate elementary forms of learning and memory at a cell and molecular level—as specific molecular activities within specific identified nerve cells.

For a biologist like myself, interested in mental processes, the study of learning has the further appeal that, unlike other mental processes such as thought, language

¹Columbia University, College of Physicians and Surgeons, 722 West 168 Street, New York, NY10032, USA. E-mail: erk5@columbia.edu

and consciousness, learning is relatively accessible to a cellular and molecular analysis. Elementary forms of learning and memory have been well characterized by classical psychology since the work of Ivan Pavlov and Edgar Thorndike in the first half of the 20th century, and these forms of learning are the most clearly delineated and, for the experimenter, most easily controlled of any mental process.

I first became interested in the study of memory in 1950 as a result of my readings in psychoanalysis while still an undergraduate at Harvard College. Later, during medical training, I found the psychoanalytic approach limiting because it tended to treat the brain, the organ that generates behavior, as a black box. In the mid 1950s, while still in medical school, I began to appreciate that during my generation the black box of the brain would be opened and that the problems of memory storage, once the exclusive domain of psychologists and psychoanalysts, could be investigated with the methods of modern biology. As a result, my interest in memory shifted from a psychoanalytic to a biological approach. As a postdoctoral fellow at the National Institutes of Health (NIH) in Bethesda from 1957 to 1960 I focused on learning more about the biology of the brain, and became interested in knowing how learning produces changes in the neural networks of the brain and how a transient short-term memory is converted to an enduring long-term memory.

From the beginning, my purpose in translating questions about the psychology of learning into the empirical language of biology was not to replace the logic of psychology or psychoanalysis with the logic of cell and molecular biology, but to try to join these two disciplines and to contribute to a new synthesis that would combine the mentalistic psychology of memory storage with the biology of neuronal signaling. As I thought more concretely about the neural mechanisms of memory storage, I hoped further that the biological analysis of memory might carry with it an extra bonus, that the study of memory storage might reveal new aspects of neuronal signaling. Indeed, this has proven true. Time and again, the molecular study of memory has revealed novel aspects of more general biological processes.

DEVISING A RADICAL REDUCTIONIST STRATEGY TO LEARNING AND MEMORY

At first thought, someone interested in learning and memory might be tempted to tackle the problem in its most complex and interesting form. This was the approach that my colleague Alden Spencer and I originally had in 1958 when, at the start of our scientific careers, we joined forces at the NIH to study the cellular properties of the hippocampus, the part of the mammalian brain thought to be most directly involved in aspects of complex memory [1]. We were initially interested in a simple question: Are the electrophysiological properties of the pyramidal cells of the hippocampus, which were thought to be the key hippocampal cells involved in memory storage, fundamentally different from other neurons in the brain, such as the well-studied motor neurons in the spinal cord involved in simple movement? In the course of studying the pyramidal cells of the hippocampus, it became clear to us that all nerve cells have similar signaling properties. Therefore, the intrinsic signaling properties of neurons would themselves not give us key insights into memory storage [17].

Thus, the unique functions of the hippocampus had to arise not so much from the intrinsic properties of pyramidal neurons but from the pattern of functional interconnections of these cells, and how those interconnections are affected by learning. To tackle that problem we needed to know how sensory information about a learning task reaches the hippocampus, and how information processed by the hippocampus influences behavioral output. This was a formidable challenge, since the hippocampus has a large number of neurons and an immense number of interconnections. It seemed unlikely that we would be able to work out in any reasonable period of time how the neural networks, in which the hippocampus was embedded, participate in behavior and how those networks are affected by learning.

Thus, to bring the power of modern biology to bear on the study of learning, it seemed necessary to take a very different approach—a radically reductionist approach. Instead of studying the most complex cases, we needed to study the simplest instances of memory storage, and to study them in animals that were most experimentally tractable. To do this we needed to find experimental systems in which a simple behavioral act that could be modified by learning was controlled by a small number of large and accessible nerve cells. Only in this way could we correlate changes in the overt behavior of the animals with molecular events in identifiable neurons and examine how sensory processing in the brain is modified by learning to give rise to memories.

Such a reductionist approach was hardly new in 20th century biology. One need only think of the use of *Drosophila* in genetics, of bacteria and bacteriophages in molecular biology, and of the squid giant axon in the study of the conduction of nerve impulses. Nevertheless, when it came to the study of behavior, many investigators were reluctant to use a reductionist strategy. In the 1950s and 1960s many biologists and psychologists believed that behavior was the one area of biology in which the use of simple animal models, particularly invertebrate ones, was least likely to succeed. They argued that only higher animals exhibit interesting forms of learning and that these forms require neuronal organizations and neuronal mechanisms qualitatively different from those found in simple animals. As a result, an approach to learning based on simple invertebrates was bound to fail because it would lack relevance to mammalian and particularly to human behavior.

It was my belief at the outset, however, that concerns about the use of a simple experimental system to study learning were misplaced. The question was and is not whether there is something special about the human brain; there clearly is. Rather, the question is whether the human brain and human behavior have anything at all in common with the nervous system and behavior of simpler animals. If so, these fundamental, common principles of neuronal organization might well be studied more profitably in simple animals.

The answer to this second question, about commonality, was clear. By 1960, work by students of comparative behavior such as Konrad Lorenz, Niko Tinbergen, and Karl von Frisch had shown that humans share many behavioral patterns and even simple forms of learning with simple animals [reviewed in 2]. That the evolution of behavior and learning is conservative should not be surprising, since the evolution of other biological functions is also conservative. There are, for example, no fundamental functional or biochemical differences between the nerve cells and synapses

of humans and those of a snail, a worm or a fly. Since behavior and learning is an expression of nerve cell activity, it would be surprising if the learning capability of people did not have some elementary features in common with the learning of snails, worms, or flies. And, if elementary forms of learning are common to all animals with an evolved nervous system, there must be conserved features in the mechanisms of learning at the cell and molecular level, that can be studied effectively even in simple invertebrate animals.

A SIMPLE INVERTEBRATE SYSTEM THAT LENDS ITSELF TO A REDUCTIONIST APPROACH

After an extensive search for a suitable experimental animal, I settled on the giant marine snail *Aplysia* (Fig. 1), because it offers three important experimental advantages: its nervous system is made up of a small number of nerve cells; many of these are very large; and (as became evident to me later) many are uniquely identifiable [3,13]. Whereas the mammalian brain has a trillion central nerve cells, *Aplysia* has only 20,000. These cells are clustered in ten anatomical units called



Fig. 1. The giant marine snail *Aplysia californica* belongs to the opisthobranch subclass of the gastropod molluscs. Animals of this species may grow to be 30 cm in length and weigh 1 kg.

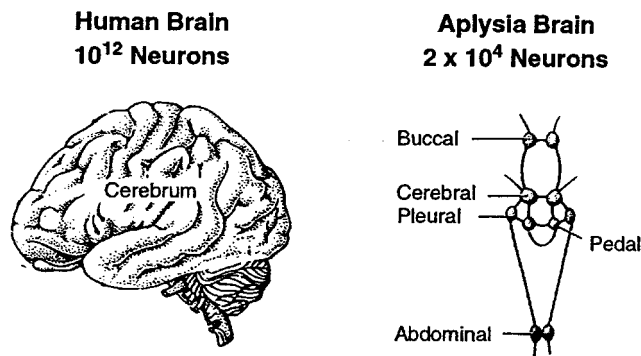

Fig. 2. The human brain has a million-million neurons while the brain of *Aplysia* has 20,000 nerve cells. *Aplysia* nerve cells are clustered together in five major bilateral ganglia, each containing about 2000 nerve cells.

ganglia, each of which contains about 2000 cells (Fig. 2). An individual ganglion, such as the abdominal ganglion, mediates not one but a family of behaviors. Thus, the simplest behaviors that can be modified by learning may involve less than 100 cells. This numerical simplification made it possible to identify the specific contribution of individual neurons to the behavior in which they participate [13]. In addition to being few in number, these cells are the largest nerve cells in the animal kingdom, reaching up to $1000\ \mu\text{m}$ in diameter, large enough to be seen with the naked eye (Fig. 3). Because of their extraordinary size and their distinctive pigmentation, it is possible to recognize many of the cells as unique individuals. One can

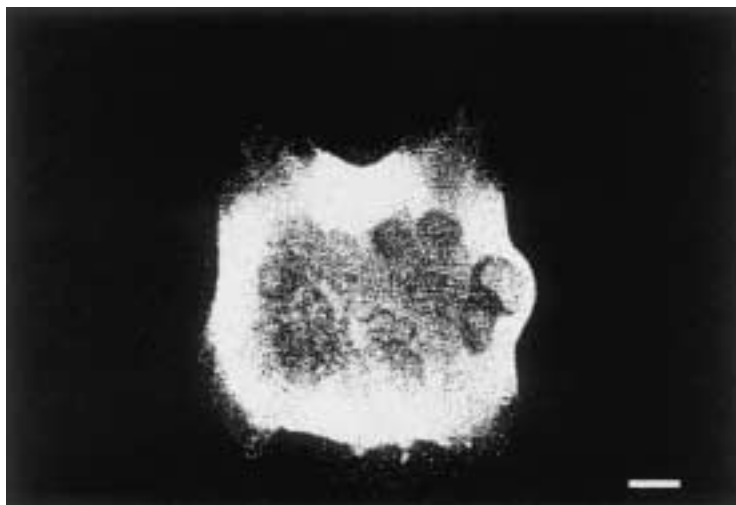

Fig. 3. A photomicrograph of an abdominal ganglion of *Aplysia* shows the distinctive pigmentation and positions of its cells. The largest cells are a millimeter in diameter and can be seen with the naked eye. Scale bar = 1 mm.

record from these large cells for many hours without any difficulty, and the same cell can be returned to and recorded from over a period of days. The cells can easily be dissected out for biochemical studies, so that from a single cell one can obtain sufficient mRNA to make a cDNA library. Finally, these identified cells can readily be injected with labeled compounds, antibodies, or genetic construct procedures which opened up the molecular study of signal transduction within individual nerve cells.

REQUIREMENT FOR A CELL-BIOLOGICAL STUDY OF MEMORY STORAGE

Given a technically advantageous experimental system, how does a cell biologist begin to address the problem of learning? The strategy that my colleagues and I developed involved four sequential steps: (1) We first wanted to define a simple behavior that can be modified by learning and that gives rise to memory storage. (2) We next wanted to identify the cells that make up the neural circuit of that behavior. (3) Within that neural circuit we then wanted to locate the critical neurons and interconnections that had been modified by learning and that store memory. (4) Finally, we wanted to analyze the changes that occur at those sites in response to learning and memory storage, first on the cellular and then on the molecular level [13]. I follow this outline in the discussion below.

DELINEATING A BEHAVIOR IN *APLYSIA* THAT IS CAPABLE OF BEING MODIFIED BY LEARNING

Irving Kupfermann and I first wanted to study the simplest possible behavior of *Aplysia* [4]. We examined the animal's behavioral capabilities and delineated a very simple defensive reflex: the withdrawal of the gill upon stimulation of the siphon, an action that is like the quick withdrawal of a hand from a hot object. In *Aplysia*, the gill is a respiratory organ that lies exposed in the mantle cavity. When the animal is in a normal, relaxed state, the gill is partially covered by a sheet of skin (the mantle shelf), which ends in a fleshy spout, the siphon (Fig. 1). When a weak tactile stimulus is applied to the siphon, both the siphon and gill are withdrawn into the mantle cavity and for protection under the mantle shelf [(Fig. 4); ref. 5].

Kupfermann, Harold Pinsker, and later Tom Carew, Robert Hawkins and I found that this simple reflex could be modified by three different forms of learning: habituation, sensitization, and classical conditioning [5, 8, 9]. As we examined these three forms of learning, we were struck by the resemblance each had to corresponding forms of memory storage in higher vertebrates and humans. As with vertebrate learning, memory storage for each type of learning in *Aplysia* has two phases: a transient memory that lasts minutes and an enduring memory that lasts days. Conversion of short-term to long-term memory storage requires spaced repetition—practice makes perfect even in snails [8, 9, 10].

We focused initially on one type of learning, *sensitization*, a form of learned fear in which a person or an experimental animal learns to respond strongly to an otherwise neutral stimulus [5, 8, 10]. For example, if a person is suddenly exposed to

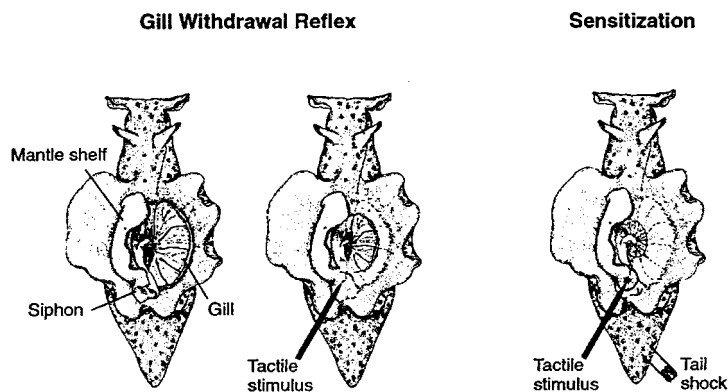

Fig. 4. A dorsal view of *Aplysia* showing the gill, the animal's respiratory organ. A light touch to the siphon cavity with a fine probe causes the siphon to contract and the gill to withdraw under the protection of the mantle shelf. Here, the mantle shelf is shown to be retracted for a better view of the gill. Sensitization of the gill-withdrawal reflex, produced by applying a noxious stimulus to another part of the body, such as the tail, leads to an enhancement of the withdrawal reflex of both the siphon and the gill.

an aversive stimulus, such as a gunshot going off nearby, that person will be sensitized by the unexpected noise. As a result, that person will be frightened and will now startle to an otherwise innocuous stimulus like a tap on the shoulder. Similarly, on receiving an aversive shock to another part of the body such as the tail (or head), an *Aplysia* recognizes the stimulus as aversive and learns to enhance its defensive reflex responses to a variety of subsequent stimuli applied to the siphon, even innocuous stimuli [Fig. 4; 12]. The animal now remembers the shock, and the duration of this memory is a function of the number of repetitions of the noxious experience. A single shock gives rise to a memory lasting only minutes; this short-term memory does not require the synthesis of new protein. In contrast, four or five spaced shocks to the tail give rise to a memory lasting several days; this long-term memory does require the synthesis of new protein. Further training gives rise to an even more enduring memory lasting weeks, which also requires new protein synthesis [Fig. 5; 10, 12].

Thus, just as in the complex learning in mammals [107, 108], long-term sensitization differs from the short-term process in requiring the synthesis of new proteins. This was our first clear evidence for the conservation of biochemical mechanisms between *Aplysia* and vertebrates, and it reinforced the hope that a detailed analysis of short-term memory and its transition to long-term memory in *Aplysia* would reveal molecular mechanisms of general importance.

DEFINING THE NEURAL CIRCUIT IN CELLULAR DETAIL

To analyze the cellular mechanisms of sensitization, we needed to identify the neural circuit of the gill withdrawal reflex. Kupfermann and I quickly localized the

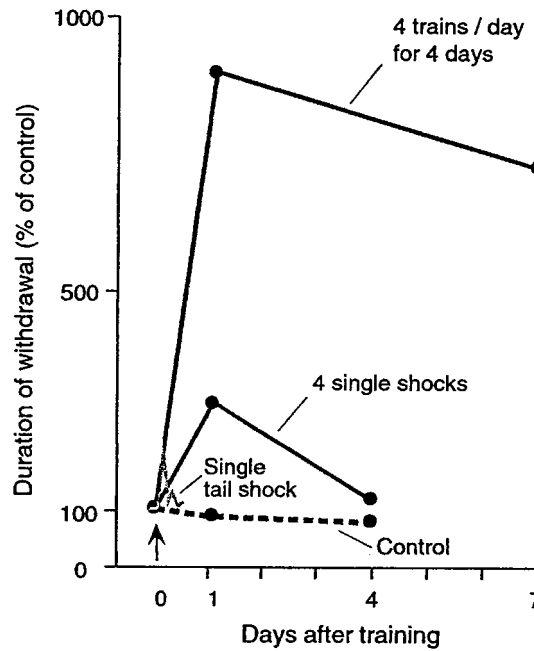

Fig. 5. Spaced repetition converts short-term memory into long-term memory in *Aplysia*. In the resting state, before sensitization training, the animal withdraws its siphon and gill only briefly in response to mild touch of the siphon. After the animal receives a single noxious shock to the tail, it withdraws its siphon and gill longer in response to the same mild touch of the siphon. Sensitization following a single noxious stimulus lasts about one hour. After four or five single tail shocks the animal withdraws its gill and siphon more powerfully and the sensitization lasts more than a day. If the animal receives four brief trains of single shocks a day over the course of four days, it withdraws its siphon and gill for almost eight times as long and retains the memory for several weeks. [Modified from 98.]

central neuronal machinery for the reflex behavior in the animal's abdominal ganglion [4, 6]. Because we soon realized that many cells could be identified in every animal of the species [3, 4, 6, 7], we were able to give them specific names and, most important, return to the same cell time and again—in both untrained and trained animals. In this way Kupfermann, Castellucci, Carew, Hawkins, John Byrne, and I were able to work out significant components of the neural circuit gill-withdrawal reflex in terms of individual cells and cell clusters. The circuit has 24 mechanoreceptor sensory neurons that innervate the siphon skin and make direct monosynaptic connections with six gill motor cells [7, 11, 36]. The sensory neurons also made indirect connections with the motor cells through small groups of excitatory and inhibitory interneurons [18, 19]. In addition to being identifiable, individual cells also

proved to have surprisingly large effects on behavior [Fig. 6C; reviewed in 13, 22, 36].

As we examined the neural circuit of this reflex in detail, we were struck by its invariance—the cells that make up the circuit and their interconnections are always the same. In every animal we examined, each cell connected only to certain target cells and not to others (Fig. 7). Carew, John Koester, Wayne Hening, and I also found this invariance in the neural circuitry of other behaviors in *Aplysia*—inking, control of the circulation, locomotion [reviewed in 13, 15]—raising a key question in the cell-biological study of learning: How can learning occur in a neural circuit that is precisely wired?

HOW DOES LEARNING AFFECT THE INVARIANT ELEMENTS OF THE NEURAL CIRCUIT?

In his Croonian Lecture to the Royal Society of 1894, Santiago Ramón y Cajal proposed a theory of memory storage: memory is stored in the growth of new connections [16]. This prescient idea was neglected in good part for half a century as students of learning fought over newer competing ideas. First, Karl Lashley, Ross Adey, Wolfgang Köhler, and a number of Gestalt psychologists proposed that learning leads to changes in electric fields or chemical gradients, which they postulated surround neuronal populations and are produced by the aggregate activity of cells recruited by the learning process. Second, Alexander Forbes and Lorente de Nó proposed that memory is stored dynamically by a self-reexciting chain of neurons. This idea was later championed by Donald Hebb as a mechanism for short-term memory. Finally, Holger Hyden proposed that learning led to changes in the base composition of DNA or RNA. Even though there was much discussion about the merits of each of these ideas, there was no direct evidence to support any of them [reviewed in 17].

We were now in a position to address these alternative ideas by confronting directly the question of how learning can occur in a circuit with fixed neuronal elements. Kupfermann, Castellucci, Carew, Hawkins, and I examined the neural circuit of the gill-withdrawal reflex while the animal underwent sensitization or habituation, a form of learning in which the animal learns to ignore an innocuous stimulus to siphon when given with monotonous repetition. (We later also extended these studies to an examination of classical conditioning [20].) Our studies provided clear evidence for Cajal's idea: learning results from changes in the strength of the synaptic connections between precisely interconnected cells [6, 7]. Thus, while the organism's developmental program assures that the connections between cells are invariant, it does not specify their precise strength. Rather, experience alters the strength and effectiveness of these pre-existing chemical connections. Seen in the perspective of these three forms of learning, synaptic plasticity emerged as a fundamental mechanism for information storage by the nervous system, a mechanism that is built into the very molecular architecture of chemical synapses [95].

We soon appreciated that the synaptic strength of a chemical synapse could be modified in two ways: homosynaptically and heterosynaptically. *Homosynaptic* changes in synaptic strength occur in a synapse because of activity in the presynaptic and postsynaptic neurons of that very synapse. During habituation, homosynaptic

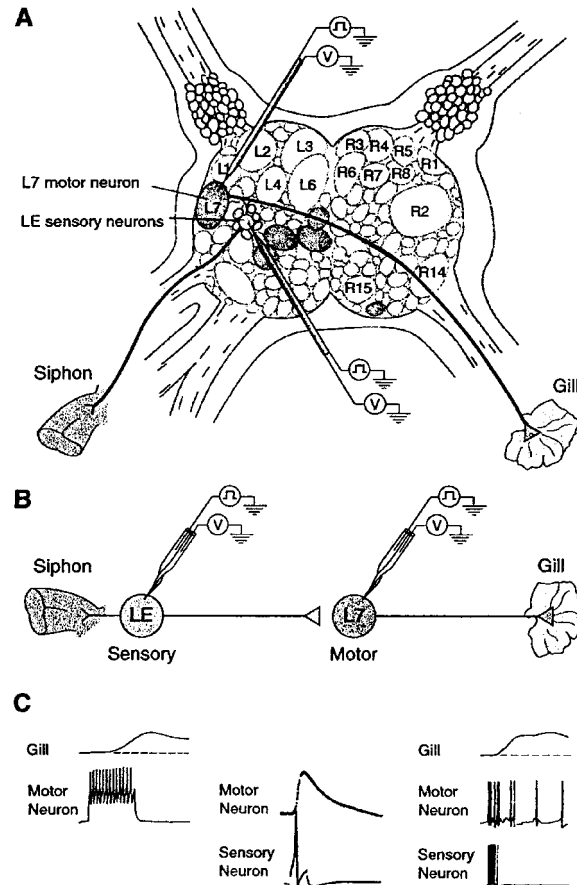

Fig. 6. The neural circuit of the gill-withdrawal reflex can be delineated in terms of specific identified cells. **A.** This dorsal view of the abdominal ganglion shows some identified cells. The six identified motor cells to the gill are shaded brown; seven sensory neurons are shaded blue. In the figure a sensory neuron that synapses on gill motor neuron L7 is being stimulated electrically. A microelectrode in the motor neuron records the synaptic potential produced by the action potential in the sensory neuron. **B.** The physiological demonstration of the direct connections between the sensory neuron and motor neuron. The sensory neuron receives input from the siphon skin; the motor neuron makes direct connections onto the gill. The fact that the cells are large and identifiable allows for the mapping of connections between specific identified cells. This part also shows the experimental arrangement for simultaneously recording in a pre- and postsynaptic cell. The sensory neuron makes a direct connection onto the motor neuron, as is evident in part C. **C.** Individual cells make significant contributions to the reflex. Stimulating a single motor neuron produces a detectable change in the gill, and stimulating a single sensory neuron produces a large synaptic potential in the motor neuron. Repeated stimulation of a single sensory neuron increases the frequency of firing in the motor neuron, leading to a visible reflex contraction of the gill. A single tactile stimulus to the skin normally activates 6–8 sensory neurons, causing each to fire 1–2 action potentials. The repetitive firing of 10 action potentials in a single sensory neuron, designed to model the firing of the total population, in fact simulates reasonably well the reflex behavior.

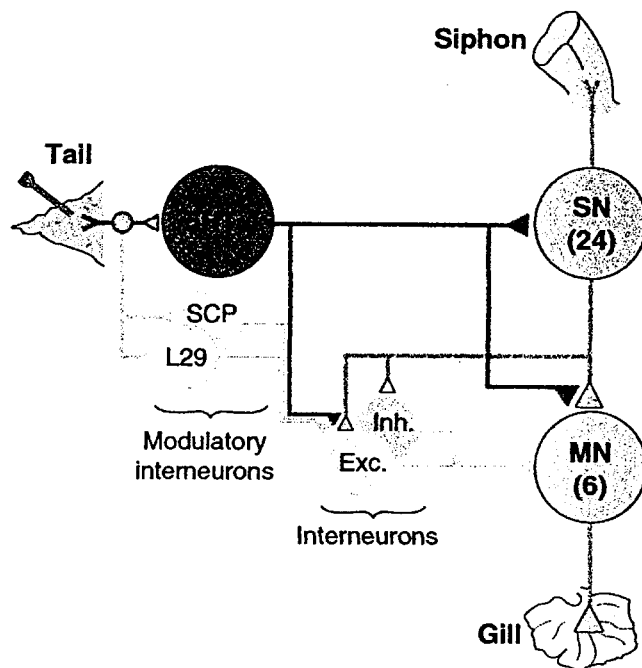

Fig. 7. The neural circuit of the gill-withdrawal reflex. The siphon is innervated by 24 sensory neurons that connect directly with the six motor neurons. The sensory neurons also connect to populations of excitatory and inhibitory interneurons that in turn connect with the motor neurons. Stimulating the tail activates modulatory interneurons that act on the terminals of the sensory neurons as well as on those of the excitatory interneurons. There are three classes of modulatory neurons activated by tail stimuli: (1) neurons that release serotonin (5-HT), (2) neurons that release a peptide called the small cardioactive peptides (SCP), and (3) the L29 cells, which release an unidentified modulatory neurotransmitter. The serotonergic modulatory action is the most important. Blocking the action of these serotonergic cells blocks the effects of sensitizing stimuli.

changes occur in the monosynaptic connections between the sensory neurons and the motor neurons of the gill-withdrawal reflex. *Heterosynaptic* changes occur in a synapse where presynaptic and postsynaptic neurons are themselves not active but there is, instead, activity in one or more modulatory interneurons that act on the presynaptic neurons, on the postsynaptic neurons of the synapse, or on both, to modify the strength of their synaptic connections. During sensitization, heterosynaptic changes are induced in the monosynaptic connections between the sensory neurons and motor neurons of the gill-withdrawal reflex. Hawkins, Abrams, and I later found that these two types of regulation are recruited together in classical conditioning [20, 21]. Classical conditioning therefore illustrated that the elementary forms of homo- and heterosynaptic plasticity form an alphabet of basic mechanisms that can produce combinations of plasticity with novel properties.

In all three forms of learning we found particularly large changes in the synaptic strength of the direct connections between the sensory and motor neurons of the reflex. We therefore focused on this one component of the reflex and found several additional principles that have proven to be quite general. First, we found that the same synaptic connection can be modulated in opposite ways by different forms of learning. For example, habituation leads to a homosynaptic weakening of synaptic connections between the sensory neurons and their target cells, the motor neurons and interneurons, while sensitization leads to heterosynaptic strengthening of these same sets of connections [7, 13, 33]. Second, learning not only leads to changes in synaptic strength, it can also affect the excitability of neurons. In the case of sensitization the excitability of the sensory (presynaptic) neurons is increased [25]. Third, the synaptic changes persist, thereby contributing to memory storage [10, 33, 94]. Indeed, the same synaptic connection can store both short- and long-term memory [7, 23, 33, 43, 94, 98]. At a given synapse synaptic plasticity can either be short- or long-lived depending on the number of spaced repetitions of the learning stimulus, and these parallel not only the behavioral changes of short-term memory [7, 43, 93]. Finally, long-term memory storage involves not only a change in synaptic strength, but also anatomical changes, changes in the number of synaptic connections [57, 58, 59].

The changes at the synapse between the sensory and the motor neuron are only a part of the changes in the neural circuit of the gill-withdrawal reflex. Important changes occur elsewhere in the circuit, but we have studied them less. We have focused on the monosynaptic portion of the circuit in order to probe in depth the molecular mechanisms that contribute to learning and memory.

INITIAL STEPS TOWARDS A MOLECULAR CHARACTERIZATION OF SENSITIZATION

What are the molecular mechanisms whereby short-term memory is established, and how it is converted to long-term memory? Initially, we focused on short-term sensitization (Fig. 8). In collaboration with James H. Schwartz, we found that the synaptic changes, like the short-term behavior, were expressed even when protein synthesis was inhibited. Since the short-term changes persisted for many minutes, it seemed unlikely that they involved a simple conformational change of one or more proteins. We therefore proposed, in 1971, that short-term memory might require a series of sequential reactions similar to that mediated by cAMP-mediated signaling [26]. Our attention was drawn to cAMP because Sutherland, Rall and Krebs had found that various neurotransmitters could increase cAMP concentration in the brain and in other tissues, and in the liver cAMP activated the cAMP-dependent protein kinase [26]. In 1972, Schwartz, Howard Cedar, and I found that stimulation of the modulatory pathways recruited during heterosynaptic facilitation led to an increase in cAMP in the abdominal ganglion [27]. Cedar and Schwartz next applied a number of neurotransmitter candidates and found that serotonin and dopamine could increase levels of cAMP [29]. This made us wonder whether the population of modulatory interneurons, which produces the heterosynaptic facilitation that gives rise to sensitization, contains serotonergic cells.

Fig. 8. The strength of the synaptic connections between the sensory and the motor neurons is increased by sensitization, by serotonin, and by direct activation in the presynaptic neurons of cAMP and PKA. A. The increase in synaptic strength produced by sensitizing stimuli can be achieved by electrical stimuli to the tail, to the head, or to the neural pathways from the tail or head. B. Facilitation could be reproduced by stimulating individual modulatory cells such as the serotonergic cells or by the application of the serotonin to the connections between the sensory neurons and motor neurons. C. Facilitation can also be produced by injecting cyclic AMP into the sensory neurons. D. Facilitation can also be produced by simply injecting the catalytic subunit of PKA into the sensory neurons. In this experiment the spikes of the sensory neuron have been artificially broadened by the application of tetraethylammonium (TEA). This reveals dramatically the further broadening produced by the catalytic subunit of PKA by the reduction of K^+ currents. [From 13, 31, 32, 37.]

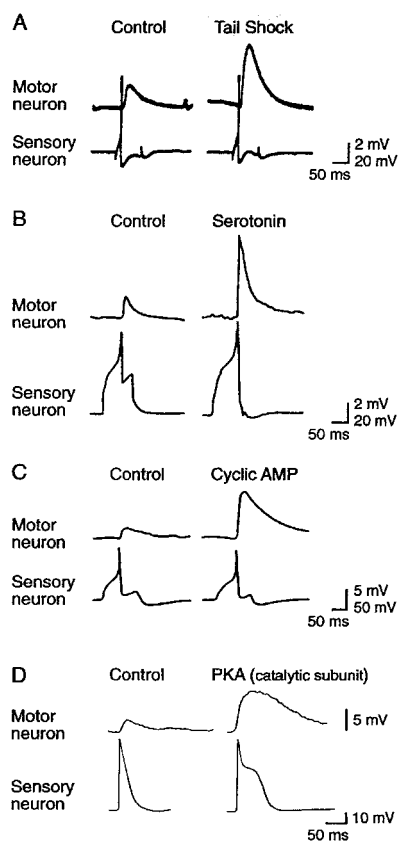

Later, Hawkins, Castellucci, David Glanzman, and I delineated the modulatory system activated by a sensitizing stimulus to the tail [19, 34, 35], and confirmed that it contains serotonergic interneurons. The system includes two other classes of heterosynaptic modulators, but the serotonergic neurons are most important for sensitization: blocking their actions alone blocked sensitization [34].

A DISTINCTION BETWEEN MEDIATING AND MODULATORY CIRCUITRY

In 1974, Castellucci and I next attempted to localize the change produced by habituation and sensitization to either the presynaptic or the postsynaptic component of the synapse. We therefore applied a quantal analysis to the synaptic connections between the sensory and motor cells and found that the short-term homosynaptic depression that accompanies habituation is presynaptic, involving a reduction in the amount of transmitter released from the presynaptic sensory neuron [30]. This transmitter, Nicholas Dale later showed, is glutamate [51]. Conversely, we found that the short-term heterosynaptic facilitation that accompanies sensitization results from an increased release of this transmitter from the sensory neuron [31].

We next found that a single brief application of serotonin could stimulate short-term sensitization (Figs. 8A and B)—by directly enhancing the release of transmitter from the sensory neurons, much as does the sensitization-induced facilitation—whereas dopamine could not [32]. Moreover, pharmacological inhibitors of serotonergic receptors blocked the effect of sensitizing stimuli, providing further evidence for the importance of serotonin as a modulator of synaptic strength [32].

Understanding the role of serotonergic and other modulatory neurons in sensitization allowed us to distinguish two different types of neural circuits important for behavior and learning: mediating and modulating (Fig. 7). A mediating circuit controls the gill-withdrawal reflex. It consists of the sensory neurons, interneurons, and motor neurons of the reflex, and it can be modified homosynaptically by habituation. But other, more complex forms of learning, such as sensitization and classical conditioning, involve modulatory circuits, somewhat akin to the arousal or attentional circuitries in higher animals. In *Aplysia* such a modulating circuit consists of serotonergic and other modulatory interneurons that act upon the mediating circuitry to regulate the strength of its connections. For example, modulatory interneurons act on the sensory neurons, including on their presynaptic terminals, to enhance the amount of glutamate released.

SHORT-TERM MEMORY INVOLVES cAMP AND THE ACTIVATION OF PKA

The finding that serotonin acts on specific receptors in the presynaptic terminals of the sensory neuron to enhance transmitter release, coupled with the fact that serotonin is capable of bringing about an increase in cAMP in the abdominal ganglion, caused us to ask whether serotonin facilitates the release of transmitter from the sensory neurons by acting via cAMP. We first explored this idea in 1976 when Brunelli, Castellucci, and I injected cAMP directly into the presynaptic cells and found that it produced presynaptic facilitation (Fig. 8C) [32, 33]. This provided the most and compelling evidence then available in the nervous system, that cAMP is involved in a specific physiological function and it gave us our first insight into the molecular mechanisms of short-term memory.

Marc Klein and I next asked: How does cAMP enhance transmitter release? We found that serotonin, or injected cAMP, leads to increased excitability and a broadening of the action potential by reducing a specific K^+ current, allowing greater Ca^{2+} influx into the presynaptic terminal with each action potential [24]. The greater Ca^{2+} influx could contribute to the enhanced transmitter release. Following the lead to Paul Greengard, who had proposed that cAMP produces all of its action in the brain through the cAMP-dependent protein kinase (PKA), Klein and I suggested that cAMP may lead to phosphorylation of this K^+ channel by activating PKA [24]. In collaborative experiments with Paul Greengard in 1980, Castellucci, Schwartz, and I tested this idea by injecting the active catalytic subunit of PKA and found that the catalytic subunit by itself produced broadening of the action potential and enhancement of glutamate release (Fig. 8D) [37]. Conversely, the specific peptide inhibitor of PKA (PKI) blocked the actions of serotonin. These findings provided direct evidence for the role of PKA in short-term presynaptic facilitation [38].

In 1981, Steven Siegelbaum arrived at Columbia, having just mastered single-channel recording during a visit to Erwin Neher and Bert Sakmann in Göttingen. In an elegant series of experiments, Siegelbaum and Joseph Camardo identified a novel K^+ channel, the S-type K^+ channel, and showed that it could be modulated by cAMP [39]. Then Siegelbaum and Michael Schuster used an isolated inside-out patch of membrane from the sensory neuron to show that PKA could act directly to decrease the number of channels open in that patch [40]. Later, Byrne showed that serotonin also modulates a delayed-rectifier K^+ channel whose contribution to spike broadening proved even more important than that of the S-type channel [reviewed in 41]. The combined studies indicated that the S-type channel mediated the increase in excitability with a minor contribution to broadening, whereas the delayed-rectifier K^+ channel contributed little to excitability but had a major role in spike broadening. Finally, Hochner, Klein, and I—and independently Jack Byrne and his colleagues—showed that, in addition to spike broadening, serotonin also enhanced release by an as-yet-unspecified action on the release machinery. Thus, serotonin leads to an increase in presynaptic cAMP, which activates PKA and leads to synaptic strengthening through a combination of mechanisms [reviewed in 41].

LONG-TERM MEMORY INVOLVES THE NUCLEAR TRANSLOCATION OF PKA AND MAP KINASE AND THE ACTIVATION OF CREB-1

Even earlier, in 1973, Arnold Kriegstein, an M.D.-Ph.D. student, succeeded in culturing *Aplysia* larvae so that we could raise *Aplysia* in the laboratory [28], providing us with animals of any size or age at any time. This was a major advance and opened up the study of synaptic plasticity in dissociated cell culture, which required very young animals [42, 43].

In the intact animal, one tail shock produces short-term sensitization, which does not depend on protein synthesis; four to five tail shocks produce sensitization that lasts several days, and this long-term process requires new protein synthesis. Both are reflected in alterations in strength in the connections between the sensory and motor neurons (Fig. 9). By substituting puffs of serotonin for tail shocks, Sam Schacher, Pier Giorgio Montarolo, Philip Goelet, and I could model this behavioral protocol in a culture dish consisting of a single sensory cell making synaptic connections with a single motor cell [43]. We were able to induce both short- and long-term facilitation in this culture and found, as we had with the intact animal, that the long-term process differed from the short-term process in requiring the synthesis of new proteins (Fig. 10). We had now trapped, in a culture consisting of two interconnected cells, the requirement for protein synthesis necessary to establish long-term memory.

We next used this cell culture to ask: What genes are activated to convert the short-term process to the long-term process, and what genes are essential for the maintenance of the long-term process? We found that five spaced puffs of serotonin (simulating five spaced shocks to the tail) activate PKA, which in turn recruits the mitogen-activated protein kinase (MAPK) and both translocate to the nucleus, where they activate a transcriptional cascade. The cascade begins with the transcription factor CREB-1, the cAMP response element binding protein-1, so called

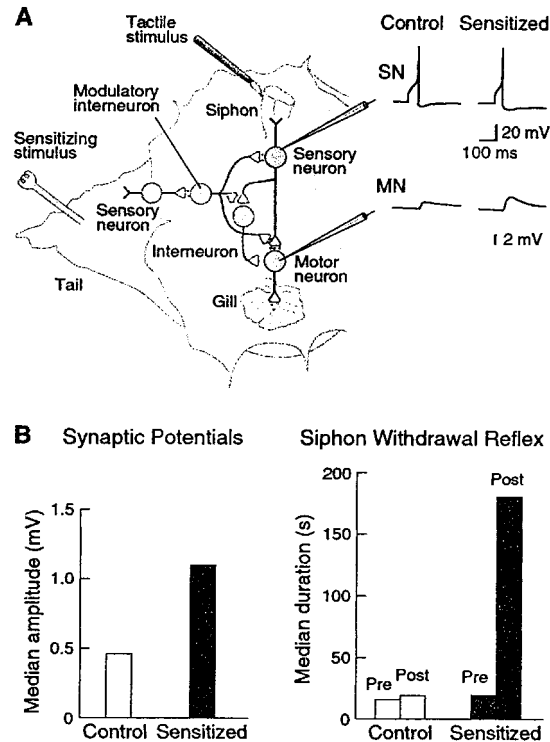

Fig. 9. Long-term sensitization of the gill-withdrawal reflex of *Aplysia* involves long-term facilitation of the connections between sensory and motor neurons. **A.** Experimental arrangement. The recordings on the right show representative synaptic potentials in a siphon sensory neuron and a gill motor neuron in a control animal and an animal that received long-term sensitization training by stimulating its tail. The record was obtained one day after the end of training. **B.** The median amplitude of the postsynaptic potential (PSP) in an identified gill motor neuron is greater in sensitized animals than in control animals. The effect of sensitization on the neural circuit of the gill-withdrawal reflex is measured by the median duration of withdrawal of the siphon. (Pre = score before training; post = score after training.) The sensitized animals were tested one day after training. [Adapted from 98.]

because it binds to a cAMP response element (CRE) in the promoters of target genes. CREB-1 leads to the activation of a set of immediate response genes, and in turn leads to the growth of new synaptic connections [44, 45, 46, 47, 49, 50, 56, 59].

The first clue to the importance of CREB in long-term memory was provided in 1990 by Pramod Dash and Binyamin Hochner [45]. They injected, into the nucleus of a sensory neuron in culture, oligonucleotides carrying the CRE DNA element, thereby titrating out CREB, and found that this selectivity blocked long-term but not short-term facilitation (Fig. 11). Later, Dusan Bartsch cloned *Aplysia* CREB-1a

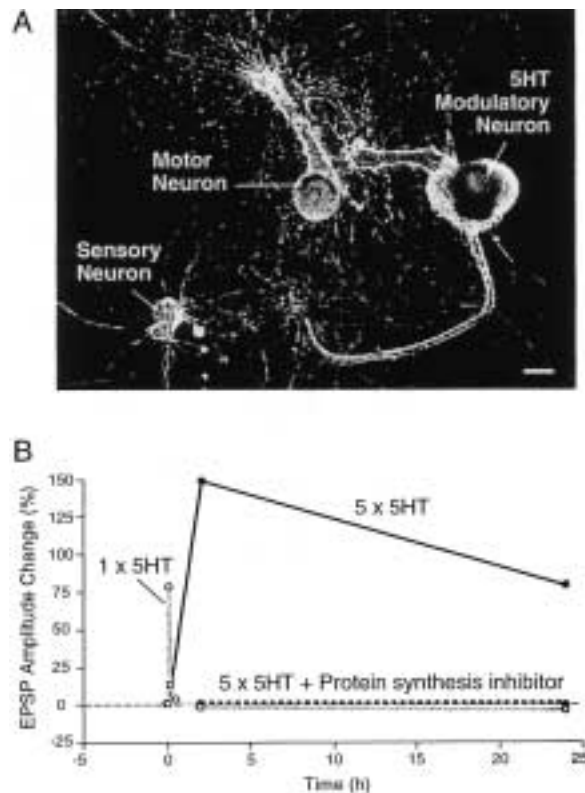

Fig. 10. The monosynaptic pathway of the gill-withdrawal reflex reconstituted in cell culture. A. In dissociated cell culture a single sensory neuron makes direct connections onto a motor neuron, and these connections can be modulated by a single serotonergic neuron. In fact, one does not need the serotonergic interneurons and can simply puff serotonin into the culture. Scale bar = 50 μ m. [From 42.] B. One puff of serotonin gives a transient facilitation that lasts a minute; this facilitation does not require new protein synthesis. Five puffs of serotonin produce a facilitation that lasts over a day; this does require the synthesis of new protein. [Modified from 53.]

(ApCREB-1a) and showed that injection of the phosphorylated form of this one transcription factor by itself could initiate the long-term process. Looking downstream from ApCREB [54], Cristina Alberini and Bartsch also found two additional positive transcription regulators: ApC/EBP and activation factor (Ap/AF) [52, 55].

INHIBITORY CONSTRAINTS ON MEMORY: MEMORY SUPPRESSOR GENES

In 1995, Bartsch found that positive regulators are only half the story—there are also inhibitory constraints on memory [53]. Long-term synaptic facilitation requires not only activation of memory-enhancer genes, but also inactivation of

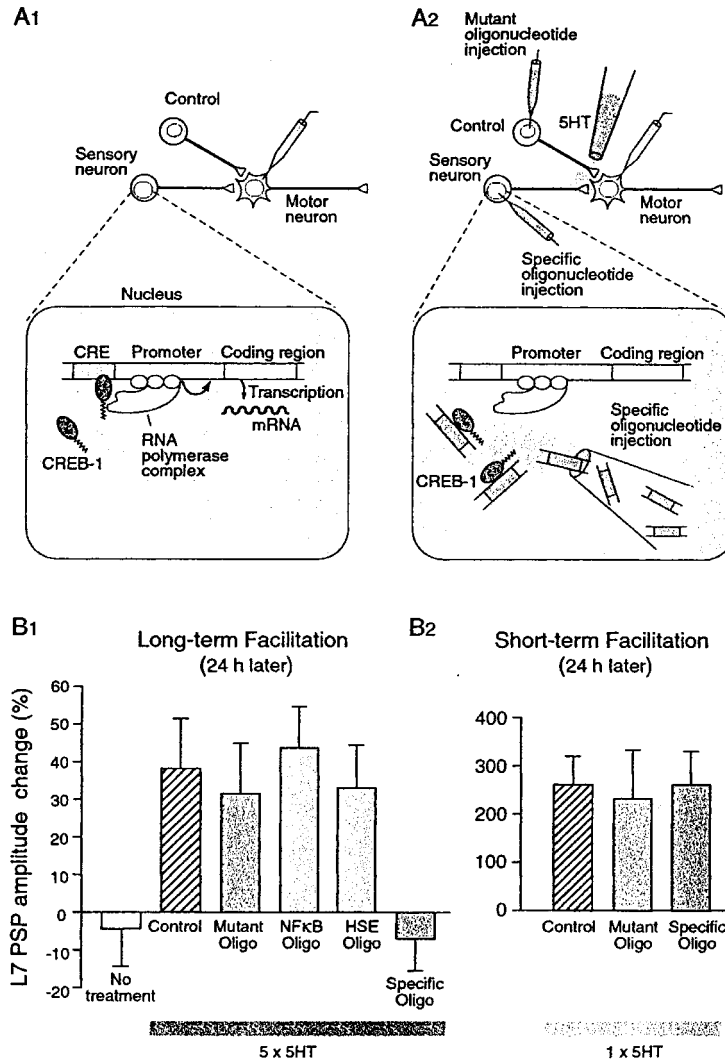

Fig. 11. Long-term facilitation requires gene transcription mediated by the transcription factor, the cAMP response element-binding protein (CREB-1). To inhibit the action of CREB, an oligonucleotide encoding the cyclic AMP response element (CRE) was injected into the *Aplysia* sensory neuron in culture. The sensory neuron in these experiments was in synaptic contact with the motor neuron. **A.** Experimental arrangement. **A1.** A single motor cell was cultured with two sensory cells. **A2.** One sensory cell was injected with the specific oligonucleotide encoding the CRE, designed to titrate out the CREB transcription factor, and the other was used as a control for injection of mutated or other oligonucleotide. **B.** The specific oligonucleotide blocks the serotonin-induced long-term facilitation measured 24 hr after injection (**B1**) but does not affect short-term facilitation (**B2**). A mutated oligonucleotide encoding the CRE or an oligonucleotide encoding the heat shock enhancer and the enhancers of $\text{NF}\kappa\text{B}$ do not affect long-term facilitation. [Modified from 45.]

memory-suppressor genes. One of these, the transcription factor ApCREB-2, can repress ApCREB-1a mediated transcription; relieving this repression lowers the threshold for the long-term process. Indeed, Bartsch found that when antiserum that blocks the action of ApCREB-2 is injected into the sensory neurons, a single application of serotonin, which normally produces facilitation lasting only minutes, now produces facilitation lasting days, accompanied by the growth of new synaptic connections (Fig. 12).

Thus, during long-term memory storage, a tightly controlled cascade of gene activation is switched on, with memory-suppressor genes providing a threshold or checkpoint for memory storage, presumably to ensure that only salient features are learned. It is clearly an evolutionary advantage for an animal to learn and store in long-term memory only facts important for survival, rather than retaining everything. Memory-suppressor genes may be regulated independently of the activators. Such independent action may be necessary to allow for the modulation of memory storage by emotional stimuli, as occurs in “flashbulb memories”, memories of emotionally charged events that are recalled in detail, as if a complete picture had been instantly and powerfully etched in the brain.

Once the repressive action of CREB-2 is removed and CREB-1 is activated, a set of immediate response genes is induced. One of these, the ubiquitin C-terminal hydrolase, is responsible for the proteolytic cleavage of the regulatory subunit of PKA, thereby removing a second inhibitory constraint or memory suppressor gene. Since the regulatory subunit normally inhibits the kinase activity of the catalytic subunit, cleavage extends the activity of the kinase for several hours [Fig. 12; refs. 60, 61]. In 1982, Schwartz and I first proposed this mechanism as the simplest molecular mechanism for long-term memory storage—the long-term process coopts and prolongs the action of the kinase involved in the short-term process but renders it independent of any further signaling by serotonin or PKA [115].

THE STABLE, SELF-MAINTAINED FORM OF LONG-TERM MEMORY IS REFLECTED IN THE GROWTH OF NEW SYNAPTIC CONNECTIONS

However, this persistent kinase is only required for 10 to 12 hours. Craig Bailey and Mary Chen first showed that what makes long-term memory enduring is the growth of new synaptic connections, a structural change that parallels the duration of the behavioral memory [56, 57, 58, 59]. As the connections retract over time, the memory fades. A typical sensory neuron in the intact animal has about 1200 synaptic varicosities. Following long-term sensitization, the number more than doubles to about 2600. With time the number returns to about 1500 synaptic connections (Fig. 12).

An important clue to the molecular actions that give rise to these structural changes came from the identification by Mark Mayford of a third class of memory-suppressor genes, the *Aplysia* cell adhesion molecules (ApCAMs) [62, 63], which belong to the immunoglobulin family of cell adhesion molecules, which includes mammalian neural cell adhesion molecule (NCAM) and *Drosophila* Fasciclin II. After exposure to five spaced puffs of serotonin, the concentration of ApCAM at the surface membrane of the presynaptic sensory neuron decreases as a result of the

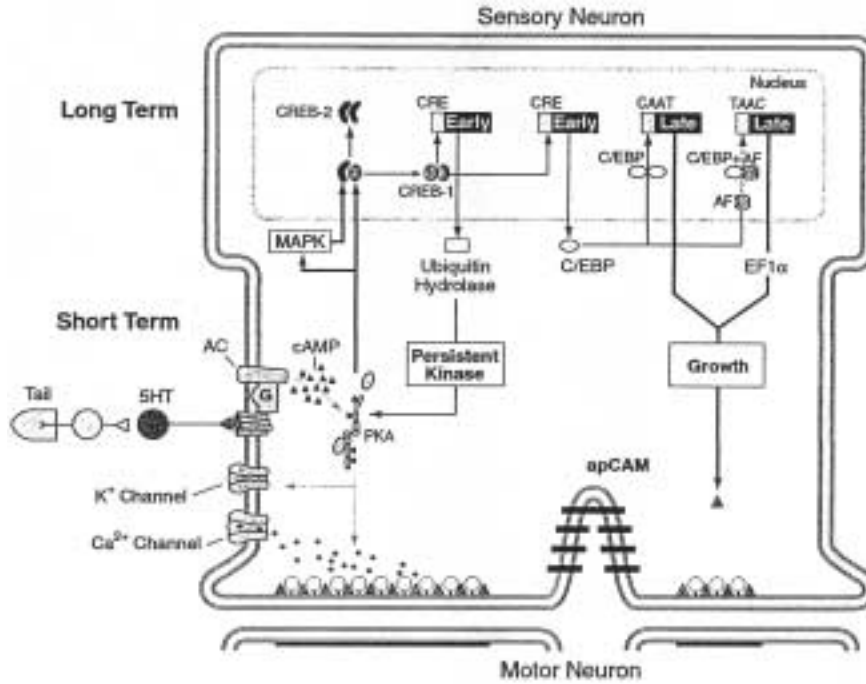

Fig. 12. Long-term sensitization of the gill-withdrawal reflex of *Aplysia* leads to two major sets of changes in the sensory neurons of the reflex: (1) persistent activity of protein kinase A and (2) the growth of new synaptic connections. In short-term sensitization (lasting minutes to hours) a single tail shock causes a one-time release of serotonin that leads to covalent modification of pre-existing proteins. The serotonin acts on a transmembrane receptor to activate adenylyl cyclase (AC) and converts ATP to the second messenger cAMP. In turn, cAMP activates the cyclic AMP-dependent protein kinase A (PKA), which phosphorylates and covalently modifies a number of target substrate proteins, including K^+ channels and components of the exocytotic machinery of release, to enhance transmitter availability and release. The duration of these modifications parallels the short-term memory. The cAMP-dependent protein kinase A has both catalytic subunits (the oval shaped structures) and regulatory subunits (the spindle-shaped structures). Normally the regulatory subunits inhibit the catalytic subunits. When the level of cAMP rises, the cAMP binds to the regulatory subunit, causing it to undergo a conformational change so that it dissociates from and frees the catalytic subunit, allowing the freed catalytic subunit to phosphorylate substrate proteins in the presynaptic terminals. With repeated stimulation, the level of cAMP rises more dramatically and persists for several minutes. This frees the catalytic subunit for a sufficient period of time to allow it to translocate to the nucleus, and in so doing it also recruits the mitogens-activated protein kinase (MAPK). In long-term sensitization (lasting one or more days) repeated shocks to the tail cause repeated release of serotonin that leads to the regulatory subunit being dissociated from the catalytic subunit for sufficient time so that the catalytic subunit translocates to the nucleus where it phosphorylates the cyclic AMP response element-binding (CREB) protein and leads to the removal of the repressive action of CREB-2, which is capable of inhibiting CREB-1 perhaps by means of another protein kinase, MAP kinase which is also activated by the catalytic subunits. Once CREB-1 is activated, it activates in turn the gene that encodes a ubiquitin hydrolase, a component of a specific ubiquitin protease that leads to the regulated proteolysis of the regulatory subunit of PKA. This cleavage of the (inhibitory) regulatory subunit results in persistent activity of PKA, leading to persistent phosphorylation of the substrate proteins of PKA, including proteins involved in the short-term process. A second set of genes, activated by CREB-1, is C/EBP, which acts both by itself as a homodimer and together with activating factor (AF) as a heterodimer to give rise to the growth of new synaptic connections. In so doing it activates a number of late genes, including elongation factor 1α (EF1 α).

internalization of the transmembrane form of ApCAM, a process that requires ongoing protein synthesis. This clathrin-mediated endocytosis is blocked by mutations in the consensus sequence for MAP kinase phosphorylation in the cytoplasmic tail [48]. Selective down-regulation of the transmembrane isoform of ApCAM causes defasciculation; it decreases the adhesive interaction of sensory cell neurites with each other, a prerequisite to process outgrowth and the formation of new synaptic connections.

THE cAMP, PKA, CREB SWITCH IS ALSO IMPORTANT FOR LEARNING AND MEMORY IN *DROSOPHILA*

The pioneering work of Seymour Benzer and the subsequent studies of his students, Chip Quinn, Tim Tully, Jerry Yin, and Ronald Davis, have led to the identification of a number of genes required for memory storage in *Drosophila* [reviewed in 97,102]. Many of the genes identified in this way are the same as those implicated in plasticity in *Aplysia*. For example, *Drosophila* genes *dunce*, *rutabaga*, and *amnesiac* all encode components of the cAMP-PKA cascade. Other genes identified encode participants in cell adhesion molecules similar to ApCAM [97]. Moreover, a protein synthesis-dependent phase of learning has been described by Tully and his colleagues, and Yin and Tully have shown that, as in *Aplysia*, CREB has a critical role in induction of longer memory [97].

IS LONG-TERM FACILITATION SYNAPSE-SPECIFIC?

The finding of a transcriptional cascade explained why long-term memory requires new protein synthesis immediately after training, but it posed a new cell-biological problem. A single neuron makes hundreds of contacts on many different target cells (Fig. 13). Short-term synaptic changes are synapse-specific. Since long-lasting synaptic changes require transcription and thus the nucleus, is long-term memory storage a cell-wide process, or are there cell-biological mechanisms that maintain the synapse specificity of long-term facilitation?

To examine these questions at the level of individual synapses, Kelsey Martin modified our culture system. She cultured one sensory cell with a bifurcating axon with two motor neurons, forming two widely separated synapses (Fig. 14). In this culture system, a single puff of serotonin applied to one synapse produces transient facilitation at that synapse only, as expected [64, 65]. Five puffs of serotonin applied to one branch produces long-lasting facilitation (72 hours) that is also restricted to the stimulated synapse (Fig. 15). This long-lasting synapse-specific facilitation requires CREB and also leads to structural changes. Thus, despite recruitment of nuclear processes, long-term change in synaptic function and structure are confined only to those synapses stimulated by serotonin.

How does this come about? Martin, Andrea Casadio, Bailey, and I found that five puffs of serotonin send a signal to the nucleus to activate CREB-1, which then appears to send proteins to all terminals; however, only those terminals that have been marked by serotonin can use these proteins productively for synaptic growth. Indeed, we found that one puff of serotonin to the previously unstimulated synapse

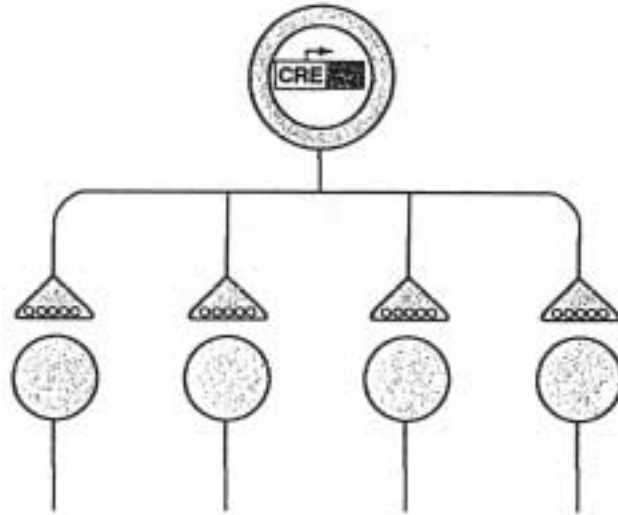

Fig. 13. A single sensory neuron connects to many target cells. The requirement of a transcriptional mechanism for long-term memory raises the question: What is the unit of long-term information storage? Is it a single synapse, as with short-term facilitation, or the entire neuron? Is there a mechanism for restricting synaptic facilitation to some synaptic connections?

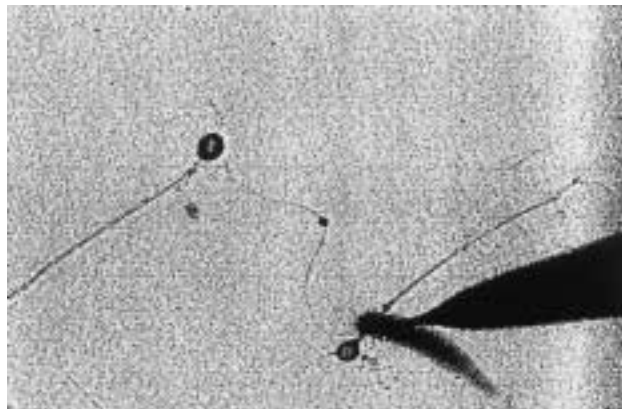

Fig. 14. This photomicrograph shows a culture system developed to examine the action of two independent branches of a single in *Aplysia* sensory neuron (the small neuron in the middle) on two different motor neurons (large neurons). Serotonin can be selectively applied to one and not the other of the two branches. The flow of the serotonin can be monitored with the dye, fast green. [From 64.]

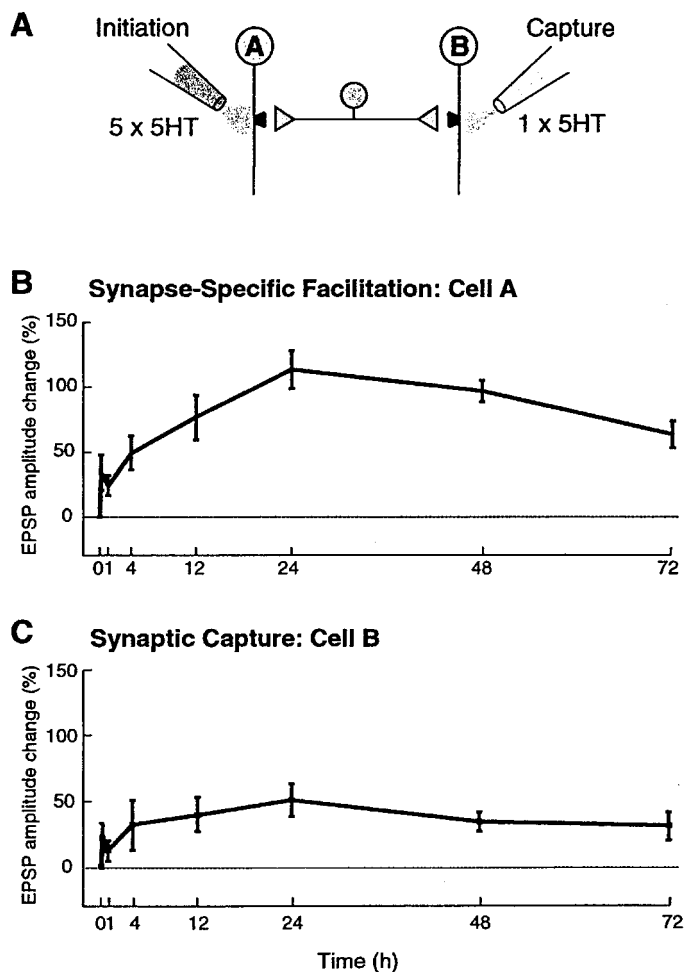

Fig. 15. Long-term facilitation is synapse-specific and can be captured at another branch by the stimulus that initiates the short-term process. A. Five puffs of serotonin are applied at the site of initiation (cell A) and produce a synapse-specific facilitation that is shown in part B. This synapse-specific facilitation is not evident at the synapse of cell B unless that synapse is itself primed with a single puff of serotonin. Under those circumstances the long-term facilitation at synapse A can be captured at synapse B in a reduced form, as illustrated in part C. [From 64.]

is sufficient to mark that synapse so that it can capture a reduced form of the long-term facilitation induced at the other site by five puffs of serotonin (Fig. 15).

These results gave us a new and surprising insight into short-term facilitation (Fig. 16). The stimulus that produces the short-term process has two functions. When acting alone, it provides a selective, synapse-specific enhancement of synaptic strength, which contributes to short-term memory, lasting minutes. When acting in

Two Different Functions of the Short Term Process

1. Short-term memory storage

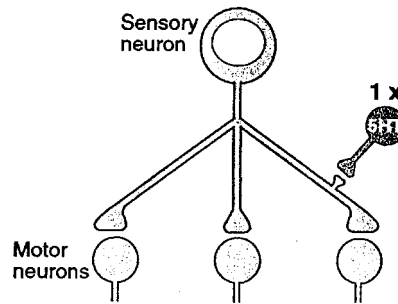

2. Marking for the capture of the long-term process and the growth of new synapses

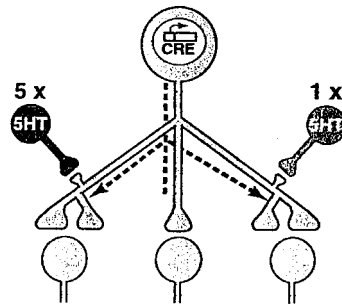

Fig. 16. Two different functions of the short-term process by itself and in conjunction with the long-term process occurring at any other part within the neural tree. By itself, short-term facilitation participates in short-term memory storage. In conjunction with long-term facilitation at any other synapse, the short-term process marks the specific synapse to which it is applied and allows it to capture and use productively the proteins necessary to establish the long-term process and to grow new synaptic connections.

conjunction with the activation of CREB initiated by a long-term process in either that synapse or in any other synapse on the same neuron, the stimulus that produces the short-term process serves to locally mark those synapses at which it occurs. The marked synapse can then productively utilize the proteins activated by CREB for synaptic growth to produce a persistent change in synaptic strength.

The existence of long range signaling between the synapse and the nucleus and the nucleus and the synapse introduces a new dimension into the integrative action of neurons that alters the rules whereby synapses are strengthened or weakened. Although long-term facilitation is *synapse-specific* and restricted, once transcription has been activated by the long-term process, the potential for plastic change of *all* the synapses of the neuron has, in fact, become altered. As a result, following the initiation of transcription in a neuron by long-term activation of one synapse, the action of any other synapse of that neuron is no longer determined simply by the history of that synapse but is also determined by the history of the transcriptional machinery in the nucleus. Thus, the logic of the long-term process is quite different from the short-term process.

THE NATURE OF THE LOCAL MARKING SIGNAL

How does one puff of serotonin mark a synapse for long-term change? We found that the synapse is marked for both long-term synaptic facilitation and for growth of new synaptic connections by covalent modifications of pre-existing proteins mediated by PKA. However, for the structural change to persist, local protein synthesis is required [65]. Oswald Steward's important work in the early 1980s had shown that dendrites contain ribosomes, and that specific mRNAs are transported to the dendrites and translated there locally [101]. But the function of these locally translated mRNAs was unknown. Our experiments showed that one function was to stabilize the synapse-specific long-term functional and structural changes.

What proteins might be important locally for the stabilization? To answer this question we needed a preparation in which we could study the local mRNA and proteins in isolation, without contamination of the cell body or surrounding glial cells. Martin was able to culture several hundred sensory neurons in a dish and then cut off their cell bodies, allowing us to study the mRNAs in the processes and how they are regulated [64]. Serotonin could stimulate translation in these isolated processes. Moreover, the transcripts in these processes contained regulatory sequences consistent with their using at least two mechanisms for regulating local translation. These two local mechanisms of translation serve different functional roles.

One group of transcripts, such as an isoform of α -tubulin that is important for the assembly of microtubules for fast axonal transport and for cytoskeletal organization, has a cytoplasmic polyadenylation element (CPEP) in their 3' untranslated region which, in other contexts, contributes to translational regulation by regulating polyadenylation. This component of translation is blocked by emetine, a general inhibitor of protein synthesis, and is necessary for initiating the long-term process (Fig. 17). Other transcripts, such as the elongation factor EF-1 α , have an oligopyrimidine tract in their 5' untranslated region. This tract is found in a small set of transcripts that are preferentially translated by growth factors and mitogens. The ability of these growth factors to recruit these transcripts is blocked selectively by the drug rapamycin [reviewed in 99, 100, 101]. Indeed, we found that the stabilization of facilitation and of the growth of new connections, both at the site of capture and the site of initiation, are sensitive to inhibition by rapamycin [Fig. 17; and ref. 65].

A FOURTH CONSEQUENCE OF NEUROTRANSMITTER SIGNALING: REGULATING LOCAL PROTEIN SYNTHESIS

These studies thus revealed a new, fourth type, of synaptic action mediated by neurotransmitter signaling. Three of these four have emerged, at least in part, from the study of learning and memory. First, in 1951, Katz and Fatt opened up the modern study of chemical transmission with their discovery of inotropic receptors that regulate ion flux through transmitter-gated ion channels to produce fast synaptic actions, lasting milliseconds [110]. Second, in the 1970s, metabotropic receptors were found to activate second-messenger pathways, such as the cAMP-PKA pathway, to produce slow synaptic activity lasting minutes [111]. As we have seen in

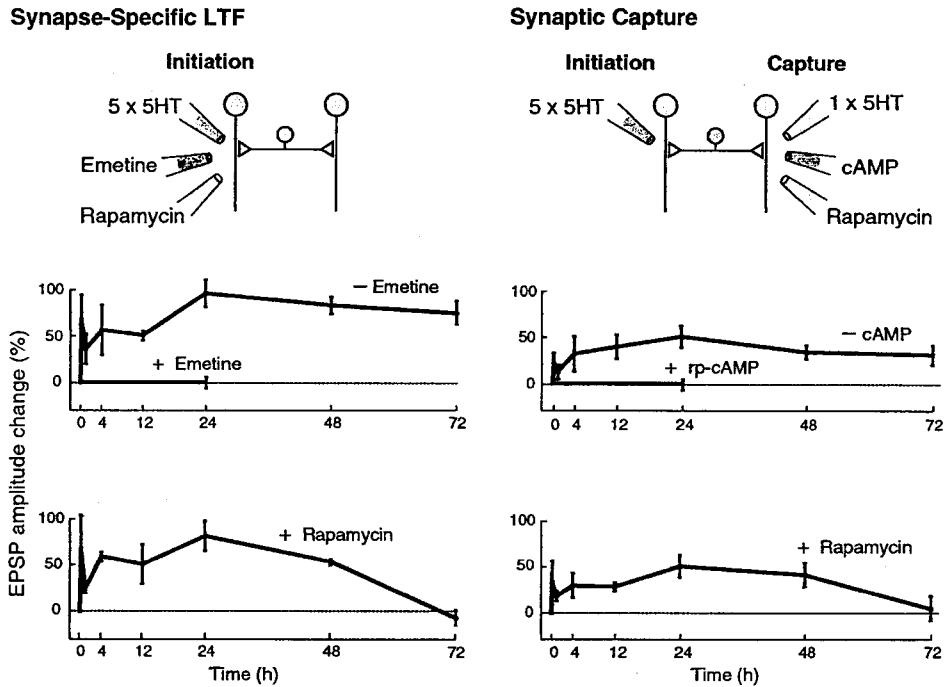

Fig. 17. The requirements for local protein synthesis differ at the sites of initiation and capture of long-term facilitation. At the site of initiation two components of local protein synthesis are required: an emetine-sensitive local protein synthesis to set up the long-term process and a rapamycin-sensitive component of local protein synthesis to maintain facilitation after 48 hr. At the site of capture, inhibitors of cyclic AMP block the capture completely. By contrast, the rapamycin- and local protein synthesis-sensitive components are only required for maintenance of facilitation. [From 65.]

Aplysia, this slow synaptic action can regulate transmitter release, thereby contributing to short-term memory for sensitization. Third, an even more persistent synaptic action, lasting days, results from repeated action of a modulatory transmitter such as serotonin. With repeated applications of serotonin, second-messenger kinases translocate to the nucleus, where they activate a cascade of gene induction leading to the growth of new synaptic connections. This of course raises the problem of synapse specificity that we have considered above. Our experiments, in the bifurcated culture system, revealed a novel fourth action of neurotransmitters, the marking of the synapse and the regulation of local protein synthesis which contributes to the establishment of synapse-specific long-term facilitation [Fig. 18].

THERE ARE TWO MAJOR TYPES OF MEMORY: THE CASE OF EXPLICIT MEMORY

I have so far considered only the simplest cases of memory storage—those involving reflexes—a form called implicit or procedural memory. Implicit memory is memory for perceptual and motor skills and is expressed through performance,

A Dialog Between Genes and Synapses

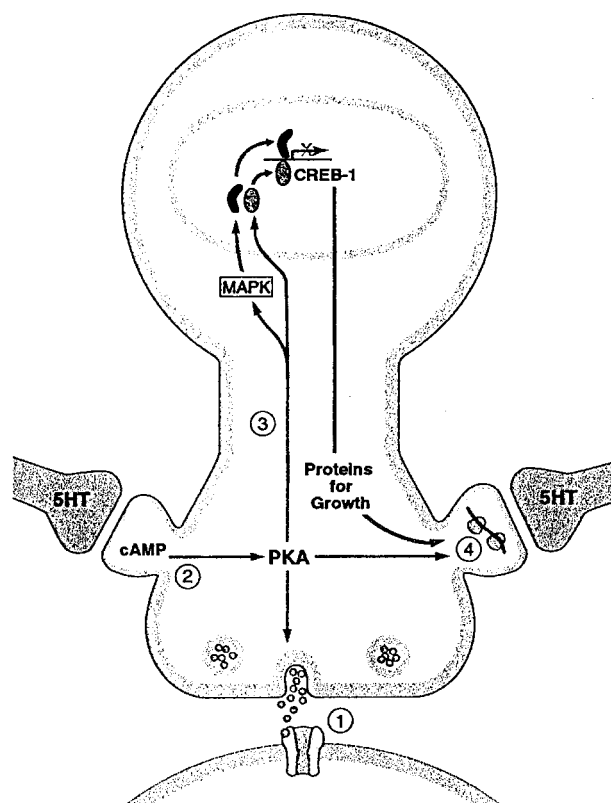

Fig. 18. Four different consequences of the action of neurotransmitters. These events show that the synapses and nucleus readily interact. 1. Transmitter activation of a ligand-gated ion channel leads to a rapid synaptic action. 2. Transmitter activation of a seven transmembrane receptor and a second messenger kinase leads to a more enduring synaptic action. 3. Repeated transmitter activation of a seven transmembrane receptor leads to the translocation of the kinase to the nucleus and to activation of transcription, producing a persistent synaptic action. 4. Transmitter can also activate local protein synthesis to stabilize the synapse-specific facilitation.

without conscious recall of past episodes. In contrast, the memories we hold near and dear are called explicit (or declarative) memories. These memories require conscious recall and are concerned with memories for people, places, objects, and events. Explicit memory involves a specialized anatomical system in the medial temporal lobe, and a structure deep to it, the hippocampus [Fig. 19; reviewed in 66, 94, 95].

How is explicit memory stored? We had known from the work of Louis Flexner, Bernard Agranoff, Sam Barondes, and Larry Squire that explicit memory, like implicit memory, has a short-term phase that does not require protein synthesis and

There are Two Major Forms of Long Term Memory

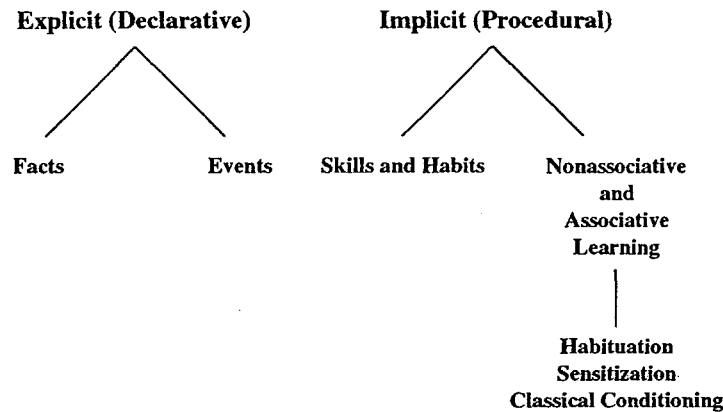

Fig. 19. Two major forms of long-term memory: explicit (declarative) and implicit (procedural). Explicit or declarative memory is the memory for persons and objects and requires conscious participation for recall. Implicit or procedural memory is the memory for perceptual and motor skills, which is perfected in performance and does not involve conscious participation for recall.

a long-term phase that does [66]. Are these two components of memory storage also represented at the cellular level? What rules govern explicit memory storage?

A decade ago, when I reached my 60th birthday, I finally gathered up my courage and returned to the hippocampus. A major stimulus for me was the presence in my laboratory of Seth Grant who was eager to work with genetically modified mice [67]. When Mario Capecchi and Oliver Smithies succeeded in achieving targeted gene ablation in ES stem cells, it became clear to me that mice would now offer a superb genetic system for relating individual genes to synaptic plasticity, on the one hand, and to complex explicit memory storage on the other. Although mice are relatively simple mammals, they have a medial temporal lobe system, including a hippocampus, that resembles that of humans, and they use their hippocampus much as we do to store memory of places and objects (Fig. 20).

In our work with mice we have focused on memory for extrapersonal space as a model of explicit memory, because spatial memory is well represented in rodents and has been particularly well studied. Although we still do not know much about how information is transformed as it gets into and out of the hippocampus, it is well established that the hippocampus contains a cellular representation of extrapersonal space—a cognitive map of space—and that lesions of the hippocampus interfere with spatial tasks [67]. Moreover, in 1972, Terje Lømo and Tim Bliss discovered that the perforant path, a major pathway within the hippocampus, exhibits activity-dependent plasticity, a change now called long-term potentiation (LTP) (Fig. 21). In the CA1 region of the hippocampus where LTP has been studied most extensively, it had been found to be induced postsynaptically by activation of an NMDA receptor to glutamate. In the late 1980s Richard Morris found that blocking the NMDA

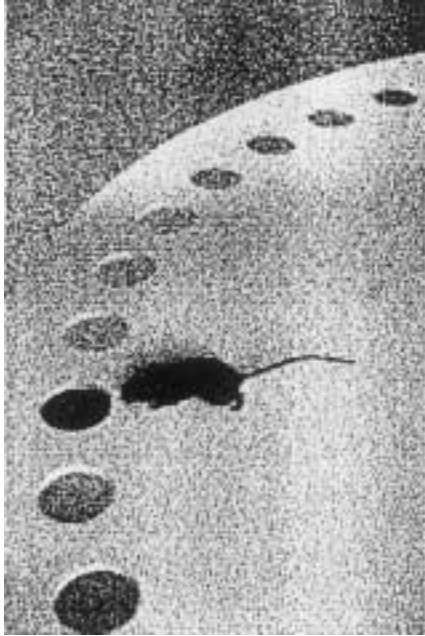

Fig. 20. Barnes maze used in studying spatial memory in the mouse. The mouse is put in the center of a wooden platform. Because mice do not like open spaces they try to find some way to move out of it. The only way they can escape from the exposed space is to find the one hole out of 40 that leads to an escape hatch.

receptor pharmacologically not only interfered with LTP but also blocked memory storage [69, 70].

We focused primarily on the Schaffer collateral, another pathway in the hippocampus, not only because it has been extensively studied but also because work with a patient R.B. by Larry Squire and his colleagues had shown that a lesion restricted to the CA1 region was sufficient to produce a significant loss of explicit memory storage [68].

Early work on LTP in this pathway in hippocampal slices by others had focused on the response to one or two trains of electrical stimuli. But in our work on *Aplysia* we had found long-term memory and the synaptic changes that accompany it emerge most effectively with repeated stimuli. So Uwe Frey, Yan-You Huang, Peter Nguyen, and I examined whether LTP changed with repeated stimulation [71, 72, 73] and found that in each of the three major hippocampal pathways LTP has phases, much like facilitation in *Aplysia*.

The early phase of LTP, produced by a single train of stimuli, lasts only 1–3 hours and does not require new protein synthesis [reviewed in 73]; it involves covalent modifications of pre-existing proteins that lead to the strengthening of pre-existing connections, similar in principle to short-term facilitation in *Aplysia*. But, as was well documented by Roger Nicoll and his colleagues, the molecular details of the early phase of LTP in the Schaffer collateral pathway differ from those of short-term facilitation in *Aplysia*. The influx of Ca^{2+} through the NMDA receptor channel leads to the activation of a Ca^{2+} calmodulin-dependent protein kinase and the phosphorylation of preexisting AMPA receptors, and insertion into the postsynaptic membrane of new AMPA receptors to glutamate [75].

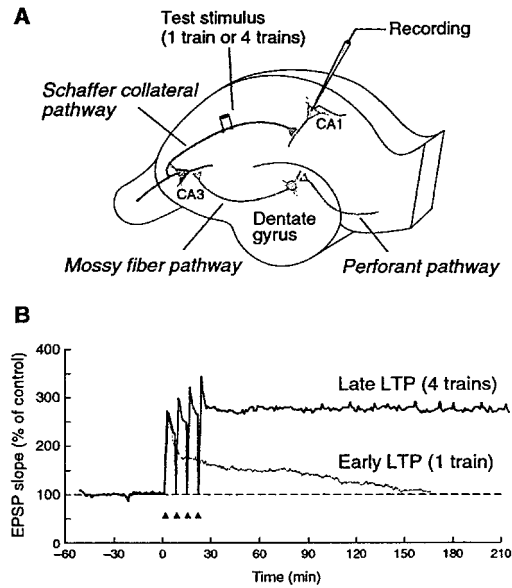

Fig. 21. Long-term potentiation (LTP) in the hippocampus. **A.** Three major pathways denote the direction of the impulse flow, each of which gives rise to LTP. The *perforant pathway* from the subiculum forms excitatory connections with the granule cells of the dentate gyrus. The *mossy fiber pathway*, formed by the axons of the granule cells of the dentate gyrus, connects the granule cells with the pyramidal cells in area CA3 of the hippocampus. The *Schaffer collateral pathway* connects the pyramidal cells of the CA3 region with the pyramidal cells in the CA1 region of the hippocampus. **B.** The early and late phases of LTP in the Schaffer collateral pathway. A single train of stimuli for one second at 100 Hz elicits an early LTP, and four trains at 10-minute intervals elicit the late phase of LTP. The early LTP lasts about 2 hr and the late LTP last more than 24 hr.

By contrast, repeated trains of electrical stimuli produce a late phase of LTP, which has properties quite different from early LTP and quite similar to long-term facilitation in *Aplysia* (Fig. 21). The late phase of LTP persists for at least a day and requires both translation and transcription. Like long-term facilitation in *Aplysia* [71, 73], the late phase of LTP is strongly modulated by a heterosynaptic input, in this case mediated by dopamine [79]. At the Schaffer collateral synapse the late phase of LTP, like long-term storage of implicit memory, requires PKA, MAPK, and CREB, and appears to lead to the growth of new synaptic connections [Fig. 22; see refs. 71, 72, 73, 74, 76, 77, 78, 80, 81, 82].

Together with Vadim Bolshakov and Hava Golan, Siegelbaum and I examined the late phase of LTP on an elementary level. We stimulated a single presynaptic CA3 neuron and recorded from a single CA1 postsynaptic cell, and found that the

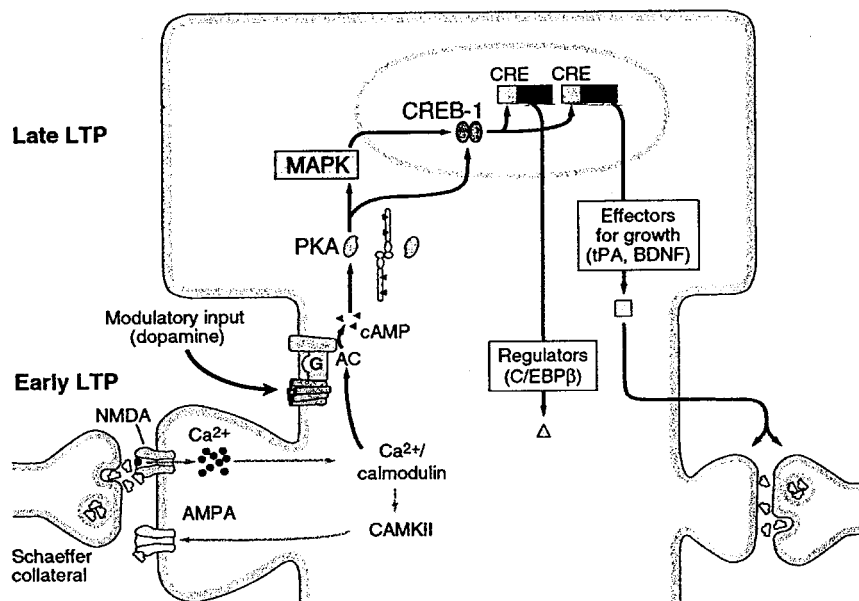

Fig. 22. A model for the late phase of LTP in the Schaffer collateral pathway. A single train of action potentials initiates early LTP by activating NMDA receptors, Ca^{2+} influx into the postsynaptic cell, and the activation of a set of second messengers. With repeated action potentials the Ca^{2+} influx also recruits an adenylyl cyclase, which activates the cAMP-dependent protein kinase. The kinase is transported to the nucleus where it phosphorylates CREB. CREB in turn activates targets that are thought to lead to structural changes. Mutations in mice that block PKA or CREB reduce or eliminate the late phase of LTP. The adenylyl cyclase can also be modulated by dopamine signals and perhaps other modulatory inputs.

late phase requires a coordinated regulation of both pre- and postsynaptic components of the synapse. In the resting state, an action potential in a presynaptic CA3 neuron released either zero or one vesicle onto the CA1 neuron. By contrast, during the late phase of LTP, a single action potential in a CA3 neuron released several vesicles of transmitter onto the CA1 neuron (Fig. 23). This increase in the number of vesicles released would seem to entail a coordinated growth of new presynaptic release sites as well as the insertion of new clusters of postsynaptic receptors [105, 106]. Consistent with this idea, and with the properties of the late phase of LTP, these long-term changes require new protein synthesis.

THE LATE PHASE OF LTP REQUIRES PKA AND CONTRIBUTES TO LONG-TERM EXPLICIT MEMORY FOR EXTRAPERSONAL SPACE

To explore further the specific role of PKA in late LTP and to determine its role in memory, Ted Abel, Mark Barad, Rusiko Bourtchouladze, Peter Nguyen, and I generated transgenic mice that express R(AB), a mutant form of the regulatory subunit of PKA that inhibits enzyme activity [84]. To restrict expression of R(AB) to the postnatal hippocampus and other forebrain regions, we used the promoter

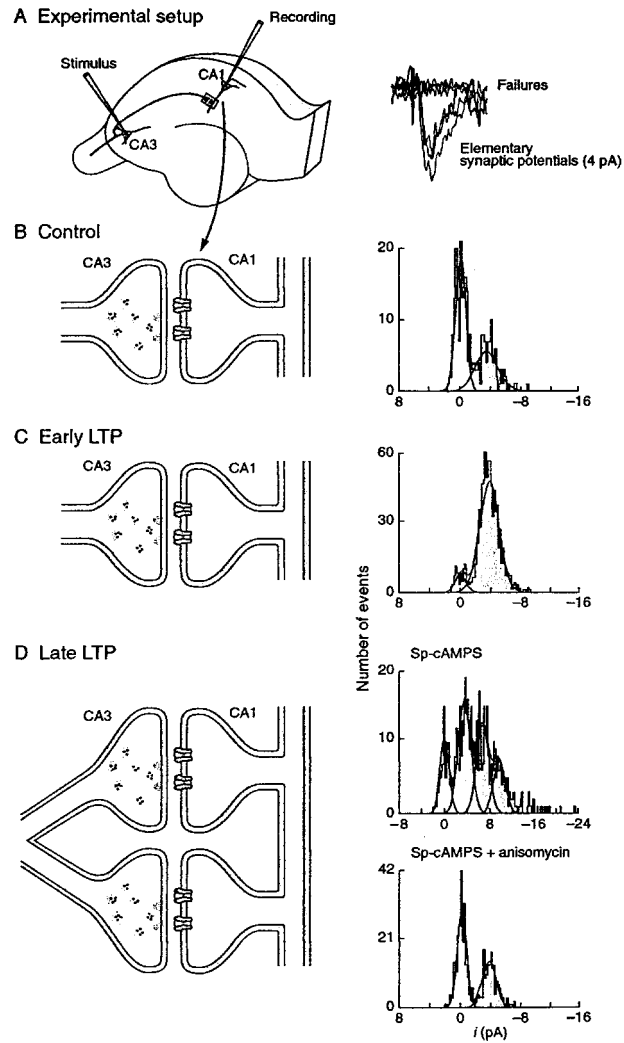

Fig. 23. A distinction between the early and late phases of long-term potentiation in the hippocampus is evident at the level of the connection between a single CA3 cell and a single CA1 cell. [Modified from 74.] A. A single CA3 cell can be stimulated to produce a single elementary synaptic potential in a CA1 cell. B. Stimulating the CA3 cell repeatedly at low frequency produces an elementary response of the size of a miniature synaptic potential or no response (a failure). The distribution of the amplitudes of many responses can be approximated by two Gaussian curves, one centered on zero (the failures) and the other centered on 4 pA (the successful responses). These histograms are consistent with the synapse between a single CA3 cell and a CA1 cell. At this synapse the CA3 cell has a single active zone from which it releases a single vesicle in an all-or-none manner (failures or successes). In control cells there are many failures, i.e., the synapse has a low probability of releasing vesicles. C. In the early phase of LTP the probability of release rises significantly. The distribution of responses is consistent with the view that a single release site releases a vesicle with a high probability of release. D. In the late phase of LTP induced by cAMP, the distribution of responses no longer fits two Gaussian curves but instead requires three or four Gaussian curves, suggesting the possibility that new presynaptic active zones and postsynaptic receptors have grown. These effects are blocked by anisomycin, an inhibitor of protein synthesis.

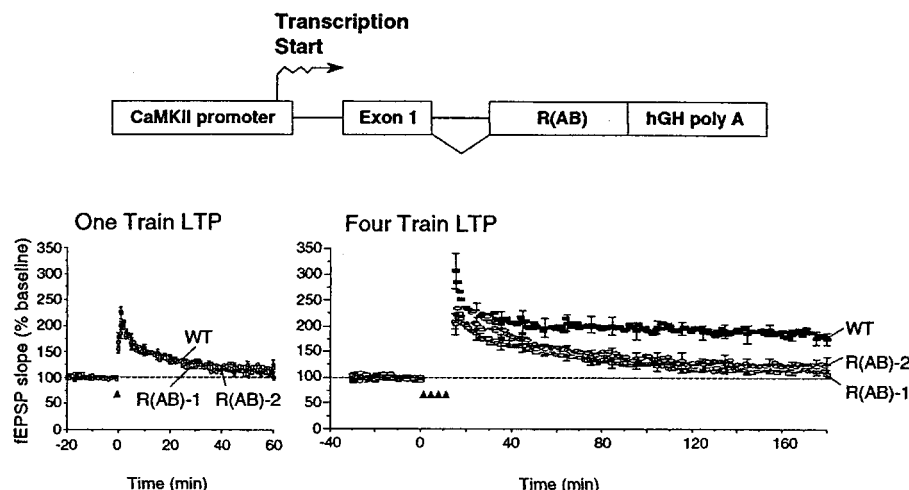

Fig. 24. A comparison of LTP in wild-type mice and mice in which PKA has been compromised by the expression in the hippocampus of a transgene, a dominant negative inhibitor of PKA. This inhibitor R(AB) is a mutated form of the regulatory subunit of PKA that inhibits the catalytic subunit but does not recognize cAMP. Two lines of mutant mice (R(AB)-1 and R(AB)-2) are compared to the wild-type mice (WT). The mutant mice have perfectly good early LTP comparable to that of wild-type mice. Mutations in mice that block PKA or CREB reduce or eliminate late LTP. [From 84.]

from the Ca^{2+} /calmodulin protein kinase II α (CaMKII α) gene which Mark Mayford had isolated and characterized. In these R(AB) transgenic mice the reduction in hippocampal PKA activity was paralleled by a significant decrease in late LTP, while basal synaptic transmission and early LTP remained unchanged (Fig. 24). Most interestingly, this deficit in the late phase of LTP was paralleled by behavioral deficits in hippocampus-dependent long-term memory for context, for extrapersonal space, whereas learning, and short-term memory, are unimpaired (Figs. 25 and 26). Thus, in the storage of explicit memory of extrapersonal space in the mammalian hippocampus, PKA plays a critical role in the transformation of short-term memory into long-term memory, much as it does in the storage of implicit memory in *Aplysia* and *Drosophila*.

TOWARD A MOLECULAR BIOLOGY OF COGNITION: PKA IS REQUIRED FOR AN INTERNAL REPRESENTATION OF EXTRAPERSONAL SPACE

Using the R(AB) mice we could now ask: What are the specific functions in spatial memory of PKA and the late phase of LTP? Why do animals with compromised PKA signaling have difficulty with space? [84] In addressing these questions we were influenced by the classic studies of John O'Keefe and John Dostrovsky, who in 1971 discovered that the pyramidal cells of the hippocampus—the cells one examines artificially using electrical stimuli to the Schaffer collateral pathway while

Contextual Conditioning

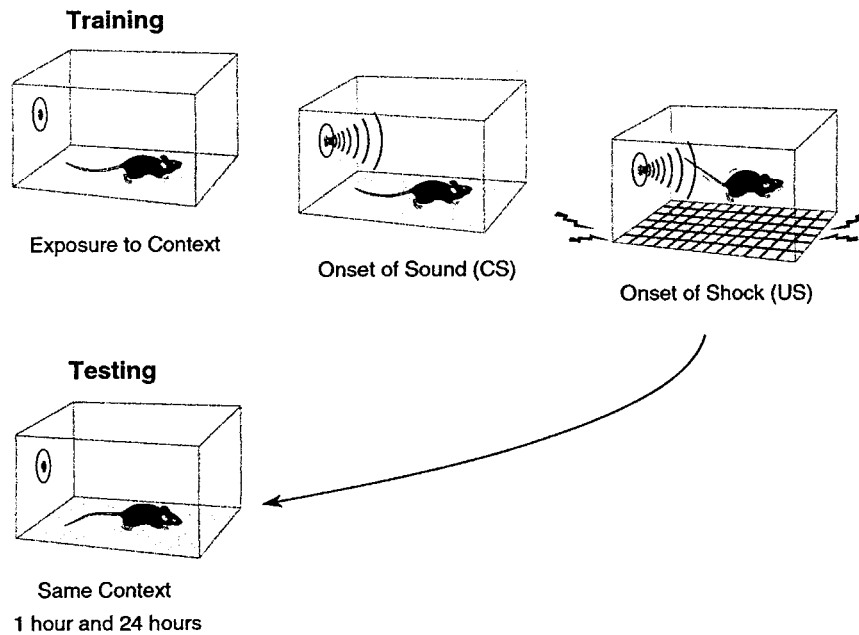

Fig. 25. The protocol for context conditioning. The conditioning consists of exposure to the context followed by a tone and then a shock. The animals are then tested 1 hr and 24 hr after training. [From 84.]

studying LTP—are “place cells”; they actually encode extrapersonal space in real life [85]. A given pyramidal cell will fire only when the head of the mouse is in a certain part of an enclosed space: the cell’s place field. Thus, when an animal walks within an enclosed space, a particular subset of pyramidal cells in the hippocampus becomes active [103]. When the animal is in different regions, different sets of pyramidal cells become active (Fig. 27).

These findings led O’Keefe and Nadel to develop the idea that the pyramidal cells of the hippocampus form an internal neural representation, or “cognitive map,” of the space surrounding the animal [85]. This holistic neural representation was thought to permit the animal to solve spatial problems efficiently. When placed in a new environment, an animal develops an internal representation of the space (the coordinated firing of a population of place cells) within minutes, and once this representation is formed it is normally stable for days. The same cell will have the same firing field each time the animal is reintroduced to that environment. When now placed in a second environment, a new map is formed—again in minutes—in part from some of the cells that made up the map of the first environment and in part from pyramidal cells that had been silent previously [reviewed in 85].

It struck me that the formation of a new map resembled a learning process. The map develops with time as the animal walks around for several minutes to

Context Conditioning Is Selectively Impaired in R(AB) Mice

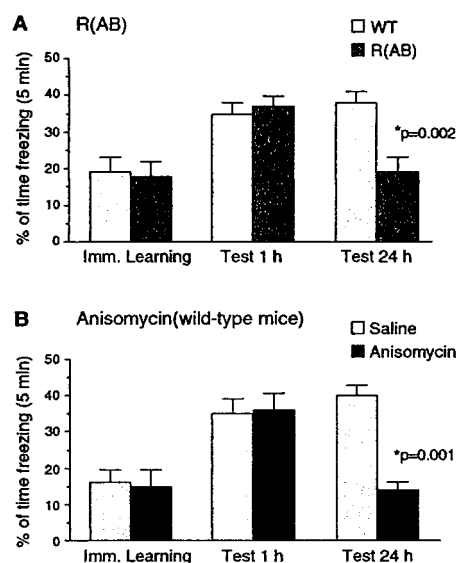
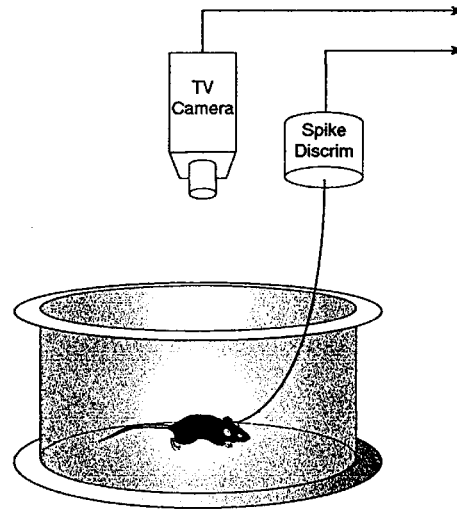

Fig. 26. Mutant mice that express the R(AB) gene in the hippocampus, blocking the action of PKA, have a selective defect for long-term contextual memory (A). Mice that express R(AB) were conditioned to freeze to the context in the form of a box illustrated in Fig. 25. The mice first walked around for a brief period of time and became familiar with the context in which they walked. They then heard a sound and received a shock delivered through the electrified grid in the floor. As a result the animals learned to associate the context of the space with shock and to freeze when placed in the box at a future time. These mice learned well and had good short-term memory at one hour for freezing to context. However, they no longer froze to context at 24 hr after conditioning, indicating a defect in a form of long-term explicit (declarative) memory that requires the hippocampus. Wild-type mice exposed to anisomycin, an inhibitor of protein syntheses, during training show a similar defect for long-term memory when tested 24 hr after conditioning (B), indicating a long-term memory defect is a form of declarative memory that requires the hippocampus. [From 84.]

familiarize itself with the space, and once learned, the map of space is retained for days and weeks. I therefore wondered whether protein synthesis and the molecular pathways underlying the late phase of LTP were important for the long-term stabilization of this map.

Even though both LTP and place cells had been discovered in the early 1970s, there had been no earlier attempt to link neural plasticity to a place cell map pharmacologically or genetically by exploring the role of molecules important for LTP in the formation and stabilization of place fields [86, 87, 88, 89, 103]. In one of our initial experiments, Cliff Kentros, Robert Muller, Hawkins, and I simply blocked LTP pharmacologically using an NMDA receptor antagonist [87]. We found that when placed in a new environment, animals with blocked NMDA receptors formed a good spatial map that was still stable one hour later. However, by 24 hours, the map had become completely unstable. Most pyramidal cells no longer retained the representation of the field they had initially. This suggested that activation of NMDA receptors—perhaps a step in modifying the strength of the synapse—is required for the long-term stabilization of a place cell map, a result consistent with the role for the late phase of LTP in the stabilization of a place cell map.

We next asked: Does a selective deficit that affects only the late phase of LTP and leaves the early phase completely intact, cause a selective abnormality in the long-term stability of place cells? Since only the late phase of LTP requires PKA, Alex Rotenberg, Muller, Abel, Hawkins, and I returned to the R(AB) transgenic mice with diminished PKA activity and a diminished form of late LTP [88]. If reduced activity of PKA affected the stability of place cells, R(AB) mice should be



Place Cell Examples in Mouse

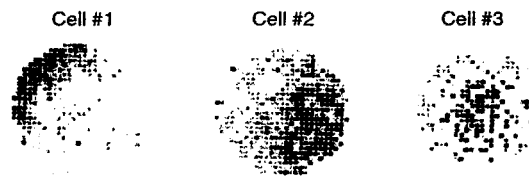

Fig. 27. Spatial memory can be studied in the mouse by recording from individual pyramidal cells in the hippocampus. The firing pattern of these “place” cells create an internal representation of the animal’s location within its surrounding. A mouse is attached to a recording cable and placed inside a cylinder (49 cm in diameter by 34 cm high). The other end of the cable goes to a 235-channel commutator attached to a computer-based spike-discrimination system. The cable is also used to supply power to a light-emitting diode mounted on the headstage the mouse carries. The entire apparatus is viewed with an overhead TV camera whose output goes to a tracking device that detects the position of the mouse. The output of the tracker is sent to the same computer used to detect spikes, so that parallel time series of positions and spikes are recorded. The occurrence of spikes as a function of position is extracted from the basic data and is used to form two-dimensional firing-rate patterns that can be numerically analyzed or visualized as color-coded firing-rate maps. Dark areas indicate regions in the circular enclosure in which the cell fires at high rates. [Based on Kandel and Squire, 1998.]

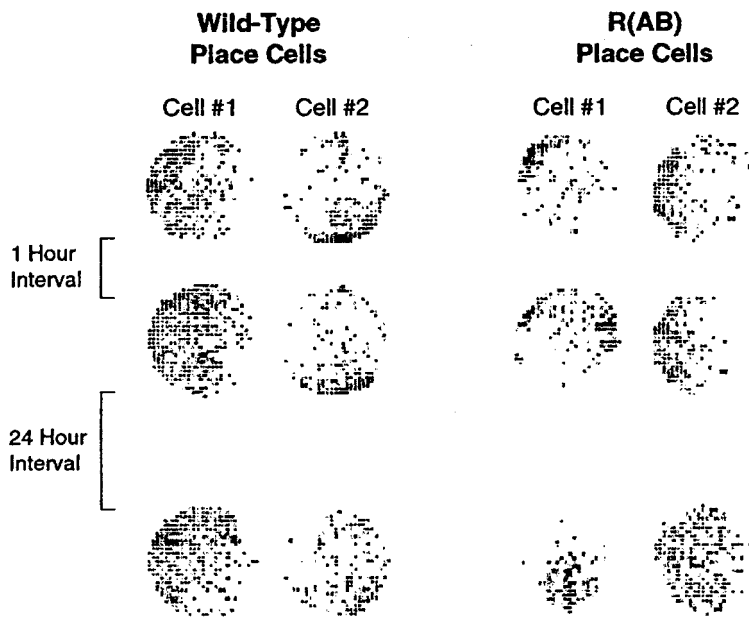

Fig. 28. The long-term stability of the place field of a pyramidal cell in a wild-type mouse and in a mutant mouse. Two simultaneous recordings from pyramidal cells in the hippocampus are illustrated in a wild-type mouse and a mutant mouse. In the wild-type mouse the spatial fields form and are stable when the mouse is taken out of the test environment and put back one hour later. When the wild-type mouse is taken out and put back 24 hr later, the fields of the pyramidal cells are still quite stable. By contrast, in the R(AB) mice in which PKA has been compromised, the pyramidal cells form good fields and these are stable at one hour, but the fields are not stably maintained and are altered at 24 hr.

able to form a stable map of space in a novel environment, as in normal animals, and to be stable for at least one hour. However, the cell field should be unstable if recorded 24 hours later. This is precisely what we found (Fig. 28).

The fact that long-term instability in the spatial map and the deficit in long-term memory paralleled the deficit in the late phase of LTP suggested that PKA-mediated gene activation and the synthesis of new protein might be essential for the stabilization of the spatial map. Naveen Agnihotri, Kentros, Hawkins, and I tested this idea, and found that inhibiting protein synthesis indeed destabilized the place fields in the long-term much as does inhibiting PKA (Fig. 29) [88, 89].

In the course of this work, we found, remarkably, that, as is the case with explicit memories in humans, a key feature in the stabilization of PKA and protein synthesis-dependent phase of memory is attention [90]. When a mouse does not attend to the space it walks through, the map forms but is unstable after three to six hours. When the mouse is forced to attend to the space, however, the map invariably is stable for days. How does this attentional mechanism work? Our recent work suggests that one component of the attentional system necessary for stability of the spatial maps is mediated by the dopaminergic modulatory input acting

Place Cell Map Stability is Dependent Upon PKA and Protein Synthesis

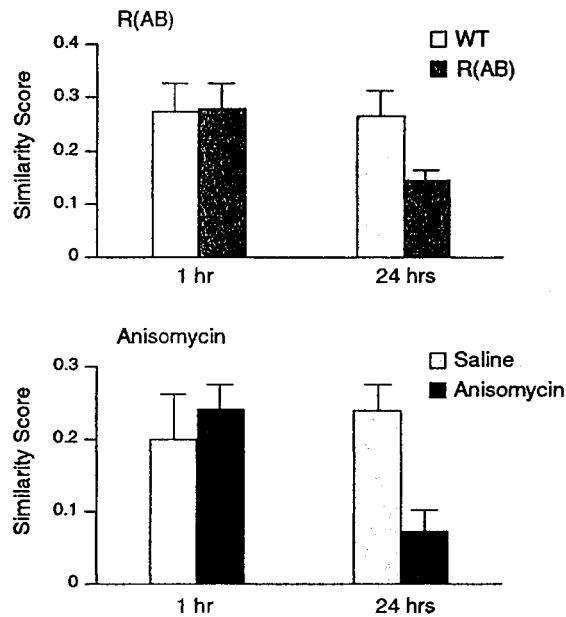

Fig. 29. The group data for mice compromised in PKA, R(AB), and those in which protein synthesis is inhibited. The top graph shows the group data for R(AB) and wild-type mice and the bottom shows that these phenotypes are also obtained by inhibiting protein synthesis with anisomycin. [From 88, 89.]

through a D1/D5 receptor that activates adenylyl cyclase, cAMP, and PKA. The actions of dopamine and other modulatory systems might, among other things, trigger the protein synthesis-dependent steps that stabilize the map.

THERE ARE ALSO INHIBITORY CONSTRAINTS ON LTP AND EXPLICIT MEMORY STORAGE

Recently our laboratory [92] and Emmanuel Landau [116] and his colleagues have found that the threshold for hippocampal synaptic plasticity and memory storage is determined by the balance between protein phosphorylation and dephosphorylation. This balance importantly involves PKA and the Ca^{2+} -sensitive phosphatase, calcineurin, the initial step in a phosphatase cascade [91, 92]. To determine whether endogenous calcineurin acts as a constraint on this balance, we inhibited calcineurin and examined the effects on synaptic plasticity and memory storage. Using the CaM kinase promoter and the doxycycline-dependent rtTA system that Mark Mayford had first successfully applied to the brain, Isabelle Mansuy, Gael Malleret, Danny Winder,

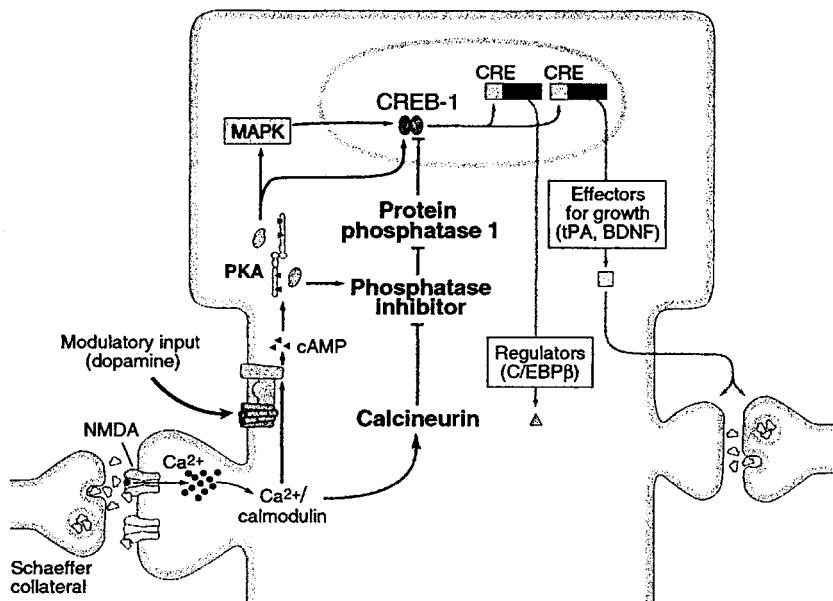

Fig. 30. Long-term potentiation requires regulation not only of kinases but also of phosphatases. The phosphatase cascade initiated by calcineurin shuts off a phosphatase inhibitor and thereby disinhibits the protein phosphatase, which can now inhibit the kinase cascade. [Based on 92.]

Tim Bliss, and I found that a transient reduction of calcineurin activity resulted in facilitation of LTP both *in vitro* and *in vivo* (Fig. 30) [92]. This facilitation persisted over several days in the intact animal, and was accompanied by enhanced learning and strengthening of short- and long-term memory on several spatial and non-spatial tasks requiring the hippocampus. The LTP and memory improvements were reversed fully by suppressing expression of the transgene through withdrawal of doxycycline. These results, together with previous findings by Winder and Mansuy showing that overexpression of calcineurin impairs PKA-dependent components of LTP and memory [83, 91], demonstrate that endogenous calcineurin can act as a negative regulator of synaptic plasticity, learning, and memory (Fig. 30).

AN OVERALL VIEW

The problem of memory storage is conveniently divided into two components: (1) the *storage component* of memory, the molecular mechanism whereby information is stored, and (2) the *systems component* of memory, the mechanisms whereby the storage sites at each point in the explicit or implicit neural system that mediates memory interact to encode, store, and recall memory. I here have addressed primarily the storage component of memory. Our studies of this component have led to two general conclusions.

First, the research I have reviewed suggests that aspects of the storage mechanisms—the cellular and molecular strategies used in *Aplysia* for storing short- and long-term memory—are conserved from mollusk to mammals, and that the same molecular strategies are employed in both implicit and explicit memory storage. With both implicit and explicit memory there are stages in memory that are encoded as changes in synaptic strength and that correlate with the behavioral phases of short- and long-term memory. The short-term synaptic changes involve covalent modification of pre-existing proteins, leading to modification of pre-existing synaptic connections, whereas the long-term synaptic changes involve activation of gene expression, new protein synthesis, and the formation of new connections. Whereas short-term memory storage uses different signaling kinases for implicit and explicit memory, long-term storage of both implicit and explicit memory uses as a core signaling sequence PKA, MAPK, and CREB-1. We presume that this represents only the core signaling pathway, and that at least in the mouse, additional components are recruited.

Finally, in both implicit and explicit memory the switch from short-term to long-term memory is regulated by a number of inhibitory constraints. One such constraint, the balance between protein phosphorylation and dephosphorylation, determines the threshold for hippocampal synaptic plasticity and hippocampal-dependent explicit memory storage. Removing this constraint lowers the threshold of late LTP and enhances storage of explicit memory.

Second, in addition to providing new insights into the molecular mechanisms of learning and memory storage, the molecular biological study of learning has revealed new features of synaptic transmission and new cell biological functions of synaptic signaling. For example, we have learned that modulatory transmitters of the brain serve as reinforcing stimuli important for synaptic plasticity related to learning and memory storage. Different forms of learning recruit these modulatory transmitters which can then act in one of three ways: (1) they activate second-messenger kinases that are transported to the nucleus where they initiate processes required for neuronal growth and long-term memory; (2) they mark the specific synapses for capture of the long-term process and regulate local protein synthesis for stabilization; and (3) modulatory transmitters appear to mediate, in ways we are just beginning to understand, attentional processes required for memory formation and recall.

Most important, the study of long-term memory has made us aware of the extensive dialog between the synapse and the nucleus and the nucleus and the synapse (Fig. 24). The long-range interactions between the nucleus and synapse introduce a new level of non-Sherringtonian integration into neuronal functioning for long-term synaptic plasticity that is different from that used by the short-term process. In the long-term process the response of a synapse is not simply determined by its own history of activity. It is also significantly determined by the history of transcriptional activation in the nucleus.

I started this essay by pointing out that 40 years ago, at the beginning of my career, I thought that a reductionist approach based on the use of a simple experimental system such as *Aplysia* might allow us to address fundamental questions in the study of learning and memory. That was a leap of faith for which I have been

rewarded beyond my fondest hopes. Still, the complexity of explicit memory is formidable, and we have only begun to explore it. We as yet know little about the molecular mechanisms that initiate or stabilize the synaptic growth associated with long-term memory. What are the signaling molecules that lead to the cytoskeletal rearrangements during synaptic remodeling? How do they relate to the molecules involved with synapse formation during development? In addition, we have here only considered the molecular mechanisms of *memory storage*—mechanisms that appeared to be shared, at least in part, by both explicit (declarative) and implicit (procedural) memory. But the storage mechanism is only one part of the memory problem. The more difficult part of memory—especially explicit memory—is the *systems problem* of memory. We still need to seek answers to a family of important questions. How do different regions of the hippocampus and the medial temporal lobe—the subiculum, the entorhinal, parahippocampal and perirhinal cortices—interact in the storage of explicit memory? How is information in any of these regions transferred for ultimate consolidation in the neocortex? We do not, for example, understand why the initial storage of long-term memory requires the hippocampus, whereas the hippocampus is not required once a memory has been stored for weeks or months [reviewed in 95,96]. What critical information does the hippocampus convey to the neocortex?

We also know very little about the nature of recall of explicit (declarative) memory, a recall that requires conscious effort. These systems problems of the brain will require more than the bottoms-up approach of molecular biology. They will also require the top-down approaches of cognitive psychology, neurology, and psychiatry. Finally, they will require a set of syntheses that bridge the two approaches.

Despite these complexities, we have every reason to believe that these and other questions in the biology of learning will be vigorously addressed in the near future. For the biology of the mind has now captured the imagination of the scientific community of the 21st century, much as the biology of the gene fascinated the scientific community of the 20th century. As the biological study of the mind comes to assume the central position within biology and medicine that it deserves, we have every reason to expect that a succession of brain scientists will be called to Stockholm and honored for their own leaps of faith.

ACKNOWLEDGMENTS

I have had the privilege to work with and to learn from many gifted students, fellows, and collaborators, and I have tried throughout this lecture to acknowledge their contributions. But beyond specific collaborators, my science has benefited enormously from the interactive environment created by the Center for Neurobiology and Behavior at the College of Physicians and Surgeons of Columbia University. It would be hard to find a more ideal environment in which to mature as a scientist. Specifically, I have benefited greatly from my long-standing friendship with Richard Axel, Craig Bailey, Jane Dodd, Robert Hawkins, John Koester, Thomas Jessell, James H. Schwartz, Steven Siegelbaum, and Gerald Fischbach, the current Dean of the College of Physicians and Surgeons. I am further grateful to John Koester for his excellent leadership of the Center for Neurobiology and Behavior, and to David

Hirsh, Sam Silverstein, and John Oldham, chairs of the three departments to which I belong. Finally, I am indebted to Herbert Pardes who, until recently, served as Dean of the College of Physicians and Surgeons.

My research has been generously supported by the Howard Hughes Medical Institute, the NIH, the Mathers Foundation, FRAXA, and The Lieber Trust. I am particularly indebted to the Howard Hughes Medical Institute and its leadership, Donald Fredrickson, George Cahill, Purnell Chopin, Max Cowan, Donald Harter, and more recently Tom Cech and Gerry Rubin, whose farsighted vision has encouraged Hughes investigators to take a long-term perspective so as to be able to tackle challenging problems. Research on learning and memory certainly meets both of these criteria!

REFERENCES

1. Kandel, E. R. and Spencer, W. A. (1961) Electrophysiological properties of an archicortical neuron. In *Problems in Electrobiolgy*, *Ann. N.Y. Acad. Sci.* **94**:570–603.
2. Thorpe, W. H. (1963) *Learning and Instinct in Animals*. Revised Edition. Harvard University Press: Cambridge, Mass.
3. Frazier, W. T., Kandel, E. R., Kupfermann, I., Waziri, R., and Coggeshall, R. E. (1967) Morphological and functional properties of identified neurons in the abdominal ganglion of *Aplysia californica*. *J. Neurophysiol.* **30**:1288–1351.
4. Kupfermann, I. and Kandel, E. R. (1969) Neuronal controls of a behavioral response mediated by the abdominal ganglion of *Aplysia*. *Science* **164**:847–850.
5. Pinsker, H., Kupfermann, I., Castellucci, V., and Kandel, E. R. (1970) Habituation and dishabituation of the gill-withdrawal reflex in *Aplysia*. *Science* **167**:1740–1742.
6. Kupfermann, I., Castellucci, V., Pinsker, H., and Kandel, E. R. (1970) Neuronal correlates of habituation and dishabituation of the gill-withdrawal reflex in *Aplysia*. *Science* **167**:1743–1745.
7. Castellucci, V., Pinsker, H., Kupfermann, I., and Kandel, E. R. (1970) Neuronal mechanisms of habituation and dishabituation of the gill-withdrawal reflex in *Aplysia*. *Science* **167**:1745–1748.
8. Pinsker, H. M., Hening, W. A., Carew, T. J., and Kandel, E. R. (1973) Long-term sensitization of a defensive withdrawal reflex in *Aplysia*. *Science* **182**:1039–1042.
9. Carew, T. J., Pinsker, H. M., and Kandel, E. R. (1972) Long-term habituation of a defensive withdrawal reflex in *Aplysia*. *Science* **175**:451–454.
10. Frost, W. N., Castellucci, V. F., Hawkins, R. D., and Kandel, E. R. (1985) Monosynaptic connections made by the sensory neurons of the gill- and siphon-withdrawal reflex in *Aplysia* participate in the storage of long-term memory for sensitization. *Proc. Natl. Acad. Sci. USA* **82**:8266–8269.
11. Byrne, J., Castellucci, V., and Kandel, E. R. (1974) Receptive fields and response properties of mechanoreceptor neurons innervating skin and mantle shelf of *Aplysia*. *J. Neurophysiol.* **37**:1041–1064.
12. Castellucci, V. F., Blumenfeld, H., Goelet, P., and Kandel, E. R. (1989) Inhibitor of protein synthesis blocks long-term behavioral sensitization in the isolated gill-withdrawal reflex of *Aplysia*. *J. Neurobiol.* **20**:1–9.
13. Kandel, E. R. (1976) *Cellular Basis of Behavior: An Introduction to Behavioral Biology*. Freeman: San Francisco.
14. Kandel, E. R. (1978) *A Cell-Biological Approach to Learning*. Grass Lecture Monograph I. Society: Bethesda, Md.
15. Kandel, E. R. (1979) *The Behavioral Biology of Aplysia: A Contribution to the Comparative Study of Opisthobranch Molluscs*. Freeman: San Francisco.
16. Cajal, S. R. (1894) La fine structure des centres nerveux. The Croonian Lecture. *Proc. R. Soc. Lond.* **55**:444–468.
17. Kandel, E. R. and Spencer, W. A. (1968) Cellular neurophysiological approaches in the study of learning. *Physiol. Rev.* **48**:65–134.

18. Hawkins, R. D., Castellucci, V. F., and Kandel, E. R. (1981) Interneurons involved in mediation and modulation of the gill-withdrawal reflex in *Aplysia*. I. Identification and characterization. *J. Neurophysiol.* **45**:304–314.
19. Hawkins, R. D., Castellucci, V. F., and Kandel, E. R. (1981) Interneurons involved in mediation and modulation of the gill-withdrawal reflex in *Aplysia*. II. Identified neurons produce hetero-synaptic facilitation contributing to behavioral sensitization. *J. Neurophysiol.* **45**:315–326.
20. Carew, T. J., Hawkins, R. D., and Kandel, E. R. (1983) Differential classical conditioning of a defensive withdrawal reflex in *Aplysia californica*. *Science* **219**:397–400.
21. Hawkins, R. D., Abrams, T. W., Carew, T. J., and Kandel, E. R. (1983) A cellular mechanism of classical conditioning in *Aplysia*: Activity-dependent amplification of presynaptic facilitation. *Science* **219**:400–405.
22. Byrne, J. H., Castellucci, V. F., and Kandel, E. R. (1978) Contribution of individual mechanoreceptor sensory to defensive gill-withdrawal reflex in *Aplysia*. *J. Neurophysiol.* **41**:418–431.
23. Carew, T. J., Castellucci, V. F., and Kandel, E. R. (1979) Sensitization in *Aplysia*: Restoration of transmission in synapses inactivated by long-term habituation. *Science* **205**:417–419.
24. Klein, M. and Kandel, E. R. (1980) Mechanism of calcium current modulation underlying presynaptic facilitation and behavioral sensitization in *Aplysia*. *Proc. Natl. Acad. Sci. USA* **77**:6912–6916.
25. Klein, M., Hochner, B., and Kandel, E. R. (1986) Facilitatory transmitters and cAMP can modulate accommodation as well as transmitter release in *Aplysia* sensory neurons. Evidence for parallel processing in a single cell. *Proc. Natl. Acad. Sci. USA* **83**:7994–7998.
26. Schwartz, J. H., Castellucci, V. F., and Kandel, E. R. (1971) Functioning of identified neurons and synapses in abdominal ganglion of *Aplysia* in absence of protein synthesis. *J. Neurophysiol.* **34**:939–953.
27. Cedar, H., Kandel, E. R., and Schwartz, J. H. (1972) Cyclic adenosine monophosphate in the nervous system of *Aplysia californica*. I. Increased synthesis in response to synaptic stimulation. *J. Gen. Physiol.* **60**:558–569.
28. Kriegstein, A. R., Castellucci, V., and Kandel, E. R. (1974) Metamorphosis of *Aplysia californica* in laboratory culture. *Proc. Natl. Acad. Sci. USA* **71**:3654–3658.
29. Cedar, H. and Schwartz, J. H. (1972) Cyclic adenosine monophosphate in the nervous system of *Aplysia californica*. II. Effect of serotonin and dopamine. *J. Gen. Physiol.* **60**:570–587.
30. Castellucci, V. and Kandel, E. R. (1974) A quantal analysis of the synaptic depression underlying habituation of the gill-withdrawal reflex in *Aplysia*. *Proc. Natl. Acad. Sci. USA* **71**:5004–5008.
31. Castellucci, V. and Kandel, E. R. (1976) Presynaptic facilitation as a mechanism for behavioral sensitization in *Aplysia*. *Science* **194**:1176–1178.
32. Brunelli, M., Castellucci, V., and Kandel, E. R. (1976) Synaptic facilitation and behavioral sensitization in *Aplysia*: Possible role of serotonin and cyclic AMP. *Science* **194**:1178–1181.
33. Kandel, E. R., Brunelli, M., Byrne, J., and Castellucci, V. (1976) A common presynaptic locus for the synaptic changes underlying short-term habituation and sensitization of the gill-withdrawal reflex in *Aplysia*. *Cold Spring Harbor Symp. Quant. Biol.* **40**:465–482.
34. Glanzman, D. L., Mackey, S. L., Hawkins, R. D., Dyke, A. M., Lloyd, P. E., and Kandel, E. R. (1989) Depletion of serotonin in the nervous system of *Aplysia* reduces the behavioral enhancement of gill withdrawal as well as the heterosynaptic facilitation produces by tail shock. *J. Neurosci.* **9**:4200–4213.
35. Mackay, S. L., Kandel, E. R., and Hawkins, R. D. (1989) Identified serotonergic neurons LCBI and RCBI in the cerebral ganglia of *Aplysia* produce presynaptic facilitation of siphon sensory neurons. *J. Neurosci.* **9**:4227–4235.
36. Byrne, J. H., Castellucci, V. F., Carew, T. J., and Kandel, E. R. (1978) Stimulus-response relations and stability of mechanoreceptor and motor neurons mediating defensive gill-withdrawal reflex in *Aplysia*. *J. Neurophysiol.* **41**:402–417.
37. Castellucci, V. F., Kandel, E. R., Schwartz, J. H., Wilson, F. D., Nairn, A. C., and Greengard, P. (1980) Intracellular injection of the catalytic subunit of cyclic AMP-dependent protein kinase simulates facilitation of transmitter release underlying behavioral sensitization in *Aplysia*. *Proc. Natl. Acad. Sci. USA* **77**:7492–7496.
38. Castellucci, V. F., Nairn, A., Greengard, P., Schwartz, J. H., and Kandel, E. R. (1982) Inhibitor of adenosine 3':5'-monophosphate-dependent protein kinase blocks presynaptic facilitation in *Aplysia*. *J. Neurosci.* **2**:1673–1681.

39. Siegelbaum, S., Camardo, J. S., and Kandel, E. R. (1982) Serotonin and cAMP close single K⁺ channels in *Aplysia* sensory neurons. *Nature* **299**:413–417.
40. Shuster, M. J., Camardo, J. S., Siegelbaum, S. A., and Kandel, E. R. (1985) Cyclic AMP-dependent protein kinase closes the serotonin-sensitive K⁺ channels of *Aplysia* sensory neurons in cell-free membrane patches. *Nature* **313**:392–395.
41. Byrne, J. H. and Kandel, E. R. (1995) Presynaptic facilitation revisited: State and time dependence. *J. Neurosci.* **16**:425–435.
42. Rayport, S. G. and Schacher, S. (1986) Synaptic plasticity in vitro: Cell culture of identified *Aplysia* neurons mediating short-term habituation and sensitization. *J. Neurosci.* **6**:759–763.
43. Montarolo, P. G., Golet, P., Castellucci, V. F., Morgan, J., Kandel, E. R., and Schacher, S. (1986) A critical period for macromolecular synthesis in long-term heterosynaptic facilitation in *Aplysia*. *Science* **234**:1249–1254.
44. Schacher, S., Castellucci, V. F., and Kandel, E. R. (1988) cAMP evokes long-term facilitation in *Aplysia* sensory neurons that requires new protein synthesis. *Science* **240**:1667–1669.
45. Dash, P. K., Hochner, B., and Kandel, E. R. (1990) Injection of cAMP-responsive element into the nucleus of *Aplysia* sensory neurons blocks long-term facilitation. *Nature* **345**:718–721.
46. Bacskaï, B. J. *et al.* (1993) Spatially resolved dynamics of cAMP and protein kinase A subunits in *Aplysia* sensory neurons. *Science* **260**:222–226.
47. Martin, K. C. *et al.* (1997) MAP kinase translocates into the nucleus of the presynaptic cell and is required for long-term facilitation in *Aplysia*. *Neuron* **18**:899–912.
48. Bailey, C. H. *et al.* (1997) Mutation in the phosphorylation sites of MAP kinase blocks learning-related internalization of apCAM in *Aplysia* sensory neurons. *Neuron* **18**:913–924.
49. Kaang, B.-K., Kandel, E. R., and Grant, S. G. N. (1993) Activation of cAMP-responsive genes by stimuli that produce long-term facilitation in *Aplysia* sensory neurons. *Neuron* **10**:427–435.
50. Glanzman, D. L., Kandel, E. R., and Schacher, S. (1990) Target-dependent structural changes accompanying long-term synaptic facilitation in *Aplysia* neurons. *Science* **249**:799–802.
51. Dale, N. and Kandel, E. R. (1993) L-glutamate may be the fast excitatory transmitter of *Aplysia* sensory neurons. *Proc. Natl. Acad. Sci. USA* **90**:7163–7167.
52. Alberini, C., Ghirardi, M., Metz, R., and Kandel, E. R. (1994) C/EBP is an immediate-early gene required for the consolidation of long-term facilitation in *Aplysia*. *Cell* **76**:1099–1114.
53. Bartsch, D., *et al.* (1995) *Aplysia* CREB2 represses long-term facilitation: Relief of repression converts transient facilitation into long-term functional and structural change. *Cell* **83**:979–992.
54. Bartsch, D., Casadio, A., Karl, K. A., Serodio, P., and Kandel, E. R. (1998) CREB1 encodes a nuclear activator, a repressor, and a cytoplasmic modulator that form a regulatory unit critical for long-term facilitation. *Cell* **95**:211–223.
55. Bartsch, D. *et al.* (2000) Enhancement of memory-related long-term facilitation by ApAF, a novel transcription factor that acts downstream from both CREB1 and CREB2. *Cell* **103**:595–608.
56. Bailey, C. H., Montarolo, P., Chen, M., Kandel, E. R., and Schacher, S. (1992) Inhibitors of protein and RNA synthesis block structural changes that accompany long-term heterosynaptic plasticity in *Aplysia*. *Neuron* **9**:749–758.
57. Bailey, C. H. and Chen, M. (1988) Long-term memory in *Aplysia* modulates the total number of varicosities of single identified sensory neurons. *Proc. Natl. Acad. Sci. USA* **85**:2373–2377.
58. Bailey, C. H. and Chen, M. (1989) Time course of structural changes at identified sensory neuron synapses during long-term sensitization in *Aplysia*. *J. Neurosci.* **9**:1774–1780.
59. Bailey, C. H. and Kandel, E. R. (1993) Structural changes accompanying memory storage. *Annu. Rev. Physiol.* **55**:397–426.
60. Hedge, A. N. *et al.* (1997) Ubiquitin C-terminal hydrolase is an immediate-early gene essential for long-term facilitation in *Aplysia*. *Cell* **89**:115–126.
61. Chain, D. G. *et al.* (1999) Mechanisms for generating the autonomous cAMP-dependent protein kinase required for long-term facilitation in *Aplysia*. *Neuron* **22**:147–156.
62. Mayford, M., Barzilai, A., Keller, F., Schacher, S., and Kandel, E. R. (1992) Modulation of an NCAM-related adhesion molecule with long-term synaptic plasticity in *Aplysia*. *Science* **256**:638–644.
63. Bailey, C. H., Chen, M., Keller, F., and Kandel, E. R. (1992) Serotonin-mediated endocytosis of apCAM: An early step of learning-related synaptic growth in *Aplysia*. *Science* **256**:645–649.

64. Martin, K. C. *et al.* (1998) Synapse-specific transcription-dependent long-term facilitation of the sensory to motor neuron connection in *Aplysia*: A function for local protein synthesis in memory storage. *Cell* **91**:927–938.
65. Casadio, A. *et al.* (1999) A transient neuron-wide form of CREB-mediated long-term facilitation can be stabilized at specific synapses by local protein synthesis. *Cell* **99**:221–237.
66. Bacsikai, B. J. *et al.* (1993) Spatially resolved dynamics of cAMP and protein kinase A subunits in *Aplysia* sensory neurons. *Science* **260**:222–226.
67. Grant, S. G. N., O'Dell, T. J., Karl, K. A., Stein, P. L., Soriano, P., and Kandel, E. R. (1992) Impaired long-term potentiation, spatial learning, and hippocampal development in *fyn* mutant mice. *Science* **258**:1903–1910.
68. Squire, L. R. and Kandel, E. R. (1999) *Memory: Mind to Molecules*. Scientific American Books: New York.
69. Bliss, T. V. and Lomo, T. (1973) Long-lasting potentiation of synaptic transmission in the denate area of the anaesthetized rabbit following stimulation of the perforant path. *J. Physiol.* **232**:331–356.
70. Morris, R. G. M., Anderson, E., Lynch, G. S., and Baudry, M. (1986) Selective impairment of learning and blockade of long-term potentiation by an *N*-methyl-*D*-aspartate receptor antagonist, AP5. *Nature* **319**:774–776.
71. Frey, U., Huang, Y.-Y., and Kandel, E. R. (1993) Effects of cAMP simulate a late stage of LTP in hippocampal CA1 neurons. *Science* **260**:1661–1664.
72. Huang, Y.-Y. and Kandel, E. R. (1994) Recruitment of long-lasting and protein kinase A-dependent long-term potentiation in the CA1 region of hippocampus requires repeated tetanization. *Learning & Memory* **1**:74–82.
73. Nguyen, P. V., Abel, T., and Kandel, E. R. (1994) Requirement of a critical period of transcription for induction of a late phase of LTP. *Science* **265**:1104–1107.
74. Bolshakov, V. Y., Golan, H., Kandel, E. R., and Siegelbaum, S. A. (1997) Recruitment of new sites of synaptic transmission during the cAMP-dependent late phase of LTP at CA3-CA1 synapses in the hippocampus. *Neuron* **19**:635–651.
75. Malenka, R. C. and Nicoll, R. A. (1997) Silent synapses speak up. *Neuron* **19**:473–476.
76. Ma, L., Zablow, L., Kandel, E. R., and Siegelbaum, S. A. (1999) Cyclic AMP induces functional presynaptic boutons in hippocampal CA3-CA1 neuronal cultures. *Nature Neurosci.* **2**:24–3.
77. Bourtochouladze, R., Franguelli, B., Blendy, J., Cioffi, D., Schutz, G., and Silva, A. J. (1994) Deficient long-term memory in mice with a targeted mutation of the cAMP-responsive element-binding protein. *Cell* **79**:59–68.
78. Impey, S. *et al.* (1998) Cross talk between ERK and PKA is required for Ca²⁺ stimulation of CEB-dependent transcription and ERK nuclear translocation. *Neuron* **21**:869–883.
79. Huang, Y.-Y. and Kandel, E. R. (1995) D1/D5 receptor agonists induce a protein synthesis-dependent late potentiation in the CA1 region of the hippocampus. *Proc. Natl. Acad. Sci. USA* **92**:2446–2450.
80. Muller, D. (1997) Ultrastructural plasticity of excitatory synapses. *Rev. Neurosci.* **8**:77–93.
81. English, J. D. and Sweatt, J. D. (1996) Activation of p42 mitogen-activated protein kinase in hippocampal long term potentiation. *J. Biol. Chem.* **271**:24329–24332.
82. Engert, F. and Bonhoeffer, T. (1999) Dendritic spine changes associated with hippocampal long-term synaptic plasticity. *Nature* **399**:66–70.
83. Winder, D. G., Mansuy, I. M., Osman, M., Moallem, T. M., and Kandel, E. R. (1998) Genetic and pharmacological evidence for a novel, intermediate phase of long-term potentiation (I-LTP) suppressed by calcineurin. *Cell* **92**:25–37.
84. Abel, T. *et al.* (1997) Genetic demonstration of a role for PKA in the last phase of LTP and in hippocampus-based long-term memory. *Cell* **88**:615–626.
85. O'Keefe, J. and Nadel, L. (1978) *The Hippocampus as a Cognitive Map*. Clarendon Press: Oxford.
86. Rotenberg, A., Mayford, M., Hawkins, R. D., Kandel, E. R., and Muller, R. U. (1996) Mice expressing activated CaMKII lack low frequency LTP and do not form stable place cells in the CA1 region of the hippocampus. *Cell* **87**:1351–1361.
87. Kentros, C., Hargreaves, E., Hawkins, R. D., Kandel, E. R., Shapiro, M., and Muller, R. U. (1998) Abolition of long-term stability of new hippocampal place cell maps by NMDA receptor blockade. *Science* **280**:2121–2126.

88. Rotenberg, A., Abel, T., Hawkins, R. D., Kandel, E. R., and Muller, R. U. (2000) Parallel instabilities of long-term potentiation, place cells, and learning caused by decreased protein kinase A activity. *J. Neurosci.* **20**:8096–8102.
89. Agnihotri, N., Hawkins, R. D., Kandel, E. R., and Kentros, C. (2001) Protein synthesis inhibition selectively abolishes long-term stability of hippocampal place cell maps. *Soc. Neurosci. Abstr.*, in press.
90. Kentros, C., Agnihotri, N., Hawkins, R., Muller, R., and Kandel, E. (2001) Stabilization of the hippocampal representation of space in mice requires attention. *Soc. Neurosci. Abstr.*, in press.
91. Mansuy, I. M., Mayford, M., Jacob, B., Kandel, E. R., and Bach, M. E. (1990) Restricted and regulated overexpression reveals calcineurin as a key component in the transition from short-term to long-term memory. *Cell* **92**:39–49.
92. Mallaret, G. *et al.* (2001) Inducible and reversible enhancement of learning, memory, and long-term potentiation by genetic inhibition of calcineurin. *Cell* **104**:675–686.
93. Frey, U. and Morris, R. G. (1997) Synaptic tagging and long-term potentiation. *Nature* **385**:533–536.
94. Castellucci, V. F., Carew, T. J., and Kandel, E. R. (1978) Cellular analysis of long-term habituation of the gill-withdrawal reflex in *Aplysia*. *Science* **202**:1306–1308.
95. Milner, B., Squire, L. R., and Kandel, E. R. (1998) Cognitive neuroscience and the study of memory. *Neuron* **20**:445–468.
96. Squire, L. R. and Zola-Morgan, S. (1991) The medial temporal lobe memory system. *Science* **253**:1380–1386.
97. Dubnau, J. and Tully, T. (1998) Gene discovery in *Drosophila*: New insights for learning and memory. *Annu. Rev. Neurosci.* **21**:407–444.
98. Frost, W. N., Castellucci, V. F., Hawkins, R. D., and Kandel, E. R. (1985) Monosynaptic connections made by the sensory neurons of the gill- and siphon-withdrawal reflex in *Aplysia* participate in the storage of long-term memory for sensitization. *Proc. Natl. Acad. Sci. USA* **82**:8266–8269.
99. Martin, K. C., Barad, M., and Kandel, E. R. (2000) Local protein synthesis and its role in synapse-specific plasticity. *Curr. Opin. Neurobiol.* **10**:587–592.
100. Schuman, E. M. (1997) Synapse specificity and long-term information storage. *Neuron* **18**:339–342.
101. Steward, O. (1997) mRNA localization in neurons: A multipurpose mechanism? *Neuron* **18**:9–12.
102. Weiner, J. (1999) *Time, Love, Memory: A Great Biologist and His Quest for the Origins of Behavior*. Knopf: New York.
103. Muller, R. (1996) A quarter of a century of place cells. *Neuron* **17**:813–822.
104. McHugh, T. J., Blum, K. I., Tsien, J. Z., Tonegawa, S., and Wilson, M. A. (1996) Impaired hippocampal representation of space in CA1 specific NMDAR1 knockout mice. *Cell* **87**:1339–1349.
105. Bolshakov, V. Y. and Siegelbaum, S. A. (1995) Regulation of hippocampal transmitter release during development and long-term potentiation. *Science* **269**:1730–1734.
106. Stevens, C. F. and Wang, Y. (1994) Changes in reliability of synaptic function as a mechanism for plasticity. *Nature* **371**:704–707.
107. Ebbinghaus, H. (1885) *Memory: A Contribution to Experimental Psychology* (1885). Reprinted, Dover: New York, 1963.
108. Flexner, L. B. and Flexner, J. B. (1966) Effect of acetoxycyclohexamide and of an acetoxycyclohexamide-purymycin mixture on cerebral protein synthesis and memory in mice. *Proc. Natl. Acad. Sci. USA* **55**:369–374.
109. Brink, J. J., Davis, R. E., and Agranoff, B. W. (1966) Effects of puromycin, acetoxycyclohexamide and actinomycin D on protein synthesis in goldfish brain. *J. Neurochem.* **13**:889–896.
110. Fatt, P. and Katz, B. (1951) An analysis of the end-plate potential recorded with an intracellular electrode. *J. Physiol. (Lond.)* **115**:320–370.
111. Greengard, P. (1976) Possible role for cyclic nucleotides and phosphorylated membrane proteins in postsynaptic actions of neurotransmitters. *Nature* **260**:101–108.
112. Monsour, S. L., Thomas, K. R., and Capecchi, M. R. (1988) Disruption of the proto-oncogene int-2 in mouse embryonic-derived stem cells: A general strategy for targeting mutations to non-selectible genes. *Nature* **336**:348–352.
113. Reid, L. H., Shesely, E. G., Kin, H. S., and Smithies, O. (1991) Cotransformation and gene targeting in mouse embryonic stem cells. *Mol. Cell Biol.* **11**:2769–2777.

114. Koller, B. H. and Smithies, O. (1989) Inactivating the beta 2-microglobulin locus in mouse embryonic stem cells by homologous recombination. *Proc. Natl. Acad. Sci. USA* **86**:8932–8935.
115. Kandel, E. R. and Schwartz, J. H. (1982) Molecular biology of learning: Modulation of transmitter release. *Science* **218**:433–443.
116. Blitzer, R. D. *et al.* (1998) Gating of CaMKII by cAMP-regulated protein phosphatase activity during LTP. *Science* **280**:1940–1942.