

THE OMNI ADVANTAGE

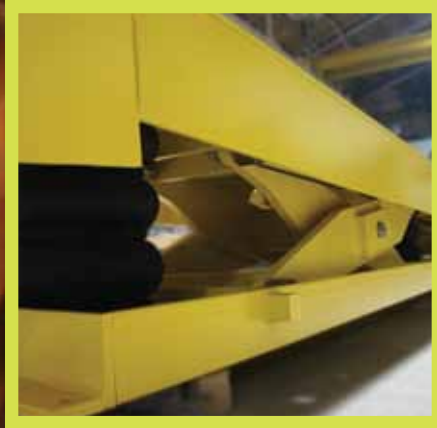

Index

Automotive.....	3
Battery Handling.....	12
Case Handling.....	14
Drum Handling.....	18
Food Handling.....	20
Foundry.....	24
Glass Handling.....	28
Pallet Handling.....	30
Steel Handling.....	34
Tube/Pipe/Roll.....	40
More Solutions.....	42
Standard Offering.....	46
Options.....	51

The Omni Advantage

Omni Metalcraft Corp. is your single source for conveyors and material handling equipment.

We offer a comprehensive line of products to meet your needs. From transporting totes and aligning packages, to rotating engines and diverting tires, Omni is your solution.

Our careful planning, attention to detail and industry-leading experience are aimed at providing you with quality products that are specific to your needs. And no matter how complex the application may be, Omni's goals are simple.

We will work closely with you to understand your application and help turn your concept into reality. We will provide you with products and services that help you succeed.

Omni is *your* supplier. Omni is *your* solution. Omni is the advantage you need.



Rim Handling System

Chain Driven Live Roller Conveyor (CDLR) with fork pockets for pallet loading feeds a turntable equipped with CDLR mounted to a scissor lift for ergonomic unloading of stacked pallets. UHMW scheduling tables are affixed to the sides to aide the operator in manually unloading tire rims off pallets. The rims are loaded onto multiple lanes of CDLR with Ultrex Sleeves which feed escapements releasing the rims to the main line.



High Speed Tire Transportation

- Transverse Roller Top (TRT) Plastic Belt Conveyor
- Three Tier Multiple Infeed
- Heavy Duty Structural Steel Leg Construction



Tractor Tire Mounting

- Tandem Scissor Lift
- Heavy Duty Construction
- 75,000 lb. Capacity

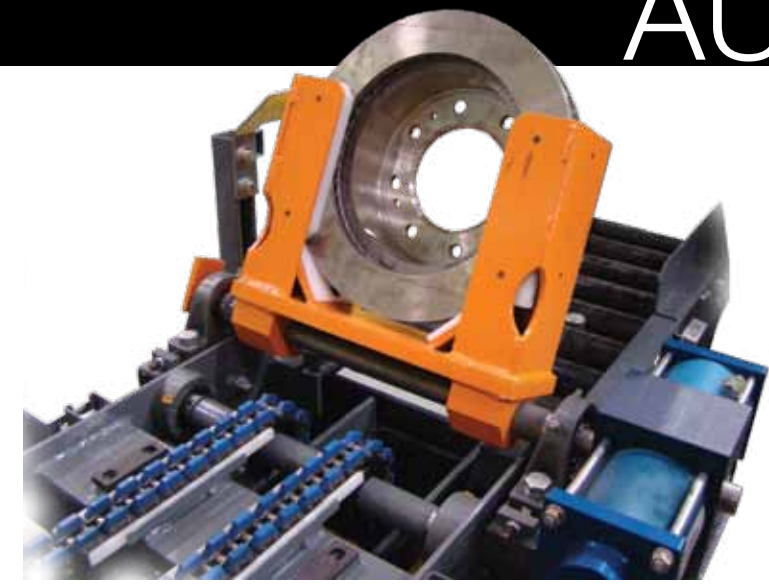

Rotor Turnover Device

- Internal Padded Chain Conveyor
- Discharge Chain Driven Live Roller Conveyor
- Ultrex Sleeves for Rotor Accumulation
- Pneumatic Turnover Device



Tire Silo

- Oval Chain Driven Live Roller Conveyor
- Flowrail Guides
- Ultrex Sleeves for Accumulation
- Hold Downs



Remanufacturing Engine Blocks

- Chain Driven Live Roller Conveyor
- Transfer Car

Seat Pallet Stacker

- Reversing Chain Conveyor
- Gravity Roller Conveyor
- Pneumatic Tip Up Device
- Dunnage Stacker



Engine Block Assembly Station

- Chain Driven Live Roller Conveyor
- Embedded Locating Stop Device
- Hydraulic Tilter
- Turntable

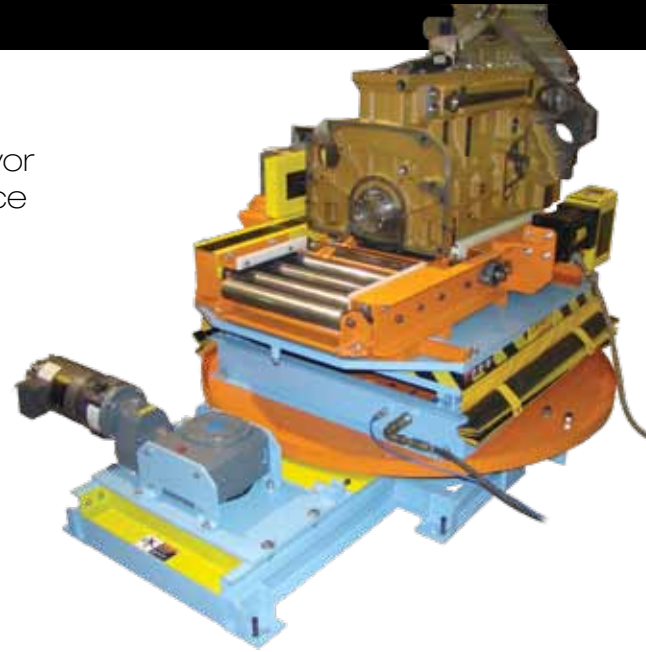

Engine Turnover

- Split Lane Chain Driven Live Roller Conveyor
- Large Diameter Urethane Coated Rollers
- UHMW Side Guides
- Powered Turnover Device

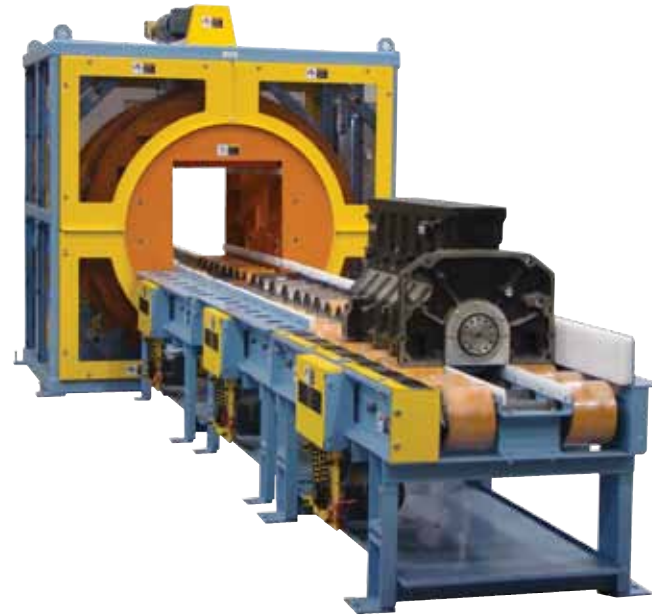

Automotive Glass Inspection, Trimming and Assembly Station

- Powered Turntable
- Lift and Rotate, Pneumatically Actuated Suction Cups
- Ergonomic Workstations
- Urethane Covered Glass Supports

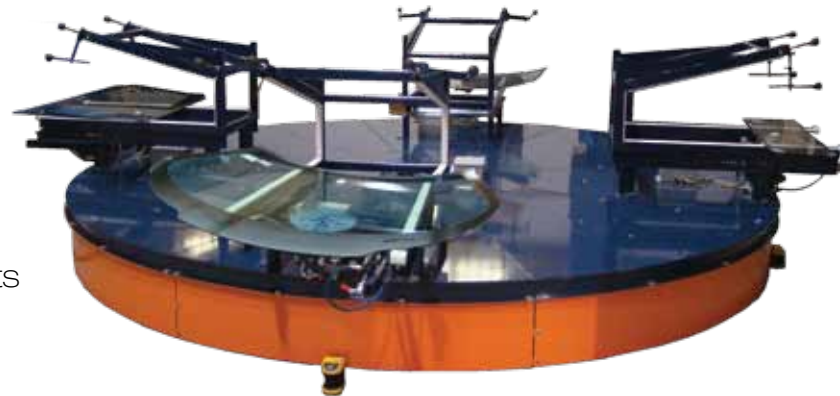

Pallet Pack-Out Station

- Zoned Chain Driven Live Roller Conveyor
- Two Strand Chain Transfer
- Adjustable End Stops
- Side Load Fork Truck Pockets
- Pneumatic Blade Stops



Tire Storage and Assembly

- Gravity Roller Silo
- Flowrail Guides
- Pneumatic Tire Tip Up
- Ball Transfer Workstation

8



Tire Reject Line

- Transverse Roller Top (TRT)
- Plastic Belt Conveyor
- Pneumatic Diverter Arm
- Gravity Roller Decline



Multi Lane Manual Tire Switch

- Transverse Roller Top (TRT)
- Plastic Belt Conveyor
- Gravity Roller Guides
- Three Lanes Wide

Tractor Tire Assembly

- Custom Scissor Lifts
- Simultaneous Actuation



9

Omni Metalcraft Corp.

Tire Unloading System

The Application:

Ergonomic tire unloading

The Need:

An automotive manufacturer added two new docks to their current tire system. They needed to receive tires from the new docks to existing plant conveyor.

The Solution:

Omni Metalcraft Corp. provided a Chain Driven Live Roller Conveyor Pneumatic Lift Gate to bridge the gap between the delivery truck and the plant conveyor while also allowing operators to pass through. Transverse Roller Top Plastic Belt Conveyor was integrated with the CDLR to transfer the tires from the lift gate to the existing conveyor.

Ultrax Sleeves for Accumulation

Intralox Series 400 Transverse Roller Top (TRT)

Radius Roller Guides

Flowrail Guides

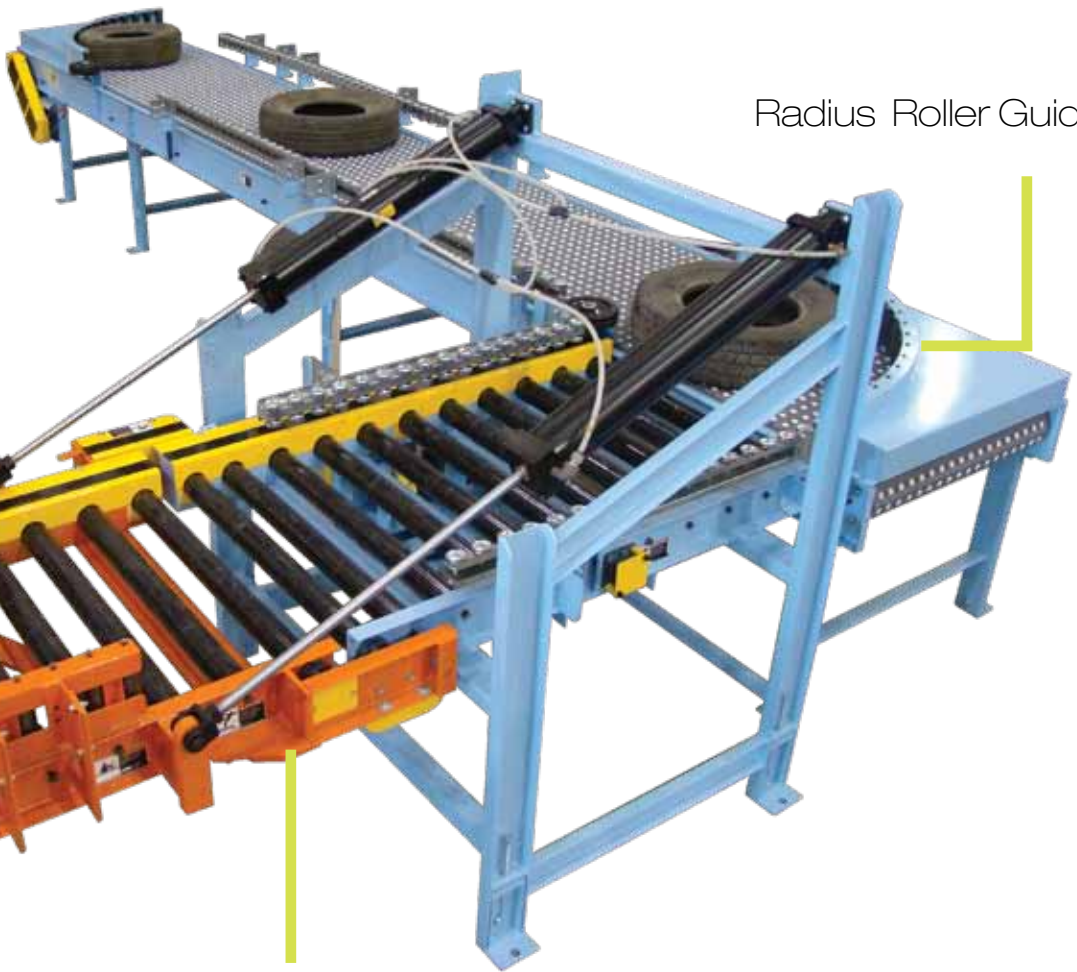

Pneumatic Lift Gate

BATTERY HANDLING

Battery Curing and Storage

- Modular Plastic Belt Conveyor
- Low Speed
- Multi-Lane
- Gravity Roller Conveyor Workstation
- Zero Pressure Accumulation Motor Driven Roller Conveyor

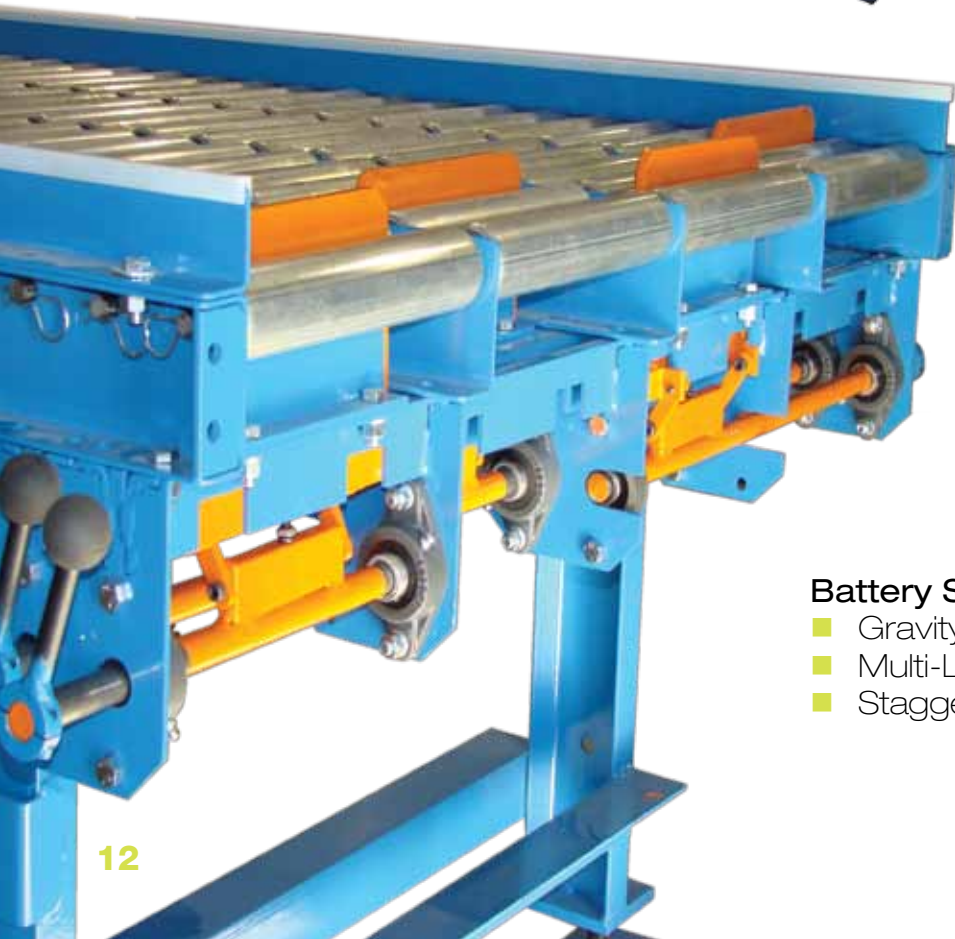

Battery Storage

- Gravity Roller Conveyor
- Multi-Lane
- Staggered Manual Blade Stops



Automated Cell Zero Pressure MDR Conveyor System for Battery Assembly and Storage

A dual tier, four lane, compact, yet heavy duty, Motor Driven Roller Conveyor system accepts batteries that are assembled and placed on a pallet robotically. The pallet is then positioned utilizing a crowder, then is transferred to a CDLR conveyor mounted to a scissor lift on a transfer car that transports the battery to the correct storage level and lane for curing. As batteries are added, they are accumulated on zero pressure MDR and conveyed to the last zone for forklift pick up.

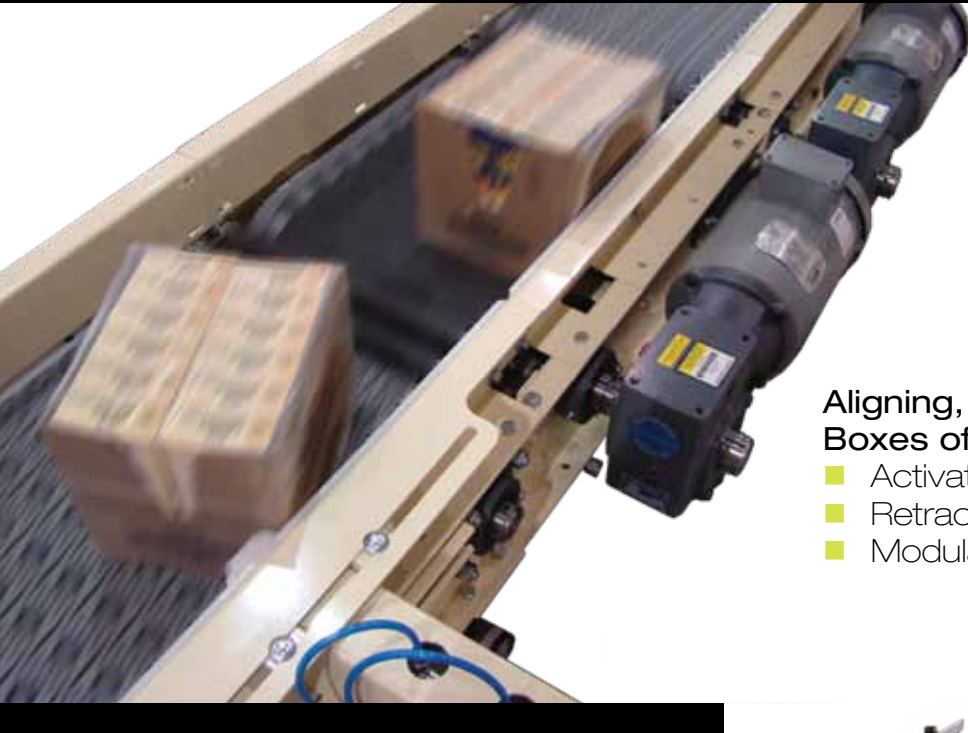

Aligning, Gapping and Selectively Turning Boxes of Pasta for Layer Forming

- Activated Roller Belt™ Aligner
- Retractable Bump Turn
- Modular Plastic Rough Top Gapping Belt

Case Rotation for Manual Ergonomic Filling

- Helix Lineshaft Conveyor
- Urethane Tipped Rollers

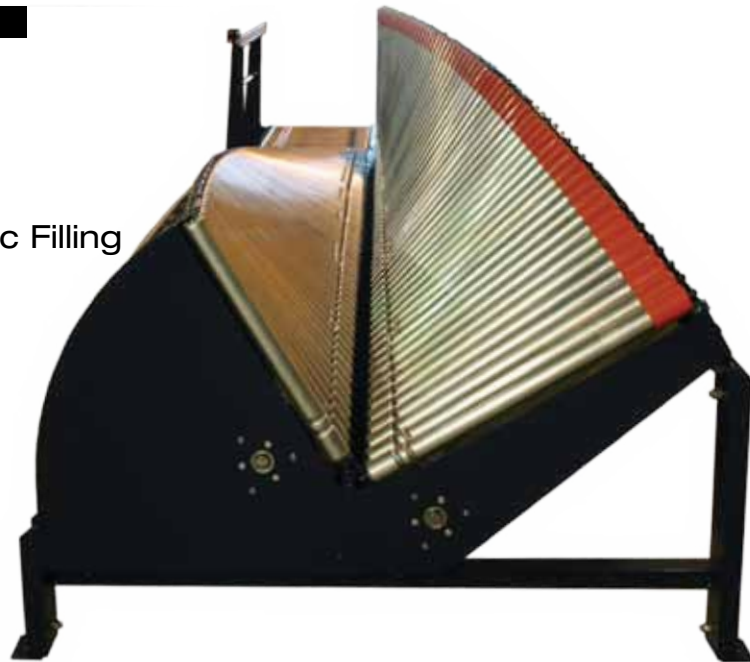

Cased Meat Reject Station

Stainless Steel Inline Activated Roller Belt™ conveyor transports cases of meat to an inspection area. The inline roller belt utilizes activated, speed up zones to create a gap allowing enough time to either accept an inspected case by passing through a pneumatic overhead stop or reject the case by engaging the stop. De-activated roller belt is then used to transfer the case to take away and accumulation Transverse Roller Top (TRT) conveyor.

Floor to Floor Conveyance of Cased Meat

- P-Class Stainless Steel Continuous Vertical Conveyor
- Stainless Infeed Chain Driven Live Roller Conveyor



Justifying and Diverting Packaged Zoned Accumulation of Cased Household Cleaning Supplies

- Zero Pressure 24 Volt Flat Motor Driven Roller Conveyor
- Integrated Stand Alone Logic Cards
- Low Friction Plates on Side Guides



Justifying and Diverting Packaged Peanuts Prior to a Scanner

- Activated Roller Belt™ Aligner
- 90° Passive Divert
- Small Footprint





Handling Full Drums of Chemicals

- Stainless Steel Flat Top Plastic Belt Conveyor Used for Accumulation
- 90° Transfer with Turning Wheel



Drum Picking

- Portable Belt Curve
- Urethane Coated Chain Driven Live Roller Conveyor
- Pivoting V-Endstop



Drum Accumulation and Indexing Utilizing CDLR

Drums full of chemicals are accumulated using zero pressure Chain Driven Live Roller (CDLR) Conveyor. The drums are then indexed onto the adjacent CDLR using pop up Chain Transfers to then be transported down stream for cleaning and disposal.



Loading Totes in a Baked Goods Production Line

- Two Strand Chain Conveyor
- Funneling Load Guides
- Filler Plate
- Fork Pockets

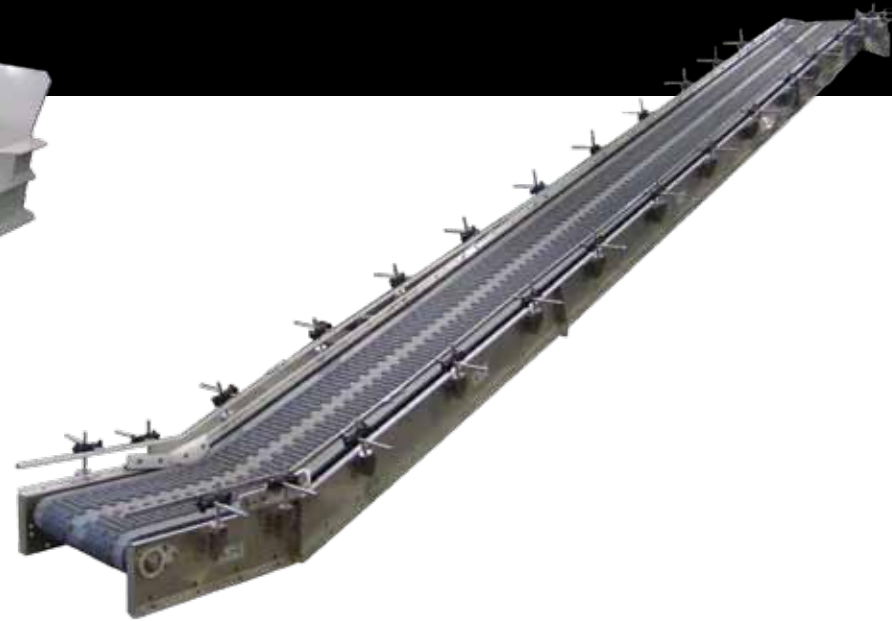

Transporting Boxed Meat through the Packaging Process

- Inclined Stainless Steel Plastic Belt Conveyor
- Adjustable Side Guides
- Friction Top Belt



Flipping Sliced Hamburger Buns

- Bi-Level Flat Top Plastic Belt Conveyor



Sanitary Peanut Conveyor

Ultimate Class Stainless Steel Sanitary Belt Conveyor equipped with a discharge chute, catch pan, food grade belting and quick release take-ups used to convey peanuts. An open UHMW bed design with side frame cleanout ports allows for ultimate cleanability by creating sanitation access.

Transporting Bulk Cheese to a Packaging Operation

- Ultimate Class Stainless Steel Sanitary Belt Conveyor
- Tool-Free Disassembly
- Adjustable Side Guides
- Motorized Sanitary Pulley



Conveying Frozen Vegetables through an Elevation Change

- Sanitary, Incline Plastic Belt Conveyor
- Cleated Belt
- Cleanout Ports



Transporting Food Product

- Sanitary Stainless Steel Metal Belt Conveyor
- Open Style Construction



Handling Packaged Cheese Products

- Inclining and Declining Modular Table Top Conveyor
- Discharge Chute



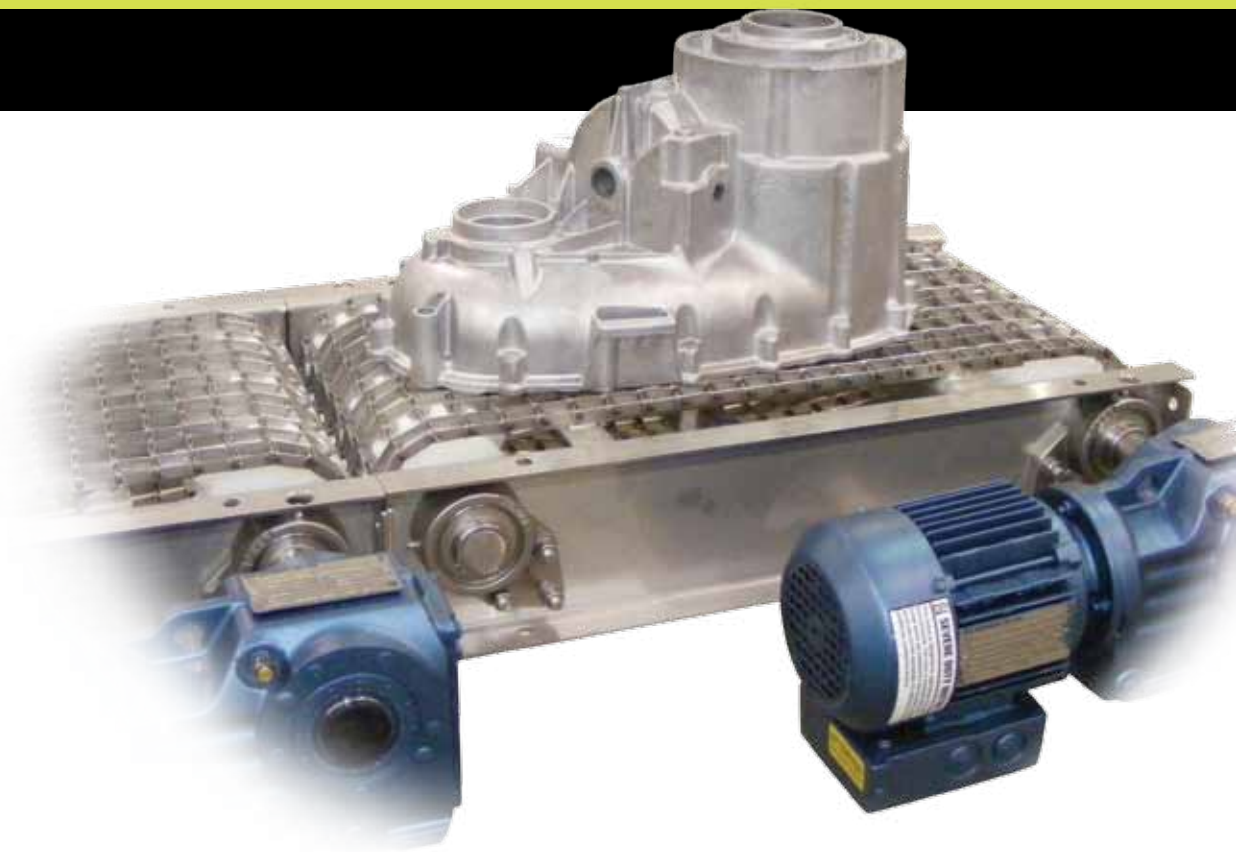

Staging Aluminum Castings

- Stainless Steel Metal Belt Conveyor
- Washdown Duty
- Open Style Construction
- High Temperature Construction

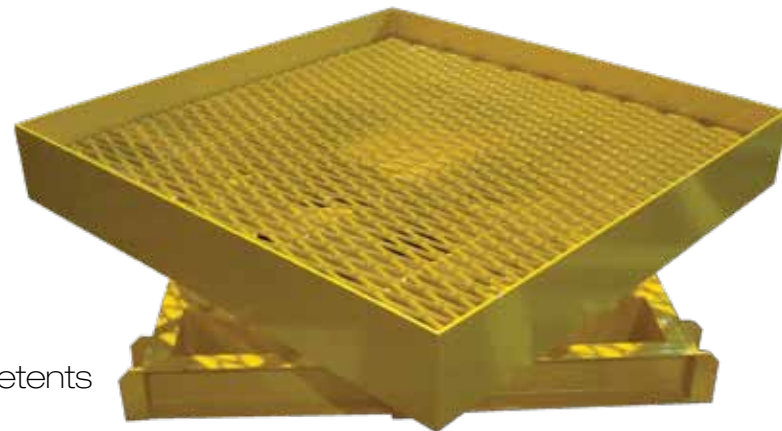

Sand Mold Handling

- Square Manual Turntable with Detents
- Expandable Metal Top



Cooling Line

A robot loads a mold onto a heavy duty infeed Chain Driven Live Roller Conveyor. The CDLR feeds the mold into a heavy duty, four post steel frame construction Reciprocating Vertical Conveyor (RVC) which transfers the mold to a dual tier cooling line.

Omni Metalcraft Corp.

Pivot Belt Conveyor

The Application:

Transporting sand molds in a foundry around tight corners and existing equipment while maintaining product orientation

The Need:

A manufacturer needed to transport sand molds in a harsh foundry environment. The conveyor needed to maneuver a tight corner around an existing machine and withstand the demands of the abusive environment.

The Solution:

Omni Metalcraft Corp. provided a Belt Conveyor on a Pivot Deck that transported the molds around the existing machine utilizing a small footprint. The robust Pivot Conveyor turned 90° while maintaining product orientation in the space allotted utilizing less space than a standard belt curve.

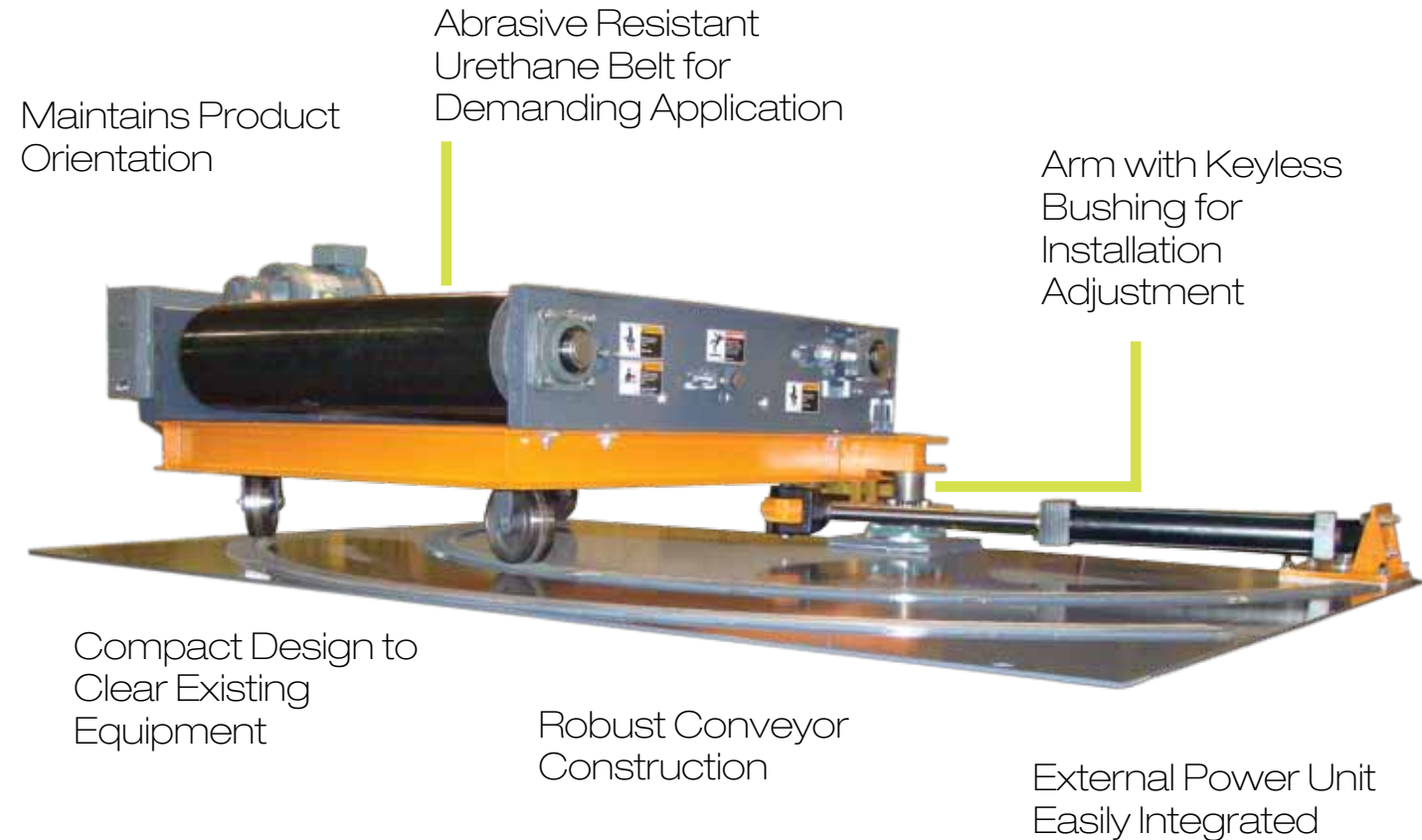



Positioning Crates for Robotic Glass Filling

- Modular Plastic Belt Conveyor on Tilters
- 60° Angled and Zoned Chain Driven Live Roller Conveyor
- Heavy Duty Flow Rail Guide



Stove Top Inspection Table

- Custom Motor Driven Roller Conveyor
- Urethane Bands for Glass Protection
- Coated Knobs for Ergonomic Assistance



Three Tier Glass Handling Storage MDR

A custom, three tier Motor Driven Roller Conveyor integrating two Reciprocating Vertical Conveyors creates three levels of buffering for a robot. Each layer is zoned for zero pressure accumulation and equipped with customer supplied specific glass handling photo eye sensors. The rollers are slave driven by urethane bands allowing for smooth transportation and a non-marring surface.

Changing Pallet Orientation within a Small Footprint

- Cross Bar Configuration Lift and Rotate
- Chain Driven Live Roller Conveyor



Pallet Transfer

- Chain Driven Live Roller Conveyor
- 90° Pneumatic Puller

30



Robotic Crate Loading

A Pack-Out Station for robotic crate loading consists of two lanes of zero pressure accumulation Chain Driven Live Roller Conveyor and a Crowder at the robot interface point. Empty crates are brought in and accumulated prior to being robotically filled. Post filling, the crates are again accumulated to be picked and unloaded with a fork truck.

Omni Metalcraft Corp.

Pick and Place Robotic Palletizer

The Application:

Pick and place robotic palletizer for variable height palletizing

The Need:

A Canadian postal service company needed to robotically palletize bundles of magazines. Three different pallets with unique footprints needed to be conveyed.

The Solution:

Omni Metalcraft Corp. provided an infeed three strand chain conveyor to receive empty pallets. A triple strand chain conveyor created better surface area accommodating all three styles of pallets to be conveyed. Pallets were then conveyed onto a Multi-Tier Scissor Lift with chain conveyor mounted to it. The lift lowered as the robot completed a layer. As the full pallet descends it is stretch wrapped and then conveyed onto a buffering section of chain conveyor allowing flexibility for the fork lift operator.

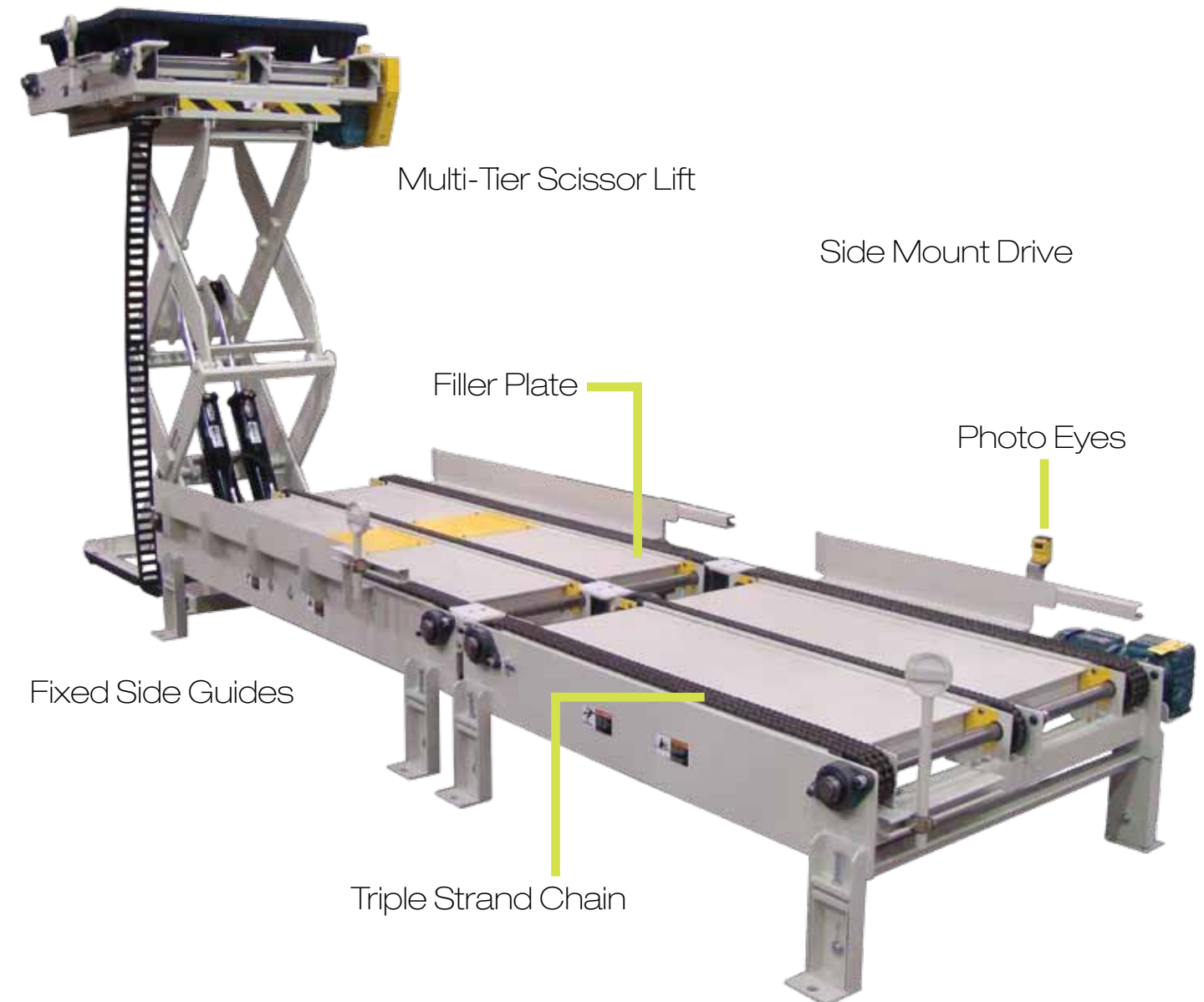

Multi-Tier Scissor Lift

Side Mount Drive

Filler Plate

Photo Eyes

Fixed Side Guides

Triple Strand Chain



Copper Sheet Transportation

- Chain Driven Live Roller Conveyor
- 6" Diameter Rollers
- Welded Spacing Disks for Crane Unloading

Discharging a Variety of Sheet Metal Stampings from a Stamping Machine

- Adjustable Rail Two Strand Chain Conveyor



Transferring Stacked Aluminum Sheets

A Flat Top Plastic Belt Conveyor transports bundled stacks of aluminum sheets to and from a 90° Level Lift Pop-Up CDLR Transfer with orange urethane coated rollers that were integrated within a 15 strand UHMW V-Belt conveyor. Tight transitions, coatings and specific belt materials were utilized to eliminate any marring or bending of products that were also heavy and abrasive by nature.



Multi-Level Inspection of Large Stainless Steel Components

- Hydraulic Tandem Carousel Lift
- Beveled Toe Guards
- Handrails
- 6-Post Structure

Upending 8,200 lb. Steel Castings

- Mechanical Chain Driven Upender
- Beveled Toe Guards
- Wood Lined Guides
- Heavy Duty Construction

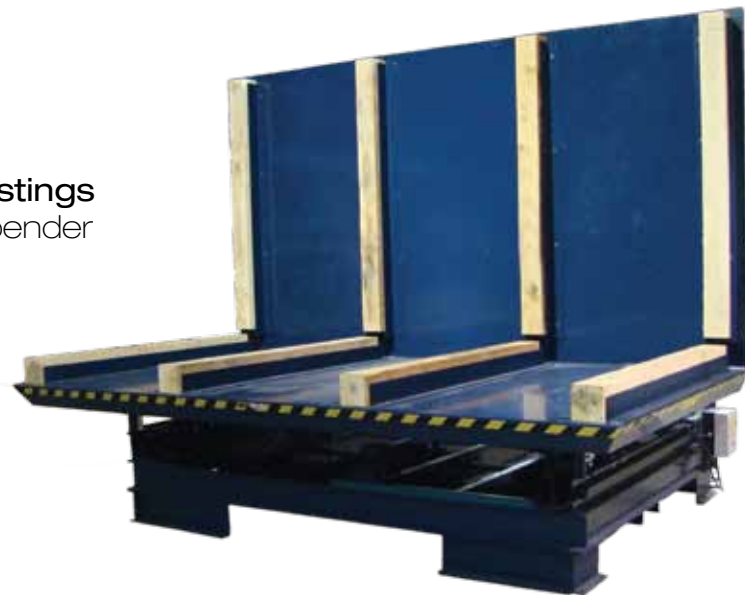

Handling 40' Long 8 Ton Sheets of Steel for Water Tank Manufacturing

- Heavy Duty Gravity Roller Conveyor
- Chain Driven Live Roller Conveyor
- Pop-Up Chain Transfers
- Six Strand Chain Conveyor
- Upender



Omni Metalcraft Corp.

Custom Saw Feeding Equipment

The Application:

Steel bar unloading and saw infeed

The Need:

A manufacturer of metal cutting saws needed a conveyor embedded into their unloading table that could receive singulated 20 foot long by 6 inch diameter steel bars from an unbundler.

The Solution:

Omni Metalcraft Corp. designed a custom saw feeding equipment solution consisting of a Chain Transfer with chain lugs and a Gravity Roller Infeed Conveyor. The Chain Transfer was designed to pneumatically pop up to create a horizontal carrying surface. The lugs would grab bars of steel and convey them to the embedded gravity roller conveyor. Once the bar reached the gravity conveyor, the end of the transfer would then tilt down to allow the bar to set onto the conveyor. The saw clamping head would automatically grab the bar and feed it to the cutting operation.

Gravity Roller Conveyor

3 Strand Chain Transfer

High Chain Lugs

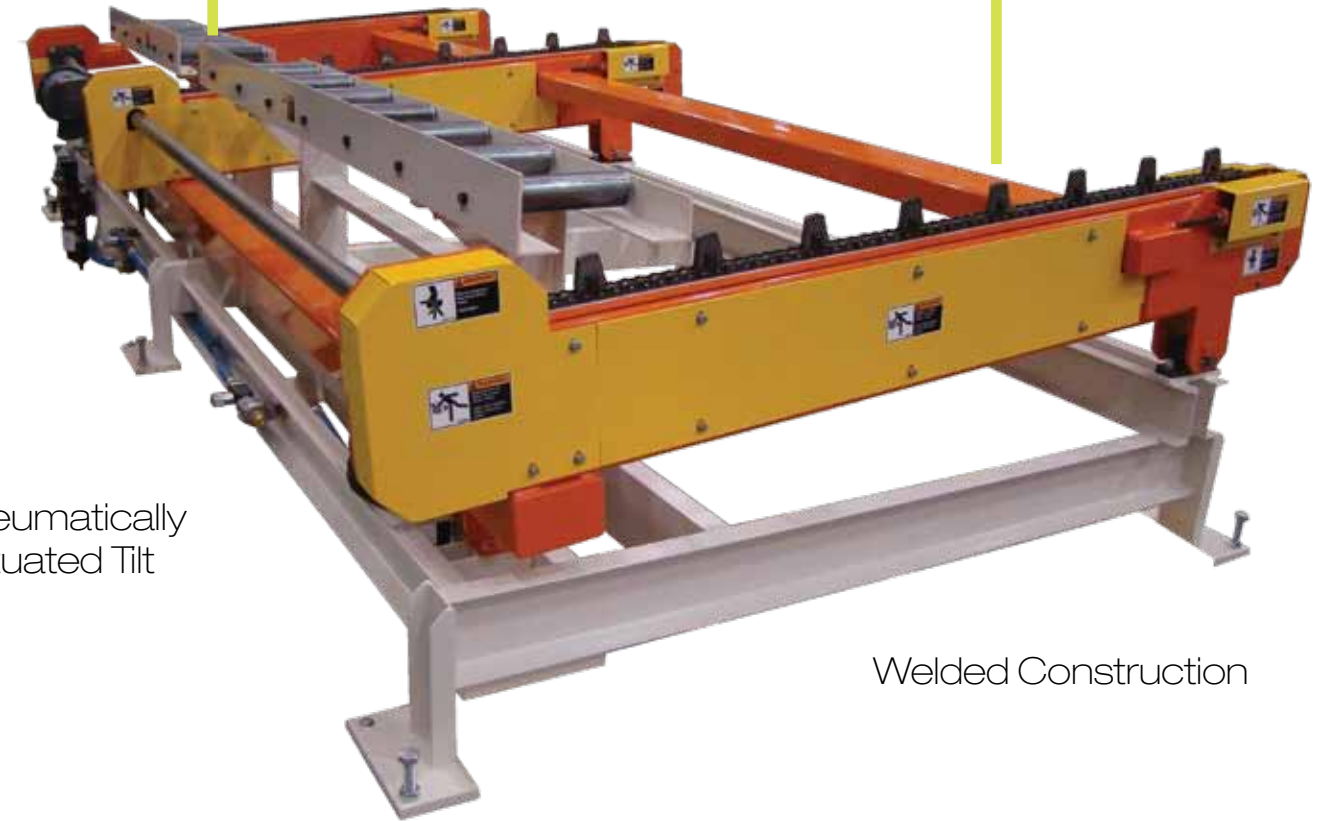

Pneumatically Actuated Tilt

Welded Construction

Custom Parameters

Lifting Textile Rolls Up and Into Shipment Racks

- Vertical Lift Arm Chain Conveyor



Repositioning a Paper Roll

- Upender
- Infeed and Discharge Chain Driven Live Roller Conveyor
- Powered Turntable
- Pneumatic Puller



Transporting Tube over a Walkway in a Cutting Operation

- Chain Driven Live Roller Conveyor
- Hydraulic Lift Gate
- Urethane Coated Concave Rollers



Roll Handling Upender

An Upender with trough Gravity Roller Infeed Conveyor and Chain Driven Live Roller Discharge Conveyor repositions large rolls of fabric onto a slip sheet for packaging. An operator would manually slide a roll of fabric onto the infeed trough and place a slip sheet on top of it. The upender would reposition the roll so the slip sheet would end up on the underside. The powered discharge conveyor would feed the roll onto a transfer car for further packaging.



Ergonomic Stove Assembly

- Hydraulic Scissor Lift
- Manual Beveled Turn Table
- Orange Urethane Coated Gravity Roller Conveyor
- Pneumatic Roller Brake
- Custom Transition Rollers



Sorting Boxes

- Passive Activated Roller Belt™
- Vertical Blade Stops



Cement Bag Take-Away System

- Heavy Duty Metal Belt Conveyor
- Bag Knock-Down Bars
- Inclined Roller Bed Belt Conveyor
- Impact Reduction Bar
- Straight Roller Bed Belt Conveyor



Changing Bag Orientation

- Belt Conveyor
- Adjustable Knock-Down Bar
- Slide Pan
- Turning Wheel



Feeding Steel Bars into a Saw Cut Off Operation

- Three Strand Metal Table Top Chain Conveyor
- Locating Cleats
- Pop-Up Chain Driven Live Roller Conveyor



Plastic Belt Bumper Assembly Line

- Flat Top Plastic Belt Conveyor
- Insert Nuts on Belt for Customer Supplied Fixtures



Case Handling Divert Line

- 30° Plastic Belt Infeed Curve
- Slaved Transfer Conveyor
- Manual Divert Arm
- 60° 24 Volt Flat Motor Driven Roller Conveyor Curve
- Decline Gravity Roller Conveyor with Manual Drop In Stop



Pallet Handling Conveyor with Transfers

- Zoned Chain Driven Live Roller Conveyor
- Cut Through Three Strand Chain Transfers
- Zinc Plated Rollers
- Side Load Fork Truck Deflectors
- Adjustable and Fixed End Stops



Tote Stacker

- Mast Style Electric Reciprocating Vertical Conveyor
- Four Strand Flat Top Plastic Belt
- Powered Turntable



Square Roller Settling Conveyor

- Stainless Steel Chain Driven Live Roller Conveyor
- Two Inch Square Rollers
- Adjustable Side Guides
- Corrosion Resistant

STANDARD OFFERING

Activated Roller Belt™ Conveyor



- Quickly rotates multiple package types using stationary or retractable bump turns
- Aligns packages quickly and positively for applications like print and apply
- Singulates and sorts multiple package sizes and types with few controls and drives

Belt Driven Live Roller Conveyor (BDLR)



- Transports or accumulates products of various shapes, sizes and weights
- Live rollers set high in a conveyor frame allowing for overhanging product applications
- Bed rollers are driven using a belt from the underside of the bed roller

Chain Transfers

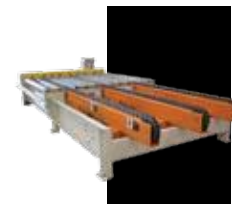

- Used to re-direct products 90° onto an adjacent conveyor line
- Ideal for transporting loaded pallets or products with a sturdy conveying surface
- Customizable to specific requirements with standard capacities up to 6,000 lbs.

Gravity and Power Rollers



- Available in sizes from 1" to 12" outside diameter
- Multiple bearing, axle assembly and accessory options customizable to many applications
- Gravity, grooved, sprocketed and taper rollers available
- Standard and nonstandard between frame widths available

Ball Transfer Tables



- Applied when the rotation of a product is desired
- When the transferring of a product between parallel lines is desired
- 360° of rotation
- Ball sizes and patterns customizable to suit the product

Chain Conveyor



- Used primarily for "wrong way" pallets or racks
- Structural tube steel rails are connected together by welded-on structural angle spreaders
- Chain is typically driven by an underhung center drive

Continuous and Reciprocating Vertical Conveyor



- Continuous flow of products between two levels
- Save valuable floor space
- Raise and lower conveyors with product
- Automatic loading or unloading provides uninterrupted product flow requiring no operator

Gravity Roller Conveyor



- Ideal for horizontal and gradual decline applications
- Multiple options of frame and roller configurations
- Designed to meet capacity requirements

Belt Conveyor



- Conveys products of various shapes and sizes
- Ideal for operations such as assembling, sorting, inspecting or transporting
- Many belt options available for specific applications

Chain Driven Live Roller Conveyor (CDLR)



- Ideal for transporting loaded pallets, tires, drums and more
- Roll to roll chains provide positive driving force to every roller
- Welded frames for ruggedness and durability

Extendable Belt Conveyor



- Conveys products of various shapes and sizes in or out of trailers
- Reduces labor costs by decreasing the load/unload time
- Extends for easy loading/unloading of trailers, containers and/or trucks

Gravity Skatwheel Conveyor



- Ideal for horizontal and gradual decline applications
- Wheel patterns and styles customizable to the application
- Possibility of multiple wheel patterns and styles
- Good tracking abilities due to the differential action of the wheels

STANDARD OFFERING

Lift and Rotate



- Ideal for changing product orientation without having to rotate the entire conveyor
- Ergonomic assistance for product reorientation
- Utilizes a smaller footprint compared to a turntable
- 360° rotation in various increments

Modular Plastic Belt Conveyor

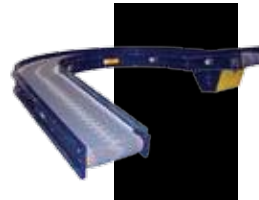

- Conveys products of various shapes and sizes
- Positively sprocket driven
- Multiple belts are available for many industries and applications

Roller Flight Conveyor



- Products are transported on rollers
- Used mainly for long runs of low pressure accumulation
- Consists of two strands of heavy duty chain equipped with rollers suspended between the chains

Stackers and Destackers



- Available in many configurations, with or without controls
- Utilizing infeed/exit conveyors
- Used to stack or destack pallets, racks or tires in an automated environment

Lineshaft Conveyor



- Energy efficient way to transport light weight, flat bottom products with the capability of minimal back pressure accumulation
- Modular conveyors and accessories allow for unlimited design configurations
- Quiet operation, easy maintenance and multiple conveyor components can be driven from a single drive

Modular Table Top Conveyor



- Conveys various sized bottles, packages, parts and boxes
- Ideal for applications requiring multiple curves and elevation changes
- Modular components allow for simple installation and unlimited design configurations

Scissor Lifts



- Capacities ranging from 500 to 100,000 lbs.
- Multiple travels and configurations
- Heavy duty steel construction
- Easily built to your specifications
- High cycle packages
- Offered in hydraulic, mechanical and pneumatic actuations
- Integrates well with all Omni conveyor

Tilters

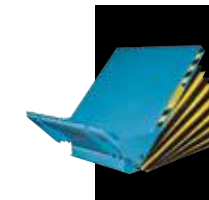

- Easily positions totes and baskets
- Tilts ranging from 30° to 60°
- Facilitates easy loading and unloading of totes and baskets
- Accordion skirting available
- Integrates with scissor lifts for additional height and functionality

Metal Belt Conveyor



- Used mainly in ovens or cooling lines
- Many configurations and styles available
- Can be manufactured in stainless steel for washdown or bakery applications

Power Belt Curve



- Capability to handle products of various shapes and sizes with belt widths from 6" to 102"
- Maintains product orientation throughout the turn
- Easily integrated into existing conveyor lines and lift tables

Slat Conveyor



- Ideal for transporting abrasive, oily and/or warm or hot products
- Special fixtures can be attached directly to the slats to perform various assembly operations
- Pallets can be easily loaded or unloaded from the sides with a fork truck

Transfer Car



- Powered or Manual Push Cars provide linear product transportation
- Inline and perpendicular loading and unloading can be accomplished
- Standard capacities offered up to 10,000 lbs. and specials available for higher load requirements

Turntables



- Provide directional and product orientation change in your conveyor line
- Manual or Powered Turntables rotate to the desired angle required for your application

24V Flat Motor Driven Roller Conveyor (FMDR)



- Ideal for energy efficient, low maintenance and easy installation zero pressure accumulation
- No gear box allows for a quiet, long lasting, low maintenance conveyor solution
- Speeds from 30 to 200 FPM

Accessories

Accordion Skirting
Adjustable End Stops
Angle End Stops
Bead Rail
Brake Rollers
Bump Turn
Ceiling Hangers
Coatings
Crowder Device

Escapements
External Power Units
Fixed Channel End Stops
Fork Truck End Stops
Leg Supports
Loose Rollers
Mobility Package
Pop Up Stops
Pushers

Replacement Bearings
Roller Brake
Roller Flanges
Shot Guard
Side Guides
Spring Gates
T-Handle Portability
Transition Rollers or Plates
Ultrax Sleeves

Upenders

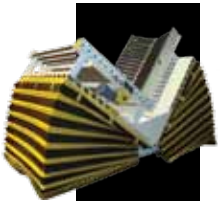

- Ideal for positioning rolls and coils
- Conveyor easily mounted to platform
- Standard capacities up to 8,000 lbs.
- Multiple power unit options available
- Typical in steel or paper industries

24V Motor Driven Roller Conveyor (MDR)



- Ideal for smooth and quiet operation zero pressure accumulation
- Less vertical frame height required than other competing conveyor technologies
- Multiple controls options available
- Speeds from 20 to 200 FPM

The Omni Paint Colors

Private Labeling

- Equipment painted with your specified color
- Your tags or labels affixed to the custom equipment
- Your part numbers on documentation
- Your shipping paperwork
- Equipment blind shipped directly to your customer

Colors illustrated below may vary slightly from actual paint colors.



Omni Standard Blue
110549



Gloss Black
111233
RAL-9005



Safety Blue
110552
RAL-5019



Machinery Grey
110652
RAL-7011



Safety Orange
110559
RAL-2010



Safety Yellow
110554
RAL-1023



Light Ivory
115174
RAL-1015



Gloss White
111232
RAL-9003



Conveyor Green
115886



Dark Green
110555



Vista Green
110556
RAL-6011

MANY OTHER
COLORS AVAILABLE
AT NO ADDITIONAL
CHARGE

Your good name, our quality equipment

Zero Pressure CDLR



- An application specific version of CDLR conveyor
- ZP CDLR is a chain driven roller conveyor divided into individual, pneumatic clutch driven zones controlled by air logic
- Many control options available

Stainless Steel Option Available



- Sanitary and washdown duty solutions
- Most of our products are available in stainless steel construction
- We welcome your custom and build to order fabrication needs

Omni Metalcraft Corp.

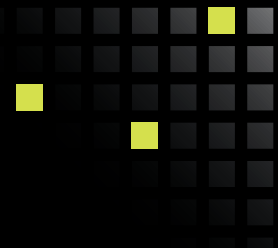

Standard Offering:

24 Volt DC Conveyor – Flat Motor and Motorized Roller Conveyor

Activated Roller Belt Conveyor

Belt Conveyor

Belt Driven Live Roller Conveyor

Chain Conveyor

Chain Driven Live Roller Conveyor

Chain Transfers

CVCs and RVCs

Gravity Conveyors

Lift and Rotate

Lineshaft Conveyor

Metal Belt Conveyor

Modular Table Top Conveyor

Overhead Monorail Conveyor

Plastic Belt Conveyor

Replacement Rollers

Scissor Lifts

Slat Conveyor

Stackers and Destackers

Tilters and Upenders

Transfer Cars

Turntables



P.O. Box 352 ■ Alpena, Michigan 49707
Phone 989.358.7000
Fax 989.358.7020
info@omni.com
www.omni.com