

**Oligarchic Primacy for  
World Government**

***The Poor-Man's***

***Guide To***

***Modernity***

**Zahir Ebrahim**



*The Poor-Man's*  
*Guide To*  
*Modernity*

Fifth Edition

---

# The Poor-Man's Guide to Modernity

## Copyright Notice

Copyright © 2011, 2012 by Zahir Ebrahim.

All rights reserved.

**For non-profit Gratis Distribution Only under *Fair-Use* Doctrine**

Words: 272856 | Pages: 764 | A4 | Printed on Sep 9, 2012

Published by Project Humanbeingsfirst™

Fifth Edition

DOWNLOAD PDF:

<http://tinyurl.com/poor-mans-guide-to-modernity5a>

<http://humanbeingsfirst.files.wordpress.com/2012/09/the-poor-mans-guide-to-modernity-5a.pdf>

Copyright © Zahir Ebrahim. Full permission to copy, repost, and reprint, in its entirety, unmodified and unedited, for any purpose, in any reproduction medium, granted, provided the PDF URL above and this copyright notice are also reproduced verbatim as part of this license, and not doing so may be subject to copyright license violation infringement claims pursuant to remedies noted at <http://www.copyright.gov/title17/92chap5.html>. All images, quotations and excerpts are based on non-profit “fair-use” for personal education and research in the public interest consistent with the understanding of laws noted at <http://www4.law.cornell.edu/uscode/17/107.html>. Partial replication or dissemination of this book with any page omitted is an infringement. Any use beyond non-profit fair-use requires written consent from all copyright holders. Verbatim reproduction license and non-profit fair-use of copyrighted material noted at <http://Humanbeingsfirst.org#Copyright>.

This book is typeset in StarOffice and OpenOffice.

---



# **Modernity Simplified to the level of a 'poor-man'**

**(i.e., one with limited ability,  
or time, or even inclination, to  
carefully read, reflect, and  
reason about the period one  
lives in)**

this page intentionally left blank

# Oligarchic Primacy for One-World Government and Its Global Imperatives

“Some even believe we are part of a secret cabal working against the best interests of the United States, characterizing my family and me as 'internationalists' and of conspiring with others around the world to build a more integrated global political and economic structure – one world, if you will. **If that's the charge, I stand guilty, and I am proud of it.**”

David Rockefeller,  
*Memoirs*, 2002, pg. 405  
Proud Internationalist, Chairman  
The Council on Foreign Relations,  
Chase bank

this page intentionally left blank

“In short, the ‘house of world order’ will have to be built from the bottom up, rather than from the top down. It will look like a great ‘booming, buzzing confusion’ to use William James’ famous description of reality, **but an end run around national sovereignty, eroding it piece by piece will accomplish much more than the old-fashioned frontal assault.**

Of course, for political as well as administrative reasons, some of these specialized arrangements should be brought into an appropriate relationship with the central institutions of the U.N. system, but the main thing is that the essential functions be performed.”

*The Hard Road To World Order,*  
The Council on Foreign Relations,  
Foreign Affairs April 1974 issue,  
pages 558-559

this page intentionally left blank

“We are at present working discreetly with all our might to wrest this mysterious force called sovereignty out of the clutches of the local nation states of the world. **All the time we are denying with our lips what we are doing with our hands,** because to impugn the sovereignty of the local nation states of the world is still a heresy for which a statesman or publicist can perhaps not quite be burned at the stake but certainly be ostracized or discredited.”

Arnold Toynbee, *The Trend of International Affairs Since the War*, International Affairs, November 1931, page 809

this page intentionally left blank



“I have never believed that there is a secret United Nations plot to take over the US. I have never seen black helicopters hovering in the sky above Montana. But, for the first time in my life, **I think the formation of some sort of world government is plausible.**”

A “world government” would involve much more than co-operation between nations. It would be an entity with state-like characteristics, backed by a body of laws. The European Union has already set up a continental government for 27 countries, which could be a model. The EU has a supreme court, a currency, thousands of pages of law, a large civil service and the ability to deploy military force. So could the European model go global?

There are three reasons for thinking that it might. First, it is increasingly clear that the most difficult issues facing national governments are international in nature: **there is global warming, a global financial crisis and a “global war on terror”.**”

*And now for a world government,*  
Financial Times, Dec. 8, 2008

this page intentionally left blank

“We are living through exceptionally difficult times. Financial crisis and its dramatic impact on employment and budgets, the climate crisis which threatens our very survival --- a period of anxiety, uncertainty, and lack of confidence. Yet these problems can be overcome, by a joint effort, in and between our countries. **2009 is also the first year of Global Governance with the establishment of the G-20 in the middle of financial crisis.** The climate conference in Copenhagen is another step towards the Global Management of our Planet. Our mission, our presidency is one of hope, supported by acts, and by deeds.”

Herman Van Rompuy,  
EU Council President,  
press conference Nov 19, 2009

this page intentionally left blank

***A Gestalt Shift in***  
**PERSPECTIVE is Required**  
**to Understand Primacy**



this page intentionally left blank

“Aspire to be like Mt. Fuji, with such a broad and solid foundation that the strongest earthquake cannot move you, and so tall that the greatest enterprises of common men seem insignificant from your lofty perspective. With your mind as high as Mt. Fuji you can see all things clearly. And you can see all the forces that shape events; not just the things happening near to you.”

Miyamoto Musashi

(Quoted in *Political Ponerology* by  
Andrew M. Lobaczewski, Red Pill Press)

this page intentionally left blank



## About this Book

This edition of *The Poor-Man's Guide to Modernity* is for non-profit personal educational use only and is Gratis. It is printed in limited quantity at the author's own expense to present to the profoundly *innocent of knowledge* among our national and international leadership for their self-education.

It is the author's fleeting hope that the present day Machiavellian attack upon nation-states and the systematic erosion of national sovereignty may still be interdicted by a modicum of realization of the real state of villainy: a despotic world government in the making.

Hence this attempt to gift its deconstruction to those few who might care to know before it is too late.

Copyright clearance has not been obtained for some of the images and excerpts reproduced in this book. Please note that the book is gratis under the fair-use doctrine for non-profit personal educational use. See Copyright Notice.

This book is also available as a PDF. It contains web-browsable links to all cited references. URL: <http://tinyurl.com/poor-mans-guide-to-modernity-5>

## About its Author

---

Zahir Ebrahim, an ordinary researcher and writer on contemporary matters, grew up in Pakistan, studied EECS at UET, MIT, and Stanford, engineered for a while in high-tech Silicon Valley (<http://tinyurl.com/zahir-patents>), and retired early to pursue other responsible interests. His maiden 2003 book of protest, written in the aftermath of 9/11, was rejected by countless publishers and can be read on the web at <http://PrisonersoftheCave.org>. His prolific writings may be read at <http://Humanbeingsfirst.org>. His extended bio at: <http://zahirebrahim.wordpress.com/bio/>

---

**To**

**Those Who Care**

this page intentionally left blank

# Table of Contents

Chapter-1	Introduction Modernity Simplified	29
Chapter-2	The Mighty Wurlitzer	38
Chapter-3	World Order is World Government	94
Chapter-4	Arc of Crisis	106
Chapter-5	Conspiracy Theory	115
Chapter 6	The Fable of the Bees	131
Chapter 7	Medicine in the Service of Empire	148
Chapter-8	Science in the Service of Empire	181
Chapter-9	Islam in the Service of Empire	207
Chapter-10	Muslim Stooges in the Service of Empire	238
Chapter-11	FBI-Militancy Presentation and Empire	249
Chapter-12	Obedience Training and Empire	259
Chapter-13	White Man's Burden	301
Chapter-14	The Oligarchs: The invisible House of Rothschild	323
Chapter 15	The Omnipotent Rothschilds : Where is the Evidence	339
Chapter-16	Redemption	355
Chapter-17	The Noble Path: Denying to Caesar what is not Caesar's	368
Chapter-18	The Ignoble Path: Long Road To Secular Humanism	373
Chapter-19	Not Fooled Again: The Alien Invasion	395

Chapter-20	Not Fooled Again: War on Terror Against Insurgents	423
Chapter-21	Not Fooled Again: Financial Terrorism	442
Chapter-22	Not Fooled Again: Reformers pitching Gold Standard	486
Chapter-23	Not Fooled Again: World Bank pitching Gold Standard	504
Chapter-24	Not Fooled Again: Red Herrings in Monetary Reform	518
Chapter-25	Not Fooled Again: The Deception of Zion	539
Chapter-26	Not Fooled Again: Dissecting the Dissent on Zion	549
Chapter-27	Not Fooled Again: Getting off the Treadmill of Zion	570
Chapter-28	Not Fooled Again: Dissecting the Intellectual Nigger	601
Chapter-29	Not Fooled Again: Dissecting the Massa's Dissent	628
Chapter-30	Not Fooled Again: The Masters of Discourse	634
Chapter-31	Not Fooled Again: Safeguarding Our Moralsense	641
Chapter-32	Case Study: Surviving the Grand Chessboard	649
Chapter-33	Case Study: Why is the Holy Qur'an so easy to Hijack?	697
	Recommended Reading	755
	Acknowledgment	757
	Sources and Credits	759



***“you are a completely stupid fool, a disgrace  
to humanity”***

Paul Craig Roberts, United States  
Former Assistant Secretary of the  
Treasury, anointing Zahir Ebrahim,  
Dec 06, 2008

this page intentionally left blank



# **The Zahir Ebrahim Reader**

**To confront, or be co-opted?**

this page intentionally left blank

## Chapter 1 Introduction

### Modernity Simplified

What is all this verbiage by Project Humanbeingsfirst™ really all about? Is there a reductionist and simplified explanation at the level of a 'poor-man'?

Yes. In the simplest terms: 'Might defines right'.

This leads to "*Hegemony is as old as mankind*".

That in turn leads to the following psychological pathocracy – some call it empire:

- If we don't have real enemies then we have to create or imagine some, and yell '**we are being attacked**' in order to, principally:
  - a) justify one's hegemonic barbarianism upon others; and
  - b) motivate an unwilling plebeian peoples into sacrificing for the conquests of the oligarchic elite.

Euphemistically, today as the winning empire, this is called "*imperial mobilization*".

Grotesquely, for previously defeated empires, it is called "*quest for Lebensraum*".

**That's all there is to it.**

All which follows is only in further examination of how that is accomplished under the veneer of "democracy", because, in the absence of such deception, "*democracy is inimical to imperial mobilization*". That quoted statement was made by Zbigniew Brzezinski in his 1997 book: *The Grand Chessboard – American Primacy and Its Geostrategic Imperatives*.

This revived "*quest for Lebensraum*" (German word for seeking more living space as an imperative), ahem, "*imperial mobilization*" of the ruling oligarchy, the *ubermensch* (German word for superior, above all others), just happens to be the age-old quest for one-world government in disguise.

It is to be achieved piece-meal, incrementally, one fait accompli at a time, one fabricated

crisis at a time, one manufactured war at a time, one real or imagined pestilence at a time, one catastrophe at a time.

The psychological pathocracy of modern Machiavellian statecraft – commandeered entirely by sociopaths who seem to uncannily just rise above the rest of the populations to always gather at the helm of power from generation to generation in the same tribes and families – requires continuous threats, crises, and uncertainty, in order to corral the democratic instincts of the modern public into accepting the unpleasant totalitarian agendas of the ruling oligarchy. *“What is inconceivable in normal times is possible in revolutionary times.”*

The solution presented for addressing each uncertainty is the next baby-step towards centralized global control of all humanity in a global empire of the financial oligarchy.

The modus operandi is to deliberately create problems and then offer only those solutions which result in bigger government, incrementally leading to one world government. *“Create conditions so frightful at home and abroad that the abandonment of personal liberties and national sovereignty will appear as a reasonable price for a return to domestic tranquility and world peace.”*

That world order, the new world order, as we can already perceive even in its initial stages, is governed with moral relativism wherein, legal opinions as those proclaimed by a United States Justice before its Supreme Court, prevail:

'Nothing is more certain in modern society than the principle that there are no absolutes, that a name, a phrases, a standard has meaning only when associated with the considerations which give birth to nomenclature. To those who would paralyze our Government in the face of impending threat by encasing it in a semantic strait-jacket, we must reply that all concepts are relative.'

That verdict from the legal mind of the highest court of the sole superpower is based on the reality of law quoted in the Protocols:

'In the beginnings of the structure of society, they [the beasts of prey who are called men] were subjected to brutal and blind force; after words - to Law, which is the same force, only disguised. I draw the conclusion that by the law of nature right lies in force;'

The term 'oligarchic elite' refers to people who are several notches above – and more hidden from public view in their enormous wealth and their secretive exercise of 'social

engineering' – than what is typically understood by the term 'ruling elite', or simply the 'elite'. The latter often refers to the generally affluent 1% of any society, the super-rich, more interested in being rich and running corporations than in 'social engineering' agendas, and many among them can be found in the Forbes' richest people listing. These super-rich, and how they hide their massive wealth, pay little or no income and inheritance tax, while still accumulating and controlling their purses across generations, can be read about in Ferdinand Lundberg's 1968 classic *The Rich and the Super-Rich*.

But one will never see a Rothschild, or David Rockefeller listed in Forbes billionaires list. That's perhaps because they are trillionaires, with all their massive wealth legally hidden behind private tax-exempt foundations, multiple trusts, and in their opaque ownership of private and family-owned banks, which in turn own many a private central bank which issue the currency of developed nations as national debt secured by public taxation! These ultra-rich can muster vast sums of private monies for 'social engineering', and administer untold funds through their tax-exempt foundations and think-tanks. They are the proverbial 'king makers' who craft 'errand boys' to do their policy bidding in the executive and legislative offices.

**To unmask them all before fait accompli is Project Humanbeingsfirst's imperative – i.e., before it's all a done deal.**

Ex post facto, narrators and historians can rehearse the deceptions and its scholarly disentanglement in the comforts of one-world government. And of course laugh their way to fame and fortune just as today's narrators call it erudite scholarship to openly rehearse the settlement of the Americas and the genocide of millions of its indigenous peoples.

Even the sixth graders in elementary schools today throughout the North American continent learn of the choice between the gattling-gun (force) and the small-pox laden bacteriological warfare (treachery) magnanimously offered to the indigenous natives, without batting their own eye-lids or offering a few tears in compensation.

Detachment from history and from previous generations who inflict crimes upon the 'lesser humanity', the '*untermenschen*' (German word for 'lesser peoples'), evidently washes away both the evidence and the guilt. But not the bold, sometimes truthful, and often sanitized narratives which become openly public, and their narrators, lauded scholars and touted academics.

In the transition to the modernity of today, the euphemisms have become considerably refined with the march of Western civilization. It is now the more egalitarian choice between

“democracy” (euphemism for force) and “revolution” (euphemism for treachery) under the dialectical *“either you are with us, or you are with the terrorists”*, that is being magnanimously offered to the indigenous natives along the *“arc of crisis”* in the *“Global Zone of Percolating Violence”*. The objectives unfortunately remain the same as in antiquity – by hook or by crook usurping what does not belong to one. The two quoted descriptive phrases are once again Zbigniew Brzezinski's, respectively from a January 15, 1979 Time magazine article titled 'IRAN: The Crescent of Crisis', and from Brzezinski's already mentioned 1997 book.

Thusly, in the case of our modernity as well, perhaps only our progeny might also bear truthful witness to the crimes and sham of intellectualism of their hypocritical ancestors – scholars, leaders, military-men, holy-men, politicians, teachers, news-bearers, both in the West and the East, on the left and the right – who hath proclaimed to stand for truth, but who only aided and abetted vile hegemonic power with their own convolutions and confabulations. Modernity du jour is entirely unwilling to unravel their confusing and deceptive narratives.

We must wait a 100 years, or perhaps only 20, before anyone who is a somebody will again truthfully proclaim how new 'smallpox laden blankets' were used to fashion one-world government. Before then, it is all to be dismissed as 'conspiracy theory'.

This is why, as had been self-servingly predicted by the Council on Foreign Relations in 1974:

**'... it will look like a great 'booming, buzzing confusion' to use William James' famous description of reality, but an end run around national sovereignty, eroding it piece by piece will accomplish much more than the old-fashioned frontal assault.'**

The myriad manufactured crises which afflict humanity today – from perpetual 'War on Terror' to perpetual Counter Insurgency to sudden Revolutions to Global Financial Crisis to Global Pandemics to Global Warming, perhaps even Global Alien Landings/Sightings and/or other Intergalactic Catastrophes – are the successive Hegelian mind-fcks, ahem, the “acts” and “deeds”, of making current affairs *“look like a great 'booming, buzzing confusion”*. Designed to wear-out the sanity of mankind by plunging them repeatedly into a state of panic, war weariness, and disillusionment, each new *'booming, buzzing confusion'* generates the new enabling pretext for inching the world one baby step closer towards the Global Governance of the Planet.

**That, in the simplest of terms, is Modernity Simplified to the level of a 'poor-man' (i.e., one with limited ability, or time, or even inclination, to carefully read, reflect, and reason about the period one lives in).**

The essays in this book are but a sensible glimpse into that twisted modernity based on commonsensical observations and assiduous study of facts and events as an unwilling participant being made to live them day by day, rather than as a historian who might surely discover more accurate facts and linkages in the future, but who can't comprehend the atmosphere and the life which only participants can feel and live. Thus it is, in some sense, a “contemporary history”, probably a non-sequitur for seasoned historians for whom contemporary is not history, and history is not contemporary. As Carroll Quigley noted in his Preface to *Tragedy and Hope*, a revealing book from which I quote at length in some of my essays, “*sensible historians usually refrain from writing accounts of very recent events because they realize that the source material for such events, especially the indispensable official documents, are not available and that, even with the documentation which is available, it is very difficult for anyone to obtain the necessary perspective on events of one's own mature life.*”

Unfortunately, the official history is almost always written by the victors and their *Mighty Wurlitzers*, constituting the source material for subsequent generations of historians, academics, and also propagandists. This lauded history, while enjoying the advantage of time and official documents, has already sanitized away much of the grotesque reality, the often hidden forces and motivations driving events and masking the linkages among them, leaving its erudite narrators to win lofty accolades as their scholarly contribution to human knowledge when absolutely nothing can be done to rectify any matter.

But for “contemporary history”, despite its closeness in time to rapidly breaking and terrifying events of international import, and therefore, by necessity, “*any such formulation inescapably contains a germ of falsehood — and hence must be tentative — the attempt represents an advance toward at least a partial understanding*” when something can surely be done to interdict its fait accompli. That quote is from Zbigniew Brzezinski's *Between Two Ages*, another revealing book which hammers away at modernity arguing its villainy inescapable: “*Human life is reduced to real suffering, to hell, only when two ages, two cultures and religions overlap. . . . There are times when a whole generation is caught in this way between two ages, two modes of life, with the consequence that it loses all power to understand itself and has no standard, no security, no simple acquiescence.*”

I obviously don't accept that latter formulation or I wouldn't be laboring as I am. Contrary to Zbigniew Brzezinski's erudite prose which underlies the many compositions of the *Mighty*

Wurlitzer, as the generation caught *Between Two Ages* on *The Grand Chessboard*, we, the “untermensch” bearers of “*Human life*”, have neither lost the power to “*understand*”, nor lost the power to overturn the coercive “*simple acquiescence*” to artificially induced transition period of “*real suffering*”. That understanding, and overturning, is the *raison d'être* for this book.

This approach to modernity however, to examining it as “contemporary history” so that something can be done before hard facts and new realities are irreversibly established on the ground, is not my unique discovery. It is shameful that for over 200 years, the rebel and the savant alike, have been warning mankind of the curse of world government clandestinely in the making. In our generation we are precariously perched on its outer rim and rapidly closing in. In fact, the figurehead EU Council President, Herman Van Rompuy, on November 19, 2009 openly admitted in his first press conference in Brussels after being appointed president, that finally, 2009 was “*the first year of Global Governance*”. To me, from my plebeian perch on Mt. Fuji, it looks like a done deal, unless more people of sturdy mental constitution and moral fibre become aware of the villainous machinations behind this modernity and feel less inclined to 'United We Stand' with it. That is the purpose of this book.

A recommended reading list is at the end for those inclined to seek independent evidence of these machinations behind our modernity. It is all in plain sight! Only its courageous reporters today, as in the past, are calculatingly dismissed as “malcontent”, “conspiracy theorist”, “kook”, “mad”, “anti-semitic”, suffering from “*emotional or mental illness*”, an “*oppositional defiant disorder*” exhibiting a pattern of “*negativistic, defiant, disobedient and hostile behavior toward authority figures*” requiring psychiatric care and confinement in state hospitality center. Failing that, of course a “terrorist”!

A few thoughts on the extraordinary length of the 5<sup>th</sup> edition of this book, more than a quarter of million words, is in order. Brevity may be the soul of wit, but as Aldous Huxley aptly captured it in his 1958 Foreword to *Brave New World Revisited*, “***[t]he soul of wit may become the very body of untruth. However elegant and memorable, brevity can never, in the nature of things, do justice to all the facts of a complex situation.***” It especially cannot do adequate justice to the complex facts and hidden motivations of matters impelling current affairs, political science and history. These come wrapped in layers of deception of both, the “*history's actors*” who enact it, and the narrow self-interests of the narrators and historians who bring it to the public. Both are subject to the orchestration of the Mighty Wurlitzer. Whereas, excessive brevity requires simplifications, which in turn necessitates omissions. And omissions become the very soul of distortion and half-truths instead of bringing forensic clarity in this sea of Machiavellian lies, half-truths,



and obfuscation.

To ensure that simplistic and pat formulations do not mask the uber sophisticated psychological, political, financial, scientific, and military methods with which modernity is being Machiavellianly choreographed to extract freedom from both the consciousness as well as the existence of the guileless herds of humanity, sufficient elaboration is essential.

But how much is too much? Again, as Aldous Huxley examined the matter: ***“But life is short and information endless: nobody has time for everything. In practice we are generally forced to choose between an unduly brief exposition and no exposition at all. Abbreviation is a necessary evil and the abbreviator's business is to make the best of a job which, though intrinsically bad, is still better than nothing. He must learn to simplify, but not to the point of falsification. He must learn to concentrate upon the essentials of a situation, but without ignoring too many of reality's qualifying side issues. In this way he may be able to tell, not indeed the whole truth (for the whole truth about almost any important subject is incompatible with brevity), but considerably more than the dangerous quarter-truths and half-truths which have always been the current coin of thought.”***

Consequently, the one accusation which continues to stand against Project Humanbeingsfirst is its unwillingness to err on the side of too much brevity, too much abbreviation, while continuing to bring as cogent an analysis with full substantiation of evidence in as simple a form as is practical! In striving to tell the whole truth to the best of its author's capacity about every matter it touches, considerably more words than many individuals have time for have been penned in its few short years and are available on its website. For those challenged by time or inclination to imbibe such high potency intellectual vitamins to their fullest absorption, which evidently is upwards of 90% of the public in every nation calculatingly weaned on 15-second attention spans to ensure that they remain engaged between *bread and circuses* only, a minimalist expansion has been cherry-picked in ***The Poor-Man's Guide to Modernity***. That minimalism has still exceeded 700 pages in this A4 size Ebook 5<sup>th</sup> edition. It comprises 33 chapters (including this Introduction) on several vastly different topics plaguing modernity to demonstrate the singular unity of the common purpose behind their dysfunction: **the Oligarchic Primacy for World Government**.

It is hoped that this humble compilation will tickle the readers' angst sufficiently to want to pursue due diligence on their own for the sake of their ownselves.

Empiricism betrays however, that even whole encyclopedic knowledge does not

automatically lead to a change in behavior or mind-set. Only the courage of one's convictions does. You can read books all day long, listen to endless hours of inspiring talks and lectures on the internet with rapt attention, seek wise counsel from your chieftains and pontiffs, and it will not change your behavior one bit. However, the tickling of self-preservation fears will almost always instinctually lead to an immediate change in behavior! Unless of course one is too vested in enjoying one's servitude. Like the brilliant fellow in Chapter 6, *The Fable of the Bees*, who clearly only lacks the courage of his own convictions, and not knowledge nor brain-power.

Nevertheless, I hope that the gestalt shift in perspective which ***The Poor-Man's Guide to Modernity*** will induce in the more alert of mind, body, and spirit, will help them perceive the world from the predatory eyes of the tom cat pictured in the book's opening pages. You are the next meal in the fishbowl! My very [first piece of public writing in April 2003](#) observed that primacy instinct of the sociopathic predator to be the obvious fact of the matter. This [job advertisement in December 2011 by the US Military](#) further validates it. Nothing ever alters the tom cat's predatory instincts just because its prey refuses to recognize it. The predator is always waiting, watching, scheming, conniving.... before pouncing – the inveterate “hectoring hegemon”! See the unusual book (for which its author states that Zbigniew Brzezinski tried to suppress its publication) in order to understand the beguiling behavior of this sociopathic predator of modernity: *Political Ponerology: A Science on The Nature of Evil adjusted for Political Purposes* by Andrew M. Lobaczewski ( <http://ponerology.com> ). And today, as is deconstructed in the many essays that follow, it's done with the most devilishly cunning Hegelian Dialectics and psychological warfare that simply run circles around the prey, alternately shocking and exhausting it into accepting what's planned for it. The wily predator cornering its prey has shrewdly anticipated all its typical behavior patterns and is therefore trivially able to preempt it:

“There will be no day of days then when a new world order comes into being. Step by step and here and there it will arrive, and even as it comes into being it will develop fresh perspectives, discover unsuspected problems and go on to new adventures. No man, no group of men, will ever be singled out as its father or founder. For its maker will be not this man nor that man nor any man but Man, that being who is in some measure in every one of us. World order will be, like science, like most inventions, a social product, an innumerable number of personalities will have lived fine lives, pouring their best into the collective achievement. ...

Nor does it alter the fact that even when the struggle seems to be drifting definitely towards a world social democracy, there may still be very great

delays and disappointments before it becomes an efficient and beneficent world system. Countless people, from maharajas to millionaires and from pukkha sahibs to pretty ladies, will hate the new world order, be rendered unhappy by the frustration of their passions and ambitions through its advent and will die protesting against it. **When we attempt to estimate its promise we have to bear in mind the distress of a generation or so of malcontents, many of them quite gallant and graceful-looking people.**"  
(New World Order – H. G. Wells, 1940, Ch. 12, WORLD ORDER IN BEING)

The only escape from its death-jaws is for the victims to collectively, in large numbers, and atypically, change their own behavior pattern from what's already been anticipated – from abject indifference and enjoying their servitude to sagacious preemptive self-defense under mutually beneficial full spectrum alliances – BEFORE it is fait accompli.

This can only be accomplished at national levels with brave nations unwilling to accept the primacy of the internationalist sociopaths, breaking through the stifling web of international controls already inflicted upon them, and coordinating their resistance effectively under uncompromisingly strong national leadership, to survive the Grand Chessboard.

Thank you for daring to read further.

Zahir Ebrahim,

Islamabad, Pakistan.

August 2012.

**Short URL Introduction:** <http://tinyurl.com/poor-mans-guide-to-modernity>

**Source URL Introduction:** <http://print-humanbeingsfirst.blogspot.com/2011/06/poor-mans-guide-to-modernity.html>

## Chapter 2 The Mighty Wurlitzer

# Architecture of Modern Propaganda for Psychological Warfare

Edward Bernays, the nephew of Sigmund Freud, began his seminal 1928 book simply titled *Propaganda*, with these ominous words:

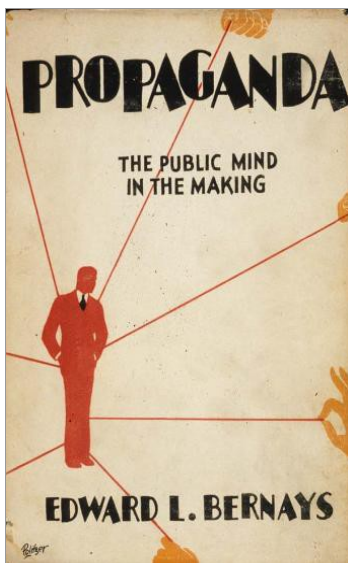

Caption The Public Mind in the Making (Book cover 1928)

'The conscious and intelligent manipulation of the organized habits and opinions of the masses is an important element in democratic society. Those who manipulate this unseen mechanism of society constitute an invisible government which is the true ruling power of our country. We are governed, our minds are molded, our tastes formed, our ideas suggested, largely by men we have never heard of.' --- Edward Bernays, 1928, pg.1, Propaganda

Aldous Huxley, on the 30th anniversary of his own seminal 1931 allegorical novel *Brave New World*, made the following dreadful observations in the very opening segment of his talk on the Ultimate Revolution upon which mankind and modernity are perilously perched:

'You can do everything with bayonets except sit on them! If you are going to control any population for any length of time you must have some measure of consent. It's exceedingly difficult to see how pure terrorism can function indefinitely. It can function for a fairly long time, but I think sooner or later you have to bring in an element of persuasion. An element of getting people to consent to what is happening to them. Well, it seems to me that the nature of the Ultimate Revolution with which we are now faced is precisely this: that we are in process of developing a whole series of techniques which will enable the controlling oligarchy who have always existed and presumably always will exist, to get people actually to love their servitude!

This is the, it seems to me the ultimate in malevolent revolution shall we say.' --- Aldous Huxley, 1962 speech at UC Berkeley, minute 04:06

In order to understand how the comprehension of Edward Bernays and Aldous Huxley, though both long dead, still manifests itself in these times, we must begin with the Mighty Wurlitzer.

However, first, a gestalt shift in perspective is necessary. Please stare at the image below for a few moments of reflection before proceeding.



Caption Perspective: Oh what a difference even a slight shift can make!  
(Image [source](#))

### **What is the 'Mighty Wurlitzer'?**

It used to be the honorific of Frank Wisner, the first chief of political warfare for the Central Intelligence Agency, used to describe the C.I.A.'s plethora of front organizations and newsmedia stooges that he was capable of playing (like a great organ with many keyboards) for synthesizing any propaganda tune that was needed for the day. See **Operation Mockingbird** ( <http://www.spartacus.schoolnet.co.uk/JFKmockingbird.htm> ) ([PDF](#)).

The fact that such an omnipresent Message-Machine is not ancient history but very much current affairs, is underscored by this NYT headline “**Behind TV Analysts, Pentagon’s Hidden Hand**”, Sunday, April 20, 2008 ( <http://tinyurl.com/6qhfgf> ). Also see [Jessica Lynch](#)

Media Myth-Making in Iraq War during **Operation “Iraqi Freedom”** in Further Study.



Caption The Mighty Wurlitzer Organ:  
Metaphor for the Multi-Modal  
Propaganda Message-Machine  
which can Play Many Perception-  
Molding Tunes Simultaneously to  
Make the Public Mind

Therefore, today, I use the term '**Mighty Wurlitzer**' as a metaphor to pluralistically refer to the same message-machine, i.e., the intelligence apparatus for manufacturing consent and controlling dissent, and its concomitant conscious manipulation of peoples' thoughts, feelings, actions and in-actions, in order to serve the primacy interests of the behind the scene governing oligarchy. The latter are, invariably, also the de facto owners of the complete messaging-system now even more globally ubiquitous than when Frank Wisner played the world for a fool.

This 'grand organ' is now able to even more effectively synthesize, implant, and reinforce, all the right set of beliefs (myths) among the entire world's public – by suitably combining 'events' with imaginative 'expos' writing – which appropriately primes the world populations to acquiesce to the oligarchic agendas. While playing this orchestra is now an integral part of all state-craft, its major musical themes are entirely determined by the behind the scenes owners of the system. While some might refer to the underlying techniques as propaganda and psy-ops, 'Mighty Wurlitzer' singularly captures the messaging-system controlled under a unified purpose of command which is both highly compartmentalized and cellularized. Only the Mighty Wurlitzer knows the entire tune.

What this means is that not all who willingly cooperate with the Mighty Wurlitzer in synchronistically humming its themes are knowingly being purveyors of its myths and deception. Many of its most shrill echoers are often well intentioned functionaries who are fed different motivating myths at different levels in the hierarchy – sometimes the lie is different at every level – such that it suitably motivates each according to their own predilection, professional station, and mission statement.

The Mighty Wurlitzer operates on the core premise which has been empirically shown to psychologically motivate most human action. That premise was elegantly captured in the following insightful observation made by the so called “Terrorism Study Group”, that

*“Public Assumptions’ Shape Views of History: Such presumptions are*

*beliefs (1) thought to be true (although not necessarily known to be true with certainty), and (2) shared in common within the relevant political community. The sources for such presumptions are both personal (from direct experience) and vicarious (from books, movies, and myths)."*

Successfully implanting such presumptions and pre-suppositions among any group is to motivate its overall actions in accordance with those implanted beliefs. Thus, many intelligent peoples for whom it is otherwise inexplicable to understand why they persist in 'United We Stand' with absurdities, are motivated to react sympathetically to those absurdities.

To barely catch a glimpse of how it's partially done, the following description by Col. Fletcher Prouty from the Preface to the first edition of his 1973 book "[The Secret Team](#)" is instructive ([PDF book](#)):

'There is another category of writer and self-proclaimed authority on the subjects of secrecy, intelligence, and containment. This man is the suave, professional parasite who gains a reputation as a real reporter by disseminating the scraps and "Golden Apples" thrown to him by the great men who use him. This writer seldom knows and rarely cares that many of the scraps from which he draws his material have been planted, that they are controlled leaks, and that he is being used, and glorified as he is being used, by the inside secret intelligence community.

Allen Dulles had a penchant for cultivating a number of such writers with big names and inviting them to his table for a medieval style luncheon in that great room across the hall from his own offices in the old CIA headquarters on the hill overlooking Foggy Bottom. Here, he would discuss openly and all too freely the same subjects that only hours before had been carefully discussed in the secret inner chambers of the operational side of that quiet Agency. In the hands of Allen Dulles, "secrecy" was simply a chameleon device to be used as he saw fit and to be applied to lesser men according to his schemes. It is quite fantastic to find people like Daniel Ellsberg being charged with leaking official secrets simply because the label on the piece of paper said "top secret," when the substance of many of the words written on those same papers was patently untrue and no more than a cover story. Except for the fact that they were official lies, these papers had no basis in fact, and therefore no basis to be graded top secret or any other degree of classification. Allen Dulles would tell similar cover stories to his coterie of

writers, and not long thereafter they would appear in print in some of the most prestigious papers and magazines in the country, totally unclassified, and of course, cleverly untrue.

In every case, the chance for complete information is very small, and the hope that in time researchers, students, and historians will be able to ferret out truth from untruth, real from unreal, and story from cover story is at best a very slim one. Certainly, history teaches us that one truth will add to and enhance another; but let us not forget that one lie added to another lie will demolish everything. This is the important point. Consider the past half century. How many major events -- really major events -- have there been that simply do not ring true? How many times has the entire world been shaken by alarms of major significance, only to find that the events either did not happen at all, or if they did, that they had happened in a manner quite unlike the original story?'

Coldly implicit in Col. Prouty's afore-quoted empirical statement: **“and the hope that in time researchers, students, and historians will be able to ferret out truth from untruth, real from unreal, and story from cover story is at best a very slim one”**, is the underlying Machiavellian modus operandi of buying time for sewing faits accomplis (new unalterable realities on the ground). By straight-jacketing all public discourse in deception when its timely revelation and unraveling can in fact derail the exercise of hegemony, new realities are constructed in the guise of responding to catastrophic events while the shell-shocked people remain dazed, confused, and frightened. They accept any solution offered by the authority figures as Americans did for instance in the aftermath of 9/11 when the catastrophic act of terrorism tore their world asunder. Ex post facto, and years down the road, separating myths and falsehoods from the calculus of hegemony will still remain only an academic exercise entirely irrelevant to reversing the faits accomplis already sewn! For Col. Prouty to not recognize this rather straightforward fact of the matter, the key modus operandi of Machiavelli for constructing new unalterable reality on the ground, as he nonchalantly observed the above quoted statement says something about the spymaster himself. See [Convince People of Absurdities and get them Acquiescing to Atrocities: The Enduring Power of Machiavellian Political Science](http://tinyurl.com/historys-actors) ( <http://tinyurl.com/historys-actors> ). Also see [Unlayering the Middle East War Agenda: Making Sense of Absurdities](http://tinyurl.com/unpeeling-lies) ( <http://tinyurl.com/unpeeling-lies> ).

### **Wikileaks and the Mighty Wurlitzer driving Imperial Mobilization**

A pertinent example of Col. Fletcher Prouty's fabricated leaks noted above, is the



Wikileaks' July 2010 disclosures of 'The Afghanistan Papers' which revealed nothing new.

Wikileaks has always been a rather transparent Mighty Wurlitzer ops. It is trivial to see through the absurdity of its protected existence despite it promoting itself as being a sort of dissenting watchdog upon empire. And therefore, ostensibly, being inimical to its unbridled quest for **“full spectrum dominance”**. Just like Al Jazeera television based in Qatar, which too, absurdly enough, is permitted to function unhindered in the same nation as America's CENTCOM headquarters.

Would it not be trivial for an armed to the teeth National Security State waging perpetual wars on civilians from Afghanistan to Iraq to Pakistan to Palestine to take-out either apparatus rather trivially if they were troublesome to its primacy and geostrategic imperatives? And that may happen once the useful idiots have outlived their utility, for *he who sups with the devil must have a long spoon!*

The reason each is allowed to function is of course social engineering, the sine qua non for waging modern warfare upon civilian populations by way of deception. It spans the entire gamut of engineering consent. From mantra creation in the

### Wikileaks Announces Osama bin Laden is alive and playing a key role in directing the war in Afghanistan, leaked US military files suggest



*'Multiple intelligence reports on the whereabouts of the al-Qaeda leader are contained among the documents. They disclose publicly for the first time that bin Laden is thought to be personally overseeing the work of suicide bombers and the makers of Taliban roadside bombs which have had a devastating effect on British and US troops. A secret "threat report" drafted by the Nato-led International Security Assistance Force (Isaf) in 2006 locates bin Laden as well as the Taliban leader Mullah Omar to the Pakistani city of Quetta as well as several villages on the Afghan border'. --- [UK Telegraph 27 July 2010.](#)*



***'I am aware that there is still some who would***

mainstream, and diabolically controlling dissent in order to control all opposition in the dissentstream, to actually fabricating the plainly visible pretexts (such as acts of terror) which can naturally ripen the conditions for the mantra of “clash of civilizations” to be called real in order to sustain the otherwise untenable “imperial mobilization”.

Backed by the Mighty Wurlitzer's compositions, inflicting state terror upon civilian populations as counter-insurgency, and military invasions of defenseless third-world nations for imagined or contrived threats in “preemptive self-defense”, automatically create and promote natural resistance among the victims thus breeding a self-fulfilling prophecy.

The director of the CIA, Michael Hayden, called this modus operandi of self-fulfilling prophecy, “tickling” the enemy: **“We use military operations to excite the enemy, prompting him to respond. In that response we learn so much”**.

Zbigniew Brzezinski most succinctly summed up the core political motivation for resorting to such Machiavellianess in his 1996 book

*The Grand Chessboard – American Primacy and Its Geostrategic Imperatives:* **“Democracy is inimical to imperial mobilization”**. (see full quote below)

This, all this, is the real fact of the matter that makes the Mighty Wurlitzer so indispensable

**question, or even justify the offense of 911.**

*But let us be clear. Al Qaeeda killed nearly 3000 people on that day.*

*The victims were innocent men, women, and children from America and many other nations who had done nothing to harm anybody.*

*And yet Al Qaeeda chose to ruthlessly murder these people, claimed credit for the attack, and even now states their determination to kill on a massive scale. They have affiliates in many countries, to try to expand their reach.*

***These are not opinions to be debated. These are facts to be dealt with.*** --- President Obama, Cairo Egypt, June 4th 2009, 911 and Imperial Mobilization Redux By Zahir Ebrahim



*'In the summer of 2005, the commission of the European parliament for security and defense, of which I am a member, was invited to a special screening created by the Washington Center for Strategic Studies*

*We were asked to watch a film which depicted what would happen in Europe, if Brussels was hit by a nuclear bomb.*

in military strategy. This is once again underscored by the April 20, 2008 NYT article mentioned at the very beginning, **“Behind TV Analysts, Pentagon’s Hidden Hand”**.

How can one tell manufactured reportage and fabricated leaks that are ab initio designed *“to promote a self-fulfilling prophecy”* from the real facts of the matter when it is most pertinent to averting its fait accompli?

### **How can one see through the psyops of the Mighty Wurlitzer?**

As daunting as it might appear to the mainstream television watcher, it is in fact rather straightforward for those unencumbered by blind faith in governments and its statecraft.

Just look for the core-lies and unquestioned axioms of empire that are typically retained in the “leaks” and reportage which, in order to sound credible, often openly expose what is mostly already known anyway or judiciously employ some variation of “Limited Hangout” wrapped in a veneer of dissent, 'freedom of the press', and often accompanied by the facade of angst and opposition from the state.

Furthermore, look for some of the lauded dissent names rushing to support the Limited Hangout – just as it was with Daniel Ellsberg for his infamous *Pentagon Papers* – to afford a veneer of legitimacy to the whistleblowing revelations of supposed state-secrets having caused some great harm to the state. The extravagance enacted in the mainstream media,

*Fifty thousand deaths, hundred thousand injured. The reactions of various European governments.*

*Suddenly, footage of Osama Bin Laden claiming responsibility for a nuclear attack on NATO headquarters comes on screen.*

*All members of the parliament, myself included, were rendered speechless.*

*Then a parliamentarian finally said:*

***“Today we were shown a convincing demonstration of how Osama Bin Laden’s image can be completely manipulated.***

***All the Osama’s we have seen over the years, may never have existed.***

***Just as a nuclear attack on NATO Headquarters in Brussels has never taken place.”*** --- ZERO

### **President Obama Announces Osama bin Laden is dead**



***“Good evening. Tonight, I can report to the American people, and to the world. The United States has conducted an operation that has killed Osama Bin Laden, the leader of Al Qaeda.”*** --- President Obama, May 1, 2011

alternately making heroes of the whistleblowers and demonizing them, is a giveaway to the circus show being enacted for plebeian consumption.

For, it matters not which side one takes, as both sides are patently false, crafted of calculated omissions and half-truths that retain core-lies, right out of the text book of the Technique of Infamy : **invent two lies and keep the public busy debating which of them is true!**

The role of crafty omissions in fabricating propoganda was best captured by Aldous Huxley in his Preface to *Brave New World* thusly:

‘The greatest triumphs of propoganda have been accomplished, not by doing something, but by refraining from doing. Great is truth, but still greater, from a practical point of view, is silence about truth. **By simply not mentioning certain subjects, by lowering what Mr. Churchill calls an “iron curtain”** between the masses and such facts or arguments as the local political bosses regard as undesirable, totalitarian propogandists have influenced opinion much more effectively than they could have done by the most eloquent denunciations, the most compelling of logical rebuttals. But silence is not enough. If persecution, liquidation and the other symptoms of social friction are to be avoided, the positive sides of propoganda must be made as effective as the negative.’ — Aldous Huxley, Preface (circa 1946) to *Brave New World*, 1931, Harper, pg. 11

To uncover omissions in a discourse is very difficult for the public who do not often have command over the domain in which the falsehoods are being perpetuated. As the psychological insight already quoted above from the Terrorism Study Group betrays, **“Public Assumptions’ Shape Views of History. Such presumptions are beliefs (1) thought to be true (although not necessarily known to be true with certainty), and (2) shared in common within the relevant political community.”**

Which is why inculcating ignorance, especially political-historical ignorance pertaining to international relations, and being made trusting of authority figures and the state, are the pre-requisites for any vile propoganda to succeed! A well bred lack of skepticism to authority figures, to experts in scientific disciplines, and to dissenting chiefs playing controlled opposition, thus becomes the heart of social engineering for 'United We Stand'.

This surfeit of blind trust in authority is what is ultimately harvested by the Mighty Wurlitzer. For a skeptical public, the tunes of the Mighty Wurlitzer would fall on very deaf ears and

public governance for private agendas would be well-nigh impossible in democratic nations. This is qualitatively no different than the power exercised by the religious clergy upon their faithful flock in any religion. Except that modernity has perniciously replaced them with multi-faceted secular clergies, the “experts”, each demanding obedience from its own 'United We Stand' trusting flock in all aspects of modern life.

This is also why “leaking” information from “experts” and “insiders” commands such a premium in Machiavellian democratic statecraft. When used judiciously so as not to dilute its impact, it can herd the flock in pretty much any direction that is desired.

As further empirically evidenced in the forensic analysis presented here, these so called whistleblowing of *leaky buckets* also succeed in accomplishing two important elements of statecraft:

- vicariously reinvigorate in the short-term public memory, the already established-by-fiat facts and core-axioms of empire;
- establish new convenient facts on the ground which are subsequently accepted as revealed gospel truths because of the already established thought-stream by the scholars of empire that when something is held in secret or is classified and subsequently declassified, or is prematurely leaked to the public, that it must contain some genuine “state secrets”, and never red herrings. Such thought-streams enable the directives of NSC 10/2 for plausible deniability (and those like it which we do not know about) to be trivially impressed upon the public mind (see [Anatomy of Conspiracy Theory](#)). These revelations of presumed “state-secrets” subsequently become the new unquestioned backdrops for both state policies and public discourses – the new “*doctrinal motivations*” – with copious help from the Mighty Wurlitzer's refined machinery.

This enables the successful deployment of already pre-planned policy prescriptions which craftily impel the various incantations of hegemony forward in baby-steps. Both, domestically by incrementally clamping down hard on rising discontent in the name of “national security”, and internationally by continuing to wage unpopular wars of preemption upon the 'untermenschen'. The infernal enemy has now been (re)confirmed to exist (despite popular skepticism) since even empire's own henchmen in their secret documents also affirm that belief (sic!). Speak of self-servingly suffering from a incestuously self-reinforced “*crippled epistemology*”!

The grandmaster of *The Grand Chessboard* himself, in his volt face half-truth laced

testimony before the Senate Foreign Relations Committee in 2007, confirmed the deconstruction of statecraft being done in this report: **“To argue that America is already at war in the region with a wider Islamic threat, of which Iran is the epicenter, is to promote a self-fulfilling prophecy.”** (see full quote below)

But earlier, the same Jewish architect of inflicting America's hegemony upon the world, Zbigniew Brzezinski, in his 1996 book *The Grand Chessboard* had un-abashedly examined the need for such invigorations of the public mind and the very promotion of self-fulfilling prophecies as a basic military tactic in order to assert *American Primacy and Its Geostrategic Imperatives*. As the former National Security Advisor under President Carter, and think-tank advisor to all subsequent occupants of the White House without prejudice, a diabolical strategist for the one-world oligarchic agenda primarily working for David Rockefeller who appointed him the first executive director of the Trilateral Commission, Brzezinski with his imposing resume (see [Zbigniew Brzezinski](#) ) betrays a shrewd comprehension of Machiavellian statecraft's reliance on social engineering. Here is a snippet for the absolute necessity of controlling the public mind for “imperial mobilization”:

**“It is also a fact that America is too democratic at home to be autocratic abroad. This limits the use of America's power, especially its capacity for military intimidation.** Never before has a populist democracy attained international supremacy. **But the pursuit of power is not a goal that commands popular passion, except in conditions of a sudden threat or challenge to the public's sense of domestic well-being.** The economic self-denial (that is defense spending), and the human sacrifice (casualties even among professional soldiers) required in the effort are uncongenial to democratic instincts. **Democracy is inimical to imperial mobilization.”** (pgs. 35-36) ;

“Public opinion polls suggest that only a small minority (13 percent) of Americans favor the proposition that 'as the sole remaining superpower, the US should continue to be the preeminent world leader in solving international problems'. ... Moreover, as America becomes an increasingly multicultural society, it may find it more difficult to fashion a consensus on foreign policy issues, except in the circumstance of a truly massive and widely perceived direct external threat. .... **More generally, cultural change in America may also be uncongenial to the sustained exercise abroad of genuinely imperial power. That exercise requires a high degree of doctrinal motivation, intellectual commitment, and patriotic gratification.**” (page 211 and onwards, [PDF book](#))

The diabolical utility of planting of **“Public Assumptions’ [that] Shape Views of History”** and therefore of current affairs, as the **“doctrinal motivation”** which can create **“intellectual commitment”**, and is rewarded by **“patriotic gratification”**, in this 'War on Terror' against the vile Militant Islam's torch bearers, the Islamofascists, cannot escape the careful reader's attention. It has wonderfully enabled **“America's power, especially its capacity for military intimidation.”**

The Terrorism Study Group in fact took up the future foretelling in 1997-1998 where Brzezinski's self-serving clairvoyance had left off in 1996 with his pithy diabolical wisdom in *The Grand Chessboard: “Democracy is inimical to imperial mobilization.”* Phil Zelikow, the future 9/11 Commission Executive Director, led the so called study on Catastrophic Terrorism. It presaged, on October 15, 1998, a full three years before 9/11, how that instinctual aversion of America's democratic public to **“imperial mobilization”** would be overcome by the United States striking out in response to catastrophic terrorism on its soil:

**“An act of catastrophic terrorism that killed thousands or tens of thousands of people and/or disrupted the necessities of life for hundreds of thousands, or even millions, would be a watershed event in America’s history.** It could involve loss of life and property unprecedented for peacetime and undermine Americans’ fundamental sense of security within their own borders in a manner akin to the 1949 Soviet atomic bomb test, or perhaps even worse. **Constitutional liberties would be challenged as the United States sought to protect itself from further attacks by pressing against allowable limits in surveillance of citizens, detention of suspects, and the use of deadly force.** More violence would follow, either as other terrorists seek to imitate this great ‘success’ or as the United States strikes out at those considered responsible. **Like Pearl Harbor, such an event would divide our past and future into a ‘before’ and ‘after.’”** --- History Commons ( <http://tinyurl.com/mlzfn5> )

The reality du jour exactly matches the doctrinal presaging done years in advance. America today is a police-state continually **“pressing against allowable limits in surveillance of citizens, detention of suspects”**, **“the use of deadly force”** is ubiquitous, and is fully engaged in a perpetual war of **“imperial mobilization”**, ahem, 'war on terror' against some Ali Baba, which its own former director of the CIA calls “World War IV” (see CNN report Thursday, April 3, 2003: Ex-CIA director: U.S. faces 'World War IV'). Its next target: Iran.

Predictably, with rising skepticism among the public on the utility of pursuing endless wars against illusive enemies that is making their own nation go bankrupt, more “harmful leaks”



from assets like Wikileaks will occur, but understandably none which are actually substantial. Like, blowing the lid on *9/11 as an inside job*, directly naming the top beneficiaries who shorted the Airline stocks raking in billions, or revealing how BBC came to report the demolition of WTC-7 a full 20 minutes before it actually transpired, never mind lending confirmation to any of the forensic detective work by independent researchers from the debris of 9/11, etceteras. And the main leaker du jour, Mr. patsy Julian Assange, like Mr. patsy Lee Harvey Oswald before him, will be sacrificed, perhaps with a new 'lone gunmen' enactment, or perhaps juridically, to lend the hoopla even more public respectability. Also see [Dismantling the Fiction of 'Former' and 'Ex' Intelligence – Zahir Ebrahim's Response to Philip Giraldi](#).

It's the exact same recipe as is used by all the other fabricated and controlled dissent assets of empire when they are not outright spinning patent lies, for spinning half-truths requires far more brilliance. One can already see the main dissent-chiefs of the West, like the venerable professor Noam Chomsky, anointed by the New York Times as “*arguably the most important intellectual alive*”, and the distinguished Daniel Ellsberg, excitedly supporting these Wikileaks exposés as if something ethereal was “*revealed in the Sinai*” (borrowing that diction from Elie Wiesel).

It is not for nothing that James Jesus Angleton, Head of CIA Counter Intelligence 1954-1974, is quoted in the 1992 BBC-2 Documentary on [Operation Gladio](#): “**Deception is a state of mind and the mind of the State**”. See: [Angleton \(1917 - 1987\)](#). Manufacturing Dissent with controlled opposition is an indispensable core construct of that very statecraft of deception. See: ['Manufacturing Dissent: Weapons of Mass Deception – The Master Social Science'](#).

With the preceding backdrop for overarching context, wherein we straightforwardly witness that empire's own strategists and scribes reveal years in advance with considerable chutzpah, *American Primacy and Its Geostrategic Imperatives*, and under what dystopian sociological conditions it could be mobilized with the democratic public being none the wiser, let's examine what I believe has been accomplished by Wikileaks in its service to empire's “War on Terrorism”. Please see “[What is War on Terror?](#)” ( <http://tinyurl.com/what-is-war-on-terror> and ) and [Postscript 'War on Terror' is not about 'Islamofascism' – Please get with the real agenda you people!](#) ( <http://tinyurl.com/what-is-war-on-terror-NOT> ) before proceeding further if you are only familiar with its insanity in empire's manufactured dissenting *Newspeak*. Meaning, the 'War on Terror' is neither irrational nor insane. It is firmly rooted in Machiavelli, the rational political science of “*imperial mobilization*”.

The core-lies retained in the Wikileaks' July 2010 disclosures – which I call 'the Afghanistan



Papers' – is to once again reaffirm that there is a real nemesis called “Osama Bin Laden”, that the “war on terror” is real, that it is being inflicted upon the West from Pakistan-Iran nexus, and to re-substantiate the handoff of former President George W. Bush's clairvoyance to the Obama Administration that *“If another September 11 style attack is being planned, it probably is being plotted in Pakistan, and not Afghanistan”!* That, when such a “planned” attack transpires, it *“will make Sept. 11 pale by comparison”*. See: **'Bin Laden': Key enabler of “imperial mobilization” and nuclear attack on Iran-Pakistan** (<http://print-humanbeingsfirst.blogspot.com/2008/04/binladen-keyenabler-nuclearattack.html> ).

The successful handoff of “*imperial mobilization*” to Pakistan and Iran, now further sprightly underscored by Wikileaks' documents, is once again demonstrated by President Obama's Secretary of State Hilary Clinton's July 2010 remark to the BBC as quoted by Reuters: *“There are still additional steps that we are asking and expecting the Pakistanis to take. But there is no doubt in anyone's mind that should an attack against the United States be traced to be Pakistani, it would (have) a very devastating impact on our relationship”*. And that is merely just another echo from the Obama Administration of what the Pakistanis themselves have been made to parrot the past 9 years, as demonstrated by its own Ambassador's remark in 2008:

*'[On] Wednesday, a media report quoted Pakistan's envoy to Washington as saying that US leaders had warned Islamabad that if the United States suffered an attack that was traced back to Pakistan Washington would retaliate. “Those (statements) have been made,” Ambassador Hussain Haqqani told editors and reporters at The Washington Post. “We want to make sure that it doesn't come to that.” -- DAWN, June 12, 2008*

To show Pakistan's unflinching willingness to do as much more as was asked, the Ambassador of Pakistan had further stated in an interview to Reuters in 2008:

*'Pakistan would attack Osama bin Laden the moment it had reliable intelligence on the Al Qaeda leader's whereabouts, Ambassador Husain Haqqani said on Wednesday. Haqqani also said he was confident Pakistan could help foil any Al Qaeda plans to attack the United States, although he did not know of any right now. “A cooperative effort between all the allies, and that includes Afghanistan, Pakistan and the United States and NATO – I think we can thwart any potential plans for an attack,” Haqqani said in an interview with Reuters.*

He said Pakistani intelligence had helped defeat many of the “several dozen” Al Qaeda plots detected worldwide since the September 11, 2001, attacks, but government officials knew of no immediate threats to the United States. Haqqani said Pakistan would act on its own against Al Qaeda if necessary. *“If Pakistan, Afghanistan or the United States had specific intelligence on the location of Osama bin Laden, they would have acted on it. No reservations would have come in the way of action on that, and none will even in the future,”* he said. *“If any of us had that actionable intelligence we would all act. We would act separately, we would act in tandem, we would act cooperatively – we would act.”* -- DAWN, June 12, 2008

So, could these self-serving 'Afghanistan Papers' have been any more convenient as a casus belli, carrying forth the same core-lies now entering its tenth year? If Wikileaks' dramatization grabbing all the world's headlines isn't an officially sponsored **“modified limited hangout”** for exactly that purpose of reinforcing the core-lies, then the White House not even bothering to stop the New York Times – whose own motto is 'All the news that's fit to print' – from publishing it, even giving it **“all got gold stars”** as the Salon put it on July 26, 2010, is downright inexplicable:

*“So, uh ... why was all of this information classified and top secret? If it's old news, and it just confirms what "everyone" already knows, what was the rationale for keeping it classified and calling WikiLeaks all sorts of mean names for publishing it?”*

What would it matter afterwards, after Iran and Pakistan have been bombed, what were lies and what was truth? Did the bogus mea culpa by the 2005 Presidential Commission on intelligence failure, the Iraq Study Group's disingenuous conclusion: **“We conclude that the intelligence community was dead wrong in almost all of its prewar judgments about Iraq's weapons of mass destruction. This was a major intelligence failure,”** reverse the decimation of Iraq? Did the New York Times 2008 revelation of Pentagon's Message Machine after 'all the barbers in town already knew it', return back to its silos each and every cruise missile that was dropped upon the innocent civilians of Iraq? Did Dr. Zbigniew Brzezinski's bizarre testimony of February 1, 2007 before the Senate Foreign Relations Committee undo the grotesque and criminal reality of *“imperial mobilization”* to which he now openly admitted? Even his bold public admission concerning the plausible false pretexts which could be found by the United States to attack Iran never made it past CSPAN, and in fact disappeared into the vast void of the Mighty Wurlitzer. What was Brzezinski's motivation for ratting on his own henchmen is anyone's guess. As a grandmaster strategist of The Grand Chessboard, he publicly issued a dare to the hawks in

the Bush Administration to subvert or delay an imminent attack on Iran at this time.

Here is what Brzezinski publicly admitted in his SFRC testimony on February 1, 2007:

'If the United States continues to be bogged down in a protracted bloody involvement in Iraq, the final destination on this downhill track is likely to be a head-on conflict with Iran and with much of the world of Islam at large. A plausible scenario for a military collision with Iran involves Iraqi failure to meet the benchmarks; followed by accusations of Iranian responsibility for the failure; then by some provocation in Iraq or a terrorist act in the U.S. blamed on Iran; culminating in a “defensive” U.S. military action against Iran that plunges a lonely America into a spreading and deepening quagmire eventually ranging across Iraq, Iran, Afghanistan, and Pakistan.

A mythical historical narrative to justify the case for such a protracted and potentially expanding war is already being articulated. Initially justified by false claims about WMD's in Iraq, the war is now being redefined as the “decisive ideological struggle” of our time, reminiscent of the earlier collisions with Nazism and Stalinism. In that context, Islamist extremism and al Qaeda are presented as the equivalents of the threat posed by Nazi Germany and then Soviet Russia, and 9/11 as the equivalent of the Pearl Harbor attack which precipitated America's involvement in World War II.

This simplistic and demagogic narrative overlooks the fact that Nazism was based on the military power of the industrially most advanced European state; and that Stalinism was able to mobilize not only the resources of the victorious and militarily powerful Soviet Union but also had worldwide appeal through its Marxist doctrine. In contrast, most Muslims are not embracing Islamic fundamentalism; al Qaeda is an isolated fundamentalist Islamist aberration; most Iraqis are engaged in strife because the American occupation of Iraq destroyed the Iraqi state; while Iran—though gaining in regional influence—is itself politically divided, economically and militarily weak. **To argue that America is already at war in the region with a wider Islamic threat, of which Iran is the epicenter, is to promote a self-fulfilling prophecy.'**

That admission requires no further elaboration from this scribe except to point out the smug hubris, that none among the senate committee members will rise to challenge his own role in that “*self-fulfilling prophecy*”, and none among the public's watchdogs of democracy will

deconstruct it in the newsmedia despite it being broadcast live on CSPAN. And they didn't!

Brzezinski's bold chutzpah of blaming the Bush Administration for their self-serving myth-making demagogic narratives to enable wars of aggression as "*self-fulfilling prophecy*", when the sole superpower in every government is only following his own recipe to fabricate "*doctrinal motivation, intellectual commitment, and patriotic gratification*" in order to pursue his previously outlined "*imperial mobilization*" agendas for "*American Primacy and Its Geostrategic Imperatives*" on The Grand Chessboard, and the "*self-fulfilling prophecy*" only overcomes his own principal lament "*that America is too democratic at home to be autocratic abroad*" which "*limits the use of America's power, especially its capacity for military intimidation*", is outright disingenuous. It's like Hitler blaming his generals for following Mein Kampf and conquering Europe, and Goebbels for being the Reichminister for propaganda!

Such ex post facto disingenuousness is evidently part and parcel of "*imperial mobilization*". Witness the following from the period of the Cold War, where synthetic terror was used in Western Europe in order to convince the increasingly skeptical public that the Communist threat was real requiring the continuous heightened state of alert and rising military expenditures at the expense of domestic spending – all revealed ex post facto by the BBC documentary in 1992 on NATO's Operation Gladio. Part-3 of the Gladio documentary has the following lovely statement quoted from the US Army's Top Secret Field Manual:

“Top Secret: There may be times when host country governments show passivity or indecision in the face of Communist subversion ... **US Army Intelligence must have the means of launching special operations which will convince host country governments and public opinion of the reality of the insurgent danger** ... US Army Intelligence should seek to penetrate the insurgency by means of agents of special assignments, with the task of forming special action groups among the most radical elements of the insurgency.”

Replacing “Communist subversion” in the text above with “Islamofascist terror” makes what is being stated in this report obvious. See Insurgency vs. Counter-Insurgency ( <http://tinyurl.com/what-is-insurgency> ) in order to relate that US Army Field Manual recipe of yesteryear with the present. In the year 2042, or even as early as 2032, surely by 2052, an updated BBC documentary will confirm it all, with at best, a mere tsk, tsk, and the all knowing characteristic nod at the imperial craftsmanship of empire. A new generation of Noam Chomsky legatees will emerge with new best-selling books waiving their sublime morality at empire (see Hegelian Dialectic of Dissent below) and will get to occupy

prestigious chairs in the academe as the new conscience of the world in one-world government.

**That is the real import of the craftsmanship of the Mighty Wurlitzer!** To engineer a fait accompli by manufacturing consent among the gullible masses and controlling dissent among the rabble rousers when *“imperial mobilization”* is still on-going, leaving future scholars, historians, and the odd malcontent to laudingly study the ashes, mea culpae, confessions, documentaries, de-classified documents, and strategic rattings left behind by *“history’s actors”*. A diabolical modus operandi of democratic statecraft which the Mighty Wurlitzer’s operators even brazenly gloat about:

**“We’re an empire now, and when we act, we create our own reality. And while you’re studying that reality -- judiciously, as you will -- we’ll act again, creating other new realities, which you can study too, and that’s how things will sort out. We’re history’s actors . . . and you, all of you, will be left to just study what we do.”** (Ron Suskind, New York Times, Oct. 17, 2004)

It is now patently obvious with the Obama Administration officially declaring Osama Bin Laden killed in an American raid on May 1, 2011, why Wikileaks had to “leak” the officialdom’s belief that he was still alive in July 2010! It is all too evident that some mileage is being derived by officially burying that nemesis at sea, a thousand miles from where they proclaim they killed him in an ambush in Abbottabad, Pakistan. Conveniently, it was in Pakistan and not Afghanistan that mankind’s toughest and most resourceful nemesis was found and killed. The color coded threat alerts instantly went up worldwide. Pakistan Navy presumably already suffered a bizarre revenge attack on its naval base in Karachi from Ali Baba’s elusive organization still intact, and now even more formidable than ever before. And its base of operation? Of course Pakistan!

Just as George W. Bush Jr., had intimated was the new Terror Central:

***“If another September 11 style attack is being planned, it probably is being plotted in Pakistan, and not Afghanistan”!***

Brzezinski’s unraveling of that *Bushism* in his SFRC testimony quoted above notwithstanding, was the 43rd President of the United States, George W. Bush Jr., just inordinately insightful to predict such matters as he was preparing to hand the presidential charge to his successor on the “change” platform? Carefully dissecting the nature of such self-serving propagandistic clairvoyance can perhaps also help the public to become

shrewdly clairvoyant in their own self-defense in these often confusing matters on international relations. Especially on what's likely to come as the next global mythical terror threat in the aftermath of Osama Bin Laden. Let's briefly review how the terrorism of 9/11 was continually foretold by the masters of discourse themselves – for that will surely show the public how to treat their next bit of self-serving fortune telling.

### **Taking a Deeper Look into the Dynamics of Mantra Creation: Islamofascism**

Let's begin at the very inception of the 'arc of crisis' which Zbigniew Brzezinski laid the groundwork for during his reign of terror upon the USSR as the National Security Advisor to the 38th President of the United States, Jimmy Carter. See [Instrumenting Kosovo in the 'arc of crisis' and the 'global zone of percolating violence'](http://tinyurl.com/arc-of-crisis) ( <http://tinyurl.com/arc-of-crisis> ) for other details of the epoch and its connections to the present 'War on Terror'. It suffices to quote here the following brilliantly clairvoyant statement attributed to Israeli Intelligence founder from the same epoch in 1979, a full two decades prior to 9/11:

'On Sept. 23, 1979, the founder of Israeli intelligence over dinner told me that America was developing a tolerance for terror. The gentleman's name was Isser Harel, the founder of Mossad Israeli intelligence-he ran it from 1947 to 1963. He told me that America had developed an alliance between two countries, Israel and Saudi Arabia, and that the alliance with Saudi Arabia was dangerous and would develop a tolerance for terror among Americans. He said if the tolerance continued that Islamic fundamentalists would ultimately strike America. I said "Where?" He said, ***"In Islamic theology, the phallic symbol is very important. Your biggest phallic symbol is New York City and your tallest building will be the phallic symbol they will hit."*** Isser Harel prophesied that the tallest building in New York would be the first building hit by Islamic fundamentalists 21 years ago.'

Source

And Mossad again betrayed its brilliant clairvoyance 20 years later:

'The attacks on the World Trade Centre's twin towers and the Pentagon were humiliating blows to the intelligence services, which failed to foresee them, and to the defence forces of the most powerful nation in the world, which failed to deflect them. The Telegraph has learnt that two senior experts with Mossad, the Israeli military intelligence service, were sent to Washington in August to alert the CIA and FBI to the existence of a cell of as many of 200 terrorists said to be preparing a big operation. ***"They had***

***no specific information about what was being planned but linked the plot to Osama bin Laden and told the Americans that there were strong grounds for suspecting Iraqi involvement,"*** said a senior Israeli security official.' --- UK Telegraph, 16 Sep 2001

Seeded by that “prophecy” from the stellar Israeli intelligence mind, British Zionist Svengali at Princeton University, Professor Bernard Lewis planted the '**The Roots of Muslim Rage**' in 1990 in the Council on Foreign Relations' prestigious magazine *Foreign Affairs*. An influential establishmentarian mouthpiece which is read around the world by those who believe that if you want to know what will happen ten years from now in any remote corner of the world, read *Foreign Affairs* of ten years ago:

“In 1990 Bernard Lewis, a leading Western scholar of Islam, analyzed '**The Roots of Muslim Rage,**' and concluded: 'It should now be clear that we are facing a mood and a movement far transcending the level of issues and policies and the governments that pursue them. **This is no less than a clash of civilizations** – that perhaps irrational but surely historic reaction of an ancient rival against our Judeo-Christian heritage, our secular present, and the worldwide expansion of both. It is crucially important that we on our side should not be provoked into an equally historic but also equally irrational reaction against our rival.” --- Samuel Huntington, *The Clash of Civilizations and the Remaking of World Order*, 1996, pg. 213

That 'Muslim Rage' was subsequently transformed in 1996 into a full blown political ideology for governing International Relations of the sole superpower as the infamous 'Clash of Civilizations', by Bernard Lewis' confrere and fellow Zionist at Harvard University, Professor Samuel Huntington:

**'The underlying problem for the West is not Islamic fundamentalism. It is Islam,** a different civilization whose people are convinced of the superiority of their culture and are obsessed with the inferiority of their power. The problem for Islam is not the CIA or the US Department of Defense. It is the West, a different civilization whose people are convinced of the universality of their culture and believe that their superior, if declining, power imposes on them the obligation to extend that culture throughout the world. These are the basic ingredient that fuel conflict between Islam and the West.'

 --- Ibid. pg. 217

'Some Westerners, including [ex] President Bill Clinton, have argued that the

West does not have problems with Islam but only with violent Islamist extremists. Fourteen hundred years of history demonstrate otherwise.... **Islam is the only civilization which has put the survival of the West in doubt, and it has done that at least twice...** The parallel concepts of 'jihad' and 'crusade' not only resemble each other...' --- Ibid. pg. 209

This systematic myth construction of 'Islamic Terror' was prime for harvesting as the global 'War on Terrorism' on September 11, 2001 by George W. Bush with the dialectical ultimatum to the world: ***“either you are with us, or with the terrorists”!***

Within 15 minutes of the super terrorism of that day in infamy, the newsmedia had been awash in naming the first terrorist: Osama Bin Laden! The scripted discourse is of course repeated ad nauseum to this very day, the last time by President Obama himself while announcing the boogeyman's demise on May 1, 2011: *“Good evening. Tonight, I can report to the American people, and to the world. The United States has conducted an operation that has killed Osama Bin Laden, the leader of Al Qaeda.”*

That's of course, after already having reiterated on the heels of his predecessor, on June 4th 2009, who was responsible for 9/11: *“But let us be clear. Al Qaeda killed nearly 3000 people on that day. The victims were innocent men, women, and children from America and many other nations who had done nothing to harm anybody.”*

And all foretold by the clairvoyance of the Zionist Israeli Mossad founder, and reinforced by other Israeli Military Intelligence Mossad agents in the days just preceding 9/11, of the brilliant Islamic fundamentalists' successful attack on the West's most prominent ***“phallic symbol”***.

Bernard Lewis subsequently justified George W. Bush's launching of the global 'War on Terrorism' in his phantasmic 2003 book *Crisis of Islam – Holy War and Unholy Terror*. First by reinforcing his earlier seeding of the mantra of 'the roots of the irrational Muslim rage', and extending those roots to Islam itself:

**'But Islam, like other religions, has also known periods when it inspired in some of its followers a mood of hatred and violence. It is our misfortune that we have to confront part of the Muslim world while it is going through such a period, and when most – though by no means all – of that hatred is directed against us.'** --- Bernard Lewis, *Crisis of Islam – Holy War and Unholy Terror*, pg. 25

And then clairvoyantly predicting the following self-serving conclusions as his last word:



**'If the fundamentalists are correct in their calculations and succeed in their war, then a dark future awaits the world, especially that part of it that embraces Islam.'** --- Ibid. Chapter IX: The Rise of Terrorism, pg. 164

**'If freedom fails and terror triumphs, the peoples of Islam will be the first and greatest victims. They will not be alone, and many others will suffer with them.'** --- Ibid. Afterword, December 1, 2003, pg. 169

### **The Collateral Damage to Language for Synthesizing the Doctrinal Motivation of Islamofascism**

Before we continue further, it is necessary to deconstruct the crafty use of language for synthesizing the aforementioned propaganda to fuel the “War on Terror”. The following is extracted from Project Humanbeingsfirst's very critical response to the CAIR (Council on American Islamic Relations) Report titled Calling CAIR to Account for its Omissions, for their egregiously omitting the most crucial fact of the matter in their otherwise stellar documentation of the rise of Islamophobia in America. The CAIR report (which incidentally underscores the observation that the name Council on American Islamic Relations sounds awfully similar to the Council on Public Relations founded by Edward Bernays to recast systems of propaganda into a new respectable light as “public relations” after World War II, the pathetic report is evidently serving the same function) was issued in collaboration with the Center for Race & Gender at the University of California, Berkeley. The significance of the following dismantling from first principles, beginning with the very use of language and the re-semantification of words to construct the propaganda system of Islamofascism, will not be lost to the builders of tall totem poles who worry about having plausibly sound doctrinal foundations in order to have propaganda stand at all.

#### **Let's examine the usage of the word “Islam” by Bernard Lewis.**

Unlike Christians and Christianity, Muslims have two completely separate words to designate the people who proclaim to follow the religion or are born into that culture (Muslims) vs. the divine religion (Islam). Any time you see one terminology aliasing for another, you might do well to remember that there is some axe to grind somewhere. Bernard Lewis is the venerable master of this obfuscation being amiably carried by CAIR without reservation. Bernard Lewis began his treatise “Crisis of Islam – Holy War and Unholy Terror” with the following gem:

“It is difficult to generalize about Islam. To begin with, the word itself is commonly used with two related but distinct meanings, as the equivalents

both of Christianity, and Christendom. In the one sense, it denotes a religion, as system of beliefs and worship; in the other, the civilization that grew up and flourished under the aegis of that religion. **The word Islam thus denotes more than fourteen centuries of history, a billion and a third people, and a religious and cultural tradition of enormous diversity.** --- Bernard Lewis, Crisis of Islam, pg. 1

That last sentence is the diabolical deception with which imperial craftsmanship subverts our religion: ***“The word Islam thus denotes more than fourteen centuries of history, a billion and a third people, and a religious and cultural tradition of enormous diversity.”***

According to the Author of the Holy Qur'an upon which the religion of Islam is based, the word “Islam” denotes only, and only, the following:

**“This day have I perfected for you your religion and completed My favor on you and chosen for you Islam as a religion;”** ( Arabic **الْيَوْمَ أَكْمَلْتُ لَكُمْ دِينَكُمْ وَأَتَمَمْتُمْ عَلَيْكُمْ نِعْمَتِي وَرَضِيتُ لَكُمُ الْإِسْلَامَ دِينًا** Holy Qur'an, Surah Al-Maida 5:3)

Indeed. Islam is the name of a religion, “deen” ( **الْإِسْلَامَ دِينًا** ).

That is the only, repeat only, context in which the word “Islam” can be legitimately used. It is the only context in which Qur'an has used it, indicating a divine religion to which the Author of the Qur'an itself gave the name “Islam”. The people didn't chose that name. Whether or not someone believes in Qur'an's “divinity” is irrelevant to us here; that is what the Book and the Religion upon which Bernard Lewis is proffering his imperial scholarship, itself proclaims.

**This is very significant.** The word “Islam” is quite distinct from the word used to designate Islam's followers and the affairs of its followers. That separation of terminology is itself espoused in the Holy Qur'an by virtue of having a separate terminology to refer to the followers. Once again, while this may sound repetitious, but to the Western mind wholly attuned to referring to Christians and Christianity with the same root word devolving from their God named “Christ”, no amount of repetition can ever be sufficient to drive the point home. The Qur'an itself defined a different nomenclature to name its followers; the followers didn't:

**“Our Lord! make of us Muslims, bowing to Thy (Will), and of our progeny a Muslim nation, bowing to Thy (will); and show us our place for the**

celebration of (due) rites; and turn unto us (in Mercy); for Thou art the Oft-Returning, Most Merciful.” ( Arabic رَبَّنَا وَاجْعَلْنَا مُسْلِمِينَ لَكَ وَمِنْ ذُرِّيَّتِنَا أُمَّةٌ مُسْلِمَةً لَكَ وَأَرِنَا مَنَاسِكَنَا وَتُبْ عَلَيْنَا إِنَّكَ أَنْتَ الرَّحِيمُ الرَّحِيمُ Holy Qur'an, Surah Al-Baqara 2:128)

This separation of terminology is in fact a singular distinction of Islam in comparison to all the other Abrahamic religions, indeed all major religions of the world including Hinduism, Bhuddism, and Zoroastrianism, which do not feature such a clear separation.

This is why followers of Prophet Muhammad for instance, are not called “Mohammedans”, nor believers of Islam “Islamic”, “Islamist”, etc. except by the prejudicial orientalists.

The word designated in the Holy Qur'an for human beings who are Muslims, regardless of good or bad people, pious or murderers, sinners or saints, is “Muslims”, or to be exact in the transliteration, “Muslimeen” ( مُسْلِمِينَ ). The Muslims throughout the world are referred to as “Muslim Umma”, or to be exact in the transliteration, “Ummat-e-Muslima” ( أُمَّةٌ مُسْلِمَةٌ ).

All who misuse the Qur'anic terminology, Muslims and non-Muslims alike, are either ignorant peoples – and there are always plenty of “learned morons” and parrots in every epoch who are deftly planted on the pulpit – or, the respected apprentices of Machiavelli. In the latter case, they deliberately try to subvert the religion of Islam by associating it with the inglorious deeds and the kingly history of Muslims.

One can immediately see the result of such gratuitous binding. It enables drawing false and specious associations by overloading the semantics in an already well-defined nomenclature.

That is the principal basis for subliminally, as well as cognitively, binding something virtuous (the religion) with something abhorrent (the vile deeds of the peoples, their kings, their cultures, their civilization). Thus, when the word Islam is mentioned, the abhorrent, or whatever is deemed abhorrent by Oriental scholarship, naturally springs to the mind of the seduced.

Based solely on that premeditated collateral damage to language that Samuel Huntington, the late circus clown of empire at Harvard, diabolically made the already quoted statement on “Islam” in his treatise “The Clash of Civilizations”. It is reproduced again because now we dissect it from the language point of view:

**“The underlying problem for the West is not Islamic fundamentalism. It**

**is Islam, a different civilization whose people are convinced of the superiority of their culture and are obsessed with the inferiority of their power.** The problem for Islam is not the CIA or the US Department of Defense. It is the West, a different civilization whose people are convinced of the universality of their culture and believe that their superior, if declining, power imposes on them the obligation to extend that culture throughout the world. **These are the basic ingredient that fuel conflict between Islam and the West.**" (Samuel Huntington, *The Clash of Civilizations and the Remaking of World Order*, 1996, pg. 217)

Since when did the word "Islam" indicate civilization? A civilization is an aggregate of peoples, harboring one or more cultures, one or more languages, one or more customs, one or more religions. Like the Western civilization which has the nations of German, French, English, American, Russian, etceteras, that many languages, and many religions are practiced in these nations, including atheism, Christianity, and Islam. Whereas Islam is a religion, a "deen". A religion can be practiced in any civilization, by any peoples, including right here in the USA.

Samuel Huntington's teacher was evidently Bernard Lewis, as evidenced from their common re-semantification of the word "Islam". This is how Huntington was able to demonize Islam: **"The underlying problem for the West is not Islamic fundamentalism. It is Islam,"** and **"These are the basic ingredient that fuel conflict between Islam and the West."** We have already witnessed the passage above in which Samuel Huntington cited his Princeton University confrere Bernard Lewis as the author of **'The Roots of Muslim Rage'** and the first authority on the **"Clash of Civilizations"**. They incestuously reinforce each other rather well, don't they? Cass Sunstein, the other propagandist Harvard Law professor and President Obama's information czar, referred to such incestuous self-reinforcements in his erudite paper on **"Conspiracy Theories"** in the more refined academic jargon, as **"crippled epistemology"**.

As we perceptively observe, it is the diabolical misuse of language which first and foremost enables drafting a thesis like "Clash of Civilizations". (See *Prisoners of the Cave* Chapter 9 which deconstructs Huntington's craftsmanship in more depth.) Such theses, made erudite and plausible sounding with the IVY League stamp, are thence crafted into simple propaganda to seed the Mighty Wurlitzer's many compositions. It is repeated ad nauseum thereafter.

Since Western people's point of reference is mainly *Christianity* where the common root word denotes everything, the people "Christians", the religion "Christianity", the civilization

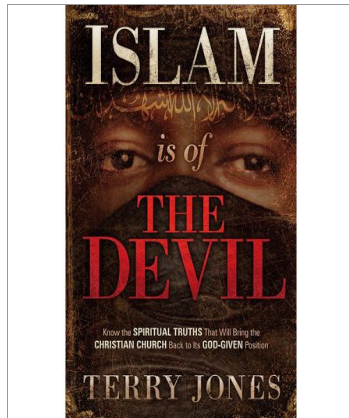

Caption **The Hegelian Dialectic side A: Reviling Islam** (Islam is of The Devil by Pastor Terry Jones)

“Christendom”, even the God “Christ” – in fact everything that Bernard Lewis falsely and maliciously imputed to Islam on page 1 of his propaganda manual “Crisis of Islam” – the same *kitchen sink* linguistics devilishly attributed to Islam, repeatedly, makes it believable for the un-informed Western public.

Thus, maligning Islam before the un-informed masses becomes a child's play for the Mighty Wurlitzer. Effective propaganda is always targeted only at the ordinary un-informed peoples, **“the crowd of simpletons and the credulous”**, as examined in the report Manufacturing Dissent. Its core purpose is to control public behavior by instilling false beliefs.

And we can see its rich harvest not in just the 'United We Stand' against “militant Islam” and the unfettered “imperial mobilization” and “shock and awe”, but in the Qur'an burning, Islam bashing, and other Islamophobic festivities of the ignorant people against Muslims. It is surely not a surprise then, that Islamophobia should have increased steadily in the United States and the West since 9/11. Islamophobia is only the desired and natural effect of the propaganda system of the Mighty Wurlitzer. Like the festering boil on the protesting bride's lip, it is only symptomatic of the real syphilis beneath the virtuous wedding gown.

This crucial analysis unarguably illustrates how imperial scholars incestuously reinforce each other in implanting the “*doctrinal motivation*” mentioned by Zbigniew Brzezinski as being necessary for “*imperial mobilization*”. It was pretty much the same protocol in the quest for *Lebensraum* of the Third Reich in yesteryear. At Nuremberg, the Nazi Party's chief philosopher, Alfred Rosenberg, was hanged for his mumbo jumbo. The third Reich's chief of propaganda, Reichminister of Propaganda and National Enlightenment, Dr. Joseph Goebbels, committed suicide after administering cyanide to his wife and six young children before the long arm of justice could wring his neck. Just thought I'd mention that in passing.

Such premeditated collateral damage to language, with the concomitant priming of doctrinal fuel for the long gestating mantras of “The Roots of Muslim Rage” years in advance of its catastrophic unveiling, is what so trivially enabled forging a bipartisan political consensus on the US foreign policy of aggression and invasion in the immediate aftermath of the shock effects of 9/11. The Patriot Act I was passed quickly without reading, and the entire United States Congress, save one member, gave its green light to

invade Afghanistan. The mightiest and richest nation on earth patriotically savaged the poorest and weakest nation on earth in a broad political consensus. The American peoples 'United We Stand' saluting the flag, and motor car bumper stickers proudly proclaimed "We Support Our Troops".

Please refer back to Zbigniew Brzezinski's quoted passages above to refresh your memory that he had shrewdly stated in 1996: ***"Moreover, as America becomes an increasingly multicultural society, it may find it more difficult to fashion a consensus on foreign policy issues, except in the circumstance of a truly massive and widely perceived direct external threat."*** *The Grand Chessboard* effectively blueprints the entire chain of causal linkages which have empirically transpired since 9/11, exactly as it was for Hitler's *Mein Kampf*.

Furthermore, also recall the previously quoted clairvoyant statements made by the so called Terrorism Study Group. These too lend prima facie evidence for how the Mighty Wurlitzer **premeditatively** harnessed the 'searing' or 'molding' event of 9/11, the "new Pearl Harbor", to successfully capitalize on the pre-implanted public myths of Islamofascism to launch the perpetual "War on Terror". For, in all that confusion surrounding the event of Catastrophic Terrorism, fait accompli of the despotic response by the sole superpower was automatically seeded because ***"Like Pearl Harbor, such an event [divides] our past and future into a 'before' and 'after.'"*** Now anything goes because ***"what is inconceivable in normal times is possible in revolutionary times"***, including launching aggressive wars against innocent nations, and turning one's own nation into a police-state. Ex post facto, print all about it in the New York Times!

Thus, also recall the previously mentioned chutzpah of their mea culpae, ex post facto, led by the Iraq Study Group in 2005 blaming "intelligence failure" for the missing WMDs in Iraq, and the New York Times in 2008 blaming the Pentagon, see [Pentagon's Message Machine Behind TV Analysts, Pentagon's Hidden Hand](#), April 20, 2008. More such revelations will continue to occur as world government is incrementally cemented. Someday, even sixth graders will learn about it with a tad more honesty than the public is permitted to know today, just as school children candidly learn today about the genocide of the native American Indians on their own land.

What had appeared to casual observers who had been interested enough to read this stuff before the events of 9/11, to be only academic psychoanalyses of the American public, became the actual reality of "imperial mobilization" exactly as was so boldly foretold in these public writings.

It is also useful to recall at this point that the US Chief prosecuting counsel at Nuremberg, Robert H. Jackson, had declared on hearing the feigned protestations from the Nazi leadership on trial that they didn't know anything about Hitler's plans for *Lebensraum*:

“The plans of Adolf Hitler for aggression were just as secret as Mein Kampf, of which over six million copies were published in Germany” --- Justice Robert H. Jackson in his closing speech at Nuremberg, on Friday, 7/26/1946, Morning Session, Part 3, Trial of the Major War Criminals before the International Military Tribunal

Thus, Islamophobia steadily rising even in the tenth year of the catastrophic terrorism of 9/11 as documented by CAIR and the University of California, Berkeley, is a direct descendent of the Dynamics of Mantra Creation for “Islamofascism”. One can no more describe the effects of Islamophobia without also describing its first cause, the American *Mein Kampfs* written by Jewish hands in Muslim blood to launch “*imperial mobilization*”, than one can describe the color of a tree without describing its first cause, the DNA of the tree.

Don't these scholars know their own literature? Can't they judge motivation? Can they not add two plus two to equal four? Will they also brazenly feign on their own day of reckoning that they were just highly paid ignorant morons unaware of the new *Mein Kampfs* rather than the learned scholars they are now presented to be?

Only vulgar propagandists and traffickers in truth will hide the causal linkages between pre-planned doctrines and the unfolding reality. That is a crime against the people! And only fools and useful idiots among them will pretend to not understand that crime. And that is the overarching success of the Mighty Wurlitzer. The myth of militant Islam has been successfully cast into perceived reality for the public.

### **The Hegelian Dialectic Militant Islam vs. Moderate Islam**

The preceding success of the Mighty Wurlitzer effectively enables introducing the Hegelian Dialectic of “moderate Islam”.

Once demonized sufficiently with “militant Islam” and “islamofascism”, with “Islamophobia” sufficiently priming the public, the new propaganda slogan automatically becomes: **we want to “reform Islam” for a more “moderate Islam”!**

To mobilize this new devil like the previous one for “militant Islam” also requires the same

**“high degree of doctrinal motivation, intellectual commitment, and patriotic gratification.”** as perceptively observed by Zbigniew Brzezinski in *The Grand Chessboard*. Please refer back to the full quoted excerpt above to remind yourself of this fact.

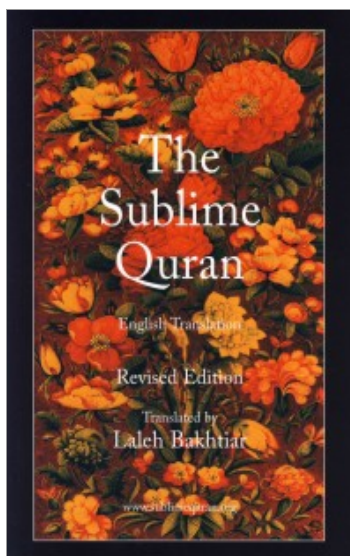

**Caption The Hegelian Dialectic side B: Reforming Islam “... Quran translated by an American woman. This modern, inclusive translation refutes past translations that have been used to justify violence against women.”** (The Sublime Quran By Laleh Bakhtiar)

Thus new comparable works of “doctrinal motivation” become available preaching “moderate Islam”. These works and writings started appearing immediately in the aftermath of 9/11 with learned Muslim clerics making loud proclamations against “militant Islam” and speaking of “good Muslims” vs. “bad Muslims” (see interview Shaykh Hamza Yusuf Hanson, San Jose Mercury News, Sunday Edition, September 16, 2001, [cached](#)). Clerics most faithfully echoing the core message of empire are immediately invited to the White House and to the Presidential Address in Congress by President George W. Bush Jr. and seated with Laura Bush and Tony Blair for dutifully speaking out against “Militant Islam” (watch [CSPAN](#) Presidential Address, September 20, 2001, see [video image](#) of Shaykh Hamza Yusuf with Laura Bush, Tony Blair, Donald Rumsfeld offering standing ovation to George W. Bush's pending invasions of Muslim nations along with the rest of United States Congress). Religious *fatwas* are issued against “militant Islam” and terrorism by “moderate” clerics in favor of “moderate Islam” (see [Response to the Fatwa on Terrorism in the Service of Empire](#), this [photograph](#) reveals the *fatwa* granting cleric Tahir ul Qadri prominently seated and speaking at the World Economic Forum).

New translations of the Holy Qur'an are marketed to “bring reform to Islam” by respectable progressive scholars (see [Critique: Laleh Bakhtiar and The Sublime Quran](#)). Shocking eye-catching news headlines in Westerndom's most prestigious newspapers announce their availability (see The Sunday Times of London, March 31, 2007, [Wife-beating rejected in ‘new’ Koran](#) ).

And the same three ring circus is masterfully conducted by the Mighty Wurlitzer with the “moderate Islam” show added to play concurrently in the same broad arena with many other side shows (switching metaphor for appropriateness). The crucial difference in this instance however is that it is seemingly staged by “reform minded”, progressive, as well as



conservative Muslims themselves. Sophisticated and scholarly looking Muslim intellectuals are recruited for this purpose from across the intellectual spectrum (see [FAQ What is an Intellectual Negro?](#)).

Muslim bookstores prominently feature the “reform Islam” authors’ works with glowing tributes: *“This is the first edition of the Quran translated by an American woman. This modern, inclusive translation refutes past translations that have been used to justify violence against women.”* (see [Kazi Publications](#), frontpage [cached](#)). Please refer to [Critique: Laleh Bakhtiar and The Sublime Quran](#) where the following commonsense is noted with respect to the preceding statement:

'It is your grave misconception that Muslims beat their wives because the Holy Qur'an gives them permission to beat their wives. Muslims also kill their wives, do honor killings of their children and family members, and a thousand other grotesque and equally criminal things in Muslim societies – **and the Holy Qur'an strictly forbids it all.**

And Muslims do no more horrendous acts than the pious Western Christians and holy Western Jews who commit the most heinous crimes, and monumental crimes against humanity which are on-going even as I write this. The white man today is calculatingly killing and raping far more Muslim women on a daily basis with “shock and awe”, drone attacks, military occupation, to the thunderous silence of Western champions of human rights than any Muslims assaulting their wives in domestic quarrels because of 4:34. **But of course it is Islam which needs to be reformed first with a new translation of the Holy Qur'an.** Daniel Pipes must be feeling rather pleased with himself for this fortuitous gift.' --- Zahir Ebrahim in his letter of critique to Laleh Bakhtiar

It is evidently more effective if respectable looking mainstream Muslims themselves appear to drive the demand to **“bring reform to Islam”** for “moderate Islam” rather than Jews like Daniel Pipes, David Horowitz, Bernard Lewis, the late Samuel Huntington, the neo-cons at AIPAC, JINSA, AEI; Christians like the 700 Club, Quran burning pastor of the Church in Florida whose book on Islam is pictured above; the White House, the Pentagon; the think-tanks; the Western courts, et. al., appear to be driving it. **The synergistic WWF wrestling matches however always only collect windfall profits for the same root promoter.**

The revealing thing to observe here is the intriguing background of some of the most prominent among these “moderate Islam” shrill voices in America. They are often converts

to Islam from Christian heritage and have become self-taught scholars of Islam in America with imposing command of Arabic. The loud mouth striving to **“bring reform to Islam”** by writing an entirely new English translation of the Holy Qur'an no less, titled The Sublime Quran (see image above), grew up as a Catholic of mixed Iranian-American parentage. She is Laleh Bakhtiar, Ph.D. in Education Psychology. As a linguist in Arabic and English, she employs the same re-semantification of the word “Islam” as Bernard Lewis and Samuel Huntington when she pitches **“bring reform to Islam”!** In the Critique: Laleh Bakhtiar and The Sublime Quran:

'You surely could not have meant 'reform the religion of Islam' for which the Holy Qur'an stated: **“This day have I perfected for you your religion and completed My favor on you and chosen for you Islam as a religion;”**  
( Arabic الْيَوْمَ أَكْمَلْتُ لَكُمْ دِينَكُمْ وَأَتَمَمْتُ عَلَيْكُمْ نِعْمَتِي وَرَضِيتُ لَكُمُ الْإِسْلَامَ  
دِينًا Holy Qur'an, Surah Al-Maida 5:3)

**You are going to reform what Allah [perfected]?**

You surely must have meant to say 'reform the misunderstandings among the Muslims regarding Islam.'

Then why not just say exactly what you mean?

Does the statement “bring reform to Islam” mean the same thing as 'bring reform to Muslims' to a grammarian and linguist who has translated the Holy Qur'an from Arabic into English?' --- Zahir Ebrahim in his letter of critique to Laleh Bakhtiar

And the loudest mouth decrying “militant Islam” from the first day of 9/11 is of course Hamza Yusuf, convert to Islam from Orthodox Christianity. He was studying to be a male nurse in Santa Clara California where I knew him in the 1980s giving fiery Friday sermons to the delight of the pious Muslim worshipers, before he conferred upon himself the lofty honorific of “Shaykh” in the 1990s and started his own institute to teach “moderate Islam” to Americans. Called the Zaytuna Institute, now Zaytuna College in Berkeley. He is well respected among many American Muslims who swear by his scholarship with an almost cult like faith – the “moderate Islam”. He has acquired international fame for his oratory and his command of the arcane in the Muslim writings of antiquity so revered by the majority of Muslims. He told the UK Guardian's Jack O'Sullivan in an article titled: 'If you hate the west, emigrate to a Muslim country', October 08, 2001:

**' "Many Muslims seem to be in deep denial about what has happened,"**

**he says. "They are coming up with different conspiracy theories and don't entertain the real possibility that it was indeed Muslims who did this. Yet we do have people within our ranks who have reached that level of hatred and misguidance." '**

Jack O'Sullivan introduced Hamza Yusuf in the lede to his aforementioned article with this description:

**'Hamza Yusuf is arguably the west's most influential Islamic scholar. Many Muslims find his views hard to stomach, but he is advising the White House on the current crisis, and today he will be talking to religious leaders in the UK'.**

As respected Muslim opinion makers bearing exactly the right credentials to appeal to their respective Muslim constituencies, they make great useful idiots and/or assets for this Hegelian Dialectic just like their “militant Islam” counterparts, whether or not they are themselves aware of it. It is no different than the suicide bombers recruited for “militant Islam” and being handled by local intelligence handlers who themselves deeply believe in their divine mission quite oblivious to the reality that they are dancing to the Mighty Wurlitzer's tune. Unless of course, also like many of their counterparts in the theater of “militant Islam”, they too were psychologically profiled and directly recruited as controlled sleeper assets of the Mighty Wurlitzer a long time ago for later harvesting.

Empiricism has the bad habit of revealing the obvious. It is especially pertinent to observe how this Hamza Yusuf character immediately sprung into prominent action as if on cue in the immediate aftermath of 9/11. When the rest of American news media was blaming “militant Islam” within 15 minutes of 9/11, Hamza Yusuf managed to get his interview published in the San Jose Mercury News in the very first Sunday's edition after 9/11, September 16, 2001, condemning “militant Islam” with pious indignation. And on September 20, 2001 was in the White House, and seated next to Laura Bush in Congress. And thereafter meeting British leaders selling the empire's story to Muslims in Britain.

No Trojan Horse agent of the Mighty Wurlitzer could have done more than Hamza Yusuf did – contribute directly to build consensus for invading Afghanistan and the 'War on Terror' by driving it from the angle of “moderate Islam”.

**It is no accident that each and every prominent proponent of “moderate Islam” and “reform Islam” also promulgates that 9/11 was done by “militant Islam” echoing the core-axiom of empire!**

And this is precisely what betrays them, the fact that they are running with the foxes while hunting with the hounds. **Otherwise the Hegelian Dialectic would not work!**

The message to their own flock is simple but effective, drawn right from Edward Bernays text book on Propaganda quoted at the very beginning of this report, and Hitler's Mein Kampf. Just as Dr. Joseph Goebbels had a very simple message for corralling the Germans, these Muslim leaders have an equally simple message for their flock adapted from empire's singular core-axiom. First, in order to refresh one's memory, this is what is reported in Mein Kampf:

'The success of any advertisement, whether of a business or political nature, depends on the consistency and perseverance with which it is employed.

In this respect also the propaganda organized by our enemies set us an excellent example.

It confined itself to a few themes, which were meant exclusively for mass consumption, and it repeated these themes with untiring perseverance.

Once these fundamental themes and the manner of placing them before the world were recognized as effective, they adhered to them without the slightest alteration for the whole duration of the War.

At first all of it appeared to be idiotic in its impudent assertiveness. Later on it was looked upon as disturbing, but finally it was believed.

But in England they came to understand something further: namely, that the possibility of success in the use of this spiritual weapon consists in the mass employment of it, and that when employed in this way it brings full returns for the large expenses incurred.

In England propaganda was regarded as a weapon of the first order, whereas with us it represented the last hope of a livelihood for our unemployed politicians and a snug job for shirkers of the modest hero type. ... I learned something that was important at that time, namely, to snatch from the hands of the enemy the weapons which he was using in his reply. I soon noticed that our adversaries, especially in the persons of those who led the discussion against us, were furnished with a definite repertoire of arguments out of which they took points against our claims which were being constantly repeated.

The uniform character of this mode of procedure pointed to a systematic and unified training. And so we were able to recognize the incredible way in which the enemy's propagandists had been disciplined, and I am proud today that I discovered a means not only of making this propaganda ineffective but of beating the artificers of it at their own work. Two years later I was master of that art.' [Mein Kampf, Adolph Hitler, Vol. 2, Chapter VI]

Now compare to what is repeated ad nauseam and with great consistency from virtually every “good” Muslim mosque pulpit and from every “good” Muslim institutional soapbox including the most prominent American Muslim civil rights organization CAIR noted earlier, each using their own diction of course to inflict precisely the following Propaganda for “moderate Islam”:

- it was “militant Islam” which is responsible for 9/11 attacks,
- these are the “bad” Muslims, we are the “good” Muslims, we don't do terrorism,
- we must fight terrorism,
- we must support our government to fight the militants,
- and we must practice “moderate Islam” which is the true Islam,
- our blessed Prophet was a “moderate”,
- he did not kill innocent peoples,
- the Qur'an forbids killing innocent people. --- Propaganda message of “moderate Islam”

Consequently, religion-based as well as secular-based voices of “moderate Islam”, the lofty bearers of this propaganda feast for the **“the crowd of simpletons and the credulous”**, are immediately effective in corralling the majority of “good” Muslims. They span the full gamut of persuasions from conservatives (Hamza Yusuf et. al.) to reform oriented progressives and seculars (CAIR et. al., Laleh Bakhtiar et. al.). All “good” Muslims end up “United We Stand” with the empire in its perpetual war against “militant Islam” following their respective pied pipers. This propaganda transcends the sectarian divide among the “good” Muslims in the West. This is the dominant characteristic of the vast majority of the 'United We Stand' mainstream Muslims.

To draw upon empiricism to validate, observe the “good Muslims” inextricably caught in this Hegelian Dialectic in [Muslims against Terrorism](#) (frontpage [cached](#)), and watch the rich and famous make [Proud to be American Muslims](#) videos to distance themselves from “militant

Islam". Joseph Goebbels would be immensely proud of his legates. At the peak of hubris, Sieg Heil is the only reality!

The few angry Muslims escaping Sieg Heil like the rest of the few angry citizens, but still caught in the Hegelian Dialectic are corralled by the controlled dissent-space anxiously waiting to welcome them. See Hegelian Dialectic of Dissent below.

The controlled dissent is run very efficiently on a treadmill permitting the angry Muslims along with the rest of the Western public to vent their lungs out shouting in the streets, and their fingers out typing on the internet, before they return back to their jobs Monday morning feeling fresh from the weekend catharsis. The too angry among them who are not so easily placated by "weekend jihad" soon acquire the label "bad" or "terrorist". There is no escape for them so long as they remain caught in the Hegelian Dialectic.

Please go back a little to the Guardian interview with Hamza Yusuf quoted above and observe the uncanny exactness in the wording which almost mirrors the New York Times' anointing Noam Chomsky. Between "*[Noam Chomsky is] arguably the most important intellectual alive*" (New York Times) driving the Left, and "*Hamza Yusuf is arguably the west's most influential Islamic scholar*" (Guardian) driving the Muslim Right, both proclaiming "militant Islam" attacked America on 9/11 in great synergy with the White House and the Pentagon, the field is covered.

One heads the manufacturing dissent factory catching those who escape the Hegelian Dialectic of "militant Islam" vs. "moderate Islam", the other heads the manufacturing consent factory for "moderate Islam" against "militant Islam" beating the imperial drums.

Where you gonna go?

Those few who eventually wisen up to it all and fearlessly exit that Hegelian Dialectic altogether are now attempted to be corralled in warmly welcoming "conspiracy" groups strategically cultivated for exactly this purpose as part of "*imperial mobilization*" planning. As Cass Sunstein put it in "Conspiracy Theories", these groups lend "**beneficial cognitive diversity**" to aid statecraft defocus all the angry energies.

If the Hegelian Dialectic didn't get all the morally angry people as it did the vast majority of the public diabolically trapped between the false paradigm of "militant Islam" vs. "moderate Islam" and controlled dissent all sharing the empire's core-axioms, this trap catches the remaining majority. Watch how the most intelligent among this lot soon find themselves in the 9/11 Truth Movement. See Toronto Hearings: A strange cast of characters among 9/11 Truth Leadership.

That treadmill is strategically designed to occupy the remaining morally angry people studying 9/11 mysteries and how the WTC towers came down repeatedly calling for “new investigations”. The “*history's actors*” of course, unbeknownst to these bright lads, have already announced that this is precisely what they shall all be kept busy with: **“We're *history's actors* . . . and you, all of you, will be left to just study what we do.”** In the meantime, the “*history's actors*” have acted again and created “*new realities*”.

There is no exit from that trap either so long as one is kept occupied with the previous fait accompli leaving the “*history's actors*” free to enact new ones!

The aforementioned set of comprehensive fly traps pretty much ensnare what appears to this scribe to be close to ninety nine percent of the nation's citizenry. About the remaining odd percent (or two), Adolph Hitler had observed in his Mein Kampf: **“*the value of these [skeptics] lies in their intelligence and not in their numerical strength,*”!** No one pays any attention to them whatsoever. If they speak, they are first ignored, then reviled, and then made an offer they can't refuse. As part of “imperial mobilization” planning, statecraft ensured via the Patriot Acts, police state laws, “no fly lists”, etc., that there remained no effective means for ordinary citizens to ever effectively mobilize themselves together on a single focussed goal of derailing “imperial mobilization” and therefore pose any threat whatsoever to their plans.

**From the propaganda of Islamofascism to domestic police state was one short jump in this slick game of “*imperial mobilization*”.**

The exercise of primacy always is. And the role of the Mighty Wurlitzer, as we can now appreciate, is indispensable across the entire spectrum of social engineering to get people to consent to what is happening to them! Please refer back to the statements made by Aldous Huxley in his talk in 1961 quoted above: **“*Well, it seems to me that the nature of the Ultimate Revolution with which we are now faced is precisely this: that we are in process of developing a whole series of techniques which will enable the controlling oligarchy who have always existed and presumably always will exist, to get people actually to love their servitude!*”**

The perpetual 'war on terror' is not mere happenstance and over-reaction to catastrophic terrorism as some of empire's leading detractors too *innocent of knowledge* gullibly argue. The evidence presented here demonstrates it to be diabolically premeditated in no less a measure than the Third Reich's march to *Lebensraum* after the full disclosure of their intent in Mein Kampf. In both cases, the public had to be mobilized since **“*Democracy is inimical to imperial mobilization.*”** In our case, *Lebensraum* is world government, and as

reasoned by Bertrand Russell, ***“World government could only be kept in being by force.”*** (Bertrand Russell, *Impact of Science on Society* Ch. 2, pg. 37)

The Hegelian Dialectic Militant Islam vs. Moderate Islam will surely go down in history as among the greatest enablers of war, rivaling and perhaps surpassing both Communism vs. Fascism and Communism vs. Capitalism of the twentieth century. It is their legatee for the twenty-first century. As previously noted, it is already called “World War IV”. The blood stains accumulated on all the saintly hands enabling it, as of those prosecuting it, won't be cleansed by all the perfumes of Arabia while they sleep holily in bed! (Shakespeare Macbeth) Fortunate are those who at least experience PTSD and can't sleep holily in bed (see Zahir Ebrahim, [Letter: A Cure for America's War Veterans who have fertilized the 'arc of crisis' in Muslim blood](#)).

The Hegelian Dialectic Militant Islam vs. Moderate Islam however is still designed to play a multifaceted role beyond the prima facie one of each of its individual components.

The mantra of “reform Islam” is the more pernicious of the two. While “militant Islam” has seditiously enabled police states in the West which all can experience themselves without having to read about it, “moderate Islam” is intended to enable the new world religion for these police states which few among the public are able to apprehend just yet.

Many useful idiots who play their role like actors on stage, some believing in the promise of “moderate Islam”, have little understanding of the entire show, their script only being for Act II. Act I was obviously “militant Islam” in this Hegelian Dialectic.

Acts III and IV which are coming up next after the intermission for which the stage is now being set, is to harvest the calculated subversion of all established religions, specifically the religion of Islam, to pave the way for the introduction of Secular Humanism – the new religion of world Government (see [Islam vs. Secular Humanism and World Government](#)).

**Full Spectrum Primacy** is the underpinning of all power calculus. Be it of the State, just the full title of Zbigniew Brzezinski's aforementioned book betrays what's already obvious: **“The Grand Chessboard – American Primacy and Its Geostrategic Imperatives”**. Or be it of the controlling oligarchy, which is also already obvious, and for which books upon books of respected scholars like Professor Carroll Quigley's **“Tragedy and Hope”** disclose their overarching agenda being world government.

Empiricism confirms these facts.

## **The Hegelian Dialectic of Dissent**



Having now perceptively understood the subtle, almost undetectably precise imperial craftsmanship of Bernard Lewis et. al., which forms the crucial seed for implanting the **“doctrinal motivation and intellectual commitment”** necessary for sustaining **“imperial mobilization”** via the Hegelian Dialectic “militant Islam” vs. “moderate Islam”, it should not be surprising to discover that even the steward of public conscience for the West, Noam Chomsky, judged Bernard Lewis to be **“just a vulgar propagandist”!**

In a revealing interview on CBC, at just about that time:

**'... now, until Bernard Lewis tells us that, and that's only one piece of a long story, we know that he is just a vulgar propagandist and not a scholar.** So yes, as long as we are supporting harsh brutal governments, blocking democracy and development, because of our interest in controlling the oil resources in the region, **there will be a campaign of hatred against us!** --- Interview to Evan Solomon, CBC, part-2, minute 5:50, December 9, 2003,

But in furthering our forensic and critical study of the Dynamics of Mantra Creation solely on the anvil of empirical political science, it is even more instructional to observe the omissions and commissions in Noam Chomsky's own vaunted dissent as *“arguably the most important intellectual alive”* (NYT). The disease of deception is evidently infectious among that clan.

Noam Chomsky himself continued to echo from the very day of September 11, 2001, and still maintains so in this tenth year of 9/11, that Osama Bin Laden and Al Qaeda carried out that *day of infamy* upon which all matters 'War on Terror' hinge!

Thus, strangely enough, despite all his famous dissent, Noam Chomsky has exactly managed to echo Bernard Lewis', Samuel Huntington's, the Pentagon's, the White House's, the incumbent as well as all living former presidents of the sole superpower, the Israelis', and the world Zionists' collective mantra of “Islamofascists” being the perpetrators of 9/11.

Noam Chomsky is of course, also the most outspoken champion of Wikileaks in his otherwise erudite disagreements with his opposite numbers in the establishment.

All this public fracas of dissent against the establishment is somewhat akin to the American and Russian spies strategically collaborating with each other despite their often antagonist tactical missions, for the greater common good of the military-industrial complexes of both nations during the Cold War. When we perceptively read the works of Anthony Sutton,

Carroll Quigley, and W. Cleon Skousen, it becomes obvious that the uber-capitalists and the uber-communists were in fact covertly collaborating at crucial core nexuses despite all their overt *WWF wrestling* style public antagonisms. Both serving the interests of the same financiers. In other words, at the highest levels of social control, there is evidently no difference of overarching agendas among its seemingly antagonistic players, each one of them merely playing a theatrical public role. Shakespeare aptly dramatized it in *As you like it*:

'All the world's a stage,  
And all the men and women merely players:  
They have their exits and their entrances;  
And one man in his time plays many parts,  
His acts being seven ages.'

It should now be self-evident that Bernard Lewis and Noam Chomsky together, while seemingly cogent opposites, in fact represent the class of counterpoint tunes of the Mighty Wurlitzer which nicely bookend all public discourse between the artificial bifurcation of Right and Left, Conservative and Liberal, Establishmentarian and Rebel, Totalitarian and Anarchist, Consent and Dissent. It is the two antipodes of a fabricated Hegelian Dialectic to respectively engineer both consent and dissent in order to sustain "imperial mobilization".

Noam Chomsky himself argues the veracity of this observation in his own erudite manner:

'The smart way to keep people passive and obedient is to strictly limit the spectrum of acceptable opinion, but allow very lively debate within that spectrum - even encourage the more critical and dissident views. That gives people the sense that there's free thinking going on, while all the time the presuppositions of the system are being reinforced by the limits put on the range of the debate.'

and yet, he just as willingly participates in it.

Thus, observe that Chomsky too echoes that there is a 'Muslim Rage', but instead of it being deemed "irrational" like Bernard Lewis posits in his "vulgar propagandist" scholarship, Noam Chomsky calls it a rational rage, a "blowback" to American foreign policy and the history of American political aggression! See Chomsky's money minting booklet "911" by Seven Stories Press; and how it was cobbled together in "[The Closet Capitalist](#)", where the Hoover Institution critic observed: "*Chomsky's marketing efforts shortly after September 11*

*give new meaning to the term war profiteer. In the days after the tragedy, he raised his speaking fee from \$9,000 to \$12,000 because he was suddenly in greater demand.”*

While dissent which retains the core-lies of empire when vehemently critiquing its effects is typical of all prominent controlled assets, in this instance of “*arguably the most important intellectual alive*”, it would perhaps be more apropos to give it the same epithet that Noam Chomsky anointed Bernard Lewis with. Just to call a spade a spade – and no more.

Who else echoes that same “vulgar propagandist’s” core-lie of empire, of 9/11 being invasion from abroad and the work of “militant Islam”, in deep consonance with Bernard Lewis, the Pentagon, the White House, and the neo-con think-tankers? Surprise, surprise, it is the other patron saint of latter day dissent, Congressman Ron Paul, echoing exactly Noam Chomsky’s theme of 9/11 being a “blowback” by malcontent Muslims. Ron Paul’s absurdities are dismantled in [My beef with the stellar congressman Hon. Ron Paul](#).

As a Muslim, I hope I might be forgiven if I observe some ground floor reality check to put all this specious “blowback” in hegemonic context. I don’t see any such naturally percolating “blowback” rage in any significant tenor in any Muslim country despite what the white man’s burden has done to us worldwide, except perhaps in the three nations militarily occupied by Israel and the United States today, Palestine, Iraq, and Afghanistan. Even there, all I see are some manufactured “insurgents” being “tickled” into expressing a manufactured rage on demand. This is deconstructed in great detail in the two comprehensive reports [Manufacturing Dissent](#) and [Insurgency vs. Counter-Insurgency](#) (<http://tinyurl.com/what-is-insurgency> ).

Suffice it to expose here this sham of “blowback” very briefly. The Director of the CIA, Michael Hayden, openly expressed the empire’s modus operandi of “tickling” terrorists into existence thusly: “**We use military operations to excite the enemy, prompting him to respond. In that response we learn so much**”. When the poor victims and their unfortunate survivors are thus sufficiently “*tickled*” with the inconsolable loss of their loved ones under the world’s mightiest superpower’s barbaric “*shock and awe*”, they become prime harvest for empire’s other long running mantra, “**God is on your side**” (where God changes sides at will as expedient – see [Islam and Knowledge vs. Socialization](#) for details).

That harvest of malcontents is managed by local intelligence handlers and the Pentagon’s Black-ops, to steer the “tickled” patsies natural lust for justified revenge on the aggressors onto pre-selected local targets. The US Army field manual cited above is apropos to quote once again as a reminder that this is indeed how the world of hegemony actually works and this report on the Mighty Wurlitzer isn’t a James Bamford novel: “*US Army Intelligence*

*must have the means of launching special operations which will convince host country governments and public opinion of the reality of the insurgent danger ... **US Army Intelligence should seek to penetrate the insurgency by means of agents of special assignments, with the task of forming special action groups among the most radical elements of the insurgency.***”

Running false-flag operations in this way by setting up diversionary suicidal patsies harvested from “*among the most radical elements of the insurgency*”, while the more precision oriented lethal hit is handled covertly by the skilled Black-Ops, becomes a breeze. This is of course the empiricism of all major assassinations of political leaders worldwide – compartmentalized disposable patsies independently working on narrow tasks for a common boss, often unbeknownst to each other. That is the prime modus operandi to fabricate the terrorist acts – called “insurgency”. That's the sum total of the “blowback” of vaunted dissent narrators like Ron Paul and Noam Chomsky, and the new dissent chiefs like Paul Craig Roberts who, after having his fill of 900 mice, now wants to lead the mice against the primacy of the feline predators (see Zahir Ebrahim, [Rebuttal to Paul Craig Roberts](#): 'Washington Arrogance has Fomented a Muslim Revolution').

Once the “insurgency” is crafted, the organs of state, the military, the police, the intelligentsia, the media, the pundits, all across the world all naturally focus on the visible terrorist act of these patsies and their poor victims! Since that is all that the public is permitted to see by the Mighty Wurlitzer, the empire's next move is naturally sanctioned. That is called “counter-insurgency”. Some call it invasion and occupation. That is also the mechanism of the super-terrorism of 9/11 in a nutshell – diversionary tactics employed as shadow play which was propagandized by the Mighty Wurlitzer worldwide, while the WTC towers were expertly and with military precision brought down with controlled demolition of some kind. The intimate dynamics of mid-wifery between insurgency and counter-insurgency can sustain “*imperial mobilization*” indefinitely!

See [Zahir Ebrahim: Between Imperial Mobilization and Islamofascism](#) and [FAQ: What is an Intellectual Negro](#) for the role played by the villainous Muslim House Negroes in promoting the hectoring hegemon's own propaganda, vs. the pathetic ground realities of the Muslim masses, the so called “revolutionaries”, in the [Preface to Prisoners of the Cave](#), all very patiently *waiting for Allah* for deliverance!

## Mining Propaganda to Uncover Agenda BEFORE it is a Fait Accompli

Returning back to the “vulgar propagandist” (I keep that epithet in quotes deliberately to emphasize the fact that apart from its veracity, it's also the product of *WWF wrestling*), we already see the empirical results of the uncannily predictive clairvoyance of America's and Israel's greatest establishmentarians concerning 'Islamic Terror' which goes by many names including “blowback”.

The fate of Afghanistan, Iraq, Pakistan, the entire Middle East, the “*arc of crisis*” and the “*global zone of percolating violence*”, all have something real in common today because of such amazing fortune telling by the masters of discourse years in advance: **“the peoples of Islam will be the first and greatest victims.”** Please refer back to the already mentioned report: [Instrumenting Kosovo in the 'arc of crisis' and the 'global zone of percolating violence'](#).

So, ought the public to take the superlative masters of discourse and the assorted “vulgar propagandists” a tad more seriously when they initially spew new absurdities enroute to successful mantra creation years in advance? And, before its eventual harvesting under the cataclysmic shock-effects of the “new pearl harbor”, makes their predictive boast: **“They will not be alone, and many others will suffer with them”**, an unalterable grotesque reality?

One of course already observes some of that Bernard Lewis' sponsored clairvoyant suffering of the innocent in America itself. While its own body-count is minuscule in comparison to Iraq, Afghanistan, Pakistan, others experiencing 'revolutions' and 'democracy' in the Middle East, not to mention PTSD suffered by its veterans which too pales in comparison to what the valiant have wrecked upon the 'untermenschen' (see [Letter to Editor: PTSD and its Cure](#)), one with eyes wide open substantially notes that:

- the American national debt is soaring because of its perpetual 'War on Terror' and the financial malfeasance of its financial elite;
- its bankruptcies and joblessness have shattered the 'American Dream' of its public;
- its de-industrialization by having off-shored all its manufacturing and production capacity is at an all time peak;
- the mighty superpower is now a police-state the likes of which was hitherto only presaged in fictional narratives like George Orwell's 1984;

- and the once mighty industrial nation may be merged into a larger supra-national regional entity similar to the EU as a consequence of all these crises conditions.

Can one therefore, perceptively not surmise that the deceased Ali Baba's replacement nemesis will be a *Super Ali Baba Plus Plus* to complete the job started by Zbigniew Brzezinski and Israeli Intelligence agents' clairvoyance? What can this new threat possibly be that it will even eclipse Osama Bin Laden in his magical prowess?

Can the public shrewdly anticipate and prepare for the next boogeyman based on the tunes now being played by the Mighty Wurlitzer, rather than be shell-shocked into acquiescence by its phantasmic unveiling? Just as the world was, and still is, shell-shocked into acquiescence due to the Catastrophic Terrorism of 9/11 which, like the Pearl Harbor, inevitably divided our past and our future into 'before' and 'after'.

One often hears it stated in the news and in the Western governments' increasingly draconian regulations to keep their public safe from terrorists, that 9/11 changed everything. Well, the super 9/11 of the Super Ali Baba Plus Plus so clairvoyantly predicted by George W. Bush, ***“will make Sept. 11 pale by comparison”*** (Bush White House, Feb. 13, 2008)!

Can one intelligently not data-mine propaganda itself, in the backdrop of the Mighty Wurlitzer's unhidden motivations and agendas, to accurately perceive and preempt what's up next?

The following passage from the 2500 years old Art of War is pertinent backdrop to the aforementioned chutzpah of empire – a zeitgeist in which the scholars of empire announce their intentions brazenly years in advance, while the detractors of empire excel in the ex post facto narrations of what is already a fait accompli after the *“history's actors”* have acted and created *“new realities”*. The instruments of empire award their own antagonists high honors and great accolades for their bold rehearsal and dissection of histories amidst the fawning adulation of all their followers having their new 'ah hah' and 'never again' moments for the first time in their life. And the cycle repeats again and again for each new act of the *“history's actors”*:

'8. To see victory only when it is within the ken of the common herd is not the acme of excellence.

9. Neither is it the acme of excellence if you fight and conquer and the whole Empire says, "Well done!"

10. To lift an autumn hair is no sign of great strength; to see the sun and moon is no sign of sharp sight; to hear the noise of thunder is no sign of a quick ear.'

Paying particular attention to item 10., one may conclude that to perceive and anticipate in a timely manner that which is not obvious to others leads to many tactical as well as strategic advantages, both in the battle of hegemony and secrecy, and, in the battle against tyranny. Which is why the public and their lauded dissent chiefs are always, but always, kept busy in idiotic puppetshows by the Machiavelli when it is most essential that they be shrewdly sighted.

Public preemption can be effective in derailing imperial mobilization only BEFORE it becomes a fait accompli. Ex post facto, when the public eventually wakes up to ascertain that it was indeed all a puppetshow, it is inevitably too late to do anything about the matter except to “study” what the “history's actors” have left behind! Obsessing with the previous fait accompli when dissent chiefs lead the effort, evidently, is also a calculated part of Machiavelli. The principle of temporal urgency in maintaining utmost deception (and secrecy) while “*new realities*” are being planned, orchestrated, and harvested, was articulated by Niccolò Machiavelli in The Prince. The modern day version of this predatory statecraft is the National Security Council Directive NSC 10/2 for creating cover stories and red herrings alongside covert operations. See Anatomy of Conspiracy Theory ( <http://tinyurl.com/cognitive-diversity> ).

As part of that plan to deflect public attention, those attempting to see through its fog of deception when a fait accompli can still be averted – before missiles have left their silos, before pen has been put to tortuous legalisms to sanction tyranny – are variously labeled as 'kooks', 'conspiracy theorists', 'delusional', 'denier', etc., their efforts infiltrated and subverted (as in cointelpro), and their energies defocussed by introducing what's cynically called “*beneficial cognitive diversity*” (see Cass Sunstein, and this counterpoint to dissent-chief David Ray Griffin's “eureka” moment on Cass Sunstein's “Conspiracy Theories”).

### **So What's Next according to Project Humanbeingsfirst?**

The Alien-UFO Agenda is one such future fait accompli in the works which can still be averted by the public becoming rationally informed about the demonic art of the Mighty Wurlitzer. The fact that:

- references to UFOs even made it into one of Wikileaks whistleblowing disclosures ;

- the fact that the FBI recently made available a 1950 Roswell UFO memo lending “UFOs” a legitimacy in the gullible mind by way of it being held as a supposed “state-secret” for these past sixty years ;
- the fact that US military is even playing war-games to interdict UFOs (USAF couldn't interdict 9/11 airplanes and are therefore determined, one surmises, to not fail against an alien UFO technology that is advanced enough to visit earth from another galaxy) ;
- the fact that there is a pertinent office at the United Nations, UNOOSA, with *“the plan to make Unoosa the co-ordinating body for dealing with alien encounters [which] will be debated by UN scientific advisory committees and should eventually reach the body's general assembly”*, and a special UN Ambassador has been *“tasked with co-ordinating humanity's response if and when extraterrestrials make contact”* ;
- and the uptick in other bogus and absurd conversations on Aliens and UFO even appearing in the mainstream media, not to mention its unrelenting repetition in the so called “alternate media” and on the internet ;

all indicate that its unveiling time is likely approaching near.



Caption The Next Global Threat? A Super Ali Baba Plus Plus to Terrify Mankind With? (The U.S. Air Force first began experimenting with flying saucers in the 1950s. Why - to deceive the former USSR, or, to induce global mass panic? See Hadley Cantril )



The reaction to this super nemesis too will surely also be launched with “***either you are with us, or with the aliens***” false dialectics!

If the public can preempt that propoganda by focussing on unraveling the many facets and scenarios on what they Machiavellianly plan to do BEFORE they enact them, the vile psy-ops can surely be defeated BEFORE it becomes the new established “facts” on the ground for the globalists' coup de grâce: **the final restructuring of the planet into world government** ( <http://tinyurl.com/ftworldgov>).

In order to perceptively engage the sophisticated finesse behind all this psychological mind-fck before it becomes fait accompli, please see: [Letter to Kerry Cassidy on the Alien-UFO Agenda](#) and [The Agenda Behind Aliens and UFOs - A Hegelian Mind-Fck Part-II](#) ( <http://tinyurl.com/Aliens-UFOs> ).

**The Mighty Wurlitzer Cultivating the Next Hegelian Mind-Fck: A Super Ali Baba++ to Seed the Clash of Planets**



Caption Earth must prepare for close encounter with aliens, say scientists UN should co-ordinate plans for dealing with extraterrestrials – and we can't guarantee that aliens will be friendly Evolution on alien worlds is likely to be Darwinian, which may mean extraterrestrials share our tendencies for violence and exploitation. (Image via UK Guardian Photograph: Rex)

Caption Earth must prepare for close encounter with aliens, say scientists UN should co-ordinate plans for dealing with extraterrestrials – and we can't guarantee that aliens will be friendly Evolution on alien worlds is likely to be Darwinian, which may mean extraterrestrials share our tendencies for violence and exploitation. (Image via UK Guardian, 10 January 2011 Photograph: Rex)

**Using State-Secrets For Myth Fabrication**

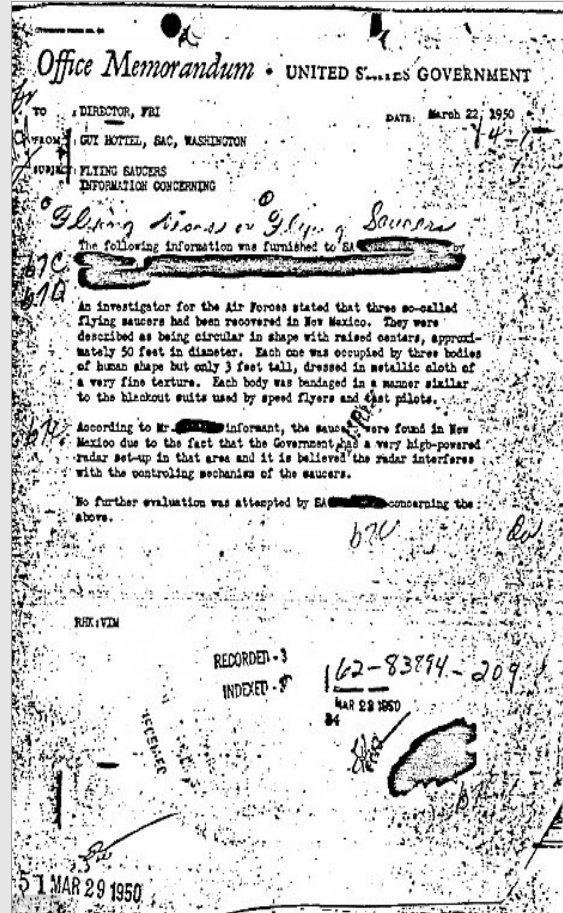

Caption 'Proof of (alien) life? A copy of the 1950 memo that recounts the discovery of flying saucers and aliens in New Mexico. The memo has been published on the FBI website' --- UK Daily Mail 9th April 2011.

A more perceptive caption however would read: **'The Art of the Mighty Wurlitzer: How to fabricate Aliens and UFOs Myths using the ploy of leaking State-Secrets'**

**President Ronald Reagan Ponders The Beneficial Consequences of an Alien Threat from Another Planet, Speaking at the UN General Assembly, Sept. 21, 1987**



***“If suddenly there was a threat to this world from some other species from another planet,”*** President Ronald Reagan had read out loud from his script at the United Nations General Assembly podium in 1987, ***“in our obsession with antagonisms of the moment, we often forget how much unites all the members of humanity. Perhaps we need some outside universal threat to make us recognize this common bond. I occasionally think how quickly our differences worldwide would vanish, if we were facing an alien threat from outside this world!”*** --- President Ronald Reagan, Speaking at the UN General Assembly, September 21, 1987

**National Geographic Channel catches up with Reagan Show Ponders The Possibility of an Alien Attack**



***“It should be as statistical as human nature, for example, that there's going to be good guys and bad guys,”*** says Dr. Travis Taylor, who's with the U.S. Space and Missile Command Department and has worked with the Department of Defense and NASA for 20 years.

***“What we would hope is that the good guys show up first, and that would be really nice. But the point of this wasn't to debate whether they are or they aren't, it's what happens if they did. Do we have a plan? What type of plan should we put together, and how would we defend the planet?”*** Taylor has also written the handbook for harrying aliens, *An Introduction to Planetary Defense*.

Lt. Col. Brian De Toy, director of defense and strategic studies program at West Point, doesn't buy the premise. ***“I am a skeptical believer in miracles. So a year ago right now I was in Iraq, and I'm more worried about Iraq and Afghanistan right now and the aliens that I'm dealing with there. And so right now, I'm pretty skeptical about the others.”*** --- National Geographic, Reported by Boston Herald May 17, 2011

**Using absurdities For Propaganda Fabrication: Pope's astronomer says he would baptise an alien if it asked him**

**'Aliens might have souls and could choose to be baptised if humans ever met them, a Vatican scientist said today.** The official also dismissed intelligent design as “bad theology” that had been “hijacked” by American creationist fundamentalists.

Guy Consolmagno, who is one of the pope's astronomers, said he would be “delighted” if intelligent life was found among the stars. “But the odds of us finding it, of it being intelligent and us being able to communicate with it – when you add them up it's probably not a practical question.”

Speaking ahead of a talk at the British Science Festival in Birmingham tomorrow, he said that the traditional definition of a soul was to have intelligence, free will, freedom to love and freedom to make decisions. **“Any entity – no matter how many tentacles it has – has a soul.”** Would he baptise an alien? **“Only if they asked.”**  
--- [UK Guardian 17 Sep 2010](#)

**UN 'to appoint space ambassador to greet alien visitors'**

'Mazlan Othman, a Malaysian astrophysicist, is set to be tasked with co-ordinating humanity's response if and when extraterrestrials make contact. Aliens who landed on earth and asked: **“Take me to your leader”** would be directed to Mrs Othman. ... But Professor Stephen Hawking has warned that alien interlopers should be treated with caution. He said: **“I imagine they might exist in massive ships, having used up all the resources from their home planet. The outcome for us would be much as when Christopher Columbus first landed in America, which didn't turn out very well for the Native Americans.”** --- [UK Telegraph 26 Sep 2010](#)

## The Psychology of Fear

In order to perceptively comprehend the psychological basis of such absurd and fabricated threats which instill existential fears:

- whose import to enabling “*imperial mobilization*” was clearly envisaged by Zbigniew Brzezinski in 1996 in *The Grand Chessboard*:

“It is also a fact that America is too democratic at home to be autocratic abroad. This limits the use of America's power, especially its capacity for military intimidation. Never before has a populist democracy attained international supremacy. **But the pursuit of power is not a goal that commands popular passion, except in conditions of a sudden threat or challenge to the public's sense of domestic well-being.** The economic self-denial (that is defense spending), and the human sacrifice (casualties even among professional soldiers) required in the effort are uncongenial to democratic instincts. **Democracy is inimical to imperial mobilization.**” (pgs. 35-36) ;

- whose raison d'être as the primary method for advancing “*the "national interest" by means of organized violence*”, was taken as axiomatic in the 1963-64 secret study reported in the 1967 book *The Report From Iron Mountain*:

“It must be emphasized that the precedence of a society's war-making potential over its other characteristics is not the result of the "threat" presumed to exist at any one time from other societies. This is the reverse of the basic situation; **"threats" against the "national interest" are usually created or accelerated to meet the changing needs of the war system.** ... The military, or ostensible function of the war system requires no elaboration; it serves simply to defend or advance the "national interest" by means of organized violence. **It is often necessary for a national military establishment to create a need for its unique powers—to maintain the franchise, so to speak.** And a healthy military apparatus requires "exercise," by whatever rationale seems expedient, to prevent its atrophy.” (pgs. 31,33) ;

- whose utility for effectively embarking on the “*military transformation*” required to achieve “*full spectrum dominance*” that wasn't “stillborn”, was openly declared in the Project for the New American Century (PNAC) report titled *Rebuilding America's*

### Defenses:

“Further, the process of transformation, even if it brings revolutionary change, is likely to be a long one, **absent some catastrophic and catalyzing event – like a new Pearl Harbor. ... Until the process of transformation is treated as an enduring military mission – worthy of constant allocation of dollars and forces – it will remain stillborn**” (pgs. 51,58) ;

- and whose necessity for rapidly transforming an entire society, nation, or the whole world, in the direction desired by the controlling oligarchy, was even discovered in the 1908 minute books of the Carnegie Endowment for Peace by the Congressional Reece Committee investigator Norman Dodd in 1954, and related by him in an interview before his death in 1982, *The Hidden Agenda of Tax Exempt Foundations for World Government:*

“We are now at the year 1908, which was the year that the Carnegie Foundation began operations. In that year, the trustees, meeting for the first time, raised a specific question, which they discussed throughout the balance of the year in a very learned fashion. **The question is: “Is there any means known more effective than war, assuming you wish to alter the life of an entire people?” And they conclude that no more effective means than war to that end is known to humanity.** So then, in 1909, they raised the second question and discussed it, namely: 'How do we involve the United States in a war?’” ;

please refer to social engineering principles in Further Study for Operation Gladio, Edward Bernays, Human Resources, and The Prisoner television series episode “It's your funeral”. Also see Myth of the Cave in Plato's 2500 years old classic *The Republic*, Book VII, page 300 (book PDF).

### **Closing Arguments**

There is a lot to learn here on deliberate Machiavellian social engineering that is not taught even in the best universities in America (and the West), nor ever makes an appearance on CNN Headline News (and Time or Newsweek)!

What we are speaking of here, of engineering the consent of the masses to get them to love their own servitude, far transcends the corporate advertising and marketing techniques

taught in MBA programs which were principally pioneered by Edward Bernays. These techniques of course also attempt to bypass the cognitive mind and target manipulating the subconscious mind directly to sell a product, a lifestyle, or an idea.

## PROPAGANDA REDUX

### ASK YOURSELF TO TEST YOUR UNDERSTANDING OF WHAT YOU HAVE JUST LEARNED

Is it not strange that the US Military is openly playing “war games” for the absurd possibility of an Alien Attack within just 25 years of President Ronald Reagan expressing the *Beneficial Consequences of a Hypothetical Alien Threat From Outside This World* speaking at the UN General Assembly, Sept. 21, 1987? Is it not absurd that they even appoint a UN Ambassador to greet the aliens with “souls” *seeking to be baptised* when they ask earthlings in English “Take me to your leader” (sic!)?

What motivation drives the Hard Road to World Order which continually requires crafting new fabled threats, new absurdities, new wars, new crises?

Fabricating a public discourse on an absurd fantasy as if it's something real by couching it in the veneer of science (or declassified State-Secrets/whistleblowing) and then reacting to that invention at supra-national levels from the United Nations to the Catholic Church, only legitimizes such discourse thus setting the stage for the later creation of a new insurmountable global threat, the Clash of Planets. If political scientists are to be believed on the utility of diabolical protocols for “*imperial mobilization*”, then, “*that exercise requires a high degree of doctrinal motivation, intellectual commitment, and patriotic gratification.*” Its doctrinal seeds must be planted years in advance. This too will surely also be launched with “*either you are with us, or with the aliens!*” --- The Agenda Behind Aliens and UFOs.

With Osama bin Laden officially retired as Enemy No 1 on May 1, 2011, does it require a Cassandra to foretell What's Next? Please see What's next after Osama Bin Laden?. Can we arm ourselves with perceptive wisdom such that we aren't fooled into 'United We Stand' with absurdities again and again? Please see Letter to Kerry Cassidy on the Alien-UFO Agenda.

If still unconvinced about the overarching motivation for all this Hegelian mind-fck – WHY do they convince you of fearful absurdities – please read Zahir Ebrahim: Of Ostriches and Rebels on The Hard Road to World Order.

However, while most recognize that advertising is a multi-billion dollar business and accept it as a matter of for-profit corporate modernity, few are aware of an order of magnitude more resources being perversely spent by tax-exempt foundations, and the tax-payers (quite unbeknownst to themselves of course), on far more diabolical aspects of social



engineering for **“getting people to consent to what is happening to them. Well, it seems to me that the nature of the Ultimate Revolution with which we are now faced is precisely this: that we are in process of developing a whole series of techniques which will enable the controlling oligarchy who have always existed and presumably always will exist, to get people actually to love their servitude!”** (please once again refer to Aldous Huxley quoted at the very beginning to refresh your memory that I haven't made all this up)



Advertising Age's 2008 Marketer of the Year award to President Obama for his election campaign of the “Change” mantra, and the Nobel committee's awarding him the 2009 Nobel Peace Prize testify to the empiricism of this observation. The American nation easily bought that fiction of “Change”, which was once again underscored by President Obama bombing Libya on the same day in 2011 that his predecessor bombed Iraq in 2003!

How did the American public buy that fiction? Once again, please refer back to the very beginning of this report and to Edward Bernays: **“We are governed, our minds are molded, our tastes formed, our ideas suggested, largely by men we have never heard of.”**

Only a tiny handful in America did not buy that fiction. Among those handful who defied the wisdom of the entire American nation and their controlled dissent chiefs, see: Not-Voting is a 'YES' vote to Reject a Corrupt System which thrives on the facade of Elections and Democracy! And Mr. Obama – The Post Modern Coup.

This ignorance and gullibility among the college-educated modern public is despite the fact that Western academe is at the forefront of the vast majority of behavior control and social engineering research studies, often funded by, or in collaboration with, Western intelligence, military, and private tax-exempt foundations such as the Rockefeller Foundation, Carnegie Endowment, and Ford Foundation. The highly compartmentalized nature of such research ensures that few students and professors in on the ground breaking studies into human behavior can ever glean the bigger picture towards which they work so diligently to respectively earn their Ph.D. and research funding! Those few who do comprehend are invariably engaged with empire in the largely unhidden orchestration of social engineering. Or, are quickly recruited as agents and assets of the Mighty Wurlitzer.

Mighty Wurlitzer has no limit for its territory. The newsmedia, entertainment, academe, political parties, religious institutions, think-tanks, private foundations, government-funded organizations, and non-governmental organization (NGOs) alike, all house its agents and



assets. And they each play their own tunes on their own specialized instruments under the supreme conduction of the Mighty Wurlitzer. The most notable among these is religion. Although the layman does not normally associate the pastor, rabbi, alim, mullah, swami, etc., with propaganda organs of state, but religion is in fact the most affected by the Mighty Wurlitzer – all throughout history. If we just reflect on the fact that more than three quarters of the world's people espouse some faith, the easiest cognitive infiltration and behavior control is directly through faith. The report: Islam and Knowledge vs. Socialization ( <http://tinyurl.com/Islam-Socialization> ), and the following challenge to a pious Muslim cleric who issued a 600-page Fatwa on Terrorism in the Service of Empire ( <http://tinyurl.com/Fatwa-Terrorism-Qadri> ), indubitably illustrate this universal fact.

Today, fact and fiction have been merged to such an alarming degree with adept perception control that to be able to rationally separate them, to tell what is mere imagery of the Mighty Wurlitzer vs. the actual interconnected causal reality (cause and effect) of statecraft, can be as uncongenial to the cognitive mind as depicted by Plato for the prisoners bred in the underground cave since birth. The fact that the most brilliant minds remain unable to tell that 9/11 was an 'Operation Canned Goods' even ten years into its vile enactment while America descends into a police-state in presumed reaction to it, demonstrates that it is not the brain hardware which is malfunctioning, but the brain software!

The inculcation of belief in authority figures and “experts” has reached pandemic proportions in the West. Indoctrination is today perhaps the greatest public plague afflicting the mightiest superpower on earth, a direct consequence of “dumbing down” the public in the name of higher education to craft self-obsessed economic widgets, narrow specialists, and superficial generalists for the Technetronic Era. The continued success of the Mighty Wurlitzer in “persuading” the public to accept absurdities to get them 'United We Stand' singularly relies on, and feeds off, this aspect of modernity. See The Ivy League Morons Syndrome. Also see the deconstruction of Bernard de Mandeville's “The Fable of the Bees” in The Seduction of Science and Technology.

There is an undeniable categorical imperative before the Western peoples today. With the escalating belligerence towards Iran and the strategic dismantling of Pakistan palpably on the visible horizon, will the profoundly ***innocent of knowledge*** in the West allow themselves to be fooled once again into more criminal aggression upon civilian populations in the name of 'war on terrorism'. Or, will the people choose to not be (willingly) deceived by the Mighty Wurlitzer's many ruses at every level which continually justify the core axioms of “imperial mobilization” by way of deception? See Peoples' Guilt and America's Profound Shame ( <http://prisonersofthecave.blogspot.com/2007/04/preface.html#Americas-Profound-Shame> )

Shame ).

It is precisely to invoke that *acquiescence* to premeditated fait accompli that Zbigniew Brzezinski self-servingly quoted in the opening pages of his seminal 1970 book *Between Two Ages – America's Role in the Technetronic Era*, the following specious rationalization for the turmoil to be purposely inflicted upon the 'lesser' humanity. The diabolically fabricated Hegelian Dialectic as the means to usher in *one-world government*, and attributing that manufactured zeitgeist to just the nature of transformation between two ages (for which nothing could be done about since the human misery which it entailed was natural and inevitable):

*"Human life is reduced to real suffering, to hell, only when two ages, two cultures and religions overlap. . . . There are times when a whole generation is caught in this way between two ages, two modes of life, with the consequence that it loses all power to understand itself and has no standard, no security, no simple acquiescence."* --- HERMANN HESSE, *Steppenwolf* (Iede quote by Zbigniew Brzezinski in *Between Two Ages*, pg. 7, [book PDF](#)).

As an establishmentarian hectoring hegemon, Brzezinski again invoked the same sort of self-serving rationalization to perpetuate *American Primacy and Its Geostrategic Imperatives*. He began his subsequent 1996 book *The Grand Chessboard* with the chauvinist sentence: **"Hegemony is as old as mankind."** Thus, by the logic of it, making the rest of the book a recipe for the exercise of America's uniquely unchallenged global power, and **"especially its capacity for military intimidation"**, as the most natural human legacy for any supremacist nation to pursue. Nothing could, or ought, to be done about that predatory instinct for organized violence since *"Hegemony is as old as mankind."* And therefore, Brzezinski naturally proffered in his chauvinist conclusion, **"In brief, the U.S. Policy goals must be un-apologetically twofold: to perpetuate America's own dominant position for at least a generation and preferably longer,..."** (Ibid., pg. 215; see [Prisoners of the Cave, Chapter 1](#) ).

The report [Of Ostriches and Rebels on The Hard Road to World Order](#), examines how that specious recipe book for America's predatory primacy, as syntactically sugared war-mongering as it is, is itself only half the truth. As the Jewish proverb suggests, *'a half truth is a full lie'*. And as the Mighty Wurlitzer knows, in order to be effective, **the lie is different at every level.**

Contrary to Zbigniew Brzezinski's erudite prose which underlies the many compositions of

the Mighty Wurlitzer, as the generation caught between two ages on the Grand Chessboard, we, the bearers of “*Human life*”, have neither lost the power to “*understand*”, nor lost the power to overturn the coercive “*simple acquiescence*” to artificially induced transition period of “*real suffering*”. That understanding, and overturning, is the *raison d'être* for this document.

When *Primacy and Its Geostrategic Imperatives* to orchestrate a *one-world government* is the ingrained doctrine among the 'ubermensch' and their instruments, it is trivial to come up with any logic, any rationalism for even the most atrocious barbarism inflicted upon the 'untermenschen'. Convince the public of absurdities and one can get them to acquiesce to any atrocity – from outright murderous invasion of other nations to torturing their civilians in the most horrendous conditions, to getting their own citizens to accept giving up their civil liberties without a sigh. Nothing new here – 'standard 007 issue' of the hectoring hegemons! That same Mighty Wurlitzer and its paymasters however would be chewing on cyanide capsules in another situation. It is best not to forget that. Baboons wear no clothes – even when they steal the sunglasses.

### **Further Study**

*For further study guide please refer to the Further Study Section in Note on Mighty Wurlitzer ( <http://tinyurl.com/mightywurlitzer> ).*

**Short URL:** <http://tinyurl.com/mightywurlitzer>

**Source URL:** <http://print-humanbeingsfirst.blogspot.com/2009/05/note-on-mighty-wurlitzer.html>

First Published May 31, 2009

## Chapter 3 World Order is World Government

### Of Ostriches and Rebels on The Hard Road to World Order



Gideon Rachman of the Financial Times wrote in his oped almost two years ago:

'I have never believed that there is a secret United Nations plot to take over the US. I have never seen black helicopters hovering in the sky above Montana. But, for the first time in my

life, I think the formation of some sort of world government is plausible. A "world government" would involve much more than co-operation between nations. It would be an entity with state-like characteristics, backed by a body of laws. The European Union has already set up a continental government for 27 countries, which could be a model. The EU has a supreme court, a currency, thousands of pages of law, a large civil service and the ability to deploy military force. So could the European model go global? There are three reasons for thinking that it might. First, it is increasingly clear that the most difficult issues facing national governments are international in nature: there is global warming, a global financial crisis and a "global war on terror".' ( Gideon Rachman, And now for a world government, Financial Times, December 8 2008 )

Mr. Rachman accurately reflected the immense momentum today towards world government which many a globalist had been working toward across generations rather openly, often boldly proclaiming that:

'We shall have World Government, whether or not we like it. The only question is whether World Government will be achieved by conquest or consent.' (James Warburg in 1950 to the US Senate, cited in Project Humanbeingsfirst's Monetary Reform Bibliography)

The EU Council President, Herman Van Rompuy, only 59 years later on November 19,

2009, openly admitted in his first press conference in Brussels after being appointed president, that finally, **“2009 is also the first year of Global Governance”**:

'We are living through exceptionally difficult times. Financial crisis and its dramatic impact on employment and budgets, the climate crisis which threatens our very survival --- a period of anxiety, uncertainty, and lack of confidence. Yet these problems can be overcome, by a joint effort, in and between our countries. **2009 is also the first year of Global Governance with the establishment of the G-20 in the middle of financial crisis. The climate conference in Copenhagen is another step towards the Global Management of our Planet.** Our mission, our presidency is one of hope, supported by acts, and by deeds.' (press conference November 19, 2009 <http://youtube.com/watch?v=QEqFtVrAgSo> )

Mr. Van Rompuy too was accurate in his message of hope that Global Governance is *“supported by acts and by deeds”*.

But just what might these be?

A Council on Foreign Relations author had rather holistically outlined the underlying character of these supporting *“acts”* and *“deeds”* way back in the middle-stages of their planning-execution cycle in April 1974 as follows:

'In short, the 'house of world order' will have to be built from the bottom up, rather than from the top down. It will look like a great 'booming, buzzing confusion' to use William James' famous description of reality, but an end run around national sovereignty, eroding it piece by piece will accomplish much more than the old-fashioned frontal assault.

Of course, for political as well as administrative reasons, some of these specialized arrangements should be brought into an appropriate relationship with the central institutions of the U.N. system, but the main thing is that the essential functions be performed.

The question is whether this more modest approach can do the job. Can it really bring mankind into the twenty-first century with reasonable prospects for peace, welfare and human dignity? The argument thus far suggests it better had, for there seems to be no alternative. But the evidence also suggests some grounds for cautious optimism.' (Richard N. Gardner, *The Hard Road To World Order*, Foreign Affairs April 1974 issue, pages 558-

Herman Van Rompuy's message of hope at the completion stages decades later was merely the cross-generational echo of Richard N. Gardner's "*prospects for peace, welfare and human dignity*" that had been long sewn "*bottom up, rather than from the top down*" such that to the uninformed public, it would always "*look like a great 'booming, buzzing confusion' to use William James' famous description of reality, but an end run around national sovereignty, eroding it piece by piece will accomplish much more than the old-fashioned frontal assault.*"

The blood-drenched transformation stage that we find ourselves in today – the wreckage of civilizations – is truly "*Between Two Ages*". That brilliant description is not mine, but the title of Zbigniew Brzezinski's seminal self-serving 1970 book which [presumably] got him appointed as the Executive Director of David Rockefeller's Trilateral Commission. There are more than a dozen Trilateralists and CFRs in President Obama's Administration too, pushing the banksters' globalist agendas finally to fruition across multiple fronts simultaneously. The money behind them, at least in the United States, is primarily the Rockefellers' who own the majority stake in the New York Fed, which in turn largely controls the Federal Reserve System.

In Europe, the money is primarily the Rothschilds' who control all the world's private central banks (including America's Federal Reserve and international lending-policing agencies such as the World Bank IMF tag-team and the WTO) with complex interlocking relationships among a closed-knit tiny fraternity who exercise their will upon international banking and global finance and thus upon all nations of the world, through their largely unknown Bank for International Settlements (<http://BIS.org>) located in Basle, Switzerland.

Entirely coincidentally of course, BIS is located in the same secretive banking capital where Theodor Herzl had earlier made his notorious Jewish manifesto, *Der Judenstaat* public in the First World Zionist Congress in 1897 to set the public stage for the creation of the exclusively Jewish state of Israel in 1948. Also entirely coincidentally, the British Empire had gratuitously issued its famous 1917 Balfour Declaration in the name of Lord Rothschild, the principal owner and founder of the international financial system who had controlled the Bank of England since Waterloo.

And again entirely coincidentally, America's entry into World War I was facilitated after the founding of its own 'Bank of England', i.e., the Federal Reserve System principally by Paul Warburg, the banking fraternal twin of Lord Rothschild in whose palace the Treaty of Versailles was signed after World War I to enable the British Mandate over the lands of

historic Palestine.

These remarkable coincidences have today made the Rothschilds the most revered family name in Israel. Some call them the King of the Jews – and to live up to that Solomon-ly title, the Rothschilds have architected, financed and built the Jewish state's principal hall of Justice, the Israeli Supreme Court in Jerusalem. The Jewish State today enjoys the unparalleled privilege of an “Iron Wall” that none can breach. The Rothschild's frankenstein can with brazen impunity exterminate, assassinate, and bomb, to the applause of the world leaders (see 'Pamphlet: How to Return to Palestine').

And yet, strangely, the Rothschild's role in seeding and orchestrating the affairs of the modern world is consistently downplayed almost universally. No media, no academic, no scholar, no historian, no dissent-chief, no corporate executive, no billionaire on Forbes list, the Forbes list itself, and of course no politician and world statesman, dare utter that name publicly – and so long as they don't, they can say anything else they want. Elusive power such as this is not a figment of someone's imagination.

Prof. Carroll Quigley was permitted to openly state the following in his 1966 book *Tragedy and Hope*, and his controlled revelations which continued that tradition of downplaying the name of the Rothschilds, only came on the heels of the free-wheeling Eustace Mullins' well-documented exposé of how the Federal Reserve System in the United States was conspiringly created by forces representing the same globalist banking elite, and he had not spared the Rothschild name; this was followed by a series of books and documentary films in the 1970s by many others including Gary Allen, W. Cleon Skousen, G. Edward Griffin, Antony Sutton et. al. These passages from Quigley's 1200 page ode to the International bankers underscores the base axiomatic reality upon which the entire web of control of the globalists is fabricated:

'The powers of financial capitalism had (a) far-reaching aim, nothing less than to create a world system of financial control in private hands able to dominate the political system of each country and the economy of the world as a whole. This system was to be controlled in a feudalist fashion by the central banks of the world acting in concert, by secret agreements arrived at in frequent meetings and conferences. The apex of the systems was to be the Bank for International Settlements in Basel, Switzerland; a private bank owned and controlled by the world's central banks which were themselves private corporations. Each central bank, in the hands of men like Montagu Norman of the Bank of England, Benjamin Strong of the New York Federal Reserve Bank, Charles Rist of the Bank of France, and Hjalmar Schacht of

the Reichsbank, sought to dominate its government by its ability to control Treasury loans, to manipulate foreign exchanges, to influence the level of economic activity in the country, and to influence cooperative politicians by subsequent economic rewards in the business world.' (Carroll Quigley, *Tragedy and Hope*, 1966, Chapter 20, page 324)

'It must not be felt that these heads of the world's chief central banks were themselves substantive powers in world finance. They were not. Rather, they were the technicians and agents of the dominant investment bankers of their own countries, who had raised them up and were perfectly capable of throwing them down. The substantive financial powers of the world were in the hands of these investment bankers (also called "international" or "merchant" bankers) who remained largely behind the scenes in their own unincorporated private banks. These formed a system of international cooperation and national dominance which was more private, more powerful, and more secret than that of their agents in the central banks. This dominance of investment bankers was based on their control over the flows of credit and investment funds in their own countries and throughout the world.' (Carroll Quigley, *Tragedy and Hope*, 1966, Chapter 20, page 326)

The following observations made in 1970 by W. Cleon Skousen in his extensive commentary on *Tragedy and Hope* is entirely empirical today:

'The real value of *Tragedy and Hope* ... [is the] bold and boastful admission by Dr. Quigley that there actually exists a relatively small but powerful group which has succeeded in acquiring a choke-hold on the affairs of practically the entire human race. Of course we should be quick to recognize that no small group could wield such gigantic power unless millions of people in all walks of life were "in on the take" and were willing to knuckle down to the iron-clad regimentation of the ruthless bosses behind the scenes. As we shall see, the network has succeeded in building its power structure by using tremendous quantities of money (together with the vast influence it buys) to manipulate, intimidate, or corrupt millions of men and women and their institutions on a world-wide basis.' (W. Cleon Skousen, *The Naked Capitalist*, pg. 6)

Gary Allen argued matters in such an elegant style in 1971 in his short book *None Dare Call It Conspiracy*, that the logic of the highlighted sentences in the passages quoted below even elicited a long chuckle from a most cynical MIT trained Silicon Valley engineer friend



of mine who has designed dozens of microchips and is not easily given to levity on current affairs:

'Most of us have had the experience, either as parents or youngsters, of trying to discover the "hidden picture" within another picture in a children's magazine. Usually you are shown a landscape with trees, bushes, flowers and other bits of nature. The caption reads something like this: "Concealed somewhere in this picture is a donkey pulling a cart with a boy in it. Can you find them?" Try as you might, usually you could not find the hidden picture until you turned to a page farther back in the magazine which would reveal how cleverly the artist had hidden it from us. If we study the landscape we realize that the whole picture was painted in such a way as to conceal the real picture within, and once we see the "real picture," it stands out like the proverbial painful digit.

We believe the picture painters of the mass media are artfully creating landscapes for us which deliberately hide the real picture. In this book we will show you how to discover the "hidden picture" in the landscapes presented to us daily through newspapers, radio and television. Once you can see through the camouflage, you will see the donkey, the cart and the boy who have been there all along. Millions of Americans are concerned and frustrated over mishappenings in our nation. They feel that something is wrong, drastically wrong, but because of the picture painters they can't quite put their fingers on it.

Maybe you are one of those persons. Something is bugging you, but you aren't sure what. We keep electing new Presidents who seemingly promise faithfully to halt the world-wide Communist advance, put the blocks to extravagant government spending, douse the fires of inflation, put the economy on an even keel, reverse the trend which is turning the country into a moral sewer, and toss the criminals into the hoosegow where they belong. Yet, despite high hopes and glittering campaign promises, these problems continue to worsen no matter who is in office.

Each new administration, whether it be Republican or Democrat, continues the same basic policies of the previous administration which it had so thoroughly denounced during the election campaign. It is considered poor form to mention this, but it is true nonetheless. Is there a plausible reason to explain why this happens? We are not supposed to think so. We are

supposed to think it is all accidental and coincidental and that therefore there is nothing we can do about it.

FDR once said "In politics, nothing happens by accident. If it happens, you can bet it was planned that way." He was in a good position to know. We believe that many of the major world events that are shaping our destinies occur because somebody or somebodies have planned them that way. **If we were merely dealing with the law of averages, half of the events affecting our nation's well-being should be good for America. If we were dealing with mere incompetence, our leaders should occasionally make a mistake in our favor.**

We shall attempt to prove that we are not really dealing with coincidence or stupidity, but with planning and brilliance. This small book deals with that planning and brilliance and how it has shaped the foreign and domestic policies of the last six administrations. We hope it will explain matters which have up to now seemed inexplicable; that it will bring into sharp focus images which have been obscured by the landscape painters of the mass media.

Those who believe that major world events result from planning are laughed at for believing in the "conspiracy theory of history." Of course, no one in this modern day and age really believes in the conspiracy theory of history -except those who have taken the time to study the subject. When you think about it, there are really only two theories of history.

Either things happen by accident neither planned nor caused by anybody, or they happen because they are planned and somebody causes them to happen. In reality, it is the "accidental theory of history" preached in the unhallowed Halls of Ivy which should be ridiculed. Otherwise, why does every recent administration make the same mistakes as the previous ones? Why do they repeat the errors of the past which produce inflation, depressions and war? Why does our State Department "stumble" from one Communist-aiding "blunder" to another?

If you believe it is all an accident or the result of mysterious and unexplainable tides of history, you will be regarded as an "intellectual" who understands that we live in a complex world. **If you believe that something like 32,496 consecutive coincidences over the past forty years**

**stretches the law of averages a bit, you are a kook!** (Gary Allen, None Dare Call it Conspiracy, 1971, Chapter 1)

Can today's handful of rabble-rousing moral activists with their chest-thumping internet-jihad and the occasional street-dance protesting with loud drum-beating, fight such a nemesis that is not only legally endowed with an infinite supply of money conjured out of thin-air, but whose controlling power pervades all public and private institutions from universities to businesses to governments to non-profit supra-organizations like the United Nations and none dare talk about it without being called a 'kook'? To genuinely reverse this unstoppable impetus towards global management surely requires an order of magnitude different strategies and tactics other than blaring into bull-horns and publishing books and eloquent websites don't you think?

To an engineer's eye attuned to building real systems rather than merely talking about their future possibility in glossy brochures, it requires mass mobilizations and the common man's commandeering of structures of power worldwide to shut down the world. No food on the store shelves, no garbage picked up, no containers unloaded, all civic services stopped, etc. A global strike that demands the juridical hanging of the oligarchy, the nationalization of their amassed wealth, and the un-privatization of usurped public commons worldwide.

Apart from the fact that all such effective mobilization requires money, global organizations, time to build them up, labor unions and political institutions which can mobilize the rank and file for common cause, unfettered access to media to carry the message, and intellectual strategies and tactics which can launch a thousand cuts of no less overwhelming convulsion than what the oligarchy conjures up to overwhelm the public senses, there are also no masses to mobilize. More importantly, there are no un-compromising leaders to lead them.

With no resources outside of the institutional parameters of the status quo for any emerging leadership to be effective in rebelling against those very institutions, and all legalisms and security apparatuses calculatngly stacked in favor of the establishment's own ruling paradigms – the unfettered promulgation of hegemony of the oligarchy fronted by the 'national security state' with its colossus military-industrial-academe-media-congressional-juridical-executive complex – what can even courageous leaders do when even the brains of the President of United States, the mightiest superpower on earth, is not safe from being blown to smithereens when it becomes a threat to the status quo? (See 'The Eight Bay of Pigs of JFK' in Jim Douglass' November 2009 talk "*JFK and the Unspeakable*" at COPA, Dallas, based on his [book](#) )

Random public riots in the streets out of individual desperation does not, and will not, cut it. Ineffectual rowdiness is in fact, the calculated tactical plan of the globalists themselves. Because, destructive riots enable them to play their final trump card – martial law! And the FEMA detention camps on military sites have already been made ready to welcome many an unwise malcontent! (See 'Why bluff martial law')

Those attempting to uncontrollably rile up the public anger with bull-horns in the style of Television Network's *Mad Prophet of the Airwaves* (Network, 1976 movie):

"Well, I am not gonna leave you alone. I want you to get mad. I don't want you to protest, I don't want you to write to your congressman because I wouldn't know what to tell you to write. I don't know what to do about the depression and the inflation and the Islamofascists and the crime in the street. All I know is that first, you've got to get mad. You've got to say "*I am a human being god dammit, my life has value*". So, I want you to get up now, and go to the window, open it, and stick your head out and yell: "***I am mad as hell and I am not gonna take this anymore***",

cannot not know this.

While it has today become next to impossible to tell fabricated dissent from manufactured consent, and with reformed cats piously trying to represent the silly mice, the underlying political science basis of the ubiquitous social engineering which employs this "*cognitive infiltration*" is documented in the two reports 'Manufacturing Dissent: The Master Social Science', and 'Anatomy of Conspiracy Theory'. Also see: 'Did David Ray Griffin and Steve Lendman miss the real purpose of Cass Sunstein's "Conspiracy Theories"?'

As one can glean in these aforementioned analyses, there is effectively no dissent today that can impact the status quo. And establishment's systems are already in place to ensure that it does not happen either. Only narratives are permitted to exist. And the narrators are often generously rewarded too, with many even openly seeking and accepting their harvest of peace prizes and other glamorous accolades, lucrative appointments and tenures, from the same empire which they ostensibly oppose in their prominent dissent! I am told that there is a very generous single Biblical word for them: hypocrite. Not being divinely inspired, mine are of course considerably less generous.

Never mind waking up the sheeple. The genuine "ostrich" activists, the "*quite gallant and graceful-looking people*" as H. G. Wells described the lot (see quote below), themselves need to wake up to the grotesque reality first, and take accurate cognizance of the

battlefield the way it really is.

The way things stand today – see the reality-check in 'Why Not Be An Ostrich?' – without birth-pangings radical transformations to dissent-space and the concomitant emergence of a focussed global resistance, Global Governance of the oligarchy is fait accompli. That is simply a factual statement with no emotional syntactic sugaring applied.

The myriad manufactured crises which afflict humanity today, from the riveting Wikileaks intrigues to the perpetual 'War on Terror', from the Financial Crisis to Global Warming and the Carbon Credit scams, and perhaps even Alien landings/sightings and/or intergalactic catastrophes soon if Project Camelot has been accurately primed, are merely the successive Hegelian mind-fcks, ahem, the “acts” and “deeds”, of making current affairs “look like a great ‘booming, buzzing confusion’ to use William James’ famous description of reality,”.

Each new ‘booming, buzzing confusion’ provides the new enabling pretext for inching the world one baby-step closer towards the Global Governance of the Planet. (See Project Humanbeingsfirst Publications Index for reports on each one of these “acts” and “deeds” to verify for yourself how every crisis has been harvested to legislate new laws towards that end)

And all that the “malcontent” and “graceful-looking people” can do, just like the “history’s actors” accurately predicted that we shall do, is study it:

'We're an empire now, and when we act, we create our own reality. And while you're studying that reality — judiciously, as you will — we'll act again, creating other new realities, which you can study too, and that's how things will sort out. We're history's actors . . . and you, all of you, will be left to just study what we do.' (Ron Suskind, New York Times, Oct. 17, 2004)

More tragically, our tortuous zeitgeist was also accurately presaged even before most of us were born:

'When the struggle seems to be drifting defiantly towards a world social democracy there may still be very great delays and disappointments before it becomes an efficient and beneficent world system. Countless people – will hate the New World Order – and will die protesting against it. When we attempt to evaluate its promise, we have to bear in mind the distress of a generation or so of malcontents, many of them quite gallant and graceful-looking people.' (H. G. Wells, The New World Order, page 127)

Isn't that where all the world's rebels precisely stand today, blindly and ineffectively resisting a fait accompli in false hopes? With most of the world's 'untermenschen' happy-happy in hope and voluntary servitude waiting for a savior? (See 'Happy-Happy in Hope and Voluntary Servitude')

But perhaps it is not because of false hopes. That is only for ostriches.

Perhaps it is really that elusive spirit of the swashbuckling rebel, Captain Rhett Butler of **Gone with the Wind** which inspires this lot. At least in so far as his penchant for supporting lost causes after they were truly lost was concerned. ***“Why?”***, said Captain Butler to Mrs. Hamilton as he gallantly abandoned his unrequited love in the middle of the road to go join the Confederate Army after Atlanta had been completely burned to the ground by Sherman and his northern soldiers, ***“maybe it's because I have always had a weakness for lost causes once they are really lost.”***

Admirable, perhaps even heroic by grandmotherly standards. But hardly any cause for indignation for the henchmen at the CFR and the EU Council who, under the *“iron-clad regimentation of the ruthless bosses behind the scenes”*, are striving to bring us *“reasonable prospects for peace, welfare and human dignity”* in the twenty-first century.

Nevertheless, rebels don't necessarily always measure their categorical imperatives in the same way. For many among the 'untermenschen', to simply exist is to resist. And obviously no self-delusion is involved there. For others, to merely survive the daily oppression and daily burials of their loved ones with their dignity and mental faculties intact, is unsurpassed heroism. Such earthly struggles when wholly circumscribed by moral dimensions, even when motivated by narrow existential self-interests such as the self-defense of one's own loved ones, or the safeguarding of one's own sanity, is perhaps best captured by the pithy wisdom from the Islamic tradition narrated in my 'Muslim's Voice: Why we endeavor even when it appears futile!':

'When the Prophet Abraham (in the Orientalist's spelling) was being thrown in the fire by the tyrannical ruler Nimrod, all creation was in tremendous angst. Even the stones spoke out against the tyrant. Every moral creature endeavored to the rescue of Prophet Ibraheem (AS) to put out the fire. To the extent that a tiny bird picked a droplet of water in its minuscule beak and started to fly over the fire.

An Angel of God asked the little bird: *“Surely you are not going to put out the fire with that droplet(!), and surely the high flames will consume you! – what*

*do you think you are doing?"*

*The tiny bird replied: "yes, you are right, and I know that my tiny droplet will not save the Ulul-Azam (Great Prophet) of God. But I bring to the endeavor of standing up to this evil tyrant whatever I am capable of, and this tiny droplet is all I am capable of."*

The rebel is not an ostrich. He and she is that tiny bird with the tiny droplet in its beak.

**References:** Facts not cited are either too well known or amply cited in the many works of Project Humanbeingsfirst.org. All report titles in the text not explicitly cited are the author's own work – please see pubs index: <http://print-humanbeingsfirst.blogspot.com/p/pubs-index.html>.

**Short URL:** <http://tinyurl.com/Hard-Road-to-World-Order>

**Source URL:** <http://print-humanbeingsfirst.blogspot.com/2010/12/of-ostriches-and-rebels-zahirebrahim.html>

First Published December 05, 2010

## Chapter 4 Arc of Crisis

### Viewpoint: Instrumenting Kosovo in the 'arc of crisis' and the 'global zone of percolating violence'

This is Part-4 of a six part series.

**Fool us once shame on you; fool us twice shame on us; fool us repeatedly, curse on us!**



Caption Libyan rebels repel attacks as refugees flee Ajdabiya Eastern Libya, March 03, 2011 (AP Photo Kevin Frayer, image via sacbee)

The pertinent news headlines in just this first week of March 2011 point to one of the obvious covert agendas behind this sudden “revolution” bubble throughout the Middle East:

- **'US warships enter Egypt's Suez Canal'** ([Press TV](#), [Fox News](#) and [AP](#)) ;
- **'Obama signals willingness to intervene militarily in Libya if crisis worsens'** ([Washington Post](#), [Daily Mail](#)) ;



- **'Obama administration prepares for possibility of new post-revolt Islamist regimes'** ([Washington Post](#)), etc.

In the absence of any genuine political leadership in our Middle Eastern nations due to decades of oppressive autocratic rules by various praetorian guards from among the Muslims, i.e., House Negroes of empire, the vacuum has to be filled when these are suddenly removed.

I had already observed some *rocket science* (sic!) in part-2 in anticipation of the third headline noted above:

'This theme repeats over and over again with variations. Sometimes, the preferred military dictator brought about with a coup, is replaced by a hand-picked malleable corrupt bastard under the facade of elections, leaving a wake of public discontent in either case, and then musical chairs begin again as the society is led by its nose towards more orchestrated chaos and insecurity. The same deadly "music" is perhaps being played in Egypt and Tunisia. With "militant" Islam poised to take hold of both nations – as per the natural aspirations of the peoples after decades of oppressive secular rule – it is rather transparent that the *'arc of crisis'* is being primed for radicalization.'

Therefore, apart from new stooges appointed/selected/elected to lead our nations, either as protagonists, or as antagonists (as per the Hegelian Dialectic already explained elsewhere), from the other headlines in establishment's own newspapers, it should now be apparent to even the most dunce *non rocket scientists* that the introduction of international "peace keeping" forces is part of the agenda behind creating this sudden vacuum in power in the Middle East. As reported in the first headline noted above by Press TV:

'The US, along with Britain and France, has also sent hundreds of Special Forces to Libya's east. The forces are setting up bases in the cities of Benghazi and Tobruk. The move comes against the backdrop of heated discussions over the possibility of imposing a no-fly zone on Libya, and a NATO-backed military intervention.

The US Senate on Tuesday unanimously passed a resolution urging the world to consider imposing a no-fly zone over Libya and condemning Gaddafi's bloody crackdown on Libyan civilians. Lawmakers approved the measure, which "applauds" demonstrators demanding democratic reforms

and "strongly condemns" Gaddafi's response.'

To fully comprehend this agenda, one has to penetratingly understand what transpired in Kosovo in the 1990s, and what was the end result. The internationalization of the United Nations and NATO "peace keeping" forces in order to maintain peace and stability among a fractious people unable to govern themselves like civilized human beings. Kosovo set the legal, and UN sanctioned precedent for how the World Order of one-world government is to be principally governed. That agenda is not new. It has been amply discussed by others. It is also frequently referenced in the many publicly available strategy documents and books of empire.

That very end result in the case of Middle East, throughout the *'arc of crisis'* in the *'global zone of percolating violence'*, is evidently being sought through these manufactured "revolutions" which only seed chaos, civil war, Muslim on Muslim ethnic/religious/political violence, all leading to the demoralization and disintegration of the cohesive social fabric under the auspices of 4th, 5th, 6th, ... generation warfare methods designed to destroy nations and societies from within. Just as was done to Serbia. And just as has been implemented successfully in Iraq. By taking the public through calculated extremes of stress-relief cycles, by means of war, or civil war, the indigenous masses are systematically primed to eventually accept whatever solution is imposed upon them in the brief relief periods, as their existential necessities of survival. It matters little if such acceptances are contrived through "elected parliaments", enforced by invasion forces by the fiat of conquest, or by "peace keeping" forces.

The end result is that the people end up losing all their national sovereignty, in anything and everything which is meaningful to being a nation rather than an administrative colony. Our nations have already lost most everything at the altar of the World Bank and the IMF. Our armed forces were already working over time in carrying *the white man's burden*. Now, even that veneer is to be stripped for complete capitulation, to the vaunted International Peace Keepers being introduced, ostensibly, to support/protect (and arm and train) the rebels as was reported by Fox News and AP in the usual camouflaged language of deception: "And while he [Defense Secretary Robert Gates] did not rule out other options, such as providing air cover for Libyan rebels, he made clear he has little enthusiasm for direct military intervention." Initially, fomenting an armed civil war will do just fine to soften up the target from within, as the news headlines in the UK Independent screamed on March 07, 2011: **'Obama asks Saudis to airlift weapons into Benghazi - America's secret plan to arm Libya's rebels'**. Setting the Muslim patsies up in Libya just like we did for years in Iraq would facilitate further justifiable intervention, announced the UK Telegraph on March 08, 2011: **'David Cameron and President Barack Obama have**

***announced a 'full spectrum' of action on Libya'.***

The brilliant '*full spectrum' of action on Libya'* is to be drawn directly from the very successful Iraqi template, since the desperate Muslim polity in the Middle East evidently still don't seem to have a damn clue what we are up to:

'A joint British and US statement said a plan for a no-fly zone, as requested by many of the rebels, was among the ideas being discussed. Action would also include surveillance and enforcement of the arms embargo against Libya. ...

The significance of control over Libya's oil facilities was emphasised when William Hague, the foreign secretary, told MPs he was considering whether to push for international action to take billions of dollars of Libyan oil revenues away from the Gaddafi regime and put them under United Nations control.

The plan, inspired by the oil-for-food system imposed on Saddam Hussein's Iraq, would require a decision by the United Nations Security Council, which is already under pressure to impose a no-fly zone over Libya in light of Col Gaddafi's use of air power to try to crush the rebellion against his 41-year-rule.'

When will the Muslim fools learn?

This is the meaning of the prescience of the '*arc of crisis'* in the '*global zone of percolating violence'*. How else does such remarkable foresight come about, decades before the percolating violence, unless it is orchestrated with long term planning and social engineering? The agenda for world government has been in systematic piece meal enactment for over a hundred years. See: [Of Ostriches and Rebels on The Hard Road to World Order.](#)

In every nation as it exists today, among every peoples, eventually, only veneers and facades will be left behind, some respectable, and some antagonistic in order to be able to escalate the white man's "threat level" for its own domestic consumption to Defcon 2 as needed. Pakistan is a shining example of continuing exactly the same policies as were in place under the decade long dictatorial reign of General Musharaf – all in support of the "massa". And today, Pakistan and Iran, the beneficiary of the *Iranian mob-revolution*, constitute the core pretext for ever going to Defcon 2!

The *uber learned* and other brilliant savants affiliated with the conquered societies always seem to dutifully rise to the occasion of heralding “change” that is brought to their shores – often by getting the people to ask for “change” themselves.

From America's “change” president, to Pakistan's “change” president, to all the “*regime changes*” planned in the '*global zone of percolating violence*', can anyone identify specific changes which have been beneficial to the independence of those nations? No.

And these same savants always also seem to be the ones to justify the solutions brought by the *white man* when it is most necessary to genuinely and effectively oppose them with efficacy. Carrying the *white man's burden* is evidently back in full vogue. But to any half astute observer of geopolitics, it would appear to actually never ever have gone out of fashion since time immemorial, despite Rudyard Kipling's poetic laments in 1899 that the West wasn't carrying its fair share of *the white man's burden* in the Philippines. These savants with lofty titles and marketable associations, either knowingly as mercenaries and stooges, or unwittingly as *useful idiots*, outright refuse to preemptively see the subversive game plan of conquest through deception, when it can actually be defeated by understanding the agenda of the enemy. Then, meaning now when breaking events in the Middle East are overtaking the commonsense of most intelligentsia, when it is utmost essential to be able to distinguish between cause and effects with forensic clarity, when it is urgently necessary to not be carried away by the visible dramas being enacted among the public, and when it is an existential imperative to comprehend the invisible subversive forces at play in order to defeat them, these brilliant minds suddenly become parrots of empire echoing its narratives!

Later, *ex post facto*, once the *fait accompli* is sewn tight, they will suddenly transform into the *useful rebels* of empire shouting **war crimes tribunals** – and for whom? For the previous crop of errand boys and girls of empire which has absolutely no relevance to the new atrocities being created on the ground by their replacements with the same, and sometimes more, impunity. My website documents my many letters to *useful idiots* and *useful rebels*, and I am quite unable to distinguish among them, whether they are just “controlled dissent” working for empire, or just being plain stupid. It does puzzle me that how is it that stupid people have become leading opinion-makers in almost every nation? Is it that their opinions have some inherent wisdom? Or is it that the empire promotes them as *useful idiots*?

Our suffering brethren in Iraq, Afghanistan, Pakistan, Palestine, Lebanon, Iran, Egypt, Syria, Libya, Bahrain, the entire '*arc of crisis*' in the '*global zone of percolating violence*' need genuine un-co-opted revolutionaries – not mob “revolutions” – who can pose even half

a challenge to the intellectual warfare that is the primal first cause of our continuous defeats at the hands of *hectoring hegemons*. Using the intellect is the first line of defense against those who *wage wars by way of deception!* While many repeatedly echo that maxim like parrots, few betray the timely recognition of that maxim when it can be most effective in defeating such warfare.

### **What can be done?**

If you know who the enemy is, deeply understand its modalities of conquest, and know yourself, you can take measures to do something about it. That enemy, the first enemy, is within our own nations.

Unless the fifth columnists in every nation and among every people – those who work against their own peoples, both in and out of power, those who set up puppet regimes with military might and then tear it down with manufactured mob power, those who engineer consent among the gullible public and those who play false oppositions to head of genuine rebellion, and those who remain behind the errand boys occupying presidencies who come and go, but they go on forever behind the scenes – all of them, are juridically euthanized first in the greater interest of the *huddled masses*, the battle against colonization is lost even before it is begun.

As was narrated by Sun Tzu in The Art of War, the oldest and still most effective military treatise in the world which principally underlies all significant political planning in the “temples”, i.e., think-tanks, of modernity:

- All warfare is based on deception;
- Now the general who wins a battle makes many calculations in his temple [before] the battle is fought. The general who loses a battle makes but few calculations beforehand. Thus do many calculations lead to victory, and few calculations to defeat: how much more no calculation at all! It is by attention to this point that I can foresee who is likely to win or lose;
- Thus it is that in war the victorious strategist only seeks battle after the victory has been won, whereas he who is destined to defeat first fights and afterwards looks for victory.

That is a lesson plan the modern *hectoring hegemons* – those who through many calculations, seed wars, pestilences, calamities, debt slavery, those who instigate nations to fight, those who turn brother against brother by incubating traitors, stooges, fools and

useful idiots among them – have deftly followed over the past two centuries. So long as these traitors of humanity exist among us – and I don't see how the Mir Jafar/Mir Sadiq among every people can ever be fully eliminated – the battle will always go to those who remain superior in the *Art of War*.

Plebeians know nothing about the *Art of War* – and so we are easily mobilized into the streets, sometimes for pecuniary gain, sometimes as the method of last resort to vent steam against tyranny. Such social engineering principles are well understood by those who plan these outcomes and harness the predictable mass behavior for their own purposes. Their effective counter can only come by combining shrewd political intellect with un-co-opted political power which can defend against these incessant onslaughts upon the powerless and rather predictable masses of human beings.

Neither does such a political intellect, nor such a political power, visibly exist today in the entire '*arc of crisis*', the '*global zone of percolating violence*', both self-serving characterizations of Dr. Zbigniew Brzezinski, the diabolical author as well as the covert architect of *The Grand Chessboard*. The reason it has been eviscerated is not merely by happenstance, or because the 'lesser peoples' just love to live under autocratic rule. But by calculated design of the *hectoring hegemons* themselves who have continually brought to power, aided and abetted, in many cases entirely financed, in other cases militarily and politically supported, the many vile dictatorships and superficial egotistical kingdoms (spanning the gamut from benign as in Bahrain to draconian as in Saudi Arabia) in these very nations in which they today raise the banner of “revolution” for “democracy”. Is this such a surprise that they now fully effectuate this banner? The Project for the New American Century (PNAC) even openly advertised instigating “regime change” being the new foreign policy calculus of the lone superpower for the twenty first century, violently replacing the *molding stability* of its own previously favored tin-pot dictatorships with the *vibrant instability* of “*revolutionary times*” – the singular catalyst of all transformations.

As already quoted above, comprehending Machiavellianly poisoned apples presented to *Snow White*: '*Lawmakers approved the measure, which "applauds" demonstrators demanding democratic reforms and "strongly condemns" Gaddafi's response.*', is really not *rocket science* – unless one is a complete imbecile, or superlatively naïve. The remaining logical conclusion therefore, when one pretends to not comprehend, is that one is among the fifth columnists!

This immediately helps us identify and “bin” (sort) our first enemies rather straightforwardly into the useful categories of traitors and fools, to separate them from the *huddled masses*. Hang the traitors and harness the fools to mobilize them productively for our own cause –

easier said than done without genuine political power and intellectual prowess to bring it about. This is evidently as true in Brzezinski's '*global zone of percolating violence*' as in Brzezinski's '*sole remaining superpower*' which is entirely overrun by traitors and fools together screwing their own nation. As is self-evident from my [Message to the US Congress in 2008](#) at the time of their willing passage of the Bankster Bailout Bill, failure to lead and act propitiously, trivially identifies who works for whom. It is not entirely obvious how any self-respecting nation, peoples, and even superpower, can survive either its traitors or its fools. Which is why none do!

**Which is also why nothing can be done without getting rid of the fifth columnists first.**

Hence the self-evident import of the remarkable truth in the saying that is quoted in the 2500 years old manual for waging both successful wars and successful self-defense: '*If you know the enemy and know yourself, you need not fear the result of a hundred battles. If you know yourself but not the enemy, for every victory gained you will also suffer a defeat. If you know neither the enemy nor yourself, you will succumb in every battle.*'

Therefore, in conclusion, if a genuine revolutionary acumen which can effectively bring to bear the above nugget of political wisdom from *The Art of War* is secretly undergoing some zealous birth-pangs just beneath the surface, it is high time these boldly germinated while the soil is still fertile. Just as the *hectoring hegemons* need "*revolutionary times*" to seed their own agendas, the same "*revolutionary times*" really become a double edged sword in the art of war. Why? Because it is also only in these "*revolutionary times*" that the enemy can also be conceivably defeated: "*what is inconceivable in normal times is possible in revolutionary times!*" As history testifies, it is only in "*revolutionary times*" that the fifth columnists reveal themselves in order to play their assigned hand. And it is only in "*revolutionary times*" that the entire house can be cleansed in a genuine revolution. Since the *hectoring hegemons* well understand this – empiricism indicates that they are also far better attuned to continually preempting it in ongoing game theory enactment with massive deployment of resources and newer Trojan Horses. To wage an effective war against such nemeses fundamentally require engaging *Mens et Manus* – both *mind and hand* together!

Zahir Ebrahim | [Project Humanbeingsfirst.org](http://ProjectHumanbeingsfirst.org)

**Full Series:**

Part-1: [Unlayering the Middle East War Agenda: Making Sense of Absurdities Jan 23, 2011](#)

Part-2: [Viewpoint: Egypt and Tunisia – The 'arc of crisis' being radicalized! Jan. 30, 2011](#)

Part-3: [Observation in Letter to BRussells Tribunal: Introducing NATO Peace Keeping Forces March 02, 2011](#)

Part-4: [Viewpoint: Instrumenting Kosovo in the 'arc of crisis' along the 'global zone of percolating violence' March 05, 2011](#)

Part-5: [Bush bombed Iraq March 19, 2003 – Obama bombs Libya March 19, 2011: Muslim blood still spills red - no change even in color](#)

Part-6: [Letter: Understanding the 'arc of crisis' with minimal work By Zahir Ebrahim March 23, 2011](#)

**Short URL:** <http://tinyurl.com/Arc-of-Crisis>

**Source URL:** <http://print-humanbeingsfirst.blogspot.com/2011/03/kosovo-in-arc-of-crisis-by-zahirebrahim.html>

First Published March 05, 2011



## Chapter 5 Conspiracy Theory

### Anatomy of Conspiracy Theory



Caption American Government Response to Conspiracy Theories  
“Conspiracy theories exist in the realm of myth, where imaginations run wild, fears trump facts, and evidence is ignored. As a superpower, the United States is often cast as a villain in these dramas.”

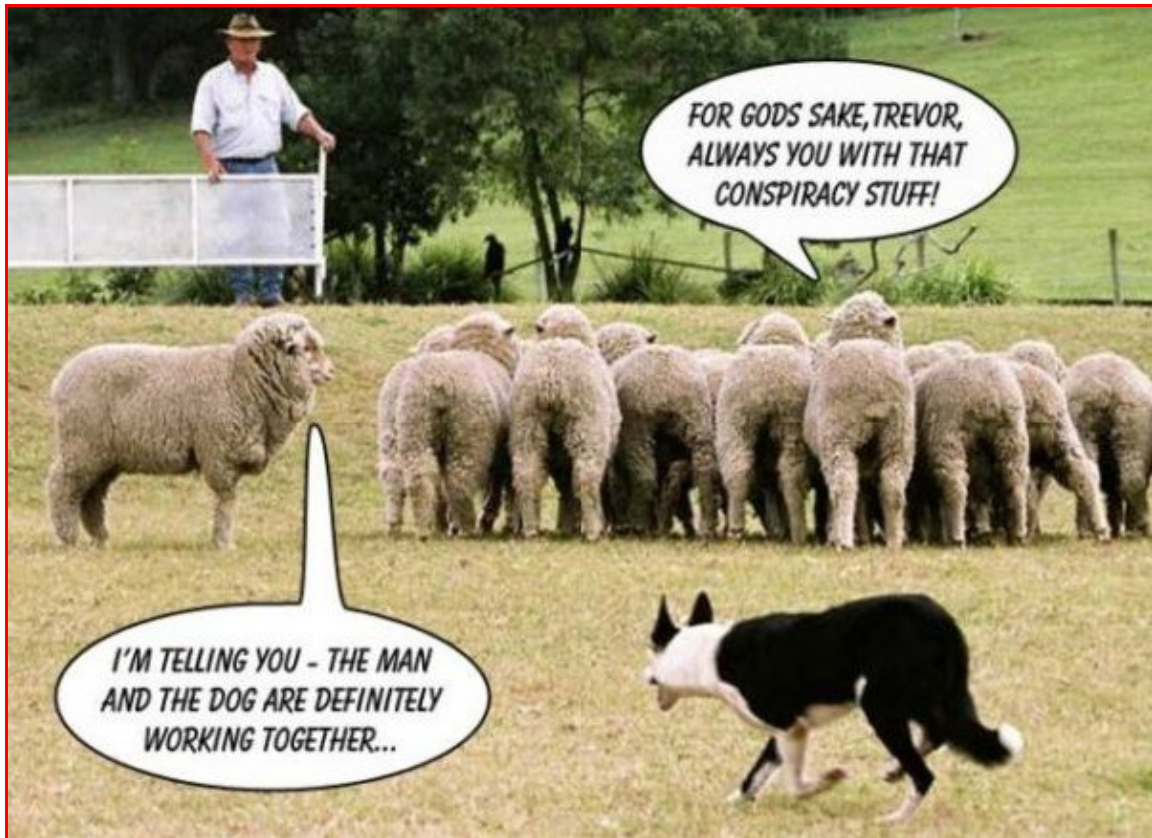

Caption Anatomy of Conspiracy Theory. NSC 10/2 directed CIA to conduct “covert” rather than merely “psychological” operations, defining them as all activities “which are conducted or sponsored by this Government against hostile foreign states or groups or in support of friendly foreign states or groups but which are so planned and executed that any US Government responsibility for them is not evident to unauthorized persons and that if uncovered the US Government can plausibly disclaim any responsibility for them.” – Furthermore, in order to preempt such uncovering, to continually seed red herrings and false theories; to delegitimize their unraveling by labeling them as kookish “conspiracy theories”; to defocus public energies by introducing “beneficial cognitive diversity”, fabricated leaks of half-truths which retain core-lies, and “Limited Hangout” mea culpae, all fed through the “Mighty Wurlitzer” messaging machinery; to brand the few daring and persistent unravellers of “truth’s protective layers” as deniers of reality suffering from “emotional or mental illness”, an “oppositional defiant disorder” exhibiting a pattern of “negativistic, defiant, disobedient and hostile behavior toward authority figures” and therefore a threat to themselves and to society; and when all else fails, to eliminate these ‘malcontents’ who refuse to tow the official line by branding them “domestic terrorists”.

Some may rationally ponder that how is it, that such a long running global conspiracy for world government as outlined in Project Humanbeingsfirst's report "**The Enduring Capitalist Conspiracy for World Government**", can be kept alive across centuries and across geographies. This brief paper examines that question.

Noam Chomsky had once observed an insightful nature of such "conspiracies", as the open shared natural goals stemming from the very nature of its definition, which could therefore, no more be termed a conspiracy than both GM and Ford endeavoring to maximize their profits at all cost be termed a 'global corporate conspiracy'.

I have always added to that, the equally un-remarkable observation that a hungry lion anywhere in the world pouncing upon a lamb is similarly no global conspiracy by the world's lions to eat up all the lambs on the planet. That is just the nature of the bestial predators when its "might defines right". The higher cerebral concepts of "right", "wrong", "moral", "immoral", etc., do not even exist among any primal predators, for these only behave according to their nature. Pious platitudes, if they could be argued by the lion or the snake for instance, would in fact only be disseminated to the lambs and the mice to make them an even easier morsel to acquire!

The only thing that occasionally deters such exercise of primacy is a collective natural response like the one observed in the "Battle at Kruger" park. Indeed, the quest for the holy grail of extracting voluntary servitude from the masses of mankind is the key idea of cultivating a willingly compliant public in order for the illuminated ones becoming their stewards for life. In Bertrand Russell's' timeless characterization, to extract voluntary servitude such that: ***"a revolt of the plebs will become as unthinkable as an organised insurrection of sheep against the practice of eating mutton."***

Thus we observe that from Plato to Nietzsche, from the philosopher-king to the 'ubermensch', all have argued the necessity of ruling upon the sheepish masses as the 'divine' imperative of the "enlightened ones". Indeed, Zbigniew Brzezinski even sub-titled his seminal book "*The Grand Chessboard*" with its egotistical subtitle "*American Primacy and Its Geostrategic Imperatives*", merely extending that idea of 'ubermensch' rule from the most "enlightened ones", to the most powerful sole-superpower!

The same theme exists among the "Chosen Peoples", to deem their primacy upon the goyim their inherent nature, their divine destiny. The 'ubermensch' are suckled these lessons in their mothers' milk to acquire those imperatives across generations in perhaps the same way as the generations of corporate executives and CEOs who inherently know that they need to continually enhance the valuation of their company's stock performance in

a capitalist system.

So, when these 'divine' ubermensch creatures who are beyond good and evil, self-servingly behave in their primal predatory natural manner across time and space, across evolution or creation, are they being “**conspiratorial**”?

In the Chomsky-Ebrahim nomenclature, perhaps not.

In the Ron Paul nomenclature, it is merely a shared “*Conspiracy of Ideas*” in which “*CFR exists, the Trilateral Commission exists*”, and that, it is only “*an ideological battle*” wherein:

**“some people believe in Globalism, and others of us believe in national sovereignty; and there is a move on toward a North American Union just like early on there was a move on for a European Union and it eventually ended up. ...**

**These are real things, it's not somebody made these up, it's not a conspiracy, they don't talk about it, and they might not admit about it, but there has been money spent on it ...**

**So it's not so much a secretive conspiracy, it's a contest between ideologies; whether we believe in our institutions here, our national sovereignty, our Constitution, or are we going to further move in the direction of international government, more UN. You know, this country goes to war under UN Resolutions. I don't like big government in Washington. So I don't like this trend towards international government ...**

**But it's not so much it's a sinister conspiracy, it's just knowledge is out there, if we look for it, you'll realize our national sovereignty is under threat!”**

In the United States' legalese nomenclature, breaking of a “*federal statute*” by at least two or more persons working in collusion (and when caught), is defined as “*criminal conspiracy*” and “*federal crime*”. According to the Columbia Encyclopedia, it is criminal whether or not Congress imposed criminal sanctions on the activity itself. A conspiracy need only be proved by “*circumstantial evidence*” even “*if it violates the rules against hearsay evidence*”:

**Conspiracy: “in law, agreement of two or more persons to commit a criminal or otherwise unlawful act. At common law, the crime of**

conspiracy was committed with the making of the agreement, but present-day statutes require an overt step by a conspirator to further the conspiracy. Other controversial aspects of conspiracy laws include the modification of the rules of evidence and the potential for a dragnet. A statement of a conspirator in furtherance of the conspiracy is admissible against all conspirators, even if the statement includes damaging references to another conspirator, and often even if it violates the rules against hearsay evidence. The conspiracy can be proved by circumstantial evidence. Any conspirator is guilty of any substantive crime committed by any other conspirator in furtherance of the enterprise. It is a federal crime to conspire to commit any activity prohibited by federal statute, whether or not Congress imposed criminal sanctions on the activity itself.”

According to such legalism, smart conspirators, if powerful enough, could affect the enactment of conducive federal statutes, or prevent the enactment of adverse ones, that would enable them to get away with many morally reprehensible systems and acts. The Federal Reserve System for instance, falls into this category. A legalized extortion racket to enslave the public in perpetual debt for the issue and supply of their own national currency. Similarly, bootlegging is a federal crime one decade, a respectable business the next! And internationally, it is the enactment of laws under WTO which defines what is criminal and what isn't – not the raping and harvesting of developing nations that goes on under its conspiratorial rubric!

Thus suffice it to say, the word “conspiracy” even has legal semantics, albeit rather limited. It is limited because it is easy to circumvent an abhorrence and call it legal when the king makes the laws.

But the multitudinous connotations of this word do not stop there. It also has a 'tin-hatted' or 'kookish' implication in furtherance of the devilish art of political science based state-craft. This was indeed implied by Congressman Ron Paul in his afore-quoted speech when he stated regarding the North American Union: **“These are real things, it's not somebody made these up, it's not a conspiracy, ... So it's not so much a secretive conspiracy, ...”**.

In fact, some of the best cloaking devices for clandestine covert-operations and hidden agendas have been invented by the most brilliant minds – here is one exposition for instance from Ezra Pound: **“invent two lies and have the public keep arguing which one of them might be true”**. Another is by Leo Strauss – the erudite teacher of the



majority of the neo-cons – called **“Noble Lies”**. A third by the White House, often referred to as **“plausible deniability”**, okay may be it was invented by the DIA, the grand-daddy of all intelligence agencies. This thinly-veiled euphemism for deception to protect the leadership if things go badly in covert-operations became public knowledge during the Iran-Contra scandal, the televised coverage of which had gripped the American nation for months, including myself. And this wasn't just a rogue operation with ad hoc deniability cover by patriotic agents as most in the public are led to believe. Deniability is official government policy vis a vis any covert operation dating back to President Truman's signing of NSC 10/2. That directive made the introduction of “plausible deniability” a requirement for CIA's clandestine operations in case they were ever blown while still active. Below is an excerpt from **“Note on U.S. Covert Action Programs”**:

### **'Management of Covert Actions in the Truman Presidency**

**The Truman administration's concern over Soviet “psychological warfare” prompted the new National Security Council to authorize, in NSC 4-A of December 1947, the launching of peacetime covert action operations. NSC 4-A made the Director of Central Intelligence responsible for psychological warfare, establishing at the same time the principle that covert action was an exclusively Executive Branch function. The Central Intelligence Agency (CIA) certainly was a natural choice but it was assigned this function at least in part because the Agency controlled unvouchered funds, by which operations could be funded with minimal risk of exposure in Washington.<sup>1</sup>**

**CIA's early use of its new covert action mandate dissatisfied officials at the Departments of State and Defense. The Department of State, believing this role too important to be left to the CIA alone and concerned that the military might create a new rival covert action office in the Pentagon, pressed to reopen the issue of where responsibility for covert action activities should reside. Consequently, on June 18, 1948, a new NSC directive, NSC 10/2, superseded NSC 4-A.**

**NSC 10/2 directed CIA to conduct “covert” rather than merely “psychological” operations, defining them as all activities “which are conducted or sponsored by this Government against hostile foreign states or groups or in support of friendly foreign states or groups but which are so planned and executed that any US Government responsibility for them is not evident to unauthorized persons and that**

if uncovered the US Government can plausibly disclaim any responsibility for them.”

... The Special Group and the 303 Committee approved 163 covert actions during the Kennedy administration and 142 during the Johnson administration through February 1967. The 1976 Final Report of the Church Committee, however, estimated that of the several thousand projects undertaken by the CIA since 1961, only 14 percent were considered on a case-by-case basis by the 303 Committee and its predecessors (and successors). Those not reviewed by the 303 Committee were low-risk and low-cost operations. The Final Report also cited a February 1967 CIA memorandum that included a description of the mode of policy arbitration of decisions on covert actions within the 303 Committee system. CIA presentations were questioned, amended, and even on occasion denied, despite protests from the DCI. Department of State objections modified or nullified proposed operations, and the 303 Committee sometimes decided that some agency other than CIA should undertake an operation or that CIA actions requested by Ambassadors on the scene should be rejected.'

Lastly, among the already well-known tools of Management of Covert Actions for statecraft, we also have the *“limited hangout”* and *“modified limited hangout”* conspiracies to mislead the public in case “plausible deniability” for governmental wrong-doing doesn't work. This modus operandi of accepting partial mea culpa for something less consequential in order to mask the more egregious crimes was amply demonstrated by Richard Nixon during the waning years of his presidency. A good description of it with excerpts from the Nixon tapes planning the red herrings is on Wikipedia.

Calculated omission is perhaps the most crafty tool of public persuasion in the general statecraft of deception as it naturally relies on ignorance – for who can have complete knowledge of every subject? Aldous Huxley aptly recalled the Churchillian term for creating such a chasm between facts and fiction as lowering an *“iron curtain”* around the public's sense of perception:

'The greatest triumphs of propaganda have been accomplished, not by doing something, but by refraining from doing. Great is truth, but still greater, from a practical point of view, is silence about truth. By simply not mentioning certain subjects, by lowering what Mr. Churchill calls an “iron curtain” between the masses and such facts or arguments as the local

political bosses regard as undesirable, totalitarian propagandists have influenced opinion much more effectively than they could have done by the most eloquent denunciations, the most compelling of logical rebuttals.' (Aldous Huxley, 1946 Preface to Brave New World, 1931)

Keeping thinking peoples plausibly occupied lest they discover the real levers of power is much more complicated than mere manufacturing consent among the masses. The latter are generally quite amenable to simple propaganda, to the big lie, and appeal to the irrational mind and subconscious fears (or needs), with repetitious reinforcement. That diabolical science of mass persuasion is already well understood, thanks to the pioneering work of Edward Bernays and the Mighty Wurlitzer, not to overlook Goebbels and Hitler, as the engineering of consent among the majority. Hitler categorized them into type-1, **“those who believe everything they read; ... when the voting papers of the masses are the deciding factor; the decision lies in the hands of the numerically strongest group; that is to say the first group, the crowd of simpletons and the credulous.”**

The minority of thoughtful peoples however, also often the people of conscience, pose a different problem. According to Hitler, the type-3, **“those who critically examine what they read and form their judgments accordingly. ... Hence the trash that newspapers are capable of serving up is of little danger--much less of importance--to the members of the third group of readers. In the majority of cases these readers have learnt to regard every journalist as fundamentally a rogue who sometimes speaks the truth. Most unfortunately, the value of these readers lies in their intelligence and not in their numerical strength, an unhappy state of affairs in a period where wisdom counts for nothing and majorities for everything.”** If not craftily waylaid, this third group of people stand to acquire some real comprehension of the otherwise carefully hidden from the masses in plain sight, conspiratorial forces which actually shape their world.

These rebels – referred to as the 'malcontents' by H. G. Wells in his famous book “New World Order” – can also figure out that the visible rulers whom the public elects with such gravitas every so often to run their country on their behalf in a momentous celebration of 'democracy' which in reality only affords the demos the choice between twiddledee and twiddledum in a carefully choreographed Hegelian Dialectic, are actually not their public servants. To hide the fact that these elected psychopaths are really still only the errand boys and girls of an invisible ruling-oligarchy, manufacturing dissent to mislead the energies of the handful of thinking and conscionable peoples has become a necessary instrument of statecraft.

This deception typically entails manufacturing dissent chiefs who can craftily take their



respective flock, by a circuitous route, to the same pastures as the mainstream public. I.e., the net impact of their celebrated dissent in derailing the manufactured consent among the masses being exactly zero. These crafty dissent-chiefs, fortunately enough, are also rather trivial to identify. **Their main modus operandi appears to be to oppose power while still echoing its core message!**

These traffickers in 'truth' – i.e., absurdities – will often truthfully describe the visible puppetshows and bravely challenge empire on what is already known and overt, such as its criminal bombings and maiming of other nations. But they will also, for instance as in this war on terror, also echo one or more of the primemover axioms of empire which ab initio enables empire's "imperial mobilization"! Namely, that some 'Ali Baba' magically pulled off 911 from his almighty perch in the Hindu Kush, that Islamofascism is a genuine threat to mankind, that Al Qaeda is out to impose its will on the West and is being aided and abetted from Pakistan-Iran nexus, etc. Because these dissent-artists hector empire in its killing of innocent civilians, they often attract big audiences among the type-2 category people identified by Hitler, **“those who no longer believe anything;”**. According to Hitler, these were formerly type-1 who changed their allegiances from unquestioningly believing establishment's dogmas, to blindly opposing them. They now unquestioningly follow their new leaders, the artfully fabricated dissent-chiefs.

But they also attract some type-3, fortunately only temporarily, since fabricated dissent is trivially exposed to those unencumbered by blind-faith in power and its many incantations. See Weapons of Mass Deception for more in depth deconstruction of the diabolical Manufacturing of Dissent.

And for the most recalcitrant among the 'malcontent' unwilling to subjugate their own common and political sense to the devil's science, exclusively the type-3 of Hitler's classification whose value **“lies in their intelligence and not in their numerical strength”**, new modalities to discredit them are continually constructed. The latest being mental illness.

As reported in the Washington Post, if “there might be a legal entitlement to be a jerk”, most assuredly there will be legal entitlement to be a non-conformist, i.e., an independent thinker:

'Today's DSM defines “oppositional defiant disorder” as a pattern of “negativistic, defiant, disobedient and hostile behavior toward authority figures.” Symptoms include “often loses temper,” “often deliberately annoys people” or “is often touchy.” DSM omits this symptom: “is a teenager.”

This DSM defines as “personality disorders” attributes that once were considered character flaws. “Antisocial personality disorder” is “a pervasive pattern of disregard for . . . the rights of others . . . callous, cynical . . . an inflated and arrogant self-appraisal.” “Histrionic personality disorder” is “excessive emotionality and attention-seeking.” “Narcissistic personality disorder” involves “grandiosity, need for admiration . . . boastful and pretentious.” And so on.

If every character blemish or emotional turbulence is a “disorder” akin to a physical disability, legal accommodations are mandatory. Under federal law, “disabilities” include any “mental impairment that substantially limits one or more major life activities”; “mental impairments” include “emotional or mental illness.” So there might be a legal entitlement to be a jerk. (See above, “antisocial personality disorder.”) -- George F. Will, *The Washington Post*, February 28, 2010, **Handbook suggests that deviations from 'normality' are disorders**

It should now be self-evident that while a conspiracy is still active, or while mileage is being extracted from a clandestine operation that is on-going or an agenda that is being secretly pursued, or to hide or spin some other egregious wrong-doing, all analytical and deconstructive references to its unraveling must be squashed or dismissed. Inter alia, by defocussing attention from them, by introducing clever red herrings and side shows, and by labeling such detective work by the public as kookish “*conspiracy theories*”.

Its advocates, the few daring and persistent unravellers of “*truth's protective layers*”, to be marginalized by labeling them as fools, idiots, deniers of reality suffering from “*emotional or mental illness*”, an “*oppositional defiant disorder*” exhibiting a pattern of “*negativistic, defiant, disobedient and hostile behavior toward authority figures*” and therefore a threat to themselves and to society! Those resorting to any active opposition against the government's lies and deceit, such as through civil disobedience, to be designated as “*domestic terrorists*”.

And when the conspiracies are prematurely blown despite all the Machiavellian preemption efforts at masking them, to have the multiple cover stories ready for “*plausible deniability*”, including some version of “*limited hangout*”, using the ubiquitous Mighty Wurlitzer's message machine.

Is all this a fairy tale? The rabbit hole runs deep and permeates not just the news media and the privately funded think-tanks, but also the academe which is routinely tapped for

statecraft.

Cass R. Sunstein of Harvard Law School, the man who is today President Obama's Information Czar in the White House, in his 2008 paper titled **“Conspiracy Theories”**, called this process of the creation of diabolical red herrings, introducing **“beneficial cognitive diversity”** through **“cognitive infiltration”**. The paper has to be read in its entirety in order to be appreciated for its brazen and open appeal to Machiavelli for conducting statecraft when thinking people remain unencumbered by its mere propaganda spin.

What are these deceptions of statecraft if not real conspiracies by the establishment to mask their real clandestine covert-operations, untenable agendas, and wrong-doings?

Thus, if it is axiomatically asserted that there is no such thing as a real conspiracy, then that really works wonderfully in the interest of the cloak-makers because it makes one forget the perspectives of history.

And this complex Machiavellian deception game behind alleging 'kookishness' bears exposing fully: invent two or more lies, not just one, and keep the good hearted well meaning peoples in the “populist democracy” occupied debating which one of them might be true, for it would hardly matter what conclusions they reached. And wherever they ended up, to perhaps yank one of the lies from underneath them by conclusively showing it to be false thus conveniently demonstrating a baseless “conspiracy theory” in order to keep that notion alive in the public imagination. This consequently delegitimizes in the public mind serious researchers' efforts in uncovering any covert-operation while its secrecy is of paramount necessity. Afterwards, after faits accomplis, after statute of limitations expiring, it makes little difference if historians and confession artists make a pecuniary gain peddling what is inconsequential history to the newer evolving realpolitik du jour. The recognition of this self-evident truth of the matter and its utility to Machiavellian statecraft was boldly narrated even in the New York Times, quoting a senior advisor to the president of the United States at the time, George W. Bush:

***“That's not the way the world really works anymore,” he continued. “We're an empire now, and when we act, we create our own reality. And while you're studying that reality -- judiciously, as you will -- we'll act again, creating other new realities, which you can study too, and that's how things will sort out. We're history's actors . . . and you, all of you, will be left to just study what we do.”*** (Ron Suskind, NYT, Oct. 17, 2004)

So many complex semantics for the simple term “*conspiracy theory*” – it's not just mere nomenclature – that this overview of its usefulness to statecraft was necessary in order to situate anything with such a bombastic title as “*The Capitalist Conspiracy*”, in its proper social-political-legal-conspiratorial context.

And an equally insightful and rational response to this question of long enduring conspiracy for world domination, is added to the motivational mix by G. Edward Griffin in the video below:

**“After a man has far more money than he possibly can spend for pleasures, what is left to excite him? For those with the ruling class mentality, the answer is power – raw power over other human beings. Money can buy such power only to a point, beyond that, politics is the sport, and world politics is the ultimate game.”**

Thus, Griffin aptly noted: “*The New World Order Is Not New*”, but a common objective borne of natural inclination to primacy which apparently transcends time, space, geography and race. It naturally increases in its scope in proportion to the vistas of power it acquires. And it automatically attracts to its cause the coterie of sycophants and useful idiots essential in realizing its overarching agendas. It is helped along, as W. Cleon Skousen uncannily observed in his commentary in “*The Naked Capitalist*”:

**'The real value of Tragedy and Hope ... [is the] bold and boastful admission by Dr. Quigley that there actually exists a relatively small but powerful group which has succeeded in acquiring a choke-hold on the affairs of practically the entire human race. Of course we should be quick to recognize that no small group could wield such gigantic power unless millions of people in all walks of life were “in on the take” and were willing to knuckle down to the iron-clad regimentation of the ruthless bosses behind the scenes. As we shall see, the network has succeeded in building its power structure by using tremendous quantities of money (together with the vast influence it buys) to manipulate, intimidate, or corrupt millions of men and women and their institutions on a world-wide basis.'** (pg. 6)

Subsequent manipulation of global events through statecraft machinations become trivial when one has already taken over the state's machinery through its many essential instruments of policy-making. The same instruments today are behind the formulation of coercive policies for ostensibly addressing the myriad global crises plaguing mankind today

– from Global War on Terror to Global Financial Collapse to Global Epidemics to Global Warming to Global Food Shortage to Global Water Shortage etceteras – and for which, the solution posited, is of course Global Governance:

**'I have never believed that there is a secret United Nations plot to take over the US. I have never seen black helicopters hovering in the sky above Montana. But, for the first time in my life, I think the formation of some sort of world government is plausible. A "world government" would involve much more than co-operation between nations. It would be an entity with state-like characteristics, backed by a body of laws. The European Union has already set up a continental government for 27 countries, which could be a model. The EU has a supreme court, a currency, thousands of pages of law, a large civil service and the ability to deploy military force. So could the European model go global? There are three reasons for thinking that it might. First, it is increasingly clear that the most difficult issues facing national governments are international in nature: there is global warming, a global financial crisis and a "global war on terror".'** ( Gideon Rachman, And now for a world government, Financial Times, December 8, 2008 )

Right out of the box of user manuals for the ***"end run around national sovereignty"*** made available to the world through the benevolence of the Council on Foreign Relations:

**"In short, the 'house of world order' will have to be built from the bottom up, rather than from the top down. It will look like a great 'booming, buzzing confusion' to use William James' famous description of reality, but an end run around national sovereignty, eroding it piece by piece will accomplish much more than the old-fashioned frontal assault.**

**Of course, for political as well as administrative reasons, some of these specialized arrangements should be brought into an appropriate relationship with the central institutions of the U.N. system, but the main thing is that the essential functions be performed.**

**The question is whether this more modest approach can do the job. Can it really bring mankind into the twenty-first century with reasonable prospects for peace, welfare and human dignity? The argument thus far suggests it better had, for there seems to be no**

**alternative. But the evidence also suggests some grounds for cautious optimism.”** (Richard N. Gardner, *The Hard Road To World Order*, Foreign Affairs, April 1974, 558-559)

In summary, the upshot of it all is that it becomes a moot point what label one might give to this empirical predatory behavior wrapped in deception. Zbigniew Brzezinski even openly proclaimed its pertinence to statecraft in the very first sentence of his book mentioned earlier: **“Hegemony is as old as mankind”**. And Nicolò Machiavelli very perceptively outlined its recipe in *The Prince* whose modern reincarnation in murderous play on the Grand Chessboard has been to convince people of absurdities to get them to acquiesce to the atrocities and spendings of hegemony.

The undeniable fact remains that world-government has been a long historical passion of oligarchs! The quest for the hegemony of the entire world has been their natural enduring conspiracy for world government. Its new religion is secular humanism. Its new imperative is population reduction. Its primal modus operandi is deception, which, in its harbingers' own words, is to create *“an end run around national sovereignty, eroding it piece by piece [by making it] look like a great ‘booming, buzzing confusion’”*. And it is finally coming to its grand fruition in our own time with continuous newer myths and crises creation which span the gamut from 'Global Warming' to 'Global War on Terror', and more recently from 'Global Swine Flu Pandemic' to 'Global environmental disaster due to oil spill', each new crisis and myth leading to enacting new legalisms for incrementally eroding more national sovereignty while ushering in more police-state. In keeping with the “conspiracy theory” paradigm of statecraft, most useful idiots are kept busy mindlessly chattering on about “conspiracy theories” and “Islamofascism” in perfect echo with the Machiavellis. Enjoy Ed Griffin's narration in *The Capitalist Conspiracy* video, made in 1972!

### **The Capitalist Conspiracy**

<http://video.google.com/videoplay?docid=6260646431723948415>



### Further Study References

- [1] <http://print-humanbeingsfirst.blogspot.com/2008/09/capitalist-conspiracy-world-government.html>
- [2] <http://print-humanbeingsfirst.blogspot.com/2008/10/monetary-reform-bibliography.html>
- [3] <http://print-humanbeingsfirst.blogspot.com/2008/12/responseto-ft-gideon-rachman-worldgov.html>
- [4] <http://print-humanbeingsfirst.blogspot.com/2009/04/some-dare-call-it-conspiracy-garyallen.html>
- [5] <http://print-humanbeingsfirst.blogspot.com/2009/12/brilliant-world-order-bedtime-story.html>
- [6] <http://fas.org/sgp/advisory/state/covert.html>
- [7] [http://papers.ssrn.com/sol3/papers.cfm?abstract\\_id=1084585](http://papers.ssrn.com/sol3/papers.cfm?abstract_id=1084585)
- [8] <http://video.google.com/videoplay?docid=8605813744843314322>
- [9] <http://print-humanbeingsfirst.blogspot.com/2010/04/enduring-power-of-machiavellian-polysci.html>
- [10] <http://print-humanbeingsfirst.blogspot.com/2009/05/note-on-mighty-wurlitzer.html>

[11] <http://print-humanbeingsfirst.blogspot.com/2008/06/wmd-master-social-science.html>

[12] <http://print-humanbeingsfirst.blogspot.com/2008/12/ali-baba-in-mumbai-eid2008-reflections.html>

[13] <http://print-humanbeingsfirst.blogspot.com/2009/03/war-on-terror-not-about-islamofascism.html>

**Short URL:** <http://tinyurl.com/anatomy-of-conspiracy-theory>

**Source URL:** <http://print-humanbeingsfirst.blogspot.com/2010/03/anatomy-of-conspiracy-theory.html>

First Published March 2010



## Chapter 6 The Fable of the Bees

### The Seduction of Science and Technology

At least some of us often lament after the fact, like all hypocrite scientists the world over, of our short-sighted pursuits in discovering sciences and inventing technologies which end up having detrimental long term impact on society.

Please watch this one hour talk by Dr. Eric Fossum, Professor of Engineering in Dartmouth's Thayer School, at Yale University:

#### Eric Fossum on Societal Concerns of his Invention

<http://www.youtube.com/watch?v=JkBh71zZKrM>



Eric Fossum is the inventor of the active CMOS imaging chip, the "camera-on-a-chip" technology which *"is used in nearly all camera phones and webcams, digital-still cameras, high-speed motion capture cameras, automotive cameras, dental x-ray cameras, and swallowable pill cameras."* according to the Yale University blurb for the talk. Dr. Eric Fossum's Bio is revealing of his intense passion for his chosen profession and the applause he has accumulated for his achievements, all of which can be gleaned from his websites <http://ericfossum.com/> and <http://engineering.dartmouth.edu/people/faculty/eric-fossum/>.

I am going to write this great inventor of sliced cake a letter and send him a link to my own

high-tech career and why I left it:

<http://zahirebrahim.wordpress.com/2009/05/29/ieee-spectrums-special-report-25-microchips-that-shook-the-world-may-09-2009/>

"While I did not work on this first version of the SPARC chip (joining just as it was in its final finishing stages), I did on subsequent generations of microchips, systems, and operating systems over the next decade (Sun-4 and Sun-5). This is how I too, albeit in a small way, helped usher in George H.W. Bush's infamous vision of the "New World Order", for without these microchips, there surely wouldn't be one! While the monumental crimes against humanity of the two World Wars in the past century were perpetrated without the aid of microchips, the present enslaving of humanity into the surveillance society of 'one-world government' is only effectuated with the help of the Technetronic Revolution wrought by these microchips. See Zbigniew Brzezinski's "Between Two Ages: America's Role in the Technetronic Era".

While IEEE Spectrum today celebrates this revolution, noting:

***"Their designs proved so cutting-edge, so out of the box, so ahead of their time, that we are left groping for more technology clichés to describe them. Suffice it to say that they gave us the technology that made our brief, otherwise tedious existence in this universe worth living."***

as a direct participant with two dozen design patents on microchips and systems, I am not so sure. A simpler times now appear more appealing. Not much of a short-break, was this! We are still talking about NWO. Everything appears interrelated and interlocked. To make a decent moral living, minimally doing no harm, ideally doing good things and leaving a positive legacy rather than a negative one, appears well-nigh impossible. There is just no escape from the New World Order. Arguably, we all contribute to it in some way in the modernity du jour – unless we choose to escape the modern-age and live on pastoral farms and in the mountains.' --- Zahir Ebrahim's response to IEEE Spectrum's Special Report: 25 Microchips That Shook the World. May 2009

In addition, the following letter I had previously written a Harvard computer scientist who

was excitedly moving to Google Labs thinking he is going to make a big societal difference, may be revealing to the brilliant designers of world's weapon systems and other misanthropic and enslaving technologies who still to this day think they have created sliced cake in a world in which the vast majority are unable to afford dry bread for one square meal a day:

<http://bloghumanbeingsfirst.wordpress.com/2010/11/19/response-to-why-im-leaving-harvard-by-zahir-ebrahim/>

I had concluded that letter to the Harvard computer scientist with the observation:

'the brilliant professors at Harvard and elsewhere equally know which side their bread is buttered in just as much measure, if not more, than any ordinary 'Good American' slaving in this system of governance and production whose entire outlook for the past century has been conditioned not by morality (except in Newspeak), but by primacy, hegemony, and by their own admission, by their quest for "full spectrum dominance". That requires riding the full monte of the 'Technetronic Era' of which both of you computer science professors speciously arguing which side of the fence is greener, are equally a part.

May I dare to hope in conclusion that with your prominent voice and brilliant credentials, that you might perhaps be motivated by this humble letter to explore this topic objectively while you are still at Harvard – as the fiscal burden to be 'acceptable' is now presumably less for you – and leave a legacy which to my mind can have far reaching and very existential consequences for all Americans. You will surely not have this opportunity at Google where, by your own admission and statement of blind aspiration: ***"I get to hack all day."*** After you have built your nth system, as one of the generations caught "Between Two Ages", you may be left wondering why you did it at all when you wake up in a full-blown "1984" one day soon and still have some commonsense left to recognize it as such.

Your children and grandchildren however, will mercifully be spared that recognition as they will habitually count, from the very day of their birth, two plus two equal five. Some Americans, perhaps the majority, are already there today. The simple question I often ask of smart peoples who might dare to escape that fate, and I leave you with that little question, how can one know that one can add correctly?' --- Zahir Ebrahim's letter to Matt

Welsh, recently tenured full professor of Computer Science at Harvard University who announced his intent to move to Google Labs for better actualization of his technological passions, November 24, 2010

Please watch the aforementioned one hour technical talk by Dr. Eric Fossum which makes much ado about societal responsibility of great inventors – the first one that I have encountered which is as candid and honest as it is! What I had hoped to achieve in Matt Welsh and failed, he did not even bother to acknowledge that letter and MIT Technology Review turned it down as a worthy discussion topic to seed at MIT, I already see Dr. Eric Fossum doing. Few men of science, technology, and industry ever grapple with any of these issues or dare to go there when they are in the prime of their careers heartily pursuing it. Usually, a handful only venture there after the fact, ex post facto, after the genie is out of the bottle and cannot be put back in. Like M.I.T.'s own former president Jerome B. Wiesner (1971-1980), who, after presiding over the buildup of the same militarized society, upon retirement from his top academic post in the most militarized country on earth, thought it most conscionable to make the following banal statement of moral clarity:

“This irrational behavior is only possible because we, the citizens of the nation, permit it. It is no longer a question of controlling a military-industrial complex, but rather, of keeping the United States from becoming a totally military culture.” — The United States: A militarized society, Jerome B. Wiesner, president emeritus MIT, Bulletin of the Atomic Scientists, Aug 1985, pg. 104

This is the outline of Jerome B. Wiesner's own militarized career according to wikipedia:

“Jerome B. Wiesner (May 30, 1915 – October 21, 1994), was associated with MIT for most of his career, joining the MIT Radiation Laboratory in 1942 and working on radar development. He worked briefly at Los Alamos, returned to become a professor of Electrical Engineering at MIT, and worked at and ultimately became director of the Research Laboratory of Electronics at MIT (RLE). He became Dean of the School of Science in 1964, Provost in 1966, and President from 1971 to 1980. He was also elected a life member of the MIT Corporation.”

These much noted pangs of belated conscience evidently make zero impact on the dystopian forces which they unleashed in their heyday, or, as one often wonders, upon their own decrypt soul as they “*died holily in their beds.*” (Macbeth 5:1:47-49 - “Yet I have known

those which have walked in their sleep who have died holily in their beds.”) Perhaps this is why it is respectable to make them upon retirement. Inter alia, it helps maintain the illusion of individual liberties and intellectual freedoms in Western societies and loosely equated with moral gravitas of its most illustrious peoples.

Well, in Eric R. Fossum I have finally discovered one lonely high-tech scientist at Dartmouth College, with the notable pedigree of Yale, Caltech, NASA Jet Propulsion Laboratory, and Columbia University, grappling with these weighty matters as the key inventor of a technology right at the very peak of his invention which he laments has accelerated the comeuppance of Big Brother like no other single invention in the Post World War II era. That show of moral awareness and greater societal concern is of course both timely and good.

But what does our man of superlative conscience Dr. Eric Fossum do after the great show of moral gravitas and intellectual tour de force?

Does he stop and desist, let alone attempt to rectify the forces he has helped unleash?

No! Of course not.

Dr. Eric Fossum simply dumps the problem onto the dumb onlookers cheering him on, and moves on with inventing/heralding more of the same dystopian world order!

Dr. Eric Fossum is now a technical consultant for Samsung Electronics, and even more diligently pursuing newer more imaginative ways to usher in Big Brother surveillance gadgetry in the serene new academic setting of New Hampshire. He blithely claims ***“I don't really like this application of my technology. There is nothing I can do about it, I have now unloaded that on you, so thank you.”***

Of course, who does not like the sound of applause, medals clanking, and all the high honors which accompany pious high-mindedness, not to mention induction into the National Inventors Hall of Fame, 2011? That veritable show of societal concern for humanity in his talk may now even beget Dr. Eric Fossum the Nobel Peace Prize – or, at least a nomination. When Global Warming scholarship can win the vice president of the United States, Dr. Al Gore such magnificent accolades, surely Dr. Eric Fossum is far ahead in his moral exercise of the scholarship of conscience he so dignifiedly proffered in his talk on the impact of his real science.

Below are some pertinent fragments captured from Dr. Eric Fossum's superfluity of societal concerns from his aforementioned talk at Yale University, titled *Photons to Bits and*

*Beyond: The Science & Technology of Digital Image Sensors:*

"Societal issues questions baggage I have been carrying around with me for a few years and I am going to unload on you" (time 0:05:38)

"There is another set of issues which is loss of privacy from all this networking. When I first invented this CMOS image sensor technology we got a little bit of publicity and a reporter for the BBC radio came and talked to me, interviewed me, and he said:

'so tell me how you feel about the fact that now Big Brother is gonna be able to spy on us a lot better with all these cameras'.

And I said:

'oh it's not really a problem because there is not enough people to watch all the video screens and all cameras that are out there and we don't have to worry.'

But to my surprise, and chagrin a little bit, you know now computers can analyze images, and computer systems can track you based on facial recognition software from camera to camera to camera, as you might move around in a highly surveilled city for example.

And, so that means that you will be tracked and all your activity completely logged. It's on your permanent record now, whatever you did, or something you really don't want people to know about.

You know, is that a good thing? I don't think so. I feel like it's an invasion of my privacy." (time 0:15:40)

"I don't really like this application of my technology. There is nothing I can do about it, I have now unloaded that on you, so thank you.

We'll get back to the science and technology now, but I hope you also worry about these things and I especially hope you figure out what we are gonna do about this in the future." (time 0:20:30) --- Dr. Eric Fossum, Yale, Oct 13, 2011

Are semi-conscious realizations devoid of deep convictions sufficient? I am in fact

unhappily waiting for the time when Eric Fossum after retirement may well make the same statement as was made by M.I.T. president Jerome B. Wiesner ex post facto: ***“But realization is not enough. It must become informed conviction based on personal study.”*** (op. cit., pg. 105)

The above lamentable state of moral hypocrisy was aptly captured by a young man reading an initial version of this missive sent to high-tech scholars and scientists:

'Of course I am always reminded of Oppenheimer the day after Trinity <http://www.youtube.com/watch?v=l8w3Y-dskeg> by things like this. Now he knew what was to come <http://www.youtube.com/watch?v=PuX7mx-PIY4> (much better than *"I really don't like this application of my technology but there is nothing I can do about it. I have now unloaded it on you so thank you".*) Oppenheimer also realized it, and feeling the way he did, never did stop. And Fossum of course continues soldiering ahead despite his "anxiety closet"...a "comforting" construct :)

[These Technetronic Era usherettes] can always take comfort in:

[http://www.roadkilltshirts.com/Assets/ProductImages/PS\\_0887\\_KILL\\_PEOPLE\\_DR.jpg](http://www.roadkilltshirts.com/Assets/ProductImages/PS_0887_KILL_PEOPLE_DR.jpg)

So let's keep building...

<http://www.youtube.com/watch?v=iX6YvWxtrw> '

As my own more limited contribution to this Big Brother menace indicates (see link to my response to IEEE 25 microchips that changed the world noted above), this dystopia of global servitude was already predicted, and indeed eagerly anticipated, inter alia by Zbigniew Brzezinski in 1970 in his **"Between Two Ages – America's Role in the Technetronic Era"**; by Bertrand Russell in 1951 in his **"The Impact of Science on Society"**; by H. G. Wells in 1940 in his **"The New World Order"**; etceteras, going all the way back to the turn of the 20th century, all portending the inevitability of, and the beneficial desirability of, global scientific dictatorship! Bertrand Russell even went out of his way to pseudo-philosophize its desirability, explaining the need for Big Brother which Dr. Eric Fossum now feels so uncomfortable about: ***“World government could only be kept in being by force.”*** (op. cit., pg. 37)

Who and what enables this inevitability which has been so eagerly anticipated by the elites who own the vast military-industrial complexes which fund the sciences and technologies,

and who wish to enslave mankind in their own web of controlled hegemony?

These are not science fiction novels and allegorical essays by imaginative behaviorists like Aldous Huxley's 1931 "**A Brave New World**" and George Orwell's 1948 "**1984**", but philosophical works in political science on rationalizing global scientific dictatorship. The most reliable disclosure of the impending world order still remains Georgetown University School of Foreign Services' long time professor, Dr. Carroll Quigley's 1966 magnum opus, *Tragedy and Hope*. While even ordinary high-schoolers in the West have enjoyed Huxley and Orwell as great dystopian literature, rare is the physical scientist directly ushering it in who has even heard of these other political science works which rationalize and justify the exercise of global hegemony.

Dr. Zbigniew Brzezinski, former American president Jimmy Carter's National Security Advisor (1976-198), even began his next most influential book of 1996, "The Grand Chessboard – American Primacy and Its Geostrategic Imperatives", with the sweeping rationalization statement for the title and content of his book: "*Hegemony is as old as mankind.*"

Well, the answer to that question is not so un-obvious to those with even a modicum of commonsense. It is guys like Eric Fossum, and the million engineers and scientists in Silicon Valleys across the world. Everyone of them most passionately laboring in the military-industrial complex of their nation without reflection under various civilizational burdens that span the full gamut of intellectual rigor, from '*la mission civilisatrice*' to national defense to passionate self-interests! Just ordinary people who are narrowly so seduced by their own chosen professions and self-interests, never mind the patriotism drilled into them, that the corruption of their own soul which begets the corruption of their intellect, remains invisible to them! Just as it is to Eric Fossum.

Should I excitedly applaud Dr. Eric Fossum for his hypocrisy and his skin deep moral clarity? Or, should I endeavor to unravel it?

How did we get to this stage of modernity that we make such wonderful useful idiots, often self-servingly harboring a moral clarity and cleanliness of sweet smelling conscience which evidently surpasses even Macbeth's proclamation to his guilt-ridden wife to just feign it: "*Be innocent of knowledge*"? (Macbeth 3:2:45)

But first, indeed I am in fact going to thank Dr. Eric Fossum, for whatever he has stated only helps me make my case even more compellingly. Fossum is not alone in this state of passionate moral decay which I too once occupied. In fact, among all those occupying that



state today in Silicon Valley and elsewhere, Dr. Eric Fossum is a bit ahead in the game because he evidently at least recognizes the obvious. He can still pay a tad more effective attention to his own moral gravitas than just high-minded lip service: ***“I don't really like this application of my technology. There is nothing I can do about it, I have now unloaded that on you, so thank you.”*** Matters are not yet wholly fait accompli. While our war-mongering modernity still infected by the stone-Age virus of primacy, is premeditatively hurtling headlong into something grotesquely abhorrent which the entire history of mankind has never witnessed before this Technetronic Era – a global scientific dictatorship which has been self-realizingly predicted for close to a century – we aren't there yet! This insane path is not by happenstance, but by engineered design which motivates and incentivizes the worker-bees to make the honey-pot towards that very outcome.

### **How did we get to this co-opting modernity?**

Below is just a cursory roadmap of how we got to this modernity that I have been able to piece together as an amateur historian, amateur social scientist, and former professional technologist who walked away from the same highly applauded passions in the same engineering profession as Eric Fossum, now thanklessly applying the same rational skills in a new passionate hobby. A hobby that is of utmost existential import and of immediate pertinence to mankind's survival as an independent, sentient, and thoughtful moral beings, but for which there is no applause. No medals. No prizes. Only hemlock. Influential scholarly scientists like Dr. Eric Fossum can and do make substantial difference to this calculus, in any direction. So why not in the direction their own inner moral voice uncannily whispers to them – rather than continuing in the suicidal direction of their baser instincts, passions and self-interests?

In order to be most succinct in this outline and still make sense to brilliant people unlearned in their own nation's literature of primacy, I must begin by quoting Edward Bernays:

“The conscious and intelligent manipulation of the organized habits and opinions of the masses is an important element in democratic society. Those who manipulate this unseen mechanism of society constitute an invisible government which is the true ruling power of our country.” --- Edward Bernays, Propaganda, 1928, pg. 1. Cited in Zahir Ebrahim, The Mighty Wurlitzer, 2011 ( <http://tinyurl.com/The-Mighty-Wurlitzer-PDF082011> )

The necessity of maintaining and manipulating a public's ignorance and perceptions through self-indulgences, through deliberately dumbing them down with bread and circuses, though wholly self-evident today, was already well thought out at the very dawn of

the industrial age in the early eighteenth century. Bernard de Mandeville in his famous classic *The Fable of the Bees*, observed:

“The economic well-being of the nation depends on the presence of a large number of men who are content to labor hard all day long. Because men are naturally lazy they will not work unless forced by necessity to do so.” ---  
Bernard de Mandeville, *The Fable of the Bees*, 1705

That philosophy, to create **“a large number of men who are content to labor hard all day long ... forced by necessity”** espoused in *The Fable of the Bees*, inspired Adam Smith, the author of *The Wealth of Nations*, to propose the pursuit of selfish industriousness for the overall common good. Of course, common good primarily of the ruling class with trickle-down economics, but that's just buried in the *Newspeak* definition of *common good* where the common man labors hard all day long, and the elites enjoy the good. Patterned upon the bees collectively making that marvelous tasting honey for the enjoyment of the bears, each bee myopically and narrowly staying busy in its own specialized micro-task **“content to labor hard all day long”**, rests the entire edifice of modern civilization.

This philosophy of selfish myopic industriousness for common good has been very sagaciously adapted to the high-tech age of the Technetronic Era. Modernity requires rather high-tech specialized worker-bees, with the commensurate twist of creating educated morons with advanced university degrees who can very patriotically **“United We Stand”** for the common good while staying productively engaged in narrow specializations in the military-industrial economy! This man-made value system of human beings as economic widgets **“content to labor hard all day long”**, has today spread like a virus across the full gamut of gainful employment in the globalized corporate world, from blue collar to white collar, from traders to craftsman, from technicians to scientists, from superficial generalists to narrow-gauged specialists.

Kept perpetually too busy to either think independently, morally, holistically, and outside their parameters of narrow-gauge specializations by the sheer demands of having to pay their endless debt-bills in pursuit of their endless “American Dreams”, and conversely, by ensuring that a handful of the more successful and most intellectual ones are so generously rewarded and applauded for their narrow-gauge specializations that they become vested in their own successes continuing, statecraft today relies on inflicting *The Fable of the Bees* upon man for its own dystopian functioning. It is therefore no surprise that possession of technological information and technical skills to manipulate matter, has been recast as profound human knowledge, and parrots and fools have been turned into

learned savants.

A state of modern affairs which infects modern man quite democratically. We are, despite all the vast data on our fingertips in this Information Age, and despite all the sophistication of modern gadgetry, still living in the age of *Jahiliya* (ignorance)! This ignorance is by artful design in the industrious West, especially in the sole superpower, United States of America – as already examined by this scribe in his maiden 2003 book *Prisoners of the Cave* which analyzed the condition of mass ignorance among the people of the United States, keyed off from the blueprint for “*imperial mobilization*” outlined by Dr. Zbigniew Brzezinski in his 1996 ode to American Primacy and Its Geostrategic Imperatives, *The Grand Chessboard*.

This state of affairs is not just due to the happenstance of knowledge explosion in modernity as Zbigniew Brzezinski would have the gullible thoughtlessly believe. Brzezinski had speciously observed in his earlier 1970 book that “*the threat of intellectual fragmentation, posed by the gap between the pace in the expansion of knowledge and the rate of its assimilation*”, is what causes general myopia in the *Technetronic Era*. Well, such perception molding is very convenient to promulgate. It justifies, nay dignifies, the lack of awareness among the learned living in industrialized societies under great self-obsessions and unbridled self-indulgences.

That state of being enables keeping the public, even the most educated of the lot, quite ignorant of what really matters to statecraft: the absence of awareness among the worker-bees that they are really toiling for the bears, while they glorifyingly slave in their own narrow-gauge specializations for one motivation or another. Here is Zbigniew Brzezinski's sophistry which attempts to pseudo-philosophize the information explosion conversely impacting individual awareness and intellectual cohesion:

'... it can be argued that in some respects "understanding" ... is today much more difficult for most people to attain. ...

The science explosion – the most rapidly expanding aspect of our entire reality, growing more rapidly than population, industry, and cities – intensifies, rather than reduces, these feelings of insecurity. It is simply impossible for the average citizen and even for men of intellect to assimilate and meaningfully organize the flow of knowledge for themselves.

In every scientific field complaints are mounting that the torrential outpouring of published reports, scientific papers, and scholarly articles and the proliferation of professional journals make it impossible for individuals to

avoid becoming either narrow gauged specialists or superficial generalists. The sharing of new common perspectives thus becomes more difficult as knowledge expands; in addition, traditional perspectives such as those provided by primitive myths or, more recently, by certain historically conditioned ideologies can no longer be sustained.

The threat of intellectual fragmentation, posed by the gap between the pace in the expansion of knowledge and the rate of its assimilation, raises a perplexing question concerning the prospects for mankind's intellectual unity.' --- Zbigniew Brzezinski, *Between Two Ages*, 1970, pg. 15

Let me highlight the two key empirical observations from that aforementioned passage: ***“make it impossible for individuals to avoid becoming either narrow-gauged specialists or superficial generalists. The sharing of new common perspectives thus becomes more difficult as knowledge expands;”***. The self-serving cyclic argument of Brzezinski is that firstly, ignorance about knowledge, due to the sheer explosion in knowledge, is the natural outcome of scientific modernity. Secondly, that people can no longer easily reach a common *“understanding”* of their common condition. Both those observations are empirically true today.

But one can easily imagine an alternate modernity where that need not be the case despite the abundance of knowledge explosion. It was the corporatization of knowledge in the service of empire in the vast military-industrial-academe complexes of the industrialized world, and its tight coupling to the exercise of hegemony, that has made it so. Science and technology today equate with hegemony. Therefore, since the quest for hegemony is perpetual, its ultimate expression being world government, those pursuing science and technology have to continue passionately slaving in the service of empire as *“narrow-gauged specialists”* often unaware that their honey-pot is being harvested by the bears calculatingly funding the worker-bees.

Just as Matt Welsh, the Harvard Computer Scientists wanted to do by his own bold admission: ***“I get to hack all day.”*** as the principal reason to move to Google Labs.

How are such ardent worker-bees ever to find the pause for reflection on what they are doing while they are busy doing it? The incentives and motivations in this ecosystem naturally enable talented and passionate people like Matt Welsh, Eric Fossum, and the rest of Silicon Valley to create the larger dystopia in baby steps while pursuing their own selfish narrow interests.

It is a self-serving, self-sustaining game of flourishing myopia in this welcoming age of *Jahiliya* (ignorance) which feeds upon itself in a positive feedback loop. Anyone and everyone who has the natural talent is invited to become a zealous worker-bee with the promise of the honey-pot dangled at the end of the rainbow. The concomitant loss of “*understanding*” although a natural outcome of such myopic industriousness, isn't just incidental to knowledge explosion as Brzezinski has tried to portray it. It is in fact according to a premeditated plan, deftly put into motion at the very onset of Western industrialization for the crafting and harvesting of **“a large number of men who are content to labor hard all day long.”**

Such bold perception management via distortions and half-truths, and the **“conscious and intelligent manipulation of the organized habits and opinions of the masses”** which Edward Bernays empirically demonstrated in his own craftsmanship of Propaganda that is best described today as the many tunes played on *The Mighty Wurlitzer*, is at the very heart of what continually enables and sustains the elite's primacy dealings in **“straight power concepts”**:

'We have about 50% of the world's wealth, but only 6.3% of its population .... In this situation, we cannot fail to be the object of envy and resentment. Our real task in the coming period is to devise a pattern of relationships which will permit us to maintain this position of disparity without positive detriment to our national security. To do so, we will have to dispense with all sentimentality and day-dreaming, and our attention will have to be concentrated everywhere on our immediate national objectives. We need not deceive ourselves that we can afford today the luxury of altruism and world-benefaction .... We should cease to talk about vague and – for the Far East – unreal objectives such as human rights, the raising of living standards, and democratization. The day is not far off when we are going to have to deal in straight power concepts. The less we are then hampered by idealistic slogans, the better.' --- Top Secret Memo, underpinning of the *Truman Doctrine* for four decades, PPS No. 23, by George Kennan, Head of the US State Department Policy Planning Staff. Written February 28, 1948. Declassified June 17, 1974

The exercise of **“straight power concepts”** however require more than just sustained propaganda. It requires social structures which enable the magnificent social engineers to engineer the public's consent for the misanthropic exercise of those very power concepts such that **“a large number of men who are content to labor hard all day long.”** Here is behaviorist and essayist Aldous Huxley explaining the reality of social engineering towards

the “*ultimate in malevolent revolution*” for those unable to perceive it for themselves, in his talk at the University of California at Berkeley a half-century ago:

'You can do everything with bayonets except sit on them! If you are going to control any population for any length of time you must have some measure of consent. It's exceedingly difficult to see how pure terrorism can function indefinitely. It can function for a fairly long time, but I think sooner or later you have to bring in an element of persuasion. **An element of getting people to consent to what is happening to them.** Well, it seems to me that the nature of the Ultimate Revolution with which we are now faced is precisely this: that we are in process of developing a whole series of techniques which will enable the controlling oligarchy who have always existed and presumably always will exist, **to get people actually to love their servitude! This is the, it seems to me the ultimate in malevolent revolution shall we say.**

And this is a problem which has interested me for many years, and about which I wrote thirty years ago a fable, *A Brave New World*, which is essentially the account of a society making use of all the devices at that time available, and some of the devices which I imagined to be possible, making use of them in order to, first of all, to standardize the population, to iron-out inconvenient human differences, to create so to say mass produced models of human beings arranged in some kind of a scientific caste system.

And since then I have continued to be extremely interested in this problem. And I have noticed with increasing dismay that a number of the predictions which were purely fantastic when I made them thirty years ago, have come true or seem in process of coming true. That a number of techniques about which I talked seem to be here already. And there seems to be a general movement in the direction of this kind of ultimate revolution. This method of control by which people can be made to enjoy a state of affairs which by any decent standard they ought not to enjoy, the enjoyment of servitude, well, this process as I say has gone on for over the years.' --- Aldous Huxley, 1962 speech at UC Berkeley, minute 04:06

Among those societal structures and methods of control “**by which people can be made to enjoy a state of affairs which by any decent standard they ought not to enjoy, the enjoyment of servitude,**” is the obvious structure of inducements and rewards to play along. And the converse punishment, the marginalization and ostracization for challenging

it. We see these incestuously self-reinforcing methods and structures straightforwardly in the incentivization to simply soldier on in the military-industrial-academe complex regardless of the consequences of one's labors and inventions. From Nobel Prize to induction into Inventors Hall of Fame, academic tenures to celebrity statuses, and the opportunities to ***“get to hack all day.”*** to vie for these few honey-pots, are all systems of entrapment and control which assist in that social engineering to militarize, scientifically organize, and standardize free societies for maximizing the exercise of *“straight power concepts”* both globally and domestically. Its natural culmination is a global scientific dictatorship of those at the top of the pyramid, managing a scientific caste system many elements of which are already visible in the 300 years old control modulus that is continually crafting ***“a large number of men who are content to labor hard all day long.”***

Staying morally and intellectually awake in this misanthropic ecosystem which by definition is threatening to *“mankind's intellectual unity”* as free human beings, but which can only thrive when its military-industrial complexes deal in *“straight power concepts”*, and which puts everyone greedily participating in that mal-constructed ecosystem into a zombie-like sleep-state in order to get them to incessantly endeavor as *“narrow-gauged specialists”* worker-bees enjoying their servitude in a positive feedback loop that only accelerates the same dystopian conditions generation after generation, one has to effectively sever that positive feedback loop.

As most competent engineers and physicists already know, a positive feedback path only culminates in an eventual cataclysmic explosion.

That is the path which puts science and technology in the service of empire – rather than humanity – just like the one Eric Fossum and millions like him have thoughtlessly been on for their own self-gratification.

Planned and engineered into practice on the blueprint of *The Fable of the Bees*.

### **What's the way out?**

Is it rocket science to figure that out after all the preceding verbiage?

To reverse the march of modernity towards its premeditated global scientific dictatorship, conscious principled refrains and conscious principled deterrent acts, and not just mere nods to high mindedness, are necessary for its own harbingers.

It begins with the individual perceptively taking moral responsibility for his or her own

passionate pursuits before sowing a fait accompli, for being holistically cognizant of how they earn their bread and butter before they let the genie out of the bottle, rather than piously making a cleansing statement after the fact and moving on to more of the same: ***“I don’t really like this application of my technology. There is nothing I can do about it, I have now unloaded that on you, so thank you. We’ll get back to the science and technology now, but I hope you also worry about these things and I especially hope you figure out what we are gonna do about this in the future.”***

That is the path of principled refrain. Every individual is capable of such conscious acts of refrain – provided their moral clarity is not skin deep. Statement like: ***“But realization is not enough. It must become informed conviction based on personal study.”***, that are made in lip-service and hypocrisy ex post facto, are the guiding beacon of moral conduct provided one has the ability to acquire that realization, and the ability to make a living in arenas not in conflict with these realizations. The modern scientific society wholly taken over by the misanthropic military-industrial complex and patterned upon *The Fable of the Bees*, is designed ab initio to preclude exactly these realizations when the worker-bees are in their most productive years.

The path of principled deterrence requires new negative feedback paths to be instantiated in this dystopian ecosystem – and that can only be effectively seeded by the same technocratic elite, like Dr. Eric Fossum.

## **Conclusion**

The seduction of blind passions, be it between tragic lovers, or between Faust and its endless disciples, only culminates in abhorrence. The seduction of science and technology is even more pernicious because unlike ill-fated lovers instantly smitten on first sight, or Faustian bargains initiated with handshakes, this co-option occurs in small baby steps, one day at a time, one accolade at a time, and before one knows it, one has become an Eric Fossum. Evidently, it can also leave no permanent trace in the conscience which cannot be straightforwardly effaced by the cheapest perfumes of Arabia. The blueprint patterned upon *The Fable of the Bees* is engineered to ensure that very co-option. To preempt that co-option requires a social awareness and unselfish priority to societal concerns which can usually only emanate among those not directly beholden to an empty stomach. Because the harbingers of this perverse ecosystem also understand the potential threats to their dystopia, they ensure its mitigation through perpetual debt-bills and taxation, fostering lack of awareness, and glamorizing and incentivizing selfishness when the worker-bee is in its most productive period.



**Short URL:** <http://tinyurl.com/The-Fable-of-the-Bees>

**Short URL:** <http://tinyurl.com/Fable-of-the-Bees>

**Source URL:** <http://print-humanbeingsfirst.blogspot.com/2011/11/seduction-of-science-and-technology.html>

First Published November 10, 2011

## Chapter 7 Medicine in the Service of Empire

### What's the truth about modern medicine?

This comprehensive forensic article looks at the world of modern medicine from an alternate perspective. And oh what a difference even a slight shift can make!



Caption Perspective: Oh what a difference even a slight shift can make!  
(Image source: Desiree L. Rover's Presentation on Vaccinations, August 1, 2009)

I

We already know what the perspective is from the eyes of innocence. It is best captured in the momentous words of international banker and chairman emeritus of Chase Manhattan Bank, David Rockefeller himself: *“Improved public health, has caused the world's infant mortality rate to decline by 60 percent over the last 40 years. In the same period, the world's average life expectancy has increased from 46 years in 1950s to 63 years today. This is a development which as individuals we can only applaud.”* (see full speech below)

To examine the perspective from the eyes of a predator however, perhaps the best place to begin is with my exclamation on learning the following:

***“Bed-bugs cause smallpox! I had no idea. In Pakistan, as children, like all of our generation in most developing nations, we were inoculated against smallpox and I remember being taught that it was spread by human contact!”*** — Zahir Ebrahim’s incredulous response to the sleuthing by Twelfth Bough on their discovering the remarkable research of Dr. Charles A. R. Campbell, M. D. and the following revealing talk by medical research journalist Desiree L. Rover.

**Vaccinations, Weapons of Mass Destruction - State of the Planet  
Conference, August 1, 2009**

[youtube=<http://www.youtube.com/watch?v=P8QKSMK2Ytw>]



## EDUCATION & CONTROL

- **1847** *American Medical Association (AMA)*
- **1850** *Bill Rockefeller poses as a doctor (Nujol, Flit)*
- **1890** *University of Chicago (John D. Rockefeller)*
- **1903** *Rockefeller Institute for Medical Research*
- **1904** *Rockefeller Education Fund (take-over medical education)*
- **1910** *Flexner Report*
- **1927** *International Education Board (Rockefeller)*



03:27 / 56:42



480p



You Tube



## EUGENICS

- **1863** *Galton creates eugenics*
- **1904** *Cold Spring Harbor (eugenics, Human Genome Project)*
- **1910** *Eugenics Record Office, Cold Spring Harbor*
- **1921** *2nd International Conference on Eugenics, New York*
- **1921** *Birth Control League Margaret Sanger*
- **1925** *American Eugenics Society (in Yale university)*
- **1926** *Kaiser Wilhelm Institut (eugenics, today: Max Planck Institut)*



05:47 / 56:42



480p



You Tube





Caption: Some slides from Desiree Rover's presentation

Now let's watch David Rockefeller whose grandfathers were the key architects of modern Western medicine, express his grave concerns for overpopulation.

### David Rockefeller speaks about population control at the UN Ambassadors' Dinner

[youtube=<http://www.youtube.com/watch?v=C1qUcScwnn8j>]



Transcript: **“Ironically however, the very innovations that are making possible dramatic improvements in human well-being are also creating new problems which raise the spectre of an alarming and possibly**

**catastrophic disaster to the biosphere we live in. And herein lies the dilemma that we all face.** Let me illustrate. Improved public health, has caused the world's infant mortality rate to decline by 60 percent over the last 40 years. In the same period, the world's average life expectancy has increased from 46 years in 1950s to 63 years today. This is a development which as individuals we can only applaud. **However the result of these positive measures is that the world population that has risen during the same short period of time geometrically to almost 6 billion people, and can exceed easily 8 billion by the year 2020. The negative impact of population growth on all of our planetary eco-systems is becoming appallingly evident.** The rapid growing exploitation of the world's supply of energy and water is a matter of deep concern. And the toxic by products of widespread industrialization and increased atmospheric pollution to dangerous levels. Unless nations will agree to work together to tackle these cross-border challenges posed by population growth over consumption of resources and environmental degradation, prospects for a decent life on our planet will be threatened. **The recent UN meeting in Cairo is appropriately focussed on one of these key issues, population growth.** But the controversies which have erupted at the conference illustrate the problem of coming to grips with issues that are deeply divisive and which have a profound moral dimension. The United Nations can and should play an essential role in helping the world find a satisfactory way of stabilizing the world population and stimulating economic development in a manner that is sensitive to religious and moral considerations. Economic growth is of course an inevitable corollary of a growing population, and is essential to improved standards of living. But without careful coordination, unrestrained economic growth poses further threats to our environment. **This was a major subject of discussion at the conference in Rio de Janeiro on the environment two years ago. The focus then was on sustainable growth, and global development.** [Agenda 21] It was pointed out at the conference that growth is most efficiently managed by the private sector, but regulation of the process by national governments and international bodies is also needed. And once again, United Nations can certainly be among the catalysts and coordinators of this process.” — David Rockefeller, Annual UN Ambassadors' Dinner Sep 14, 1994

Why is the chairman emeritus of Chase Manhattan Bank, a private banker, David Rockefeller so concerned about the earth's population? Who elected or appointed him to

be so concerned? His enormous wealth? Indeed. And this concern of the private wealthy international bankers was most frankly articulated by Robert Strange McNamara, the former Secretary of Defence under presidents Kennedy and Johnson (1961 to 1968) who presided over the decimation of Vietnam, Laos and Cambodia, in 1970 as the new head of the World Bank upon leaving government service:

“... [Population growth is] the gravest issue that the world faces over the years ahead. ... It is not a world that any of us would want to live in. Is such a world inevitable? It is not sure but there are two possible ways by which a world of 10 billion people can be averted. **Either the current birth rates must come down more quickly or the current death rates must go up. There is no other way.**” — Robert McNamara, Speech to International bankers as Head of the World Bank, October 2, 1970, cited in [Population control, US bio-weapons research, McNamara, Rockefeller, and AIDS](#)

Why are these private unelected international bankers and war-mongers trying to reduce the world's population? Is there a political theory and social architecture behind all this? Well, if the Georgia Guidestones are to be believed, the answer is evidently yes. Etched in 18 feet tall granite stone monument in Elbert County, Georgia, USA, are the new Ten Commandments for a new world, written in English, Spanish, Swahili, Hindi, Hebrew, Arabic, Chinese, and Russian:

1. Maintain humanity under 500,000,000 in perpetual balance with nature.
2. Guide reproduction wisely — improving fitness and diversity.
3. Unite humanity with a living new language.
4. Rule passion — faith — tradition — and all things with tempered reason.
5. Protect people and nations with fair laws and just courts.
6. Let all nations rule internally resolving external disputes in a world court.
7. Avoid petty laws and useless officials.
8. Balance personal rights with social duties.
9. Prize truth — beauty — love — seeking harmony with the infinite.
10. Be not a cancer on the earth — Leave room for nature — Leave room for nature.

Let's ask some probing questions here. How is Commandment number 1 on the Georgia Guidestones linked with:

1. the vaccination regimen of modern medicine given that the same international bankers who architected modern medicine, and who architected the modern private central banks which loan money on interest to Western governments as their national debt, are also the loudest in their expression of concern for overpopulation, for the degradation of the environment, and are the real powers behind the United Nations Agenda 21 which was signed in Rio in 1992 by almost all member states of the United Nations? (see [United Nations Agenda 21, condensed version](#), [10 minutes dummies' version](#), [The Move to Depopulate the Planet By Stephanie R. Pasco](#), [Codex Alimentarius & Nutricide by Dr. Rima Laibow](#), etc.) ;
2. the military grade bioweapons research and development of the most contagious viral pathogens along with their dispersal systems that can wipe out the entire human race? (see ['Anthrax isn't scary at all compared to this': Man-made flu virus with potential to wipe out many millions if it ever escaped is created in research lab](#), November 28, 2011)

Is the Rockefeller controlled modern medicine, alongside the obviously deadly biowarfare contagions coming from both the military's and big-pharma's bioweapons research labs, out to implement what Robert Strange McNamara had so monumentally stated, and which only reminds one of Hellenic gods of antiquity playing their mortifying games on earth: ***“Either the current birth rates must come down more quickly or the current death rates must go up. There is no other way.”?***

Between the manmade diseases and its concocted poisonous antidotes, the Commandment number 1 on the Georgia Guidestones could be realized in some sophisticated bioweapon warfare protocol unsuspectingly unleashed on human populations without much compunction if some entities really meant to reduce the world's population to those levels, couldn't it?

Eustace Mullins' 1988 underground classic [Murder By Injection](#) spoke to the same conspiracy by the Rockefeller cabal controlled medical profession – to vaccinate people to death against viruses and to blame it on natural causes. Man made viruses and pandemics can sure come in handy for that purpose. The [Swine Flu Pandemic of 2009](#) and the pretext to [microchip](#) the population came to underscore the same [conclusions](#). It is not just the vaccines alone, but their coupling with deadly biowarfare contagions, separately, or within it



as its main dispersal agent, which may come to rival the proverbial *deathstar* weapon. The fact that big-pharma leader Baxter released real live Bird Flu Virus in their flu vaccine is of course only an accident, as Baxter International, claimed (see [Bloomberg: Baxter Sent Bird Flu Virus to European Labs by Error](#), February 24, 2009, and [Vaccines as Biological Weapons? Live Avian Flu Virus Placed in Baxter Vaccine Materials Sent to 18 Countries](#), March 03, 2009). Obvious questions like the following were raised even by mainstream narrators looking at the fishbowl with childlike simplicity. LifeGen.de, the German special interest online-magazine which claims to have 90,000 subscribers, in its editorial of February 26, 2009, pondered:

“There is no excuse. According to the scientific network PROMED, Baxter International Inc. in Austria "unintentionally contaminated samples with the bird flu virus that were used in laboratories in 3 neighbouring countries, raising concern about the potential spread of the deadly disease". Austria, Germany, Slovenia [Slovenia] and the Czech Republic – these are the countries in which labs were hit with dangerous viruses. **Not by bioterrorist commandos, but by Baxter. In other words: One of the major global pharmaceutical players seems to have lost control over a virus which is considered by many virologists to be one of the components leading some day to a new pandemic.** Was it H5N1, or the even more risky H3N2? And what about the BSL3-Standards Baxter is operating when handling the viruses? What happened? And who failed?” — LifeGen.de, [Baxter's H5N1 as global flu pandemic threat](#)

We see this theme repeating itself by their own admission! Had the “accident” succeeded in wiping out a large population of mankind, at worst, it would have been deemed a tragic “accident”! At best, only a natural pandemic. In either presentation of this public relations, the agenda of population reduction being achieved with no one to blame! The big-Pharma has already been given legal immunity against any wrong-doings for their vaccines in the guise of rushing pandemic-fighting solutions rapidly to market. Even this “accident” had no punitive and legal repercussions for Baxter International as such! They are exempt even if their vaccines kill people! It is only an ex post facto “oops”! And that is precisely both the legal and the public relations plan – right before your very eyes!

What this Baxter “accident” fortuitously betrayed to the world was the method's existence to infect the world population with deadly viruses through vaccines! And had it not been serendipitously caught by a diligent practitioner outside Baxter before administering it to humans, leading up to the forced vaccinations of civilian populations worldwide (see [Wake Up, America: Forced vaccinations](#)), shows that all the concerns which have been discussed

above are not only practicable, but perhaps already in “clinical trials”! The legalized backing from global laws on vaccinations through the WHO is already in place to force public vaccination under the pretext of fighting the pandemic. Even the definition of what is a “pandemic” has extraordinarily been revised to facilitate its easy declaration: “*WHO has revised its definition of pandemic flu in response to current experience with A/H1N1.*” reported BMJ in September 2009.

Despite all these disclosures, presenting its baby face of wonderment to the world, the Council on Foreign Relations in New York held a Pandemic Influenza Conference on October 16, 2009, where it complained about the anemic uptake in public vaccinations. One scholar from the audience lamented the public's resistance to being vaccinated against the swine flu during this stage-6 pandemic declaration in these words: “***[anti-vaccine movement] Crazy people who think the vaccine will kill you***”. The panelist thought up a clever public relations plan to increase the vaccine uptake (only half-jokingly I am sure):

“Having said that, does it work to mandate [vaccination]? **I think what would work better would be to say that there was a shortage and people tend to buy more of something that's in demand.** (Laughter.) We saw that -- there was one season where, really, people lined up all night to get a flu shot.” (see The Swine Flu Chronicles 2009: Why to say 'No' to the Swine Flu Vaccine)

Fortuitously for mankind, the 2009 Swine Flu Pandemic “clinical trial” actually was defeated by circumstances which could not be controlled by the vaccination committees peddling the pandemic despite all their advanced preparations. Even the DER SPIEGEL staff could only conclude in their best innocence after their exhaustive study which appeared in their March 12, 2010 issue:

***“No one at the WHO, RKI or PEI should feel proud of themselves. These organizations have gambled away precious confidence. When the next pandemic arrives, who will believe their assessments?”*** (see The Swine Flu Postscript: 'Reconstruction of a Mass Hysteria – The Swine Flu Panic of 2009' ).

Is all this alternate perspective just hyper-imagination? On the surface it seems far fetched doesn't it? What monstrous entity would be so heinous as to want to play god, and even not fear not getting away with it? Who has that kind of global power? Again – without a gestalt shift in perspective, the feline's instincts for predation cannot be understood by the

baby staring at the beauty of creation!

### **But what really is the real truth regarding modern medicine?**

Is it pro-life (“Primum non nocere”: “First, do no harm”), or is it pro-population reduction?

If it is the latter, then how comes whenever I go to the doctor when I am ill I usually come back healthy – I should be dead by now if they were really trying to kill me! But if they are really trying to heal me, why do they preclude the development of other non big-Pharma related modalities of health care, such as alternate medicine?

Is private big-Pharma's monopoly control over the national and international healthcare parameters worldwide just good old fashioned monopoly capitalism just like the one the private Federal Reserve Bank of the United States enjoys in issuing this nation's money?

Well, if such private monopoly control is okay for the financial oligarchy controlling a nation's money supply, why is it not okay for the same oligarchy controlling the nation's health supply? David Rockefeller indeed stated his altruistic preference at the UN Ambassador's dinner speech: ***“It was pointed out at the conference that growth is most efficiently managed by the private sector, but regulation of the process by national governments and international bodies is also needed. And once again, United Nations can certainly be among the catalysts and coordinators of this process.”*** Is there anything insidiously diabolical or nefarious about privatized and unelected nexus of public control exercised through the United Nations which today extends its impact over the entire globe's population?

How can one distinguish between modern medicine's apparent faux pas amidst its seemingly well-intentioned attempts to heal in the short term (see *iatrogenic* death rate in *Death By Medicine* and big-Pharma's *Chemotherapy 'could cause brain damage' in breast cancer patients*), vs. its prima facie and well-documented long term conspiracies to exterminate for eugenics and population reduction while making a profit for the big-pharma which controls all aspects of it?

At the risk of being repetitious, the reader needs to reflect on the following slide once again in order to understand why it can be psychologically difficult for those in the medical profession and the public to address this question.

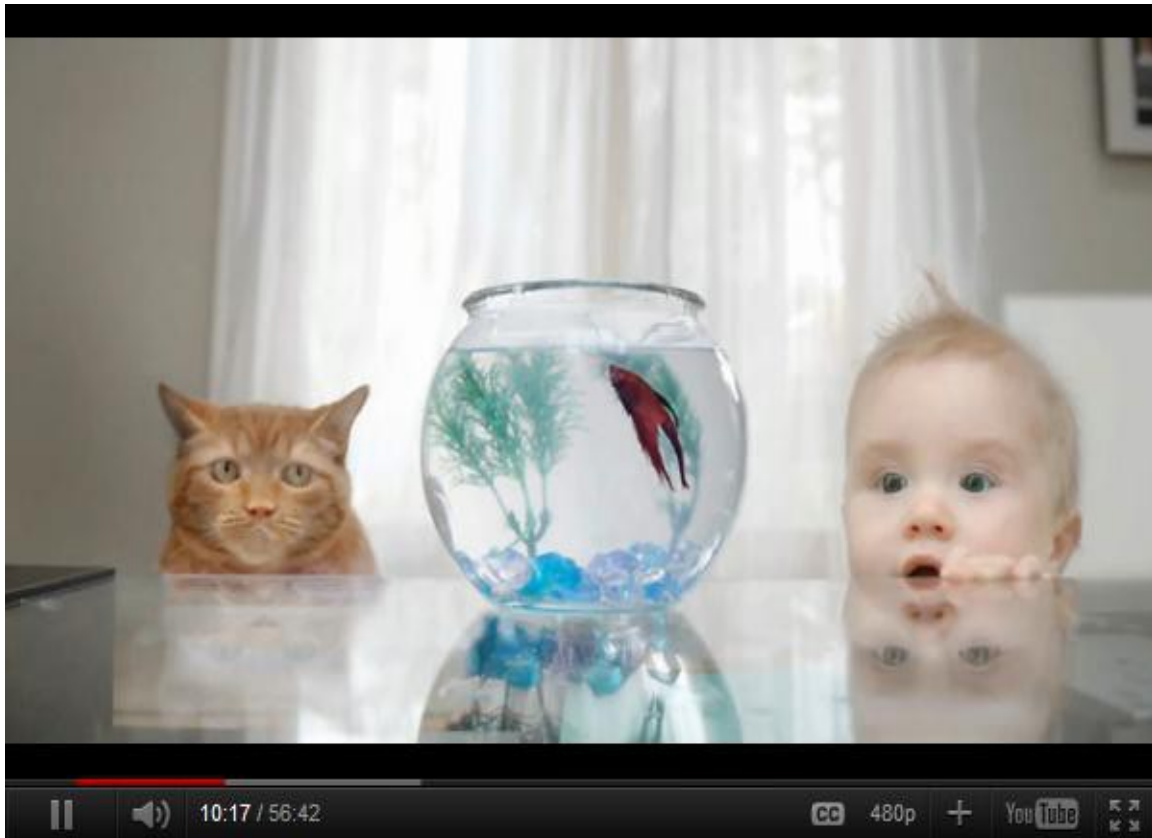

Caption: A change in perspective is required to understand this question  
(slide from Desiree Rover's presentation)

Or, is the unspeakable fact of the matter really this: that modern medicine, as part of modern science and technology, is yet another tortuous link in the conspiracy by the oligarchy to scientifically control life itself in the dystopia of one world government which has been in open-planning for a very long time; that modern medicine is a healing craft only in the short-term under the monopoly control of the financial oligarchy which funds and oversees it via the big-Pharma and its various administering, legislating, regulating, licensing, and fund granting organizations like the NSF, AMA, FDA, FAO, Lobbies, WHO, and the United Nations, enroute to its development as a corrosive scientific supra-national controller of life itself in the longer term.

Can one imagine such a dystopian universal controller in a scientific dictatorship which would want to ***“standardize the population, to iron-out inconvenient human differences, to create so to say mass produced models of human beings arranged in some kind of a scientific caste system ... to get people actually to love their servitude”***?

Here is one depicted in Aldous Huxley's 1931 fable A Brave New World. And that quoted

description is also Aldous Huxley's own from his [1962 speech at UC Berkeley](#), titled *The Ultimate Revolution*. Listen to that 40 minute most revealing speech before going for *A Brave New World* – it is almost as if Huxley is reading off of some blueprint of the future:

### **The Ultimate Revolution Aldous Huxley**

<http://sunsite.berkeley.edu/VideoTest/hux1.ram>

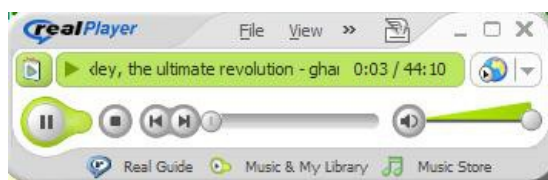

### **The Movie A Brave New World**

[[googlevideo=http://video.google.com/videoplay?docid=-3536993421073315692&hl=en](http://video.google.com/videoplay?docid=-3536993421073315692&hl=en)]

Well, one of the major themes of the fable *A Brave New World*, is birth control, separation of sexuality from reproduction, and sexualizing children beginning at a very young age (see [Parents upset over crotchless panties sold in kid's store](#), [cached](#), watch [video](#)). Signs are all around us wherever Westerndom's cultural influences pervade, for setting the stage for a new world in which sex plays no part in reproduction but is encouraged for recreation and bodily needs without the traditional bounds of marriage. It is of course the only method by which to achieve the controlled flat birth-rate consistent with Commandment number 1 of the Georgia Guidestones noted above while permitting unlimited recreational sex.

The psychological (for each individual), and sociological (for the society), conditioning necessary for such asexual reproduction must begin in childhood, just as is depicted in Aldous Huxley's fable. Elements of the fable are now visibly beginning to match with empirical reality where even pre-adolescent elementary school kids are exposed to it in pop culture – that being the prime Trojan Horse for infiltrating and subverting conservative mores and customs. Subversion of tradition is necessary before such a dystopia where family bonds are replaced by collectivist and functional bonds, can be achieved.

Control of sexuality however is still just one link in the greater interconnected chain which includes research in big-Pharma, modern medicine, technology, and all aspects of socialization, for the full spectrum control of mind-body-spirit of human beings in a scientific dictatorship. Yes, even spirit, for which a new religion has been conceived, Secular Humanism! (see [Brian Gerrish 'State of the Nation'](#)) All of this has been most effectively enabled by the "Technetronic Era". That neologism was coined by Dr. Zbigniew Brzezinski

in his 1970 book *Between Two Ages – America's role in the Technetronic Era*. Brzezinski, like Aldous Huxley before him, coldly observed:

**“Life seems to lack cohesion as environment rapidly alters and human beings become increasingly manipulable and malleable. Everything seems more transitory and temporary: external reality more fluid than solid, the human being more synthetic than authentic. Even our senses perceive an entirely novel "reality"—one of our own making but nevertheless, in terms of our sensations, quite "real." More important, there is already widespread concern about the possibility of biological and chemical tampering with what has until now been considered the immutable essence of man. Human conduct, some argue, can be predetermined and subjected to deliberate control. Man is increasingly acquiring the capacity to determine the sex of his children, to affect through drugs the extent of their intelligence, and to modify and control their personalities. Speaking of a future at most only decades away, an experimenter in intelligence control asserted, "I foresee the time when we shall have the means and therefore, inevitably, the temptation to manipulate the behaviour and intellectual functioning of all the people through environmental and biochemical manipulation of the brain.”**” (pg. 12)

Only when such an overarching societal control agenda is understood, does the perception management and social engineering politics of two steps forward and one step backwards in such headlines as the following begin to make any sense: [Supreme Court Blocks Government Plan To Claim Ownership Of DNA](#). Why does the government want to own your child's DNA? And they will, eventually, under one pretext or another.

Research in medicine has today inextricably become linked with bioweapons research, genetics, and DNA/cellular level manipulation of life and its food sources.

In combination with big Agri-business and genetically modified pesticide laden food stock being forced upon the world (see Codex Alimentarius and the Monsanto world), and the vaccination regimen also being forced upon the world, induced sterility over a generation or two will see drastic reduction in world population beginning with the third world peoples. There is simply no other reason for Microsoft founder Bill Gates to be so concerned with polio, mosquitos and malaria throughout Asia and vaccinating the poor children for free when the indigent peoples don't even have clean drinking water or roof over their head, never mind one square meal a day ("[decade of vaccines](#)"):

“Bill Gates, the Microsoft founder and philanthropist, will donate \$10 billion (£6 billion) over the next decade to develop and deliver new vaccines to children in the developing world in one of the biggest ever single charitable donations. Speaking at the World Economic Forum in Davos, Mr Gates called for a "decade of vaccines" to reduce child mortality dramatically by 2020. **By the end of the decade, 90 per cent of children in the world's poorest nations would be immunised against dangerous diseases such as diarrhoea and pneumonia, he said, saving some eight million lives.**”

See [Funding the Eugenics Movement](#).

The weaponization of viruses, for human and food supply is the most secretive and most prolific military technology of the West today. As previously stated above, can its covert unleashing in conjunction with big Pharma's vaccines, and modern draconian methods of controlling the public to take them, be part of population engineering (watch [CBS-60-Minutes 1976 Swine Flu Scare](#), [Dr. Teresa Forcades: BELL-TOLLING for Swine Flu, transcript](#))?

Well, as already examined in the report [Swine Flu Pandemic of 2009](#), any deadly interactions among these as sophisticated weapons systems which are only lethal when their effects are combined together and designed to selectively cull populations in different modalities – from infertility to sterility in offspring to epidemic death – can always be blamed upon God, nature, or just bad luck and gullibly accepted by the surviving public with proper propaganda support! And therefore, the question has more than mere rhetorical significance.

Let's examine that question of motivation in the words of those mighty gods with real state powers and the ability to inflict it upon vast populations, and not be content with the mere words etched in stone monuments in state parks or in some rich bankers' fertile imagination merely longing to play god.

The [NSSM 200](#) Memorandum of the United States National Security Council already envisioned such draconian measures in 1974 in a concluding section titled '**An Alternative View**':

“Should the U.S. make an all out commitment to major limitation of world population with all the financial and international as well as domestic political costs that would entail. ... **Would food be considered an instrument of national power? Will we be forced to make choices as to whom we can reasonably assist, and if so, should population efforts be a criterion for**

**such assistance?** Is the U.S. prepared to accept food rationing to help people who can't/won't control their population growth?"

See the cited link for in-context deconstruction of that Memorandum written by the then Secretary of State Dr. Henry Kissinger which posited rising third world population a threat to America's National Security! President Gerald Ford subsequently signed-off on NSSM 200 in the White House's National Security Decision Memorandum NSDM 314, agreeing to the population control agenda for world's most populous Least Developed Countries outlined by Henry Kissinger.

What scientific and political modalities were secretly thought through for NSSM 200 and NSDM 314, and in their follow-ons that are still classified such that even their existence is not known, which are in baby-steps and in stages covertly being deployed against the Least Developed Countries unbeknownst to their public? The Monsanto GMO seeds – in conjunction with the WTO treaties which leverage off of the third world debt under the WB-IMF tag team – now being forced upon the Least Developed Countries either as foreign aid or as acceptance condition for continued foreign aid, and the real danger of these genetically modified seeds yielding catastrophic crop failures resulting in widespread famine which will put these poorest nations at the direct existential mercy of the West, has misanthropic implications already visible even in the declassified NSSM 200. Coupled with biowarfare agents administered by vaccinations and/or other dispersion methods, population reduction modalities and global eugenics are no longer science fiction. It has now become merely policy implementation of who, when and where, not how!

Furthermore, Bertrand Russell's 1952 book *The Impact of Science and Society*, in Chapter 7 argued the misanthropic rationale for applying draconian methods of population control in the poorest nations of the world for the benefit of the affluent Western nations – if only the world's public had the opportunity to read what is so eruditely planned in high places for them:

“What is the inevitable result if the increase of population is not checked? There must be a very general lowering of the standard of life in what are now prosperous countries. ... What, then, can we do?”

Apart from certain deep-seated prejudices, the answer would be obvious. The nations which are present increase rapidly should be encouraged to adopt the methods by which, in the West, the increase of population has been checked. Educational propaganda, with government help, could achieve this result in a generation. There are, however, two powerful forces



opposed to such a policy: one is religion, the other is nationalism. I think it is the duty of all who are capable of facing facts to realize, and to proclaim, that opposition to the spread of birth control, if successful, must inflict upon mankind the most appalling depth of misery and degradation, and that within another fifty years or so.

I do not pretend that birth control is the only way in which population can be kept from increasing. There are others, which, one must suppose, opponents of birth control would prefer. War, as I remarked a moment ago, has hitherto been disappointing in this respect, but perhaps bacteriological war may prove more effective. If a Black Death could be spread throughout the world once in every generation survivors could procreate freely without making the world too full. There would be nothing in this to offend the consciences of the devout or to restrain the ambitions of nationalists. The state of affairs might be somewhat unpleasant, but what of that? Really high-minded people are indifferent to happiness, especially other people's. However, I am wandering from the question of stability, to which I must return.

There are three ways of securing a society that shall be stable as regards population. The first is that of birth control, the second that of infanticide or really destructive wars, and the third that of general misery except for a powerful minority. All these methods have been practised: the first for example, by the Australian aborigines; the second by the Aztecs, the Spartans and the rulers of Plato's Republic; the third in the world as some Western internationalists hope to make it and in Soviet Russia. (it is not to be supposed that Indians and Chinese like starving, but they have to endure it because armaments of the West are too strong for them.)

Of these three, only birth control avoids extreme cruelty and unhappiness for the majority of human beings. Meanwhile, so long as there is not a single world government there will be competition for power among different nations. And as increase of population brings the threat of famine, national power will become more and more obviously the only way of avoiding starvation. There will there be blocs in which the hungry nations band together against those that are well fed. That is the explanation of the victory of communism in China.

These considerations prove that a scientific world society cannot be stable

unless there is world government.” — Bertrand Russell, *The Impact of Science and Society*, pgs. 115-116

These self-serving specious justifications of the Western ubermensch, prima facie blueprint the national security policy documents like NSSM 200 which are exercised through the governmental-corporate-academe-NGO nexus of the vast military-industrial complexes of the West. Similar policy documents must surely exist in the European Union and its affluent nations as well, which also outlive their successive political administrations just as they do in the United States of America. The strange continuity of the entire Global North's predatory practices inflicted upon the natural resources rich and yet still debt laden and poverty stricken Global South, despite the frequent changes in democratically elected governments in the white houses of Western democracies, is inexplicable otherwise.

Furthermore, Baxter's vaccine “accident”, and Monsanto crop failures in previously fertile regions in many parts of the third world, prima facie and incontrovertibly demonstrate the genocidal methods already available today for inducing *humanicide*, the population reduction agenda. While other techniques of inducing long term mortality, via infertility and sterility over a generation or two, are only forensically arguable at this time by witnessing the bizarre mega spendings on children vaccinations in the most populous and least developed countries in Asia and Africa as if the West really cared for their welfare. Voiding the third world debt alone would be sufficient to ameliorate their condition if the affluent International bankers holding that debt-enslavement chain really cared for the 'untermensch' children's sufferings (see John Perkins' [A Game as old as Empire](#), [intro-cached](#)).

### **The World According to Monsanto**

[googlevideo=<http://video.google.com/videoplay?docid=6262083407501596844>]

### **Food: The Ultimate Secret Exposed**

[youtube=<http://www.youtube.com/watch?v=MSpkLk0vYmk>]

[youtube=<http://www.youtube.com/watch?v=-B9MeO3SRxU>]

## **II**

Returning to our main focus on Western medicine and the role of big-Pharma, it is commonsense to observe that if there was no immediate and near term benefit of modern medicine, there'd be no one subscribing to it. That ubiquitous subscription ought not to

blind one to its visible eventual direction however. And that's the agenda of modern medicine – to continue to blind one to that long-term agenda by its short term benefits. It is the same modus operandi as the one fueling the “Technetronic Era” for its immediate benefits, but which is also hurtling the world into the global surveillance society of big Brother and full scientific dictatorship at breakneck speeds. That same agenda in medicine could not perhaps be achieved without monopoly control of all health care modalities and research, and of course without attracting and luring young scientists to work in life sciences and medicine.

The near term benefits we see today in healthcare, the advanced surgical techniques, the trauma centers and the ER, and what we typically think of as wonders of modern medicine, does span an entire life-span, or two. It helps millions of people everyday. These benefits to our good-life in the near term are undeniable, as even David Rockefeller articulated at the UN Dinner. Just like the wonders of modern science and technologies also benefit the modern kitchen to modern travel in our “Technetronic Era”. These benefits of a scientific modernity are part and parcel of the same incentivization modalities to get people to tirelessly work on their narrow passionate interests in the short term, often in the name of scientific advancement benefiting humanity, or national security, quite oblivious to their detrimental long-term outcomes. These self-serving motivations and their cumulative impact on society in creating a global scientific dictatorship have already been fleshed out in [The Fable of the Bees and the Seduction of Science and Technology](#).

But modern medicine does love symptomatic treatments even when it is not trying to kill us in the short term. I cannot recall big-Pharma announcing a cure for any major modern disease – can you? – from cancer to heart disease to diabetes to AIDS. The best patients are the ones on illness management drugs for a lifetime. There is much profit in administering a continuous supply of pharmacological cocktails rather than any holistic cure. And a new disease is as simple to define as simply calling it a disorder!

As reported by George F. Will in The Washington Post, Handbook suggests that deviations from 'normality' are disorders, [February 28, 2010](#): **“Today's DSM defines “oppositional defiant disorder” as a pattern of “negativistic, defiant, disobedient and hostile behavior toward authority figures.” Symptoms include “often loses temper,” “often deliberately annoys people” or “is often touchy.” DSM omits this symptom: “is a teenager.”**

The draconian implication of this new “disorder” definition in DSM was not lost upon the cynical journalist: **“If every character blemish or emotional turbulence is a “disorder” akin to a physical disability, legal accommodations are mandatory. Under federal**

law, "disabilities" include any "mental impairment that substantially limits one or more major life activities"; "mental impairments" include "emotional or mental illness." So there might be a legal entitlement to be a jerk."

George Will continued: "The revised DSM reportedly may include "binge eating disorder" and "hypersexual disorder" ("a great deal of time" devoted to "sexual fantasies and urges" and "planning for and engaging in sexual behavior"). Concerning children, there might be "temper dysregulation disorder with dysphoria." **This last categorization illustrates the serious stakes in the categorization of behaviors. Extremely irritable or aggressive children are frequently diagnosed as bipolar and treated with powerful antipsychotic drugs.**"

And that has now become a trend for recruiting new patients – to continually move it downwards in age. Children are now the focussed target of big-Pharma, with *Attention Deficit Disorder* diagnosis rampant, and other pharmacological infestations into the child's body occurring from birth as part of modern healthcare. It isn't voluntary, as systems of exclusions of rights and opportunities are legally attached to not being responsive to modern medicine and its diktats. That is what is meant by "legal entitlement"!

The following shocking revelation by Dr. Rima Laibow while responding to a question at the Anti-Zensur Konferenz (AZK - Anti-censorship conference) in Germany is notable in this respect:

"In the United States there was a law enacted, which was signed into law by the twice unelected president of the United States, George Bush. That law is called the New Freedom Initiative. The New Freedom Initiative signed into law in November 2004, says the following: Says every child in the United States, including unborn children, must be screened for mental illness. [Former executive sales rep for Eli Lilly & Co., Dr. John Rengen Virapen, interjecting: This was a study done by George Bush's Institute for Mental Health in Texas, which was built by Eli Lilly & Co.] But there is more. **Step One: screen every child including the unborn by screening their mothers for mental illness. Step Two: treat on a mandatory basis, every child who is found to have, quote, mental illness, which means, every child. And Step Three: screen and treat on a mandatory basis, every single person who has any contact with children because we have to protect the little dears. That means mothers, fathers, shop keepers, school teachers, grandparents, neighbors, everyone. So first we control, first we control, and we make ill because every drug requires**

**more drugs, which require more drugs, and more drugs, and then eventually, we depopulate.”** (minute 7:30)

The fact that the above statement **“we make ill because every drug requires more drugs, which require more drugs, and more drugs,”** is empirically true in many cases not just for drugs but also for therapies such as radiation, can straightforwardly be gleaned in this continually updated [iatrogenic survey](#) of Western medicine culled from news reports. And therefore, the first-cause question raised earlier about modern medicine has to be addressed at every stage by the shrewd reader concerned with health matters. For emphasis, it is restated: Is this malevolence of modern medicine deliberate, or, merely *iatrogenic*? That medical terminology means having inadvertent or unintended side-effects. Furthermore, if it is the latter, then is it due to big-Pharma's *raison d'être* of big profits, and their collusion with the FDA to rush drugs and therapies to market which are poorly tested over the long term for complex side-effects? Or do all these hierarchical goals just work seamlessly in tandem? None who are so innocent of knowledge and naively staring at the fishbowl can ever comprehend all its felinic dimensions.

While I have to admit that I have not yet been able to locate and study the original source document for that unlayering of Newspeak by Dr. Rima Laibow behind Executive Order 13217, titled: **“New Freedom Initiative and its goal of community integration for people with disabilities”**, the business of statecraft couched in neurolinguistic phenomenology to imply one thing for public perception and mean quite another is not unfamiliar to those who study it. The Orwellian use of the already very familiar words like “Freedom” to mask diabolical intent, as in “Operation Iraqi Freedom”, would only come as a surprise to those most acutely suffering from the *dumbed-down disability* (DDD). Similarly, the wholesome word “community” and the concept of “community integration”, minus the Newspeak is explained very perceptively by California State employee and activist Rosa Koire in her talk on [How your community is implementing AGENDA 21](#) (minute 8:30).

If one has the stamina to sit through Rosa Koire's 90 minute entertaining talk, one will come to understand that the Agenda 21 is all pervasive, multifaceted, and its collectivist *prime directive*, the depopulation of the planet and its global management through central governance, is being implemented locally in stages! However, by looking at each local enactment and baby-step individually, it is impossible to see the big picture in much the same way as painstakingly examining each atom and its sub-structure in the water molecule still makes it impossible to understand why the water naturally only flows downstream.

Nobel laureate physicist Max Planck expressed this holistic fact of system analysis most

aply:

“Modern physics has taught us that the nature of any system cannot be discovered by dividing it into its component parts and studying each part by itself, since such a method often implies the loss of important properties of the system. We must keep our attention fixed on the whole and on the interconnection between the parts.” (Cited in Critique of Western Philosophy and Social Theory By David Sprintzen, pg. 76)

Consequently, in order to acutely comprehend the larger interconnection between parts, one has to not only understand many parts, but also the historical trends and dynamics in the interconnection between those parts – as these are neither static, nor temporal, but evidently bring a long hysteresis effect to their current state and future direction. A former nursing student Jennifer Lake has compiled an interesting medicine Timeline to this effect, spanning the period between 1830 to present, where the long-term trends of modern medicine and the medical establishment's conduct leading us here, is self-evident (see [Jennifer Lake's Blog](#)).

But it is of course next to impossible to understand any of this in the limited time dedicated professionals have available to them after toiling all day long in their 'American Dreams'.

Which brings us back to the busy doctors and their knowledge of their own profession, never mind of complicated agendas and trends which both transcend their profession as well as is part of their profession. The modern doctors don't appear to know too much about the medicines and vaccines they prescribe to their own patients, behaving more and more like technicians for big-Pharma. This empirical observation is most unfortunate because many practitioners I am sure, and two of my own children are laboring in that endeavor of the healing sciences, come to this profession with a great deal of idealism. But what happens by the time they have graduated medical school and labored 80-100 hours per week in their residencies at barely livable wage and a quarter of million dollars in debt? They become slaves to the dogmas of big-Pharma.

Indeed, the modern physician, from pediatrician to internal medicine to oncologist to psychiatrist, all appear most beholden to whatever is the prevailing cultural dogma of big-Pharma, to the FDA, to the AMA, to the WHO, and to the sales rep of big-Pharma from whom they evidently get all their knowledge of the drugs they automatically prescribe like robots based on a symptom diagnostic table also provided to them by big-Pharma. The choice of radiology and surgery for this reason appeals to some because these entail the least interaction with big-Pharma. A few also just walk away. This is what Jennifer Lake

wrote on her blog: ***“Welcome to my blog. I was a nursing student in 2005-2006 and decided not to enter the field and give people drugs. My school experience opened my eyes to the depth of medical fraud within the military-industrial-medical-complex and the willful cover-up of the real causes of disease.”***

Western Medicine, in the name of protecting the patients from quackery, is the most draconianly regulated profession in the world with big Brother management across the board. This big Brother works for big-Pharma. And big-Pharma controls the medical profession as well as its professionals. All non big-Pharma healing methods are minimally considered unorthodox when not outright condemned, even when empiricism speaks otherwise and even when respectable medical coverage is given to it.

A notable example of this “unorthodox” treatment which received considerable medical press, but with otherwise little interest shown by the medical establishment other than as a quirky curiosity, is Norman Cousins. The New England Journal of Medicine published a revealing case study of self-healing by Norman Cousins (Cousins, N. Anatomy of an Illness (as Perceived by the Patient) NEJM 295:1458-1463 December 23, 1976). Cousins expanded that NEJM article into a 1979 book, Anatomy of an Illness (As Perceived by the Patient), detailing his observations of the medical profession and his “unorthodox” experiments in self-healing. He was stricken by a painfully debilitating illness in 1964 upon returning from a trip to the Soviet Union, which was diagnosed as *ankylosing spondylitis*. Eventually, after all the medical remedies in the hospital had proved futile, and as he put it in his book: ***“I had a fast-growing conviction that a hospital is no place for a person who is seriously ill.”*** (pg. 31), Cousins left the hospital, checked into a hotel, and under his own enlightened doctor's supervision, a Dr. William Hitzig, created for himself a daily schedule of hearty laughter therapy as an exercise in mind-body self-healing.

Norman Cousins' book contains many commonsensical insights into the rational and wholly scientific thought processes behind its author's specific experiments in self-healing carried out under the close supervision of his licensed physician. Such general analytical thought processes which affectively tickle the natural human biochemistry is not known to be FDA approved (sic!). There is no profit in natural or nature-derived remedies for big-Pharma which projects anything non-pharmacological as a zealous move towards abandoning the very canons of science. Therefore, modalities afforded freely by nature, by low cost natural remedies, and by natural human biochemistry do not constitute any significant part of the medical school training regimen which is entirely high-margin pharmaceutical driven as the Alpha and Omega of modern medical intervention.

Detractors and public relations experts shilling for the established medical profession make

their own “independent” pronouncements in the “public interest” but almost always in favor of their priesthood whenever an “unorthodox” case gains unusual prominence. As [this chap](#) from the National Council Against Health Fraud (“NCAHF is a private nonprofit, voluntary health agency that focuses upon health misinformation, fraud, and quackery as public health problems.”) did against the empiricism brought forth by Norman Cousins, and the consequent interest it generated among the public. Since the medical establishment rarely funds any scientific studies into these non big-Pharma healing modalities, it is easy to dismiss its effectiveness as quirky, non-scientific, or faith-based. This self-serving loop is retained in modern medicine by design by big-Pharma and its big Brother enforcers.

[Here](#) is a former sales executive and Managing Director for Eli Lilly and Company, Sweden AB, Dr. John Rengen Virapen, speaking at the same Anti-Zensur Konferenz in Germany as Dr. Rima Laibow mentioned above, where he explained the big-Pharma's system of co-optation. In the conference presentation, Virapen admits to bribing the regulatory board in Sweden to approve Prozac! Dr. Virapen also wrote his confessional memoir, *Side Effects: Death - Confessions of a Pharma-Insider*, blowing the whistle on Eli Lilly's and big-Pharma's shady practices. In this [blogtalkradio](#) 2007 interview, Dr. Virapen explained more details on how he did the bribing for Eli Lilly and Company to get Prozac approved. (Virapen video: <http://www.youtube.com/watch?v=Qmi3ihrUHJU> )

Dr. Virapen's confessional insights into the overall systems of corruption, including his own personal corruption for the lure of the good life and high society, clearly demonstrates how corrosively big-Pharma infects both regulatory bodies via political lobbies and kickbacks, as well as the medical practitioners via their indoctrinating training, that few are able to retain whatever iota of Hippocratic idealism that had brought them to their profession.

Especially, when doctors are employed by HMOs and hospitals which have standardized diagnostic and prescription regimens, it leaves little room for discretion for any talented physicians who might wish to explore refrains or alternatives not sanctioned by the hospital or the insurance companies.

When the FDA wisdom, and the WHO wisdom, both of which represent the big-Pharma interests, is to prescribe flu shots or some vaccination protocol for instance, and not just their paycheck but their ability to practice their profession depends on following those diktats, then which physician has ever done any first hand research on the drug or the vaccination protocol on their own? Which physician has the time, or the inclination to go against the wisdom du jour? During the 2009 Swine Flu pandemic declaration by the WHO to unprecedented Stage-6 for instance, how many in the medical profession administering the swine flu vaccines bothered to study first hand either the pandemic or the vaccination



protocol dictated by the authorities? Even the Director-General of WHO was following orders of her superiors who told her exactly what to proclaim next.

I wrote to Margaret Chan, the figurehead boss of WHO, on May 09, 2009:

“I write you respectfully to express immense concern, and without mincing words. I would like to draw your kind attention to the letter to editor which is reproduced below. It expresses grave reservations that the **World Health Organization is acting as a global sales-rep for vaccine manufacturers.** I specifically draw your kind attention to the “Note on abetting the Pandemic” which is cited below. **It is quite likely that you have become an unwitting pawn in the ruling oligarchs' game of population reduction.** If you finally come to realize that [fact] through your [own] due diligence, I urge you to make that information public from your high pulpit. At worst, you will lose your job. **But your unconscionable inaction, or mere resignation in silence, will lead to a billion-plus exterminated, with WHO subsequently claiming all the credit for saving the rest.** There is likely a Nobel Peace Prize lurking in there somewhere for all this 'saving'. And the cycle will repeat.”

See details in my [Letter to Dr. Margaret Chan, Director-General, WHO: Global Sales-Rep for Big-Pharma!](#)

It is just assumed by the vast majority of medical practitioners that the FDA and the WHO have done their own due diligence, and that they operate in good faith under the same Hippocratic oath. In this perspective of the baby staring at the complicated creature in the fishbowl with wondrous innocence, there is no comprehension of the psychology and prime directive of the tom cat eyeing the same as a tasty morsel. The system ensures that the very existence of the tom cat is denied. But the evidence of its existence is neither hidden, nor classified top secret. It is just inconvenient to see it.

The incursion of big-Pharma into medical school training regimens to groom that very faithful and trusting physician is now so notorious that few pay any attention to it. The Western medical profession takes big-Pharma's very visible role in their profession as just the “normal” part of modern medicine. It is often rationalized away as “they are spending a billion dollars in research every year”. So this [2009 news story](#) of **“Two hundred Harvard Medical School students are confronting the school's administration, demanding an end to pharmaceutical industry influence in the classroom.”** was refreshing indeed.

The New York Times ran the following report on March 2, 2009:

“In a first-year pharmacology class at Harvard Medical School, Matt Zerden grew wary as the professor promoted the benefits of cholesterol drugs and seemed to belittle a student who asked about side effects. Mr. Zerden later discovered something by searching online that he began sharing with his classmates. **The professor was not only a full-time member of the Harvard Medical faculty, but a paid consultant to 10 drug companies, including five makers of cholesterol treatments.** ... The Harvard students have already secured a requirement that all professors and lecturers disclose their industry ties in class — a blanket policy that has been adopted by no other leading medical school. **(One Harvard professor’s disclosure in class listed 47 company affiliations.)**”

But that overt role of big-Pharma and its disclosure of conflict of interest with such fanfare in the New York Times is already layered upon the entire implicit pharmacological dogma set up by the Rockefellers at the turn of the twentieth century as cited in the presentation by Desiree Rover. So what is being protested by the Harvard medical students is just the tip of the ice-berg. Disclosing this overt conflict of interest by doctors teaching medical students to prescribe drugs which they have financial interest in seeing sold, while I am sure beneficial for some purpose, does little to alter the interlocking and incestuously self-reinforcing medical profession itself which is controlled by big-Pharma. If not this drug, then that drug – what's the difference since that's the only permitted choice?

Want to reform that? Instead of the mere disclosure of conflict of interest, make conflict of interest itself illegal across the medical profession – for that would surely be a tad more useful than merely talking about it. Make it illegal for doctors to be a financial part of big-pharma, and make it illegal for big-pharma to offer any inducements of any sort to the medical practitioners which is even broadly speaking conflict of interest.

But such sensible laws can of course never be passed because big-Pharma thriving on Wall Street on the very existence and continuous supply of “sick people”, is itself the first prima facie conflict of interest!

And even that pecuniary motivation is itself just the tip of the iceberg. The long-term *prime directive* of big-Pharma, like that of big Agri-business, both crafted by the same financial oligarchy, is control of life itself and not just mere profit. **It is an egregious mistake to think that it is all about profit – “money money money” – it is not.** Profits are merely the payback to its technicians and administrators who enable implementing the *prime*

*directive* year after year in baby-steps. I am certain that even the top scientists and executives of big-Pharma remain as unaware of the *prime directive* as the top scientists and executives of the high-tech industry remain oblivious of the presuppositions and axioms under which they are continuously ushering in the Technetronic Era to its natural culmination (see [the Seduction of Science and Technology](#)).

Therefore, the same New York Times article also reporting: **“Harvard Medical School’s peers received much higher grades, ranging from the A for the University of Pennsylvania, to B’s received by Stanford, Columbia and New York University, to the C for Yale.”**, is hardly much of a differentiator for the overall practice of Western medicine. This specious grading system is itself meaningless as it is layered upon the same Rockefeller axioms which run big medicine and train medical professionals year after year in all the Western medical schools under the FDA and AMA mandates authored by big-Pharma, which is itself controlled by the financial oligarchy. That unfettered exercise of power to craft and legalize un-challengeable axioms at the very source from which all practice naturally follows, as was stated by the Rothschild scion for the power to coin a nation's money supply: **“give me control of a nation's money supply and I care not who makes its laws”**, makes the grading system as useful as the economic policies when controlled by the same monopolistic private cabal. That cabal now presides over the world's destiny, towards the full spectrum global management of the planet and its resources – which includes life!

Their control is being enabled daily in baby-steps. The following was reported in my earlier examination of micro-chipping the population during the swine flu pandemic as the pretext (see [Swine Flu: The Ultimate Revolution in the Making](#)). And that malevolent control of human beings was only temporarily thwarted, despite being led by the Council on Foreign Relations, CDC, and WHO, when the so called pandemic turned into vaporware (see [The Swine Flu Postscript: 'Reconstruction of a Mass Hysteria – The Swine Flu Panic of 2009'](#)).

In his New Technologies and innovations show-and-tell in Toronto in April 2008, Dr. Patrick Redmond described the current state of tracking devices, the RFID chips:

“Hitachi a few years ago produced a chip (called the mu chip) that was the size of a pencil point; if you take a pencil and put it on a piece of paper you get a little dot. That’s how small they’re getting. In 2007 Hitachi came out with a chip that was even smaller, they call it RFID powder. They are just like the talcum powder you would put on a baby. Somark Innovations in Jan 10, 2007 announced an invisible RFID ink. This can be applied to cattle, prime cuts of meat, military personnel and it can be read through hair.”

Dr. Patrick Redmond observed of its deployment trend that:

“... by 2011 you should be able to go on Google and find out where someone is at any time from chips on clothing, in cars, cell phones, and inside many people themselves.”

Dr. Patrick Redmond, 31 years with IBM before he retired, further noted the recent staggering growth of the RFID industry:

“From 1955 to 2005, cumulative sales of radio tags totaled 2.4 billion; in 2007 alone, 2.24 billion tags were sold worldwide and analysts project that by 2017 cumulative sales will top 1 trillion—generating more than \$25 billion in annual revenues for the industry.”

The [article-transcript](#) of Dr. Redmond’s talk is most revealing if unfamiliar with the extent of technological deployment of RFIDs. He not only surveyed how RFIDs are being used today for commodity tracking, but also how these might be used in the near future for psychotropic behavior control when perception management via propaganda (see [The Mighty Wurlitzer by Zahir Ebrahim](#) ) fails , ominously concluding:

“If chips can disseminate medicine then they can disseminate other things too; anything put inside a microchip can be activated by a signal. **And finally, with this technology, subliminal mind control becomes possible.**”

The *Technetronic Era* has willingly brought the world full circle from Aldous Huxley’s 1931 mood-altering drug “SOMA” in his fable *A Brave New World*, to his 1962 predictions at his already cited talk at the University of California Berkeley of the advancements in social engineering through direct behavior control whereby people will actually be made to love their own servitude creating the **“ultimate in malevolent revolution”**, to its real enablement within 50 years, in our own lifetime.

Is this mere happenstance, an inevitable side-effect of technology, or societal control wielded by Machiavelli and worked towards by the many architects of hegemony in every generation? According to Zbigniew Brzezinski, the author of *The Grand Chessboard*, the co-founder of the Trilateral Commission with David Rockefeller and its first executive director, and America's National Security Advisor under president Jimmy Carter (1976-80):

“Another threat, less overt but no less basic, confronts liberal democracy. More directly linked to the impact of technology, it involves the gradual

appearance of a more controlled and directed society. Such a society would be dominated by an elite whose claim to political power would rest on allegedly superior scientific know-how. **Unhindered by the restraints of traditional liberal values, this elite would not hesitate to achieve its political ends by using the latest modern techniques for influencing public behavior and keeping society under close surveillance and control.**” (Dr. Zbigniew Brzezinski, *Between Two Ages*, 1970, pg. 97)

Any modern day physician anywhere in the world having taken the Hippocratic and AMA sponsored oaths in their own local language will naturally bark reading all this, protesting with utmost sincerity and with much innocence of knowledge I am sure, that these are just the natural errors or happenstances of the system and that there isn't some overarching diabolical agenda for inducing lucrative sicknesses, long term sterility, and population reduction behind it. But, over the course of another hundred years or less, perhaps within our own children's lifetime – these happenstances will see a world government patterned in some combination drawn from all these fables.... Is such a felinic world desirable? Should the common man drawn by bread and circuses stop to worry about his own children's fate? Should the passionate scientists and technicians working on it care a bit more than the lure of Nobel prizes and induction into National Inventors Hall of Fame?

It is not obvious to me how to practicably interdict this controlled descent into dystopia on any significant scale! That's because its harbingers deem global scientific dictatorship an ascent rather than a descent and are moving ahead with full force. The system is calculatingly made so co-opting and corrosive that apart from inducing apathy in the majority, even when a handful do their due diligence and shift their perspective from that of the innocent trusting baby to that of the predatory feline to understand the primacy instincts of the oligarchy, they have so much invested in their high-tech and medical careers by the time they wake up that it is just easier to succumb to the “banality of evil” and soldier on as before. The best contemporary example is Dr. Eric Fossum, the inventor of the CMOS imaging chip which along with other computing technologies, has ushered in big-Brother in full force. See [The Seduction of Science and Technology](#).

Moralizing Knowledge does not often equate to moral acts. In fact, it rarely does. The oft quoted Biblical wisdom: **“And ye shall know the truth, and the truth shall make you free”** seems to have little empirical relevance in our seducing modernity where the pleasures and healing of the soul have been traded for the pleasures and healing of the body. (See [America's War Veterans: PTSD and its Cure – Letter to Editor](#))

This modernity, which the Council on Foreign Relations accurately presaged in [April 1974](#)

would ***“look like a great ‘booming, buzzing confusion’ to use William James’ famous description of reality”***, and it now does, has the full impetus of global governance behind it the extrication from which appears well-nigh impossible! This was well planned and superbly orchestrated, just as the CFR author had prognosticated:

“In short, the ‘house of world order’ will have to be built from the bottom up, rather than from the top down. **It will look like a great ‘booming, buzzing confusion’ to use William James’ famous description of reality, but an end run around national sovereignty, eroding it piece by piece will accomplish much more than the old-fashioned frontal assault.** Of course, for political as well as administrative reasons, some of these specialized arrangements should be brought into an appropriate relationship with the central institutions of the U.N. system, but the main thing is that the essential functions be performed.” (Richard N. Gardner, *The Hard Road To World Order*, April 1974, pgs. 558-559)

### **Global Governance - EU President Admits One-World Government is Here**

[youtube=<http://www.youtube.com/watch?v=QEqFtVrAgSo>]



“We are living through exceptionally difficult times. Financial crisis and its dramatic impact on employment and budgets, the climate crisis which threatens our very survival --- a period of anxiety, uncertainty, and lack of confidence. Yet these problems can be overcome, by a joint effort, in and between our countries. **2009 is also the first year of Global Governance with the establishment of the G-20 in the middle of financial crisis. The**

**climate conference in Copenhagen is another step towards the Global Management of our Planet.** Our mission, our presidency is one of hope, supported by acts, and by deeds.” — Herman Van Rompuy, EU Council President, press conference Nov 19, 2009

The news report coming out of Eurozone in August 2011 reconfirmed the EU president's proclamation of inching towards full global governance of the planet by baby-stepping through regional collectives into the greater whole under the pretext of dealing with crises:

**“The leaders of France and Germany are proposing a collective ‘government’ for the Eurozone led by the EU President. It is the solution being put forward to deal with the EU debt crisis. ...** After the talks in Paris Mr. Sarkozy said he and the German Chancellor were also proposing that all 17 Eurozone countries commit to balanced finances and write that goal into their constitutional law by the summer 2012.” (Proposals outlined for collective Eurozone government, Aug 16th, 2011)

### III

#### **Conclusion and Remedies**

Under the collective Western governments of the Euro-Anglo-American nexus, the Western medical system, the big Pharma, the big-Agri business, the big biotech business, the big chemical business, the big technology business, their tightly integrated and inter-dependent research and development in bio-agents and biowarfare, and their increasing and gradual control, tampering, and synthesis of all living things, have all been made resilient to, and well-protected from, any adverse changes in their respective march towards their own compartmentalized *prime directive* in the scientific dictatorship of the emerging global governance.

Under this gruesome realitycheck, one that is neither Pollyanish nor defeatist, but an accurate measure of reality and all the forces driving it, what can be done?

Well, one can of course just pretend that the problem does not exist and continue to hold the perspective of the innocent baby staring at the fishbowl. But if one has succeeded in shifting one's perspective to that of the tom cat, then in self-preservation as the proverbial fish in the fishbowl, what are the options?

First, where we need to be – the destination. When the medical profession is itself complicit in administering inimical medicine to the public, they are part of the petty crime syndicate

and merely wearing white coats and gloves instead of guns. And the medical doctors have to come to that realization before anything can be changed! We do need medical professionals today and tomorrow who will challenge and transcend this big-Pharma dominated healthcare modalities. We need holistic healthcare for humanity which is both scientific and skilled as the awesome surgeons are today, and also un-inimical to the mind-body-spirit. Developing that wholesome medicine, and the schools to train this new breed of practitioners under an hostile environment being driven towards scientific dictatorship, with new laws enacted almost daily to limit individual freedom of action and independence outside the parameters adjudicated by AMA, NIH, CDC, FDA, et. al., as “wholesome”, is the daunting challenge. These American bodies have a global reach today through the WHO. The world witnessed this incontrovertible fact yet again during the 2009 Swine Flu Pandemic. All signatories to WHO Conventions are beholden to its diktats by international law.

Next, how to get there – the journey.

**Consumers:** Well, don't look to me for heroic solutions. You, as consumers, are equally responsible for what happens to you. The solution is within each one of us – don't look for it coming from some messiah, superhero, or born-again Rockefeller.

**Scientists and medical professionals:** Well, take a careful read of [The Fable of the Bees and the Seduction of Science and Technology](#). Refrain perceptively before the fact, rather than lament ex post facto hypocritically. Here is another [case](#) of belated lament, November 29, 2011: *Amy Goodman interviews Kamran Loghman, inventor of modern pepper spray and developer of police procedures for its use. Loghman regrets his work today, and says it's "fashionable" to use chemical agents on "people who have an opinion"*.

**Young men and women choosing the medical profession:** Think very carefully how you wish to practice the healing arts predicate “**First, do no harm**”, realizing fully well: 1) how the medical profession actually functions under big-Pharma's *drugopoly* rather than laboring under some idealistic and false delusions of curing cancer; and 2) perceptively seeing the choke-hold on modern medicine by the financial oligarchy hell-bent on controlling life and the life-sciences for a scientific dystopia they have imagined; before investing in your medicine career.

**Nations:** It is a national challenge for every nation to become independent of the WHO in its practice of medicine, and to develop its own traditions and legal bodies in medicine which are not taking their marching orders from the American and the big-pharma controlled global medical establishment. Not an easy thing to accomplish in a world that is



already being ruled by fiat, by the draconian imperatives of Global Governance which is gradually eroding away national sovereignty! Only truly independent nations un-beholden to the international bankers and to their instruments of debt-enslavement, can even think of standing up to these global forces which surround all individual matters. This means, as one can perceptively observe, in order to effectively reform medicine, a nation first has to neutralize all the forces and power levers, both overt and hidden, that have enabled its draconian embedding with big-pharma.

Just imagine – what will it take to overturn AMA for instance? An act of United States Congress? What does it take to prevail upon the Congress, and upon the President to not veto them? The all powerful American public couldn't alter their pre-fated destiny for even the grotesque 2008 TARP bailout bill in favor of the international bankers! And therein lies the firm connection of all abhorrent constructs in the world today to the most un-natural primordial force in the world before which all powers bow. Over a century ago, Woodrow Wilson, America's 28th president (1913 – 1921) made the following observation about the nature of this power which was witnessed unvarnished by all and sundry a hundred years later in the passage of that TARP bailout bill of 2008:

“Since I have entered politics, I have chiefly had men's views confided to me privately. Some of the biggest men in the United States, in the field of commerce and manufacture, are afraid of somebody, are of afraid of something. **They know that there is a power somewhere so organized, so subtle, so watchful, so interlocked, so complete, so pervasive, that they had better not speak above their breadth when they speak in condemnation of it.**” — The New Freedom, Woodrow Wilson, 1913, Chapter 1, pgs. 17-18

And that same un-natural primordial force, *a power somewhere so organized, so subtle, so watchful, so interlocked, so complete, so pervasive*, also protects its key construct for controlling life and life sciences: Western medicine! It is all interlinked and interlocked, and it cannot be dismantled in isolation from the forces which protect it. That power has a core weakness. It has today harnessed its weakness in its favor. And that is the power to legislate which it owns outright today. That can be overturned overnight by brave nations freeing themselves of their yoke of servitude – or never at all for a millennium and beyond.

The following pertinent passage from Sun Tzu can be the only fitting conclusion:

“If you know the enemy and know yourself, you need not fear the result of a hundred battles. If you know yourself but not the enemy, for every victory

gained you will also suffer a defeat. If you know neither the enemy nor yourself, you will succumb in every battle.” — Sun Tzu, The Art of War

**Short URL:** <http://tinyurl.com/Modern-Medicine>

**Source URL:** <http://print-humanbeingsfirst.blogspot.com/2011/11/whats-thetruth-about-modern-medicine.html>

First Published November 19, 2011

## Chapter 8 Science in the Service of Empire

# Letter to a 'co-conspiracy theorist' : Reflections on Modernity, Climategate, Pandemic, Peer Review, and Science in the Service of Empire

Dear 'co-conspiracy theorist' M – Hi.

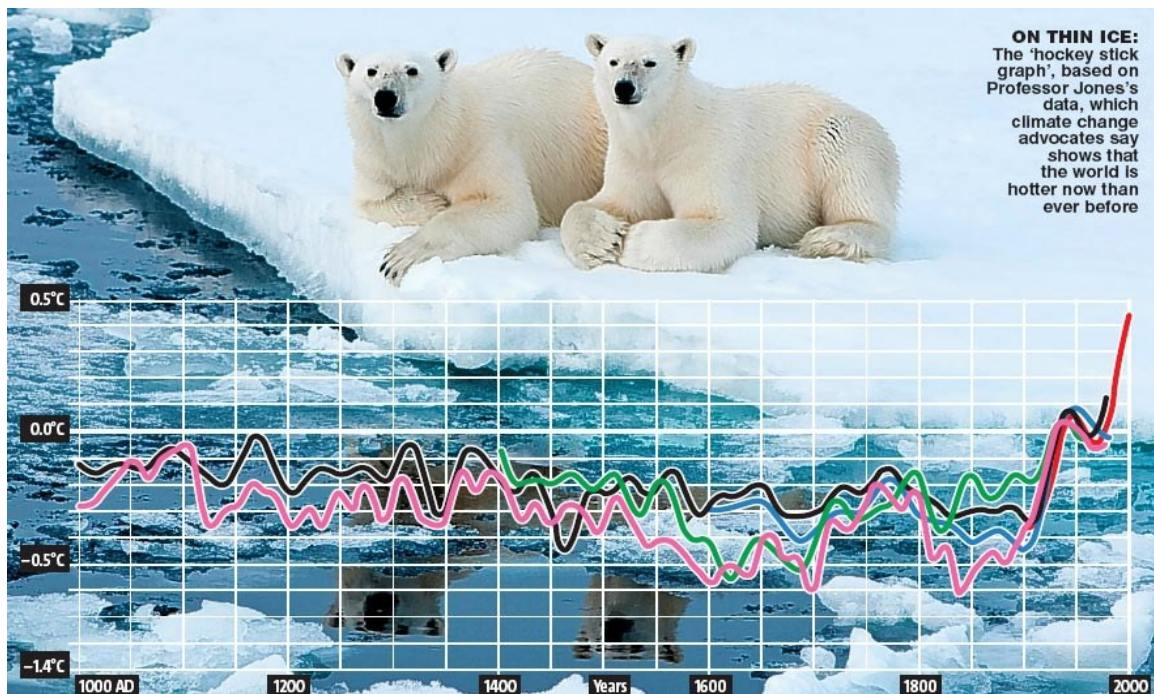

Caption Climategate U-turn 'On thin Ice – The hockey stick graph fraud', The Daily Mail UK, Feb 14, 2010

What Dr. Tim Ball stated in his concluding remarks in the following climategate video also captures my sentiments:

***"... but you know what, finding out that what I was saying was true there is no pleasure in that whatsoever. No pleasure in 'I told you so' because this is a deeply troubling time not only for climate-science, but Science in general."*** -- Minute 9:30, Climategate: Dr. Tim Ball on the hacked CRU emails, November 21, 2009 on [corbettreport](http://www.youtube.com/watch?v=Ydo2Mwnwpac) <http://www.youtube.com/watch?v=Ydo2Mwnwpac>

**The Death Blow to Climate Science**

By Dr. Tim Ball Saturday, November 21, 2009

**HOUSE OF ILL REPUTE**  
Climatic Research Unit, University of East Anglia

Global Warming is often called a hoax. I disagree because a hoax has a humorous intent to puncture pomposity. In science, such as with the Piltdown Man hoax, it was done to expose those with fervent but blind belief. The argument that global warming is due to humans, known as the anthropogenic global warming theory (AGW) is a deliberate fraud. I can now make that statement without fear of contradiction because of a remarkable hacking of files that provided not just a smoking gun, but an entire battery of machine guns.

Someone hacked in to the files of the Climatic Research Unit (CRU) based at the University of East Anglia. A very large file (61

Dr. Tim Ball Bio  
Print friendly  
E-mail a friend  
Contact Us

SHARE

Hypertension

9:36 / 9:58

720p

Caption Corbett Report Climategate Dr. Tim Ball on the hacked CRU emails, November 21, 2009

And as sweeping as that **“deeply troubling time”** statement is, I would say Dr. Tim Ball still didn't go far enough. He did not unravel the overarching agenda and the galactic extent it permeates its corrupting tentacles as noted in this [Letter to Editor: Understanding the Political Science behind Global Warming February 07, 2009](#), and in this [Response to Financial Times Gideon Rachman's 'And now for a world government' December 11, 2008](#).

And neither did Senator Inhofe examine the 'WHY' of **“cooking that science”** in this exchange on Fox News back in June 2009:

Fox News Anchor: **“Does it appear to you that the EPA buried evidence that would have made the President's climate change bill unnecessary”?**

Sen. Inhofe: **“Oh absolutely Greg. They have been cooking that science since 1998. ...”**

Fox News Anchor: **“And here is what Alan Carlin said [Author of EPA 98-page study on climate change]: 'My view is...there is not currently any reason to regulate carbon dioxide. Global temperatures are roughly where they were in mid-20th century. They're not going up. If anything, they're going down.' In other words, if there is no**

***endangerment, there is no need for a Bill.”***

Sen. Inhofe: ***“The thing is phony. I feel so good about being redeemed after all these years... all of those scientists that Al Gore had lined up... all of them used to be on his side, they all said wait a minute, this science isn't right, and that's exactly what Alan Carlin said...”*** -- Minute 0:30, Sen. Inhofe On Global Warming: 'This Thing Is Phony', Fox News, June 29, 2009 <http://www.youtube.com/watch?v=Skf8bpl8WSg>



Caption Video: Fox News Sen. Inhofe On Global Warming: 'This Thing Is Phony' June 29, 2009

The following is an interesting map of global temperatures – I am not sure of the source or accuracy of the specifics of the data from which it is constructed, but the planetary level temperature cycles are quite empirical:



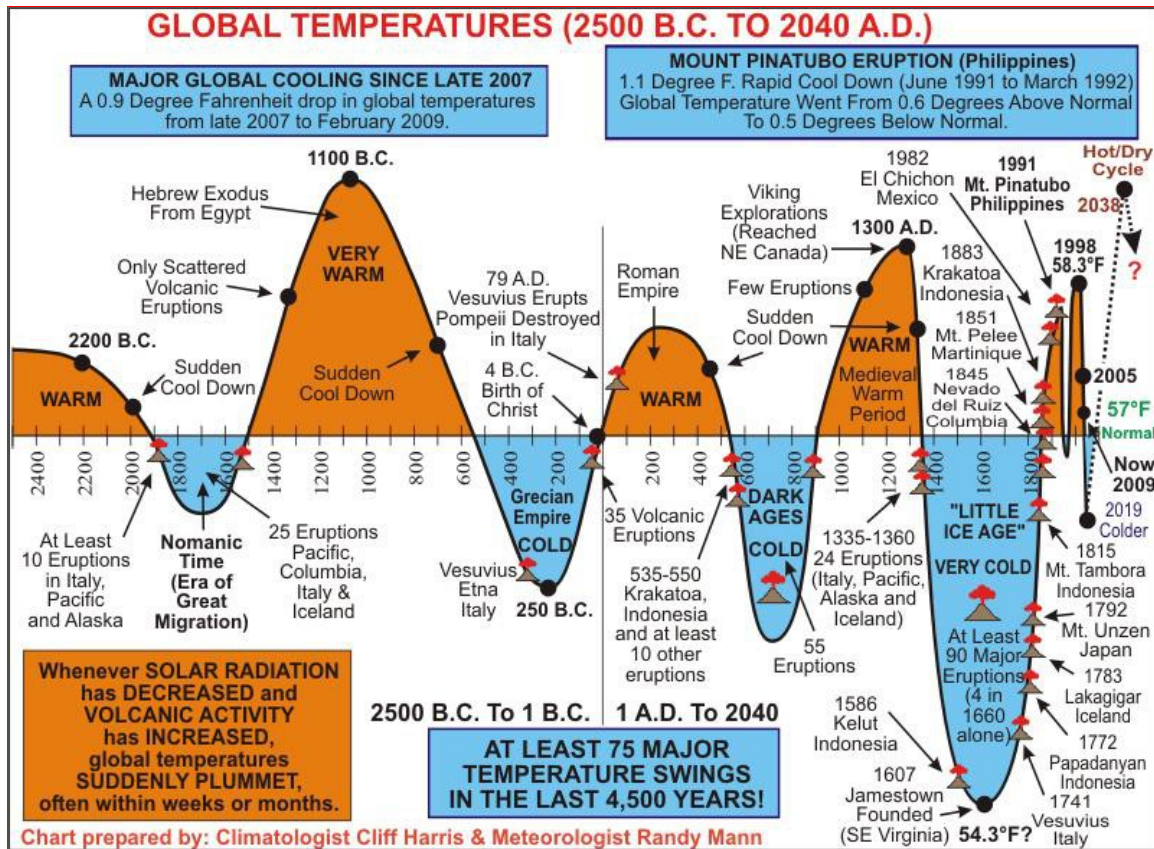

Caption Global Temperature Chart 2500 BC to 2040 AD By Cliff Harris and Randy Mann (Image source longrangeweather.com)

Whereas, not unlike the many previous diabolical mantras deployed by the ruling establishment as pretexts for different facets of its *“imperial mobilization”* agenda, the following is the famous “hockey-stick” science graph used for promoting the mantra of Global Warming:

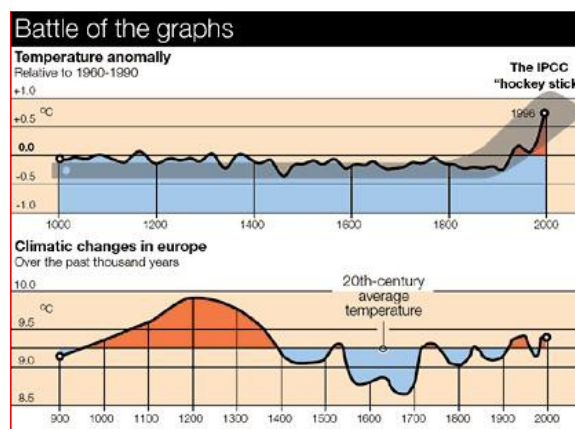

Caption The ‘Hockey Stick’: A New Low in Climate Science by John L. Daly (graph courtesy wattsupwiththat.com)

Canadian Professors Ross McKittrick and Christopher Essex deconstructed that hockey-stick science along with their notable non-conformist collaborator and businessman from Toronto, Steve McIntyre, in their 2003 book *Taken by Storm*, long before climategate. But Prof. Ross too, circumspectly, only called it “**bad science**”, judiciously refraining from calling it **Science in the Service of Empire** which it is:

'Michael Coren: “**What's all this about a hockey-stick?**”

Ross McKittrick: “Well, the hockey-stick graph. This was back in 2001, the Intergovernmental Panel on Climate Change [IPCC], it's a UN body that every five years puts out a big assessment of the science. And they are especially alert to any evidence that really promotes the Global Warming story and they give it lots of promotion. And in 2001, they latched onto this result that was fairly fresh in the literature, that had to do with what's called paleoclimatology. The study of the behavior of the climate from way back before we had thermometers.

Now, for decades the standard view has been that over the past thousand years, there is a Medieval era, which is very warm compared to the present. You know, the Greenland, the Vikings were able to have farms in Greenland. All over the world there is evidence that it was warmer, and basically better for people. And then things got cold for about 500 years, up to the 1800s, and then we were in a warming phase coming out of the little ice-age as it was called.

In the 2001 IPCC report, they changed all that and presented a graph that looks like a hockey stick lying on its side. So the mean state of the climate is almost constant, up until the year 1900, and then suddenly the temperatures started rising rapidly.

**And this was very dramatic. It was an extremely effective graphics for getting people worried about global warming.**

And it featured prominently in the debates over Kyoto, the government of Canada had it on its website. Actually the government of Canada quoted from it in a pamphlet they sent out to households across the country, and governments around the world did the same thing. Al Gore features it in his movie.” -- Minutes 0:23 to 2:20

Michael Coren: “... **Hold on, you are being very generous here.** The

hockey stick was used time and time again, and in fact, it became almost iconic within the Global Warming movement. As you say, movies, and pamphlets sent out to people across Canada. **And you are not saying to me, it was never genuine, either because there was weak research, or even dishonest research, this is kafkaesque.**”

Ross McKittrick: “Well, what we found along the way was there was statistical errors, but one of the big problems was they'd used a contaminated dataset. They had about 400 input data series of these temperature proxies, but the way they were analyzing them was most of the data was thrown out, and there is one little segment of the dataset that all the results depended on, and they are called bristle cone pine series. It's a funny looking tree that grows mostly in Western United States and they grown very old. Thousand years old.

**But, people have long known, and the National Academy of Science has repeated this warning: you shouldn't use them for temperature reconstructions, because they have this hockey-stick shape that's got nothing to do with temperature.**

Well, it turned out that the hockey-stick graph was formed by taking these bristle cone pines and just putting all the weight on them.

**And the original author had redone his analysis taking this small number of bristle cone pines out, and the whole shape changes. The graph just loses its shape, it just becomes sort of noisy and nothing. So, they knew when they published this study.”**

Michael Coren: **“They lied!”**

Ross McKittrick: **“I wouldn't say they lied. I think what they did was they didn't disclose the fundamental weakness of the original result.”** ' -- Minute 4:42 to 6:20, conversation with Professor Ross McKittrick, The hockey stick is wrong and result of bad science, on Michael Coren Show <http://www.youtube.com/watch?v=-1k4mFZr-gE>





Caption Video: Michael Coren interviews Ross McKittrick 'The hockey stick is wrong and result of bad science' July 2008

As the above narratives brazenly disclose, one can't expect any effective policing of empire by those fed from the crumbs of empire, never mind unravel the hidden agendas! Just look at even Professor Ross McKittrick's apologetics on behalf of his fellow-scientist whose fraud he himself exposed, as being mere errors of omissions and not outright lying despite the acute probing by the interviewer. That modus operandi of crafty omissions and half-truths, as is examined later in this letter, is a full lie and the vulgar propagandists' key mechanism for manufacturing mantras, dissent, and consent for empire.

In any event, as the political science thesis contained in my aforementioned Letter to Editor argues, there is indeed a prime reason for **“cooking that science”** of climate-change. It is, quite un-surprisingly, along the same global axis as the prime reason for **“cooking the science”** of Swine Flu as already unraveled in The Swine Flu Chronicles 2009: Why to say 'No' to the Swine Flu Vaccine. See its Preamble for a succinct examination of the principle modus operandi in the globalists' own handwritings. In this case, it is to fabricate plausible sounding justifications for legally ushering in the architecture of 'carbon credit', regardless of whether there is global warming, global cooling, or no significant temperature change. That is the real heart of the matter and the focus of heated debates for the past ten years being whether or not there is global climate change, as now in the climategate that there isn't, is a gigantic red herring.

**The point of focus shouldn't be the unraveling of the deception, but the unraveling of the crucial agendas behind the deception for which mantras are so painstakingly fabricated and consent manufactured.**

As both, Zen wisdom and forensic science dictate, these revelations are **“like a finger pointing away to the moon – don't concentrate on the finger or you will miss all that heavenly glory”!**

That Letter to Editor noted above examined the 'why' question, quoting from an earlier analysis of Global Warming:

'And as is entirely obvious from Mr. Gideon Rachman's article why this is politically motivated, the reasons become clear why this confusion is deliberately being created. If you accept the Capitalist conspiracy for world government, as I have described it, and if you accept the NSSM-200 agenda for population reduction as I have also described it, tying in the hand of Rockefeller to the UN and their agenda for population reduction (citations for these statements are in my various essays), then you must realize why the ruling elite wants to control 'life activity', and carbon-credit is their architecture of control!

It is somewhat akin to acquiring control of a nation's money supply in the guise of managing the economy better. Few in the public understand why such a control is bad anyway, but those who do try to understand it are thrown layers upon layers of obfuscation. Something similar is happening here. Think of acquiring control of 'carbon-credits' almost equivalent to acquiring control of a nation's money supply! This will control every aspect of sustaining life, just as control of money determines every aspect of sustaining the economy. You name it, between the two of them, it will control it in a world-government. And the first recipient of these controls, the carbon-credit specifically, is the developing world, the Global South, because that is where development must be arrested, and populations thinned out! Just as control of money was first exercised where there was a superfluity of industry and commerce, control of 'carbon-credit' is intended to be exercised where there is a superfluity of populations aspiring to grow their nascent economies!' -- NB: On Global Warming December 12, 2008

And it is instructive to juxtapose all of that perspective with the motivation for population control expressed by David Rockefeller at the UN Ambassadors dinner, as transcribed in Project Humanbeingsfirst's Monetary Reform Bibliography:

"Ironically however, the very innovations that are making possible dramatic improvements in human well-being are also creating new problems which raise the spectre of an alarming and possibly catastrophic disaster to the biosphere we live in. And herein lies the dilemma that we all face. Let me illustrate. Improved public health, has caused the world's infant mortality rate to decline by 60 percent over the last 40 years. In the same period, the

world's average life expectancy has increased from 46 years in 1950s to 63 years today. This is a development which as individuals we can only applaud. However the result of these positive measures is that the world population that has risen during the same short period of time geometrically to almost 6 billion people, and can exceed easily 8 billion by the year 2020.

**The negative impact of population growth on all of our planetary ecosystems is becoming appallingly evident. The rapid growing exploitation of the world's supply of energy and water is a matter of deep concern. And the toxic by products of widespread industrialization and increased atmospheric pollution to dangerous levels. Unless nations will agree to work together to tackle these cross-border challenges posed by population growth over consumption of resources and environmental degradation, prospects for a decent life on our planet will be threatened. The recent UN meeting in Cairo is appropriately focussed on one of these key issues, population growth.**

But the controversies which have erupted at the conference illustrate the problem of coming to grips with issues that are deeply divisive and which have a profound moral dimension. The United Nations can and should play an essential role in helping the world find a satisfactory way of stabilizing the world population and stimulating economic development in a manner that is sensitive to religious and moral considerations.

**Economic growth is of course an inevitable corollary of a growing population, and is essential to improved standards of living. But without careful coordination, unrestrained economic growth poses further threats to our environment.**

This was a major subject of discussion at the conference in Rio de Janeiro on the environment two years ago. The focus then was on sustainable growth, and global development. It was pointed out at the conference that growth is most efficiently managed by the private sector, but regulation of the process by national governments and international bodies is also needed. And once again, United Nations can certainly be among the catalysts and coordinators of this process." -- David Rockefeller, United Nations Ambassador's Dinner, hosted by the Business Council for the United Nations, <http://www.youtube.com/watch?v=ClqUcScwnn8>



Caption Video: David Rockefeller speaks about population control at UN Ambassador's Dinner

So many learned people betray shock and surprise by climategate that they betray their own pathetic ignorance of the doctrinal craftsmanship of empire. Yes, and among them are the most brilliant scientists on the planet – a phenomenon I call the **“ignorance of the learned”**. Some are pleased or have the 'told you so' reaction, and some just pooh-pooh it as insignificant, but few betray any deep forensic comprehension of the full import of the Machiavellian agenda behind the mantra now becoming unraveled. I haven't bothered studying these leaked materials since the confirmation they proclaim is a waste of my time. **As the good Dr. Tim Ball candidly stated, it also gives me absolutely no pleasure to receive confirmation that I see the tortuous reality for what it is.** I'll examine their details when it becomes pertinent to some analysis I am doing. These climategate leaks contain no profound knowledge which can benefit me – and that's because Hari Seldon's statecraft of 'psychohistory', I mean Machiavellian political science, predicts the hijacking of hard-science as well as social-science accurately. It is manifest across the board.

And Dr. Tim Ball acutely put his finger on the precise modus operandi used in imperial science today as its key loci of control for conferring credibility and respectability to priesthood for inclusion into empire's officially approved churches: the **peer-review** process. I call it **“incestuous science”**! The peer-review process cannot approve or adjudicate, by definition, anything outside of the conventional wisdom endorsed by the peers of empire if the science ever goes against the principal interests of empire. So, while it can work well for science which does not challenge empire's interests or entrenched prevailing wisdom, peer-review has undeniably become a bloody scam to promote establishment's own agendas, to issue grants, to authenticate pseudo-scientific plausible-sounding justifications for pre-determined outcomes, and to see who falls in line for further reward and who qualifies for ostracization.

This should be self-evident irrespective of the climategate brouhaha. Page 101 of John Perkins 2004 book “**Confessions of the Economic Hitman**” for instance, also reveals an example of the perverse respectability gained from peer-review publishing of entirely bogus mathematical econometric-theory in furtherance of the hegemonic agenda for diabolically acquiring control over developing nations and their natural resources. This is what John Perkins confesses in the opening pages of Chapter 17, titled *Panama Canal Negotiations and Graham Greene*:

'Bruno came up with an idea for an innovative approach to forecasting: an econometric model based on the writings of a turn-of-the-century Russian mathematician. The model involved assigning subjective probabilities to predictions that certain specific sectors of an economy would grow. It seemed an ideal tool to justify the inflated rates of increase we liked to show in order to obtain large loans, and Bruno asked me to see what I could do with the concept.

... By 1977, I had built a small empire that included a staff of around twenty professionals headquartered in our Boston office, and a stable consultants from MAIN's other departments and offices scattered across the globe. I had become the youngest partner in the firm's hundred-year history. In addition to my title of Chief Economist, I was named manager of Economics and Regional Planning. I was lecturing at Harvard and other venues, and newspapers were soliciting articles from me about current events. I owned a sailing yacht that was docked in Boston Harbor next to the historic battleship *Constitution*, “Old Ironsides”, renowned for subduing the Barbary pirates not long after the Revolutionary War. I was being paid an excellent salary and I had equity that promised to elevate me to the rarified heights of millionaire well before I turned forty. True, my marriage had fallen apart, but I was spending time with beautiful and fascinating women in several continents.

... [With that as background] I brought a young MIT mathematician, Dr. Nadipuram Prasad, into my department and gave him a budget. Within six months he developed the Markov method for econometric modeling. Together we hammered out a series of technical papers that presented Markov as a revolutionary method for forecasting the impact of infrastructure investment on economic development.

It was exactly what we wanted: a tool that scientifically “proved” we were doing countries a favor by helping them incur debts they would never be

able to pay off. In addition, only a highly skilled econometrician with lots of time and money could possibly comprehend the intricacies of Markov or question its conclusions. The papers were published by several prestigious organizations, and we formally presented them at conferences and universities in a number of countries. The papers – and we – became famous throughout the industry.'

And specifically, returning to climategate, in the case of the first author of climategate sciences in the service of empire, John L. Daly wrote the following of Michael Mann in [The 'Hockey Stick': A New Low in Climate Science](#):

### **'Michael Mann**

At the time he published his 'Hockey Stick' paper, Michael Mann held an adjunct faculty position at the University of Massachusetts, in the Department of Geosciences. He received his PhD in 1998, and a year later was promoted to Assistant Professor at the University of Virginia, in the Department of Environmental Sciences, at the age of 34.

He is now the Lead Author of the 'Observed Climate Variability and Change' chapter of the IPCC Third Assessment Report (TAR-2000), and a contributing author on several other chapters of that report. The Technical Summary of the report, echoing Mann's paper, said: "The 1990s are likely to have been the warmest decade of the millennium, and 1998 is likely to have been the warmest year."

Mann is also now on the editorial board of the 'Journal of Climate' and was a guest editor for a special issue of 'Climatic Change'. He is also a 'referee' for the journals Nature, Science, Climatic Change, Geophysical Research Letters, Journal of Climate, JGR-Oceans, JGR-Atmospheres, Paleo oceanography, Eos, International Journal of Climatology, and NSF, NOAA, and DOE grant programs. (In the 'peer review' system of science, the role of anonymous referee confers the power to reject papers that are deemed, in the opinion of the referee, not to meet scientific standards).

He was appointed as a 'Scientific Adviser' to the U.S. Government (White House OSTP) on climate change issues.

Mann lists his 'popular media exposure' as including - "CBS, NBC, ABC, CNN, CNN headline news, BBC, NPR, PBS (NOVA/Frontline), WCBS,

Time, Newsweek, Life, US News & World Report, Economist, Scientific American, Science News, Science, Rolling Stone, Popular Science, USA Today, New York Times, New York Times (Science Times), Washington Post, Boston Globe, London Times, Irish Times, AP, UPI, Reuters, and numerous other television/print media" [17].

Mann's career highlights a serious problem with the modern climate sciences, namely the 'star' system where high-profile scientists are promoted swiftly to influential positions in the industry. Such a star system reduces a science to the level of Hollywood.'

Unfortunately, the last passage in the aforementioned complete quote is where John L. Daly too failed to appreciate the import of Science in the Service of Empire, narrowly pinning the problem as only plaguing "*modern climate sciences*".

It should be evident to all men and women of science that neither Darwin nor Galileo would ever have passed peer-review. The fact that genuine scientists seeking the peer review process don't seem to care about this blatant obviousness which is even rooted in historical precedence, suggests that they wisely choose to remain within the allowable confines of acceptable research, i.e., funded research, even when they have no diabolical or mal intent of their own. The control in science is exercised in a manner not too dissimilar to permitting vigorous and contrarian social debate within an allowable spectrum to give the illusion of free speech and freedom of thought! Those falling outside the allowable limits are of course variously labeled and marginalized.

Thus, while no one may challenge the sacred-cow Holocaust™ narrative in the EU or Canada without going to jail as everyone already knows, debating and developing competing theories on Islamofascism and maligning Islam and its Prophets is greatly encouraged as the epitome of freedom of speech and profound intellectualism. **But challenging the very premise of Osama Bin Laden or 'Radical Islam' is frowned upon, and will likely soon be labeled 'terrorism' if it isn't already.** Rendition can't be that far behind. Nevertheless, it is still easier to survive being marginalized in the social discourse arena. But quite impossible to do so in science which has become a big budget operation requiring institutional support and endorsement.

That abuse of science, the "**incestuous science**", in the present vaccination drive for the swine flu forms the underpinning of this [Note on Vaccination](#) which expresses a unique concern that is still largely outside the many paradigms of concern expressed by many of the nay-sayers in their own formulations of why they are against the swine flu vaccine, or

against vaccination in general:

'My immediate concern is the latter which includes an entire gamut of political abuse, from eugenics to GMO foods to epidemics – which harvests justifications and techniques from science and technology – all for population culling and elimination. It's akin to abusing Islam to create the fabled enemy of 'Islamism' for a war-making agenda – whether or not there is some inherent deficiency in the religion is irrelevant and orthogonal to its political abuse for “imperial mobilization”.' -- The Swine Flu Chronicles 2009: Why to say 'No' to the Swine Flu Vaccine

The aforementioned concern is even more eloquently voiced by the polymath Spanish Benedictine nun at San Benet of Montserrat's Monastery in Barcelona, Dr. Teresa Forcades, with the peerless credentials: Physician specialist in Internal Medicine, Ph.D. in Public Health, and Degree in Theology from Harvard University.

**Swine Flu Dr. Teresa Forcades Spanish Benedictine nun at San Benet of Montserrat's Monastery in Barcelona, Sept 23, 2009**

<http://vimeo.com/7298827>



And that full spectrum abuse of science, the “**incestuous science**” in the service of empire, is the crucial heart of the matter today.

The fact that we see it occurring repeatedly across the board – from the government sanctioned official but absurd NIST report on how the WTC towers catastrophically collapsed into their own footprints on 911, to the fraudulent climate-change science of Global Warming, to the brazenly criminal medical science of swine flu pandemic promulgated by government sanctioned official bodies like WHO and CDC – minimally



shows how science is being perversely used in the service of empire. What a tortuous implementation of Sir Francis Bacon's drive to inter-link the pursuit of the nascently emerging Western science in the 17th century with imperial funding from the superpower du jour, in order to more effectively deploy the harvest of science in the service of humanity (and of course empire): ***“human knowledge and human power meet in one”!***

It is immensely interesting to also note in passing that Noam Chomsky insisted on 911 science be peer-reviewed before he'd read the papers written by Jones et. al. And when it finally got published by a maverick online journal (I sent a thank you note to them), my dear professor Noam Chomsky – to whom I will forever remain indebted as the teacher who actually taught me to think critically – insisted that he will wait for other credible scientists in that domain to critique it before reading and/or offering his own opinion as he was not a domain expert in how tall buildings collapse, and that letting the domain experts sort it out first in peer-reviewed journals is the acceptable process of science!

What a new born baby octogenarian – or perhaps Noam Chomsky had understood rather well that going against the grain on 911 would be severely career limiting for any technical domain expert, and thus it was, and perhaps still is, safe to argue in this way? A specious red herring? Or merely intellectual convolutions to continue echoing empire's sacred-cow axioms of ***“imperial mobilization”*** while appearing to challenge its deadly expression?

Does it take a domain expert, or some ordinary un co-opted commonsense observation to realize that this free-fall symmetrical collapse into its own footprint suspiciously looks like controlled demolition, and that this and this catastrophic instantaneous powdering of tall buildings into fine dust are hardly the gravity collapse of a standing steel structure due to fire; never mind the fact that no response from empire's imposing air defense systems on that ill-fated day when the hijacking drama was unfolding smacks of active collusion at the highest levels of the US military high-command; and therefore, minimally, to pin 911 on Osama Bin Laden based on some newly discovered faith in officialdom after a life of dissent is profoundly anti-intellectual?

All are empire's own multifaceted instruments of public relations, as well as its “approved science”, and its “approved dissent”. The political abuse of science to serve hegemonic agendas is a monumental scam, and Dr. Ball's following terse expression is very perceptive:

“... [in the debate about the hockey-stick] these people are all publishing together, and they all peer-reviewing each other's literature. So there is a classic example of [incestuous self-reinforcement] ... **why are they pushing**

**the peer-review issue so big, why are they saying well, you haven't published peer-review ... and now of course we realize is because they have control over their own process.** That's clearly exposed in these emails. On a global scale it is frightening.... they control the IPCC. They manipulated that ... The IPCC has become the basis in all governments for the Kyoto Protocol, the Coopenhagen Accord, and so on!” Minute 1:20, Tim Ball, Op. cit.

Anecdotally, I will recall for you some interesting personal experiences of the abuse of peer review by individuals. In the late 1980s when I worked as a development engineer in a computer company, my new office-mate, a recent Ph.D. from a very reputed top school in the United States and only 25 years of age (he celebrated his 25th birthday after his first day at work), had published almost 20 or so papers on the operating system he had worked on for his Ph.D. thesis. In any case it was a large number of papers, I may be forgetting the precise number. So, one day, having nothing better to do, I read all his published papers that were listed on his imposing resume – there was no web at the time, and only hardcopy of these papers existed which he fortunately had in the office. I also read his Ph.D. thesis. And I was very puzzled. 90% of the content in the refereed and conference papers was identical. To my mind, the differences didn't warrant new papers, only perhaps separate sections, and at most 2 or 3 papers. So I asked him about it. He candidly told me that this is how the game is played, and that those who didn't play it, paid the price. This scholarship inflation is indeed rewarded with academic respectability, not just in academe, but in corporate research as well. A few years later, another graduate student in computer science developed a fancy piece of software to automatically synthesize an entirely gibberish but plausible sounding paper in context by scanning words and sentences in already published papers, and submitted his genius to one or more peer-reviewed journals.

My god – one of them actually published it. I do not recall the full details now, except that the gallant chap also sent in a note informing them how the paper was created. And as I vaguely remember, there was both amusement, and minor discussion on the poor peer-review process by over-worked professors, but no major scandal. Obviously! And lastly, a few years ago when I briefly consulted for a big-shot scientist in Pakistan, when he introduced himself to me by saying he had 600 publications to his credit, I recalled for him that possibly the mightiest physicist of the 20th century after Einstein, the Nobel Laureate Richard Feynman of Caltech, had only 37 or so published papers, and that how did he get so many. I can't even remember this inflated egoist's answer today!

All this isn't “**incestuous science**” per se and is perhaps more akin to tolerable noise in any system. But it does show that the glorified peer review is far from being the pristine

scientific process that it is made out to be, and that people will be people, and when quantity of publications is incentivized, they will routinely find clever ways to harness the process for their own narrow interests which may have nothing to do with the science per se in no less measure than the ruling establishment.

The same arguments are easily extended to the examination and granting of patents, fancifully called the intellectual property rights. All of my patent filings for instance were primarily a business decision made by the corporation to create a patent portfolio as a currency of barter in patent infringement lawsuits. I doubt very much that the patent examiners anywhere have the wherewithal to know what is prior art and what isn't, as all engineering and technology fields have exponentially grown since the concept of patenting was invented as a business tool to allow entrepreneurs to capitalize on their product inventions for a limited time. That has today transformed into the abhorrent WTO extortion racket to mainly prey upon the developing nations!

Dear M, returning to the Machiavellian political science which lends so much insight into almost everything man endeavors, it is almost as if my favorite science fiction novelist, the galaxologist Isaac Asimov, was vicariously projecting Hari Seldon's psycho-historical calculations for guiding the course of "future-history" of his fictional empire on the vast intergalactic canvas, as a profound clue to mankind to get them to forensically comprehend manufactured reality. Just like Plato had done in his *Myth of the Cave*, 2500 years earlier.

People in the West tend to go all gaga when an obvious conspiracy is finally revealed to be true, as in this case of climategate. But worse, many of them tend to focus on its how-whiz minutiae when the iron is hot instead of doing something useful with it, and then simply move-on deeming the scandal to be a one-of case of some misguided policy gone awry or case of individual corruption. And at best, a nefarious but myopic agenda which is not related to any other agenda of the establishment. This armchair anguish also remained the case with the revealing of the Iran-Contra scandal in the 1980s which momentarily riveted the attention of the American public. No one at the time questioned why was America criminally assisting the two neighborly countries of Iran and Iraq to fight each other to death; only that it did this in some non-kosher way. The exact same thing is once again transpiring in climategate. Few are focussing on connecting the dots towards a bigger picture – deliberately missing the Zen of political science.

This circumscribing of the imagination in the erudite Western intellect is almost as if the Western mind has been calculatingly indoctrinated into the notion that the pursuit of sciences is a pristine, highly objective endeavor of incredibly moral supermen devoid of any political agendas in promulgating the objectives of empire that funds it. It is akin to the

Eastern mind long having become attuned to the notion of predestination because of which it silently continues to suffer its fate at the hands of its own oligarchy. Each half of the world, apparently, are wont to sacrifice different half of their brain at the altar of their respective feudal priestdoms.

The military-industrial complex of America for instance is entirely scientist driven at its technological forefronts. This is plainly visible and openly conducted, and therefore, not one sane person in the world would deny that such science and technology pursuits entirely serve the interests of Western hegemony.

But when caught in a lie for executing far more diabolical objectives of the hectoring hegemon in circuitous ways – because these may not be articulated or pursued so openly even when it is not a state-secret and the information is available to anyone – the Western intellect suddenly fails! How could these scientists possibly have been working for the establishment's own Machiavellian agendas – it must surely be that they were merely personally corrupted at best, or just did “poor science” in an incestuous cabal. The “lone-gunman” theory of sciencegate!

In making better guns and bigger bombs, bioweapons and econometrics, and other assorted technetronic-gadgets for empire that enables backing its MacDonald franchises with McDonnell Douglas, since all of it is an open enterprise, no one doubts that scientists and technicians work for empire and are generously rewarded for it. In fact, it is even bandied about with great eloquence:

**“The hidden hand of the market will never work without a hidden fist -- McDonald's cannot flourish without McDonnell Douglas, the builder of the F-15. And the hidden fist that keeps the world safe for Silicon Valley's technologies is called the United States Army, Air Force, Navy and Marine Corps.”** -- Thomas L. Friedman, A Manifesto for the Fast World, NYT March 28, 1999

But to make the multi-pronged complex architecture of diabolical control of humanity possible, well, that just can't be. That is just conspiracy theory! So let's just narrowly concentrate only on the facts that have been disclosed ... like why the sum of squares goes negative in the source code of climategate!

As is amply evident over the past few weeks since the climategate scandal broke, almost all people of scientific acumen continue to focus on the fascinating mechanics of how Mann et. al., said their “gun” worked, but it actually didn't! So bad-bad-scientists. Let's just clean

up the climate sciences of its rotten eggs and move-on. This attitude is clearly visible in almost all the stellar conversations on climategate in cyberspace even among the academics. Especially among the academics! See for instance this [open letter](#) by Prof. Judith Curry, and her [editorial](#).

This tunnel vision isn't limited to climategate however, but permeates all imperial mantras the most prominent and most deadly to date of course being the “**Global War on Terror**”. I look forward to the day when similar email revelations will show how 911 was an inside job and how any challenge to the official narrative was to be suppressed, including in science publications and only the Popular Science version which elaborated on the NIST science was to be promulgated. At that time, all the uber intelligent beings will once again similarly become fixated with the minutiae of the obvious. But yesterday, as today, when boldly asserting so by influential men and women of science could surely have derailed “**imperial mobilization**” to Afghanistan and Iraq thus preventing all the horrendous crimes against humanity which followed, it remained a conspiracy theory of the lunatic fringes who saw gods in the sky.

My all time favorite physicist of Pakistan, the MIT literate prodigy, Dr. Pervez Hoodbhoy, the scholar who contributed his own punditry to the mantra of Islamism in dialectical penmanship to Daniel Pipes' in erudite prose like “[Between Imperialism and Islamism](#)” and “[The Threat From Within](#)”, once wrote me in response to my trying to get him to see that Bin Laden couldn't have done 911 as WTC collapses looked like controlled demolition and that he, Hoodbhoy, was failing to connect all the dots which clearly lead to puppetmasters, saying something to the effect: ~ “**remember how our ancestors connected the dots in the sky and saw all those shapes as their gods...**”.

So henceforth, Pervez Hoodbhoy judiciously avoided connecting the dots lest he too be misled into seeing things that aren't there, while of course finding it infinitely pleasurable to continue echoing the mantras and axioms of empire. Not only MIT trained scientists, but apparently almost all major scientists and scholars of any IVY and other lofty pedigree are pregnant with imperial wisdom in that way.

These brilliant scholars only see puppetshows, and painstakingly describe them, but never go towards uncovering the forces which drive them. Since I have already described their salient characteristics in detail before, let me just reproduce it here as its worthwhile to relate that to the topic at hand:

- None of them betray that they possess long term memories, or any comprehension of even recent history that can be contextualized to the present.

- None of them seem to have heard of 'covert-ops' and 'black-ops'; none of them have read the shrewd analysis of the imperial thinkers themselves of the necessity of real mobilizing pretexts such as the *"New Pearl Harbor"* and *"clear and present danger"* as otherwise *"Democracy is inimical to imperial mobilization"*.
- None of them apparently understand that covert-ops while they are operational and active, are meant to be secretive and mendacious, which is why they are called 'covert', and that their unraveling necessitates perceptively seeing beyond what's being deliberately made manifest and what's being insisted upon as **'two plus two equals five'** - for hard receipts for them will only be uncovered by historians through the famed declassification process post faits accomplis.
- Thus all of these 'astute' thinkers, commentators, and media pundits none too miraculously reach the same minimal and common conclusion space regardless of their own starting thesis or the circuitous routes taken in their analysis and speculations, that at the bare minimum, the scourge of 'fundamentalism' and 'militant Islam' needs to be checked with renewed commitment in the global 'war on terror', or else no one in the 'civilized world' would remain safe from these antiquated Taliban style 'evil jihadis' and 'al qaeeda'. That root of terror has now been successfully showcased as residing in Pakistan – the *'Terror Central'*!
- It is indeed deemed a 'clash of civilizations', not of the East and the West titans, but of 'radical antiquated militant Islam' and the rest of civilized humanity! That *"Today [even] if one could wipe America off the map of the world with a wet cloth, mullah-led fanaticism will not disappear"*, as the distinguished native-informant par excellence, the world class physicist Pervaiz Hoodbhoy, has conclusively observed in his latest analysis of the matter in "Preventing More Lal Masjids", and which he had earlier explored in great analytical depth in "The Threat From Within". And none [too] surprisingly, echoing the same mantra of Pakistan becoming a 'terrorist sanctuary' [as] CNN a few days ago [which] aired the documentary by Nick Richardson "Pakistan - The Threat Within". The unanimity of this conclusion space is scary to say the least – at least for us Pakistanis.
- It would appear that the world's leading thinkers, journalists, newsmedia, scholars and leaders *"united we stand"* that Pakistan poses a serious threat to world peace! **Not the hectoring hegemony who have cleverly utilized 911 "to goosestep the Herrenvolk across international frontiers"** in what only

appears to be another 'operation canned goods' or the 'Reichstag fire' or the much coveted 'New Pearl Harbor' to achieve the 'transformation of [its] forces' to achieve 'full spectrum dominance' over the planet and outerspace, **but my wretched lands of the ancient Indus valley, and my wretched peoples – we are the world threat!** -- Saving Pakistan from Synthetic 'Terror Central' - Orchestration of 'Lal Masjid' – a precursor to 'shock and awe'? July 13-23, 2007.

In the light of what is transpiring in Pakistan today, it is not at all prescient that Pervez Hoodbhoy should have written the following in his ode to Daniel Pipes: "The Threat From Within". In response to it, I had been compelled to write to dissent-specialist Hoodbhoy that had there not been an author's name in that document and someone had asked me to guess who had written it, I would have easily guessed Daniel Pipes. Take a look at the following passage for instance:

### **'Is Radical Islam Inevitable?'**

With the large and growing popular sentiment against Musharraf and his army, one cannot rule out the possibility that in the years ahead nuclear armed Pakistan may fall under a neo-Taliban style Salafi-Wahabi-Deobandi leadership allied with conservative senior military leaders. If it does, then Pakistan could become the world's most dangerous state. But, although possible, it is certainly not inevitable – countervailing forces work against this nightmare scenario.' -- Pervez Hoodbhoy, Pakistan – The Threat From Within, Pakistan Security Research Unit (PSRU), Brief Number 13, 23rd May 2007.

The crafty Machiavellian omissions present in that saintly expression of fear by uber physicist Pervez Hoodbhoy: "***in the years ahead nuclear armed Pakistan may fall under a neo-Taliban style Salafi-Wahabi-Deobandi leadership allied with conservative senior military leaders. If it does, then Pakistan could become the world's most dangerous state***", was once again most recently dismantled in Response to 'Wahabization- Salafization of Pakistan and Muslim Ummah : Fighting the Terrorists But Supporting Their Ideology'.

It is respected scholars like these – hiding behind academic freedom of speech and the press – who continually manufacture disinformation as agents, assets, and sayanim of the Mighty Wurlitzer that has caused me to waste so much of my precious time penning the million obvious words on my website to refute their half-truths and Machiavellian spins, for **it takes a sentence to construct a lie, considerably more space and time to refute it.**

Noam Chomsky had himself noted this bit of truism, I am sure realizing its full import for his own writings of crucial omissions. And who has the time to read the long refutations even if someone bothers to diligently offer them, even inviting a riposte? Those being refuted simply ignore it. None may withstand the glare of truth in bright sunlight except those wearing sunglasses!

Omission, the cardinal sin of all totalitarian propagandists when they do purvey half-truths instead of outright full lies – which, as Gary Null put it, “**there is an old Jewish saying, a half truth is a full lie**” – is even more effective for deception. Aldous Huxley had insightfully noted its impact in the (circa 1946) Preface to his 1931 novel *Brave New World*:

‘The greatest triumphs of propaganda have been accomplished, not by doing something, but by refraining from doing. **Great is truth, but still greater, from a practical point of view, is silence about truth.** By simply not mentioning certain subjects, by lowering what Mr. Churchill calls and “iron curtain” between the masses and such facts or arguments as the local political bosses regard as undesirable, totalitarian propagandists have influenced opinion much more effectively than they could have done by the most eloquent denunciations, the most compelling of logical rebuttals.’ -- Aldous Huxley, pg. 11, *Brave New World*

And this appears to be how science and scientists are both put to work for echoing the message of empire. Through calculated omissions and retaining the sacred-cow axioms, be it pertaining to hard science, such as in this climatology scam and in the 911 NIST report scam, or related to social science as in the 911 Commission Report scam in order to perpetuate the same political theology of empire while appearing to investigate it.

This modus operandi is what we had been seeing of the Global Warming mantra even before the climategate brouhaha erupted. Awarding of the Nobel Prize to Al Gore only added Public Relations manufacturing to the game. Now, all new born baby pundits may also verifiably glean how the establishment was pulling its invisible strings to fabricate the mantras and the silence about truth. It didn't seem to have worked to the establishment's complete satisfaction this time around – but in how many other cases has it worked, and is still working?

Science is a blatant instrument of empire when it is necessary for it to be so, even when the scientists might proclaim themselves innocent like the new-born baby. Interestingly, or perhaps sadly, many whom I know personally do tend to behave as if they were indeed born yesterday when it comes to comprehending dialectical social engineering! They often



proclaim, when their naïveté is challenged, that political science is not their field – as if it requires a Ph.D. to know when is one being taken for a ride on the horns of erudite gibberish!

Are the mighty men and women of science really all that much different from any astute politician? While one may pen much prose to show the reasons for their apparent gullibility, from self-deception to actual collusion, from having accepted or told one lie to the necessity of accepting and/or narrating subsequent lies until the soul is in so deep that it can't extricate itself either mentally or physically, etceteras, the undeniable fact remains that ultimately, both the politician and the scientists are fed from the same coffers and therefore serve the same ruling interests. If they didn't, or if they made waves, they'd be out. Those who ultimately control the purse strings control the research as well as the opinions. The paymasters decide the science that gets funded, and the science which is not pursued. This is most brazenly obvious in the Big-pharma led medical science today that is pushing vaccination, vaccines, and other toxic cocktails to the exclusion of all natural and alternate remedies.

And who doesn't open their mouth wide for the great benefits – both tangibles and intangibles – to be accrued from cooperating with the ruling wisdom, and minimally, for the opportunity to passionately pursue well-funded science in the mainstream and earn all its rewards of respectability and a productive career? Who will jeopardize that?

Only genuine 'conspiracy theorists'!

The entire barrel of apples is rotten to the core! The intellectual corruption of modernity has amazingly seeped into all fabrics of society, almost without exception, from organized religion to organized science and everything in between. And the primemover source of that corruption is namely one today! It is the one with the deepest and most infinitely replenished pockets to spend on all that is vile disguised as philanthropy, the pursuit of science, the humanities, the arts, and for the good of high society. Some of it of course is. But the good is also a veneer to pursue world-domination agendas of those who rule from behind the scenes. A patient but forensic read of Prof. Carroll Quigley's seminal history text of empire "Tragedy and Hope" makes that abundantly clear. In his commentary on that text, the following statement of W. Cleon Skousen sheds the most pertinent light on the calculated "ignorance of the learned":

'The real value of Tragedy and Hope ... [is the] bold and boastful admission by Dr. Quigley that there actually exists a relatively small but powerful group which has succeeded in acquiring a choke-hold on the affairs of practically

the entire human race. Of course we should be quick to recognize that no small group could wield such gigantic power unless millions of people in all walks of life were “in on the take” and were willing to knuckle down to the iron-clad regimentation of the ruthless bosses behind the scenes. **As we shall see, the network has succeeded in building its power structure by using tremendous quantities of money (together with the vast influence it buys) to manipulate, intimidate, or corrupt millions of men and women and their institutions on a world-wide basis.**' -- W. Cleon Skousen, *The Naked Capitalist*, pg. 6

Oligarchs have of course always existed, and presumably always will. Aldous Huxley noted in his [famous talk in 1962 at Berkeley](#) that the rulers getting the serfs to love their own voluntary servitude would be the “*ultimate revolution*” in social control. That notion, of puppetmasters seeking ways and means to control the populace, is simply empirical.

Indeed, since time immemorial, the kingmaker has been either a god, or the oligarchs. And some uber skeptics even argue that our entire conception of organized religion is an invention too. I don't quite go that far unless the Anunaki arrive from planet Nibiru in my own lifetime. Then, I might perhaps concede the obviously compelling argument that all controlling dogmas on planet earth were indeed fabricated instruments of social cohesion and control throughout our social evolution, and which, going forward in our continued evolution according to the prevailing tenets of social Darwinianism, is to be replaced by Adam Wieshaupt's Secular Humanism. But I doubt I'll ever stop being a **theist** even then, for I can't imagine believing that we are merely an extended amoeba without a soul! Those who don't need that 'crutch' are certainly mightier than I. They are welcome to their superman state.

And to take on these 'ubermensch' in every generation, and to keep them in check, is the only way to keep the real primemover of evil also in check. That dialectical Manichean struggle automatically enables, and is otherwise also culpable, for all the good or evil that follows.

That is clearly the responsibility of us all. But only the 'idle conspiracy theorists' seem to recognize it, or want to take it on as a moral imperative.

So, I am writing this letter to you, my dear co-conspiracy theorist M, for pondering the profound question: **how can this general polymath wisdom of Hari Seldon's political-science be shared with others before it becomes mainstream confirmation; before it becomes fait accompli?**

Ex post facto, when it is time for it to become history for public consumption, of course all will see it. Like the old proverb says, something to the effect, they come running with the news after all the barbers in town already know! And they laugh their way to their bank penning their narratives, with lofty prizes and prestigious titles awarded them by the very instruments of empire they appear to hector before their flock.

My teacher Noam Chomsky, is perhaps the most egregious example of this. The New York Times called him **“arguably the most important intellectual alive”**. Indeed he is. His imposing books are undeniably the most exhaustive compilation of the crimes of empire. But in critically examining his prolific life of dissent without being snowed in by his voluminous body of work, at least on two of the gravest moments in any ordinary intellectual's life, never mind the **“most important intellectual alive”**, when the most urgent need of the hour was to publicly show bold skepticism for the narratives of power, Noam Chomsky persisted in exactly echoing the core sacred-cow axioms of empire. From the officially promulgated lone-gunman theory of JFK assassination, to the officially promulgated 19 hijackers theory of 911, he cleverly echoed the sacred-cow axioms of empire even in his dissent!

While Noam Chomsky has eruditely accused empire of manufacturing consent by deceiving the public, I strongly suspect him of manufacturing dissent to effectively assist the empire at the most crucial times in the same. To me, the New York Times awarding that title to an intellectual like him is akin to awarding the Nobel Peace prize to Jimmy Carter – as both a reward for a job well done for empire, and to help fabricate a dissent-chief for the malcontents resisting empire. The epithet proudly adorns Noam Chomsky's many books and has surely helped him acquire a prestige which even prompted a notable rebel leader like President Chavez of Venezuela, to wave one of his books from the United Nations as the epitome of moral resistance to empire.

So I ask you in conclusion dear M, is there any intellectual discourse at all possible to explain all this to others, and have one see not only its palpable wisdom, but also the categorical imperatives that automatically spring from it, which, if one voluntarily shirks responsibility for, one acquires the blood of an accomplice on one's hands?

Or, would only the Charles Dickens' character, Madame Defarge, with her guillotine basket, provide the right motivation to enable one to call reality the way it is in this age of atheistic relativism when spiritualism is dead even for many a pious savant still on the prayer mat?

Best wishes,

Zahir Ebrahim, [Project Humanbeingsfirst.org](http://Project.Humanbeingsfirst.org)

**Short URL:** <http://tinyurl.com/Science-in-Service-of-Empire>

**Source URL:** <http://print-humanbeingsfirst.blogspot.com/2009/11/let-co-conspiracy-theorist-climategate.html>

First Published November 30, 2009

## Chapter 9 Islam in the Service of Empire

### Islam and Knowledge vs. Socialization

**The very foundation of hegemony and empire lie in the public holding largely facile views of truths essential to the rulers.**

I sometimes like to tee off my writings on the human condition from the opinions I hear being expressed among the common man, in the grapevine, or in the news media. The quoted perspective below is from an unknown website written by an anonymous person. It expresses the seeds of a crucially pertinent topic to the human condition which is examined in considerable depth in this article.

'On occasions, I feel Muslims 'lose' something when it comes to religion. I am speaking about the second last prophet Jesus or Isa (E-sa) peace be upon him. ... My general opinion of Muslims is that they tend to take on a facile view of Christianity ... I get the feeling that this may be because: If an increase in discussions by Muslims of Jesus (pbuh) were to take place, it would be perceived as "being Christian".' ---- [article](#)<sup>[1]</sup>

The interesting perspective embodied in that quote which inspired me to address this issue, is along the lines which reduce to the following empiricism: Human beings in general don't tend to appreciate what is not part of one's own socialization.

Furthermore, with suitable inculcation, this lack of appreciation can span the gamut of behavior from remaining largely indifferent to being outright antagonistic to what's not perceived as one's own. The limit of that of course being intense doctrinal hatred and warfare.

This is pretty much a universal trait. An observable universal truism if there is one. And just as applicable to one as to another.

Upon this truism is the manipulative jingoism of antiquity to modernity constructed. We see this from tribalism to ethnocentrism, and nationalism to patriotism.

It is even the basis of the following formulation in Zbigniew Brzezinski's *The Grand Chessboard*: *"More generally, cultural change in America may also be uncongenial to the sustained exercise abroad of genuinely imperial power. That exercise requires a high degree of doctrinal motivation, intellectual commitment, and patriotic gratification."* (pgs. 211-212)

I mention that not to needlessly digress, but only to point out the universality of the principle that the article being responded to, has outlined just one instance of.

Recognizing this innate psychological trait of mankind (one presumes) is why the author of the Qur'an, which Muslims of course believe is the Creator (while others believe was a lunatic), makes an extraordinary pronouncement on this very topic in Surah Al-Maeda:

"It was We who revealed the Torah (to Moses); therein was guidance and light. By its standard have been judged the Jews, by the Prophet who bowed (as in Islam) to Allah's will, by the Rabbis and the Doctors of Law: for to them was entrusted the protection of Allah's Book, and they were witnesses thereto: therefore fear not men, but fear Me, and sell not My Signs for a miserable price. If any do fail to judge by (the light of) what Allah hath revealed, they are (no better than) Unbelievers. (44)

We ordained therein for them: "Life for life, eye for eye, nose for nose, ear for ear, tooth for tooth, and wounds equal for equal." But if anyone remits the retaliation by way of charity, it is an act of atonement for himself. And if any fail to judge by (the light of) what Allah hath revealed, they are (no better than) wrong-doers. (45)

And in their footsteps We sent Jesus the son of Mary, confirming the law that had come before him: We sent him the Gospel: therein was guidance and light, and confirmation of the law that had come before him: a guidance and an admonition to those who fear Allah. (46)

Let the people of the Gospel Judge by what Allah hath revealed therein. If any do fail to judge by (the light of) what Allah hath revealed, they are (no better than) those who rebel. (47)

To thee We sent the Scripture in truth, confirming the scripture that came before it, and guarding it in safety; so judge between them by what Allah hath revealed, and follow not their vain desires, diverging from the Truth that hath come to thee.

To each among you have We prescribed a Law and an Open Way. If Allah had so willed, He would have made you a single people, but (His plan is) to test you in what He hath given you: so strive as in a race in all virtues. The goal of you all is to Allah; it is He that will show you the truth of the matters in which ye dispute. (48)” (Holy Qur’an, Surah Al-Maeda 5:44-48)

And to ensure that the point is not lost here, permit me to highlight the solution-space outlined in the above passage by none other than the presumed Almighty Creator of mankind: **“To each among you have We prescribed a Law and an Open Way. If Allah had so willed, He would have made you a single people, but (His plan is) to test you in what He hath given you: so strive as in a race in all virtues. The goal of you all is to Allah; it is He that will show you the truth of the matters in which ye dispute.”**

The Author of the Qur'an is in fact rather emphatic about “*matters in which ye dispute*”:

“And in whatever thing you differ, its decision is unto God” (Holy Qur’an, Surah Ash-Shura 42:10, Arabic: وَمَا اٰخْتَلَفْتُمْ فِيْهِ مِنْ شَيْءٍ فَحُكْمُهُۥٓ اِلَيْهِ اَللّٰهُ )

If one were to endeavor to judiciously extract the core principle from that multicultural pronouncement, noting that the Author of the Holy Qur'an affirms that It did not deny Its Message or Its Messengers to any among mankind (even though only a very few are explicitly mentioned in the Holy Qur'an such as in Surah Al-Maeda 5:44-48 above):

“And verily We have raised in every nation a messenger, (proclaiming): Serve Allah and shun false gods”, (Holy Qur’an, Surah An-Nahl 16:36, Arabic: وَلَقَدْ بَعَثْنَا فِيْ كُلِّ اُمَّةٍ رَّسُوْلًا اَنْ اَعْبُدُوْا اللّٰهَ وَاجْتَنِبُوا الطَّاغُوْتَ ),

and that furthermore, the Author of the Holy Qur'an even requires anyone who accepts Its teachings to also accept all Its past Revelations to all peoples as an article of faith:

“And who believe in that which has been revealed to you and that which was revealed before you and they are sure of the hereafter.” (Holy Qur’an, Surah Al-Baqara 2:4, Arabic: وَالَّذِيْنَ يُؤْمِنُوْنَ بِمَا اُنزِلَ اِلَيْكَ وَمَا اُنزِلَ مِنْ قَبْلِكَ وَبِالْآخِرَةِ هُمْ يُوقِنُوْنَ ),

one discovers a governing principle that is universally applicable to all of mankind, to all beliefs, and to no belief:

1) [to] mind one's own business for what one does not feel is one's own, as

in the case of what's outside one's own sphere of socialization; and

2) [to] compete with each other in virtuous conduct ( فَاسْتَبِقُوا الْخَيْرَاتِ )  
Surah Al-Maeda 5:48) among each other with what one does feel is one's  
own.

In my humble view, this is outstanding guidance to a fractious mankind who are naturally psychologically prone to tribalism, ethnocentrism, the modern version of it being nationalism. By the admission of the author of the above verse, it is by design that the Creator made mankind into separate peoples and nations and gave each localized affiliations: ***“If Allah had so willed, He would have made you a single people”*** ( أُمَّةً <sup>٥٤</sup> وَأَحَدَةً <sup>٥٥</sup> Surah Al-Maeda 5:48).

Of course, when one looks at evolutionary biology and sociology, that is the natural outcome of how mankind has developed in many different tribes and nations across the earth.

And the author of the Holy Qur'an provides the prescription taking empiricism of mankind's condition into account!

The obvious point to make here is that otherwise, the following Biblical Commandment from antiquity was, and still is, at least in my view, both complete and sufficient for governing the peaceable and virtuous conduct of mankind:

“Do unto Others as you have others do unto you.” (The Bible: Matthew 7:12,  
Luke 6:31; Old Testament Mosaic Law; Socrates; Confucius; Solon)

So, why does mankind need anything more than that one general statement? Indeed, one can easily surmise that all beneficial national constitutions, international and local laws, trade treaties, foreign policies, and inter and intra governing principles are logically derivable from just that one ancient first principle, for a fairly equitable co-existence of mutual benefit to mankind.

While this universal pithy wisdom is deemed Biblical, I have found evidence of its truism in other antiquity as cited above. For instance, Solon the Athenian law giver, according to Plutarch's Lives, when asked which city he thought was well-governed, said: *“That city where those who have not been injured take up the cause of one who has, and prosecute the case as earnestly as if the wrong had been done to themselves.”*

Even beyond divine religion, in the realm of logic and rational empiricism alone, the



following operations-research (OR) logical formulation due to Bertrand Russell, a man of considerable beliefs in no religion, is the most commonsensical recipe of governing peaceable human conduct. In my own succinct rendition, Bertrand Russell's formulation goes something like this (and I am putting it in single quotes to indicate that the formulation belongs to Russell but the words may not all be his):

'Maximize individual happiness while minimizing social conflict for optimizing the overall common-good.' (Bertrand Russell's prescription to do away with religion as the bearer of moral law, probably in 'Why I am not a Christian' and similar writings)

With just a little bit of reflection, one will see that Bertrand Russell captures the beneficial essence of many religions, including Islam, in at least so far as "haquq-al-ibad", i.e., the rights of man upon man, otherwise known as moral law, are concerned, quite admirably.

By just using rational empathetic logic which hinges on spreading virtue rather than glory, vice, hegemony, and conquest, one can come up with reasonably equitable methods of governing oneself in any age, and among any peoples.

However, the author of the Qur'an having commanded the path to virtue, is as meaningless as man coming up with it on his own logic, if man is unwilling or unable to implement it.

That choice, is entirely man's. The author of the Qur'an also asserts that such a choice is up to man and not a diktat:

"There is no compulsion in religion." (Holy Qur'an, Surah Al-Baqara, 2:256, Arabic: لَا إِكْرَاهَ فِي الدِّينِ ط )

The point being, at the risk of being repetitious, whatever the religion, whatever the people, and whatever the culture and geography, man naturally gravitates firstly towards one's own kith and kin, and secondly towards one's own socialization. It is all but a truism that just as one man's terrorist is another man's freedom fighter, one man's messiah is another man's lunatic.

And Islam, recognizing this natural tendency for partisanship, proffered the above quoted solution of Surah Al-Maeda 5:44-48, to those who believe in Islam, lest Muslims become senselessly imbued with empire and its 'la mission civilisatrice', and criminally come to carry the "white man's burden"! The commandment is very explicit. Even though, the universal principle of virtuous co-existence to be derived from it evidently require at least a modicum of reflection.

Indeed, this is such a momentous concept of acceptance of others in the religion Islam, that it is even formulaically repeated countless times each day by its adherents without any reflection whatsoever. For, if one even spent 10 minutes thinking about what many "pious" among Muslims likely repeat at least 17 times daily, if not more, one would easily see that very core-principle at work for oneself.

That repetitive formulation is Surah Fatiha of the Holy Qur'an, its very first Surah. It is recited countless times daily by Muslims as a prayer. Just look at it with some reflection rather than rehearsing it as a parrot and matters become transparent. And what does it say?

First let's see what it does not say:

- 1) there is no mention of the word "muslim" in it;
- 2) nor is there any mention of the noble name of the harbinger of the Qur'an, its Exemplar.

If one were not so imbued with one's own socialization since birth, one would surely ask the following question to oneself: why not?

If Islam is the last Testament, its Prophet the last Messenger, and the Holy Qur'an the last Word on the matter of Divine Guidance to mankind, why have the following riddle in its **the most essential** Surah:

"Show us the straight path," ( Arabic إِهْدِنَا الصِّرَاطَ الْمُسْتَقِيمَ )

"The path of those whom Thou hast favoured." (Arabic: صِرَاطَ الَّذِينَ أَنْعَمْتَ عَلَيْهِمْ ) Holy Qur'an, Surah Al-Fatiha 1:5-6

Why command the reciter of that Surah to beseech the Creator to show him or her the "straight path", a path that is not named or labeled or identified in any other way other than as the "straight path", a singular path, and only identified as the path of those whom (plural) have been bestowed "divine favors" (plural), or who have been divinely favored? But no names are mentioned for any further identification!

Why send the poor seeker of divine wisdom in search of solving what appears to be a complicated riddle?

How is he, or she, to know what those unknown "quantities" are?

Is the man of faith simply to be socialized into fixing those unknowns – like choosing a value for the variable “x” in an elementary school level algebraic expression – by his parents, grandparents, teachers, scholars, culture, civilization, by osmosis, diffusion, vicariously?

Given that the average intelligence of the masses in any nation is rather low, and the Author of the Holy Qur'an if it is indeed the Creator of man would certainly have known that, why then did the Author of the Holy Qur'an not straightforwardly just say for all and sundry Muslim to understand in its most oft recited Surah: follow the path laid out in the Holy Qur'an, follow the path of Muhammad, its last Messenger and Exemplar?

**How ironical that what the Surah calls a “straight path” is not identified straightforwardly!**

All Muslims feel they already know (by virtue of their socialization) that that's what is implied. But that's not what the Surah says at all. One is only interpreting it to mean that based on one's own socialization bias!

The answer to the riddle, as invariably in all Qur'anic riddle cases, the Holy Qur'an itself also provides.

The author of the Qur'an has repeatedly alluded to Its Word as the Book of Reflection which none shall approach, except with a *cleansed heart*.

So, not everyone can glean the wisdom of the Qur'an even though they may be reading or mouthing its words – how interesting!

And the solution to the riddle is hinted, inter alia, in the afore-quoted verses from Surah Al-Maeda 5:44-48. It is still obviously not the complete solution, but we are an inch closer to solving the riddle.

For one thing, we learn that the solution is multicultural, and is indeed very much socialization dependent.

Different peoples will naturally have different perspective on what is "divine favor", who those favored ones are, and are thus encouraged to seek out the path followed by those whom they naturally psychologically feel closer to – that is the basis for what appears to the riddle of Surah Fatiha, 1:5-6.

And Surah Al-Maeda 5:44-48 quoted above is an exemplary partial hint to solving that

riddle.

Wow! What an incredible Book!

Nevertheless, it is still a Book of reflection first and foremost, which none shall penetrate, except with a *cleansed heart*. The rest are naturally misled. The Author of the Holy Qur'an even asserts that only It Guides Whom It pleases and leads others astray. Is this just rhetorical tautology? The Western mind un-attuned to the language of the Qur'an often thinks so.

Here are some verses from the Holy Qur'an on the *cleansed heart* metaphor:

That this is indeed a Qur'an Most Honourable, 56:77	إِنَّهُ لَقُرْآنٌ كَرِيمٌ
In a Book well-guarded, 56:78	فِي كِتَابٍ مَكْنُونٍ
Which none shall touch but those who are clean (purified): 56:79	لَا يَمَسُّهُ إِلَّا الْمُطَهَّرُونَ
A Revelation from the Lord of the Worlds. 56:80	تَنْزِيلٌ مِّن رَّبِّ الْعَالَمِينَ
Is it such a Message that ye would hold in light esteem? 56:81, Surah Al-Waqia, 56:77-81	أَفَبِهَذَا الْحَدِيثِ أَنْتُمْ مُدْهِنُونَ
Those are they whose hearts, ears, and eyes Allah has sealed up, and they take no heed. Surah An-Nahl, 16:108	أُولَئِكَ الَّذِينَ طَبَعَ اللَّهُ عَلَى قُلُوبِهِمْ وَسَمْعِهِمْ وَأَبْصَارِهِمْ وَأُولَئِكَ هُمُ الْغَافِلُونَ
Allah hath sealed their hearing and their hearts, and on their eyes there is a covering. Theirs will be an awful doom. Surah Al-Baqara, 2:7	خَتَمَ اللَّهُ عَلَى قُلُوبِهِمْ وَعَلَى سَمْعِهِمْ وَعَلَى أَبْصَارِهِمْ غِشَاوَةً وَلَهُمْ عَذَابٌ عَظِيمٌ
In their hearts is a disease, and Allah increaseth their disease. A painful doom is theirs because they lie. Surah Al-Baqara, 2:10	فِي قُلُوبِهِمْ مَرَضٌ فَزَادَهُمُ اللَّهُ مَرَضًا وَلَهُمْ عَذَابٌ أَلِيمٌ بِمَا كَانُوا يَكْذِبُونَ
Do they not then reflect on the Quran? Nay, on the hearts there are locks. Surah Muhammad 47:24	أَفَلَا يَتَدَبَّرُونَ الْقُرْآنَ أَمْ عَلَى قُلُوبٍ أَقْفَالُهَا

Caption Verses from the Holy Qur'an on the *cleansed heart* metaphor.

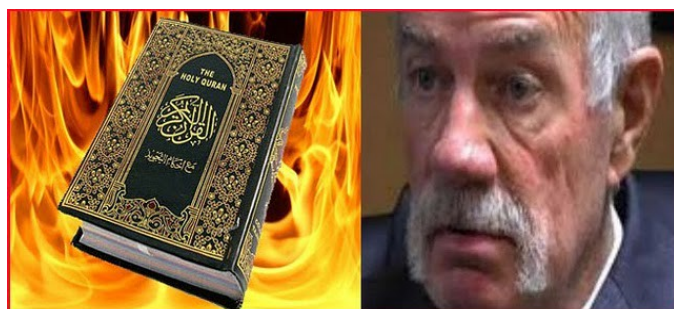

Pastor, Terry Jones

Caption Image Pastor Terry Jones burning the Holy Quran

The understanding of the message contained in the Holy Qur'an is only made accessible to those who try to approach its contents **not** with pre-conceptions and prejudices, or agendas bearing the diseases of the heart, or under behavior control as stooges and patsies, but with a genuine desire to learn what exactly is the Book

Saying! Only the purified ones, الْمُطَهَّرُونَ may approach its full understanding. The meaning of the Qur'anic word الْمُطَهَّرُونَ in the context of the Holy Qur'an is layered and nuanced.

The *cleansed hearted* learning is not just with the intellectual left-half brain, i.e., analytical, logical, reasoned, based on empirical knowledge. But also with the poetic right-half brain, i.e., with feelings, emotions, empathy, intuitions,, insights, inspiration, all of which may transcend the causality principle of intellectual empiricism. For a discussion of why these are independent human faculties and why both are necessary to human wisdom and spiritual learning, see the essay<sup>[2]</sup> Morality derived from the Intellect leads to Enslavement!. The report<sup>[3]</sup> Islam: Why is the Holy Qur'an so easy to hijack? Part-II further dwells upon this bifurcation of left and right half brain and what the *language of the intellect* (verses like 67:3-4 see discussion below), and the *language of the heart* (verses like those quoted above), respectively speak to in the context of the overarching spiritual teachings of the Holy Qur'an (such as in verse 20:114 discussed below). One without the other is at best one-eyed! More often, usually blind. This is why the Holy Qur'an refers to this spiritual condition in similitudes like: **“on the hearts there are locks”** and **“Allah hath sealed their hearing and their hearts, and on their eyes there is a covering.”**

This is also a common topic of exposition by genuine scholars of Islam but it has been relegated to dusty old books in local languages which few ordinary people read. The advent of the internet has made at least some of these works accessible to anyone today and there is hardly any excuse for the lack of commonsense on how to sensibly study the Holy Qur'an.<sup>[4]</sup>

That's the *cleansed heart* metaphor – inter alia, a genuine desire to learn using all human

faculties at our disposal. Whereas anyone may pick up a copy of the Qur'an, read it, torch it, defecate on it, shoot at it, and of course, even recite it in in the most surreal and melodious of incantations that is prized by all Muslims worldwide. The *cleansed heart* is an empirical demand not just of the Author of the Holy Qur'an to those who seek its teaching, but also of rational commonsense.

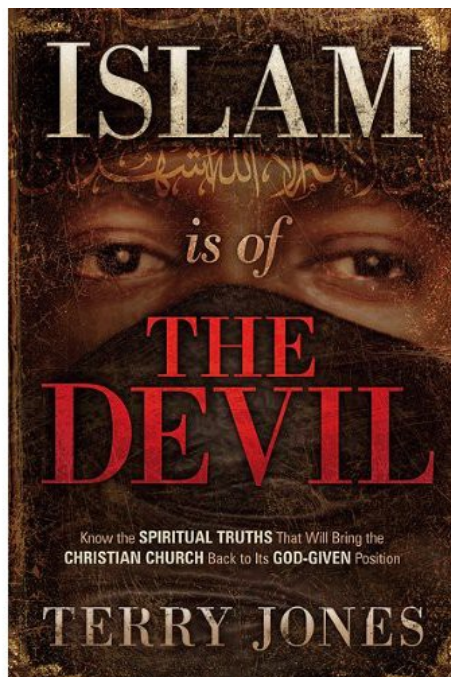

Caption Image bookcover of Pastor Terry Jones maligning Islam

Don't bring perceptual, ingrained, residual, or prejudicial biases to reading any book or else you won't comprehend the complete message that was put in the book by its author. You'll only get what you want to hear, believe, or argue to serve your own narrow interests! That's how fine literature is supposed to be read, argued, and enjoyed – using one's own interpretation and imagination. A fine book of poetry or allegorical fiction can reasonably mean different things to different people – and they can argue about it all day if they like without loss of

sensibilities.

But try doing that to a city's handbook of traffic laws, or the tax laws. One has to precisely understand what the authors of the traffic regulations – the Department of Motor Vehicles (DMV) – mean in the full letter, the full intent, and the full spirit of the regulations if one wants to pass that pesky written test to get one's driver license. More importantly, in order to be a safe driver which only comes about by repeatedly putting into best practice what one has learnt in theory. The practice helps clarify the theory, and the theory helps refine the practice.

Indeed, the Holy Qur'an is like any other convoluted law book – one has to absorb it with concentration, contemplation, and with the clear motivation to exactly comprehend what its Author had in mind. And then to practice it to fathom what it really entails. The comprehension and practice of the Religion of Islam suddenly got a lot harder than the prostration stamped on the forehead! (See: Islam: Why is the Holy Qur'an so easy to

hijack? [Part-I](#), [Part-II](#))

Memorizing like a tape recorder has zero pertinence to understanding its message, let alone practicing it. Imagine daily reciting the DMV driver's handbook just for the pleasure of the sound of its words!

That is in effect what the Muslims have done with the Holy Qur'an – read the DMV handbook for the sheer pleasure of hearing the sounds and rhythm of its words and sentences! As useful as that might be to wean oneself from sleeping pills, can one pass the DMV test that way? ***“Is it such a Message that ye would hold in light esteem?”*** demands the Author of the Holy Qur'an, while simultaneously asserting ***“In a Book well-guarded, which none shall touch but those who are clean”!***

Clearly, the warning to Muslims (and non-Muslims alike) by the Author of the Holy Qur'an to not make a mockery of the ***“well-guarded Book”***, is very bold. The focus is veritably on its message as it commonsensically should be, and not on its mere recitation and ritual reverence: ***“Is it such a Message that ye would hold in light esteem?”*** Of course, as all Muslims will surely testify, there is a more profound affect upon the spirit on hearing or reciting the Holy Qur'an in its original Arabic than doing the same to the DMV driver's handbook in any language.

The Holy Qur'an, first and foremost, is an aural recitation, not a written word. The authenticity and correctness of the written copy of the Qur'an, as Muslims are aware, is testified by a *hafiz* of the Qur'an, one who has memorized it in its exactness, like a tape recorder, and the memorization has itself been authenticated by his teacher – successively going back to the time of the Prophet of Islam when the Prophet himself approved the full recitation as it exists today. (For a [history](#) of its written compilation see: *Some Old Manuscripts of the Holy Qur'an*<sup>[5]</sup>) As divisive as Muslims are, and in as many sects as we are divided in, and in as many languages we speak on all five continents that we live, one thing we agree upon is the text of the Qur'an – that it remains unchanged. There is nothing which unites us more than the text of the Holy Qur'an. This is why there is so much emphasis among Muslims of all nations and cultures to learn the memorization of the Qur'an as a utilitarian virtue. It protects the Holy Qur'an from tampering by those who own the printing presses. And it protected the Holy Qur'an in antiquity from malicious scribes working for kings, and from copying errors.

There is also something undeniable about the uncanny calmness which comes over one when reciting a Surah from the Holy Qur'an as an act of worship. Such calmness does indeed benefit us temporally – in the here and the now. Our psychiatric bills are almost

negligible (unless we are physically being bombed to bits on a daily basis) and Prozac sales never took off among the Muslim nations as it did in the West.

Nevertheless, commonsense tells us that something has terribly gone wrong here.

### **We have kept the shell and thrown away its fruit!**

The Muslims have come to believe, or been led to believe, collectively, that making the Arabic offering of the Qur'an to Allah with its attendant rituals will take one to *Heaven!*

More recitation offerings to Allah will bring more *Heaven* in the *Hereafter* by compensating for our failings in the here, of both commissions and omissions.

Personal elevation of the spirit notwithstanding – the Shaman priest too derives much elevation of the soul in reciting his mantras as does the Hindu swami reciting the Vedas – often times the words being recited are in a foreign tongue (Arabic) which the vast majority of Muslims on earth don't even speak or understand!

Of the 1.6 Billion Muslims, just about 10% are native speakers of Arabic. A few others speak it as a second language.

But most Muslims mouth the words of the Holy Qur'an formulaically in its original Arabic, or in its transliteration into their local language script, for some vague notion of reaping rewards in the *Hereafter*.

Acts of courage, valor, dignity, self-respect, standing up for what's right, standing up to oppression, tyranny, breaking the bonds of servitude, have all been replaced by joyous recitations.

Muslims do such pious recitations every opportunity we get, which is mostly on deaths and death-anniversaries of loved ones. We solemnly bring down the Qur'an from the topmost shelf of our choicest closet or bookcase, often kept wrapped in many layers of fine silk to preserve its dignity from dust and spiders, and gather around with friends and family to “finish” mouthing the Qur'an a maximum number of times as blessings and reward for the dear departed. More often than not, because of our busy lives, unable to gather sufficient number of people to mouth the Qur'an, we farm off the task to the nearest mosque and get children studying there to come-over and do so in proxy services in lieu of some food and generous gratuity to the mullah. More money we spend in such efforts, more we feel our prayers have traveled farther into *purgatory* relieving the burden of accountability on our loved ones!



As per the concept of *sadqa-jariya*, it is believed by many Muslims that such Qur'anic recitations and prayers of good-will help those who are no longer in this world when their loved ones miss them and pray for mercy for their souls (as opposed to forget them or curse them). Let's just accept, to avoid any red herring contentions, that it helps the damned to be less damned in purgatory if they leave a good legacy of love and charitable works behind. For those rare virtuous people not damned, perhaps the prayers of the living helps them gain greater *Heaven*. *Sadqa-Jariya* is a unique concept in Islam which helps foster love, brotherhood, and charitable works that keep on accruing benefit to one even after one has left this abode, so long as the good-will left behind keeps bearing fruit for those still living.

But does such ceremonial mouthing of the Holy Qur'an help us while we are still living?

And during Ramadan of course, we again rush to "finish" mouthing all its 114 chapters divided into 30 sections, in just under 27 days as the fast-path to *Heaven*. If we overshoot by one day, we are in panic mode to finish the remaining sections quickly before the night of moon-sighting for the next day's *Eid* festivities.

**When do Muslims actually study the Holy Qur'an to comprehend its message for the here and the now, as one would study the DMV handbook? Or more aptly, as one studies to learn one's profession and trade?**

How much more facile than that can anyone get?

Returning back the topic of the remarkable pluralism of Surah Al-Fatiha and Surah Al-Maeda, what does the Author of the Qur'an say about its many prophets and messengers? Well, read the Good Book to find out.

But does the Author of the Qur'an forbid reading other people's books?

No!

I have not found any occasion when such a travesty has been advocated.

Does the Author of the Qur'an forbid speaking to the people of other nations?

No!

I have not found any occasion when such a travesty has been advocated.

To the contrary, the author of the Qur'an emphatically states the following:

“O mankind! Lo! We have created you from male and female, and have made you nations and tribes that ye may know one another. Lo! the noblest of you, in the sight of Allah, is the best in conduct. Lo! Allah is Knower, Aware.” (Holy Qur’an, Surah Al-Hujraat, 49:13, Arabic: يَا أَيُّهَا النَّاسُ إِنَّا خَلَقْنَاكُمْ مِنْ ذَكَرٍ وَأُنْثَىٰ وَجَعَلْنَاكُمْ شُعُوبًا وَقَبَائِلَ لِتَعَارَفُوا ۗ إِنَّ أَكْرَمَكُمْ عِنْدَ اللَّهِ أَتْقَاكُمْ ۗ إِنَّ اللَّهَ عَلِيمٌ خَبِيرٌ )

And how can **“ye may know one another”** ( لِتَعَارَفُوا ) unless ye talk to each other, partake of each others joys and sorrows?

The straight forward logic of this verse demonstrates that the author of the Qur’an made the religion of Islam both non-isolationist, and non-triumphalist to the core!

Does the Author of the Qur’an forbid Muslims imbibing themselves of knowledge and wisdom from any source?

No!

I have also not found any occasion when such a travesty has been advocated.

Quite the opposite in fact. The Author of the Qur’an commands Its own last Messenger to pray to his Creator to increase his own "ilm" as a virtue:

“and say: My Lord! Increase me in knowledge.” (Holy Qur’an, Surah Ta-Ha, 20:114 , Arabic: وَقُلْ رَبِّ زِدْنِي عِلْمًا )

And therefore, since the Author's last Messenger is also the Exemplar for his followers, the commandment is to the Exemplar's followers as well, i.e., to the Muslims, to do the same: **“and say: My Lord! Increase me in knowledge.”** This pithy prayer is recited by many Muslims in their daily prayers. Unfortunately, this increase evidently hasn't come to pass for a vast majority of us.

What's more, the author of the Qur’an even advocates pursuing boundless “ilm” thusly:

“Thou seest not, in the Creation of the All-Merciful any imperfections. Return thy gaze, seest thou any fissure, Then return thy gaze, again and again. Thy gaze comes back to thee dazzled, aweary.” (Holy Qur’an, Surah Al-Mulk, 67:3-4, Arabic: مَا تَرَىٰ فِي خَلْقِ الرَّحْمَنِ مِنْ تَفَاوُتٍ ۗ فَارْجِعِ الْبَصَرَ هَلْ تَرَىٰ مِنْ فُطُورٍ ۚ ثُمَّ ارْجِعِ الْبَصَرَ كَرَّتَيْنِ يَنْقَلِبْ إِلَيْكَ الْبَصَرُ حَاسِنًا ۗ وَهُوَ حَسِيرٌ )

The profound significance of these pithy verses of Surah Mulk to knowledge, to “ilm” acquisition can perhaps also be judged from the fact that Muslim physicist Dr. Abdus Salam rehearsed it in Stockholm upon accepting The Nobel Prize in Physics 1979, boldly stating<sup>[6]</sup> at the Nobel Banquet on December 10, 1979, before other Nobel laureates, scientists and dignitaries, the Nobel Foundation and the Royal Academy of Sciences, that: ***“This in effect is, the faith of all physicists; the deeper we seek, the more is our wonder excited, the more is the dazzlement for our gaze.”***

But does the author the Qur'an advocate such pursuits, singlemindedly, to the exclusion of all else, such that such pursuits become the self-serving pursuit of the 'American Dream'?

Or, is such an advocacy for the pursuit of “ilm” as a noble endeavor, made an essential component of a greater all encompassing moral imperative by the author of the Qur'an? A categorical imperative which devolves upon man an even greater system of personal and social responsibility for which the wholehearted pursuit of “ilm” is necessary, but not sufficient?

The answer is obvious, despite the question not being merely rhetorical.

It is plainly given by the author of the Qur'an in the pithy Surah Asr, in the verse fragment:

“and those who strive for haq” (Holy Qur'an, Surah Asr, 103:3, **وَتَوَّاصُوا**  
( **يَا الْحَقِّ** )

The Arabic word “haq” **حَقِّ** (pronounced 'huq' like 'hug' and not like 'faq') is an all encompassing word and its single-word translation into English is impossible. It means all of the following (and then some): truth, Truth, justice, rights, rectifying injustice, not violating rights, not being unjust, demanding one's own rights, not permitting others to violate one's own rights, etceteras.

It is but simple logic and commonsense to deduce that the pursuit of accurate knowledge in all matters is an essential prerequisite to the pursuit of “haq” in all matters – lest one be deceived, be manipulated, end up believing in falsehoods, and act unjustly.

The aforementioned tiny but self-sufficient verse fragment of the Qur'an forms the foundational basis for what is called “jihad”, striving as a moral imperative, in other verses of the Qur'an:

“And strive they with their wealth and their lives in the way of God; they are the truthful ones.” (Holy Qur'an, Surah Al-Hujraat 49:15, Arabic: **وَجَاهِدُوا**)

( بِأَمْوَالِهِمْ وَأَنْفُسِهِمْ فِي سَبِيلِ اللَّهِ )

But what should they “strive” ( وَجَاهِدُوا ) for, inter alia, with their wealth and their lives, without any expectations in return from their fellow man, to be so nobly designated as the “truthful ones” ( الصَّادِقُونَ ) by none other than the one who claims to be their Creator?

The Qur'anic answer, once again unequivocally provided by the author of the Qur'an in the Qur'an itself, is in Surah Asr.

It is to principally strive for “haq” ( وَتَوَاصَوْا بِالْحَقِّ ) with all of one's wealth, resources, talents, and energies! The lack of striving of which, the author of the Qur'an emphatically re-asserts in the same Surah Asr, leads to:

“Lo! man is in a state of loss” (Holy Qur'an, Surah Asr 103:2, إِنَّ الْإِنْسَانَ لَفِي خُسْرٍ )

For completeness, reproduced below is the full recipe of the pithy Surah Asr for a noble life which is “not in a state of loss”, one which is not perpetually full of facile views, ignorance, apathy, vile servitude to the harbingers of inequity and injustices, and wild revolutions and further injustices in the name of redressing injustices. Notice what's stated and what's omitted in this self-sufficient tiny Surah. There is no reference to Muslims, or to Islam, or to any particular people or religion. It is directly addressed to man ( الْإِنْسَانَ ), “insaan”, to every people of all religions, and to people of no religion, the overarching context for which has already been elucidated above:

By the declining day, (1)	وَالْعَصْرِ
Lo! man is in a state of loss (2)	إِنَّ الْإِنْسَانَ لَفِي خُسْرٍ
Save those who believe,	إِلَّا الَّذِينَ آمَنُوا
and do good works,	وَعَمِلُوا الصَّالِحَاتِ
and strive for “haq”,	وَتَوَاصَوْا بِالْحَقِّ
and are patient (3)	وَتَوَاصَوْا بِالصَّبْرِ

Caption Surah Al-Asr, Chapter 103 of the Holy Qur'an (see [exposition](#)<sup>[7]</sup>)

The aforementioned few words of the author of the Holy Qur'an, as straightforward as they appear to be, still do require plenty of reflection and context to grasp the full import of its message towards an equitable and mutually beneficial multicultural co-existence without

the imposition of anyone's values and/or "facile views" upon another.

It is important to re-emphasize for the first of the four clauses of verse 3 of Surah Asr quoted above, even at the risk of being repetitious once gain, that on theological matters of belief, including no belief, when one disagrees with another, the dispute is not up to man to decide. It is for some abstract entity called "God" to decide, as already quoted from the author of the Qur'an in the preceding discussion. It is not the business of man what another's beliefs are. That business is God's, and is defined as being among the Rights of God upon man, the "haquq-Allah". No mortal may interfere in that Right even if, due to their own natural socialization and/or self-ascribed learnedness, they perceive that some Right of God is being violated by others holding a facile view. This clear demarcation of respective Rights in Islam between the Rights of God (beliefs) and the Rights of man (moral law), ends for all times, at least from Islam's point of view, all arguments of the type: whose conception of god is better; is there a god or isn't there; etc.

Everyone gets to believe in whatever theology they want! The author of the Holy Qur'an in defining the religion of Islam, already took the inherent differences in beliefs and perception biases due to the very nature of socialization of man into account! Thus, apart from friendly discourse, any forceful disputation with another on the nature of their personal beliefs is transgressing the limits set by the author of the Qur'an for Islam's practitioners:

"And if your Lord had pleased, surely all those who are in the earth would have believed, all of them; will you then force men till they become believers?" (Holy Qur'an, Surah Yunus 10:99, Arabic: **وَلَوْ شَاءَ رَبُّكَ لَأَمَنَّ** **مَنْ فِي الْأَرْضِ كُلَّهُمْ جَمِيعًا أَفَأَنْتَ تُكْرِهُ النَّاسَ حَتَّىٰ يَكُونُوا مُؤْمِنِينَ** )

Wonderful.

This leaves man, as per the other three clauses of Surah Asr verse 3, in his short gift of life, to not worry about saving another's soul, but to primarily contend with his own conduct with his fellow man, the previously mentioned "haquq-al-ibad".

The commonsense advocacy of that method of conduct, of doing good to fellow man, of striving for "haq" in removing injustices from oneself and from fellow man, and being patient in adversity rather than committing suicide or becoming a suicide bomber, is beneficial guidance to all mankind no differently than the Biblical commandment: "*do unto others has you have others do unto you*", and Bertrand Russell's non-religious formulation: '*Maximize individual happiness while minimizing social conflict for optimizing the overall common-good*', are beneficial for all mankind.

Take from whichever system of thought that resonates with one; but don't be iniquitous to oneself or to another; and the only practicable method to achieve that enlightened state of affairs regardless of the belief system is the pursuit of "ilm" – is the prima facie core message of the author of the Qur'an.

If only man were to take heed of any of this platitudinous stuff from any of the Books of wisdom, and implement that which is his preferred choice due to socialization, in his respective tribe and nation.

That singular failure to implement moral platitudes, from time immemorial, is the one fundamental problem of failure to strive in "haq"!

It is because of this empirical fact that the author of the Qur'an, in what it claims to be its last Testament to mankind, has laid such strong emphasis on striving for "haq" – even making it the underpinning of a life which is at a loss in its absence ( *إِنَّ الْإِنْسَانَ لَفِي خُسْرٍ* ). Otherwise, the Biblical "*do unto others as you have others do unto you*" is still sufficient general principle. However, while the latter was merely advisory, striving for "haq" has been made compulsory!

And what has man, "insaan", done about such striving?

Nothing.

Caught between facile world views on the one hand, and bread and circuses on the other, man continues to be manipulated into voluntary servitude to tyrants of modernity just as he was in antiquity. While one may arguably understand the servitude in the Dark Ages to the tyrants of antiquity, in the modern information age, the Technetronic Era (term coined by Zbigniew Brzezinski), for the disease of the Dark Ages to persist is indicative of something far deeper which has not changed despite the march of civilizations, liberations, exponential increases in public knowledge, and the Technetronic progress.

Those who pursue "ilm", knowledge, don't necessarily do so to strive for "haq", or to redress the human condition, but for their own narrow self-interests to achieve their own version of the 'American Dream'. As the knowledge bearers, they are often either the direct harbingers of, or the silent bystanders to, the untold crimes against humanity. In the Technetronic Era of today, the former are the scientists, engineers, and technicians of empire laboring under facile delusions of all kind.

Tyranny of course only flourishes when many good men, and many good women, learned and pious, too busy pursuing their 'American Dreams', stay silent, indifferent.

That is just too well-worn a statement to be anything but one of the best moral clichés of all time. Edmund Burke wasn't the first to think of it. All the sages throughout the ages have reflected upon it. And Solon, considered one of the seven greatest law givers of ancient Rome, even made coming to the aid of fellow man in distress, a legal obligation!

Apart from the copious evidence of blood-stained pages of recorded history, the obvious import of accurate knowledge to the pursuit of “haq” as its principled primemover, can also be contemporarily judged by the empirical fact that due to the Muslims having a rather facile view of their own religion throughout history, and remaining quite ignorant of its interplay with imperial matters in every epoch, “jihad” was once again vilely harvested for an imperial agenda in the modern epoch with nothing but snake oil.



This time around by Zbigniew Brzezinski for “*giving to the USSR its Vietnam War*” in Afghanistan 1979-1988 by creating the “Mujahideens”. It is worth reproducing here Zbigniew Brzezinski's 1998 interview to French magazine *Le Nouvel Observateur* for his own confessions of the utility of promulgating facile world views to accomplish this:

**'Question:** The former director of the CIA, Robert Gates, stated in his memoirs [“From the Shadows”], that American intelligence services began to aid the Mujahadeen in Afghanistan 6 months before the Soviet intervention. In this period you were the national security adviser to President Carter. You therefore played a role in this affair. Is that correct?

**Brzezinski:** Yes. According to the official version of history, CIA aid to the Mujahadeen began during 1980, that is to say, after the Soviet army invaded Afghanistan, 24 Dec 1979. But the reality, secretly guarded until now, is completely otherwise. Indeed, it was July 3, 1979 that President Carter signed the first directive for secret aid to the opponents of the pro-Soviet regime in Kabul. And that very day, I wrote a note to the president in which I explained to him that in my opinion this aid was going to induce a Soviet military intervention.

**Question:** Despite this risk, you were an advocate of this covert action. But perhaps you yourself desired this Soviet entry into war and looked to provoke it?

**Brzezinski:** It isn't quite that. We didn't push the Russians to intervene, but we knowingly increased the probability that they would.

**Question:** When the Soviets justified their intervention by asserting that they intended to fight against a secret involvement of the United States in Afghanistan, people didn't believe them. However, there was a basis of truth. You don't regret anything today?

**Brzezinski:** Regret what? That secret operation was an excellent idea. It had the effect of drawing the Russians into the Afghan trap and you want me to regret it? The day that the Soviets officially crossed the border, I wrote to President Carter. We now have the opportunity of giving to the USSR its Vietnam war. Indeed, for almost 10 years, Moscow had to carry on a war unsupportable by the government, a conflict that brought about the demoralization and finally the breakup of the Soviet empire.

**Question:** And neither do you regret having supported the Islamic fundamentalism, having given arms and advice to future terrorists?

**Brzezinski:** What is most important to the history of the world? The Taliban or the collapse of the Soviet empire? Some stirred-up Moslems or the liberation of Central Europe and the end of the cold war?

**Question:** Some stirred-up Moslems? But it has been said and repeated Islamic fundamentalism represents a world menace today.

**Brzezinski:** Nonsense! It is said that the West had a global policy in regard to Islam. That is stupid. There isn't a global Islam. Look at Islam in a rational manner and without demagoguery or emotion. It is the leading religion of the world with 1.5 billion followers. But what is there in common among Saudi Arabian fundamentalism, moderate Morocco, Pakistan militarism, Egyptian pro-Western or Central Asian secularism? Nothing more than what unites the Christian countries.' (source [Global Research](#)<sup>[8]</sup>)

It is also worth reproducing here how Brzezinski fashioned these “*Some stirred-up Moslems*”:

**News voice over 1980:** “*US National Security Advisor Brzezinski flew to Pakistan to set about rallying resistance. He wanted to arm the Mujahideen without revealing America's role. On the Afghan border near the Khayber*



*Pass, he urged the Soldiers of God to redouble their efforts”*

**Brzezinski 1980:** *“We know of their deep belief in God, and we are confident that their struggle will succeed. That land over there, is yours, you'll go back to it one day, because your fight will prevail, and you'll have your homes and your mosques back again; because your cause is right; **God is on your side.**”* [enthusiastic clapping by the future 'Mujahideens']

**Brzezinski in the studio speaking to the interviewer:** *“The purpose of coordinating with the Pakistanis will be to make the Soviets bleed, for as much, as long, as possible.”* (transcription is mine from the documentary [video clip<sup>\[9\]</sup>](#))

The mass ignorance and the facile world views that lay behind **“their deep belief in god”** among the Muslims was devilishly harvested with **“god is on your side”** to leave the Muslim civilization of Afghanistan into dust, and to set the stage for the future disintegration of Pakistan, with nothing but **“Some stirred-up Moslems”!**

It is the same fundamental lack of wherewithal today among the Muslims which is also enabling the same grandmasters to wage the perpetual 'Global War on Terror' upon the world as the age-old pretext for **“imperial mobilization”** on *The Grand Chessboard*. (See [Hijacking the word 'Islam' for Mantra Creation](#))

In both endeavors, Muslim rulers and their intelligence apparatuses played, and are still playing, prostitutes to empire against the common-good of their own public.

Evidently, all empires, past and present, from antiquity to modernity, are built upon promoting facile views of certain truths among their public, and among their prostitutes.

St. Augustine had rightly summed it millennia ago:

*“When the King asked him what he meant by infesting the sea, the pirate defiantly replied: ‘the same as you do when you infest the whole world; but because I do it with a little ship I am called a robber, and because you do it with a great fleet, you are an emperor.’”* (*The City of God against the Pagans*, pg. 148).

It is not surprising then, that the One who claims to be the Creator of man, the author of the Qur'an, correctly gauged the natural psychology of the masses among mankind and how they will be manipulated by the devil's apprentices, and for which it universally advocated

the pursuit of “ilm” and “haq” for every “insaan” in a lifelong striving it termed “jihad” as the only effective counter to facile world views from which all evil follows.

It is therefore also not surprising then, that the superlative devil's apprentices too, from time immemorial, also recognized that encouraging facile views among the masses was essential in order to rule them!

Thus was created the narrow specializations and superficial generalization of education systems since the dawn of the Industrial Age, to craft the “*likkha parrha jahils*” of modernity, meaning, literate morons with pieces of paper proclaiming their august qualifications. It wasn't just by the happenstance of rapid knowledge expansion of the *Technetronic Era*, as Zbigniew Brzezinski speciously implied in his 1970 book *Between Two Ages*, that the following has transpired:

'... it can be argued that in some respects "understanding" ... is today much more difficult for most people to attain. ... It is simply impossible for the average citizen and even for men of intellect to assimilate and meaningfully organize the flow of knowledge for themselves. In every scientific field complaints are mounting that the torrential outpouring of published reports, scientific papers, and scholarly articles and the proliferation of professional journals make it impossible for individuals to avoid becoming either narrow-gauged specialists or superficial generalists. The sharing of new common perspectives thus becomes more difficult as knowledge expands; in addition, traditional perspectives such as those provided by primitive myths or, more recently, by certain historically conditioned ideologies can no longer be sustained.' (Zbigniew Brzezinski, *Between Two Ages*, 1970, pg. 15)

Let me highlight the two key empirical observations from that aforementioned passage: **“make it impossible for individuals to avoid becoming either narrow-gauged specialists or superficial generalists. The sharing of new common perspectives thus becomes more difficult as knowledge expands;”**. The self-serving cyclic argument of Brzezinski is that firstly, ignorance about knowledge, due to the sheer explosion in knowledge, is the natural outcome of scientific modernity. Secondly, that people can no longer easily reach a common “understanding” of their common condition. Both those observations are empirically true today. But one can easily imagine an alternate modernity where that need not be the case despite the abundance of knowledge explosion. It was the corporatization of knowledge in the service of empire in the vast military-industrial-academe complexes of the industrialized world, and its tight coupling to the exercise of hegemony, that has made it so. Science and technology today equate with hegemony. Therefore, since

the quest for hegemony is perpetual, those pursuing science and technology have to continue slaving in the service of empire as “*narrow-gauged specialists*.” It is a self-serving, self-sustaining game of flourishing ignorance. And it isn't just incidental to knowledge explosion as Brzezinski has tried to portray it. It is in fact according to a premeditated plan, deftly put into motion at the very onset of Western industrialization, for the crafting of “***a large number of men who are content to labor hard all day long.***”

Here is Bernard de Mandeville in the eighteenth century, cleverly planting the very seeds of modern self-serving ignorance of the people for a production-consumption economy wherein, human masses are deemed only useful as economic widgets for the economic well-being of a nation:

'The economic well-being of the nation depends on the presence of a large number of men who are content to labor hard all day long. Because men are naturally lazy they will not work unless forced by necessity to do so.'  
(Bernard de Mandeville, *The Fable of the Bees*, 1705)

This man-made value system of human beings as economic widgets “*content to labor hard all day long*”, has today spread like a virus across the full gamut of gainful employment in the globalized corporate world, from blue collar to white collar, from traders to craftsman, from superficial generalists to narrow-gauged specialists.

That philosophy, to create “*a large number of men who are content to labor hard all day long ... forced by necessity*” espoused in *The Fable of the Bees*, inspired Adam Smith, the author of *Wealth of Nations*, to propose the pursuit of selfish industriousness for the overall common good. Of course, common good primarily of the ruling class with trickle-down economics, but that's just buried in the definition of common good where the common man labors hard all day long, and the elites enjoy the good. Patterned upon the bees collectively making that marvellous tasting honey, each bee narrowly staying busy in its own specialized micro-task, while the queen bee rests and enjoys all the benefits, lies the entire edifice of modern civilization. It hinges entirely upon what Bernard de Mandeville stated 300 years ago. At the risk of being repetitious, it needs to be emphasized once again: “***The economic well-being of the nation depends on the presence of a large number of men who are content to labor hard all day long ... forced by necessity.***”

This 300 years old philosophy of inculcating selfish, myopic, narrow-gauged industriousness for the common good has been easily adapted to the high-tech *Technetronic Era* of modernity which naturally requires highly specialized, passionate, skilled, ultra-hard working bees “*content to labor hard all day long*” due to their natural

fascination with the subject. It goes hand in glove with creating specialized narrow-gauged morons with advanced university degrees who can very patriotically “United We Stand” for the common good while staying productively engaged in narrow specializations in the economy.

Kept perpetually too busy to either think independently from the herd even when capable of doing so, or to pursue knowledge outside of their narrow-gauged spheres of specializations by the sheer demands of time and the endless debt-bills in pursuit of their endless “American Dreams”, statecraft today relies on inflicting exactly *The Fable of the Bees* upon man for its own functioning as an empire. In this scheme of things, vast amounts of useless information has been recast as knowledge, and parrots have been turned into learned savants. While wisdom and commonsense have been driven out from the acumen of men and women “*content to labor hard all day long ... forced by necessity.*”

That pursuit, by its very nature, promotes holding only facile world views among the dreamers of the 'American Dream'. The more one is invested in one's American Dream, the more averse one automatically becomes to losing that dream if one wakes up to “ilm”. Natural psychological forces do the rest, by automatically bringing to the cognitive surface incessant rationalizations and self-delusions to maintain status quo in order to suppress the discomfort of cognitive dissonance. (See Leon Festinger's study of mental gymnastics for harmonizing dissonance.) The end result is that one prefers to maintain only a nodding acquaintance with “ilm”, remaining mostly content with what's salutarly written on that piece of decorative parchment necessary for becoming an economic widget. The devil's apprentices building their palatial heavens right here on this earth, have further ensured that the very nature of participating in modernity also only permits the hardworking bees just sufficient time and inclination for either very superficially-broad, or very narrow-gauged specialized acquaintance with “ilm”.

We have already seen above that without “ilm”, striving for “haq” is impossible. Thus, between self-deception, deception by Machiavelli, and full time engagement in bread and circuses, one automatically becomes a captive audience to one's ignorance in all important matters which occupy the elites enjoying all that common good from the work of those “*content to labor hard all day long.*” This diabolically induced state of ignorance makes one easy putty in the rulers' cold calculating hands. The cumulative impact of this to society is exactly as presaged by Brzezinski in *Between Two Ages* – a must read ode to legitimizing the tyranny of the elite in the *Technetronic Era* (subtitle of the book). The era of global scientific dictatorship.

The proof of this is the empirical evidence that the most industrialized, most powerful, the

greatest and richest Republic on earth today whose economic foundation was laid by Adam Smith, trumped the foundation of liberty and separation from empire laid by its founding fathers with the prime directive that it was to be a Republic. It has silently descended into a police-state without a murmur of protest from either its super-educated or its rank and file. They both today stupidly stand together in line to have their body cavities examined, groped, molested, humiliated, or irradiated with deadly radiation every time they travel by air. Soon, it will be every time they visit a shopping mall, governmental office, school, and perhaps even getting on and off highways to and fro from work. Mobile radiation scanners are already deployed in many cities which scan all passerbys, cars, trucks, for the so called "terrorists". The rulers meanwhile have their own private jets which take off and land on private runways and terminals bypassing the fate of the masses. No radiation scanners violate their physical being, and no perverts molest their women and children.

All this travesty only exists because the public is continually taught the facile view, or forced to acquiesce to the facile view at the threat of themselves being labeled "terrorist", that they are under mortal threat from the "terrorist". Referring back to Zbigniew Brzezinski's ode to hegemony quoted at the very beginning, the method of circumventing domestic impediments to the "**sustained exercise abroad of genuinely imperial power**" become empirically self-evident: "*Moreover, as America becomes an increasingly multicultural society, it may find it more difficult to fashion a consensus on foreign policy issues, except in the circumstance of a truly massive and widely perceived direct external threat. [Because] the pursuit of power is not a goal that commands popular passion, except in conditions of a sudden threat or challenge to the public's sense of domestic well-being.*" (pgs. 211, 44) Q.E.D.

As the aforementioned examination discloses, in this perpetual battle between good and evil, strong and weak, hegemony and victims, wolves and sheep, rulers and masses, evidently both sides have been well equipped. But unfortunately, it is only the one side which has continually figured out, from time immemorial, how to capitalize on its own core strengths and others' weaknesses. And it has artfully trapped the other in bread and circuses.

This was the craft of kings from antiquity who ruled in the name of the divine for their own private interests with "*all authority is an extension of god's authority*". And is now the craft of Machiavelli in modernity who showed the prince how to rule for private interests in the name of democracy with "*god is on your side*".

Indeed, it is only upon that singular characteristic that the following observation of Zbigniew Brzezinski in his own bible of hegemony, *The Grand Chessboard*, is so penetratingly

accurate even today: ***“Hegemony is as old as mankind.”*** (pg. 3)

The very foundation of hegemony and empire lie in the public holding largely facile views of truths essential to the rulers. It doesn't matter which view they hold, in fact, they can hold any view they want, so long as it is not the whole truth, and is anything but the truth.

Like every people, such facile views are also promoted by Christians themselves of their own religion upon their own masses – never mind others doing it for them – when it is convenient to the exercise of imperial power. There is virtually no exception to this empiricism throughout the pages of recorded history. It exists among every people, including Jews, Hindus, Muslims, Greeks, Romans, Egyptians, etc. Pick an empire and its people have been subjected to facile world views which have served the interests of empire.

And modernity is no exception.

Promulgating Zionism among the Jews, and Christian Zionism in the Bible Belt of America, readily come to mind.

The following is just one example. A facile sermon ostensibly from the Holy Bible, by a Christian preacher harkening back to the divine kings of antiquity to teach his own flock to ***“Honor the King. Do it anyway, whether the king deserves it or not”***:

“I am free to submit to authority. I am free to make myself a slave.

My friends, you are free, you are free to respect and appreciate the authority of the government that god gives to you - Honor the King!

The way you talk about your government, it's so easy to complain isn't it? It is so easy to criticize, it is so easy to find fault.

Honor the King. Do it anyway, whether the king deserves it or not.

All authority, all authority is an extension of god's authority!” (*New American Theology of Civil Submission*’, transcription is mine from a Youtube video of the sermon cited by [prisonplanet.com](http://prisonplanet.com)<sup>[10]</sup>, April 14, 2008)

What can be a more self-servingly facile view of Christianity than that Orwellian double-speak?

Any Muslim's facile views of Christianity surely pale in comparison!

As is amply evidenced above, anyone can promote facile views, and also be the victim of them. To remove facile views on any subject, including Christianity and Islam, it is commonsensical to go directly to its source. Approach the Good Book with a desire to understand what the Book actually says, whether or not one believes or accepts it – as when writing an A+ book report for a high school English honors class – and one shall know.

Worn out from holding facile views in the land of absurdities, Journalist and “accidental theologian”, Lesley Hazleton tried it. She sat down one day to read the Holy Qur'an as “*an agnostic Jew reading someone else's Holy Book*” – by her own description. And what she found -- as a non-Muslim, a self-identified “tourist” in the Islamic holy book -- wasn't what she had expected. It ended for her the tyranny of facile views on Islam and the Holy Qur'an. [Watch<sup>\[1\]</sup>](#).

## Conclusion

To finally bring this long riposte to a conclusion, the short article being keyed off here has posed a good specific question whose general answer has been explained to those Muslims who can understand the wisdom of the Qur'an. Ignorance, like being naked at birth, is the natural state of being. But we don't go prancing about as civilized adults in the *au natural* state of our body anymore than we should as civilized adults, of the *au natural* state of our mind!

Having facile views is natural, of others especially, but is not limited to the 'other'. One can be just as ignorant of what's one's own as illustrated above. And as an antidote to holding facile views, the full spectrum pursuit of knowledge as the precondition for the pursuit of a noble life – to be counted among the “truthful ones” – is rationally advocated by the author of the Qur'an as a categorical imperative for the civilized and harmonious co-existence of man.

That quest for harmonious co-existence at times requires measured and effective self-defence against predators, both physical and psychological. And the prescription for that striving against man's natural predators, the sociopaths and tyrants from among mankind itself, is captured by the universal striving for “haq”. Meaning, just as the natural state of creation is the jungle, but we don't live in one as a civilized people, the natural law of the jungle too is not the law of civilization. That law, the Qur'anic prescription of striving for “haq”, is the most well balanced and comprehensive prescription that exists in any book of wisdom from time immemorial. It prescribes how to be effective and pragmatic in standing

up to barbarians without ourselves becoming one. It offers the criterion for resolving the existential dilemma often faced by all peoples of conscience, whether to confront, or to be co-opted. To know what it is, one still needs to acquire its “ilm”, as with everything else. We no more naturally know it in our *au natural* state of ignorance and barbarianism than we are born with our clothes on.

Interestingly, it is also a commonsense wisdom. Acquire Knowledge – *'even if one has to journey to China'*, as the Prophet of Islam is reputed to have also stated to his followers in that *Age of Jahiliya* (ignorance).

The difficulty of physically journeying to China is of course considerably less today. However, we continue to suffer another *Age of Jahiliya* in our modernity today. One that is dominated by facile views and deception all around. The most pervasive of these facile views among Muslims today is their own self-deception to avoid taking on the responsibility for rectifying their own subjugated condition. It is that oft heard self-serving proclamation of the pious and the scoundrel alike: *“Allah chala raha hai”*. Meaning, “God is running the world”. Its natural corollary then easily follows: *“let Allah take care of his world while I take care of my camels.”*

The devil's apprentices who actually are running the world, from time immemorial, deliberately cultivate such servile dogmas and facile views among the foolish masses living in their *au natural* mental state. To await their favorite *savior* or *messiah*; to patiently suffer life for the future expectation of reward in heaven; to focus on taking care of one's own camels and to leave the affairs of state to god, president, or king, except to vote every four years as that's called “democracy” which one must worship; etceteras, while the rulers continue to enjoy their own unlimited heavens right here on earth.

The devil's apprentices also find an irresistibly natural fertile soil among the Muslims for imperial plowing and harvesting. Divided into partisan sects from birth, each having not just a different understanding of the early history of their religion, but also a slightly different understanding of the religion of Islam itself despite possessing the same Holy Qur'an that they all share, Muslims rush to draw upon their respective sectarian narrations of history and doctrinal mumbo jumbo (that's the only way I can fairly describe what pious Muslim scholars utter from their highest pulpits to indoctrinate their flock), to dignify their pathetic silence to tyranny. That's the “good Muslim” variety (sic!). The “bad Muslim” of course rush to join “Al Qaeda” (sic!). The Muslim ethos, born in servitude, cultivated into co-option, and dreaming of rewards in heaven, lends naturally to the Hegelian Dialectic of “good Muslim” vs. “bad Muslim”.



And precisely that facile world view was engaged from the very day of 9/11 by Muslim scholars with assistance from the many Trojan Horses and Uncle Toms. It made, and still continues to make ten years later, the otherwise un-congenial task of *“imperial mobilization”* all that much more un-impedimental for invading and occupying “bad Muslim” nations while the “good Muslims” who stay silent, or support the empire's narratives, are applauded and rewarded for their “United We Stand”. See for instance, the 2010 [600 page Fatwa on Terrorism](#)<sup>[12]</sup> which earned its Uncle Tom author a place next to the massa at the World Economic Forum in 2011.

As one can hopefully appreciate very clearly by now, the observation by Zbigniew Brzezinski: *“Hegemony is as old as mankind”*, has only been true because of an almost infinite gamut of facile views being deftly cultivated among the peoples who have lived and died for maintaining the glory of their rulers from the very beginning of civilization.

Where to seek knowledge, wisdom, when all bearers of knowledge and wisdom, both in the East and the West, appear to be shilling for self-interest? When the bearers of knowledge today also appear to be the greatest manipulators and predators of man? And when the knowledge seeker too is naturally beholden to socialization and susceptible to accepting facile world views ingrained since birth?

See the [CAIR report](#)<sup>[13]</sup> for the difficulties faced in overcoming facile views by even the most learned and pious when their own chiefs mislead them. For writing and disseminating that response to CAIR report pointing out its significant omissions, one Muslim board member of one of the largest Muslim community and mosque of California Bay Area responded: *“Whose interests are you serving? Hateful zionists or the hateful christian zioinists or both? Take me off your list.”!*

To be continued someday. For now – if there's interest – please see [“The Poor-Man's Guide to Modernity”](#)<sup>[14]</sup>. Two additional articles which shed some tangential light on how difficult this endeavor of seeking knowledge and overcoming facile views has become in our times: [“The IVY League Morons Syndrome”](#)<sup>[15]</sup> and [“Response to 'Why I'm leaving Harvard’”](#)<sup>[16]</sup>. A review of the [FAQ: What is an Intellectual Negro?](#)<sup>[17]</sup> and the report on the [Mighty Wurlitzer](#)<sup>[18]</sup> may prove useful in becoming self-aware of some of the mental gymnastics of servitude which naturally encourage holding self-serving facile views even among the most learned, especially among super-educated, upwardly mobile colonized peoples.

Zahir Ebrahim | Project Humanbeingsfirst.org

## Footnotes

[1] An early version of this article was submitted as comment for the article to the anon website: <http://lwtc247.wordpress.com/2011/06/09/jesus-isa-alahi-salam/#comment-5241>

[2] <http://print-humanbeingsfirst.blogspot.com/2009/12/morality-from-intellect-is-enslavement.html>

[3] <http://faith-humanbeingsfirst.blogspot.com/2011/08/islam-why-is-quran-easy-to-hijack-pt2.html>

[4] A straightforward exposition can be found in Murtada Mutahhari, *Understanding the Uniqueness of the Qur'an*, <http://www.al-islam.org/al-tawhid/unique-quran.htm> albeit with the characteristic presuppositions common to all ingrained sectarian socializations already examined in Part-I of *Islam: Why is the Holy Qur'an so easy to hijack?* <http://faith-humanbeingsfirst.blogspot.com/2011/08/islam-why-is-quran-easy-to-hijack-pt1.html> This fact of socialization is unfortunately not acknowledged by Mutahhari in his exposition even though it is embedded in the teachings of the Holy Qur'an in its emphasis on the separation of righteous beliefs (haquq Allah 42:10) from righteous acts (haquq-al-ibad 5:48). The Holy Qur'an calls itself *Al Furqan*, the criterion, by which to judge both for one's own strivings in the path of "haq". That lack of recognition fortunately does not detract from Murtada Mutahhari's sensible examination of how to study the Holy Quran despite that fact that he does lend an a priori conclusion to such study based on his own socialization which is amply in evidence in his exposition. It is in fact hard to find a scholar of any religion who fervently believes in that religion, who would be immune to such a priori conclusions even as he might endeavor to teach others how to study the religion and letting them arrive at their own conclusions AFTER that study! This appears to be the inherent nature of socialization and of the subjectivity, and hence the religiousity, conferred to it by the right-half brain. This is perhaps why the Holy Qur'an while accepting socialization as a human fact, has also laid so much emphasis on striving for "haq" under all conditions for everyone among mankind whereby, striving for overcoming the *nafs*, the personal inclinations due to proclivity and socialization, is termed the *greater jihad* and a co-requisite to the reflective study of the Holy Qur'an. See Part-II of *Islam: Why is the Holy Qur'an so easy to hijack?* (Ibid.) for some inherent impediments in its path.

[5] *Some Old Manuscripts of the Holy Qur'an* by Kazim Mudir Shanehchi, Astaneh-ye Quds-a Radawi, Mashad, Iran <http://www.al-islam.org/al-tawhid/manuscripts.htm>

[6] [http://nobelprize.org/nobel\\_prizes/physics/laureates/1979/salam-speech.html](http://nobelprize.org/nobel_prizes/physics/laureates/1979/salam-speech.html)

- [7] <http://faith-humanbeingsfirst.blogspot.com/2011/07/islam-surah-al-asr-of-holy-quran.html>
- [8] <http://www.globalresearch.ca/articles/BRZ110A.html>
- [9] [http://sites.google.com/site/humanbeingsfirst/download-pdf/god\\_is\\_on\\_your\\_side.wmv](http://sites.google.com/site/humanbeingsfirst/download-pdf/god_is_on_your_side.wmv)
- [10] [http://www.prisonplanet.com/articles/april2008/140408\\_b\\_Theology.htm](http://www.prisonplanet.com/articles/april2008/140408_b_Theology.htm)
- [11] [http://www.ted.com/talks/lesley\\_hazelton\\_on\\_reading\\_the\\_koran.html](http://www.ted.com/talks/lesley_hazelton_on_reading_the_koran.html)
- [12] <http://print-humanbeingsfirst.blogspot.com/2011/03/resp-terror-fatwa-in-service-of-empire.html>
- [13] <http://print-humanbeingsfirst.blogspot.com/2011/07/cair-report-islamophobia-rising-usa.html>
- [14] <http://print-humanbeingsfirst.blogspot.com/2011/06/poor-mans-guide-to-modernity.html>
- [15] <http://print-humanbeingsfirst.blogspot.com/2011/01/ivy-league-morons-syndrome-zahirebrahim.html>
- [16] <http://print-humanbeingsfirst.blogspot.com/2010/11/response-to-why-im-leaving-harvard.html>
- [17] <http://print-humanbeingsfirst.blogspot.com/2010/02/what-is-intellectual-negro.html>
- [18] <http://print-humanbeingsfirst.blogspot.com/2009/05/note-on-mighty-wurlitzer.html>

**Short URL:** <http://tinyurl.com/Islam-Socialization>

**Source URL:** <http://print-humanbeingsfirst.blogspot.com/2011/06/knowledge-vs-socialization.html>

### **About the author**

The author is a spiritual, non-religious to semi-religious, almost irreverent Muslim whose entry into every mosque he has ever opened his mouth is likely frowned upon. The opinions expressed here are the author's personal opinions as an ordinary plebeian. He is not a "scholar". He in fact detests scholars of all stripes, especially those presumptuous enough to call themselves scholars – be they Bernard Lewis, "*leading Western scholar of Islam*", or Tahir ul Qadri, the leading Eastern scholar of Islam. The latter had the chutzpah to issue a 600 page Fatwa on Terrorism in service to the "*leading Western scholar of Islam*" as incestuous self-reinforcement of imperial scholarship. See the author's Letter to Muslims on '*Is Islam really the Last Obstruction to World Government and Absolute Scientific Global Dictatorship?*', and Chapter-8 of *Prisoners of the Cave* titled '*The Role of American Muslims in Empire Building*'.

First published on June 11, 2011

## Chapter 10 Muslim Stooges in the Service of Empire

### Response to the Fatwa on Terrorism in the Service of Empire

The political philosophies and social engineering underlying *imperial mobilization* are far more diabolical today than they have been in the past. Comprehending the role of fabricated enemies and false oppositions to lend credence to the fabricated enemies, begins at the doorstep of political science, not Islam. The fatwa is part of the finely tuned social engineering to continually *engineer consent* for the fabricated perpetual war on terror.



Caption **Shameless Stooges** at the *massa's* table. The Western establishment's cultivated Trojan Horse among Muslims to institute beneficial religious diversity (sic!), namely "moderate Islam", Tahir UI Qadri makes even Mir Jafar/Mir Sadiq duo look virtuous. If there was any doubt earlier, the gratuitous presence at the 2011 WEF is conclusive proof of the Qadri-Khan duo being the pathetic house negroes eagerly carrying the white man's burden.

declares that attacks on innocent citizens are "absolutely against the teachings of Islam".

This is a response to the following pertinent passage from the Pakistani news reports on the Islamic scholar Dr. Tahir ul-Qadri of Minhaj-ul-Qur'aan, a Sufi organization in East London, issuing terrorism fatwa (also BBC March 2, 2010).

The Pakistani English language daily The News reported:

'LONDON: The 600-page document, drawn up by Dr Tahir-ul-Qadri,

The Minhaj-ul-Qur'aan, a Sufi organisation based in East London, which advises the British government on how to combat radicalisation of the Muslim youth, will launch the 600-page Fatwa against suicide bombings and terrorism, declaring them un-Islamic, tomorrow.

It condemns the perpetrators of terrorist explosions and suicide bombings. The document, written by Dr Tahir-ul-Qadri, declares the suicide bombings and terrorism as "totally un-Islamic". It is one of the most detailed and comprehensive documents of its kind to be published in Britain.'

Right!

The BBC in its own truthful coverage of the fatwa (and parroted by the world press) noted that: ***'The scholar describes al-Qaeda as an "old evil with a new name" that has not been sufficiently challenged.'*** Al Qaeda is indeed the same age "old evil with a new name": the fabricated Hegelian Dialectic necessary for launching and sustaining "imperial mobilization" on the Grand Chessboard!

But sadly, and quite expectedly, none heralding the fatwa in the worldwide media coverage, nor any branded scholar manufacturing consent or dissent, dared to complete that virtuous proclamation on terrorism in that 600-page fatwa with the following obviousness:

***'Furthermore, gratuitously laying a carpet of bombs on civilian populations, invading one's military forces into other nations' territories, and decimating entire civilizations to the point of cultural and physical genocide, is a far greater terrorism; a crime of aggression so heinous that it is not simply referred to as "war crime", but "the supreme international crime differing only from other war crimes in that it contains within itself the accumulated evil of the whole."***

Unless that additional truism – which is also the Islamic principle for culpability expressed in the Qur'an as the blame is with those who initiate the war-mongering aggression – well established by the Military Tribunal at Nuremberg by the United States herself as the yardstick for identifying primary war-mongers, is appended, or pre-pended, to any overarching statement on terrorism, one must know that all such pious proclamations, including that in the 600-page document, are only the Hegelian vomit of vulgar propagandists justifying the ***"supreme international crime"*** of their real masters.

Their fate will be no different than Goebbells'. Whether or not that destiny actually transpires within our own lifetime, let it be repeatedly told at every opportunity, in every

generation, and in no uncertain terms, that in the hammaams (bath houses) of the hectoring hegemony, these prostitutes are merely their “Bukakke” (borrowing that hideous new word which appears to be the passionate pastime of many a Pakistani as I learnt here).

Unlike some others, I foolishly write under my own name with full self-identification. And I invite these brilliant scholars who span the gamut of doctrinal warfare from peddling “Islam” with half-truths to peddling Secular Humanism with outright deception, to haul me into the International Criminal Court of Justice for referring to them by their only real profession. It should be interesting, but only if the foolish plebeian is permitted to speak unfettered.

Any takers of “justice”, “Islam”, Secular Humanism? How about you, Dr Tahir-ul-Qadri?

The voice of reason of ordinary plebeians often seems to be accompanied by only the thunderous sounds of silence. Free-speech in free-space can kill mercilessly by asphyxiation!

And humanity is concomitantly being butchered under the twain carpet of bombs because there is no one to challenge the **“supreme international crime”** in a forum that has any meaningful power to redress it. When the rare opportunity does materialize to wage a genuine battle for justice for a change, it is largely squandered on the lower order bits of the matter:

<http://print-humanbeingsfirst.blogspot.com/2010/03/zahirs-comment-Russell-tribunal-palest.html>

<http://print-humanbeingsfirst.blogspot.com/2010/01/letter-francisboyle-iraq-afghan-victims.html>

<http://print-humanbeingsfirst.blogspot.com/2009/04/vanilla-or-chocolate-icing-ondevilscake.html>

But what kills me even more than these well-intentioned justice-minded professionals whom I don't personally know – at least these courageous folks know the truth and operate on their own peculiar calculus of justice which merely differs from mine – is the obsequence of intellectual and house negroes in America and Pakistan, many of whom happen to be my good friends and colleagues. Some even know of my humble pen. And yet, they too only see the friggin Islamofascist pirates, just like this Dr. Tahir-ul-Qadri chap with his fake Hegelian opposition to Islamofascism. But not the emperor's vast armies poised to annihilate entire defenseless nations with their unmatched nuclear weapons, and already

having done so with extreme **“shock and awe”** invasions of Iraq, Afghanistan, Lebanon, Palestine, and now even doing their own nation.

Nor do they try to comprehend political science, that the pirates are almost entirely a diabolical synthesis of the emperor’s Machiavellian brains because without Islamofascism and its duped recruits, the rulers of the world have no pretext to rapidly transform their empire into world government. All the hectoring hegemon’s raped-pregnancies and birth-pangs of world order ultimately remain still-born without the synthetic curse of Islamofascism:

**‘[Because] the pursuit of power is not a goal that commands popular passion, except in conditions of a sudden threat or challenge to the public’s sense of domestic well-being. The economic self-denial (that is defense spending), and the human sacrifice (casualties even among professional soldiers) required in the effort are uncongenial to democratic instincts. Democracy is inimical to imperial mobilization. ... [Thus it is] more difficult to fashion a consensus on foreign policy issues, except in the circumstance of a truly massive and widely perceived direct external threat. ... That exercise requires a high degree of doctrinal motivation, intellectual commitment, and patriotic gratification.’** (Zbigniew Brzezinski)

I expect Dr. Tahir ul-Qadri of Minhaj-ul-Qur’aan to publicly explain his vulgar omissions in his partial definition of terrorism. Perhaps he remains un-aware that: **“Great is truth, but still greater, from a practical point of view, is silence about truth. By simply not mentioning certain subjects... totalitarian propagandists have influenced opinion much more effectively than they could have by the most eloquent denunciations.”** (Aldous Huxley) I would in fact support his thesis on terrorism if it was accordingly amended to reflect all the omissions noted here, and not couched as fatwa in the service of empire.

However, the learned scholar labors under a grave misconception that his personal opinion has any religious significance as fatwa, even if he were to make the aforementioned corrections and forthrightly condemn empire’s own state terrorism and war-mongering aggression in his document.

No human being needs permission from another to wage his or her legitimate self-defense. It is a primary existential instinct, more fundamental than any dogma, religion, or belief – even the lowliest of animals have their instinct for self-preservation. If modernity has



desensitized that basic instinct among humankind, watch its demonstration in animalkind in the Battle at Kruger. Loftier principles of morals and dogmas layered upon these basic natural instincts which purport to transform us human beings from the amoeba into Ashraf-ul-Makloqat – such as America's famous Bill of Rights and its Declaration of Independence, and of course Islam which proclaims itself the natural religion liberating man from the shackles of all servitude to fellow man – regulate what is lawful and what isn't so people may equitably co-exist with each other and with state-power without usurping each others rights. That regulation for Muslims choosing to follow the religion Islam, is explicit in the Qur'anic teachings in the context of terrorism vs. Jihad. These require no mullah's fatwa, no matter how learned. Personal fatwas in the religion of Islam may not be issued on what is already made explicit in the religion of Islam itself – by the very definition of the concept of fatwa in Islamic jurisprudence. What is permissible, and what isn't, in waging the battle of self-defense is already made abundantly explicit in the principled teachings of the Holy Qur'an. One may surely explain these principles to others in full context, but not issue fatwas amending, particularizing, or hiding its general import in the totality of the message of Islam through calculated omissions in the service of vested interests.

Any personal opinion couched as fatwa which fails to recognize the greatest enemy systematically devouring Muslims today, can only emanate from the enemy of the Muslims. The hectoring hegemons are experts at disguises and can wear any garb. The Mussalmans' short and blood-soaked history is replete with such two-bit skills putting religion in the service of empire. The price has spanned the gamut of co-option from a few silver coins for issuing imperial proclamations in the name of Islam, to anointed leadership of manufactured sects for sowing discords and **“beneficial cognitive diversity”** in the best mold of divide et impera.

In this instance, it is the realization of Daniel Pipes wet-dreams in the service of empire that ***'The idea that “militant Islam is the problem, moderate Islam is the solution” is finding greater acceptance over time.'*** Well, here is empire's own **“moderate Islam”** for us plebes, as the WWF wrestling match against its own virulent creation of **“militant Islam”**.

### **The face of “moderate Islam”**



Caption Video Face of “*moderate Islam*” featuring Dr. Tahir-ul-Qadri, the “*Ambassador of Peace*”. An even more entertaining version of Daniel Pipe's choice for “*moderate Islam*” with its leader\* basking in the adulation of his prostrating fans, is here (search)

The political philosophies and social engineering underlying *imperial mobilization* are far more diabolical today than they have been in the past. Comprehending the role of fabricated enemies and false oppositions to lend credence to the fabricated enemies, begins at the doorstep of political science, not Islam. The fatwa is part of the finely tuned social engineering to continually *engineer consent* for the fabricated perpetual war on terror. The primary modus operandi of that social engineering is seeded in the Hegelian Dialectics of Deception and the Technique of Infamy as already explained in this tutorial. Witness the dialectical twin of this pious Fatwa in the promulgation of the impious girl flogging video which was presciently unraveled in this Letter to Editor of April 06, 2009, and which is now coming unraveled even officially.

This factual observation of diabolically *engineering consent* with tortuous political theories and absurdities being primarily at work here, is further underscored in the stark contrast between the pious 'Islamic scholarship' of the Fatwa in the service of empire and this Syrian Arab Catholic priest's lament in his open letter 'To His Holiness Pope Benedict XVI'. The latter demonstrates a moral fibre largely unknown to Pakistan's virtuous *house negro* peddling 'Islam's holiness' for gratis (£6.99 for hardcopy), and which was even intoned by the BBC News Magazine as '**A fatwa they can work with?**': “An Islamic scholar turned up in London last week to deliver a religious ruling denouncing terrorism in all its forms – but what was it about him that made everyone sit up and listen? **He’s a man on a mission – a mission to state the obvious.**” Unfortunately for the 'untermenschen' everywhere, this

virtuous **“man on a mission”** journeying to the heartland of empire in voluntary servitude to peddle his “Islam” felt no **“moral mission to state the [even more] obvious”!** Facts which, quite unsurprisingly, even the empire's own top field commander, Gen. Stanley A. McChrystal, being a free man unfettered in his own *la mission civilisatrice*, had the cold chutzpah to boldly proclaim without fear of any future Nuremberg accountability: **“We have shot an amazing number of people, but to my knowledge, none has ever proven to be a threat,”** (New York Times, March 26, 2010)

Finally, I conclude this lamentable but principled response to Dr. Tahir-ul-Qadri's terrorism fatwa in the service of his empire with the only universally humanitarian prayer to perhaps ever escape from the particularistic lips of 'god's chosen people' now waging full spectrum war of domination upon all *Amelekites*, that of its favorite Nobel laureate Holocaust™ spokesman, Elie Wiesel:

***'I still curse the killers, their accomplices, the indifferent spectators who knew and kept silent, and Creation itself, Creation and those who perverted and distorted it. I feel like screaming, howling like a madman so that that world, the world of the murderers, might know it will never be forgiven.'***

Thank you.

\* **Footnote:** I have no opinion on Tahir ul-Qadri's version of “Sufi Islam” per se, only on his brazen omissions in defining terrorism in the *calculated* service of empire. Qadri is not a patsy.

**Zahir Ebrahim**

**Project Humanbeingsfirst.org**

---

## **Addendum: Letter to Fatwa Authors**

**Date: Wed, Mar 24, 2010 at 11:09 AM**

**From:** Zahir Ebrahim | Project Humanbeingsfirst.org

**To:** The originators and authors of the Fatwa on Terrorism

tehreek@minhaj.org, spokesman@minhajuk.org, shahid.mursaleen@minhajuk.org,  
zahid.iqbal@minhajuk.org, ishtiaq.ahmed@minhajuk.org

**CC:** Press

**Dear Scholars and Leaders of Islam issuing the One-sided Fatwa on Terrorism:**

You might be aware that I do not recognize any pious leaders, of Islam or otherwise, when they intersect conversely with truth, or with political science. The only genuine leadership I know of today, is that of the devil – the hectoring hegemons – and therefore, I oppose it.

Therefore, I do not find it impertinent to boldly ask whether you take peoples to be fools? Or are you just being useful idiots in the hands of hectoring hegemons? I am not sure which one. Therefore, I draw your kind attention to Project Humanbeingsfirst's Response to your Terrorism Fatwa which is entirely in the service of empire:

<http://print-humanbeingsfirst.blogspot.com/2010/03/resp-terror-fatwa-in-service-of-empire.html>

Please be advised that people are aware that all sorts of fatwas have been issued throughout history by the most pious pontiffs to justify the crimes of empire. If it is news to you how religion, and especially Islam, is put in the service of empire through half-truths and outright omissions, then, instead of presuming to teach others, you might perhaps spend some time studying yourself.

And lest you believe that you have acquired some newly inspired knowledge through virtuous piety which I do not possess due to my ordinary dint of hard study and forensic observations, and due to which you believe your palpable omissions as noted in the response are justified, I would be happy to hear of your inspired knowledge.

And if I am shown the error of my analysis and conclusions due to my general lack of humility before either the pirates or the emperor, I would be happy to eat crow.

Otherwise, I invite you to be forthright and include what is omitted in your terrorism report to complete your partial thesis in the full service of the people, of all peoples. For doing that, you will most assuredly earn my genuine and humble thanks with full endorsement of your report - provided the word fatwa is dropped from it. Your personal opinion has no religious significance in matters in which the religion of Islam has unequivocally already spoken. Only a political one, and that would be sufficient, nay [of] immense significance for the ordinary peoples of the world, almost 7 billion of us, of all faiths and persuasions, that even one Muslim scholar has the balls to call a spade a spade.

Even further, I would be most happy to enter into fair interlocution with your learned scholar who presumably authored this one-sided Fatwa, or obligingly put his name to it, in any public televised forum. Should be interesting for the world to witness a rational dialog between a virtuous Islamic scholar berating the pirates while ignoring the grotesque imperial mobilization of the emperor that is not only responsible for genocide of multiple Muslim civilizations, but is also rapidly lowering an iron-curtain of tortuous police-states throughout Europe and America, and an ordinary plebe.

I humbly invite the press to publish this letter in their columns and newspapers.

Thank you.

Zahir Ebrahim

Project Humanbeingsfirst.org

<http://humanbeingsfirst.org>

California, United States of America.

---

## The Reply

**Date:** Wed, 24 Mar 2010 21:44:52 +0000

**Subject:** Re: Response to the Fatwa on Terrorism in the Service of Empire

**From: Zahid Iqbal**

**To: "Project Humanbeingsfirst.org"**

**Cc:** tehreek@minhaj.org, spokesman@minhajuk.org, shahid.mursaleen@minhajuk.org, zahid.iqbal@minhajuk.org, ishtiaq.ahmed@minhajuk.org, Abbas Aziz , DAWOOD HUSSAIN

AoA

err....

I think we have a nut-job here, and a frustrated one at that. No need to reply, methinks...

Zahid

---

**Short URL:** <http://tinyurl.com/Tahir-ul-Qadri-Fatwa-Terrorism>

**Source URL:** <http://print-humanbeingsfirst.blogspot.com/2011/03/resp-terror-fatwa-in-service-of-empire.html>

**Source PDF Letter March 24, 2010:**

<http://humanbeingsfirst.files.wordpress.com/2010/03/letter-to-fatwa-authors-response-to-the-fatwa-on-terrorism-in-the-service-of-empire-by-zahir-ebrahim-march-24-2010.pdf>

First published on Saturday, March 20, 2010

## Chapter 11 FBI-Militancy Presentation and Empire

# FBI Muslims and Militancy Considerations --- Heads up

### A Public Service Message from Project Humanbeingsfirst.org

Ominous clouds are hovering over the Muslims of the West as they occupy themselves in virtuous mosque-piety behind useful idiots, false leaders and Trojan horses, quite oblivious to the reality around them. The best among the Muslim institutional leadership can only come up with syntactic sugaring – and this ranges from mosque pulpits to institutional reports to academic pundits selling their consciences on the prayer mat and amidst virtuous Hegelian Dialectic speeches on Islamophobia. Our institutional corruption spanning the gamut from Mosques to NGOs to the Academy is so widespread that it has become almost invisible and incognizant like the air we breathe --- but it surrounds us no less. This corruption isn't like what most Muslims are used to in the East. To understand this intellectual corruption which is laden with Faustian pacts of the soul and cradled in Machiavellian omissions to keep the laity perpetual *prisoners of the cave* while the prison walls around us continue to close-in, click on the FBI's agent-education image below:

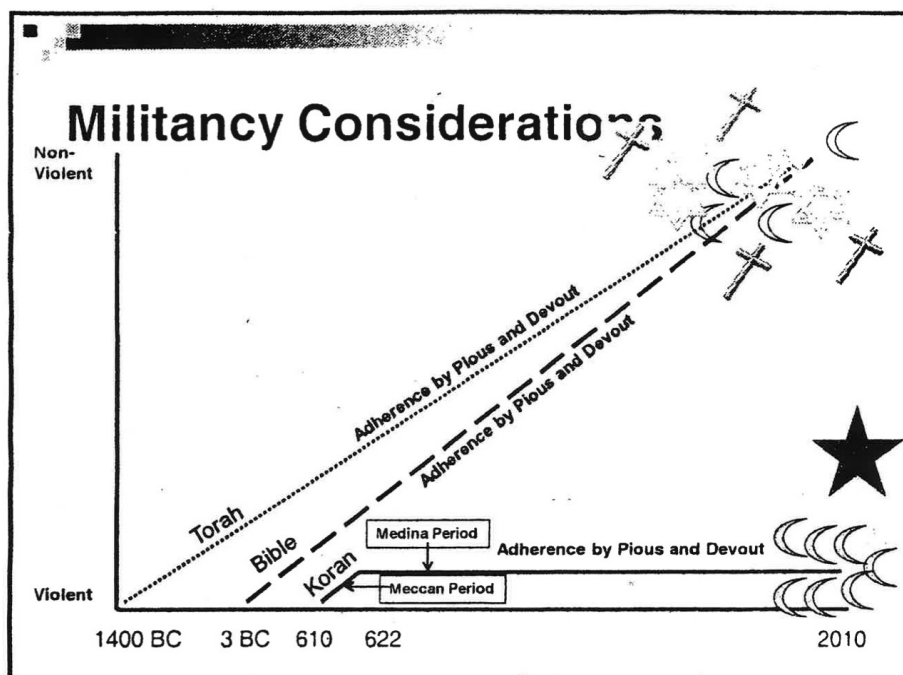

Caption An FBI presentation titled "Militancy Considerations" measures the

relationship between piety and violence among the texts of the three Abrahamic faiths [ **the god's chosen people obviously coming out on top!!!** ] As time goes on, the followers of the Torah and the Bible move from “violent” to “non-violent.” Not so for devotees of the Koran, whose “moderating process has not happened.” The line representing violent behavior from devout Muslims flatlines and continues outward, from 610 A.D. to 2010. In other words, religious Muslims have been and always will be agents of aggression. Watch [FBI Presentation Video](#) artfully Hijacking Islam. See [Islam vs. Secular Humanism and World Government by Zahir Ebrahim](#) for its full implication. ([Image source](#))

The roots of this graph in the FBI presentation are very distinguished and very deep-seated in doctrinal warfare. It is not merely some ad hoc “overreaction” to the “war on terror” against “militant Islam” by an overzealous state security apparatus' training program to keep the Americans safe from terrorists.

For instance, the late Samuel Huntington of Harvard University in his famous ode to reseeding new “*doctrinal motivation*” for the on-going exercise of Anglo-Saxon hegemony over the entire planet titled “The Clash of Civilizations and the Remaking of World Order”, stated:

“Some Westerners, including [ex] President Bill Clinton, have argued that the West does not have problems with Islam but only with violent Islamist extremists. Fourteen hundred years of history demonstrate otherwise .... Islam is the only civilization which has put the survival of the West in doubt, and it has done that at least twice.” (pg. 209)

“The underlying problem for the West is not Islamic fundamentalism. It is Islam, a different civilization whose people are convinced of the superiority of their culture and are obsessed with the inferiority of their power. The problem for Islam is not the CIA or the US Department of Defense. It is the West, a different civilization whose people are convinced of the universality of their culture and believe that their superior, if declining, power imposes on them the obligation to extend that culture throughout the world. These are the basic ingredient that fuel conflict between Islam and the West.” (pg. 217)

“The violent nature of these shifting relationships is reflected in the fact that 50 percent of wars involving pairs of states of different religions between



1820 and 1929 were wars between Muslims and Christians". (pg. 210)

"In 1990 Bernard Lewis, a leading Western scholar of Islam, analyzed '*The Roots of Muslim Rage*,' and concluded: '*It should now be clear that we are facing a mood and a movement far transcending the level of issues and policies and the governments that pursue them. This is no less than a clash of civilizations – that perhaps irrational but surely historic reaction of an ancient rival against our Judeo-Christian heritage, our secular present, and the worldwide expansion of both. It is crucially important that we on our side should not be provoked into an equally historic but also equally irrational reaction against our rival.*'" (pg. 213)

That "*Judeo-Christian heritage*" and '*The Roots of Muslim Rage*,' is what is captured in the FBI "Militancy Considerations" training graph. Bernard Lewis of Princeton University further reconstituted Huntington's self-serving statistic for the "*basic ingredient that fuel conflict between Islam and the West*" in his post 9/11 ode to defending the West against "militant Islam" titled "Crisis of Islam – Holy War and Unholy Terror":

"... But Islam, like other religions, has also known periods when it inspired in some of its followers a mood of hatred and violence. It is our misfortune that we have to confront part of the Muslim world while it is going through such a period, and when most – though by no means all - of that hatred is directed against us." (pg. 25)

"Terrorism requires only a few. Obviously the West must defend itself by whatever means will be effective. But in devising means to fight the terrorist, it would surely be useful to understand the forces that drive them." (pg. xxxii)

**That's all that the FBI is doing – implementing Bernard Lewis' prescription. The FBI, like all the rest of the Western states security and war-mongering apparatuses of their vast interlocking military-industrial-academe-media-intelligence complex, are defending the West against the motivations outlined for them by the *god's chosen peoples*:**

"For more than a thousand years, Islam provided the only universally acceptable set of rules and principles for the regulation of public and social life. Even during the period of maximum European influence, in the countries ruled or dominated by European imperial powers as well as in those that

remained independent, Islamic political notions and attitudes remained a profound and pervasive influence. In recent years there have been many signs that these notions and attitudes may be returning, albeit in modified form, to their previous dominance.” (pg. 13)

But we already knew all about that imminent threat of the Islamofascists trying to take over the West. Since the day FBI knocked on my door in 2003 as the bombing of Iraq was underway to protect the Americans from Sadaam Hussein's WMDs, I knew that by first hand experience.

Which begs the question, why make such information public? The intelligence apparatuses will do what they are chartered or ordered to be doing – what purpose does such an outright *big lie* depicted in the FBI graph serve by making it public? Never mind the Christian Crusades; never mind Christian Zionism and Talmudic Zionism devastating Palestine to Iraq; never mind the World Wars which saw Christians killing Christians, and Christians killing Jews, all financed by the Jewish Wall Street and the Jewish bankers controlling the Federal Reserve Bank of the United States who sat in on the subsequent so called Peace Conferences to harvest the loot of the Balfour Declaration to orchestrate the Jewish State in Palestine in the name of Torah's god: “*This country exists as the fulfillment of a promise made by God Himself.*” [1] and “*It is true God promised it to us. ... Our God is not theirs.*” [2]; etceteras, who would buy into such an outright big lie in the West today? The majority of its public who 'United We Stand' with absurdities! This includes all the Muslims who stay silent like their Western counterparts, and labor under the same or different misconceptions.

Those who do not understand the psychological basis of doctrinal warfare, fear-mongering, and uncertainty-creation as essential ingredients of psyops and mass persuasion techniques for creating “*revolutionary times*” [3] as the most effective means of changing the lifestyle of an entire people, will never comprehend such matters which are driven entirely from the macro-social calculus of ushering in one-world government. Unless one understands all of that, that the Hard Road to World Order is paved in cold blood, one can neither understand this FBI training modality for its agents, nor the obedience training of Americans at airports. See the detailed Mighty Wurlitzer Report to comprehend its primal DNA. And read the two short articles Convince People of Absurdities and get them Acquiescing to Atrocities: The Enduring Power of Machiavellian Political Science and ‘War on Terror’ is not about ‘Islamofascism’ – Please get with the real agenda you people! to understand how the blossoming tree of “*imperial mobilization*” is being constructed in baby steps using that very DNA of full spectrum psychological warfare and controlled

“revolutionary times”.

Pick up Huntington's *The Clash of Civilizations*, and Bernard Lewis' *Crisis of Islam*, and read them both in the context and references outlined here and the absurd FBI graph will start making sense. Then pick up Zbigniew Brzezinski's *The Grand Chessboard* and the concept of “doctrinal motivation” necessary for “imperial mobilization” will start making sense:

“It is also a fact that America is too democratic at home to be autocratic abroad. This limits the use of America's power, especially its capacity for military intimidation. Never before has a populist democracy attained international supremacy. But the pursuit of power is not a goal that commands popular passion, except in conditions of a sudden threat or challenge to the public's sense of domestic well-being. The economic self-denial (that is defense spending), and the human sacrifice (casualties even among professional soldiers) required in the effort are uncongenial to democratic instincts. Democracy is inimical to imperial mobilization.” (pgs. 35-36)

“Moreover, as America becomes an increasingly multicultural society, it may find it more difficult to fashion a consensus on foreign policy issues, except in the circumstance of a truly massive and widely perceived direct external threat. .... More generally, cultural change in America may also be uncongenial to the sustained exercise abroad of genuinely imperial power. That exercise requires a high degree of doctrinal motivation, intellectual commitment, and patriotic gratification.” (pgs. 211-212)

Compare all that book knowledge with the empirical reality, and Bertrand Russell's 1952 book *The Impact of Science on Society* will start appearing more self-servingly prophetic than Nostradamus:

“There is, it must be confessed, a psychological difficulty about a single world government. The chief source of social cohesion in the past, I repeat, has been war; the passions that inspire a feeling of unity are hate and fear. These depend upon the existence of an enemy, actual or potential. It seems to follow that a world government could only be kept in being by force, not by the spontaneous loyalty that now inspires a nation to war.” (Ch. 2, pg. 37)

## **Muslims today are victimized twice:**

- First by the massa's "imperial mobilization" by way of deception, by dictatorship infliction, by bombardment and "democracy" and "revolution" infliction to bring freedoms from the same dictatorships, not to mention more neo-liberal debt enslavement for rebuilding what's destroyed while bringing neo-cons freedoms.
- And second, by the subversion of our own Uncle Toms who keep us confused and un-enlightened by their shifting amalgams of myths, half-truths, omissions, mis-diagnosis, and red herrings.

Together they target us by total perception management, and thus control our behavior of full servitude by piece-meal conditioning, eventually leading to Pavlovian compliance to their every stimulus. Their dominant narratives is what informs us, cajoles us, frightens us, and that's how we end up 'United We Stand' with the Massa. If they say there is "Islamic terrorism", we say there is "Islamic terrorism". If they say 9/11 was the work of "jihadi Muslims", if they say there is "global warming", "peak oil", "swine flu", this and that global disaster, this and that galactic catastrophe, we not only echo the same, but naturally find ourselves inclined to act in accordance to that implanted fear. If such mantras come anointed with imposing IVY stamp of approval, the Nobel stamp of approval, lofty academic endorsement, so much more we believe in them, to the point that we even permit the state to molest us to keep us safe! The theories of psychological persuasion techniques in textbooks exactly match the ground realities. Sounds rather prosaic – but empirically true nevertheless.

This ought not to be surprising --- here is Aldous Huxley prognosticating it in 1962 at University of California-Berkeley:

'You can do everything with bayonets except sit on them! If you are going to control any population for any length of time you must have some measure of consent. It's exceedingly difficult to see how pure terrorism can function indefinitely. It can function for a fairly long time, but I think sooner or later you have to bring in an element of persuasion. An element of getting people to consent to what is happening to them. Well, it seems to me that the nature of the Ultimate Revolution with which we are now faced is precisely this: that we are in process of developing a whole series of techniques which will enable the controlling oligarchy who have always existed and presumably always will exist, to get people actually to love their servitude!

This is the, it seems to me the ultimate in malevolent revolution shall we say.’ — Aldous Huxley, 1962 speech at UC Berkeley, minute 04:06

Without our own self-study and due diligence, without skepticism to all that is presented to us, as the targets of villainous perception management and behavior control, we will continue to fall victim to the Uncle Toms who control all our institutions on behalf of the massa.

We have to by-pass our holy and pious chieftains and their institutions and become self-reliant both intellectually and physically, that means in thought as well as in lifestyle away from our pontiffs and chieftains, or else we shall continually be sold down the drain in the guise of their being our illumined “benefactors” and “peace-makers”. Holy Qur’an verse 2:11 even bears witness to that timeless empiricism --- but Plato predates it in his prescient similitude *Myth of the Cave* in *The Republic* by one thousand years!

Empowering the individual with deep knowledge in overarching contexts to instill deep system insights into the calculus of hegemony, is the only antidote for this full spectrum assault on the human mind which employs sophisticated psychological persuasion techniques of behavior control from cognitive to subliminal. We cannot lay out the parts like a motor mechanic and examine each one in isolation. We have to look at the entire system and understand its overall behavior as a function of its components and what role each plays in that overall system dynamics.

Such comprehension cannot be had in 15-second attention spans we have been weaned on. And nor by sitting like stupid gullible fools in pious or learned gatherings listening to Trojan Horses and other insipid fools and useful idiots planted among us and in our vaunted institutions – both religious and secular, as well in our academies and our governments. And nor can it be acquired by the feeble minded cowards and Uncle Toms who prefer to die many deaths for the pleasure of earning a good word and a paycheck from the *massa*. There is no external cure for Faustian pacts. The cure for that is solely within.

But for the rest more inclined to use an iota of commonsense and a modicum skepticism than stoned belief in authority to examine any matter, this heads-up contains essential knowledge you will not be given either at UC Berkeley, or Harvard, or Princeton, or by a Woodrow Wilson scholar or a Nobel laureate, or by the mercenaries and stooges heading CAIR or MCA, or ISNA, ICNA, AMA, CIA, ISI, MI6, CNN, ABC, NBC, BBC, NYT, and the myriad other alphabet soups throughout the world under the iron grip of the Mighty

Wurlitzer. Yet this knowledge is entirely public information, only waiting to be read and studied as containing the master blueprints for the global governance system being built openly. Its success lies in obscurity by design – since no one “respectable” goes there. Just look at the two recent reports emanating from CAIR and American Progress in collaboration with University of California-Berkeley, both belaboring the obviousness of Islamophobia like the autumn leaves, but not disclosing to the public what is made deliberately obscure by their criminal conspiracy of omission. None of them relate matters to the Hard Road to World Order... but they will all be eagerly doing so ex post facto, and awarded Pulitzers and other lofty intellectual anointments for their eruditeness!

It is a crafty red herring and calculated subversion for Muslim institutions (led by glorified Uncle Toms and useful idiots) to protest the fabricated symptoms of the disease while ignoring the root cause of the disease: The Diabolical Hijacking of Islam for Imperial Mobilization by god's chosen peoples!

Now we can finally return to the question asked above to lend some forensic insight into the matter: Why did the FBI make its 'Islamology' presentation public which is entirely drawn from the war-mongering Jews Bernard Lewis', Samuel Huntington's, Zbigniew Brzezinski's et. al.'s decades old craftsmanship for a viable “*doctrinal motivation, intellectual commitment, and patriotic gratification*” to seed the propagandistic explanation for a “New Pearl Harbor”, and subsequently sustain “*imperial mobilization*” to its logical conclusion as disclosed above? It further begs the question that for those eloquently condemning it, including Muslim organizations like CAIR, myriad other civil rights and human rights organization including the Senators who Blast FBI Terror-Training ‘Lies’, Senator Joe Lieberman, the bastion of Zionist Jewry in the United States Senate, why is the forensic articulation of what's disclosed here by a mere plebeian so difficult for them to express?

It ain't rocket science – or is it? No, it is only Machiavellian political science!

Think Hegelian Dialectic of Dissent ( <http://tinyurl.com/Hegelian-Dialectic-Dissent> ) fabricated from bogus lies whose main purpose is to re-justify the core-axioms of empire couched in WWF wrestling, and the fog lifts instantly! One team invents the lies, the other condemns it, and it is orchestrated by the same coterie who come away from it re-emphasizing the core “*doctrinal motivation*”, the threat of “al-Qaida”, at the expense of their own intelligence apparatus which is only following the directives given to it by the State. This is what the most hawkish king of war-mongering neo-con Zionist Jews in the US Senate averred, playing WWF wrestling with his brethren with a chutzpah which only the god's chosen people who have moved *from “violent” to “non-violent”* following their Torah

can muster:

**“There is no room in America for the lies, propagated by al-Qaida, that the U.S. is at war with Islam, or the lie propagated by others that all Muslims support terrorism,” Sen. Joe Lieberman, the chairman of the Senate Homeland Security and Government Affairs Committee, told Danger Room.’ WIRED, September 15, 2011**

Examine the political science of it all today and not tomorrow when fait accompli of world government will make it a moot point which boogiemans were myth, and which one was factual --- like the disclosure by the New York Times in 2008 of the Pentagon's Message Machine that its retired Generals diabolically led the three ring media circus to enact America's decimation of Iraq under obvious falsehoods. That belated admission after the NYT itself led that three ring circus did not restore to Iraq its shattered tabula rasa with any more chutzpah than the admission by the Iraq Study Group in 2005, mostly populated by the same hectoring hegemony who led the mantra of WMD in the first place including Bernard Lewis, that all the intelligence on Iraq's WMDs were indeed false!

Tomorrow, many of the myths and “*doctrinal motivations*” taken as gospel truths today will similarly be shown to be the output of the Mighty Wurlitzer's message machine with a simple narrative “oops”! This is already presaged in The Report from Iron Mountain where the motivational source for many fear-mongering modern myths can be found. Don't wait until tomorrow when you hear it from your favorite pontiffs and nod your head in that all-knowing state of servitude that has become the pathetic characteristic of Muslims and all the rest of the 'untermenschen' worldwide. Evaluate the many Hegelian Dialectics today, argue these today, challenge your pontiffs today, disrobe and unmask them today, understand the motivations behind their Message Machine today which comes layered in sophisticated political science as the vile mechanics for a system of global governance that is being deceptively ushered in under different guises of fabricated “*revolutionary times*”. This system is being wrought by a people all of whom evidently have multiple Ph.Ds. in deception. The culprits are visible to even the most blind in the saintly FBI graph itself.

And ultimately, if you deem this knowledge not worthy as it still only comes from the lowly pen of a most ordinary plebeian, and not from your favorite pontiff, throw it away.

**Thank you.**

**Zahir Ebrahim**

## Footnotes

[1] Full quote: *“This country exists as the fulfillment of a promise made by God Himself. It would be ridiculous to ask it to account for its legitimacy.”* -- Golda Meir, Le Monde, 15 October 1971 ([source](#))

[2] Full quote: *“If I were an Arab leader, I would never sign an agreement with Israel. It is normal; we have taken their country. It is true God promised it to us, but how could that interest them? Our God is not theirs. There has been Anti-Semitism, the Nazis, Hitler, Auschwitz, but was that their fault? They see but one thing: we have come and we have stolen their country. Why would they accept that?”* -- David Ben Gurion – Quoted by Nahum Goldmann in Le Paradoxe Juif (The Jewish Paradox) ([source](#))

[3] Full quote: *“What is inconceivable in normal times is possible in revolutionary times; and if at this time the opportunity is missed and what is possible at such great hours is not carried out – a whole world is lost”* -- David Ben Gurion ([source](#))

## Additional References

[1] [Zahir Ebrahim's Letter to Editor: FBI's Islamology September 25, 2011](#)

[2] [Zahir Ebrahim's Response to Chris Hedges' amalgam of half-truths 'A Decade After 9/11: We Are What We Loathe' September 13, 2011](#)

**Source URL:** <http://faith-humanbeingsfirst.blogspot.com/2011/09/fbi-muslims-and-militancy.html>

First Published September 18, 2011



## Chapter 12 Obedience Training and Empire

# Body-scan Alert - Not Suffering Indignities at Airports

First Published November 06, 2010 | Last updated Saturday, November 26, 2011



Dear American & International traveler friends,

Please pay URGENT attention to this :

- Airport screeners get more aggressive with pat-downs ;
- TSA agents gone wild: fondling little children, planting cocaine in passenger bags and more ;
- TSA Groping Out Of Control ;
- Hands off, buddy – we're Americans ;
- Don't Touch My Junk ;
- Miss USA Susie Castillo: My TSA Pat Down Experience
- Watch CNN Meredith Jessup Report: 'TSA Behavior Indicator'
- Documents Reveal TSA Research Proposal To Body-Scan Pedestrians, Train Passengers, Forbes
- Radiation scientists agree TSA naked body scanners could cause breast cancer and sperm mutations
- Amy Alkon: "YOU RAPED ME."
- Amy Alkon: TSA agent Thedala Magee's demands me to pay her \$500K, apologize to her, and take down my blog item about her

- Elie Mystal: Two Minutes of Terrorist Triumph: Alone With the TSA

And this:

- Get the facts about Advanced Imaging Technology (<http://dontscan.us/scans.html>)

Please click on the link above to download the *Know Your Rights at Airports Brochure* from dontscan.us. If you don't like these images, you should be aware that according to the brochure, you have been generously afforded the right to say NO to body-scan with the supposed **"I Opt-out"** utterance.

Should you sensibly choose to exercise that right, then you have to deal with the possible trauma described in one of the links above which states: **'TSA agents stand accused today of fondling the genitals of women and little children as part of their "enhanced pat-down" procedures being rolled out at airport security checkpoints.'**

The brochure imaged below further carries the following **warning**:

**'Pat downs are no longer the simple search like those in the past. In some instances, as part of an "enhanced patdown," the TSA screener may use the front of their hands to touch your genitals. Should you feel that you or your child were inappropriately touched, call for a law enforcement officer.'**

**If presented with the option to leave the checkpoint for a private screening, consider politely declining with a "No, thank you," as you will likely be asked to remove your clothing. Pat downs can be performed in public view.'**

Please study this carefully. This is unbelievable!

If you are like me, then my attitude is that before submitting to pat-down and after having uttered the formulaic *"I opt-out"*, coldly warn that nice-looking TSA agent getting ready to frisk you that he better not touch you and your family members' private parts and if he intends to, that you want to immediately see the manager/supervisor in-charge before subjecting yourself to pat-down physical search.

And, if you are still more like me, you will likely boldly add within earshot of others waiting in line to experience the same traumas, that you will NOT subject yourself to humiliation by either undergoing strip-search which is what the body-scan reduces to, or gross physical pat-down of your anatomy and the violation of your personal rights guaranteed you by the

Constitution. And that while you know the TSA is merely doing its job to earn its paycheck just like the 'Good Germans' once did in the Third Reich, you are concerned for your own rights and privacy and you wish to take preventive action now rather than lament later!

I would personally make a calculated, un-emotional, carefully chosen, perhaps pre-rehearsed, loud statement of rights and dignity **before** I am humiliated, rather than doing it afterwards emotionally, when crying and talking to CAIR/ACLU/clergy and filing meaningless complaints serves little to mitigate the traumas – for indeed, it is only the un-courageous silent acquiescence to tyranny which creates all this erosion of rights and liberties in the first place. I did that once before, entirely un-rehearsed, and this is what I have advised my own family to remember – teaching by example rather than academic punditry – their old man's stance at the front door on those two occasions in April 2003 when the nice boys from the FBI had come calling looking for “terrorists” in our home in California: [They dared to Knock on my door!](#)

And I am still here. And so long as I have the choice, I refuse to suffer indignities, either in Pakistan my home country where it is far more common to be feeled up at every damn checkpoint and roadblock, or in the United States where I live. When I won't have the choice, I don't know what I will do – perhaps nothing different from the vast 'untermenschen' now bearing the brunt of “**imperial mobilization**” from Pakistan to Palestine. Every day I and my loved ones escape that fate, I offer a prayer of thanks!

If you are really like me, then you too will be boldly civic minded before you lose that choice. You too will daringly protect your own inalienable rights and your own dignity – no one else will do it for you.

Before the day comes when everyone is asked at gun-point every few hundred yards, “*your papers, your papers please, show me your papers*”, and one's refusal then is rewarded with a bullet lodged into one's brain, it is surely a tad easier to stand-up now with the little show of courage that it takes, before the indignities of these government mandated TSA searches.

An excellent illustration of how to do this with dignity, poise, and resolute firmness is in the experience of a recent traveler in his pre-Thanksgiving week journey through an American airport. The traveler, Matt Kernan, meticulously reported his encounter in his blog article '[My TSA Encounter](#)' where he narrates:

'I certainly don't enjoy being treated like a terrorist in my own country, but I'm also not a die-hard constitutional rights advocate. However, for some

reason, I was irked. Maybe it was the video of the 3-year old getting molested, maybe it was the sexual assault victim having to cry her way through getting groped, maybe it was the father watching teenage TSA officers joke about his attractive daughter. Whatever it was, this issue didn't sit right with me. So, since I had nobody waiting for me at home and no connecting flight to catch, I had some free time. I decided to test my rights. After putting all my stuff through the x-ray, I was asked to go through the Backscatter. I politely said that I didn't want to. The technician quipped to his colleague, "We've got an opt-out." They laughed. He turned back and started to explain. After he finished, I said, "***I understand what the pat-down entails, but I wanted to let you know that I do not give you permission to touch my genitals or the surrounding area. If you do, I will consider it assault.***" ... I was never touched, I was never "Backscattered," and I was never metal detected. In the end, it took 2.5 hours, but I proved that it is possible. I'm looking forward to my next flight on Wednesday.' -- 22 Nov 2010 <http://noblasters.com/post/1650102322/my-tsa-encounter>

**Click on the image below to watch video reports of how some other Americans are reacting**

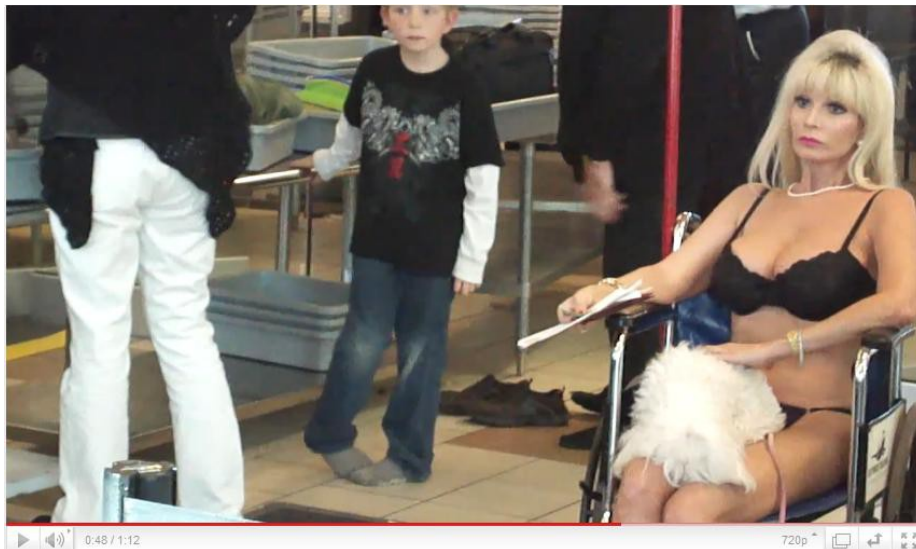

Caption What Went Wrong In The Land of The Free – Standing For Airport Indignities: In bra, panties and wheelchair, Tammy Banovac goes through Oklahoma City airport screening on 30 Nov 2010

The AP news report of November 15, 2010, **Scanners and pat-downs upset airline passengers** (cached [here](#)), narrated the story of Americans' rising outrage:

'Nearly a week before the Thanksgiving travel crush, federal air security officials were struggling to reassure rising numbers of fliers and airline workers outraged by new anti-terrorism screening procedures they consider invasive and harmful.

Across the country, passengers simmered over being forced to choose scans by full-body image detectors or probing pat-downs. Top federal security officials said Monday that the procedures were safe and necessary sacrifices to ward off terror attacks.

*"It's all about security,"* Homeland Security Secretary Janet Napolitano said. *"It's all about everybody recognizing their role."*

Despite officials' insistence that they had taken care to prepare the American flying public, the flurry of criticism from private citizens to airline pilots' groups suggested that Napolitano and other federal officials had been caught off guard.

At the San Diego airport, a software engineer posted an Internet blog item saying he had been ejected after being threatened with a fine and lawsuit for refusing a groin check after turning down a full-body scan. The passenger, John Tyner, said he told a federal Transportation Security Administration worker, ***"If you touch my junk, I'm gonna have you arrested."***

Tyner's individual protest quickly became a web sensation, but questions also came from travel business groups, civil liberties activists and pilots, raising concerns both about the procedures themselves and about the possibility of delays caused by passengers reluctant to accept the new procedures.

There are some 300 full-body scanners now operational in 60 U.S. airports. TSA is on track to deploy approximately 500 units by the end of 2010.'

The Harvard Crimson reported on [December 03, 2010](#), **Harvard Students Sue TSA Over 'Intrusive' Searches:**

'Two Harvard Law School students filed a lawsuit against the Transportation Security Administration for its use of "intrusive" full body scanners and pat down procedures late last month.

Jeffrey H. Redfern and Anant N. Pradhan, both second year Law School students, allege that the scanners—which generate images of travelers' bodies—and the TSA's "enhanced pat down" technique which requires "the touching of their genital areas" are a violation of the Fourth Amendment protection against unreasonable search and seizure, according to the complaint filed on Nov. 29 at a U.S. District Court in Boston.

Currently, passengers are permitted to opt out of a full body scan, but upon doing so must submit to an enhanced pat down.

Both Redfern and Anant opted out of the full body scan while traveling on separate occasions and found the pat down "highly intrusive," according to the complaint.'

Remember, TSA is authorized by the Homeland Security, which in turn is authorized by the US Government, to subject its denizens to this – TSA is not doing it on their own. It draws its rights from the Government, which at least in the lofty American Republican theory, draws its rights from the people. It isn't clear to me whether deliberately hiring sexual perverts into TSA and calculatingly seeding the traumas noted in the first link above, is part of the unwritten coercion policy of the Government to get objecting peoples to accept the body-scan! It just seems extraordinary to me that without some tacit support from higher-ups, that anyone in their right mind would do such molestation in such a public place with everyone watching.

**This is a commonsense public service message from Zahir Ebrahim, Project Humanbeingsfirst.org**

Please circulate it, specially to your young family members and womenfolk who travel. It does not matter that they might be travelling in the company of their adult male family members – perverts and absurdities do not discriminate between sexes and ages, nor does tyranny.

Just imagine the entire body-scan scam failing before it gets off the ground due to every civic-minded law-abiding courageous American declining all indignities in the name of enhanced security – their own, from big brother!

The UK and EU Airports shall not escape such draconian procedures either unless good peoples silently complying with state-tyrannies in Europe also stop doing so in significantly large numbers. This report headlined '**Muslim woman barred from flight after refusing body scan**' in the UK Telegraph of [March 03, 2010](#) states: 'A Manchester Airport

spokeswoman said: *“Two female passengers who were booked to fly out of Terminal 2 refused to be scanned for medical and religious reasons. In accordance with the Government directive on scanners, they were not permitted to fly.”*

Despite the real fear of being labeled as suffering from an **“oppositional defiant disorder”** as per the newly revised DSM IV psychiatric manual (see [Anatomy of Conspiracy Theory](#)), and the concomitant threat of being legally confined to 'state-hospitality' centers for rehabilitation, or worse, being labeled **“domestic terrorist”** as per big-brother's newly enacted police-state laws to maintain domestic tranquility in the face of rising public discontent, the price to be paid now to challenge the grotesquely Orwellian Western society while it is still in its infancy, is minuscule compared to what our progeny will face! A new generation born into a mature system of big brother in the West won't know the difference – unless their parents' generation takes a cross-Atlantic stand now while the Orwellian World Order is still only being birth-panged into existence under the pretext of fighting the War on Terror: [What is War on Terror?](#).

Please read the CFR's April 1974 disclosure [“Hard Road to World Order”](#), to hear it from the horse's mouth concerning the nature of this World Order and how it must be deceptively instrumented, piece-meal: *“In short, the ‘house of world order’ will have to be built from the bottom up, rather than from the top down. It will look like a great ‘booming, buzzing confusion’ to use William James’ famous description of reality, but an end run around national sovereignty, eroding it piece by piece will accomplish much more than the old-fashioned frontal assault.”* Here is a *CliffsNotes* version which deconstructs that diabolical planning for those weaned on 15-second attention spans and unable to digest too much information in one sitting: [Of Ostriches and Rebels on The Hard Road to World Order by Zahir Ebrahim](#). And here is a detailed tutorial that demonstrates the hideous existence of long-entrenched establishment forces arrayed against the peoples of the United States of America and which transcend the changing occupants of the White House and the Congress: [Tutorial: The Un-Hidden Agenda for World Government by way of 911 and Imperial Mobilization By Zahir Ebrahim](#).

EPIC, the civil liberties research center in Washington, D.C., has acquired Homeland Security Documents under FOIA, including this 173 page ominous [report](#) dated July 12, 2006, which reveal phased proposals to Body-Scan pedestrians, rail passengers, with rapidly emerging Electromagnetic technologies. It should not be surprising if the next thing to be revealed as part and parcel of fighting terrorism will be their deployment at shopping malls, Safeway, Macys, and schools! Meanwhile, the latest in terrorist detection has already been revealed by Der Spiegel, to be those wearing a [Casio watch](#): *“US interrogators at Guantanamo Bay identified potential terrorists by the watch they wore on their wrist.”*

*Evidently, “The Watch Points to Mecca”, and is “Used to Detonate Bombs”!*

Given such overwhelming agendist forces at play, resisting both the deadly body-scan as well as the vile patdown intrusions at airports, may indeed appear to be an insignificant challenge.

However, the import of this challenge in firing up the imagination of a significant percentage of the public if the draconian and nonsensical security measures are successfully thwarted even at a single airport, can be immense. Recall that the active participants in the American Revolutionary War were only 3% of the colonist population! The Western states being ubiquitously governed by brilliantly psychopathic minds, also realizing that such small defeats can quickly snowball into larger defeats with the possibility of widespread domestic revolts, will surely try to make an example of those resisting the body-scan (see video report by CNN's Meredith Jessup in Postscript below)! In the United States, it is already frowned upon in some places to quote its Constitution chapter and verse even in one's own self-defense (see: Postscript ‘War on Terror’ is not about ‘Islamofascism’ – Please get with the real agenda you people!).

Therefore, also be forewarned that if you sensibly choose to act in your and your progeny's own best interests, it may not be a free ride. You may be denied boarding, or even arrested.

## **Summary**

If you have to travel but don't wish to be part of the new nude morality of the United States that is trying hard to keep America safe from the ubiquitous Islamofascist terrorist, you still have some liberating choices in personal freedoms left:

- 1) 'To opt out for a pat down, say “I opt out.”
  
- 2) 'Warning: Pat downs are no longer the simple search like those in the past. In some instances, as part of an “enhanced patdown,” the TSA screener may use the front of their hands to touch your genitals.

Should you feel that you or your child were inappropriately touched, call for a law enforcement officer.

If presented with the option to leave the checkpoint for a private screening,



consider politely declining with a “No, thank you,” as you will likely be asked to remove your clothing. Pat downs can be performed in public view.'

3) Warning2: Should you sensibly choose to exercise that right, then you have to deal with the possible trauma of being groped and molested: 'TSA agents stand accused today of fondling the genitals of women and little children as part of their “enhanced pat-down” procedures being rolled out at airport security checkpoints.'

4) Warning3: Should you sensibly choose to quote your inalienable rights guaranteed by the Constitution to protect yourself and your loved ones from these vile indignities, you may have to deal with being labeled a “domestic terrorist”!

5) Based on this escalation path of making the price of discontent progressively costlier and costlier, the vast majority will simply choose the body-scan. That appears to be the strategic thinking behind these enhanced pat down procedures and the occasional case of vile molestation which will be widely reported!

6) But if you choose to bravely stand up for yourself by not standing for any of these vile indignities, you may not only get away with having a pleasant journey, you will also be assisting in patriotically extracting your nation from the rapidly closing jaws of the *Brotherhood of Death*.

**Postscript-1: Jeffrey Goldberg confirms the aforementioned summary, especially item-5, in *the Atlantic*, October 29, 2010, 'For the First Time, the TSA Meets Resistance'**



“I asked him if the new guidelines included a cavity search. “No way. You think Congress would allow that?”

I answered, “If you're a terrorist, you're going to hide your weapons in your anus or your vagina.” He blushed when

I said "vagina."

"Yes, but starting tomorrow, we're going to start searching your crotchal area" -- this is the word he used, "crotchal" -- and you're not going to like it."

"What am I not going to like?" I asked.

"We have to search up your thighs and between your legs until we meet resistance," he explained.

"Resistance?" I asked.

"Your testicles," he explained.

"That's funny," I said, "because 'The Resistance' is the actual name I've given to my testicles."

He answered, "Like 'The Situation,' that guy from 'Jersey Shore?'"

Yes, exactly, I said. (I used to call my testicles "The Insurgency," but those assholes in Iraq ruined the term.)

I pointed out to the security officer that 50 percent of the American population has no balls (90 percent in Washington, D.C., where I live), so what is going to happen when the pat-down officer meets no resistance in the crotchal area of women? "If there's no resistance, then there's nothing there."

"But what about people who hide weapons in their cavities? I asked. I actually said "vagina" again, just to see him blush. "We're just not going there," he reiterated.

I asked him if he was looking forward to conducting the full-on pat-downs. "Nobody's going to do it," he said, "once they find out that we're going to do."

In other words, people, when faced with a choice, will inevitably choose the Dick-Measuring Device over molestation? "That's what we're hoping for. We're trying to get everyone into the machine." He called over a colleague. "Tell him what you call the back-scatter," he said. "The Dick-Measuring Device," I said. "That's the truth," the other officer responded.

The pat-down at BWI was fairly vigorous, by the usual tame standards of the TSA, but it was nothing like the one I received the next day at T.F. Green in Providence. Apparently, I was the very first passenger to ask to opt-out of back-scatter imaging. Several TSA officers heard me choose the pat-down, and they reacted in a way meant to make the ordinary passenger feel very badly about his decision. One officer said to a colleague who was obviously going to be assigned to me, "Get new gloves, man, you're going to need them where you're going."

Jeffrey Goldberg offers the following summation of lessons learned. He is right on the money on the first two. But he misses entirely on his third lesson, demonstrating his deep axiomatic faith in the establishment's core-narratives du jour. See the Conclusion section which provides my own commonsensical summation that these "*terrorist plots*" are themselves a fabrication.

"I draw three lessons from this week's experience: The pat-down, while more effective than previous pat-downs, will not stop dedicated and clever terrorists from smuggling on board small weapons or explosives. When I served as a military policeman in an Israeli army prison, many of the prisoners "banged" contraband up their asses. I know this not because I checked, but because eventually they told me this when I asked.

The second lesson is that the effectiveness of pat-downs does not matter very much, because the obvious goal of the TSA is to make the pat-down embarrassing enough for the average passenger that the vast majority of people will choose high-tech humiliation over the low-tech ball check.

The third lesson remains constant: By the time terrorist plotters make it to the airport, it is, generally speaking, too late to stop them. Plots must be broken up long before the plotters reach the target. If they are smart enough to make it to the airport without arrest, it is almost axiomatically true that they will be smart enough to figure out a way to bring weapons aboard a plane."

--- <http://www.theatlantic.com/national/archive/2010/10/for-the-first-time-the-tsa-meets-resistance/65390/>

Note: The image above is for illustrative purpose only. It is NOT from an AIT scanner.

## **Postscript-2: Statement of Enhanced Pat-downs from TSA's own BLOG**

'You may have read about TSA implementing enhanced pat downs as part of our layered approach to security. Using the latest intelligence, TSA constantly updates our screening procedures to stay ahead of those who wish to do us harm and keep the skies safe for the flying public. When developing our security procedures, we use input from across the agency, including our Offices of Intelligence, Privacy, and Civil Rights and Liberties.

To add some perspective, TSA has used pat downs since our agency started federalizing checkpoints in 2002. They're an effective way of helping us keep dangerous items such as weapons or improvised explosive devices off of planes.

So, what might cause you to receive a pat-down? Passengers may receive a pat-down in a number of circumstances: to resolve an alarm at a walk-through metal detector; if an anomaly is detected during screening with advanced imaging technology; or during random screening. Passengers who opt out of enhanced screening such as advanced imaging technology will receive an equivalent level of screening to include a thorough pat-down. Remember, you can always request to be screened in a private area.

You shouldn't expect to see the same security procedures at every airport. Our security measures are designed to be unpredictable and are constantly assessed and updated to address evolving threats.' ---  
<http://blog.tsa.gov/2010/08/enhanced-pat-downs.html>

**Postscript-3 A closer look at an Image from the AIT (Advanced Imaging Technology)  
Body-scan machine vs. photoshop**

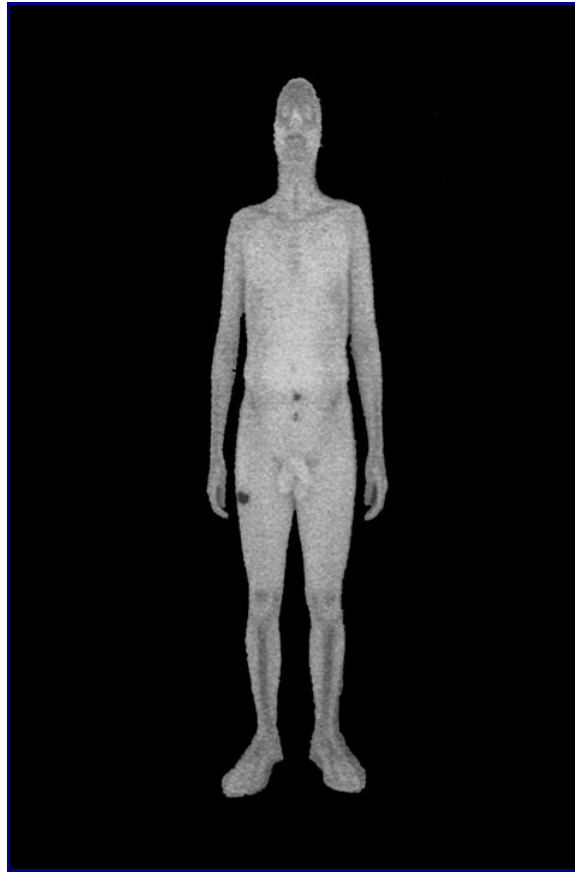

Caption The “Dick-Measuring Device”. Portrait of an Artist, Self-Image by John Wild taken with Backscatter X-ray fully-body scanner at Manchester Airport UK (Image Source)



Caption What can the 'naked' scanner really see? **A fabricated**

**image depicting a fabricated threat in this fabricated War on  
Terror** (Image original [Source](#), the image has now been  
removed)

Click [here](#) and [here](#) to verify that the image is fabricated; [here](#) to understand that terror threats are fabricated; and [here](#) to confirm that the War on Terror is also fabricated ab initio.

And you might sensibly well ask WHY?

Why do they need this 'War on Terror', the constant terror alerts, the myriad other global threats and crises – from financial to pandemic to global warming – all of which ***“look like a great ‘booming, buzzing confusion’ to use William James’ famous description of reality,”*** to literally bring mankind to its knees in submission?

Well, let's gallantly permit the elites' own mouthpiece, the Financial Times, to inform one in their own eloquent words:

'I have never believed that there is a secret United Nations plot to take over the US. I have never seen black helicopters hovering in the sky above Montana. But, for the first time in my life, I think the formation of some sort of world government is plausible. A “world government” would involve much more than co-operation between nations. It would be an entity with state-like characteristics, backed by a body of laws. The European Union has already set up a continental government for 27 countries, which could be a model. The EU has a supreme court, a currency, thousands of pages of law, a large civil service and the ability to deploy military force. So could the European model go global? There are three reasons for thinking that it might. First, it is increasingly clear that the most difficult issues facing national governments are international in nature: there is global warming, a global financial crisis and a “global war on terror”.' --- Gideon Rachman, And now for a world government, Financial Times, December 8 2008

**Postscript-4 What the officials say about anonymity and storage of body-scan images**

The UK Telegraph of March 03, 2010 cited above which reported the two female passengers being barred from flight after refusing body scan on religious and medical

grounds, also reported from the Manchester Airport spokeswoman:

*“Body scanning is a big change for customers who are selected under the new rules and we are aware that privacy concerns are on our customers' minds, which is why we have put strict procedures to reassure them that their privacy will be protected.”*

The UK Telegraph further stated:

'Last month, Transport Secretary Lord Adonis stressed that an interim code of practice on the use of body scanners stipulated that passengers would not be selected *“on the basis of personal characteristics”*. He stressed that images captured by body scanners are immediately deleted after the passenger has gone through and that security staff are appropriately trained and supervised.'

The following video of the trialling of the body-scan machine at Manchester Airport is revealing of the official UK Government position:

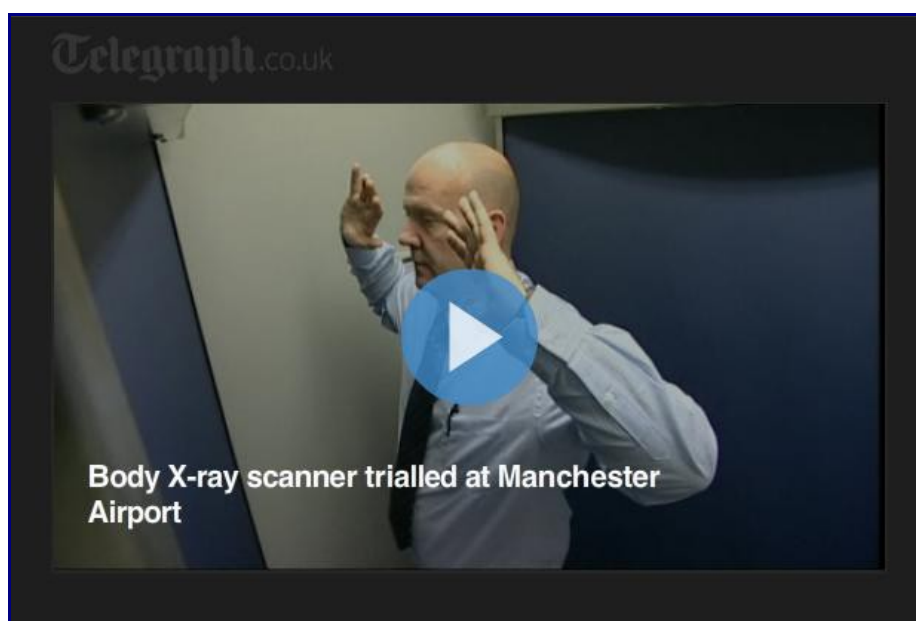

Caption Video Body X-ray scanner trialled at Manchester Airport - The Telegraph 13 Oct 2009. Click on the image to watch the Airport Spokesperson Sarah Barrett defend the trial of full body-scan.

The Manchester Airport Spokesperson Sarah Barrett in the above video stated the following:

'Firstly, we have made sure it's safe. So its been certified by the National Radiological Protection Board. There are part of the Health Protection Agency. And they are the people who certify medical equipment, medical x-rays fit for use. So they have given it their stamp of approval.

We have also made the process completely anonymous. So you will see from the images, you cannot, it is impossible to recognize an individual's face from the image.

They are not photographic images. They don't show skin color, they are not erotic, they are not pornographic, completely anonymous.

The operator viewing the image sits remotely, in a different part of the airport. They don't sit in the public search area, and the machine in which they are viewing the image doesn't have the capability to store images.

So the images can't be stored, you know recorded, forwarded on to anybody. They are literally on the screen for a few seconds and then they are off.

... We want to give our customers the experience that they want. We know they don't like security at the moment. They don't like the physical pat down. They tolerate it, because they want to be safe. But a lot of them are telling us that they would welcome an alternative. And that's why we are trialling this technology.'

--  
<http://www.telegraph.co.uk/news/newsvideo/6316975/Body-X-ray-scanner-trialled-at-Manchester-Airport.html>

As if the Image from the *"Dick Measuring Device"* in Postscript-3 above and mainstream news reports aren't prima facie evidence of the disaffirmation of the official narratives of the in-capabilities of the AIT body-scanners, the following US headline **'Feds admit storing checkpoint body scan images'** in CNET News of August 4, 2010 is outright evidence of the official deployment of public-deception alongside the body-scanners:

'For the last few years, federal agencies have defended body scanning by insisting that all images will be discarded as soon as they're viewed. The Transportation Security Administration claimed last summer, for instance, that ***"scanned images cannot be stored or recorded."***

Now it turns out that some police agencies are storing the controversial



images after all. The U.S. Marshals Service admitted this week that it had surreptitiously saved tens of thousands of images recorded with a millimeter wave system at the security checkpoint of a single Florida courthouse.' -- [http://news.cnet.com/8301-31921\\_3-20012583-281.html](http://news.cnet.com/8301-31921_3-20012583-281.html)

While EPIC has filed a lawsuit to suspend the deployment of body scanners at US airports, they are up against the empirical state policy to create police-state USA to protect Americans from terrorists, like the UK and the EU. Therefore, all organs of state officially support that policy. Hence, EPIC's principled arguments will most assuredly remain ineffectual in practice:

'On July 2, 2010, EPIC filed a petition for review and motion for an emergency stay, urging the District of Columbia Court of Appeals to suspend the Transportation Security Administration's (TSA) full body scanner program. EPIC said that the program is *"unlawful, invasive, and ineffective."* EPIC argued that the federal agency has violated the Administrative Procedures Act, the Privacy Act, the Religious Freedom Restoration Act, and the Fourth Amendment. EPIC cited the invasive nature of the devices, the TSA's disregard of public opinion, and the impact on religious freedom.' --- [http://epic.org/privacy/body\\_scanners/epic\\_v\\_dhs\\_suspension\\_of\\_body.html](http://epic.org/privacy/body_scanners/epic_v_dhs_suspension_of_body.html)

### **Postscript-5 Miss USA Susie Castillo Sexually Assaulted TSA Style – Dallas Airport April 21, 2011**

**Update June 15, 2011:** Susie Castillo is taking her challenge to the next level: Former Miss USA, Ralph Nader, Privacy Advocates Fight Full Body Airport Scanners and Invasive Pat-Downs, [http://www.democracynow.org/2011/6/13/former\\_miss\\_usa\\_winner\\_and\\_ralph](http://www.democracynow.org/2011/6/13/former_miss_usa_winner_and_ralph)



Excerpted From Susie's BLOG:

'My TSA Pat Down Experience

Dear Friends,

To be quite honest, I almost didn't post this video and blog because I kept asking myself, "Am I just being a baby?" I'm also not one to stir up controversy. In fact, I do my best to live a very positive and healthy life. However, in the situation I'm about to describe, I felt truly violated and believe I should let my voice be heard. Ultimately, I hope others will do the same. Mahatma Gandhi famously said, "Be the change you want to see in the world." So, that's what I'm doing by sharing this experience:

On my overnight, 11-hour flight back to Los Angeles last week after hosting the red carpet premiere for "Fast Five" in Rio De Janeiro, I connected in Dallas Fort Worth (DFW) where I had the misfortune of being selected to go through one of those full body scanners that emits radiation. Now, if you don't fly very often, you might not worry about it. But I'm a frequent flyer and don't wish to be irradiated more than I already am on flights (we get a pretty large dose of radiation while flying due to our proximity to the sun; the longer your flight, the more your radiation exposure) and in life in general (we're exposed to radiation all day every day; it's called "background radiation"). So I will always "opt out" of going through these body scanners, especially since the long-term effects of radiation are quite well documented: it mutates our cells, often in irreversible ways, and causes cancer. I'm all set with that!

Anyway, after “opting out,” I proceeded to follow a very nice older female TSA employee to the “pat down” area. It was an inconvenience, but I thought, “No biggie. I just went through this at LAX for the first time and it wasn’t too bad, so let’s just get it over with.”

Well, this pat down was completely different. It was MUCH MORE invasive than my first one at LAX, just a week before. To say that I felt invaded is an understatement. What bothered me most was when she ran the back of her hands down my behind, felt around my breasts, and even came in contact with my vagina! Honestly, I was in shock, especially since the woman at LAX never actually touched me there. The TSA employee at DFW touched private area 4 times, going up both legs from behind and from the front, each time touching me there. Was I at my gynecologist’s office? No! This was crazy!

I felt completely helpless and violated during the entire process (in fact, I still do), so I became extremely upset. If I wanted to get back to Los Angeles, I had no choice but to be violated, whether by radiation or a stranger. I just kept thinking, “What have I done to deserve this treatment as an upstanding, law-abiding American citizen?” Am I a threat to US security? I was Miss USA, for Pete’s sake!

... I have never felt more violated in my life than I did that morning at DFW, and I’ve heard of others feeling the same way after these “pat downs.” Just a couple weeks ago, a video of a six-year-old girl being patted down by TSA made headlines. Talk about unjust and unacceptable. So I decided to speak to a TSA supervisor about how I felt, and make a video about what happened to post on my blog.

This “pat down” is a total violation of our rights (we shouldn’t be searched this way without probable cause or a search warrant), therefore I will be filing a complaint via phone, online and also in writing with the TSA to complain each and every time for as long as the TSA is violating my rights. I’m 100% against it, and if you care about your freedom, you should be too. This is precisely the kind of unjust search and seizure our Constitution was created to protect us from.

... Here’s the video I made right after going through the invasive, unjust, unconstitutional and ineffective “pat down.” Honestly, I don’t like that I’m

putting myself out there like this, but I wanted you to know what happened, what I was feeling, and that I hope you, too, will speak up if and when this happens to you. We shouldn't be giving up our liberties as Americans because of our fears. The government can't keep us safe. No matter how much they promise us they can, it's a false promise.

### Watch Video

And here's the TSA compliment/complaint card that I filled out and mailed to the DFW TSA. I'll be filling one out each time I get "patted down" at an airport. Hopefully tears won't be involved every time:

 Transportation Security Administration	
Help us improve our customer service by completing and returning this card to a TSA drop-box or to a TSA supervisor or manager.	
Date: <u>4/21/11</u>	Time: <u>7:15 AM</u> Airport: <u>Dallas Fort Worth</u>
Date/Time of Travel: <u>(see above)</u>	Airline & flight number: <u>AA 2411</u>
Checkpoint/area of airport: <u>D gates</u>	TSA Employee(if known): _____
COMPLIMENT/COMPLAINT(summarize): <u>After opting 'out' of going through the body scanner due to health reasons, I found the 'pat down' to be INCREDIBLY invasive. My private area was grazed 4 times! Is this necessary? I feel totally violated and degraded, and started crying after the process was over. I would like to express how deeply upset I am about this and, as a frequent flyer, would like to see this violation of my rights changed.</u>	
Passenger's Name: (optional, so we can follow-up with you) <u>Susie Castillo</u>	e-mail: _____
(Optional) Phone number _____	
NOTE: If you wish to seek payment from TSA for damaged or missing items, you must file a claim on-line at <a href="http://www.tsa.gov">www.tsa.gov</a> or through the TSA Contact Center at <b>1-866-289-9673</b> .	
<small>Collection of this information is made under 49 U.S.C.114(e) &amp; (f). Providing this information is voluntary. TSA will use the information to improve customer service and may share it with airport operators for this purpose. For more information, please consult DHS/TSA 006 Correspondence and Matters Tracking Records. It will take no more than 5 minutes to complete this form. An agency may not conduct or sponsor, and a person is not required to respond to, a collection of information unless it displays a valid OMB control number. The control number assigned to this collection is OMB 1652-0036, which expires 1/31/2012. Send comments regarding this burden estimate or any other aspect of this collection of information including suggestions for reducing this burden to TSA/601 S. 12<sup>th</sup> Street, Arlington, VA 22202. ATTN: PRA 1652-0036.</small>	

### CLICK TO ENLARGE

Like I say in the video, we as individuals have to speak up and protect our liberty. If you feel like your Constitutional rights have been violated by the TSA, please follow my lead and contact your Congressional representatives. Let them know that if they want your vote they must stand up for our rights. ...' --- <http://susiecastillo.net/blog/2011/4/25/my-tsa-pat-down-experience.html>

Thank you Susie Castillo for speaking out so courageously as a citizen. However, ***“Let them know that if they want your vote they must stand up for our rights.”*** - isn't going to work. Please see [Not-Voting is a 'YES' vote to Reject a Corrupt System which thrives on the facade of Elections and Democracy!](#) and [Flashback: From President George W. Bush to President Barrack Obama – More faces change, more they remain the same!](#)

**Postscript-6 CNN Meredith Jessup Report: 'TSA Behavior Indicator: Anyone who Displays arrogance and verbally expresses contempt for the screening process' is a possible terrorist**

[Watch Video](#)

<http://www.youtube.com/watch?v=jVyidvyjXVc>

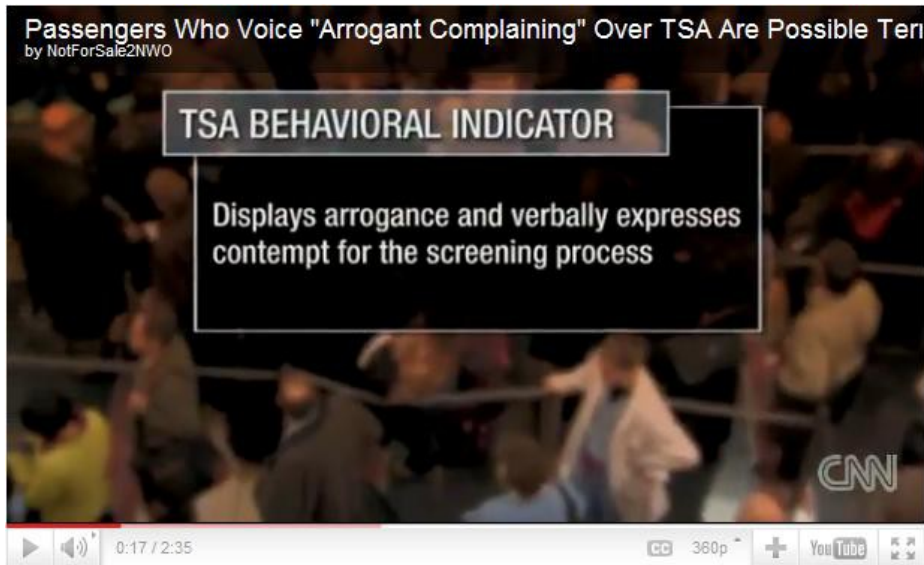

**Postscript-7 May 27, 2011 An Open Letter to State Officials in Response to the DOJ Threat Letter ("WE TOUCH YOUR PRIVATES OR YOU DON'T FLY Dept. of Justice letter threatens TSA will cancel flights in Texas if agents are not allowed to touch passengers' private areas" Press Release Office of Texas State Representative David Simpson May 25, 2011)**

'An Open Letter to State Officials in Response to the DOJ Threat Letter

Dear Sirs:

Today you received a letter from Mr. John E. Murphy, United States Attorney, Western District of Texas in regards to House Bill 1937 currently up for consideration by the Senate.

In his letter, Mr. Murphy made a veiled threat to the elected officials of Texas that if we move to protect the constitutional rights of our citizens, the TSA could shut down flights to and from Texas airports.

175 years ago in the first battle of the Texas Revolution against Mexico, a small band of Texans stood in defiance at Gonzalez, turning back the attempt to deprive them of their weapon of defense, a single cannon.

Gentlemen, we find ourselves at such a watershed moment today. The federal government is attempting to deprive the citizens of Texas of their constitutional rights under the Fourth Amendment of the United States Constitution and Article 1, Section 9 of the Texas Constitution. If we do not stand for our citizens in the face of this deprivation of their personal rights and dignity, who will?

Time is critical. If the bill does not pass the Senate tonight it may very well be dead until the next legislative session. Meanwhile, our wives, our children, our mothers and grandmothers, will be rudely violated by federal employees out of control.

My response to Mr. Murphy's factually inaccurate letter follows. Please give this matter your immediate attention.

For Texas And Liberty!

David Simpson

**John E. Murphy, U.S, Attorney letter states:**

**TSA False Statement:** "As you no doubt are aware, the bill makes it a crime for a federal Transportation Security Official to perform the security screening that he or she is authorized and required by federal law to perform."

**Truth:** HB 1937 states that a person commits an offense if, while acting under color of the person's office or employment without probable cause, performs a search for the purpose of granting access to a publicly accessible building or form of transportation and intentionally, knowingly, or recklessly touches the anus, sexual organ, buttocks or breasts of the other person. We know of no federal law that requires this kind of search without probable cause.

**TSA False Statement:** "The proposed legislation would make it unlawful for a federal agent such as a TSO to perform certain specified searches for the

purpose of granting access to a publicly accessible building or form of transportation. The provision would thus criminalize searches that are required under federal regulations in order to ensure the safety of the American public.”

**Truth:** HB 1937 grants a defense to prosecution for an offense that the actor performed pursuant to and consistent with an explicit and applicable grant of federal statutory authority that is consistent with the United States Constitution.

So, if there is actually statutory authority consistent with the Constitution, all an agent must do is bring that statute to the attention of the court. In other words, Texas needs to tell the Department of Justice, “You show me yours (statutory authority) and I’ll show you mine (privates)”

**TSA False Statement:** “The legislation also makes it crime for a public servant, as defined in the bill, to deny or impede another person in the exercise or enjoyment of any right or privilege, knowing that the public servant’s conduct is unlawful. As a result, it appears that the intent of the bill is to preclude a TSO from turning away from the secure area of an airport someone who otherwise would have been subjected to a pat down as a condition of entry.”

**Truth:** Actually, it is already current law in Texas that public servants cannot intentionally deny or impede another person in the exercise or enjoyment of any privilege, power, or immunity, knowing the public servant’s conduct is unlawful. TSO would only be precluded from touching specific private areas of an individual without probable cause to believe the person committed an offense. The bill will not prohibit a TSO from using administrative screening methods with metal detectors, scanners, explosive sniffing dogs or pat downs that do not include touching the travelers anus, breasts, sexual organs, or buttocks.

**TSA False Statement:** The effect of this bill, if enacted, would be to interfere directly with the Transportation Administration’s (TSA) responsibility for civil aviation security. 49 U.S. C Section 114 (d); 6 U.S.C. Section 202 (1). Congress has directed the Administrator of TSA to take ‘necessary actions to improve domestic air transportation security,’ 49 U.S.C. Section 44904(e), and directed him to “prescribe regulations to protect passengers

and property on aircraft . . . against an act of criminal violence or aircraft piracy.” Id. Section 44903(b). Congress has directed TSA to provide for “the screening of all passengers and property . . . before boarding,” in order to ensure that no passenger is unlawfully carrying a dangerous weapon, explosive, or other destructive substance. Id. Sections 44901(a), 44902(a), 114(e). If the Administrator determines that “a particular threat cannot be addressed in a way adequate to ensure. . . the safety of passengers and crew of a particular flight,” he “shall cancel the flight or series of flights.” Id. Section 44905(b)

**Truth:** Nowhere in the language cited is there statutory authority for a government agent to touch the breasts, anus, sexual organs, or buttocks of a traveler. And, no where in the Texas legislation does it prohibit that touching if there is probable cause to believe an offense has been committed. HB 1937 merely works on the premise that Texans don’t have to forfeit their dignity to exercise their right of free travel.

**TSA False Statement:** HB 1937 would conflict directly with federal law.

**Truth:** It is perplexing that the United States Attorney would make a statement saying one thing while citing examples that do not substantiate the remark. Either he intentionally misrepresented the truth, was unaware of the actual language of HB 1937, or has other statutes to validate his statement. No comment on the first two scenarios, but if the third scenario exists, then the defense to prosecution will apply and Americans will be made aware of the actions of their elected officials.

**TSA False Statement:** The practical import of the bill is that it would threaten criminal prosecution of TSA personnel who carry out the security procedures required under federal statutes and TSA regulations passed to implement those statutes. Those officials cannot be put to the choice of risking criminal prosecution or carrying out their federal duties. Under the Supremacy Clause of the United States Constitution, Texas has no authority to regulate federal agents and employees in the performance of their federal duties or to pass a statute that conflicts with federal law.

**Truth:** HB 1937 only threatens criminal prosecution if there is inappropriate touching and there is no federal statute consistent with the United States Constitution to do so. As elected officials, Texas legislators have taken an



oath to uphold both the U.S. Constitution and the Texas Constitution. In that capacity, they not only have authority to pass a statute that would reign in the daily violation of Fourth Amendment rights, they have a responsibility to do so.

**TSA Threat:** If HB 1937 were enacted, the federal government would likely seek an emergency stay of the statute. Unless or until such a stay were granted, TSA would likely be required to cancel any flight or series of flights for which it could not ensure the safety of passengers and crew.

**Truth:** The United States Attorney has thrown down the gauntlet. Either Texas backs off and continues to let government employees fondle innocent women, children and men as a condition of travel, or the TSA has the authority to cancel flights or series of flights.

Homeland Security Secretary Janet Napolitano says, "Well, actually, very, very, very few people get a pat-down."

Atlanta TSA spokesman Jon Allen told us (Hot Air) that during March, 3 percent of air passengers were subject to a pat-down. The TSA collects this data by monitoring "data from select airports throughout the year," he wrote in an email. That number is "consistent with that of previous time periods."  
...

So, 97 percent of people who go through the nation's airports do not go through these offensive searches. And yet, a United State's Attorney warns that flights to Texas could be shut down because TSA would not be able to ensure the safety of passengers and crew if agents could not touch the genitals of the other 3 percent.

Someone must make a stand against the atrocities of our government agents. As Reagan said, "***If not us, who? And if not now, when?***"

Source URL Open Letter ( <http://davidsimpson.com/blog/?postid=70> )

I would first like to appreciate the courage of this bold Texas Representative, Mr. David Simpson. Thank you Sir!!

However, had the good Representative of the peoples of Texas read Project Humanbeingsfirst's Body Scan Alert before writing his excellent exposition of dissent, he

surely would have outright challenged the entire state of fiction of this “War on Terror”, rather than merely the degree to which it is tolerable to the State of Texas. Indeed, I dare to surmise that were Mr. David Simpson properly informed that it is not just that **“Someone must make a stand against the atrocities of our government agents”**, but that someone must make a stand against the ruling oligarchy that is ruining the United States of America through their government errand boys for their own private globalist agenda, and that these vile indignities being inflicted upon the public at American and other Western airports are but a mere link in the chain of fear based Pavlovian conditioning of the public, he would surely have challenged the whole body of false axioms upon which the entire geometry of “War on Terror” is fabricated.

As Mr. Simpson truthfully observes on his website: **“David Simpson was grateful to be elected State Representative of House District 7 in 2010”**, a sentiment which he has already shown to be genuine by boldly standing up for the dignity of his peoples to the degree that he has, I have no doubt that he would be just as fearless in resisting the enactment of this entire Alice in Wonderland fiction to safeguard the larger interests of his own nation.

To humbly assist in that endeavor, this report has been emailed to the specified contact person to forward to the good Representative: [Kathi.Seay@house.state.tx.us](mailto:Kathi.Seay@house.state.tx.us)., Tel: 512-463-0750.

**Postscript-7a June 16, 2011 Forbes: Quote of the Day, After Texas State Official 'Left Sore' From a TSA Patdown “You’ve got to have a reason to go to third base.”**

Texas Rep. David Simpson, author of an anti-groping bill that would make TSA patdowns a misdemeanor. This was his response after Texas Public Utility Commission chairman Barry Smitherman was “punished” with a TSA patdown that left his private parts “sore,” after opting out of a whole-body-imaging scan in New Orleans. The anti-TSA-groping bill failed to pass in the Texas Senate after the feds threatened to cancel all flights out of Texas, but it may sputter back to life in the state’s current special session.

Source

Watch Video

<http://www.youtube.com/watch?v=AKE98sJpGig>



**Postscript-8 September 07, 2011 The travails of Amy Alkon at the hands of TSA: [My letter to Amy Alkon](#)**

**To:** Amy Alkon, [advicegoddess.com/goddessblog](http://advicegoddess.com/goddessblog) [AdviceAmy@aol.com](mailto:AdviceAmy@aol.com)

**From:** [Project Humanbeingsfirst.org](http://ProjectHumanbeingsfirst.org)

**Subject:** Re: Don't Give The TSA An Easy Time Of Violating Your Rights

**Date:** Wed, Sep 7, 2011 at 4:43 AM

“On March 31st, when I came through the metal detector and realized that everyone in the TSA line to my United flight was getting searched, I got teary. I was teary at the prospect of being touched by a government worker ... I sobbed my guts out. Loudly. Very loudly. The entire time the woman was searching me. Nearing the end of this violation, I sobbed even louder as the woman, FOUR TIMES, stuck the side of her gloved hand INTO my vagina, through my pants. Between my labia. She really got up there. Four times. Back right and left, and front right and left. In my vagina. Between my labia. I was shocked -- utterly unprepared for how she got the side of her hand up there. It was government-sanctioned sexual assault. ... [September 07, 2011]

Magee is looking for me to pay her \$500K, apologize to her, and take down my blog item about her -- because I had the nerve to exercise my First Amendment rights and complain after she jammed her hand sideways into my vagina four times. " --- [Amy Alkon \(graphic description of violation cached\)](#)

'My client entered Terminal Six at Los Angeles International Airport (LAX) and exercised her right to opt out of the TSA's body scan. Your client, in apparent retaliation for my client's refusal to blindly submit to the TSA's authority, jammed her fingers in between my client's labia -- not once, not twice, but four times. My client characterized Ms. Magee's actions as "rape." As a result, your client seems to believe that she is entitled to \$500,000.' --- [Marc Randazza, attorney for Amy Alkon, September 06, 2011](#)

Hello,

I am sorry to hear of your experience.

There is evidently some misconception regarding who is actually doing the 'rape' vs. who is ordering it, and why.

While you were intruded upon by the TSA, they are only 'following orders' no differently than the Third Reich's henchmen followed orders. However, at Nuremberg, the foot-soldiers who did all the killing (and dying) were only starved out in the concentration camps by Eisenhower. There were no legal charges brought against them, even though, they did much of the killing (and dying) in the killing fields of Europe. The victor's justice primarily ensured that those who ordered the "*supreme international crime*" were hanged, creating an international precedent for victor's justice. Some argue that there is no reason to prepend "victor's" before it. I do it only to imply the impracticality of administering justice unless one is a victor and wields the upper hand, and the hypocrisy of it. Namely, that only the losers are hung by artfully crafting the definition of how crime is defined such that the victors' crimes are not considered crimes, only self-defence and collateral damage of war.

**The Airport intrusive patdowns cannot be understood in isolation from**

**the two parallel contexts of "imperial mobilization" and "police state" which cradle that act.**

**The pat-downs are merely obedience training for the American public.**

Remember, TSA is authorized by the Homeland Security, which in turn is authorized by the US Government, to subject its denizens to this – TSA is not doing it on their own. It isn't clear to me whether deliberately inducing emotional traumas, which to the victims do appear rape-like, among the passengers, especially women, is part of the unwritten coercion policy of the Government to get objecting peoples to accept the body-scan! It just seems extraordinary to me that without tacit support, and directives from higher-ups, that anyone in their right mind would do such molestation in such a public place with everyone watching.

If you wish to understand how the various pieces fit together, you may find my report pertinent:

[Body-scan Alert - Not Suffering Indignities at Airports](#)

Zahir Ebrahim

Project Humanbeingsfirst.org

Also posted as comment for Amy's article on September 7, 2011 5:24 AM:  
[http://www.advicegoddess.com/archives/2011/04/26/make\\_it\\_tough\\_t.html](http://www.advicegoddess.com/archives/2011/04/26/make_it_tough_t.html)

## **References**

**Amy Alkon's Response article to my comment:**

[http://www.advicegoddess.com/archives/2011/09/07/obedience\\_train.html](http://www.advicegoddess.com/archives/2011/09/07/obedience_train.html)

**My letter to Amy Alkon's attorney Marc Randazza:** <http://print-humanbeingsfirst.blogspot.com/2011/09/letter-civilrights-tsa-lawsuit-randazza.html>

**Letter of Demand for \$500,000 by attorney for TSA agent (PDF):**

<http://humanbeingsfirst.files.wordpress.com/2011/09/cacheof-tsaalkonthedalamageeltr-via-techdirt-com-letter-july-12-2011.pdf>

**Marc Randazza's response letter to the Demand by TSA agent (PDF):**

<http://humanbeingsfirst.files.wordpress.com/2011/09/cacheof-randazza-responsetotsaagentlegalthreat-via-techdirt-com-letter-sept-6-2011.pdf>

**My article September 09, 2011: America: TSA vagina probe and you**

**Elie Mystal's Testical Probe September 09, 2011: Two Minutes of Terrorist Triumph: Alone With the TSA**

**Postscript-9 September 09, 2011 My article: America: TSA vagina probe and you**

[Watch Video](#)

<http://www.youtube.com/watch?v=ZCya5vEJNJQ>

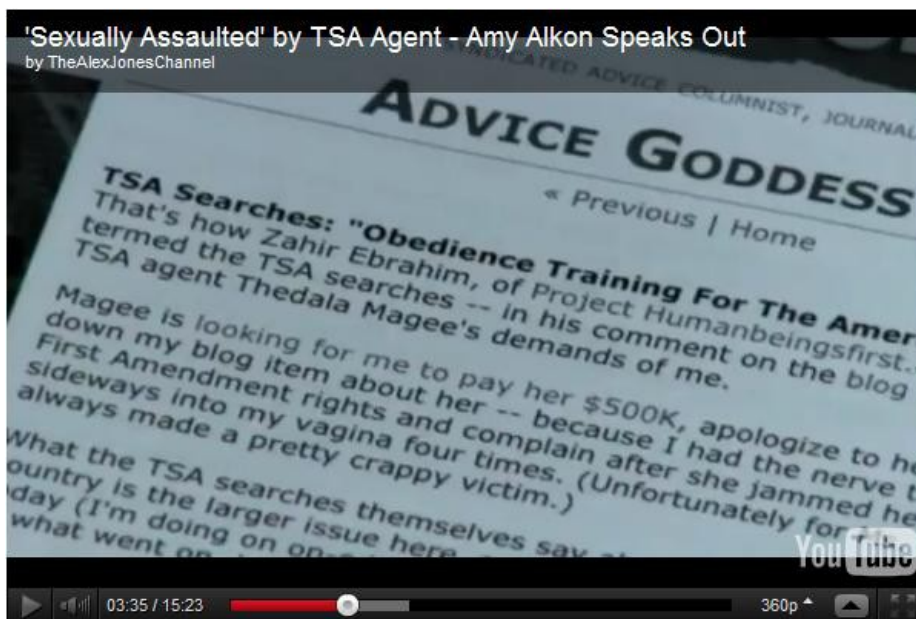

The Airport intrusive patdowns cannot be understood in isolation from the two parallel contexts of "imperial mobilization" and "police state" which cradle that act. The pat-downs are merely obedience training for the American public.

It appears that in this particular instance, there was no choice for the passengers – be exposed to radiation and full nudity via X-ray body-scan, or, feel the pain of sexual groping and molestation.... LAX, United Airlines.

The grotesquely absurd demand by the TSA agent seeking \$500,000 from Amy Alkon must be resoundingly defeated because I suspect it is not just the pot calling the kettle black (*ulta chore kotwal ko dante*), not just a TSA agent suing Amy for her loud complaining, but the TSA itself is suing Amy, DHS is suing Amy, Police-state is suing Amy, as part of silent acceptance of obedience training of Americans.

I suspect that this is another testing of the waters by the hectoring hegemony, a barometer, a rain gauge, of how successful their obedience training has been thus far --- will the Americans even accept this vile absurdity that after the state shoves its hand inside the American vagina, it prohibits complaining about it and the majority of people accept it?

The intimidation of lawsuit is also intended to be precedent setting to ensure that the majority of the public do not revolt because it will hit them directly in the pocket-book.

Remember, indoctrination and obedience training is primarily for the masses. The public already has accepted all the rest of 'war on terror' absurdities which have been heaped upon them since 9/11:

Convince People of Absurdities and get them Acquiescing to Atrocities: The Enduring Power of Machiavellian Political Science

'War on Terror' is not about 'Islamofascism' – Please get with the real agenda you people!

10th Anniversary: 9/11 and Imperial Mobilization

Hijacking Islam for Imperial Mobilization

Please promulgate this issue widely. Publish it if you have a website. Highlight Amy Alkon's case if you are a writer. Donate funds to her legal defense team if you have the capacity. For all these acts, you will actually be helping protect your own loved ones' vaginas and balls. And most importantly, take Amy's own advice for the best way you can support her, by standing up for your own self: ***"Thank you so much -truly appreciate that. And my wonderful attorney has the legal defense handled, but what I hope people will do is make a stand for our rights. Many, many thanks.-A"***

**Postscript-10 September 10, 2011 My response to Elie Mystal's 'Two Minutes of Terrorist Triumph: Alone With the TSA'**

From: Project Humanbeingsfirst.org <humanbeingsfirst@gmail.com>

Date: Sat, Sep 10, 2011 at 12:41 PM

Subject: America: TSA vagina/testicle probe and you

To: tips@abovethelaw.com

In response to the vile molestation suffered by Elie Mystal: [Two Minutes of Terrorist Triumph: Alone With the TSA](#) , the [following](#) sheds light on the 'system architecture' of which this is merely a tiny component.

As villainous as these molestations are, they can no more be understood in isolation from "imperial mobilization" and obedience training to accept police state, for "World government could only be kept in being by force.", than the function of a wire can be understood in isolation from the rest of the system to which it belongs and without which, the entire system with thousands of wires would still fail.

This is the second time this week that I have to express this sentiment related to TSA excesses and I only wish this was to be the last time: "I am sorry to hear of your experience."

The solution is not to accept such indignities in the first place for lamenting after the fact does little to mitigate the trauma, the anger, and the disgust. The success of this obedience training is precisely measured by the fact that of this [powerless] sentiment expressed by Elie Mystal: **'But I did not appreciate it. I wanted to say, "The next time I use an epic tragedy as a trumped up excuse to molest you, we'll see how relaxed you are." Of course, I didn't say that, but I did flash him my "if you were any other man, I'd kill you where you stand" look..'**

For the next time you travel: [Body-scan Alert - Not Suffering Indignities at Airports](#)

Zahir Ebrahim,

Project Humanbeingsfirst.org



## Postscript-11 September 10, 2011 My Open Letter via email

From: Project Humanbeingsfirst.org <humanbeingsfirst@gmail.com>

Date: Sat, Sep 10, 2011 at 12:52 PM

Subject: Fwd: America: TSA vagina/testicle probe and you

To: worldwide distribution

Can the mosques, churches, synagogues, NGOs, civil rights organizations, professors, lawyers, doctors, scholars, newsmedia, kindly take a preemptive public stand that is not just of meaningless lip-service and unfortunate lament – for, the next time I have to express my regret, it may be for your wife, daughter, child, grandmother.... or you.

The silence is criminal. Adopt the Solon principle and one can change the destiny of a nation, and a people.

Solon, the Athenian law giver, according to Plutarch's Lives, when asked which city he thought was well-governed, said: **“That city where those who have not been injured take up the cause of one who has, and prosecute the case as earnestly as if the wrong had been done to themselves.”**

Thank you for your time,

Zahir Ebrahim,

Project Humanbeingsfirst.org

### Conclusion

As evidenced in the postscripts above, the vile TSA indignities are being escalated upon the American public with increasing villainy, and with chutzpah to boot. Those sexually assaulted under legal cover can't even complain after the fact of molestation without being threatened with a lawsuit for complaining! Even public officials are not immune from TSA's genital probe – all under the rubric of 'war on terror' in which the state is terrorizing its own denizens into submission by systematic obedience training.



These intrusive measures have little to do with keeping the childishly insecure Americans and the poor orphans of the beleaguered Western Anglo-Saxon nations safe from the Islamofascist terrorists, and more to do with their systematic Pavlovian conditioning in increasingly draconian stages to get them to willingly accept big brother.

One arrives at this logical conclusion based on the self-evident observation that the Anglo-American governments are keen on ushering in big brother under the pretext of fighting terror.

But as Aldous Huxley had observed in 1961 at UC Berkeley in his speech titled **The Ultimate Revolution:**

*“it seems to me that the nature of the Ultimate Revolution with which we are now faced is precisely this: that we are in process of developing a whole series of techniques which will enable the controlling oligarchy who have always existed and presumably always will exist, to get people actually to love their servitude!”*

Only with the knowledge of social and political sciences can one even begin to appreciate the social engineering purposes of these otherwise rather senseless and vilely intrusive measures in which all organs of state, at both local and federal levels, in all Western nations, are participant.

**Therefore, it follows that, only individual peoples in large numbers, courageous peoples refusing all indignities at Airports, who can practicably overturn this measure.**

While no sensible person espousing traditional modesty would recommend stripping down to a bare poodle like what Tammy Banovac did at Oklahoma City airport, or the bikini girl from Los Angeles Corinne Theile routinely does, and evidently TSA and Homeland Security have no problem with women baring it all while enjoying their own degradation and making light of it, finding commonsense ways of demonstrating the immorality, the perversity, the unconstitutionality, and outright absurdity of these vile TSA measures is most essential. Like what the two young Harvard Law school students did. Congressman Ron Paul



No X-ray needed here: Corinne Theile poses in her bikini at LAX in protest of TSA security checks

submitted a Bill in the US Congress which sensibly argues that if it is a crime for a private individual to grope and molest you, it should be a crime for Federal employees to grope and molest you as well! Nothing can be expected to come out of it as the entire Congress is part of the same problem-space and entirely responsible for police-state USA in the same measure that they are entirely responsible for America's perpetual 'War on Terror' and the passages of its Patriot and other Enabling Acts. Individual Congressman pitching the lofty Jeffersonian notions of Liberty of yesteryear cannot do a thing unless they can get majority vote on their Bill. We all know empirically where the *Janus faced* Congress' primary allegiances lie.

Just witness this [Reuters report](#) of May 26, 2011 with the self-explanatory headline ten years into the fabricated "War on Terror", **Congress votes to renew anti-terrorism steps:**

'WASHINGTON (Reuters) - Congress, racing the clock and rejecting

demands for additional safeguards of civil liberties, passed a bill Thursday to renew three expiring provisions of the anti-terrorism Patriot Act. With the provisions set to expire at midnight Thursday (0400 GMT on Friday), the Republican-led House of Representatives approved the measure, 250-153, just hours after it cleared the Democratic-led Senate, 72-23.' (cached [here](#))

Therefore, it is entirely up to individual peoples to take their liberty, their dignity, and their sensibilities, into their own hands.

Unless individual public protest spreads quickly however, unless more and more people increasingly behave like the courageous San Diegan John Tyner, and the measured but persistent traveler Matt Kernan, it will become *fait accompli* as it gets drawn out. Because, good people will eventually give up after their initial flurry of protesting these physical and emotional assaults on their bodies. The big brother government is counting on exactly that! They have already proclaimed that they don't do policy based on "*focus groups*"!

If you still remain unconvinced that the terrorist threat is fabricated by the State itself, that your government is run by psychopathic liars who have taken America from lies to lies towards its calculated demise as a sovereign nation-state, that its escalating security mantra followed by its escalating totalitarian measures is entirely for training you to acquiesce to the gradual loss of your liberties in the name of security, then by all means, go through the *"Dick Measuring Device"*, and bend over for the anal probe to pay homage to the Fourth Reich each time before you travel, while also recalling the pragmatic words of your own founding father: ***"those who trade their essential liberties for some temporary safety deserve neither!"***

Do you not remember that your own government had told you that the terrorists hit America on 9/11 because they hated your freedoms? Well, the terrorists seemed to have succeeded beyond their own wildest expectations in taking it all away from you so easily!



And as you marvel at the remarkable powers of persuasion of *Ali Baba* to screw the entire Western world with nothing but some primitive box-cutters, a pair of well-worn tennis shoes, and fancy underwear, do keep looking down the neckline of that buxom 38-D sitting next to you on the plane/train/bus for any signs of restlessness, for she could be carrying some modified IUD implants which the TSA's surface gropes failed to detect. But Perhaps you might be more concerned with

that suspicion falling upon your own wife and daughter? For, not just at airports, they could be pulled over at the shopping mall next and ordered to bare it all or go through that body-scanner! Watch this video if you don't believe that your lovely six year old child can ever be designated a threat to "national security" and groped up the wazoo in this diabolical calculus of America's obedience training.

TSA, at least for now, has openly admitted to glossing over certain inner sanctums of the public's bodies, perhaps waiting for that convenient "crotch area bomber" or the "breast implant bomber" to trigger willing compliance with that final loss of human dignity. As already reported by CNN in September 2010, **10,000 TSA employees, one sixth of the agency's workforce, get secret clearances**, to ensure that very outcome! It will be coming to your Safeway and Macys soon enough.

Once you become a creature of habit in the police-state whereby all big brother absurdities

make sense to you, where you routinely count 2 + 2 equal 5, you have arrived in the world of "1984". Watch the movie to remind yourself what you are automatically accepting for tomorrow when you stand for these vile indignities today. Recall that you began yesterday with stupidly standing in line with your dirty shoes in hand to keep you safe. Now you stupidly open up your private parts for strangers to grope, or image by exposing you to cumulative deadly radiation, to keep you safe! If you don't act today, prison-state in full surveillance society West will become your safest zeitgeist. This is precisely what's been planned long before 9/11, because, as rationalized by the philosopher of one-world government in his 1952 book *The Impact of Science on Society*, "**World government could only be kept in being by force**" under the scientific dictatorship of the elite. The global scientific dictatorship in the making however has other existential ramifications besides just the police-state and full surveillance society.

**Thank you**

**Zahir Ebrahim | Project Humanbeingsfirst.org**

**Short URL:** <http://tinyurl.com/TSA-Obedience-Training>

**Source URL:** <http://print-humanbeingsfirst.blogspot.com/2010/11/body-scan-alert-not-suffering-indignity.html>

First Published November 06, 2010

---

## **APPENDIX: My letter to Amy Alkon's attorney Marc Randazza**

**To:** Marc Randazza, First Amendment and Civil Rights Law, Randazza Legal Group, randazza.com

**From:** [Project Humanbeingsfirst.org](http://ProjectHumanbeingsfirst.org)

**Date:** Wed, Sep 7, 2011

**Dear Mr. Marc Randazza,**

Hello.

I am writing you as a concerned denizen of the United States, and a human being, to first thank you for taking up the legal case of Amy Alkon whom I only heard about last night from an article on Forbes ( <http://forbes.com/sites/kashmirhill/2011/09/06/female-blogger-threatened-with-a-defamation-suit-for-blogging-about-tsa-rape/> ).

The second reason for writing you is as a principled activist and researcher, I would like to leave you a link to my report which you may find pertinent: Body-scan Alert - Not Suffering Indignities at Airports

<http://print-humanbeingsfirst.blogspot.com/2010/11/body-scan-alert-not-suffering-indignity.html>

If I possessed the legal wherewithal, I would have filed a denizen's Good Samaritan law suit "suo moto" on multiple fronts myself many years ago directly on the head of the rotting fish. Solon, the Athenian law giver, according to Plutarch's Lives, when asked which city he thought was well-governed, said:

“That city where those who have not been injured take up the cause of one who has, and prosecute the case as earnestly as if the wrong had been done to themselves.”

That wisdom unfortunately has been given little educational currency in modernity which is being assaulted full spectrum for the purpose of obedience training the masses. The assault is primarily intellectual, and its effects are visible physically, inter alia, the TSA inflicted vulgarities. Other effects are the war on terror, the financial collapse. The interlinked myriad effects have the same first cause.

My redressal pursuit therefore would not primarily be to the rotting tail of the fish which is TSA, but to principally its head from which all the rot follows, and would rope in the entire fish --- which is very large, very compartmentalized, but still inter-connected in one body!

I am given to understand by my study of the Nuremberg transcripts and their contextualized

analysis (as the transcripts themselves don't carry the overarching context of victor's justice within which both the Nuremberg and Tokyo Trials were administered, and without which, the facts noted in the transcripts remain poorly understood by those merely reading the transcripts), that the first principles, the prime-movers, the first act of aggression, those who gave the orders, from which *"all the evil that follows"* has a long-running legal precedent which was forcefully refreshed at Nuremberg. You perhaps understand its legal modalities better, but I can argue it right at the head of the fish.

Some of my writings referenced in that aforementioned report examine the head of the fish and the nature of the rot, the why, the motivation, which automatically fingers the entire hierarchy of the who, of which the machinery of the state is merely the visible henchmen. That exposure might perhaps indicate the level of abstraction at which such cases really ought to be pursued for an efficacious legal case. It is precisely that abstraction, the head of the fish, which thrives on remaining out of the public limelight. Put the spotlight on the cause, not the effects, and you strip it of its power of thriving on anonymity. You also risk an early grave.

I was struck by your comment which was reported by Amy Alkon on her website: *"Some cases are too important to need to get paid for."* ([http://advicegoddess.com/archives/2011/09/07/obedience\\_train.html](http://advicegoddess.com/archives/2011/09/07/obedience_train.html) ). I wanted to know more about someone who'd make a statement like that in this day and age, what a rare breed, and I came to your website and saw you quoting Thurgood Marshall on the First Amendment. I wonder if [you] are aware of Justice Vinson's empirical opinion alongside that immanent-speak of Marshall's:

"Nothing is more certain in modern society than the principle that there are no absolutes, that a name, a phrases, a standard has meaning only when associated with the considerations which give birth to nomenclature. To those who would paralyze our Government in the face of impending threat by encasing it in a semantic strait-jacket, we must reply that all concepts are relative." -- Justice Vinson, U.S. Supreme Court, 1951.

While Thurgood Marshall's is inspiring and a lofty goal of the philosopher, Vinson's is empirical, the way reality actually is in legaldom. A legal system which is always primarily in the service of empire, and not the people. As you can witness, that ode to moral relativism was uttered by Justice Vinsom directly on the heels of Nuremberg where Justice Robert H. Jackson, the United States Chief Prosecuting Counsel, had argued in moral absolutes as the victors are always wont to do when administering justice upon the vanquished:

"If certain acts of violation of treaties are crimes, they are crimes whether the United States does them or whether Germany does them, and we are not prepared to lay down a rule of criminal conduct against others which we would not be willing to have invoked against us." --- Robert H. Jackson, Nuremberg Military Tribunal, 1946

And therefore, I peg your chance of success in this lawsuit, were you to focus on the fish tail, next to nil (but I am not an expert, just using layman's commonsense). But I do believe, based on empirical data of "imperial mobilization" and the forces driving it, that such effort will merely be an exhausting run on the treadmill for your client, and not precedent setting (for your cause, only for theirs – the victim of *obedience training* can no longer complain too loudly of the vile methods employed to do so), nor cause any real impact to the TSA policies which is being administered by Homeland Security as part of "war on terror".. At best, the claimant, will drop the lawsuit. At worst, your client will go broke both financially and emotionally, despite your pro bono. That is the obvious first-stage strategy any tyrannical government always counts on against individuals. They exhaust themselves on their own given sufficient time and sufficient embroilment.

Whereas, if you were to address the head of the rotting fish, the tail would automatically be included. By being realistically aware of your opponents' vast arsenal which spans the gamut of Machiavelli to social engineering, and their overarching motivations to use it when the stakes are high, as they are in this momentous epoch in future narratives of history, you can better take on this challenge which you so forthrightly stated transcends mere pecuniary gains.

The stakes are far higher than the first Amendment you cherish and quote. The stakes are police-state and public enslavement of the entire West initially. Unless you can understand the overarching motivation, succinctly summed up by Bertrand Russell in his 1952 book *The Impact of Science on Society*: "*World government could only be kept in being by force.*", your efforts will have marginal efficacy at best.

Even the influential Financial Times has argued that 9/11 finally enabled one-world government:

'for the first time in my life, I think the formation of some sort of world government is plausible. ... it is increasingly clear that the most difficult issues facing national governments are international in nature: there is global warming, a global financial crisis and a "global war on terror"' ( <http://print-humanbeingsfirst.blogspot.com/2008/12/responseto-ft-gideon->



[rachman-worldgov.html](http://rachman-worldgov.html) ).

And the EU president confirmed the FT editor's self-serving confession, by coldly stating that “2009 is also the first year of global governance” ( <http://youtube.com/watch?v=QEqFtVrAgSo> )

These are the forces behind the myriad effects, including TSA absurdities of protecting the traveling public by offering them the false dialectics of death by sustained radiation exposure via naked strip-down (body-scan imaging) vs. suffering humiliation by groping and molestation. Its entire purpose is obedience training of the American public. And it is evidently succeeding. The last time I checked the TSA data a few months ago, they reported that of the millions who silently accept the false choices provided them by the TSA, only a minuscule 0.005% public have resisted (that number is from memory and maybe the decimal is misplaced).

You cannot prevent an apple from falling unless you are aware of the nature of gravity. But if you fully understand the force of gravity, then you don't need to watch an apple fall if you let go of it in positive gravity, to know that it has fallen. That bit of commonsense logic is from Mr. Spock of Star Trek. Because I understand the forces which drive “*imperial mobilization*”, I don't need to hear the actual outcome of your case, to know what it will be.

Let me know if you think I can be of any assistance after you have read my work, and if you wish to address the head of the fish. I will be happy to lend whatever hand I can, **gratis**, on the Solon principle while I am still in the United States (as I spend my time between my home in California and my home country Pakistan), and will also bear my own costs. The stakes are so high that the entire house of cards can potentially be brought down by accurately attacking its Achilles' heel. That requires more than just a legal team. Inter alia, it requires intellectual capital and full spectrum engagement at many fronts including in the media. The latter will automatically happen, I suspect, if you succeed in shinning the spotlight on the head of the fish and drive it all the way to the Supreme Court. I can already wager stochastically that the highest court in the land will decline to hear it. But we don't know that for a fact – and in waging a battle, it is not always the strongest who wins. Like Patrick Henry had once observed in his inimitable style:

“Besides, sir, we shall not fight our battles alone. There is a just God who presides over the destinies of nations, and who will raise up friends to fight our battles for us. The battle, sir, is not to the strong alone; it is to the vigilant, the active, the brave.” -- Patrick Henry, March 23, 1775

I generally pursue principled moral activism only in full public view. When there are no secrets to keep, there is no fear of their being revealed. That may not always be a good legal, chess, or poker strategy, but it is a great risk mitigation strategy for the public against subversion, entrapment, and cointelpro.

Therefore, any 0.02 cents contribution I can make, if called upon to do so, I will be happy to contribute without the crutch of secrecy and confidentiality with my well-worn pen and my hoarse voice now tiring of repeating the same things over and over again. The power of the public in standing up to tyranny lies only in its open expression of resistance to the absurd and the vile. For instance, if one pre-advertise the fact how one sees the outcome developing, one can (perhaps) preempt that outcome from developing in order for the system to continue to maintain its facades -- which I deem is still necessary for it for a while longer. We are presently caught *Between Two Ages*, a transition period. This epoch still requires maintaining some facades in the mainstream public's views. That necessity of theirs, is also their Achilles' heel. If you transform this battle into Judo, using your opponents' strengths and weakness against them, then who knows...

Thank you once again, it has been a pleasure hearing of someone who is motivated by something other than the worship of their stomach. Thus this letter.

Zahir Ebrahim

Project Humanbeingsfirst.org

bio url: <http://zahirebrahim.wordpress.com/bio/>

Submitted on the website form on Wednesday, September 7, 2011, 2:28 PM PST: <http://www.randazza.com/contact/thankyou.html> Resubmitted with typographical correction (in bold) and minor elaboration (in paranthesis), 10:00 PM.

**Source URL:** <http://print-humanbeingsfirst.blogspot.com/2011/09/letter-civilrights-tsa-lawsuit-randazza.html>

## Chapter 13 White Man's Burden

### The White Man's Burden appears Uniformly Distributed among Jews Christians and Atheists – how can one tell the difference?

'If you know the enemy and know yourself, you need not fear the result of a hundred battles. If you know yourself but not the enemy, for every victory gained you will also suffer a defeat. If you know neither the enemy nor yourself, you will succumb in every battle.' -- Sun Tzu, The Art of War



Caption Why ostriches are very happy creatures.... (image source National Geographic)

This is part7 of my confusion series on trying to think for myself. It is a bloody confusing exercise which I wouldn't wish to inflict even upon my most despicable enemies – they already think plenty for themselves. See earlier episodes here: part1, part2, part3, part4, part5, and part6. This is the final episode as I have promised myself to no longer be plagued by this curse of independent thought. The comfort of following the experts, the know-it-all “illuminated ones” from the vast spectrum of leaders offered to the plebes, is much more opiate, if not completely soothing to the soul. A dead intellect is the best one for the sheep – and of course, the shepherds delight.

I begin by reproducing the famous 1899 poem, *The White man's Burden*, by Rudyard Kipling. Its full title in synecopation with the actual *white man's burden* of the time, actually was: “**The White Man's Burden: The United States and The Philippine Islands**”. And it went like this:

Take up the White Man's burden--  
Send forth the best ye breed--  
Go bind your sons to exile

To serve your captives' need;  
To wait in heavy harness,  
On fluttered folk and wild--  
Your new-caught, sullen peoples,  
Half-devil and half-child.

Take up the White Man's burden--  
In patience to abide,  
To veil the threat of terror  
And check the show of pride;  
By open speech and simple,  
An hundred times made plain  
To seek another's profit,  
And work another's gain.

Take up the White Man's burden--  
The savage wars of peace--  
Fill full the mouth of Famine  
And bid the sickness cease;  
And when your goal is nearest  
The end for others sought,  
Watch sloth and heathen Folly  
Bring all your hopes to nought.

Take up the White Man's burden--  
No tawdry rule of kings,  
But toil of serf and sweeper--  
The tale of common things.  
The ports ye shall not enter,  
The roads ye shall not tread,  
Go mark them with your living,  
And mark them with your dead.

Take up the White Man's burden--  
And reap his old reward:  
The blame of those ye better,  
The hate of those ye guard--  
The cry of hosts ye humour

(Ah, slowly!) toward the light:--  
"Why brought he us from bondage,  
Our loved Egyptian night?"

Take up the White Man's burden--  
Ye dare not stoop to less--  
Nor call too loud on Freedom  
To cloke your weariness;  
By all ye cry or whisper,  
By all ye leave or do,  
The silent, sullen peoples  
Shall weigh your gods and you.

Take up the White Man's burden--  
Have done with childish days--  
The lightly proffered laurel,  
The easy, ungrudged praise.  
Comes now, to search your manhood  
Through all the thankless years  
Cold, edged with dear-bought wisdom,  
The judgment of your peers! --- [Source](#)

According to *History Matters'* commentary on the poem:

'In February 1899, British novelist and poet Rudyard Kipling wrote a poem entitled "The White Man's Burden: The United States and The Philippine Islands." In this poem, Kipling urged the U.S. to take up the "burden" of empire, as had Britain and other European nations. Published in the February, 1899 issue of *McClure's Magazine*, the poem coincided with the beginning of the Philippine-American War and U.S. Senate ratification of the treaty that placed Puerto Rico, Guam, Cuba, and the Philippines under American control. Theodore Roosevelt, soon to become vice-president and then president, copied the poem and sent it to his friend, Senator Henry Cabot Lodge, commenting that it was "rather poor poetry, but good sense from the expansion point of view." Not everyone was as favorably impressed as Roosevelt. The racialized notion of the "White Man's burden" became a euphemism for imperialism, and many anti-imperialists couched their opposition in reaction to the phrase.' --- [Source](#)

Because history matters so much – both for understanding the present for the thought bearing, and for confounding the present for the uninitiated in order to get them *'United We Stand'*, not to mention for forging the future, any future, both good and bad – that Zbigniew Brzezinski had so astutely observed in *The Grand Chessboard* in 1996:

“The earlier empires were built by aristocratic political elites and were in most cases ruled by essentially authoritarian or absolutist regimes. The bulk of the populations of the imperial states were either politically indifferent, ... or infected by imperialist emotions ...a quest for national glory, 'the white man's burden', 'la mission civilisatrice', not to speak of the opportunities for personal profit – all served to mobilize support for imperial adventures to sustain essentially hierarchical imperial power pyramids. The attitude of American public toward the external projection of American power has been more ambivalent. The public supported America's engagement in WWII largely because of the shock effect of the Japanese attack on Pearl Harbor. .... After the Cold War had ended, the emergence of the United States as the single global power did not evoke much public gloating but rather elicited an inclination toward more limited definitions of American responsibilities abroad. Public opinion polls conducted in 1995 – 1996 indicated a general public preference for 'sharing' power with others, rather than for its monopolistic exercise.” (24,25)

“It is also a fact that America is too democratic at home to be autocratic abroad. This limits the use of America's power, especially its capacity for military intimidation. Never before has a populist democracy attained international supremacy. But the pursuit of power is not a goal that commands popular passion, except in conditions of a sudden threat or challenge to the public's sense of domestic well-being. The economic self-denial (that is defense spending), and the human sacrifice (casualties even among professional soldiers) required in the effort are uncongenial to democratic instincts. Democracy is inimical to imperial mobilization.” (35,36)

“Public opinion polls suggest that only a small minority (13 percent) of Americans favor the proposition that 'as the sole remaining superpower, the US should continue to be the preeminent world leader in solving international problems'. ... Moreover, as America becomes an increasingly multicultural society, it may find it more difficult to fashion a consensus on foreign policy issues, except in the circumstance of a truly massive and widely perceived direct external threat. .... More generally, cultural change in America may also be uncongenial to the sustained exercise abroad of genuinely imperial power. That exercise requires a

high degree of doctrinal motivation, intellectual commitment, and patriotic gratification. ... Mass communications have been playing a particularly important role in that regard, generating a strong revulsion against any selective use of force that entails even low levels of casualties .... In brief, the U.S. Policy goals must be un-apologetically twofold: to perpetuate America's own dominant position for at least a generation and preferably longer,..." (211-215)

So, how to embark on "*imperial mobilization*" when the American *white man* (and the Western *white man* in general) are no longer themselves "*infected by imperialist emotions ...a quest for national glory, 'the white man's burden', 'la mission civilisatrice',*" kept engaged, and ensnared, as they all are, in chasing their respective '*American Dreams*'? Which, for the vast majority of '*white trash*' among them, have their dollars, pounds, and euros, sucked out of their pockets even before it can reach their dinner tables and their perpetual debt collectors? The political science principle of achieving "*imperial mobilization*" under such conditions is to engineer consent – just as one might engineer technology, or engineer the voyage to the moon. It takes a great deal of expertise, and very deep pockets. This social technology is examined in the Preamble of my 2008 report [Weapons of Mass Deception](#), where it is explained how consent, as well as dissent, both must to be manufactured in order to be effective, employing different categories of deceptions tailored to the different audiences and their mental acumen.

This variance of having a differing audience, also necessitates making the manufacturing process, and its products, different at every level. From simple big lies for the vast majority, to complex layered ones which mix verifiable empirical truths, half-truths, and outright lies characterized by clever omissions, layer by layer, so that the remaining few, as well as institutions and organizations with group-think, can also find something believable to suit their own individual propensities. Myths and mantras are cleverly fabricated and presented to each audience according to their own limited world views and selfish priorities which are often shared with their respective political, social, cultural, and religious groups. These engineered myths and mantras always motivate people to act in accordance with those implanted beliefs. The end result being that the *history's actors* are able to get away Machiavellianly sowing their irreversible faits accomplis amidst all the confusions which follow.

Different and often opposing myths also naturally seed the interesting *Technique of Infamy* among antagonist domestic groups, keeping people and cabals fully embroiled in vehemently debating who is right, who knows more, who is more intelligent, who is more pious, who is more peaceable, who is the avantgarde in thought and who are the sheep, etc. Such opposing "truths" deftly implanted among groups automatically enables setting

one group against another – political philosopher Hegel's recipe for creating new order from old by orchestrating the continuous clash of the opposites known as Hegelian Dialectic – and we see this false Left--Right political paradigm orchestrated along those very lines, with almost an infinite layers in between, for that very purpose. And in the limit, internationally, it enables seeding total wars among nations – the key Machiavellian modus operandi for tearing down any old world order to create a new world order. Very powerful stuff. Such confabulations, hegelian mind-fcks I call them, were examined in depth in my essay on the Mighty Wurlitzer and the power of crafting enabling myths: [Wikileaks and Imperial Mobilization](#).

My essay [Unlayering the Middle East War Agenda: Making Sense of Absurdities](#) demonstrated that Brzezinski's prima facie motivation for inflicting *American Primacy and Its Geostrategic Imperatives* upon the world as expressed in *The Grand Chessboard*, which was chauvinistically stated as: “to perpetuate America's own dominant position for at least a generation and preferably longer,” was itself only a motivating myth. It was necessary for motivating America's vast military-industrial complex and the Pentagon warriors who all thrive on even small wars, and therefore would just love the idea of thriving endlessly in a Total War waged endlessly, the World War IV that will last “at least a generation and preferably longer,”.

The nihilistic notion of *Total War* similarly pushed by Brzezinski's confrere, Michael Ledeen, ostensibly to usher in regime changes throughout the New Middle East, is similarly absurd when one pauses to reflect that the old Middle East – ripe with installed dictators and implanted kingdoms oppressing their own peoples in service to the sole superpower along artificially contrived borders carved out from the remnants of the Ottoman empire at the conclusion of World War I – is entirely the orchestration of the same imperial masters now advocating the next cycle of regime changes:

“No stages. This is total war. We are fighting a variety of enemies. There are lots of them out there. All this talk about first we are going to do Afghanistan, then we will do Iraq... this is entirely the wrong way to go about it. If we just let our vision of the world go forth, and we embrace it entirely and we don't try to piece together clever diplomacy, but just wage a total war... our children will sing great songs about us years from now.” -- Michael Ledeen, speaking at the AEI (American Enterprise Institute), [10/29/2001](#), [source](#)

Why is Ledeen selling *Total War*? For the same covert motivation Zbigniew Brzezinski is selling America's preeminence in *The Grand Chessboard*. Everyone in the military-industrial complex is sold what they want to hear. But the real intent behind the chauvinism,



as empiricism testifies, is to bankrupt America, to demoralize its public, while sowing chaos and destruction in the previous world order they had themselves established after the two World Wars. Disguised in polished vernacular and under the farcical pretext of regime changes, is the nihilism to seed chaos and demoralization among the public throughout the world. This is even apparent when one un-layers Michael Ledeen even with an ounce of forensic thinking, especially in the light of empiricism:

“Creative destruction is our middle name, both within our own society and abroad. We tear down the old order every day, from business to science, literature, art, architecture, and cinema to politics and the law. Our enemies have always hated this whirlwind of energy and creativity, which menaces their traditions (whatever they may be) and shames them for their inability to keep pace. Seeing America undo traditional societies, they fear us, for they do not wish to be undone. They cannot feel secure so long as we are there, for our very existence—our existence, not our politics—threatens their legitimacy. They must attack us in order to survive, just as we must destroy them to advance our historic mission.” -- Michael A. Ledeen, *The War Against The Terror Masters: Why It Happened. Where We Are Now. Wow We'll Win*, 2003, [pgs. 212-213](#)

This is textbook Hegel. One can see this nihilistic theme being repeated over and over again, only the latest incarnation being the Egypt Revolution. This was examined in my article: [Egypt and Tunisia – The 'arc of crisis' being radicalized!](#).

The agenda behind constructing all these “*revolutionary times*” along Zbigniew Brzezinski's “*arc of crisis*” using Michael Ledeen's “*total war*” for “*creative destruction*” wherein, the children of the *white man*, in Ledeen's own words: “*our children will sing great songs about us years from now*”, is to make the final push for the globalists' one-world government. The white man has very clearly understood that which most 'untermenschen' have not, in David Ben Gurion's own words: “*what is inconceivable in normal times is possible in revolutionary times*”!

To launch this renewed *white man's burden* for world government, entirely through deception, many many ruses, and many many peoples, from mercenaries to patsies, from manufactured ideologues to fabricated stooges, and from all walks of life and profession have been engaged.

Infiltrations are at every level, from physical to cognitive as per the old COINTELPRO style, and even at the level of the sub-conscious mind through both flag-waiving indoctrinations,

and propaganda techniques pioneered by Edward Bernays. The latter had been successfully utilized by him to wage psy-op wars upon the peoples of all nations throughout World War I and World War II. Now refined to the level of science, this art of persuasion has been taken to new heights.

So, we have the Zionist Jews murdering the Palestinians to the sound of their trumpet while urging the superpower to wage endless war upon the world – the so called neo-cons. Then we have the American and its Allied Christian soldiers murdering the Iraqis, Afghans, and Pakistanis, in large numbers, and again to the sound of even greater trumpets. Today, the blame for this *Total War* is entirely laid at the doorstep of the Jewish neo-cons who have visibly taken over almost all of the United States Government which is evidently being run from Tel Aviv.

But, is this mission of *Total War* through *Total Deception* hell of a lot different from *the white man's burden* of the not too distant past, when plain folks, quite genuinely “*infected by imperialist emotions ...a quest for national glory, 'the white man's burden', 'la mission civilisatrice', not to speak of the opportunities for personal profit – all served to mobilize support for imperial adventures to sustain essentially hierarchical imperial power pyramids.*”?

The settlement of the Americas by genociding its native inhabitants, is the best example of genocide of the indigenous peoples as the noble Christian *white man's burden*. The conquest of the sea trade routes by the East India Company and the physical colonization of the Indian subcontinent, is the best example of colonizing an indigenous peoples into subservient bondage to the noble Christian white man's *la mission civilisatrice*. The unfortunate native populations of the Americas, Australia, etc., weren't so fortunate, as the noble Bible thumping white man actually coveted their land. In India they only coveted her vast riches – the Jewel in their crown!

Well, that same exercise with only minor syntactic sugaring, is being inflicted by the holy Jews and noble atheistic soldiers of irredentist Zion upon the 'untermenschen' of Palestine today. Is it much different? Not according to the two Christian and Jewish statesmen, respective leaders of their nations. On the festive and felicitous occasion of the 60th anniversary of Israel's existence which was celebrated with much fanfare from Tel Aviv to Washington D.C., President George W. Bush along with his notable wife landed at Tel Aviv's Ben Gurion airport on May 14, 2008, to the warm greetings of Shimon Perez:

*“Welcome to the new Israel: Three thousand years old, and going on sixty”*

President Bush had effusively replied:

*“Our two nations both faced great challenges when they were founded. And our two nations have both relied on the same principles to help us succeed. We built strong democracies to protect the freedoms given to us by an Almighty God”*

And the late Tanya Reinhart, the Leftist Jew and respected dissent chief of many a rebel, made the exact same comparison after she experienced her *metanoia* and tried to explain to the world the indoctrination and false justifications she was infected with while growing up as a Zionist in Israel:

“The state of Israel founded in 1948 following a war which the Israelis call the War of Independence, and the Palestinians call the Nakba – the catastrophe. A haunted, persecuted people sought to find a shelter and a state for itself, and did so at a horrible price to another people. During the war of 1948, more than half of the Palestinian population at the time – 1,380,000 people – were driven off their homeland by the Israeli army. Though Israel officially claimed that a majority of refugees fled and were not expelled, it still refused to allow them to return, as a UN resolution demanded shortly after 1948 war. Thus, the Israeli land was obtained through ethnic cleansing of the indigenous Palestinian inhabitants. This is not a process unfamiliar in history. Israel's actions remain incomparable to the massive ethnic cleansing of Native Americans by the settlers and government of the United states. Had Israel stopped there, in 1948, I could probably live with it. As an Israeli, I grew up believing that this primal sin our state was founded on may be forgiven one day, because the founder's generation was driven by the faith that this was the only way to save the Jewish people from the danger of another holocaust.” -- Tanya Reinhart, *Israel/Palestine – How to End the War of 1948*, [source](#)

An honest comparison which evidently learned rebels like Alan Hart, another favorite rebel of the dissent space, who keep comparing the Zionist enterprise in Palestine to the Nazis, fail to make. I examined this inexplicable failure in response to Alan Hart's characterization of Israel as “The New Nazis”, in [No, No - Not the 'New Nazis'](#), January 2009.

Therefore, concluding the preceding analysis, I have to wonder how comes the brilliant white man is suddenly so naive that he fails to see the parallel *white man's burdens* in all his holier than thou blanket Jew bashing? I hope I may be forgiven today, in 2011, that I am

entirely unable to differentiate one *white man's burden* from another. Can you tell them apart in the images below? Please click on the image and it will take you to a more detailed exposition in case you feel you are able tell the difference:

## Hidden No Longer:



Caption Hidden no longer: Genocide in the Americas by the pious Christians bearing the gift of *the white man's burden* to the native Indian tribes [hiddennolonger.com](http://hiddennolonger.com)



Caption Genesis to Genocide in Palestine by the pious Jews bearing the gift of *the white man's burden* to the Arabs and Muslims



Caption Exodus, destruction, death and chaos, inflicted by the pious bearing gifts of Western civilization's new *white man's burden*, the war on terror, to Pakistan with copious



help from the Pakistani House Negroes



Caption Exodus, destruction, death and chaos, inflicted by the pious bearing gifts of Western civilization's new *white man's burden*, the war on terror, to Afghanistan



Caption Exodus, destruction, death and chaos, inflicted by the pious bearing gifts of Western civilization's new *white man's burden*, the war on terror, to Iraq



Caption Jesus has come in May to Afghanistan: US troops urged to share faith in Afghanistan - 04 May 09



Caption US Soldiers in Afghanistan Told to “*hunt people for Jesus... so we get them into the kingdom*” rebelreports

And, I would be sorely remiss in not condemning the brazen and pernicious role of *House Negroes* in dutifully carrying *the white man's burden* as their own. Pakistani negroes and native informants are famous for their being trivially flattered into the *massa's* lair. Quoting from the former Director of ISI's 1995 memoirs, *Profiles of Intelligence*:

*'A lot has been said and written by some of our American friends about the price of a Pakistani. Dr. Andrew V. Corry, US Counsel General at Lahore, once said, “Price of a Pakistani oscillates between a free trip to the US and a bottle of whisky.” He may not be too far wrong. We did observe some highly placed Pakistanis selling their conscience, prestige, dignity and*

*self-respect for a small price.*' (Brig. Tirmazi, Director of Pakistan's ISI at the time of the judicial homicide of its elected primeminister Zulfiqar Ali Bhutto, Profiles of Intelligence, Brig. Syed A. I. Tirmazi, 1995, pg. 45).

Can you easily tell the difference between the burden of the *white man* and his *house niggers*:



Caption **Shameless Stooges** at the *massa's* table in payoff for "Bukakke" services rendered. Tahir ul-Qadri and Imran Khan are not simpleton patsies – they know exactly what they are doing by echoing empire's axioms on Terrorism. Just being invited to sit at the *white man's* table and utter gibberish in gratitude is evidently sufficient incentive for Pakistani *brown-sahibs* to commit treason. The Western establishment's cultivated *Trojan Horses* among Muslims to institute *beneficial religious-political diversity* (sic!), namely "moderate Islam", Qadri-Khan make even Mir Jafar/Mir Sadiq duo look virtuous. The final payment awaiting stooges when their services are terminated can be witnessed in the fate of the one far more illustrious, Benazir Bhutto. The ill-fated *daughter of the East* had echoed the same axioms on Terrorism at the CFR in 2007. Evidently, anyone and everyone can be recruited after they have shown their willingness to echo the white man's burden. Here is CFR's latest 2011 promotion from among the *native informants*. Now is your chance to serve the *massa* – pathetic house negroes are evidently still in great demand! And you can have your choice of "Betweens" to choose from as your daily service. Trips to Disneyland, sabbaticals, appointments, and book deals are included in the compensation



package based on the level of eruditeness of your bullshit. (Image contributed by a Pakistani *field negro*)

The foolish 'untermenschen' better understand the insidious breadth and depth of the common *la mission civilisatrice* bond among the *white man* (and including their *house niggers* who are often more *white* than the *white man*) when they come, individually, and in groups, wearing different colored labels of Left, Right, Liberal, Conservative, Progressive, Atheist, Christian, Jew, whatever, bearing gifts of pious virtue in various Hegelian Dialects. Zbigniew Brzezinski justified the primacy of the powerful with "*Hegemony is as old as mankind*" in *The Grand Chessboard* only as the latter day secular version of that same *white man's burden*.

When I recently, only this past week in fact, once again challenged the pious *white man's* characteristic narratives in their blanket Jew bashing screeds in my letter: Zahir Ebrahim's Letter to John Kaminski – Are you Jewish?, and deconstructed the new *white man's burden* of Secular Humanism they now wish to inflict upon humanity in the guise of discrediting all established religions in order to secure their one-world government, I was not surprised by what happened. You can read the response of the fanatic all-knowing Jew-basher, who has extended his unfettered Jew bashing to both Christian and Muslim bashing: "***Christians and Muslims are trapped in the same delusional mindlock as the Jews,***" reviling without any compunction more than 5 billion peoples on the planet in just one sentence, even calling my religion, Islam, "***fetid and toxic dogma***".

The supposedly rebel website which goes by that very name and presents itself on the side of the 'untermensch' by publishing dissenting articles with empire, gratuitously wrote an amusing editorial response to my letter instead of condemning their own favorite white man whose trite screed they boldly feature on their front page every week as the avantgarde in progressive thought: Rebel News' Letter to Zahir Ebrahim – Are you Mossad?. When I submitted my response to the white man denigrating my religion and 5 billion peoples' on the planet in the name of dissent and requested the website publish my response, the same editor wrote back: "**I won't. Your writings clearly don't fit in. Thank you for your time. -- Andrew Winkler Rebel Media Group**"!

Indeed!

This plebeian's antidote to hectoring hegemons clearly won't fit in where the *white man's burden* is the real agenda – heeheehee!

I have been labeled worse than "Mossad" for calling the bullshit of the *white man*. The

'denier' label from [Israel Shamir](#), the holy Jew miraculously metanoia'd into pious Christian like the historical Saul into Paul, was a tad more cognitive.

But as of this writing, nothing has surpassed what the genuinely Christian rebel leader extraordinaire, Paul Craig Roberts, United States Former Assistant Secretary of the Treasury who sat at the same oligarchic tables before taking on his new role, and who writes for the camouflaged white supremacist website VDARE.com, honored me with in [Dec 06, 2008](#): **“you are a completely stupid fool, a disgrace to humanity”**. My unpardonable sin? Boldly calling his bullshit of maligning the Muslims as terrorists, while all the rest of fools, mostly the *white man*, applaud him for his gallant dissent!

Dissent with what? Dissent does not automatically imply being on the side of the 'untermenschen'. It is only presumed to be so in the vernacular which has calculatingly been developed in the West as a *neuro linguistic programming* Trojan Horse for the mind, to alias subversion under association with something familiar. And this works great for pushing covert agendas of the *political elites* in a far more sophisticated format than merely through “controlled dissent”. The latter is principally employed for craftily channeling any public opposition, or the premature discovery of monumental crimes in progress, towards inefficacy and at best, a *Limited Hangout* sacrificial mea culpa, as already examined in [Anatomy of Conspiracy Theory](#). The endless trail of red herrings established by the social engineering symphonies of the [Mighty Wurlitzer](#), of which “controlled dissent” is an essential melody, is primarily intended to waste sufficient time while *manufacturing consent* in order to successfully engineer a fait accompli that is subsequently irreversible due to its very nature, even if the truth is ex post facto revealed with much fanfare. This is straightforwardly true for a single set of masters pursuing a single set of overarching goals. Empiricism however, undeniably suggests that there are in fact, multiple sets of masters carrying their respective *white man's burden*, and competing amongst themselves for the unfettered rights to primacy.

For these *elites*, the common plebeian masses are merely the *puck* to be pushed around towards their own respective goal posts. In the full engagement of such broad-spectrum mind-fcks, the dissent of the lauded chiefs, and many a public figure, evidently spans the gamut – and perhaps my cynicism may be forgiven as one of only a confused person endeavoring to think for oneself without the benefit of prominent “experts” to guide one – from disagreeing amongst each other while sharing the *white man's burden*, to vilely herding the sheep of dissent to the same pastures as the sheep of mainstream but in erudite round-about ways. Dissent under social engineering burdens, is not always the lofty mantle of Socrates. More frequently, it is the mantle of the controllers outside of *Plato's Cave* pursuing their own narrow primacy interests. See: [Responsibility of Intellectuals –](#)

## Redux.

The pious *white man* is slipping today. Those majoring in Western hypocrisy might wish to work at layering their common *mission civilisatrice* with a bit more finesse and diabolicalism than they are doing now. Perhaps as they used to do in the past, when the East India Company created its version of globalism with *free trade* inflicted upon its colonies. And perhaps when small pox laden blankets decimated entire tribes and nations and genocided them off the face of the earth as a peoples. Today, even an ordinary plebeian is trivially able to call attention to their common bond of pious virtues, and trivially unravel their bullshit. Their Hegelian Dialectic is slipping....

Below are some empirical essays which unarguably demonstrate how the modern white man is still united in the same un-severable common bond, its *la mission civilisatrice*, even upon each other, irrespective of their separate creeds and occasional bouts of antagonistic power-plays among each other. They only compete amongst themselves, and the outclassed by the better trained simply run home to mommy, variously crying *foul* and *grapes are sour*.

The losing *white man* in this primacy contest often makes a great show of friendship to the '*untermensch*' victims of the winning *white man*, employing the timeserving "*enemy of my enemy is my friend*" principle to open new backdoors back into the same contest. I suspect that the *white man's burden* intrinsically makes sharing the prize problematic among the various white man from differing creeds and races for very long, despite their common mission of unfettered primacy whenever they can get away with it.

This common mission statement used to be mistakenly called *the law of the jungle* – but it really isn't. In the jungle, when the primacy hierarchy, all the way to the top, has eaten its fill, each rests until the next mealtime. The strong weed out the weak yes, but only from wanting to have their daily meals, and the weakest not being able to do so for one reason or another. Never just for the sake of control, for full spectrum dominance, in the urge to enslave others. But for the arbiters of the *white man's burden*, there can be no point of satiation in their social Darwinianism. Such primacy can only culminate in full master-slave bondage, couched in modern day Newspeak for camouflage, as *world government* (see [Of Ostriches and Rebels on The Hard Road to World Order](#)). But then, the masters must turn upon each other because there really can be, only one master!

This is the Nihilist Order that is being pushed upon mankind today by the legatees of the same old *white man's burden*. I really can't tell these different strands of the *white man* apart – be they holy Zionist Jews in Palestine bringing us Western civilization on that front,

or pious Christians bringing “Jesus” to Afghanistan just as they did to the Americas, and to the Indo subcontinent, or noble leftists and atheists posing as their common peacenik antagonists. They all look the same to me, especially from Mt. Fuji:

“Aspire to be like Mt. Fuji, with such a broad and solid foundation that the strongest earthquake cannot move you, and so tall that the greatest enterprises of common men seem insignificant from your lofty perspective. With your mind as high as Mt. Fuji you can see all things clearly. And you can see all the forces that shape events; not just the things happening near to you.” -- Miyamoto Musashi -- Quoted in Political Ponerology

Here are some of my pertinent writings on the theme of *white man's burden*, in reverse chronological order:

- <http://print-humanbeingsfirst.blogspot.com/2011/02/letter-john-kaminski-are-you-jewish.html>
- <http://print-humanbeingsfirst.blogspot.com/2011/01/white-mans-burden-still-looks-white.html>
- <http://print-humanbeingsfirst.blogspot.com/2010/12/my-confusion-pt5-kevinmacdonald-wmb.html>
- <http://print-humanbeingsfirst.blogspot.com/2010/02/respto-johnkaminski-jewish-writers.html>
- <http://print-humanbeingsfirst.blogspot.com/2010/02/white-anglo-saxon-race-obsession.html>
- <http://humanbeingsfirst.files.wordpress.com/2010/02/cacheof-12281-in-defence-of-larry-david-by-gilad-atzmon-with-zahirs-comment-afp-nov162009.pdf>

Judge for yourself – and if you learn to tell the difference, please inform this confused plebeian who is fast reaching the pitiable conclusion that almost all of the dissent in the West, especially that led by the white man, is bogus! The rare exceptions are not sufficient in influence to call it effective dissent, and they are generally the unknown ordinary men and women of conscience who nobody knows, and who aren't the typical opinion-makers.

What this further underscores is the empirical pragmatism which has always been true, that the Global East, and the Global South, the lowest in the pecking order of the 'untermensch',

stand pretty much alone against the incessant, all encompassing onslaught of the hectoring hegemony of the Global North-West. This has been the unvarnished history of the past several hundred years, and just because there is internet today, and the information age, it is foolish to think that it is all about to miraculously change! These new age tools have been deftly adapted for the same agenda which were previously thrashed out on lonely typewriters.

**Unless the 'untermensch' nations of the East indigenously come to our own common self-defense against these almost superhuman global forces arrayed against us, no one else will.**

The only known defense for the weak, is to innately become strong. No people living on the begging bowl pleading for justice in charity, have ever got a fair hearing in the imperial courts of any ubermensch, white, black, brown or yellow, any place on earth.

Becoming strong does not however imply following a new pied piper, such as falling prey to “revolutions” orchestrated through mob-power, wherein, the same puppetmasters diabolically harness the public's genuine disaffections to merely replace one tyrant by another in a game of hegelian musical chairs. See: [Zahir Ebrahim's Letter to BRussells Tribunal: Egypt Revolution, the White Man's Burden, and Iraq](#), which penetrates behind the “revolutions” now transpiring among the 'untermensch' nations in the Middle East in the vaunted name of “change”.

This is a stark lesson to remember for the American and Western public as well. They are continually taught to look towards “leaders” and “experts” to show them the way at the expense of their own commonsense. Kept thoughtlessly occupied chasing the mirage of the '*American Dream*', the '*white trash*' of the Global North-West shall not escape the butcher's knife either. Their biggest Achilles heel today, is their loss of faith, and their greatest nemeses are those pitching Secular Humanism to them by reviling all religions.

And it is done with such finesse – if one were to judge Islam by the ubiquitous song of “Islamofascism” in the Western newsmedia and the Hollywood movies, Christianity by the child molesting priests proudly decked in their starched collars of piety, Judaism by the Judeofascist Talmudic cabal who today principally stand out as the most barbaric of peoples on planet earth, one would become naturally primed for a great new secular substitute for the New Age.

Without faith, without a deep sense of justice and morality, all of which are being systematically stripped from the gullible Americans' national psyche which was already too

rich in the fertile soil of hedonism pre-ploughed with the ripe seeds of moral relativism, what is to prevent the American masses from turning into “cannibals”? They have already been sufficiently psychologically conditioned into barbarianism, almost gleefully watching the slaughter of the 'untermenschen' without much anxiety, in just this past decade (see [America's Shame](#)). Now they are also being physically conditioned through their own systematic dehumanization at airport security checkpoints where 99% of the travelling public meekly acquiesces to the false choice between accumulating deadly radiation dosage and grotesque molestation to keep them “safe” (see [What Went Wrong In The Land of The Free – Standing For Airport Indignities](#)).

And if this [science report](#) is to be believed, pharmaco'logically induced moral reconditioning may well be the next mandatory prescription, prescribed in Newspeak of course, like every other Orwellian remedy: *“Racist? Angry? The answer may be in a pill. A pill to enhance moral behaviour; a treatment for racist thoughts; a therapy to increase your empathy for people in other countries – these may sound like the stuff of science fiction but, with medicine moving closer to altering our moral state, society should be preparing for the consequences, according to a book reviewing scientific developments in the field.”*

The “ultimate revolution”, as Aldous Huxley had put it almost a half century ago, would be *“to get people actually to love their servitude!”*

That “ultimate revolution” of full spectrum servitude is being brought to the Western shores in systematic crisis stages. Each crisis stage masking the preceding one, to appear independent and unrelated. The public naturally focuses on the most recent crisis which is tearing their lives apart, and remain unable to distinguish between cause and effects that are cumulatively and systemically disintegrating their free society into a draconian police-state, one crisis stage at a time. This calculated lapse of public understanding works beautifully in the interest of those who are the first-cause of the Social Darwinian disease of primacy, the untouchable oligarchy. These murdersome *Hectoring Hegemons*, the *Brotherhood of Death*, perceptively understand that which the public mind simply cannot comprehend. Namely, that the political and social engineering of how to usher in unpopular transformations, the piecemeal erosion of national sovereignty to create world government, requires the creation of overwhelming *“revolutionary times”* which can make the public's reality *“look like a great ‘booming, buzzing confusion’ to use William James’ famous description of reality,”*. Each new *‘booming, buzzing confusion’* provides the new enabling pretext for inching the world one baby-step closer towards the Global Governance of the Planet by the oligarchy. Because they control the global mass media and the Mighty Wurlitzer's infinite capacity to mold national destinies, they are always successful in getting public perception to focus on whatever they wish to fabricate, instead of the public

accurately perceiving its zeitgeist as an interconnected whole (see [Some Dare Call it Conspiracy! Are you among them?](#)).

All this mind-fck primes the desperate public mind to easily accept the equally shocking remedies that are proffered up to alleviate the crisis in the cacophony of experts and useful idiots. Much effort gets expended by the many doctors of society, some mercenaries, some dupes and patsies, and with much fanfare, in chasing the remedies for the most shocking symptom with little impact on the actual disease which remains largely undiagnosed. Even the most brilliant and honest social and political physicians get caught in this mind-fck. The master sociologist of all times had insightfully observed of this principle of social engineering in his own epiphany to *the white man's burden*. I hope I may be forgiven if I see the many convoluting parallels at many levels too acute to deny:

“The cure of a sickness can only be achieved if its cause is known, and the same is true of curing political evils. To be sure, the outward form of a sickness, its symptom which strikes the eye, is easier to see and discover than the inner cause. And this is the reason why so many people never go beyond the recognition of external effects and even confuse them with the cause, attempting, indeed, to deny the existence of the latter.” -- Mein Kampf, 1:10, *Causes of the Collapse*

Indeed, even commonsense suggests that the cure of a sickness can only be achieved if its primary cause is known, and the same is true of curing political evils which create and sustain all others. In my [Response to Nihilists](#) and [Letter to Muslims](#), I examined the *new color* that Western society is being so methodically painted in with the delicate and sophisticated brush strokes of Secular Humanism, as a necessary adjunct to getting them to love their own cannibalistic servitude. This ain't a matter to be digested within the 15-second attention span that Westerners are taught to parse headline news with. If there is any truth to the sociologists' statistic that *less than 2% people actually think, 8% think they think, and 90% would not be caught dead thinking*, all plebeians are gonna have to work really hard to comprehend the Hegelian mind-fcks we are being routinely dished to prime us for “voluntarily” accepting the New World Order. As far as the *hectoring hegemons* are concerned, the North Western '*white trash*' only occupy a different pecking order from the '*untermensch*' of the East and the South. The misery at least ends for the dead. The *wretched of the earth* must continue to live in full service to the masters, wherever they might be, until it is their turn to be served at the dinner table. As meal. And if the wretched can be kept in a happy-happy state while waiting for their turn, voluntarily acceding to what is happening to them, so much the better. See [What can be done?](#).

Zahir Ebrahim

Project Humanbeingsfirst.org

## Footnotes

**Part-1:** [My experiments in confusion – Part-1: How many Jews does it take to confuse me? Response to 'How many Rabbis does it take to create a Racist State?'](#)

**Part-2:** [My experiments in confusion - Part-2: The invisible House of Rothschild](#)

**Part-3:** [My experiments in confusion - Part-3: The Omnipotent Rothschilds](#)

**Part-4:** [How many Gentiles does it take to confuse me? Evidently, also only One! Part-4](#)

**Part-5:** [My experiments in confusion - Part-5: Letter to Prof. Kevin MacDonald](#)

**Part-6:** [The white man's burden still looks white in color - Zahir Ebrahim's Response to John Kaminski's "There are no good Jews"](#)

**Response to Nihilists:** <http://bloghumanbeingsfirst.wordpress.com/2011/02/17/zahir-ebrahims-response-to-nihilists/>

**Letter to Muslims:** <http://humanbeingsfirst.wordpress.com/letter-to-muslims/>

**What can be done?:** <http://print-humanbeingsfirst.blogspot.com/2011/03/kosovo-in-arc-of-crisis-by-zahirebrahim.html#What-can-be-done>

**Short URL:** <http://tinyurl.com/The-White-Mans-Burden>

**Source URL:** <http://print-humanbeingsfirst.blogspot.com/2011/02/white-mans-burden-uniformly-distributed.html>

First Published February 19, 2011



## Chapter 14 The Oligarchs

### My experiments in confusion - Part-2: The invisible House of Rothschild

See Part-1: [How many Jews does it take to confuse me?](#)

See Part-3: [My experiments in confusion - Part-3: The Omnipotent Rothschilds](#)

Continuing from Part-1...

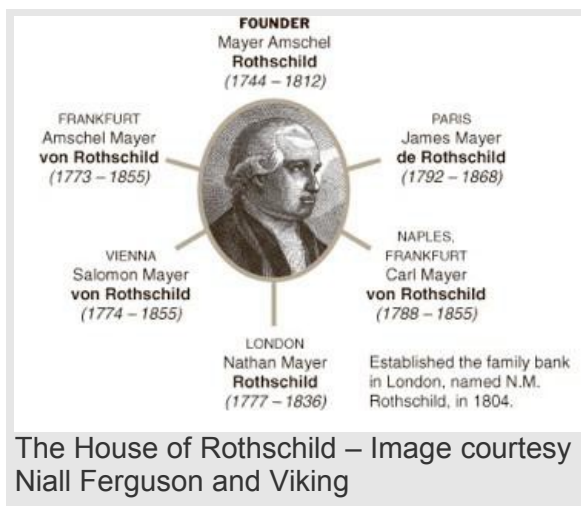

Let me highlight the socio-political conundrum identified in [part-1](#), quoting myself (since no one else ever quotes a confused person): *“Perhaps I am going about this free-thinking business all wrong? Perhaps there is some happy halfway compromise to fully independent thinking which will also help me gain friends and influence people?”*

The following example almost always loses me friends, tempting me to stop experimenting with independent thought altogether. I believe it is a miracle that I still dabble in it every now and then. I observed the following conundrum in my essay '[Of Ostriches and Rebels on The Hard Road to World Order](#)':

#### Excerpt

'Herman Van Rompuy's message of hope at the completion stages [of world order] decades later was merely the cross-generational echo of Richard N. Gardner's *“prospects for peace, welfare and human dignity”* that had been long sewn *“bottom up, rather than from the top down”* such that to the uninformed public, it would always *“look like a great ‘booming, buzzing confusion’ to use William James’ famous description of reality, but an end*

*run around national sovereignty, eroding it piece by piece will accomplish much more than the old-fashioned frontal assault.”*

The blood-drenched transformation stage that we find ourselves in today – the wreckage of civilizations – is truly *“Between Two Ages”*. That brilliant description is not mine, but the title of Zbigniew Brzezinski's seminal self-serving 1970 book which [presumably] got him appointed as the Executive Director of David Rockefeller's Trilateral Commission. There are more than a dozen Trilateralists and CFRs in President Obama's Administration too, pushing the banksters' globalist agendas finally to fruition across multiple fronts simultaneously. The money behind them, at least in the United States, is primarily the Rockefellers' who own the majority stake in the New York Fed, which in turn largely controls the Federal Reserve System. In Europe, the money is primarily the Rothschilds' who control all the world's private central banks (including America's Federal Reserve and international lending-policing agencies such as the World Bank IMF tag-team and the WTO) with complex interlocking relationships among a closed-knit tiny fraternity who exercise their will upon international banking and global finance and thus upon all nations of the world, through their largely unknown Bank for International Settlements (<http://BIS.org>) located in Basle, Switzerland.

Entirely coincidentally of course, BIS is located in the same secretive banking capital where Theodor Herzl had earlier made his notorious Jewish manifesto, *Der Judenstaat* public in the First World Zionist Congress in 1897 to set the public stage for the creation of the exclusively Jewish state of Israel in 1948. Also entirely coincidentally, the British Empire had gratuitously issued its famous 1917 Balfour Declaration in the name of Lord Rothschild, the principal owner and founder of the international financial system who had controlled the Bank of England since Waterloo. And again entirely coincidentally, America's entry into World War I was facilitated after the founding of its own 'Bank of England', i.e., the Federal Reserve System principally by Paul Warburg, the banking fraternal twin of Lord Rothschild in whose palace the Treaty of Versailles was signed after World War I to enable the British Mandate over the lands of historic Palestine.

These remarkable coincidences have today made the Rothschilds the most revered family name in Israel. Some call them the King of the Jews – and to live up to that Solomon-ly title, the Rothschilds have architected, financed

and built the Jewish state's principal hall of Justice, the Israeli Supreme Court in Jerusalem. The Jewish State today enjoys the unparalleled privilege of an "Iron Wall" that none can breach. The Rothschild's frankenstein can with brazen impunity exterminate, assassinate, and bomb, to the applause of the world leaders (see 'Pamphlet: How to Return to Palestine'). And yet, strangely, the Rothschild's role in seeding and orchestrating the affairs of the modern world is consistently downplayed almost universally. No media, no academic, no scholar, no historian, no dissent-chief, no corporate executive, no billionaire on Forbes list, the Forbes list itself, and of course no politician and world statesman, dare utter that name publicly – and so long as they don't, they can say anything else they want. Elusive power such as this is not a figment of someone's imagination.

Prof. Carroll Quigley was permitted to openly state the following in his 1966 book *Tragedy and Hope*, and his controlled revelations which continued that tradition of downplaying the name of the Rothschilds, only came on the heels of the free-wheeling Eustace Mullins' well-documented exposé of how the Federal Reserve System in the United States was conspiringly created by forces representing the same globalist banking elite, and he had not spared the Rothschild name; this was followed by a series of books and documentary films in the 1970s by many others including Gary Allen, W. Cleon Skousen, G. Edward Griffin, Antony Sutton et. al.'

### **End excerpt**

I dared to think about that palpable omission on my own, inviting both confusion and loss of friends.

**I asked:** why was that most distinguished and singular Jewish family name, Rothschild, never permitted any significant mention not just in the Western press, but in the worldwide mainstream presses? It surely wasn't only because the AP and other news agencies, newspapers, newsmedia, were interlocking owned/controlled by the uber financiers of the world, the House of Rothschild.

Even the brave president of Iran, Dr Ahmadinijad, and the brave president of Venezuela, Chavez, courageously challenging the status quo of the world anytime they acquire a microphone in their hands have not dared to mention that name. It is evidently still risk free to waive Noam Chomsky's 'Hegemony and Survival' from the UN podium and speak out against the criminal excesses of the sole superpower and its Allies du jour, but not okay to

wonder out loud why was the Balfour Declaration issued in the House of Rothschild name?

Hmmm.... What sort of elusive omnipotent power did that magical name command such that it had erected an equally magical "Iron Wall" around Der Judenstaat? An "Iron Wall" which protected the Zionists' grotesque re-settlement and extermination project for Jewish Lebensraum being conducted with brazen impunity, often under thunderous applause of the Western leaders who continually renew their vows to support the expansion of the Jewish State created in the very name of Lord Rothschild, that none living dare mention and investigate that name while they continue to pay lip-service in support of the Palestinian peoples?

The Palestine freedom zealots in the West can boldly investigate and indict the dispensable Israeli leaders who come and go every election, but not its founder who evidently goes on forever?

By the Rothschild's own watered-down admission, **they are not a has-been House:**

'We provide advice on both sides of the balance sheet, and we do it globally. ... We have had 250 years or so of family involvement in the finance business, ... There is no debate that Rothschild is a Jewish family, ... For a family business to survive, every generation needs a leader, ... Then somebody has to keep the peace. Building a global firm before globalisation meant a mindset of sharing risk and responsibility. If you look at the DNA of our family, that is perhaps an element that runs through our history.' --- Baron David de Rothschild, *The first barons of banking* by Rupert Wright, UAE thenational.ae, November 6, 2008

That humble confession by Baron David de Rothschild quoted above exactly fulfills in this generation, the well-known directives issued by their forefather, the founder of the House of Rothschild, Mayer Amschel Bauer. A long staple of Rothschild biographers, the founding directives are even vicariously depicted by Hollywood in the 1934 film which was intended to be an ode to the Rothschild name. Watch this [short clip](#) of the movie *The House of Rothschild*, about half way through in that clip, the historical depiction from the mouth of great-grandfather Amschel Rothschild, is empirically being fulfilled today, 250 years later, as glibly confirmed even in that watered-down admission from his own great-grandson, David de Rothschild!

The UAE National newspaper even openly stated its lack of faith in the 'coincidence theory' of history and noted the overarching contemporary significance of the House of Rothschild:

'Among the captains of industry, spin doctors and financial advisers accompanying British prime minister Gordon Brown on his fund-raising visit to the Gulf this week, one name was surprisingly absent. This may have had something to do with the fact that the tour kicked off in Saudi Arabia. But by the time the group reached Qatar, Baron David de Rothschild was there, too, and he was also in Dubai and Abu Dhabi.

Although his office denies that he was part of the official party, it is probably no coincidence that he happened to be in the same part of the world at the right time. That is how the Rothschilds have worked for centuries: quietly, without fuss, behind the scenes.' --- Ibid.

In fact, according to the following article in the London Times, the Rothschild's is the one unusual financial House in the world which came out ahead without any legal extortion, ahem, financial bailouts of people's money legally granted by the people's elected Representatives to the robber barons of modernity (watch that bizarre extortion racket for the forced Bailout in the United States in October 2008 here: <http://youtube.com/watch?v=sN3a1oTdDwM> , and witness my further confused experiments in independent thought in 'Why Bluff Martial Law?')

### **Excerpt**

'Not all investment bankers are having to get by on reduced or no bonuses this year. Rothschild group staff have received record bonuses, it has emerged after the bank reported a 31 per cent improvement in profits before tax to €459 million.

Record results from both its advisory and private banking operations enabled the bank to pay the bonuses to its 2,700 people in June.

Unlike conventional investment banks Rothschild, whose chairman is Davide de Rothschild, has steered clear of proprietary trading, prime broking and other activities that have devastated rivals, although it still wrote off €96 million because of souring loans.

Rothschild's year-end of March means the bonuses were paid before the most serious setbacks to banks. Most investment banks pay out bonuses between January and May. Goldman Sachs is due to tell its staff the size of their payouts in the next three weeks.

Alongside its pro-forma group-wide results, Rothschild unveiled a joint venture with Rabobank of the Netherlands, whereby the two sides will pool their staff and clients in the food and agriculture sector.

As part of the deal, Rabobank is buying a 7.5 per cent stake in one of the key holding companies in the Rothschild empire, Rothschild Continuation Holdings, which owns the N M Rothschild business in the UK.

Rabobank becomes the second biggest investor outside the family after the trading group Jardine Matheson, which owns 20 per cent. Rabobank's vice chairman Sipko Schat joins the Rothschild board.

It is the second joint venture with a Dutch bank. Rothschild teamed up with ABN Amro for 11 years in equity capital markets before dissolving the arrangement when Royal Bank of Scotland took over ABN last year.

Rabobank's stake was held in treasury by Rothschild after it bought it from the insurer Eagle Star. No price was put on the deal. Jardine paid \$185 million for its 20 per cent in 2005.

Rothschild advisory clients include Rio Tinto, which is fighting a hostile bid from BHP, British Energy in its deal with EDF of France and Alliance & Leicester when it was sold to Banco Santander.' --- Rothschild pays out record bonuses to staff by Patrick Hosking, London Times Online, November 19, 2008

### **End Excerpt**

With full spectrum control of the world's private central banks and BIS firmly in the hands of the House of Rothschild and their closed knit coterie, I of course, in my confused experiment of thinking for myself, chalk that wizard financial success of bailing out from publicly traded banks about to fail in a timely manner, and having only successes for one's own private family bank, up to just another coincidence. I strongly suspect that Gary Allen's confusion on such coincidences far exceeded mine as evidenced from his book *None Dare Call it Conspiracy*:

'Those who believe that major world events result from planning are laughed at for believing in the "conspiracy theory of history." Of course, no one in this modern day and age really believes in the conspiracy theory of history -except those who have taken the time to study the subject. When you think

about it, there are really only two theories of history. Either things happen by accident neither planned nor caused by anybody, or they happen because they are planned and somebody causes them to happen. In reality, it is the "accidental theory of history" preached in the unhallowed Halls of Ivy which should be ridiculed. Otherwise, why does every recent administration make the same mistakes as the previous ones? Why do they repeat the errors of the past which produce inflation, depressions and war? Why does our State Department "stumble" from one Communist-aiding "blunder" to another? If you believe it is all an accident or the result of mysterious and unexplainable tides of history, you will be regarded as an "intellectual" who understands that we live in a complex world. **If you believe that something like 32,496 consecutive coincidences over the past forty years stretches the law of averages a bit, you are a kook!** --- Gary Allen, None Dare Call it Conspiracy, 1971, Chapter 1

But more pertinent to my confusion for the main point under consideration, namely, the bizarre silence on the Rothschilds when it comes to the topic of the holy lands which they 'own' completely, as even demonstrated to the most ardent zealot fighting the cause of Palestine by the fact of the Balfour Declaration gratuitously awarding Palestine to the entire Jewish peoples being specifically in just that one singular name, doesn't that omission appear frighteningly absurd once again? See for instance: ['Zahir's Response to Francis Boyle's Jewistan – What Elephant?'](#).

Well, to me that silence is just as absurdly confounding as the bizarre merrymaking with the 'Happy Unbirthday' song at the Mad Hatter's Tea Party confounded Alice in Wonderland.

So, while searching for a way out of these absurd confusions rapidly piling up, I found this really bizarre interview asking similar questions for the first time in modern times, about the House of Rothschild, and I transcribed it: ['Rothschild Connection to World Government and Zionism: David Icke – Origins and Symbolism of the EU'](#).

Please see what you make of such attempts at independent thinking. Also please feel free to advise me how one ought to go about this independent thinking business, the much wanted contribution of Western civilization to modern man, or so they say, without stepping on censor toes – never mind without losing friends. Even this last thought is causing me a great deal of confusion. But first, here is the interview.

### **Excerpt**

Transcription of Red Ice Creations' David Icke's video interview by Project Humanbeingsfirst, segment on The Rothschild Connection to World Government and Zionism, Parts 6 & 7 [Parenthesis are Transcriber's notes]

[ youtube=<http://youtube.com/p/03D36F59DC6F1259> ]

Begin Transcription:

'They are all connected, and they are connected through the House of Rothschild.

See, if people just took a breadth, and looked at the whole scene, they would ask serious questions:

Foreign Office,  
November 2nd, 1917.

Dear Lord Rothschild,

I have much pleasure in conveying to you, on behalf of His Majesty's Government, the following declaration of sympathy with Jewish Zionist aspirations which has been submitted to, and approved by, the Cabinet

"His Majesty's Government view with favour the establishment in Palestine of a national home for the Jewish people, and will use their best endeavours to facilitate the achievement of this object. It being clearly understood that nothing shall be done which may prejudice the civil and religious rights of existing non-Jewish communities in Palestine, or the rights and political status enjoyed by Jews in any other country"

I should be grateful if you would bring this declaration to the knowledge of the Zionist Federation.

A handwritten signature in dark ink, appearing to read 'Arthur Balfour', with a small heart-like mark above the 'i' in 'Balfour'.

[ Why is the Balfour Declaration addressed to a Rothschild? ]





[ Why is Israel's Supreme Court in Jerusalem built by the Rothschilds? ]

Why does that slither of land, called Israel, and I have driven around it, and you can virtually drive around it in a day, why does it have so much power?

Why is it the biggest by far recipient of American aid when it is one of the richest per capita countries in the world?

Why does it have the biggest F-16 fleet outside America?

How come it can have a very considerable arsenal of nuclear weapons, refuse to sign a Non Proliferation Treaty, and have a breadth taking agreement which has just been confirmed by Barrack Obama in the last few months, that they have a policy in terms of America and other countries in Israel, that they don't ask whether they have got nuclear weapons. And therefore, Israel does not have to say if they have or not. This is an official policy!

Why, when they pepper-bomb the most crowded piece of land in the world, and instigate slaughter on a shocking scale, does the international community, apart from one or two people, say nothing?

[ <http://print-humanbeingsfirst.blogspot.com/2008/05/celebrating-israels-60th-birthday.html> ]

Simple.

The House of Rothschild controls Israel. It created Israel. And more than that, it created a political philosophy, note a POLITICAL PHILOSOPHY, called ZIONISM.

[ <http://print-humanbeingsfirst.blogspot.com/2009/02/letterto-dalitvoice-which-god.html> ]

What they have brilliantly done, though it's breaking down, is they have equated Jewish people as a race with Zionism, which is a political philosophy. And at its core is a secret society, connects into the other secret societies.

And, so if you challenge Zionism, and its horrors, and its impositions, and its

hypocrisy, and its slaughter, you are equated with being prejudiced against Jewish people.

What they don't tell you is significant number of Jewish people are actually appalled by Zionism. And actually openly protest against it.

[ <http://print-humanbeingsfirst.blogspot.com/2009/11/genesis-to-genocide-golem-not-jewish.html> ]

And there is some fantastic young people in Israel that refuse to serve in the military, and end up in jail because of it. And you, know they are incredible people to have that sense of value.

The questions that I have just posed can be answered very easily.

[ <http://print-humanbeingsfirst.blogspot.com/2009/10/respto-what-cost-israel-lobby-jeffgates.html> ]

The House of Rothschild control American politics. They control the neo-cons, they control Bush, they control what I call the demo-cons that control Obama.

[ <http://humanbeingsfirst.blogspot.com/2008/10/not-voting-is-yes-vote-to-reject-system.html> ]

And in the White House as I speak, we have the White House Chief of Staff, Rahm Emanuel, who is the puppeteer, immediate puppeteer of Obama, [ Just like Bush's Brain was Karl Rove ] and his father actually served in an Israeli Zionist terror group called Irgun, which, with others, bombed Israel into existence and forced 750,000 to 800,000 Palestinians to leave their homeland after 1948.

The reason, therefore, that Israel is the biggest recipient of American aid and military support, is because this hand [points to right hand] called the House of Rothschild, takes the money from the United States and hands it to this hand [points to left hand] called Israel of the House of Rothschild, and says thank you very much!

The reason that there is no questioning of Israeli nuclear capability, that they get away literally with mass murder, time and time again, is because the

House of Rothschild controls the countries of the European Union, and controls the European Union. I mean, Tony Blair is a "yes sir no sir, three bags full sir, how high would you like me to jump sir" front man for the House of Rothschild.

[ <http://print-humanbeingsfirst.blogspot.com/2009/11/rescuing-the-struggle-for-palestine.html> ]

So who do they put in after he left the British Government, as negotiator of peace in Israel - Tony Bloody Blair! 'What should I say Mr. Rothschild, thank you very much, thank you thank you' [mimics Tony Blair]. That's it.

So when you have got the same force controlling all these different agencies, than of course they are gonna be coordinated.

That's the way Israel gets away with what it gets away with.

And if people think its anti-Semitic, well actually anti-Semitic means anti-Arab by the way, then they'll have to take it and shove it somewhere where the sun don't shine 'cause I ain't shutting up about this because it is fundamental to understanding the world, and to understanding the European Union and world events!

The Jewish people, in general, have been mercilessly used by the House of Rothschild, and their front secret society, satanic secret society, called Zionism, as a front which they can hide behind.

[ <http://print-humanbeingsfirst.blogspot.com/2009/09/is-zionism-hegelian-dialectic.html> ]

So it is House of Rothschild organizations like B'nai Brith, Sons of the Covenant, who created an organization called the Anti-Defamation league, which goes around defaming everyone ironically, who have not just campaigned for hate laws that stop you exposing these people, they have actually written the bloody legislation in America, in North America and Canada.

And so, these hate laws which say you can't say this you can't say that, because that's prejudiced and all that, they are not there to protect gay people - everyone ought to their own I say, I couldn't care less - they are not

there to protect Jewish people, or minorities.

They are there, simply, to stop legitimate investigation of the Rothschilds and its network. That's what they are there for.

[ <http://print-humanbeingsfirst.blogspot.com/2009/10/respto-what-cost-israel-lobby-jeffgates.html> ]

And, they are in so many ways the Rothschilds. At operational level, the center of the spider's web.

And they need to be exposed.

[ 'Therefore, focussing on Jewish political action groups like AIPAC, ADL, JDL, Chabad Lubavitch Hasidics, et. al., who put Israel first to influence the superpower's policies, or the hundred Jewish-dominated opaquely funded private think-tanks like the AEI, CFR, et. al., who ab initio construct the polices of war and hegemony favoring Israel, without betraying any comprehension of the actual prime-movers behind them, is not only an exercise in futility, but these visible magnets are deliberately there, and manifest themselves with their inexplicable arrogance, precisely in order to draw fire away from the prime-movers!' -- <http://print-humanbeingsfirst.blogspot.com/2010/05/palestine-theway-forward.html> ]

Because if they get exposed, and they go, when I say go [I mean] they are removed from their positions of power, 'cause to be honest, if they went to jail, for what they have been responsible for, the House of Rothschild, they would have to reincarnate hundreds of times to complete the sentence!

[ 'If fair punishments are ever to be awarded for their crimes against humanity for just the past 100 years in any Just court of law, Adolph Eichmann would have to be retroactively let go by resurrecting his soul from his grave with high honors and awarded multiple peace prizes plus compensation, in order to administer hanging and extraction of restitution as the graduated scale of ultimate punishment for the ultimate prime-movers of all wars and pestilence before which their errand boys' and patsies' crimes against humanity pale in comparison.' -- <http://print-humanbeingsfirst.blogspot.com/2009/11/rescuing-thestruggle-for-palestine.html> ]

And, we've ignored them. Or we have not ignored them, people have ignored their power for long enough because they have brilliantly hidden it. It needs the light to be shone on it because when they come down, in so many ways, the House of cards comes down!

[ <http://print-humanbeingsfirst.blogspot.com/2010/04/resp-abusitta-rothschild-not-zabara.html> ]

Thank you very much.'

End Transcription by Project Humanbeingsfirst.org, Parts 6 & 7  
[Parenthesis: Transcriber's notes]

## **End excerpt**

## **Conclusion**

Aaaaaah, confusion, confusion! I could just scream. No wonder why the goyem don't think much, and it is not recommended for us to think by the doctors who conveniently do all the original thought experiments for us to save us the burden. Here is the problem alluded to earlier, stepping on censor toes, and it can only be the inevitable conclusion of our zeitgeist: If one avoids tabooed thoughts for fear of censorship, loss of friends, being indicted and incarcerated under the thought-crimes Bill pending in many a legislature's quarters worldwide, is that still considered 'independent thinking', the gift of Western civilization to mankind? Perhaps it is so under NewSpeak, the newly revised gift of Western civilization to the Dawn of the New Age?

The New Age being hasteningly beckoned by Zbigniew Brzezinski, cited above, wherein, he justified/rationalized humanity's deadly plight in our zeitgeist by quoting Hermann Hesse from *Steppenwolf* thusly; *"Human life is reduced to real suffering, to hell, only when two ages, two cultures and religions overlap. . . . There are times when a whole generation is caught in this way between two ages, two modes of life, with the consequence that it loses all power to understand itself and has no standard, no security, no simple acquiescence."*?

That profound insight, of brilliant hindsight and self-serving foresight, very well could be the elusive key I have been searching for to open the mysterious door past which I can't see.

## Further Study

To catch only a fleeting glimpse for yourself of that veil past which evidently no one else is able to see either, and which is seeding so much confusion among those wanting to do their own independent thinking that unless one opens up the final edition of the Newspeak dictionary described by George Orwell in his seminal work '1984' (watch the movie [here](#)), one is destined to stay confused, read the following two books by Eustace Mullins: *The World Order – A Study in the Hegemony of Parasitism*, and *The Curse of Canaan – A Demonology of History*. Additionally, *The Thirteenth Tribe* by Arthur Koestler, and *The Empire of "The City" (world superstate) – The Jekyll/Hyde Nature of the British Government* by E. C. Knuth, are both helpful in thinning out the powerful fog of confusion which surrounds the origins and the rise to power of Black Nobility. A careful study of these books (PDF available on the web; search, download and read them before these out-of-print books get banned, or, reading them is made a thought-crime), helps one understand the elusive power which has corrupted and co-opted almost all of dissent in the West today creating the sort of absurdities highlighted in my confusions. The pernicious nature of that indomitable power to mold, influence and corrupt across the board world-wide was captured in the following way by W. Cleon Skousen in his commentary on Carroll Quigley's *Tragedy and Hope*:

'The real value of *Tragedy and Hope* ... [is the] bold and boastful admission by Dr. Quigley that there actually exists a relatively small but powerful group which has succeeded in acquiring a choke-hold on the affairs of practically the entire human race. Of course we should be quick to recognize that no small group could wield such gigantic power unless millions of people in all walks of life were "in on the take" and were willing to knuckle down to the iron-clad regimentation of the ruthless bosses behind the scenes. As we shall see, the network has succeeded in building its power structure by using tremendous quantities of money (together with the vast influence it buys) to manipulate, intimidate, or corrupt millions of men and women and their institutions on a world-wide basis.' --- W. Cleon Skousen, *The Naked Capitalist*, pg. 6

The publicly available *need to research* (as in *need to know*) private archives of the House of Rothschild is now on the web. Presumably sanitized of any adverse material – since its primary purpose evidently is to glorify the 250 years of exploits of the House of Rothschild – for those inclined to experiment in forensic confusion, it may yet prove to be an invaluable treasure trove of discovery: <http://www.rothschildarchive.org/ta/> . The private Rothschild Archives I imagine is where the official biographers have always received their source

material to write their pandering odes to the House of Rothschild. See for instance, *The House of Rothschild* by Niall Ferguson. Now it's available to you as well!

For those unable to read, but still inclined to experiment in some self-inflicted confusion, Grace Power's Amenstop Production DVD 'Ring of Power' may be a good starting point (watch part-1, part-2, the second part focusses on the House of Rothschild). I rather like Grace Powers' DVD presentation which is based on some of the historical material presented in the above books, because she addressed her video to the lowest level mental acumen in Western society with an easy to follow narrative. I have never met Grace Powers, communicate with her every now and then over email, consider her a seeker of knowledge based on her work, but don't agree with her many esoteric opinions and conclusions which, rather strangely, anyone who speaks of the oligarchy, secret societies, and the Black Nobility, also often seem to hold. I am glad the authors whose books are recommended reading above appeared to be an exception to this bizarre contemporary empiricism. Mullins' *The Curse of Canaan* is an intriguing deconstruction of history which he based on his understanding of the Bible and study of the Talmudic literature. One may draw from Mullins' pointing fingers what one may, perhaps using Bruce Lee's wisdom expressed in his martial arts movie *Enter the Dragon*: **“Don't concentrate on the finger or you will miss all that heavenly glory”** (watch movie clip here).

I too apply such Zen of analysis to my own self-inflicted confusions (when I could just as well bow before 'experts' and save me the bother), and Grace Powers' work is no exception. What that specifically means in this case is not to throw the baby out with the bath water. Leave aside the speculative material for some future time, and focus directly on the rational analysis based on obvious and historical facts. On the whole, *Ring of Power's* narrative on the House of Rothschild is penetratingly contemporary, as Grace Powers attempts to forensically tie 9/11 and the documented historical quest for World Order of the Black Nobility for the average dumbed-down television watcher of America. If the size of the 'United We Stand' crowd and the size of protests in the immediate aftermath of 9/11 are any indication, the dumbed-down and indoctrinated peoples of America likely constitute well over 90% of its 300 million population!

What brazen absurdity once again. The mightiest superpower on earth in this information age is also home to the most ignorant and mind controlled peoples, including The Master Builders of the Technetronic Era! Who created such pathetic state of affairs in this once unassailable nation and why? There is very little time left for its public to find out. A short 10-minute readable summary is: 'Of Ostriches and Rebels on The Hard Road to World Order'.

**Short URL:** <http://tinyurl.com/Invisible-House-of-Rothschild>

**Source URL:** <http://print-humanbeingsfirst.blogspot.com/2010/12/my-confusion-invisible-rothschild-usa.html>

First Published December 13, 2010



## Chapter 15 The Omnipotent Rothschilds

### Where is the Evidence? Part-3

Continuing from [Part-2](#), where Baron David de Rothschild was quoted proclaiming:

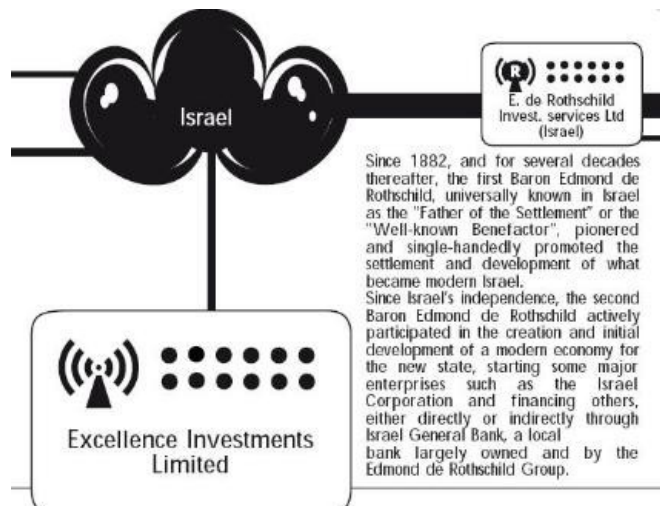

Caption World Governance By The Rothschilds, 2003 - **Click image for expanded view**

**GOVERNING BY NETWORKS.** See partial expansion at end (Image via bibliotecapleyades-net via bureaudetudes-org large 3 MB)

**Building a global firm before globalisation meant a mindset of sharing risk and responsibility. If you look at the DNA of our family, that is perhaps an element that runs through our history.'** --- Baron David de Rothschild, The first barons of banking by Rupert Wright, UAE thenational.ae, November 6, 2008

When, in my state of perpetual confusion whereby my experiments in independent thinking sometimes get out of hand, I have immoderately challenged many a rebel leader on their omitting to mention the *Rothschild* name in their otherwise erudite critiques of modernity, I have always come up empty handed. This is amply demonstrated in my responses to [Salman Abu Sitta](#), [Antoine Raffoul](#), [Ismail Zayid](#), [Khalil Nakhleh](#), [Shadi Nassar](#), [Mustafa Barghouti](#) and [Anna Baltzer](#), [Jeff Gates](#), [Jeff Blankfort](#), [et. al](#). My most recent challenge was yet another unsolicited letter, this time to an old timer Western rebel of the United

**'We provide advice on both sides of the balance sheet, and we do it globally. ... We have had 250 years or so of family involvement in the finance business, ... There is no debate that Rothschild is a Jewish family, ... For a family business to survive, every generation needs a leader, ... Then somebody has to keep the peace.**

States of America, Mr. Jeffrey Blankfort. He courteously replied:

**'I do not mention the Rothschilds because I have yet to see a single shred of evidence that they control the world's money supply, the CFR, or anything else of such substance as to influence the way the world works. As far as I can tell whereas once members of the Rothschild banking family ran the banks of Western Europe, I see no evidence that they do so today. ... Again, if you have any direct evidence with unimpeachable sources that the Rothschilds are running everything or for that matter anything behind the scenes I would appreciate receiving it but lacking that up to now, I never mention their name apart from Walter Rothschild being the recipient of the Balfour Declaration.'** --- Jeffrey Blankfort replying to Zahir Ebrahim Nov. 11, 2010 (see full correspondence [here](#))

I was simply delighted that my new friend Jeff Blankfort had even bothered to write back, as most brilliant chiefs, both Eastern and Western, gallantly rising to defend the Palestinians as their own cause célèbre, simply tend to ignore the meddlesome and the confused who don't buy their craftsmanship. The crazy thing is, that among the Palestinians themselves, many appear to prefer running from Jew to Jew to solve their problems, as was observed by a Palestinian friend of mine out of sheer frustration: ***“We run from Jew to Jew, they create the problem, and also argue the solution, they control the full spectrum of our discourse as well as our existence.”*** I promised Jeff: *“Thank you mon ami for your reply. I will compose a thoughtful reply later...”*

This [Part-3](#) attempts to respond to Jeff Blankfort's request for evidence for the trumpeting-defecating elephant in the bedroom. As quoted above, Jeff asked for ***“direct evidence with unimpeachable sources”***.

I will humbly endeavor to provide both – **direct, unimpeachable**. And before concluding, I will even suggest that the legal standard itself for proving criminal conspiracy is far less than what Mr. Blankfort has generously demanded from me, for the obvious reasons that even half-smart conspirators usually hide behind their errand boys, like the Mafioso, and don't leave their calling cards. More empirically however, unlike the dumb Mafioso who rob, extort, and kill illegally thus enabling the state policing apparatuses to be used to juridically hang them, brilliant conspirators usually enact legalisms and statutes, and directly employ the state's governing apparatus itself to mask and legalize their dastardly plunders, their war-mongerings, their social-engineerings, and their pernicious subversions of the peoples' democratic institutions and constitution. Even the flag-waiving ordinary indoctrinated

American understood how that craftsmanship worked when he and she witnessed the banksters' bailout extortion racket in October 2008 (see '[Why bluff Martial Law](#)') and their subsequent brazen accounting of how they spent it ([watch](#)).

And yet, the law of un-intended consequences, i.e., nature, still has its ways to un-obscure the golem if one has the eyes and the will to perceive.

Let me first state the criterion for proof as Blankfort did not stipulate any beyond "*direct, unimpeachable*". I intend to demonstrate that an omnipotent power exists, that such a power visibly existed not too long ago using unimpeachable sources, and since there is no evidence of such a power suddenly eviscerating, that by the sheer force of logic, it must still exist even if occulted from mainstream Americans today. And I will top that off with the confirmation of its own existence by the omnipotent power itself. I invite the readers to pretend that they are a jury member, and reach their own verdict whether the following can be sufficiently deemed "*direct evidence*" from "*unimpeachable sources*" to satisfy the request of Jeffrey Blankfort and all those like him who choose to willfully remain *innocent of knowledge* of the most glaring, trumpeting, shitting, elephant in the bridal suite.

First, the unimpeachable source: **Nuremberg Military Tribunal and its official Record**. I don't think there can be anything more unimpeachable a source than that, do you?

Let's first see what transpired at Nuremberg in the score-settling with victor's justice in the aftermath of World War II with respect to the Nazi banker most instrumental in financing the Nazi war machine, Hjalmar Schacht. While 21 Nazi chiefs were hanged ([watch](#)) by Robert H. Jackson, the chief prosecuting counsel for the United States ([watch](#)), the banker whom the chief counsel as the official representative of the United States government to the Nuremberg Military Tribunals, most wanted to hang, was set free due to the intervention from the Bank of England governor Sir Montagu Norman!

Say what? Bank of England is so powerful that it prevailed upon their own military Allies at Nuremberg to let go of the principal enemy who financed the destruction of entire Europe and of the British Empire itself – with agreement from all the Allied military high command and their governments (with only Russia dissenting)? No, you did not read that in history books did you, nor did you hear Noam Chomsky talk about the inconvenient case of Hjalmar Schacht even when he waxes eloquence about victor's justice at Nuremberg by highlighting the case of Admiral Karl Dönitz, and evidently, nor did you hear Mr. Jeffrey Blankfort bring it up in all his dissent-ing critique of Noam Chomsky.

I get really confused when I encounter such blind-sighted omissions regarding the King of

the Jews among the moral Jews who become dissent-chiefs for the dumb goy, and book-end their own dissent so wonderfully while still giving the illusion of vigorous debate. Chomsky explains this Machiavellian construction rather elegantly even as he implements it himself with involuntary help from his own antagonist, Jeff Blankfort, and the goyem cheer for their favorite horse – don't matter which horse wins, the real winners are those who benefit from the calculated omissions, the race course owners:

‘This “debate” is a typical illustration of a primary principle of sophisticated propaganda. In crude and brutal societies, the Party Line is publicly proclaimed and must be obeyed — or else. What you actually believe is your own business and of far less concern. In societies where the state has lost the capacity to control by force, the Party Line is simply presupposed; then, vigorous debate is encouraged within the limits imposed by unstated doctrinal orthodoxy. The cruder of the two systems leads, naturally enough, to disbelief; the sophisticated variant gives an impression of openness and freedom, and so far more effectively serves to instill the Party Line. It becomes beyond question, beyond thought itself, like the air we breathe.’

‘Democratic societies use a different method: they don't articulate the party line. That's a mistake. What they do is presuppose it, then encourage vigorous debate within the framework of the party line. This serves two purposes. For one thing it gives the impression of a free and open society because, after all, we have lively debate. It also instills a propaganda line that becomes something you presuppose, like the air you breathe.’

‘The smart way to keep people passive and obedient is to strictly limit the spectrum of acceptable opinion, but allow very lively debate within that spectrum – even encourage the more critical and dissident views. That gives people the sense that there's free thinking going on, while all the time the presuppositions of the system are being reinforced by the limits put on the range of the debate.’ --- Noam Chomsky.

At this point, before I go any further, please permit me to dust out the following observation of novelist Aldous Huxley in the *Brave New World* to illustrate why I consider artful omissions and silence, as counter-intuitive as it might appear to the profoundly *innocent of knowledge*, to be a most powerful propaganda tool:

**‘The greatest triumphs of propaganda have been accomplished, not by doing something, but by refraining from doing. Great is truth, but still**

greater, from a practical point of view, is silence about truth. By simply not mentioning certain subjects, by lowering what Mr. Churchill calls an “iron curtain” between the masses and such facts or arguments as the local political bosses regard as undesirable, totalitarian propagandists have influenced opinion much more effectively than they could have done by the most eloquent denunciations, the most compelling of logical rebuttals. But silence is not enough. If persecution, liquidation and the other symptoms of social friction are to be avoided, the positive sides of propaganda must be made as effective as the negative.’ — Aldous Huxley, Preface (circa 1946) to *Brave New World*, 1931, Harper, pg. 11

I have to wonder about my sanity sometimes – why don't I get it when brilliant chiefs inexplicably dabble in their own thought control, in their own self-policing?

Why do I persist in experimenting with independent thinking? Just accept the pious statements of the Jewish chiefs that there is not a shred of evidence of the existence of the King of the Jews controlling the state of affairs in the world today, lest I be labeled a 'kook', a 'denier of established truths', and carted away to some re-education camp for my own, as well as other's safety! 'Denier' I have already been anointed by none other than a recovering Jew, a reformed Zionist, Christian friend of mine, Israel Shamir! Yes, I know I have accumulated some lovely friends in my few journeys into the unknown world of independent thinking! I now try my best to stay away from such confusions, and I believe this is one of my last few times as my new year's resolution!

Before we jump too far ahead as I briefly did in the preceding passages to give a taste of the acerbic logic about to develop, let's study this shockingly revealing fact of Hjalmar Schacht which is so uncontrovertibly recorded in the pages of victor's justice at Nuremberg, and the circumstances surrounding this fact. The following is excerpted from David Irving's **Nuremberg, the Last Battle** ( [PDF](#) ). It appears in my document “Monetary Reform: Who will bell the cat?” as footnote [11] and [13] and is reproduced below along with the passage being footnoted:

'Yes, confessionals after faits accomplis, is a characteristically “cleansing” Christian tradition. Somehow, it only seems to work for those in absolute power, never for the common man. **“You're right, we did it. We're very sorry. But thanks to you, we won't do it again”** [Ben Bernanke to Milton Friedman] doesn't seem to be part of the ordinary judicial system where the common man is made accountable for stealing bread. But it is part of the

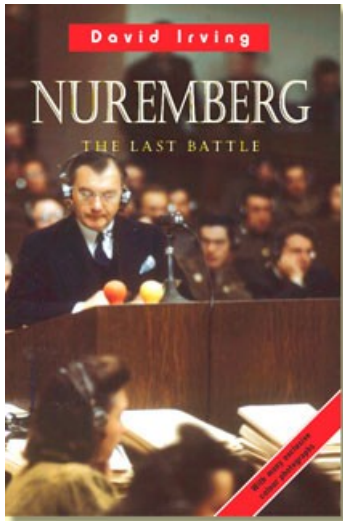

Caption Nuremberg, the Last Battle: Bank of England overriding the victorious Allies and freeing the Nazi Banker Hjalmar Schacht from the hangman's noose

Nuremberg Military Tribunals which let Dr. Hjalmar Schacht, the former governor of the Reich Bank [11] – the bankster who orchestrated the financing for Hitler and enabled his war machine with funding from Wall Street [12] and the City of London financiers – go scot-free!

Whence such awesome power to even let a fascist banker who caused the destruction of all of Europe – as per the Nuremberg established principle of **“all the evil which follows”** – become a prominent and influential member of the financial community once again in post-war Germany **“as though there had never been a blemish on his character”**? [13]

Footnote [11] Dr. Hjalmar Schacht (Reich minister of economics until 1937, Reichsbank president until 1939). David Irving, Nuremberg, The Last Battle, 1996, page 160.

“[Jackson] regarded the former president of the Reichsbank as the most contemptible of all the defendants. He had provided the finance for the spectacular rise and rearmament of Hitler’s Germany. More than any other, this man’s financial genius had paved the way for the violation of the Versailles Treaty.” (page 157)

“Ambitious and arrogant, Schacht [Highest IQ 143, page 292] had walled himself in behind a belief in his own righteousness. He seethed with rage at being imprisoned with Hitler’s henchmen. He admitted to having violated the Versailles Treaty, but countered that since the Allies were in collusion against Germany this was no crime. .. He admitted rebuilding Germany’s run-down economy, but not for the purpose of waging war; Hitler had dismissed him as soon as he balked at the aggressive planning that began.” (page 293)

“Hjalmar Schacht – ‘after Göring the toughest of them.’ He [Jackson] had always regarded Schacht as one of the most despicable defendants. The banker’s arrogant attitude since the trial had begun only vexed him all the

more.” (page 327)

“Even more irritating for Jackson was that Schacht was overheard in the cells confidently predicting that he would be acquitted. Irritating rumours circulated that the prosecution of Schacht was not in earnest. Letter-writers taunted Jackson that he would never succeed in convicting a big banker – whether friend or foe, they were the new Untouchables. He soon became aware that the Nazi banker did indeed have friends in the most unlikely places and influence everywhere. One day one of his team, the eminent New York international lawyer Ralph Albrecht, reported to him that the British assistant prosecutor Colonel Harry J. Phillimore – later a lord justice of appeal in London\* – had accosted him in the hall outside the courtroom and urged the Americans to relax their remorseless pressure on the banker. When Albrecht, perplexed, asked ‘Why?’, Phillimore uneasily explained that certain representations had been made by Sir Montagu Norman, governor of the Bank of England from 1920 to 1944. ‘It would be most unfortunate,’ murmured the British colonel, ‘if anything were to happen to Schacht.’ In fact Schacht had been an informer of Sir Montagu, secretly apprising him of the political and financial decisions taken at the highest level in Berlin for sixteen years before the war.” (page 328)

“There is in the records of His Majesty’s treasury in the British archives an illuminating file on the efforts made by Sir Montagu Norman to get Schacht released.” (page 329)

“He [Jackson] regarded the case against the banker as a test of the good faith of the entire prosecution. As he had said in a secret meeting of all the chief prosecutors in April, of which there is a shorthand record in his files, ‘If the court, for instance, holds that we have no case against Schacht, then it seems clear that we can have no case against any industrialist, as the case against him is stronger than the others.’ ... He [Jackson] privately recorded later, ‘I would at least stand out forthrightly in demanding his conviction, convicting him if I could.’ He harried the banker mercilessly in the witness box, addressed him as ‘Schacht,’ tout court, confronting him with the evidence of his participation in Hitler’s aggressive planning until eventually the defendant had to admit that he had been untruthful about his dealings with the Führer. Jackson showed the Tribunal newsreel film of Hitler’s triumphant return to Berlin in July 1940 after the defeat of France – long after Schacht would have had them believe he had fallen into disfavour.

There was Schacht, in Prince-Albert morning coat and top hat, the only civilian among the generals waiting on the station platform to pump the Führer's hand – indeed with two hands he caught hold of the Führer's, stepped out of line, and followed him 'in almost lickspittle fashion,' as Jackson remarked later. And this was the Nazi gentleman for whom the British lawyer Phillimore and banker Sir Montagu Norman were interceding. All the more acute was Jackson's fury when the Tribunal – with only the Russian judge publicly dissenting – acquitted Schacht. Biddle, who read out this part of the judgement, claimed some months later that he had also wanted to convict, but the British had insisted on an acquittal and had left him no choice." (pages 329-330)

Also see page 392.

<http://www.fpp.co.uk/books/Nuremberg/NUREMBERG.pdf>

Footnote [12] Antony C. Sutton, *Wall Street and the Rise of Hitler*, 1976

[http://www.reformed-theology.org/html/books/wall\\_street/](http://www.reformed-theology.org/html/books/wall_street/)

Footnote [13] David Irving, *Nuremberg, The Last Battle*, 1996, page 402: "As he was released from his [Nuremberg] cell, German police stepped forward and arrested him. A German court sentenced him to eight years' imprisonment as a major offender under the denazification laws enacted by the Control Council in Berlin. He served two years in solitary confinement, and was eventually released in 1948. The world of banking absorbed him again as though there had never been a blemish on his character."

Let's also recall from my article "[Of Ostriches and Rebels on The Hard Road to World Order](#)" what Professor Carroll Quigley had stated about Montagu Norman, and all the other governors of world's private central banks:

'The powers of financial capitalism had (a) far-reaching aim, nothing less than to create a world system of financial control in private hands able to dominate the political system of each country and the economy of the world as a whole. This system was to be controlled in a feudalist fashion by the central banks of the world acting in concert, by secret agreements arrived at in frequent meetings and conferences. The apex of the systems was to be the Bank for International Settlements in Basel, Switzerland; a private bank owned and controlled by the world's central banks which were themselves private corporations. Each central bank, in the hands of men like Montagu



Norman of the Bank of England, Benjamin Strong of the New York Federal Reserve Bank, Charles Rist of the Bank of France, and Hjalmar Schacht of the Reichsbank, sought to dominate its government by its ability to control Treasury loans, to manipulate foreign exchanges, to influence the level of economic activity in the country, and to influence cooperative politicians by subsequent economic rewards in the business world.' (Carroll Quigley, *Tragedy and Hope*, 1966, Chapter 20, page 324)

'It must not be felt that these heads of the world's chief central banks were themselves substantive powers in world finance. They were not. Rather, they were the technicians and agents of the dominant investment bankers of their own countries, who had raised them up and were perfectly capable of throwing them down. The substantive financial powers of the world were in the hands of these investment bankers (also called "international" or "merchant" bankers) who remained largely behind the scenes in their own unincorporated private banks. These formed a system of international cooperation and national dominance which was more private, more powerful, and more secret than that of their agents in the central banks. This dominance of investment bankers was based on their control over the flows of credit and investment funds in their own countries and throughout the world.' (Carroll Quigley, *Tragedy and Hope*, 1966, Chapter 20, page 326)

Is it too rude to ask – that if Montagu Norman is merely among the **“technicians and agents of the dominant investment bankers of their own countries”**, then who is the dominant investment banker of England who has in fact controlled the Bank of England and the City at least since Waterloo?

#### **Rothschild N. M. and Sons.**

This is what they confirm of themselves today on their own [website](#): ***Rothschild has been at the centre of the world's financial markets for over 200 years. Today, it provides Investment Banking, Corporate Banking and Private Banking & Trust services to governments, corporations and individuals worldwide.*** Baron David de Rothschild has already been quoted in the beginning of this article, proclaiming: ***'We provide advice on both sides of the balance sheet, and we do it globally. ... We have had 250 years or so of family involvement in the finance business'***

But here we shall just stick with Nuremberg for the moment.

Sir Montagu Norman, at the behest of the owners of the Bank of England, set one of their own criminal banksters free from the clutches of the hangman's noose. Those owners, both commonsense and force of logic suggests, commanded at least that much power which could trivially prevail upon all of the Military Tribunal members, except Russia who voted against it. Americans had lost 300,000 soldiers in that 'just war' against the axis powers, the United Kingdom had lost its empire along with its *jewel in the crown*, and Europe lay decimated, 6 million Jews exterminated – we won't quibble with the holocaust industry here – 20 million Russians butchered, and sum-total of 50 million human beings, mostly Christians, and most of them German civilians under the unspeakable fire-bombings of civilian cities by the Allies, lost their lives in the name of fighting the aggression initiated by the Nazis which was even termed “... ***the supreme international crime differing only from other war crimes in that it contains within itself the accumulated evil of the whole***”.

Just watch the video of the closing speech of Robert Jackson condemning the Nazis (cited earlier). It was a superlative public relations Tribunal, because, it was utmost important for the United States of America, the emerging superpower from the ashes of World War II, to pontificate to the entire world its moral and military supremacy, and condemn the abhorrence of aggression of the Nazis as it was itself entering a new Cold War with the new enemy. Nuremberg was entirely about public relations. And the United States judges at Nuremberg wanted to make an outstanding example of the Nazi war machine and its bankster to demonstrate their own moral high grounds.

Despite all of these empirical motivations, those who controlled the Bank of England, call it *Foundation-X* for the lack of a better handle to refer to this non-existent power which none can see, could spring one of their own from the sure jaws of death?

This incontrovertible fact and its significance indicates the existence of a power which is superior to the combined power of the victorious allies of World War II.

So, the evidence of Hjalmar Schacht being set-free unequivocally demonstrates at least the existence of an elusive omnipotent power in 1946.

And we already know that this immense power also existed in 1917, when the Balfour Declaration was issued in its name (see [Part-2](#)).

Where did that amazing power, which was confirmed to exist in 1917 when it prevailed upon the British empire to grant the Zionists another's land, and again in 1946 when it prevailed upon the British and American empires to grant amnesty to their own arch enemy

Foreign Office,  
November 2nd, 1917.

Dear Lord Rothschild,

I have much pleasure in conveying to you, on behalf of His Majesty's Government, the following declaration of sympathy with Jewish Zionist aspirations which has been submitted to, and approved by, the Cabinet

"His Majesty's Government view with favour the establishment in Palestine of a national home for the Jewish people, and will use their best endeavours to facilitate the achievement of this object, it being clearly understood that nothing shall be done which may prejudice the civil and religious rights of existing non-Jewish communities in Palestine, or the rights and political status enjoyed by Jews in any other country"

I should be grateful if you would bring this declaration to the knowledge of the Zionist Federation.



Caption Revisiting the Curse of Canaan:  
The Balfour Declaration November 2nd  
1917 - The first-cause of Palestinian  
genocide in the Land of Canaan is in the  
Name of a Rothschild and yet they don't  
know that name!

classified documents, let alone unlock them of their public relations baggage. We shall just wait for [Wikileaks](#) to let us know if UFO-Abduction is indeed that elusive cause of their sudden vanishing from the face of the earth. [Julian Assange](#) has already hinted: "*it is worth noting that in yet-to-be-published parts of the cablegate archive there are indeed references to UFOs.*"

In the meantime, back here on earth outside the Plato's cave, by the sheer force of inevitable logic, I must rationally conclude that such a power, call it *Foundation X* (or Y), still exists right here on earth. And, since I have also not found, despite vigorous search in libraries and on the web, any evidence that the *Foundation-X* ownership surreptitiously changed hands except from generation to generation within the same DNA cess-pool, and as admitted by the scions now wielding the baton themselves, then, whomsoever were the owners of *Foundation-X* in 1946, and in 1917, are still its owners today.

### **Casa de Rothschild!**

Let me know if this sufficiently constitutes Jeff Blankfort's requirement for evidence: "***if you***

that had seen tens of millions of Christians dead, so suddenly vanish in the mere 60 years since?

Did the earth swallow it, did the sky absorb it, or was there an earthquake which sunk it?

What happened to it?

In my experiments in confusion, I valiantly searched for such a catastrophic event which could have silently vanquished that *Foundation-X* which had existed only 60 years earlier.

I am sorry to report here that there is no known documentation existing on planet earth in the annals of public archives which records any such cataclysmic event where that elusive power could have disappeared. If one exists in secret classified archives, like aliens abducting them off the face of the planet, I do not possess such powers to access those

***have any direct evidence with unimpeachable sources that the Rothschilds are running everything”***

Now let me briefly examine the legal requirement for evidence in the United States. The following definition is excerpted from my Editorial: [Some Dare Call it Conspiracy! Are you among them?](#) April 19, 2009:

**Conspiracy:** “in law, agreement of two or more persons to commit a criminal or otherwise unlawful act. At common law, the crime of conspiracy was committed with the making of the agreement, but present-day statutes require an overt step by a conspirator to further the conspiracy. Other controversial aspects of conspiracy laws include the modification of the rules of evidence and the potential for a dragnet. A statement of a conspirator in furtherance of the conspiracy is admissible against all conspirators, even if the statement includes damaging references to another conspirator, and often even if it violates the rules against hearsay evidence. The conspiracy can be proved by circumstantial evidence. Any conspirator is guilty of any substantive crime committed by any other conspirator in furtherance of the enterprise. It is a federal crime to conspire to commit any activity prohibited by federal statute, whether or not Congress imposed criminal sanctions on the activity itself.” -- Columbia Encyclopedia

Permit me to highlight the core legal standard in that passage with emphasis:

- 1) The conspiracy can be proved by circumstantial evidence.**
- 2) Any conspirator is guilty of any substantive crime committed by any other conspirator in furtherance of the enterprise.**
- 3) A statement of a conspirator in furtherance of the conspiracy is admissible against all conspirators, even if the statement includes damaging references to another conspirator, and often even if it violates the rules against hearsay evidence.**

My goodness! The entire gang of banksters despite their web of control can be roped in even if one conspirator can be indicted. I have just demonstrated the corrupting power of the banker fraternity, and shown that the Casa de Rothschild exists today because it existed in 1917 and 1946 by the evidence of Balfour Declaration and Nuremberg Military Tribunals, respectively. This fraternity has such immense powers that it can legally enact Federal Statutes, like the Federal Reserve System of the United States, by having the

American Congress enact their preferences into law. When such an extortion happens, the above artfully defined definitions of conspiracy become irrelevant. The law of the sovereign becomes the ultimate arbiter of what is crime and what is virtue, as aptly demonstrated by Saint Augustine of Hippo in the 4th century:

**“When the King asked him what he meant by infesting the sea, the pirate defiantly replied: *‘the same as you do when you infest the whole world; but because I do it with a little ship I am called a robber, and because you do it with a great fleet, you are an emperor.’*”** (*The City of God against the Pagans*, Page 148).

This modus operandi, of theft of public's wealth by legalism enactment by the sovereign, also appears to be right out of the *Protocols*. Witness Protocol 1, items 3 through 5 which lend an empirical definition to the term “legal” when applied to control the masses:

3. It must be noted that men with bad instincts are more in number than the good, and therefore the best results in governing them are attained by violence and terrorisation, and not by academic discussions. Every man aims at power, everyone would like to become a dictator if only he could, and rare indeed are the men who would not be willing to sacrifice the welfare of all for the sake of securing their own welfare.

4. What has restrained the beasts of prey who are called men? What has served for their guidance hitherto?

5. In the beginnings of the structure of society, they were subjected to brutal and blind force; after words – to Law, which is the same force, only disguised. I draw the conclusion that by the law of nature right lies in force.

Based on insights gleaned from these contortions, especially item 5), if you can enact Federal Statutes and laws to protect your graft by wielding the hidden might of your indomitable force, then, there is no “conspiracy” in the legal terms because you did not violate any Federal Statutes!

Isn't that just marvellous?

So, the House of Rothschilds, using their hired front men and political errand boys, backed by their interlocking interests in all the world's central banks, have protected themselves from that definition of Conspiracy by shrewdly employing the uber-Machiavellian Protocols!

But have they protected themselves from RICO?

See my [editorial](#) which contains an extended excerpt of laws from the late Eustace Mullins' 1985 book *World Order*, which could have potentially been used in earlier times.

I now believe that the accelerated pace towards world government today, under the complete co-option of all organs of state worldwide, makes the bankster fraternity almost immune by way of any legal recourse in the entire Western Hemisphere. They might occasionally sacrifice a red herring errand boy here and there at the altar of reform to keep the plebeians happy, if it ever came to that! These are the ultimate UNTOUCHABLES! No one can even see them.

I hope that between [Part-2](#) and [Part-3](#) of this series of my goyish attempts at independent thinking, there is sufficient grounds for courageous moral Jews like Mr. Jeffrey Blankfort to finally perceive their own brethren – the King of the Jews – who have bestowed upon Zionistan its creation. Its ethos. Its “iron wall” that none can breach. Their full spectrum interlocking control of the world's private central banks continually enables them to implement their own two centuries old familial boast ***“give me control of a nation's money supply and I care not who makes its laws”*** with such brazen impunity that it is almost always accompanied by the thunderous applause of European and American goy statesmen and law makers. The King of the Jews have inflicted upon the entire Jewish peoples a calumny that the Jews shall not be able to outlive even if they exist for another 3000 years! See: [From Genesis to Genocide in Palestine : The Golem Is Not Jewish!](#). The following sentiment barely captures it:

'If fair punishments are ever to be awarded for their crimes against humanity for just the past 100 years in any Just court of law, Adolph Eichmann would have to be retroactively let go by resurrecting his soul from his grave with high honors and awarded multiple peace prizes plus compensation, in order to administer hanging and extraction of restitution as the graduated scale of ultimate punishment for the ultimate prime-movers of all wars and pestilence before which their errand boys' and patsies' crimes against humanity pale in comparison.'

---

<http://print-humanbeingsfirst.blogspot.com/2009/11/rescuing-thestruggle-for-palestine.html>

All persons of any faith (or no faith) not entirely consumed by depravity, apathy, Faustian pacts, and if I might be so bold as to emphatically add, pious hypocrisy, should have no qualms calling a spade a spade. What prevents one from doing so, is suggested in my

pamphlet: [How To Return to Palestine This Day Forward](#).

What can one do about it today? Practicably nothing, as suggested in: "[Of Ostriches and Rebels on The Hard Road to World Order](#)".

But I pray that I am mistaken, that Machiavellian political science and infinitely deep pockets of the oligarchy exuded through their tax exempt foundations, private central banks, income tax levied upon masses, and national debt levied upon nations – an inflexion of power which can bring combined superpowers to their knees – can straightforwardly be trumped by copious narratives of dissent chiefs and plebeians' abundant prayers!

Thank you, ladies and gentlemen of the jury.

**Short URL:** <http://tinyurl.com/Omnipotent-Rothschilds>

**Source URL:** <http://print-humanbeingsfirst.blogspot.com/2011/01/omnipotent-rothschilds-where-is-proof.html>

First Published December 31, 2010

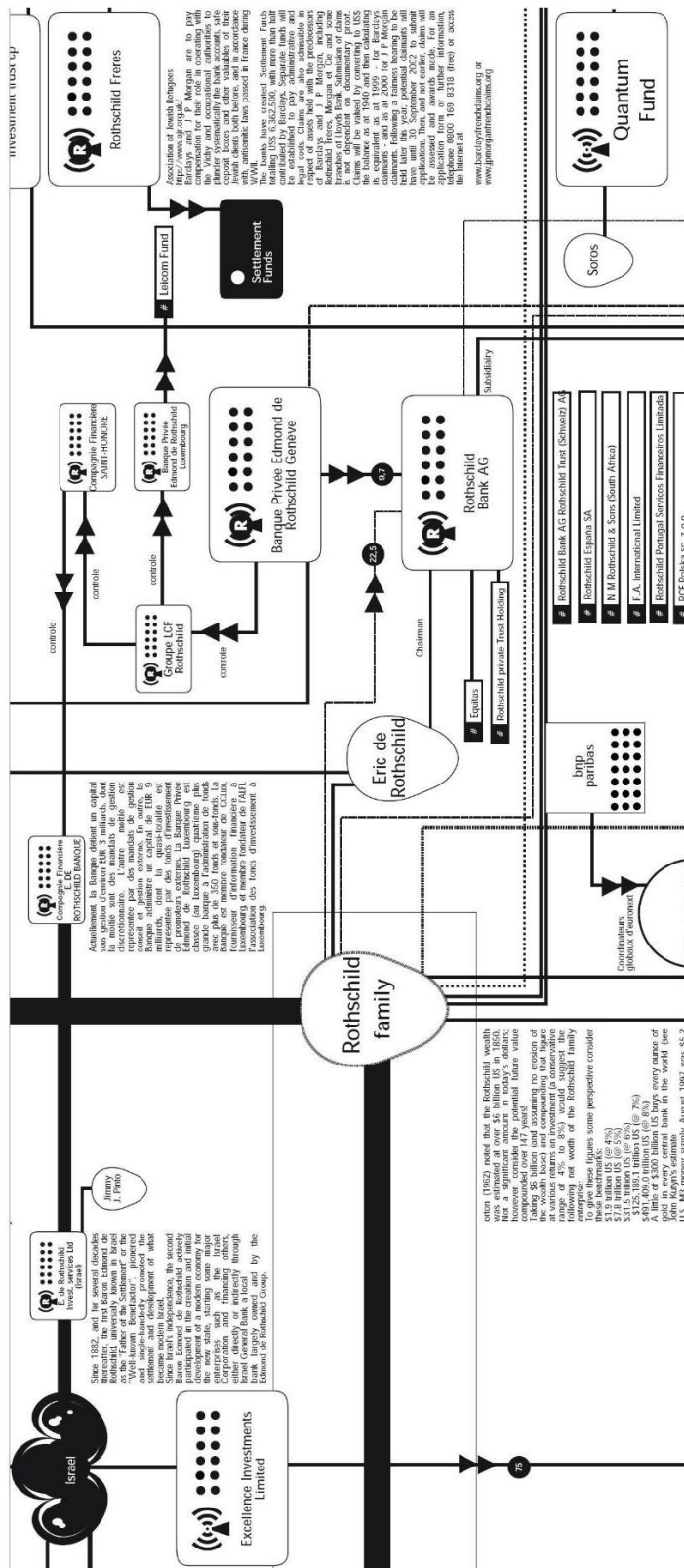



## Chapter 16 Redemption

### America's War Veterans: PTSD and its Cure – Letter to Editor



The two American websites, Veterans Today and Salem News, run by two former US Military veterans, contain some of the most outstanding RealitySpeak writings by both civilians and America's war veterans, presumably, all mostly being eagerly ingested by other American war veterans. In full disclosure, these websites also reprint my two cents every now and then. The Editors in chief of both websites whom I have never met but communicate with occasionally, very generously invited me to become Staff Writer on their respective panels, and I politely declined in each case. I prefer my lonely voice to stay independent – for it allows me to explore my own confusions as no one else can.

So, exercising that independence of thought, if I may be permitted to ask the next logical question to great penmanship and reportage by recovering war veterans, does such RealitySpeak affect a change in status quo?

Does all this verbiage ameliorate the suffering of the bemedaled American war hero who brought my fellow Muslim men, women, and children of Afghanistan, Iraq, Pakistan, perhaps Iran next, the 'liberation' depicted in the images?

Do the oft maligned liberators of truth from the sharp jaws of deceit, ever impact the inflexion of hegemonic power with mere moral words and intellectual theses which unravel the never ending lies of the hectoring hegemons du jour?

For, if words alone could make appreciable difference to the calculus of hegemony, then, the Ten Commandments would have surely eased mankind's journey over the past hundred years of successive world wars and vile deprecation of humanity. As the noted essayist and novelist Aldous Huxley had once observed when responding to the question "What does one do?":

'Well this is the real problem. Nothing is easier than to formulate high ideals, but few things are more difficult than to discover the means for by those ideals might be implemented, and the categorical imperatives which spring from them can be a pain. This is the real problem. I mean one has to dream, but one has to dream in a pragmatic way to consider how... Merely preaching to people doesn't have much effect, people have been preaching for an awfully long time and we are still pretty much where we were.'  
(Herman Harvey: Sum and Substance with Aldous Huxley, co-produced with University of S. California, KNXT Public Affairs.  
<http://www.huxley.net/ah/huxley-interview.html> )

The undeniable practical fact of the matter remains, that unless moral prescriptions and copious intelligent analyses appearing on these websites get translated into direct activism, into building organizations, into building movements, and into creating a powerful national chorus collectively saying NO to the murdersome hectoring hegemony now bringing vile indignities to the American people right here at home, elegant moral words on paper, wonderful prose bringing exposes to the intelligent, is only self-entertaining the armchair internet warriors.

In all honesty, haven't we, the narrators du jour, merely substituted the mind numbing television, America's favorite sedative, with a new type of cognitive programming for a minuscule sub-minority who indulges in study, but which remains as impotent in mobilizing the conscience to act in order to affect change, as the former medium was effective in amusing us to death? The "*history's actors*" in fact even brazenly noted that this is all we shall be able to do. The New York Times quoted a senior White House Advisor during the Bush Administration while explaining how fait accompli enacted by "*history's actors*" actually worked for "*imperial mobilization*":

'We're an empire now, and when we act, we create our own reality. And while you're studying that reality — judiciously, as you will — we'll act again, creating other new realities, which you can study too, and that's how things will sort out. We're history's actors . . . and you, all of you, will be left to just study what we do.' — Senior Bush Advisor, The New York Times, October

17, 2004 (see [Convince People of Absurdities and get them Acquiescing to Atrocities: The Enduring Power of Machiavellian Political Science](#) )

I say, bullshit! Let's grasp the bull by the horns and turn the tables on its head for the criminals who, with cold chutzpah and flushed with hubris, openly proclaim themselves '[Hectoring Hegemons](#)' working on ending national-sovereignty through successive [hegelian mind-fcks!](#)



But in order to do so, one must first have the courage to spell bullshit as B.U.L.L.S.H.I.T, without dropping any letters to pass our delicate sensibilities which can shatter the tabula rasa of civilian populations 20,000 miles from home, but can't handle seeing RealitySpeak in print. This, in case it isn't already obvious, is merely a metaphor for first being able to face reality without syntactic sugaring. What follows is plain RealitySpeak – no bullshit. While you don't have to agree with anything here, there is no Newspeak in it. For, only in straight plain talk without bowing to political correctness, is there a way out of being mere narrators of the murderous shit continually being left behind by 'history's actors'.

I believe that the brave veterans of America's wars upon the 'untermensch' 20,000 miles away, the principal audience of both these websites I imagine, can actually play a leading role in helping to change that dismal state of affairs.

HOW?

By rising to protect their own nation's peoples for a change, where, while they were busy bringing 'democracy' and 'liberation' to my 'barbarian' peoples in exotic faraway lands, their own land of the free was being turned into a police-state.

Instead of the increasing number of war veterans being perpetually trapped in PTSD and seeking palliatives to assuage their guilty conscience, '[VA says PTSD claims up 125%](#)'

Veterans Today, December 18, 2010, undertaking principled moral acts with discipline to safeguard the decent peoples in their own nation, may prove to be far more therapeutic than the Marijuana being pitched by experts like Dr. Phil Leveque, as in 'You Can't Go Back and You Can't Come Back', Salem News, December 13, 2010.

The 1978 Hollywood movie, *The Deer Hunter*, graphically brought home to civilians a vicarious touch of what soldiers of patriotism, fortune, and economic conscription, can experience in horrendous modern wars that are principally illegitimate, whose principal victims are civilians, cultures, and civilizations. Those creating the victims often end up with the guilt complex which modern soulless medicine, unable to comprehend the delicate connection between mind-body-spirit and the damage which wars cause to man's essence, calls its symptomatic display PTSD. The psycho-babble of the learned, Post Traumatic Stress Disorder, in the case of wars, is primarily symptomatic of the injury to the conscience, to the soul, which perpetually remains un-amenable to brain surgery, to palliatives, to sedatives, to psycho-therapy, and to modern medicine. *The Deer Hunter's* main focus, if the reader will recall, was primarily to demonstrate the consequences of the horrendous dysfunctionality of modern warfare causing maladjustment back into normalcy for both victims and victimizers, the latter becoming war's second victims. Therefore, for them to not astutely comprehend that modern warfare by superpowers moving pawns around on *the Grand Chessboard* is itself a monumental crime, a racket, and those participating in it as soldiers and technicians under waving flags and blaring trumpets, themselves commit crimes against humanity, is to miss the point of it all.

Call the suffering of the conscience from that backlash *PTSD* if you will, but being able to separate cause from effect, symptoms from disease, doesn't seem to be a forte of Veterans Hospitals. And while that symptom is captured most precisely, most elegantly, almost poetically, in the aforementioned article title by Phil Leveque, "*You Can't Go Back and You Can't Come Back*", it does nothing to focus attention on the primary cause of it: the injury to the 'self', the essence of man, what, for the lack of a better terminology, we variously refer to as conscience, soul, superego, all elements which remain elusive to modern medicine. Ask any AMA approved medical doctor for any alternative to big-Pharma led prescriptions, and they will only give you the same standard response they have actually been taught to give in medical school in order to pass their AMA certification – *I don't know anything about alternatives not recommended by the FDA.*

But just as the Hollywood movie had left its audience hanging, had offered no real solutions for the returning veterans, nor for preventing the creation of future maladjusted veterans, neither does Phil Leveque with his prescriptive conclusion in bold: "**WHY CAN'T THE VA USE THE BEST DRUG – MARIJUANA?**" When the illness is misdiagnosed, the cure can

at best only be a placebo.

Please permit me to lend some Eastern Zen here – for, Western experts have sufficiently ruined this nation, and the world, to warrant any faith in their diagnosis and their prescriptions.

First, let's try to understand how the war veteran got to the stage of PTSD in the first place.



For the reader's orientation, please permit me to coldly state that I am that 'untermensch' upon whose civilizations the proud, the brave, the bold veterans of America and its Allies waged their boundless courage 20,000 miles away from their own home, in whose homes they slaughtered our children calling it *collateral damage* just as the CIA's hit team started

arriving in Afghanistan courageously proclaiming: ***“We will export death and violence to the four corners of the earth in defense of our great nation.”*** (Bob Woodward in *Bush at War*).

You, dear veteran, could have shown a different kind of courage too at that time and avoided the injury to your soul altogether. Instead of signing up to bravely rain Daisy Cutters and cruise missiles upon barefooted children, upon cities, upon civilian infrastructures, upon wedding parties, upon defenseless men, women, and children, and continually be fearing that hypothetical day when a future Nuremberg might administer you the same victor's justice as your nation routinely administers to the vanquished, you could have signed up to say NO to immoral conquests of your ruling elite. You could have signed up to say NO to economic conscription and found other ways to fund your college education, other ways to earn your livelihood. And you could have used the tiny gray matter to see through the facade of false patriotism, of inculcated false beliefs, of false flag operations, of false enemies, of falsely identified culprits, of *“imperial mobilization”* disguised as “war on terror”.

Just like one among you had done, not too long ago, sparing himself the moral scar tissue you find yourselves saddled with today as its new victims. This is what this courageous fellow had found the nerve to state then:

'Why should they ask me to put on a uniform and go 10,000 miles from



home and drop bombs and bullets on Brown people in Vietnam while so-called Negro people in Louisville are treated like dogs and denied simple human rights? No I'm not going 10,000 miles from home to help murder and burn another poor nation simply to continue the domination of white slave masters of the darker people the world over. This is the day when such evils must come to an end. I have been warned that to take such a stand would cost me millions of dollars. But I have said it once and I will say it again. The real enemy of my people is here. I will not disgrace my religion, my people or myself by becoming a tool to enslave those who are fighting for their own justice, freedom and equality. If I thought the war was going to bring freedom and equality to 22 million of my people they wouldn't have to draft me, I'd join tomorrow. I have nothing to lose by standing up for my beliefs. So I'll go to jail, so what? We've been in jail for 400 years.' (Redemption Song: Muhammad Ali and the Spirit of the Sixties (1999) by Mike Marqusee, quoted from Wikipedia page on Muhammad Ali)

You could have done the same thing, no?

Yet, you didn't.



You took that uncourageous path of accepting to shoot at my 'untermensch' peoples because your leaders ordered you to do so. Your blind deeds borne of "***I was just following orders***" have made you your own victims. Don't think that only you know in the privacy of your anguish how horrendous some of these crimes were. The victims know too, both the dead ones for whom the war and misery has ended,

and the living for whom it is never ending. You think your suffering from PTSD is painful? Ask those whose tabula rasa you have shattered while "*following orders*". And though silently and apathetically spectating, the world spectators aren't blind either. The veterans suffers only in a glass cage that appears opaque to them in the hell of their private shame. But it is only a one-way mirror, entirely transparent from the other side.

Unless you can squarely face up to that grotesque fact without self-delusions and false justifications, that you have monumentally wronged the 'lesser peoples' while slumbering under your patriotic zeal and implanted false beliefs, the redemption will remain illusive.

Just like this Winter Soldier squarely faced up to his crimes against humanity without making excuses:

'And I tried hard to be proud of my service but all I could feel was shame. These were peoples, these were human beings. I have since been plagued by guilt. I feel guilt anytime I see a mother with her children. I feel guilt anytime I see a young girl. We are told we are fighting terrorists; the real terrorist was me and the real terrorism is this occupation. Those who send us to war do not have to pull a trigger or land a mortar round. They don't have to fight the war, they merely have to sell the war. They need a public who is willing to send their soldiers in a harms way. They need soldiers who are willing to kill and be killed without question. They can spend millions on a single bomb, but that bomb only becomes a weapon when the ranks of the military are willing to follow orders to use it. Our enemy is not 5000 miles away, they are right here at home. If we organize and fight with our sisters and brothers, we can stop this war, we can stop this government, and we can create a better world.' (Iraq war veteran Mike Prysner admits his shame and guilt after the fact, and suggests the only remedy possible for preventing future shame – had he only paid attention to what Muhammad Ali had done before the fact, March 15, 2008, <http://www.youtube.com/watch?v=5jGmMbQPJTU> )

But that private suffering, I believe, is also a mercy upon man – for within it also lies the only seed of positive redemption. This aspect is very important to comprehend fully. It is not theological gibberish of religious salvation which I expound here (I leave that to the priests), but empirical psych-physiology of what makes us a human being. In its clarity, lies the practicable solution-space. Both for suffering veterans of today, and for preventing future suffering veterans of tomorrow.

So please permit me to explain at length, for indeed, no leader glibly sending America's kids off to perpetual wars, no MD serving in empire's own imperial institutions under AMA and FDA guidelines to stick to their officially mandated medical protocols or lose the license to practice medicine, and no priest carrying empire's renewed white man's burden to bring us 'untermenschen' their 'Jesus' (watch video <http://youtube.com/watch?v=hVGmbzDLq5c> ) will explain the following commonsense.

Only if man has a conscience, a soul, that he naturally suffers when he indulges in horrendous crimes, what modern soulless medicine calls PTSD. Just think, if we had no conscience, there would be no mental anguish, and thus no psychological traumas!

The proof of this straightforward observation is to simply ask the empirical question: do we ever observe the mighty generals and noble presidents, who, under orders from their own task-masters, destroy entire nations and civilizations before being awarded Nobel Peace Prizes for their peace-making, suffering from PTSD? No. They are never known to walk the night lamenting: “*All the perfumes of Arabia will not sweeten this little hand*”, and die rather “*holily in their beds.*” (MacBeth). That is because they have no conscience, they have no 'soul'. This pathology, more aptly termed pathocracy, is not just Zen-babble or Shakespearean theater. It is now even clinically coming to the surface. See the book *Political Ponerology: A Science on The Nature of Evil adjusted for Political Purposes* by Andrew M. Lobaczewski ( <http://ponerology.com> ).

While the rest of us may suffer from the “banality of evil” whose only known cure is moral courage and moral redemption, the psychopath is observed to be suffering from some yet to be precisely identified structural abnormality which makes him and her completely impervious to feeling empathy. He and she is evidently either born without a conscience (or, some how had it killed off in unrecoverable ways in rituals and rites peculiar to the elite who send ordinary men and women to the slaughter without batting an eye). This creature appears as normal person to us, lives and moves among us as a normal person, but inevitably always seems to rather uncannily end up in ranking leadership positions where it easily makes immoral decisions for narrow interests without compunction and remorse. He and she experiences no more cognitive dissonance ordering an atomic bomb dropped, than ordering a rendition flight, or sentencing a frail Aafia Siddiqui to 86 years in jail. Whereas, the evil normal people face, both you and I, was aptly captured by Hannah Arendt by that term “Banality of Evil” when trying to comprehend how the *Good German* was created in Nazi Germany.

Hannah Arendt arrived at the conclusion that it was a combination of lack of moral courage, easily succumbing to authority figures by one's nature, through sustained indoctrinations to obey authority, and due to the blind allegiance to discharging one's duties without reflecting upon the consequences of those duties. The 'banality', ordinariness of individual evils, added up suddenly becomes extraordinary in its proportion and consequences. This is the exact same description of how the *Good American* has been created today for which, you are now paying the price of PTSD due to all that red blood of my peoples upon your hands.

No? Yes! Read it [here](#) to see it from the eyes of one upon whose Muslim civilizations, your patriotic munificence was so courageously unleashed by the cumulative “banality of evil”.

We, the ordinary peoples, who often become canon fodder for pathocrats, have a conscience, we are not psychopaths. We may however become so if we continue to suffer



and continue to inflict suffering upon others to the point that physiological changes in our bodies irreversibly kill off those brain structures where empathy springs from, where conscience resides, where, in Freudian terms, the superego keeps our id and ego in check. But short of becoming a psychopath, there is a moral path of redemption available to all of us which isn't available to the pathocrats who send us to our death smiling. Who never suffer from PTSD.

So, what is the cure for this tortuous scarring of the moral psyche of normal persons which modern medicine calls PTSD? What is the path of redemption? Permit me to share our Eastern wisdom, our ancient medicine, our redemptive therapy, something that adventurers coming to bomb and rob us somehow conveniently fail to carry back with them to their own civilization along with their plunder and their mental scars. The cure is not in physical therapy, it is not in confessionals in priest boxes, and it is not on a psychiatrist's couch, nor in going back into childhood to find and kill-off old demons, real and imagined. The damage caused to the spiritual essence of man for enduring horrendous moral crimes, only the spiritual resurgence can cure. That is what modern medicine cannot give you because there is no profit in it for big-Pharma. Nor is it in the interest of the war-mongers to have their VA hospitals advocate spiritual resurgence – the kind I describe below – for they must have a continuous supply of new recruits of patriotic and economic conscriptions as canon fodder to fight their perpetual wars.

Moral or spiritual redemption is only possible in undertaking moral acts, not in mere words, but in courageous endeavors which go beyond the normal existence, just as the cataclysms which created PTSD went beyond the normal existence. Acts which border on heroism, and which permit us to rise to our better-selves primarily in the service of those whom we have injured by both commissions, and omissions. Only such redemptive acts can assuage our guilt sufficiently to enable atoning for our earlier moral lapses. In certain societies, perhaps still today, judges would sometimes award the guilty a punishment of such a type, to go humbly serve the family of those whom they have injured, whose bread-winners they killed. When implemented properly, it helped heal both the victim, and most interestingly, also the victimizer. Not too profound when one thinks about it, is it? Even Hollywood learns – as they evidently did in what may have been the topical sequel to *the Deer Hunter*, Tom Cruise's 2003 movie, *The Last Samurai!* The *Metanoia* experienced by the American soldier *Nathan Algren*, beckons today's PTSD villains. The Greek term for 'afterthought repentance', *metanoia*, denotes a change of mind, a reorientation, an awakening, a fundamental transformation of outlook, a spiritual conversion, walking the path of moral redemption and penitence in consequence.

Those who have undertaken such strivings, ask them their experiences. I imagine that

asking Ken O'Keefe for instance, the man who is off in Gaza braving bullets whizzing by his head, bullets which he once himself inflicted upon the 'untermensch' in whose defense he now braves it with empty hands, might be an interesting exercise for America's veterans.

Not only can the veterans help heal themselves with such courageous efforts undertaken with direct moral acts in their own nation, but they can even help prevent future veterans from coming into existence by leading conscientious objector movements across their nation, teaching and warning the youngsters often enlisting as victims of economic conscription and state propaganda, the very words and analyses available on these stellar websites.

If each suffering veteran of America can prevent just one new future suffering veteran from being created, the healing efficacy of their moral strivings will be nothing short of miraculous! Just imagine when they can prevent ten?

If the suffering veterans of America can forge a movement to loudly say NO to the vile indignities being heaped upon us right here at home in the land of the free, they can make a difference to their own healing.



Here is the most recent grotesque example of what we all face: [Boy Asks TSA 'Why Pat Down Mom And Not Me?'](#), [TSA Replies "You Don't Have Boobs"](#).

Saying NO to invasive body scans at airports, and saying NO to humiliating patdowns as well, and drawing media and public attention to those bold NOs can even galvanize the public to do the same, and to join forces with you to reclaim your nation

from the rapidly closing jaws of a police-state. If servicemen remain unaware of the real agenda behind these vile physical gropings of America's men, women, and children, as is amply evidenced by the blind compliance of the active duty American soldier going through an American airport in uniform carrying an automatic weapon – a narrative which appeared in Veterans Today and which drove me up the wall that someone can so courageously shoot at barefooted people in Afghanistan, Iraq, Pakistan, but can't say NO to absurdities in his own country – see my article '[Body-scan Alert - Not Suffering Indignities at Airports](#)'. Will that soldier also only acquire his moralsense under PTSD once he is a veteran? Isn't there something grotesquely wrong with that picture?

A single dose of resonating moral NOs across the land of the free will prove to be far more therapeutic to the veterans of America than a 1000 psychedelic joints of Dr. Phil Leveque's prescription which he simultaneously avers: *"My subject matter is that whatever the degree of PTSD/TBI the condition is almost permanent."* And thus, by his own admission, asserts all ingestive medicines being ineffective.

Can you, the veterans of America who have finally woken up, kindly give an active think to this prescription? As Ray McGovern lamented in Washington DC at a war veterans' march upon the White House, December 16, 2010, which was only a hundred veteran strong instead of one to two million:

'[quoting Daniel Berrigan] *Those who say **let us have peace**, often tack on: **but let us risk nothing, let our lives stand intact, let us know neither prison, not ill repute, nor ridicule from friends, nor disruption of ties.** There is no peace, says Berrigan, because the making of peace is just as costly as the making of war. At least as liable to bring disgrace and prison.* So, we accept our responsibility here. We are going to do all we can to stop the violence being perpetrated in our name. And so, if the making of peace means prison, that's where you are gonna find us!' (watch <http://www.youtube.com/watch?v=1WK5--Us7v0> )

And where were all the tens of thousands of war veterans suffering from guilty consciences?

They were, and still are too busy reading websites like this one to bother striving for real redemption – they'd rather just talk about it while collecting their minuscule pecuniary compensation from the Veterans Administration!

You don't need any more knowledge my friends. You don't need any more study. You don't need to read any more websites to learn what has happened to you. All that these words do for you is to turn you into even more armchair wallowers caught between diligent study and PTSD. But no redemption. Knowledge does not lead to acts of redemption. Only *metanoia* does! And that comes from within – not by reading more websites!

How can you, the equally discarded victims of America's wars of hegemony, elevate your *metanoia*, your new found awareness of how you were sent off to fight for the narrow interests of an elite hell-bent on destroying your own nation – all amply demonstrated by the stellar writings and beautiful words appearing on Veterans Today and Salem News for those who really don't already know – into principled coordinated moral acts which can

reverse the grotesque police-state transpiring in your own nation right now? And by so doing, help avert a global catastrophe, a planned Armageddon upon the remaining 'untermenschen'! That is an unparalleled self-healing path, unmatched by modern medicine as well as natural sedatives.

If I, a mere civilian mouse, a foreigner in the United States pursuing his 'American Dream' like everyone else, can say NO to state tyranny – read it [here](#) – and I scare just as easily as any other mouse, have a family, have aspirations, have passions, have no history of maladjustment except by choice since 911 when I consciously chose to become a *malcontent* (in [H. G. Wells' words](#)) and *maladjusted* (in [Martin Luther King Jr.'s words](#)) because there was simply no other choice (read it [here](#) and [here](#)); if this disabled wheelchair bound young man protesting state tyranny in the streets of London can say NO – watch it at <http://youtube.com/watch?v=ZL4eL0sLzKU> – and he is suffering from cerebral palsy; is there some very good reason why the hurly-burly American veterans of wars' brutalities should continue to comply with tyrannical absurdities which are destroying their own nation-state? I believe this is where the certificate of everlasting virtue from the Veterans Administration comes in handy.

But, if the war veteran, you, boldly rise beyond such certificates, if you rise beyond the mere psychedelic words you read on paper which always look good in print and in speeches, if you instead stand alongside the very 'untermensch' whom you once oppressed, serve the victim families from Afghanistan to Iraq whose bread-winners you once destroyed with a humility you were never acquainted with as a US marine, stand-up for your own nation's peoples suffering under the jackboots of the same tyrants who caused you to suffer PTSD in immoral *imperial mobilizations* deceptively sold to you as *preemptive war on terror in defense of your nation*, **your yesterday becomes a mere prologue, the rest of your life, finally your own.**

Thank you.

Sincerely,

Zahir Ebrahim | [Project Humanbeingsfirst.org](http://ProjectHumanbeingsfirst.org)

California, United States

**Short URL:** <http://tinyurl.com/PTSD-Cure>

**Source URL:** <http://print-humanbeingsfirst.blogspot.com/2010/12/letter-american-war-veteran-ptsd-cure.html>

First Published December 18, 2010

# Chapter 17 The Noble Path: Denying to Caesar what is not Caesar's

## Islam: Surah Al-Asr of the Holy Qur'an

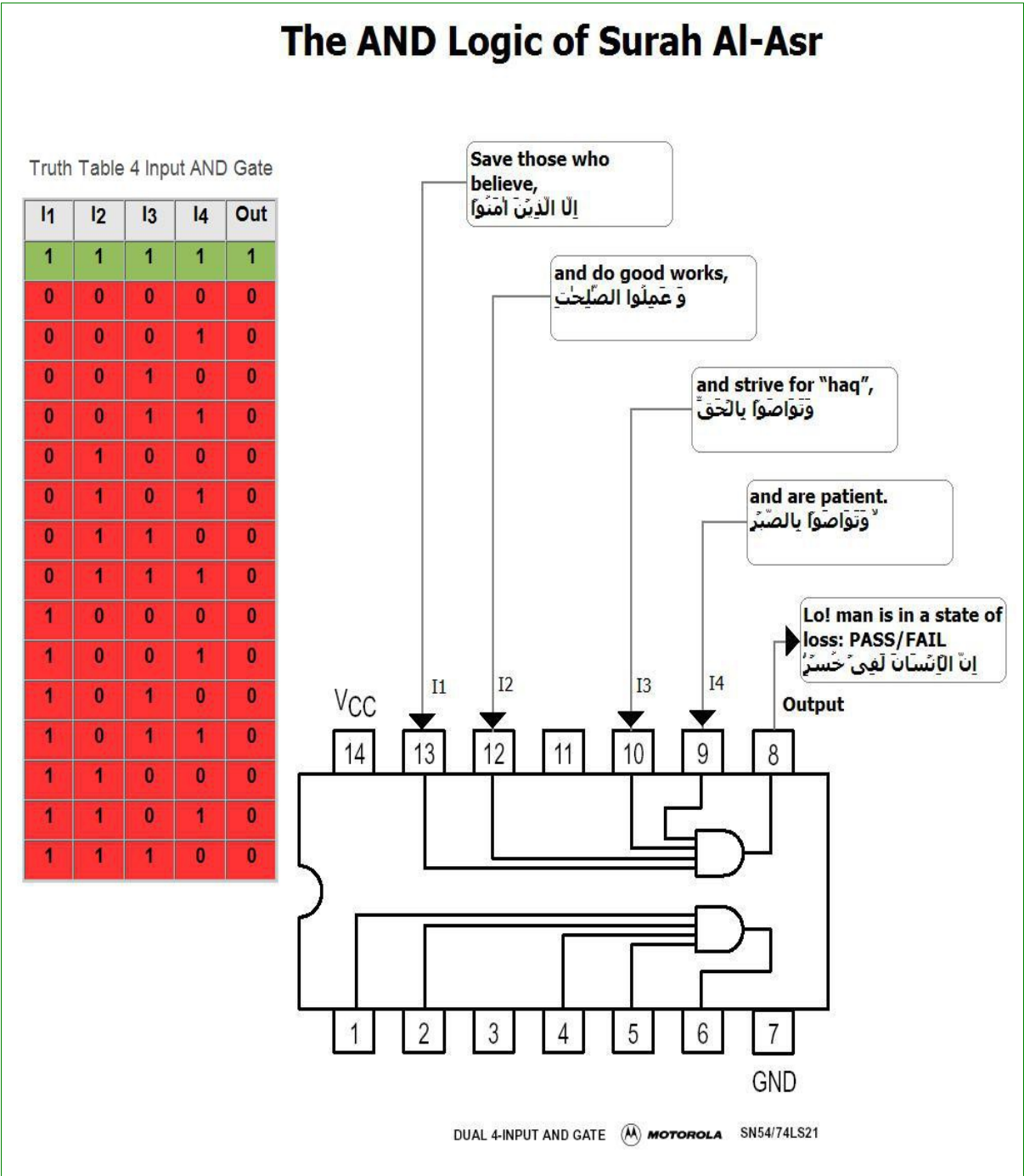

Caption Islam: The AND Logic of Surah Al-Asr of the Holy Qur'an, Chapter 103

By the declining day, (1)	وَالْعَصْرِ
Lo! man is in a state of loss (2)	إِنَّ الْإِنْسَانَ لِفِي خُسْرٍ
Save those who believe, and do good works, and strive for “haq”, and are patient (3)	إِلَّا الَّذِينَ آمَنُوا وَعَمِلُوا الصَّالِحَاتِ وَتَوَاصَوْا بِالْحَقِّ وَتَوَاصَوْا بِالصَّبْرِ

Caption Full text of Surah Al-Asr, Chapter 103 of the Holy Qur'an

Reproduced above is the full recipe of the pithy Surah Al-Asr of the Holy Qur'an for a noble life which is “*not in a state of loss*”.

Notice what's stated and what's omitted in this self-sufficient tiny Surah which evidently requires reflection in inverse proportion to its length.

There is no reference to Muslims, or to Islam, or to any particular people or religion.

The Surah is directly addressed to man, “*insaan*” ( الْإِنْسَانَ ), to every people of all religions, and to people of no religion (the overarching pluralistic context for peoples of different faiths has previously been established in the article: [Islam and Knowledge vs. Socialization](#)).

The logic of the verses 2-3 is the **AND** conjunctive clause. Meaning, a concatenation of conditions joined by the AND clause (Arabic وَ). Every one of the listed conditions in such a statement has to be individually true in order for the overall statement to be true. Otherwise the statement is false.

Being a techie engineer, I have depicted this AND conjunction in electrical engineering parlance in the top figure using a simple electronic device called the AND Gate. One can purchase it for a few cents at Radio Shack. The logic device is made out of a few transistors and implements this AND conjunctive clause function.

The 4-input AND Gate in the diagram captures the logic of Surah Al-Asr verses 2:3 with exact precision. Those more inclined to be “Left-brained” (logic, math, and problem-solving dominated) than “Right-brained” (art, creativity, and language dominated) can perhaps appreciate the import of Surah Al-Asr better in this representation.

Imagine that an LED is attached to the pin labeled **Output** (metaphor for a man's life).

- It glows green (to indicate a life which is not at a loss) only if all four inputs of the AND Gate labeled I1, I2, I3, and I4 are TRUE (represented by a “one” in the truth table). Observe that there is only a single statement in the truth table when the LED is ever green.
- It glows red (to indicate a life which is at a loss) if one or more input is FALSE (represented by the corresponding “zero” in the truth table). Observe that there are fifteen statements in the truth table representing all the remaining permutations for which the LED is red!! The obvious first statement of all zero inputs clearly captures the vile hectoring hegemony of the planet and is of no surprise to anyone. But the remaining fourteen can indeed be very surprising.

Meaning:

- it doesn't matter how many prayers one offered and how many *Hajj* one performed to “believe” ( **أَمَّنُوا** );
- or how many hungry mouths one fed, how many hospitals and schools one built, and how honestly one earned one's income and paid one's *zakat* to do “good works” ( **عَمِلُوا الصَّالِحَاتِ** );
- if one didn't strive to oppose falsehoods and uphold “haq” ( **حَقًّا** ), the life, even if otherwise piously and well-lived, is still one of “loss” ( **خُسْرًا** ).

I am not making this up. That's what the Holy Qur'an itself states, unequivocally – reflect on it yourself while further recalling the admonishment of the Author of the Book of Reflection:

'That this is indeed a Qur'an Most Honourable, In a Book well-guarded,  
Which none shall touch but those who are clean: A Revelation from the  
Lord of the Worlds. **Is it such a Message that ye would hold in light  
esteem?'** Holy Qur'an, Surah Al-Waqia, 56:77-81

Witness that the hardest thing to do in modern life is to stand up to oppression and tyranny ( **وَتَوَّاصُوا بِالْحَقِّ** ). And also to be patient in adversity when one is experiencing the jackboots of the new Nazis upon one's neck ( **وَتَوَّاصُوا بِالصَّبْرِ** ).

Whereas the easiest thing to do is to sit in a mosque, and/or to feed the hungry in atonement of a guilty conscience.



We already see what the pious Muslims worldwide tend to excel in. We pay our *zakat*, *khums*, *fitra* (religiously mandated donations) on time, pray our *namaz* on time, and keep our *fasts* on time. Aspire to go for *Hajj* at least once, while the privileged take great pride in performing it repeatedly. Many among the oppressed are also incredibly patient in affliction. Indeed, we are so patient that we oft proclaim “*Allah chala raha hai*” (God is running the world), “*Allah malik hai*” (God is our provider), and often cry ourselves to sleep with utmost *sabr* (patience), repeating to ourselves with quivering lips and glistening eyes: “*hasbun allahu wa naimal wakeel*” (Allah is sufficient for us and most excellent is the Protector Arabic: حَسْبُنَا اللَّهُ وَنِعْمَ الْوَكِيلُ Holy Qur'an, Surah Al-e-Imran 3:173).

According to the testimony of Surah Al-Asr, take it any which you want, the fact remains that most of us are still in حُسْرٍ unless we stand up to oppression and unequivocally affirm حَقِّ to the best of our capacities. Silence and acquiescence to tyranny seems to be the antithesis to وَتَوَاصَوْا بِالْحَقِّ . That seems to be the *modus vivendi* of the majority of Muslims today.

The crafting of that antithesis evidently has also come about courtesy of the imperial scholars subverting the meaning of the religion of Islam in the service of tyrants and kings throughout the ages, modernity being no exception. Language being its first corrupter. Thus, وَتَوَاصَوْا بِالْحَقِّ has been reduced to some nonsensical gibberish by the pious turbaned man on the pulpit to mean: just talk about it with utmost earnestness while occupying oneself in the mosque and in عَمَلُوا الصَّالِحَاتِ . The *ullema* (plural for the Muslim man on the pulpit) today, as yesterday, selectively focus people's attention with verses from the Holy Qur'an that exhort people to *good works* and *belief* promising a pleasing *Hereafter* (e.g. Surah Al Baqara 2:25) to mask their crafty omissions in service of empire. Keeping the masses occupied in rituals and salvation, and “*rendering unto Caesar the things which are Caesar's,*” is not merely a Biblical saying (Matthew 22:21). That semantics has existed from time immemorial. Its biggest harbingers have always been the man on the pulpit.

Witness the 600-page one-sided Fatwa on Terrorism by the vaunted “scholar of Islam”, the posterboy of “moderate Islam” who issued a jurist's proclamation (*Fatwa*) against the terrorism of the pirates (see <http://tinyurl.com/Fabricating-Pirates> ) but not the emperor's. For services rendered to empire, the *house nigger* (see Faq: What is a house nigger) soon found a place-setting at the *massa's* table. As previously examined in Islam vs. Secular Humanism and World Government, the religion of Islam was hijacked from its very early days to service “empire” - Muslims' own. Nothing has principally changed today except for the color of the imperial flag.

Liberating the meaning of the religion of Islam, the *Deen-ul-Haq* (religion of حَقّ ) from the clutches of the so called scholars and jurists among Muslims is only as difficult as the uncongeniality of pondering the message of the Holy Qur'an directly, with one's own head and commonsense, rather than merely mouthing its melodic and soothing words which no doubt are magic to the soul.

To strive for "haq" ( وَتَوَاصَوْا بِالْحَقِّ ) requires no man's sanction – when Allah Itself has sanctioned it for every individual man and woman ( إِنْسَانَ ) in creation.

That is the momentous import of Surah Al-Asr – that tiniest Surah of the Holy Qur'an comprising a mere 27 words (as counted for the English translation used here). Its utility as a rallying call for denying to Caesar the things which are not Caesar's, for affirming to God what is God's, and to man what is man's, remains unsurpassed.

But at the end of the day, only Allah is also the final Judge of the extent to which we each did our own due diligence to Allah's Eloquence given our respective trials and tribulations, our bounties and blessings, **on all four criterion** for a life which only It shall Deem as *"not in a state of loss"*!

**Q.E.D.**

The holy month of Ramadan, a joyous month of fasting and reflection, commences tomorrow (or the day after) worldwide for 1.6 billion Muslims. Perhaps while rushing to "finish" the recitation of the Holy Qur'an in this month for nourishing the starved soul, the hunger in the stomach from not eating all day will be matched with a hunger in the intellect from not thinking at all.

**Ramadan Mubarik.**

Zahir Ebrahim

Project Humanbeingsfirst.org

Sunday, July 31, 2011

**Short URL:** <http://tinyurl.com/Surah-Asr-Tafsir>

**Source URL:** <http://faith-humanbeingsfirst.blogspot.com/2011/07/islam-surah-al-asr-of-holy-quran.html>

## Chapter 18 The Ignoble Path: Long Road To Secular Humanism

### Islam vs. Secular Humanism and World Government

**Zahir Ebrahim's Letter to Muslims: Is Islam really the Last Obstruction to World Government and Absolute Scientific Global Dictatorship?**

Please read the article "[Thought police muscle up in Britain](#)" by Hal G. P. Colebatch which appeared in *The Australian* on April 21, 2009, in conjunction with watching these revealing videos:

- Brian Gerrish's talk from the *2009 Lawful Rebellion Conference* and the *2009 Wakeup Call Conference* in the UK: <http://tpuc.org/node/564>,
- American documentary by William Lewis *One Nation Under Siege*: <http://undersiegemovie.com>.



[<http://www.bbc5.tv/eyeplayer/video/brian-gerrish-state-nation>]



[<http://www.bbc5.tv/eyeplayer/video/brian-gerrish-exposing-common-purpose>]

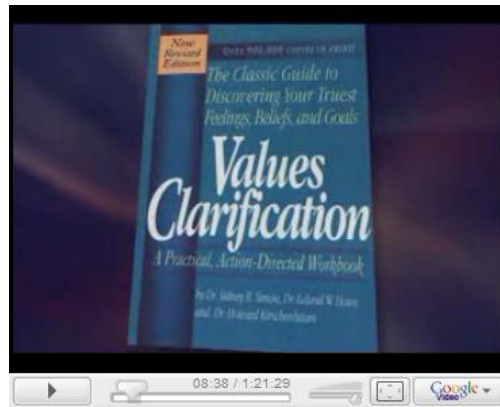

[[googlevideo=http://video.google.com/videoplay?docid=-7455325731648062338](http://video.google.com/videoplay?docid=-7455325731648062338)]

And connect with the impetus towards the introduction of Secular Humanism as the “religion” of the New World Order!

To understand what Secular Humanism really means in practice, please watch the cited videos. To understand its philosophical underpinnings, please read my article “**Morality derived from the Intellect leads to Enslavement!**” permanently linked to with this photograph:



Caption: Secular Humanism is the Moral Relativism of the New Age: Morality derived from Intellect leads to

Barbarianism and Enslavement under the false pretense of  
Enlightenment!

These documentaries reveal a concerted effort to subvert Theism, mainly Islam and Christianity respectively. Since this letter is addressed to Muslims, its focus is on Islam. However, a universal truth which applies to all Theism regardless of religion, and which appears to be a major impediment to the nihilism of the New World Order, is that only Theism teaches man in absolute moral codes how to overcome self-interests for higher moral cause; only Theism teaches man how to break his bonds of servitude to fellow man. And that is why the genuine practice of Theism and its absolute morality poses a real impediment to Secular Humanism and World Government which depend on moral relativism to promulgate their nihilistic agenda for the New Age.

As noted by Brian Gerrish in his *Lawful Rebellion* talk, all other major religious and ethnic populations in the West have become so secularized in the Western culture that only Islam today remains the effective impediment in its path – even though it is not much of one, as seen by the subversion of the Muslims and their religion! I quite agree with this introduction chapter by David Livingstone of the book “**Surrendering Islam – The subversion of Muslim politics throughout history until the present day**”: <http://surrenderingislam.com/surrendering-islam/surrendering-islam>.

What Livingstone has perhaps missed in his zeal (I haven't read his entire book), but which does not change his point about the subversion of Islam today made in that chapter, is that the subversion of Islam historically was started the day of 'Fatah Mecca' (and not just by the British creating sects through Machiavellian infiltrations). A dispassionate non-partisan study of recorded history itself shows that Islam was viewed differently by different peoples, many of whom converted overnight to the new religion of Arabia after a lifetime of opposition to it. As one critically examines the most momentous of times in the early days of Islam in the immediate aftermath of the death of its Prophet, even when one glosses over the first 25 years of tumultuous ad hoc political successions and rapid expansion of territories through their own *la mission civilisatrice*, the first dynastic imperial empire was really seeded by Abu Suffian. The mighty trader and leader of the Meccans, and the Prophet of Islam's greatest antagonist, Abu Suffian, standing next to Ibn Abbas (the Prophet's relative), on the mountains surrounding Mecca on the night of 'Fatah Mecca' – following the conquest of Mecca without bloodshed, and the Prophet's blanket proclamation of full pardon without seeking any retribution for the ten years of imposed military warfare by the Meccans upon the Muslims – and watching the vast field of thousands of bonfires dotting the Muslim tents in the valley below, realized that Islam potentially meant a lucrative “empire”, and told Ibn Abbas so!

Moral codes in Theism are indeed encased in the absolute **semantic strait-jacket** so feared by all tyrants across space and time and therefore, remain forever under attack and subversion. Islam, like all Theistic religions, has already answered the question of bondage to fellow man in showing the way to its effective severing. It is even part of the cryptic formula, the *Kalima*, recited by the adherent daily, without evidently understanding any of it: **“La ilaha ilallah”** (Arabic: لا إله إلا الله ) – **“there is no god but God”**.

Islam's clear prescription of bowing in servitude only to the One God of Truth is completely pre-conditioned upon **first** breaking the bonds of servitude to all other gods of falsehoods. A simple substitution of “God” with “Truth”, and “god” with “falsehoods” including the worship of “self-interests” and “society's gods” in the above daily declaration of faith makes the all encompassing import of *Kalima* self-evident. The logic of that declaration itself mandates this mental substitution in the proclamation of *Monotheism* in order to prevent it from degenerating into an absurdity.

Islam, for its followers, is anything but an absurdity. And yet, their facile understanding of it directly reduces their practice of their lofty proclamation of *Monotheism* to the absurdity of polytheism. Silence and apathy in the face of the ubiquitous spread of oppression and falsehoods in our time, is akin to directly bowing in servitude before the gods of tyranny. That silence and co-option permits tyranny to spread unchecked becoming its de facto first-cause enabler! Islam calls the allegiance to another *superpower*, or bowing in servitude before other gods and idols, *polytheism*. The abode of polytheists, the Holy Qur'an oft proclaims, is *Jahanam*.

accomplished today.

The sophistication of Islam's subversion however that is evidently running circles around the Muslim mind today, relies in the employment of complex political theory called Hegelian Dialectic: invent two or more opposing and polarized ideologies (or lies), say one entirely militant, and the other entirely spiritual, and get them to clash by forcing people to choose

From Abu Suffian, the harbinger of ill-begotten Muslim dynastic empires, to Bernard Lewis, the harbinger of fabricated “*clash of civilizations*”, spanning the gamut of those 14 centuries and with all the Muslim empires which David Livingstone glorifyingly mentions in-between, they all corrupted the Holy Qur'an's designated “*straight-path*” of guidance in Islam, the “*sirat-e-mustaqeem*” of *Surah Fatiha*, into “empire” – one way or another.

In today's modernity, Islam is principally subverted in the same mold by introducing “**beneficial cognitive diversity**” (sic!) into that original singular formulation of “*straight-path*”. See Islam and Knowledge vs. Socialization for details on how exactly it is

between them while perniciously harvesting each one in the greater service of *“imperial mobilization”*. This is the underlying philosophy in the “good Muslim” vs. “bad Muslim” dialectic, and in Presidential statements like *“either you are with us, or you are with the terrorists”*. The conflict that is naturally seeded in any clash of the opposites is an opportunity for *birth-pang* something far greater from the burnt ashes left behind. Tortuous processes so unleashed upon the unsuspecting public can leave so much confusion and chaos in its wake that as David Ben Gurion had explained the purpose of seeding controlled chaos: ***“what is inconceivable in normal times is possible in revolutionary times”***. And the Council on Foreign Relations proposed exactly that same modus operandi to seed world government:

'In short, the 'house of world order' will have to be built from the bottom up, rather than from the top down. It will look like a great '*booming, buzzing confusion*' to use William James' famous description of reality, but an end run around national sovereignty, eroding it piece by piece will accomplish much more than the old-fashioned frontal assault.'

Watch the fabrication of the Hegelian Dialectic of “militant Islam” vs. “moderate Islam” in the following two videos. Both are officially sponsored by the ruling establishment of the Hectoring Hegemons. These promulgate their respective asininity among the Muslims for a purpose so diabolical that it can only be fully comprehended in the domains of political theory, game theory, employing dynamic systems analysis, and not by studying each component separately.

### **'God is on your side'**



[youtube=<http://www.youtube.com/watch?v=WaiJtLrEwVU>]

### **The face of “moderate Islam”**





Caption Video Face of “**moderate Islam**” featuring Dr. Tahir-ul-Qadri, the “*Ambassador of Peace*”. An even more entertaining version of Daniel Pipe's choice for “**moderate Islam**” with its leader\* basking in the adulation of his prostrating fans, is [here](#) ([search](#))

This sophisticated Machiavelli is primarily the reason most Muslims, while knowing that there is something wrong with the 'War on Terror' in that the way the UK-US-EU axis of evil is going about it only creates more terror, remain perpetually confused by what is it that the West really wants when it arbitrarily seems to support opposites simultaneously. Inextricably caught between suicide bombers and F-16s, and between neo-colonialism and struggle for daily bread, most clutch at every strawman spun by any detracting snake-oil salesman in town. Thus we see the proliferation of conspiracy theories and plausible sounding false explanations with the concomitant “**beneficial cognitive diversity**” which these naturally engender, many of them deliberately created as red herrings (see [Anatomy of Conspiracy Theory](#)). And our learned scholars, news media, politicians, et. al., have all been so co-opted that they willingly lead the *Newspeak* chorus of 'war on terror', taliban, al-Qaeda song and dance routine as the *House Negroes* of the West. Our best minds have turned *Native Informant*. So who is left to explain Realityspeak to the Muslims?

As any knowledgeable person – who is not entirely deprived of mental acuity to have largely become a glorified parrot of history, often with imposing titles stamped upon his turban to lend respectability before the masses – would straightforwardly know, there are no empire's in the religion of Islam itself. Or, for that matter in any Theistic religion that is intended to be a *way of life* for ordinary peoples. Only 'religions' of the elite have empires. Interestingly, one can trivially spot the subversion of any religion by simply observing the stances of its pontiffs to the powers under which they flourish. This is true of the religion of both the Christian and Muslim peoples throughout the ages. The subversion of Theistic



theologies to support empire is empirical.

Find a word for “empire” for me in the Holy Qur’an as a commandment to seek it – as distinct from finding it in the history of the despotic Muslim rulers who did indeed build vast dynastic empires with the help of their own doctrinal scholars, from historians to narrators, no different than has been done since time immemorial. There is no basis for such dynastic imperialism in the Holy Qur’an. Indeed, Muslim civilizations, its arts, letters, and sciences, all flourished during those first 700 years after the Prophet of Islam. And these dominant Muslim civilizations also defined the “modernity” of their epoch. But so have many other civilizations of history including the present modernity of the Americans – the Classical Greeks arguably flourished even more than the Muslims, and for a lot longer period. But what does that have to do with a religion? The Muslim rulers of all these Muslim empires espoused as much moral gravitas as any other preceding or succeeding rulers in recorded history, ancient and modern. Who can deny that? The empirical fact that these Muslim empires were long running family dynasties acquired by bloodshed, and often maintained and perpetuated by the same sort of intrigues and bloodshed as Shakespeare’s Henry the whatever, is not hidden from anyone, except perhaps the Muslims.

Whereas, Islam defines itself rather precisely in the Holy Qur’an, and it is entirely about moral existence along a divinely defined path – the “*sirat-e-mustaqeem*” noted in its very first Chapter. Islam’s unequivocally stated aim is to give mankind the free-will of elevating itself to “*Ashraf-ul-Makhlooq-aaat*” – the best among all creations – while fully engaged in the vicissitudes of this life as commanded in its *Surah Asr*. And furthermore, to also be equally free to go the converse route, be the worst of all creations. The twain, Islam the religion, and Muslims (with their concomitant histories, narratives, cultures, civilizations, and good and evil choices throughout history which has ultimately led us to our present), are not the same thing. Only Bernard Lewis is confused about it. He even opens his formidable thesis titled: “**Crisis of Islam – Holy War and UnHoly Terror**”, redefining “Islam” in precisely that way (which evidently has also confused David Livingstone like many other Muslims):

'It is difficult to generalize about Islam. To begin with, the word itself is commonly used with two related but distinct meanings, as the equivalents both of Christianity, and Christendom. In the one sense, it denotes a religion, as system of beliefs and worship; in the other, the civilization that grew up and flourished under the aegis of that religion. The word Islam thus denotes more than fourteen centuries of history, a billion and a third people, and a religious and cultural tradition of enormous diversity.' (page 1, Bernard Lewis, Crisis of Islam)

See my exact deconstruction of that Machiavellian definition of “Islam” in [Behavior Control: Architecture of Modern Propaganda](#). Suffice it to note here that the Holy Qur'an has given a very precise meaning to the word “Islam” to exclusively designate a divine religion, a “deen” (الإِسْلَامَ دِينًا ) , and not a civilization, not a people (for which a separate word “Muslim” is used in the Holy Qur'an), and not an empire (for which there is no word in the Holy Qur'an):

'This day have I perfected for you your religion and completed My favor on you and chosen for you Islam as a religion;' ( Arabic أَلْيَوْمَ أَكْمَلْتُ لَكُمْ دِينَكُمْ ) Holy Qur'an, Surah Al-Maida 5:3)

As corrupted, subservient, powerless, and mentally colonized the two billion Muslims are today despite our vast piety and full mosques, and as convoluted and tortuous the understanding of Islam and what passes as its history has become, **still, according to Brian Gerrish in his aforementioned video, Islam and Muslims are evidently the single biggest social impediment to Secular Humanism!!**

In other words, Islam is the last wall to breach in order to usher in the full [1984-like](#) Orwellian New World Order, and all the details of enslavement which it portends, including, the elimination of religion, of family, and the big-Brother State birthing and owning the kids and raising them according to the new precepts of Secular Humanism. (See [What's the truth about modern medicine?](#))

Hollywood movies like [Logan's Run](#) and Aldous Huxley's fable [A Brave New World](#), while offering fun futuristic entertainment to the masses, have also been psychologically priming the Western public to this state of voluntary servitude wherein, a combination of Orwellian-Huxleyan worlds coupled with full mind-body control and total social engineering will simply make human revolt against the communist-style regimentation of the oligarchy as unthinkable as the revolt of sheep against the habit of mutton eating! That phraseology is borrowed from Bertrand Russell. Aldous Huxley had (perhaps self-servingly) observed in his [talk](#) at UC Berkeley in 1961, that eliciting such voluntary compliance from the plebes has remained the focus of all social engineering throughout the ages, **“to get people actually to love their servitude”** in what could only be called the **“ultimate in malevolent revolution”**:

'Today, we are faced, I think, with the approach of what may be called the ultimate revolution. The final revolution where man can act directly on the mind-body of his fellows. Well needless to say, some kind of direct action on human mind-bodies has been going on since the beginning of time. But this

has generally been of a violent nature.

The techniques of terrorism have been known from time immemorial and people have employed them with more or less ingenuity, sometimes with the utmost crudity, sometimes with a good deal of skill acquired by a process of trial and error, finding out what the best ways of using torture, imprisonment, constraints of various kinds.

But, as, I think it was Mettenif, said many years ago, you can do everything with bayonets except sit on them! If you are going to control any population for any length of time you must have some measure of consent. It's exceedingly difficult to see how pure terrorism can function indefinitely. It can function for a fairly long time, but I think sooner or later you have to bring in an element of persuasion. An element of getting people to consent to what is happening to them.

**Well, it seems to me that the nature of the Ultimate Revolution with which we are now faced is precisely this:** that we are in process of developing a whole series of techniques which will enable the controlling oligarchy who have always existed and presumably always will exist, **to get people actually to love their servitude!**

This is the, it seems to me, the ultimate in malevolent revolution shall we say.' (Aldous Huxley, 1961 UC Berkeley, minutes 3:05 to 5:17, transcribed by Project Humanbeingsfirst <http://sunsite.berkeley.edu/VideoTest/hux1.ram> )

What empirically stands in the path of fully realizing that state of affairs today?

The 1984 style thought control paradigm being enacted in the US--UK is portentous of what's to come to all of Western civilization as a very visible force – its signs are already visible all around us, thus far only disguised as the “war on terror” – see this article [“War on Terror is not about Islamofascism – get with the agenda you people”](#), for how it is perniciously making its way into the very fabric of American and European society where the “terrorists” now [“look Western”](#). And with this [Times Square bombing plot](#), I just heard Retired General Michael Hayden, the terrorist [“tickling”](#) specialist as the former director of the CIA and now with the Chertoff group selling all those body-scanners to the United States, on [MSNBC describing the new Al-qaeeda threat](#), and soon new laws will be enacted or enforced to deal with those. Already we are being conditioned to obey orders by

forcing us to take our shoes off at airports, and compelling us to exhibit our anatomical perfections to the perps manning the FAST scanners. Hollywood entertainment in "Total Recall" had presaged full body scanners at airports with people going through them without a second thought a full two decades ago. And we are doing exactly that today. The RFID implants are next. Zbigniew Brzezinski, like his intellectual confrere Aldous Huxley before him, had also predicted with matching chutzpah in his seminal 1970 book *Between Two Ages : America's Role in the Technetronic Era*, that:

'In the technetronic society scientific and technical knowledge, in addition to enhancing production capabilities, quickly spills over to affect almost all aspects of life directly. Accordingly, both the growing capacity for the instant calculation of the most complex interactions and the increasing availability of biochemical means of human control augment the potential scope of consciously chosen direction, and thereby also the pressures to direct, to choose, and to change.

Reliance on these new techniques of calculation and communication enhances the social importance of human intelligence and the immediate relevance of learning. The need to integrate social change is heightened by the increased ability to decipher the patterns of change; this in turn increases the significance of basic assumptions concerning the nature of man and the desirability of one or another form of social organization. Science thereby intensifies rather than diminishes the relevance of values, but it demands that they be cast in terms that go beyond the more crude ideologies of the industrial age.' (page 10)

This re-casting of values that "*go beyond the more crude ideologies of the industrial age*" with "*biochemical means of human control [which] augment the potential scope of consciously chosen direction,*" is the incontrovertible flag of scientific totalitarianism we see rapidly being unfurled today. While much less biochemical in its present state of deployment than in Aldous Huxley's narrative (but not for the want of it, for example see RFID Implants), it is no less coercive than in George Orwell's narrative. Brzezinski went on to prognosticate the "*trend*" in his book, and mind you with a foresight so uncannily accurate that he could only have been sitting at the same oligarchic dinner tables when the future that is already here today, was being planned into existence:

'In the technetronic society the trend seems to be toward aggregating the individual support of millions of unorganized citizens, who are easily within the reach of magnetic and attractive personalities, and effectively exploiting

the latest communication techniques to manipulate emotions and control reason.

Reliance on television—and hence the tendency to replace language with imagery, which is international rather than national, and to include war coverage or scenes of hunger in places as distant as, for example, India—creates a somewhat more cosmopolitan, though highly impressionistic, involvement in global affairs.' (page 11)

'Life seems to lack cohesion as environment rapidly alters and human beings become increasingly manipulable and malleable. Everything seems more transitory and temporary: external reality more fluid than solid, the human being more synthetic than authentic. Even our senses perceive an entirely novel “reality”—one of our own making but nevertheless, in terms of our sensations, quite “real.”

More important, there is already widespread concern about the possibility of biological and chemical tampering with what has until now been considered the immutable essence of man. Human conduct, some argue, can be predetermined and subjected to deliberate control. Man is increasingly acquiring the capacity to determine the sex of his children, to affect through drugs the extent of their intelligence, and to modify and control their personalities. Speaking of a future at most only decades away, an experimenter in intelligence control asserted, “I foresee the time when we shall have the means and therefore, inevitably, the temptation to manipulate the behaviour and intellectual functioning of all the people through environmental and biochemical manipulation of the brain.” (page 12)

'Another threat, less overt but no less basic, confronts liberal democracy. More directly linked to the impact of technology, it involves the gradual appearance of a more controlled and directed society. Such a society would be dominated by an elite whose claim to political power would rest on allegedly superior scientific know-how.

Unhindered by the restraints of traditional liberal values, this elite would not hesitate to achieve its political ends by using the latest modern techniques for influencing public behavior and keeping society under close surveillance and control.' (page 97)

Zbigniew Brzezinski's elite have already embarked on achieving their political end “*by using the latest modern techniques for influencing public behavior and keeping society under close surveillance and control*” as witnessed today. The culmination of this path of engineered social control, the “*tampering with what has until now been considered the immutable essence of man*” – a tortuous combination of Orwellian and Brave New World in which “*Human conduct [is] predetermined and subjected to deliberate control*” – will hit the West the hardest. They were the most used to living in free societies, and thus, by the necessity of management of the masses by the controlling oligarchy, had been given the illusions of freedom more than us in the East where we were long conditioned to god, kings, and dictators. As Goethe had observed: “*None are more hopelessly enslaved than those who falsely believe they are free*”. I do believe that mentally, as colonized the East has been physically, it is has been far freer than the West. In the East, we don't trust our elite, nor our government. In the West, most even refuse to believe that there is even an elite which runs their elected governments, and the vast majority “United We Stand” as is evident from 911.

The Orwellian-Huxleyan social engineering presently in the works takes away even those freedoms and those illusions – because, the West is headed towards full-spectrum dominance, but not just of the world, but of its peoples. I.e., totalitarianism the likes of which have not been seen in history. The East is not targeted for such mind-controlled totalitarianism, because, for one thing it is difficult to implement. We are too backwards as a scientifically controlled modernity. But not to fear, we are a direct target of population reduction and all the rest of Malthusian crap. See my deconstruction of [NSSM-200](#), and Bertrand Russell's “[Impact of Science on Society](#)”. But, as is the truism of life, we all have to go some day of course. So, arguably, at least let's live with a mind that isn't enslaved, even though the body may be in chains and under the constant threat of physical “shock and awe” from both the pirate suicide bombers working for the emperor as patsies, and the emperor's drones once again bringing us the *white man's burden*, its renewed *la mission civilisatrice*.

The only place left today to seek to make a home to raise one's family, appears to be back in the East – yes, where we are under constant “shock and awe”. The psychological attacks and sophisticated social engineering transpiring in the West, coupled with its scientific modernity, make surviving outside the “matrix” of thought control a rather challenging if not outright impossible task in the West. Crazy, isn't it? But crazy or not, choosing lesser of two evils has become part of the calculus of life's decision making – whatever the decision. Only fools and ignoramuses will ignore these parameters though – for ignorance is surely bliss. Taking the “[blue pill](#)” does have its rewards.

This potential obstruction to the elite's **religion of Secular Humanism** for their world government posed by Islam as a Theistic religion, and by ordinary practicing Muslims just living their ordinary family lives, is an entirely different and orthogonal dimension from the hectoring hegemon's harnessing of "militant Islam" and "moderate Islam" described above.

Before hearing Brian Gerrish's evidence last year and reflecting upon the matter ever since, I did not really believe Islam, the last of the great Theistic religions, to be anything other than a diabolical instrument of hegemony in the minds of hectoring hegemon's in the pre and post 9/11 world – just like Communism of the USSR was before it was dismantled. Something they brilliantly subverted to create a boogymen for seeding "***doctrinal motivation, intellectual commitment, and patriotic gratification***" in order to sustain "***Imperial mobilization***" on Zbigniew Brzezinski's Grand Chessboard. But something they had only utter contempt for.

Evidently, they also find Islam to be a genuine impediment to achieving their ultimate agenda of Secular Humanism. An impediment reaching outside of their direct ability to eliminate or even control. An empire in its own statecraft of hegemony never holds genuine impediments to its primacy ever in contempt. Rather, it always deals with them as a real enemy to subdue and dominate with "***military-style objectivity***" and "***avoidance of preconceived value assumptions***". That amoral phraseology is from the Report from Iron Mountain. The myriad Pentagon and think-tank documents such as the Joint Vision 2020 and PNAC which blithely strategize for "***full spectrum dominance***", afford a glimpse into that primacy mindset.

**Incredible! Muslims today, despite our pathetic servile condition slaving under the yoke of both mental and physical colonization, still potentially have something that is perceived as a real obstruction by the hectoring hegemon's in their nihilist calculus of world government.**

That alone is an excitement I cannot contain! I have something they can't control nor take away from me if I don't let them. Indeed, the pithy Surah Al-Asr of Islam, is perhaps the most potent political-spiritual weapon system in the Muslim possession if we can only learn to use it effectively. It can straightforwardly achieve what Etienne de La Boétie could not bring about in his "The Politics of Obedience: The Discourse of Voluntary Servitude"!

Islam's prescription to end man's voluntary servitude to tyranny, one which escaped Etienne de La Boétie's commonsensical Discourse, is ***Jihad-un-nafs***. Contrary to what many are led to believe as just an "inner struggle" with no outward manifestation, its true import is nothing less than revolutionary. Jihad-un-nafs principally directs us in our inner

struggles to break our bonds of servitude to fellow man, to overcome our fears, apathy, and silence. It is the reservoir from which saying 'No' to the *banality of evil* springs from. Jihad-un-nafs enables us to deny our own petty as well as existential self-interests when they conflict with morality and 'higher purpose'. For, it is only self-interests that trump morality which co-opt us and perpetually enslave us to any tyrant. Once such inner-struggle is underway, when fears and allegiances to falsehoods start melting away, when determination sets in which no denigrating labels may circumvent, when the fear of the loss of paycheck or confinement to state hospitality centers can no longer preempt moral stance, then, and only then, doors automatically open up, feet automatically start marching in the streets, mouths automatically come un-stitched, and in the limit, one fearlessly stands-up before the D9-Caterpillar bulldozer like Rachel Corrie, and before the armies of tyrants like David before Goliath, Hussein before Yazeed, Rosa Parks before KKK, Viva Palestina before Israel, .... As the late George Bernard Shaw had wisely observed: **“We are made wise not by the recollections of our past, but by the responsibility for our future.”** That responsibility becomes easier to shoulder when our self-interests can no longer trump our moral callings.

Pious peoples continually ask me what can they do as the justification for their silence and apathy. As consummate victims of the *banality of evil*, evidently they are so saddled with self-interests that they either pretend to not see the clear path as they rather stay busy in their various ritual acts of seeking *Heaven* instead of stand-up to wrong-doings, or, suffer from a myopia characteristic of self-absorption and/or indoctrination. Well, *Heaven*, if there is one in the future, is surely denied to those who help create hell on earth today – for, evil only flourishes when well-intentioned people remain silent spectators and do nothing to stop it. Often times they even directly collaborate in it as part of their daily grind, collectively culminating in horrendous evils – *the banality of evil!* Jewish scholar Hannah Arendt had already explored that aspect of it in copious detail in the context of the Third Reich in 1963. Just two score years later, I too had dwelled upon it in my very first piece of public writing in the context of the Fourth one. For our purposes here however, let's briefly examine this idea of apathy logically within the Theistic beliefs of the Muslims themselves. I have examined indoctrination and the reigning twisted epistemology which blinds one to it elsewhere.

Do pious Muslims filling their mosques in relative comforts while humanity everywhere is oppressed at the altar of the lusts of the Hectoring Hegemons, think that *Jahanam* will be the abode of only the few tyrants and their soldiers of fame and fortune who directly inflicted the evils? That their own souls are spotless since they stayed busy in ritual piety *waiting for Allah?*



If it is true that tyrants flourish only with the assistance of the majority who silently comply, and empiricism and history both lend substantial evidence to this view (Etienne de La Boétie almost 500 years ago gave a compelling description of it in his Discourse cited above), then, it logically follows that the first-cause enablers of tyranny and its spread throughout the lands is the silently spectating apathy of the peoples! Those who enable crimes are no less culpable than those who commit crimes.

The inescapable logic of this condemns the first-causers to be the backbone fuel of the very inferno they so wish to escape with their obsession with ritual piety while Creation burns. If the god whom pious Muslims worship is a rational god, then this must be true – for, only in courageously rising to break the bonds of servitude to fellow man is Islam's "*Ashraf-ul-Makhlooq-aa*" birth-panged into existence. If however, their god is irrational, as many learned scholars proclaim when they attribute arbitrariness to god's justice due to its self-proclaimed omnipotence, then is such a god anything more than Zeus, the anthropomorphic god of ancient Greece? Why fall in prostration to Zeus 5 times each day?

Even Nuremberg, as fallible as that Military Tribunal was in its administration of 'victor's justice', focussed on the first-cause (self-servingly) ignoring the Allied bombings of civilian population centers and dropping of atomic bombs. Nuremberg called the Nazi aggression the first-cause of war, "***the supreme international crime differing only from other war crimes in that it contains within itself the accumulated evil of the whole.***"

When the first-cause is always held more culpable even in our fallible courts on earth, do Muslims think that in the Court of the *Most Just* the first-cause enablers will get a free-ride?

Many thinking Muslims presume that the god they worship is absolute in its *Justice*. Otherwise, they feel that the whole notion of *Accountability* on the *Day of Judgment* in the *Hereafter* becomes meaningless gibberish, devoid of substance. Indeed, were that not the case, God's Justice would be reduced to the whimsical moral relativism that is already being thrust upon us in these times as propositioned by a US Supreme Court Justice:

'Nothing is more certain in modern society than the principle that there are no absolutes, that a name, a phrases, a standard has meaning only when associated with the considerations which give birth to nomenclature. To those who would paralyze our Government in the face of impending threat by encasing it in a semantic strait-jacket, we must reply that all concepts are relative.' Justice Vinson, U.S. Supreme Court, 1951

Moral codes in Theism are indeed encased in the absolute ***semantic strait-jacket*** so

feared by all tyrants across space and time and therefore, remain forever under attack and subversion. Islam, like all Theistic religions, has already answered the question of bondage to fellow man in showing the way to its effective severing. It is even part of the cryptic formula, the *Kalima*, recited by the adherent daily, without evidently understanding any of it: **“La ilaha ilallah”** (Arabic: لا إله إلا الله ) – **“there is no god but God”**.

Islam's clear prescription of bowing in servitude only to the One God of Truth is completely pre-conditioned upon **first breaking** the bonds of servitude to all other gods of falsehoods. A simple substitution of “God” with “Truth”, and “god” with “falsehoods” including the worship of “self-interests” and “society's gods” in the above daily declaration of faith makes the all encompassing import of *Kalima* self-evident. The logic of that declaration itself mandates this mental substitution in the proclamation of Monotheism in order to prevent it from degenerating into an absurdity. The Holy Qur'an admonishes not to make a mockery of its teaching:

'That this is indeed a Qur'an Most Honourable, In a Book well-guarded, Which none shall touch but those who are clean: A Revelation from the Lord of the Worlds. **Is it such a Message that ye would hold in light esteem?**' Holy Qur'an, Surah Al-Waqia, 56:77-81

### Iqbal's Poem from Zarb-E-Kaleem explains “there is no god but God”

خودی کا سر نہاں لا الہ الا اللہ  
خودی بے تیغ، فساں لا الہ الا اللہ

Khudi ka sirr-e-nihaaN La ilaha il Allah  
khudi hai tegh-e-fasaaN La ilaha il Allah

The secret of the Self is hid, In words "No god but He alone".  
The Self is just a dull-edged sword, "No god but He," the grinding stone.

یہ دور اپنے براہیم کی تلاش میں ہے  
صنم کدہ ہے جہاں، لا الہ الا اللہ

Yeh daur apne 'Brahmeem ki talaash mein  
hai  
Sanam-kadah hai jahaaN La ilaha il Allah

An Abraham by the age is sought To break the idols of this Hall:  
The avowal of God's Oneness can Make all these idols headlong fall.

کیا ہے تو نے متاع غرور کا سودا  
فریب سود و زیاں، لا الہ الا اللہ

Kiya hai tu ne mataa'-e-gharoor ka sauda  
fareb-e-sood-o-ziyaaN ! La ilaha il Allah

A bargain you have struck for goods Of life,  
a step, that smacks conceit,  
All save the Call "No god but He" Is merely fraught with fraud and deceit.

یہ مال و دولت دنیا، یہ رشتہ و پیوند  
بتان وبم و گماں، لا الہ الا اللہ

Yeh maal o dawlat-e-dunya, yeh rishtha o  
paivand  
butaan-e-vehm-o-gumaaN! La ilaha il Allah

Islam, for its followers, is anything but an absurdity. They'd sooner die than mock their religion. And yet, their facile understanding of it directly reduces their practice of their lofty proclamation of *Monotheism* to the absurdity of polytheism. Silence and apathy in the face of the ubiquitous spread of oppression and falsehoods in our time, is akin to directly bowing in servitude before the gods of tyranny. That silence and co-option permits tyranny to spread unchecked becoming its de facto first-cause enabler! Islam calls the allegiance to another *superpower*, or bowing in servitude before other gods, *polytheism*. The abode of polytheists, the Holy Qur'an oft proclaims, is *Jahanam* (the metaphorical abode in the *Hereafter* where accounts are to be settled for creating, aiding and abetting, the hell on earth). **Q.E.D.**

The invitation to break all false gods and idols is the first Abrahamic creed of Islam. Without it, there is no Islam – only hypocritical pretensions. This Qur'anic similitude was well understood by previous generations of Muslims. This is even evidenced in the twentieth century poet-philosopher of Muslims, Muhammad Iqbal's attempts at transforming the *Muslim umma* from the shackles of ubiquitous colonialism and servitude (see poem in the sidebar).

But Muslims in our present age of *Jahiliya* have been deftly indoctrinated into believing that *polytheism* is only about worshipping the *stone statues* like the ones which inhabited the *Kaaba* before the advent of

The worldly wealth and riches too, Ties of  
blood and friends a dream  
The idols wrought by doubts untrue, All  
save God's Oneness empty seem.

خرد ہوئی ہے زمان و مکاں کی زبانی  
نہ ہے زمان نہ مکاں، لا الہ الا اللہ

Khird huwee hai zamaan o makaan ki  
zunaari  
na hai zamaaN, na makaaN! La ilaha il  
Allah

The mind has worn the holy thread Of Time  
and Space like pagans all  
Though Time and Space both illusive "No  
god but He" is true withal.

یہ نغمہ فصل گل و لالہ کا نہیں پابند  
بہار ہو کہ خزاں، لا الہ الا اللہ

Yeh naghma fasl-e-gul o laaleh ka nahin  
paband  
bahaar ho ke khizaaN, La ilaha il Allah

These melodious songs are not confined To  
Time when rose and tulip bloom  
Whatever the season of year be "No god  
but He" must ring till doom.

اگرچہ بت ہیں جماعت کی آستینوں میں  
مجھے ہے حکم اداں، لا الہ الا اللہ

Agarche buth hain jama'at ki aasteenoN  
mein  
mujhe hai hukm-e-azaaN, La ilaha il Allah

**Many idols are still concealed' In their  
sleeves by the Faithful Fold,  
I am ordained by Mighty God To raise the  
call and be much bold.**

Translated by: Syed Akbar Ali Shah ([listen](#))

Islam and its latter day variants, both physical and abstract, seen among peoples of many faiths. Such as, the Holy Trinity of the Christians (the Father, the Son, the Holy Ghost), and the physical representations of the many gods of the Hindus!

**While loudly decrying those gods of others, Muslims daily reaffirm their own allegiance to all the false gods of pelf and power to advance their petty livelihood and ephemeral station!**

All those signature prostrations on the prayer-mat and the circumambulations around the *Kaaba* leaving their indelible mark of piety on the forehead of silence to the hell on earth, may yet turn out to be the key evidence for the eternal purgatory of *Hell* for *polytheism* in the *Hereafter*. For Islam to make any rational sense at all, that is the only logic of justice which falls out. And that logic has been reaffirmed in Surah Al-Asr of the Holy Qur'an, in the second most misunderstood formulaic daily rehearsal by Muslims: **“*Wa ta wa so bil haq*”** (Arabic 103:3 وَتَوَاصَوْا بِالْحَقِّ ) – **“and those who strive for haq”**. What is “haq” but another synonym for truth, justice – the exact antithesis of silent collaboration with tyranny? **2 + 2 still equals only 4, even when the pious might insist upon 5!**

It is surely the most ironical of empirical paradoxes that it is not the theists by and large, but the moral atheists who have courageously risen to shoulder that **“responsibility for our future”!** See [Islam and Knowledge vs. Socialization](#) for why, contrary to popular belief, even the atheist is not without an inner moral compass (see Bertrand Russell's formulation cited therein). Perhaps the pious living for the *Hereafter* in obliviousness to the tyranny around them, might strive to learn from the godless to value the *here and the now* more than *Hereafter*; to endeavor to make the present less hellish in order to avoid it in the *Hereafter*; to be more concerned with affairs of the *here* than of the *Hereafter*; and in doing so perhaps come to learn the real intent of Theism – **“*Wa ta wa so bil haq*”** – from these moral atheists!

It would be a well-deserved divine irony if moral atheists who stood by their fellow man without fear of hell or favor of heaven, come to constitute the largest citizenry of any *Heaven* if God does turn out to exist! They will end up with the last laugh in either case! That's all I can say to the pious silent bystanders of modernity prostrating daily in ritual prayers. Poet Iqbal said it a bit more delicately:

جو میں سر بسجدہ ہوا کبھی تو زمیں سے آنے لگی صدا  
تیرا دل تو بے صنم آشنا، تجھے کیا ملے گا نماز میں

Jo Mein Sar-ba-sajada Hova Kabhi, To Zameen Se Aane Lagi Sada

Tera Dil To Hai Sanam Aashana, Tujhe Kya Milega Namaaz Mein  
(transliteration, [listen](#))

'Ever I bowed my head in prostration, there arose hue and cry from the ground:

Thy heart is enamoured by idols, what shalt thou find in prayers?' (Kalaam-e-Iqbal, Bang-e-Dara)

East or West, theist or atheist, being aware of the real challenges for those who choose to not merely exist in a dream-state, I believe, will prepare one to meet them more effectively. Self awareness however is the key to the awareness of reality. As Edward Bernays stated it bluntly in the opening passage of his book titled [Propaganda](#): "*We are governed, our minds are molded, our tastes formed, our ideas suggested, largely by men we have never heard of.*" The videos cited at the top of this letter empirically show that a formidable totalitarian system is being engineered even as we speak, and we are being convinced to accept it. Why are they succeeding? How are they able to control our perceptions? I am afraid that most Muslims remain unaware of all this concerted social engineering as many continue to sing the [empire's 'War on Terror' song](#) against the Islamofascists. Soon, Muslims might be surprised to find their own religion banned in the West and their very identity as Muslim being associated with "terrorism". In a generation or two, there won't be any overt Muslims. A far cry?

Not if this [Oped in Pakistan's Dawn](#) of May 06, 2010 is portentous:

*'Hussain immigrated to the United States in 2003 and said his children had once even asked if they could change their names due to the image of their homeland in the wake of the September 11, 2001 attacks.'*

The headline screaming in [today's Dawn](#), May 07, 2010, is even more revealing, even if perhaps mainly as [Mighty Wurlitzer's](#) psyop to get others to follow suit:

**'Pakistanis pose as Indians after NY bomb scare: NEW YORK: Pakistani merchants and job seekers in the United States, still reeling from economic hardship since the Sept. 11 attacks of 2001, are posing as Indians to avoid discrimination in the wake of the Times Square bomb attempt.'**

The systematic demonization of Islam and Muslims is being conducted not merely by the vile ignoramuses and the agents provocateurs in burning the Holy Qur'an (see [Hijacking the word 'Islam' for Mantra Creation](#) ), but officially by the State itself as evidenced in what the FBI is teaching its agents even in the tenth year of 9/11 ( see [WIRED: FBI Teaches](#)

Agents 'Mainstream' Muslims Are 'Violent, Radical' and 7th-Century Simpletons July and September 2011 ). Mother Jones magazine September/October 2011 issue reports that the FBI has built a massive network of spies to prevent another domestic attack (sic!), “*The bureau now maintains a roster of 15,000 spies, some paid as much as \$100,000 per case, many of them tasked with infiltrating Muslim communities in the United States.*” Teamed up with the University of California-Berkeley's Investigative Reporting Program, the author of that report gallantly asked – perhaps to add a measure of chutzpah after carefully omitting to challenge the core-axiom of the State that 9/11 was the work of Muslim terrorists – “*But are they busting terrorist plots—or leading them?*”

That Machiavellian trend of calculated lying by way of omissions in respectful looking reportage, backed by academic prestige which retain the core presuppositions of empire necessary to craft the Hegelian Dialectic of Dissent, is ubiquitous. It was brazenly apparent in the May 2011 CAIR report which was co-sponsored by the University of California-Berkeley's Center for Race and Gender (see CAIR Documenting Islamophobia on the rise in the USA – Calling CAIR to Account for its Omissions By Zahir Ebrahim ). It was also evident in the followup August 2011 report by a private Washington think-tank called American Progress, gallantly titled “Fear, Inc.” (see Zahir Ebrahim's response to Fear, Inc. The Roots of the Islamophobia Network in America ). Both of these reports respectably documented the rise of Islamophobia in America. But they also egregiously failed to examine its root cause and motivation in the geopolitical context of the 'War on Terror'.

The concept that this synthetic war on terror was being used as the pretext for ushering in one-world government is completely absent in these (yawn) narratives! Perhaps these brilliant pundits are poorly read only in certain impermissible scholarship. Or, the more likely, the most respectable looking academic scholarship and award-winning journalists are being engaged by the Mighty Wurlitzer to convey both the empire's opprobrium of “Militant Islam”, as well as what's permissible dissent. Notice how – by retaining the notion of “Militant Islam” in the guise of critiquing the reactionary excesses of the sole superpower in response to 9/11. That is the standard line of acceptable dissent. (See Zahir Ebrahim's Response to Chris Hedges' amalgam of half-truths 'A Decade After 9/11: We Are What We Loathe' )

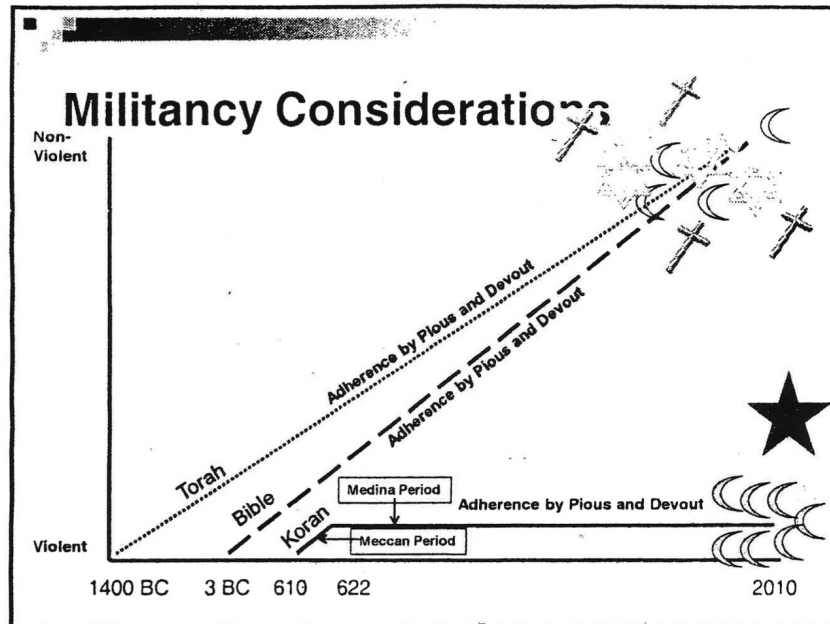

Caption An FBI presentation titled "Militancy Considerations" measures the relationship between piety and violence among the texts of the three Abrahamic faiths [ **the god's chosen people obviously coming out on top!!!** ] As time goes on, the followers of the Torah and the Bible move from "violent" to "non-violent." Not so for devotees of the Koran, whose "moderating process has not happened." The line representing violent behavior from devout Muslims flatlines and continues outward, from 610 A.D. to 2010. In other words, religious Muslims have been and always will be agents of aggression. ([source](#))

It's a pretty slick game of full spectrum assault on all human senses, cognitive as well as subliminal. Hollywood has already interjected that thought of banning the Qur'an into Western consciousness in the movie "V for Vendetta". Soon – that demand might actually be heard on mainstream television in the many choruses of the Mighty Wurlitzer. It ought not to surprise anyone if Muslim faces are presented as Hegelian counterpoint, demanding a "moderate" Islam instead of banning the Qur'an outright! (See Hijacking the word 'Islam' for Mantra Creation). Muslims have plenty of House Niggers and cultivated agents and assets in the West who will be harvested for this purpose. (See FAQ: What is an Intellectual Negro) Such a demand simply cannot be plausibly made, or effectively implemented, in the East! Judging from the riots that break out on the "mere" cartooning of the Prophet of Islam – O yes, we are surely slated for population reduction, the "*useless eaters*" of humanity, **while we apathetically wait for Allah to change our condition:**

'For his sake there are angels following one another, before him and behind him, who guard him by Allah's commandment; surely **Allah does not change the condition of a people until they change their own**

**condition;** and when Allah intends evil to a people, there is no averting it, and besides Him they have no protector.' (Holy Qur'an, Surah Al-Ra'd, 13:11)

Evidently, the God of the Muslims says different from what a lot of Muslims have been led to believe (vicariously) that *Allah chala raha hai* (God is running the world). If someone were to ask me, I'd suggest that obsessive immoral devils are running the world. Because, Allah has unequivocally proffered all human beings to stand up to these devils; to not wait for Allah to change their condition; to manage their own affairs with **“*Wa ta wa so bil haq*”** and with patience if their life is not to be a total loss despite all its material as well as spiritual advancement (see my [examination](#) of my understanding of Surah Al-Asr).

– **End Letter** –

**Endnote:** All quotes and unfamiliar concepts in the text can be studied further by using the [Search-box](#) on Project Humanbeingsfirst's [homepage](#). Please help give wide circulation to this letter. The most pious institutions of the Muslims, and our most learned men and women of Letters and the Cloth heading them, are the most villainous Trojan Horses among us — empowering the individual with knowledge and understanding is its only antidote. Thank you.

**Supplemental Readings on** <http://faith-humanbeingsfirst.blogspot.com>

[1] [Islam and Knowledge vs. Socialization](#)

[2] [Hijacking the word 'Islam' for Mantra Creation](#)

[3] [Islam: Surah Al-Asr of the Holy Qur'an](#)

[4] [Islam: Why is the Holy Qur'an so easy to hijack? Part-1, Part-II](#)

**Short URL:** <http://tinyurl.com/Islam-vs-Secular-Humanism>

**Source URL:** <http://faith-humanbeingsfirst.blogspot.com/2011/07/islam-vs-secular-humanism.html>

Original date of Letter: Friday, May 07, 2010



## Chapter 19 Not Fooled Again: The Alien Invasion

### The Agenda Behind Aliens and UFOs - A Hegelian Mind-Fck Part-II

#### Seeding the 'Clash of Planets' and the 'War of the Worlds' to cement one-World Government



Caption The Agenda Behind Aliens and UFOs - A Hegelian Mind-Fck Part-II By Zahir Ebrahim.

**Secret** : *those who know do not speak; those who speak do not know; those who know and speak always sleep with the fishes.* **State** : *Deception is a state of mind and the mind of the State.*

Therefore, **leaking a State-Secret** : *only a tune played by the Mighty Wurlitzer (Image via TFC iamthewitness.com)*

Continuing from [Part-1](#), January 04, 2011, where, in response to the mainstream [news](#) and other [reports](#) on Julian Assange/Wikileaks threatening to reveal secret documents pertaining to UFOs: ***“it is worth noting that in yet-to-be-published parts of the cablegate archive there are indeed references to UFOs”***, I had observed:

If you use political science to understand this absurdity, it does not appear to be an absurdity at all, but a very important unveiling of the new 'big lie' that has been a long time in the making,

beginning with Orson Wells' dramatization in New York in 1938 of H. G. Wells 'War of the Worlds'! That social engineering project prototype to study [mass panic behavior](#) was funded by the Rockefeller Foundation, as it later came out. Read the condensed summary paper by Hadley Cantril ([PDF](#)), 1947, to glean some insight into group categories and how people reacted

then under the implanted false belief. Would masses react any differently now?'

This topic has intrigued me for many years, not just as entertaining science fiction of which I have been an avid reader since at least 6th grade when I first encountered Arthur C. Clarke in the British Council Library Lahore, Pakistan, but from the perspective of social engineering by ubermensch predators to create a new *super Ali Baba++* threat to terrorize mankind to continue on with the next stages of "*imperial mobilization*". Especially since the used-up Ali Baba was finally retired on May 1, 2011. (See [The Mighty Wurlitzer by Zahir Ebrahim](#))

Zbigniew Brzezinski had both forthrightly and self-servingly presaged the power of social engineering to manufacture consent among the modern *unwashed*

*masses* in Western democracies, especially in the sole superpower, for the unpopular narrow agendas of the elites, in his 1997 book *The Grand Chessboard*:

"The earlier empires were built by aristocratic political elites and were in most cases ruled by essentially authoritarian or absolutist regimes. The bulk of the populations of the imperial states were either politically indifferent, ... or infected by imperialist emotions ...a quest for national glory, 'the white man's burden', 'la mission civilisatrice', not to speak of the opportunities for personal profit - all served to mobilize support for imperial adventures to sustain essentially hierarchical imperial power pyramids. The attitude of American public toward the external projection of American power has been more ambivalent. The public supported America's engagement in WWII largely because of the shock effect of the Japanese attack on Pearl

Fabricating a public discourse on an absurd fantasy as if it's something real by couching it in the veneer of science (or declassified State-Secrets/whistleblowing/leaks), and then self-servingly reacting to that fabrication as a threat to national security at supra-national levels from the United Nations to the Catholic Church to justify and dignify the expenditure chasing the new immanent threat, only legitimizes such discourse among the public as plausible. It fertilizes the stage for the subsequent creation of a new insurmountable global threat, **the Clash of Planets**. If political scientists are to be believed on the utility of diabolical protocols for "*imperial mobilization*", then, "***that exercise requires a high degree of doctrinal motivation, intellectual commitment, and patriotic gratification.***" Its doctrinal seeds must be planted years in advance. This new shock-therapy threat too will also of course be launched with the dialectical ultimatum: "***either you are with us, or with the aliens***"!

Harbor. .... After the Cold War had ended, the emergence of the United States as the single global power did not evoke much public gloating but rather elicited an inclination toward more limited definitions of American responsibilities abroad. Public opinion polls conducted in 1995 – 1996 indicated a general public preference for 'sharing' power with others, rather than for its monopolistic exercise.” (ibid. pgs. 24,25)

“It is also a fact that America is too democratic at home to be autocratic abroad. This limits the use of America's power, especially its capacity for military intimidation. Never before has a populist democracy attained international supremacy. **But the pursuit of power is not a goal that commands popular passion, except in conditions of a sudden threat or challenge to the public's sense of domestic well-being.** The economic self-denial (that is defense spending), and the human sacrifice (casualties even among professional soldiers) required in the effort are uncongenial to democratic instincts. Democracy is inimical to imperial mobilization.” (ibid. pgs. 35,36)

“Public opinion polls suggest that only a small minority (13 percent) of Americans favor the proposition that 'as the sole remaining superpower, the US should continue to be the preeminent world leader in solving international problems'. ... **Moreover, as America becomes an increasingly multicultural society, it may find it more difficult to fashion a consensus on foreign policy issues, except in the circumstance of a truly massive and widely perceived direct external threat.** .... More generally, cultural change in America may also be uncongenial to the sustained exercise abroad of genuinely imperial power. **That exercise requires a high degree of doctrinal motivation, intellectual commitment, and patriotic gratification.** ... Mass communications have been playing a particularly important role in that regard, generating a strong revulsion against any selective use of force that entails even low levels of casualties .... In brief, the U.S. Policy goals must be un-apologetically twofold: to perpetuate America's own dominant position for at least a generation and preferably longer,....” (ibid. pgs. 211-215)

Having been a *malcontent* student of many a *hectoring hegemon* long before *the catalyzing event of the New Pearl Harbor* was inflicted upon mankind on September 11, 2001, I have been diligently studying all facets of *engineering consent* especially since. I have also learned how to parse the layered writings of the hectoring hegemons. At one level,

Brzezinski wants to ***“perpetuate America's own dominant position for at least a generation and preferably longer,”***.

But at another level, empiricism betrays that the blueprint in *the Grand Chessboard* for waging endless wars, is in fact designed to bankrupt America in order to end its national sovereignty (see [“A Note on Unlayering the Middle East War Agenda: Making Sense of Absurdities”](#)). Zbigniew Brzezinski is himself the representative of the globalists, being a leading thinker for the Council on Foreign Relations, the Trilateral Commission which he co-founded with David Rockefeller and was its first Executive Director, etceteras. And the globalist stated agenda is just the opposite from what's deceptively narrated in *the Grand Chessboard* – to usher in Global Governance in a World Government where nation states are just the municipalities of local administration, perhaps continuing to fly their own national flags but nothing else is theirs.

All governance laws, economics, military, policing, planning, production, harvesting natural resources under their own national soil, and even core social values which have affectionately come to be called “secular humanism”, to be driven from a centralized planning oligarchy, much like what's envisioned in Karl Marx's *The Communist Manifesto!* If one examines the 10 points of his architecture to restructure society, the increasing resemblance to modernity is only co-incidental of course (sic!).

The globalist openly proclaim their own modus operandi, so that we won't have to guess at either their motives, or their methods, and be labeled *conspiracy theorists* – too bad so few people read, even fewer think (*some suggest less than 2% people actually think, 8% think they think, and 90% would not be caught dead thinking*). Here is Richard N. Gardner of the Council on Foreign Relations, helping those who can actually think understand way back in April 1974 in his article [“The Hard Road To World Order”](#), how the globalist plan to subvert nation states with ***“an end run around national sovereignty, eroding it piece by piece [which] will accomplish much more than the old-fashioned frontal assault.”***:

“In short, the ‘house of world order’ will have to be built from the bottom up, rather than from the top down. It will look like a great ‘booming, buzzing confusion’ to use William James’ famous description of reality, but an end run around national sovereignty, eroding it piece by piece will accomplish much more than the old-fashioned frontal assault.

Of course, for political as well as administrative reasons, some of these specialized arrangements should be brought into an appropriate

relationship with the central institutions of the U.N. system, but the main thing is that the essential functions be performed.

The question is whether this more modest approach can do the job. Can it really bring mankind into the twenty-first century with reasonable prospects for peace, welfare and human dignity? The argument thus far suggests it better had, for there seems to be no alternative. But the evidence also suggests some grounds for cautious optimism.” (ibid. pgs. 558-559)

It should be self-evident by now that implanting the fear of some new super boogymon to supplant the existing *Ali Baba of terrorism*, Osama Bin Laden, with Extraterrestrials, UFOs, Aliens, other global and galactic catastrophes, as enabling myths, serves those very globalist interests hand in glove. Who does not understand the import of engineered myths to statecraft? Evidently the vast majority who 'United We Stand' with them. Even though, the hectoring hegemon once again go through the inordinate bother of explaining it themselves to save us the trouble of having to figure it all out by reverse engineering some coherent sense from the unfurling visible reality which otherwise only appears steeped in absurdities. I have already examined the import of their own words in “Wikileaks and Imperial Mobilization” and the following passage captures it sufficiently for our purpose here:

'The Mighty Wurlitzer operates on the core premise which has been empirically shown to psychologically motivate most human action. That premise was elegantly captured in the following insightful observation made at the so called “Terrorism Study Group”, that **“Public Assumptions' Shape Views of History: Such presumptions are beliefs (1) thought to be true (although not necessarily known to be true with certainty), and (2) shared in common within the relevant political community. The sources for such presumptions are both personal (from direct experience) and vicarious (from books, movies, and myths).”** Successfully implanting such presumptions and pre-suppositions among any group is to motivate its overall actions in accordance with those implanted beliefs. Thus, many intelligent peoples for whom it is otherwise inexplicable to understand why they persist in 'United We Stand' with absurdities, are motivated to react sympathetically to those absurdities.'

## Using State-Secrets For Myth Fabrication

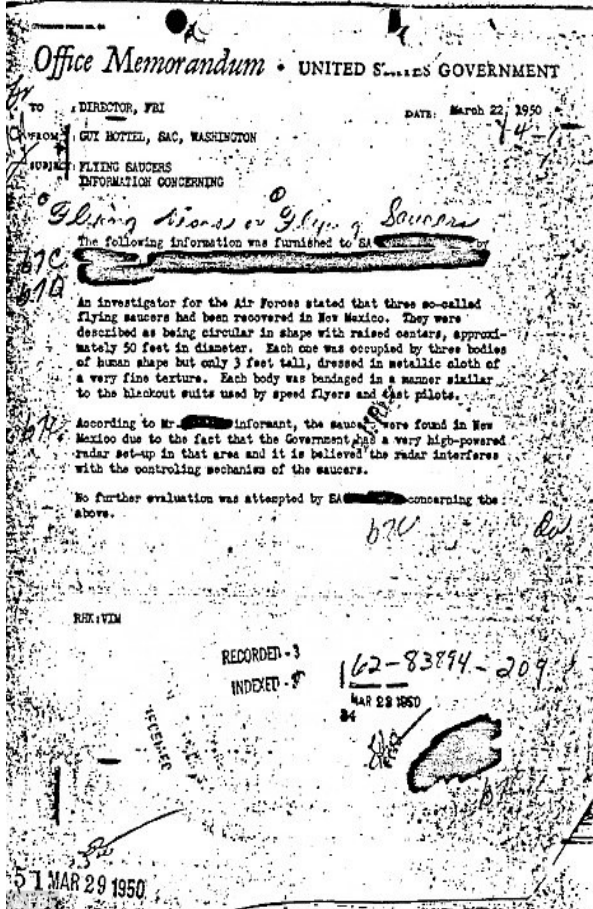

Caption 'Proof of (alien) life? A copy of the 1950 memo that recounts the discovery of flying saucers and aliens in New Mexico. The memo has been published on the FBI website' --- [UK Daily Mail 9th April 2011](#).

A more perceptive caption however would read: **'The Art of the Mighty Wurlitzer: How to fabricate Aliens and UFOs Myths using the ploy of leaking State-Secrets'**

## Using absurdities For Myth Fabrication: Pope's astronomer says he would baptise an alien if it asked him

'Aliens might have souls and could choose to be baptised if humans ever met them, a Vatican scientist said today. The official also dismissed intelligent design as "bad theology" that had been "hijacked" by American creationist fundamentalists.

Guy Consolmagno, who is one of the pope's astronomers, said he would be "delighted" if intelligent life was found among the stars. "But the odds of us finding it, of it being intelligent and us being able to communicate with it – when you add them up it's probably not a practical question."

Speaking ahead of a talk at the British Science Festival in Birmingham tomorrow, he said that the traditional definition of a soul was to have intelligence, free will, freedom to love and freedom to make decisions. **"Any entity – no matter how many tentacles it has – has a soul."** Would he baptise an alien? **"Only if they asked."** --- [UK Guardian 17 Sep 2010](#)

### **Alice in Wonderland: UN 'to appoint space ambassador to greet alien visitors'**

'Mazlan Othman, a Malaysian astrophysicist, is set to be tasked with co-ordinating humanity's response if and when extraterrestrials make contact.

**Aliens who landed on earth and asked: "*Take me to your leader*" would be directed to Mrs Othman.**

She will set out the details of her proposed new role at a Royal Society conference in Buckinghamshire next week. The 58-year-old is expected to tell delegates that the proposal has been prompted by the recent discovery of hundreds of planets orbiting other stars, which is thought to make the discovery of extraterrestrial life more probable than ever before. Mrs Othman is currently head of the UN's little known Office for Outer Space Affairs (Unoosa).

Opinion is divided about how future extraterrestrial visitors should be greeted. Under the Outer Space Treaty on 1967, which Unoosa oversees, UN members agreed to protect Earth against contamination by alien species by "sterilising" them. Mrs Othman is understood to support a more tolerant approach.

But Professor Stephen Hawking has warned that alien interlopers should be treated with caution. He said: "*I imagine they might exist in massive ships, having used up all the resources from their home planet. The outcome for us would be much as when Christopher Columbus first landed in America, which didn't turn out very well for the Native Americans.*" --- UK Telegraph 26 Sep 2010

**President Ronald Reagan Ponders The Beneficial Consequences of an Alien Threat from Another Planet, Speaking at the UN General Assembly, Sept. 21, 1987**



***“If suddenly there was a threat to this world from some other species from another planet,”*** President Ronald Reagan had read out loud from his script at the United Nations General Assembly podium in 1987, ***“in our obsession with antagonisms of the moment, we often forget how much unites all the members of humanity. Perhaps we need some outside universal threat to make us recognize this common bond. I occasionally think how quickly our differences worldwide would vanish, if we were facing an alien threat from outside this world!”*** --- President Ronald Reagan, Speaking at the UN General Assembly, September 21, 1987

**National Geographic Channel Show catches up to Reagan in 2011: Ponders The Possibility of an Alien Attack**



“It should be as statistical as human nature, for example, that there's going to be good guys and bad guys,” says Dr. Travis Taylor, who's with the U.S. Space and Missile Command Department and has worked with the Department of Defense and NASA for 20 years.

“What we would hope is that the good guys show up first, and that would be really nice. But the point of this wasn't to debate whether they are or they aren't, it's what happens if they did. Do we have a plan? What type of plan should we put together, and how would we defend the planet?” Taylor has also written the handbook for harrying aliens, *An Introduction to Planetary Defense*.

Lt. Col. Brian De Toy, director of defense and strategic studies program at West Point, doesn't buy the premise. *“I am a skeptical believer in miracles. So a year ago right now I was in Iraq, and I'm more worried about Iraq and Afghanistan right now and the aliens that I'm dealing with there. And so right now, I'm pretty skeptical about the others.”* --- National Geographic, Reported by Boston Herald May 17, 2011



I had already stated the implication of all this in my April 2009 newsletter on [Financial and State Terrorism](#), and re-emphasized in my December 2009 tutorial [“The Brilliant Construction of World Order – Or a children's bedtime story”](#):

'It will be the coup de grace for bringing the fractious humanity finally together in one-world government **“if suddenly there was a threat to this world from some other species from another planet.”** As President Ronald Reagan had read out loud from his script at the United Nations podium in 1987: **“we often forget how much unites all the members of humanity. Perhaps we need some outside universal threat to make us recognize this common bond. I occasionally think how quickly our differences worldwide would vanish if we were facing an alien threat from outside this world”**. Coming soon to your local friendly skies, complete with the 'messiah' and the 'mahdi' descending from the heavens on the wings of dove, or the chariots of fire, in their final return to save the now united mankind against the common threats. Maybe there is something to this 'dajjal' story, the 'false messiah' lore after all! Brought to you courtesy of NASA's Universal Holographic Satellite Projection System.'

With the aforementioned rehash from my previous writings as the essential backdrop, let's turn back to the present. But before I do that, first, just some necessary words on why the rehash. One of the problems I continually face as an activist-writer is that the majority of ordinary peoples I encounter have very short term memories which, when not being outright selective, contain minimal context. This is evidently true even among the uber-learned who make much ado about their brilliant scholarship and great achievements of the 'American Dream' (see: [“The Ivy League Morons Syndrome”](#) and [“Why Not Be An Ostrich?”](#)).

While such collective public amnesia works nicely in favor of those *engineering consent* to get peoples across all walks of life and economic/social class to 'United We Stand' with the mantras du jour, it works terribly against those who instead dare to stand up to the *hectoring hegemons* by trying to inform the insolvent public mind of the vile Machiavellianess of statecraft. And therefore, I often have to restate things to continually recreate the overarching context before I can add the one new item I have uncovered to their already over-taxed consciousness in its full context. Otherwise, I find that most people simply refuse to evaluate only the new discovery in the full context on their own.

I am also constantly asked for proof – and my website has proofs in writings up the wazoo but no, I have to provide it each time afresh because clicking on a link is way too much

trouble for many. Oh sure, everyone wants to see copious references all right, nicely formatted, which evidently imparts the warm-fuzzy feeling of imposing “expert” scholarship at work, automatically increasing with the number of footnotes and endnotes. But strangely, I have noticed that most people don't actually bother reading them carefully except to note their presence, never mind analyzing their veracity and reasonableness for themselves by studying the cited material.

Therefore, when I am unlayering and unraveling the most absurd in Realityspeak, as is the case here, I make the effort to carry the context along – because this one essay is all anyone will ever read, if one ever bothers reading a plebeian that is.

### **The UFO-Alien Disclosure Project of Steven Greer**

Over the last few days I have been studying this Dr. Steven Greer fellow of the Aliens Disclosure Project, his UFO testimonies, his *Free Energy* mantras, his perpetual motion machine pitch and other bullshit to solve all the imaginary and manmade mantras du jour such as global warming (imaginary), global energy/food/water shortage and global poverty (manmade), etc. All mankind's intractable problems finally made soluble thanks to the miraculous but still vilely hidden technologies reverse engineered from aliens' crashed spacecrafts by the secretive black-projects of the *national security state!* If only they'd reveal it – and hence the raison d'être for Dr. Steven Greer's Disclosure/Orion Projects.

The Reality Behind Flying Saucers and UFOs -- The U.S. Air Force first began experimenting with flying saucers in the 1950s. See flying UFO models adapted from special purposes fighter-type planes in the images below. Of what conceivable use is a flying saucer (and its mantra) to the United States Government? To comprehend such asininity which on the surface makes no rational sense, one must first comprehend what was learned in the 1938 Hadley Cantril led study of mass panic behavior with the first radio broadcast of War of the Worlds! (See Hadley Cantril) Second, see Area 51 below. It is not beyond these people that artistic spy surveillance planes were flown as UFOs both for a mind-fck and for lending credence to psychological warfare mantra.

Before a couple of days ago, I had never heard of this brilliant fellow with such a phenomenal access to black-ops engineers who could so trivially reverse engineer an alien's (from another world) machine in the 1950s, and not only figure out how it works, but duplicate it with our existing rather primitive technological base and limited understanding of science (otherwise we'd have been visiting their planet instead of their coming here)!

Wow! I must have gone to the wrong school – should have joined *Skunkworks!*

I must have watched about 7-8 hours of these videos, including the 4 hours of Steven Greer's Disclosure DVD, and the hour long rather mind-blowing interview with this US Air Force techie, William Pawelec:

<http://www.youtube.com/watch?v=yytSNQ2ogD4>

That latter interview with William Pawelec is what got me interested in spending the other 6-7 hours studying what else Dr. Greer and company had to say about such matters. In the above interview, Pawelec discloses some fascinating black technology which existed in 1980s, such as a RFID chip with a transponding range of 120 km with just a two inch coiled antenna, and it could be read from satellites in earth orbit! Since I am a EE techie from MIT and thought I understood antenna theory rather well in my heyday, this fascinated me. It simultaneously sounds both gibberish, and also fascinating if true, that they had this kind of remote sensing and RFID tracking technology way back in 1980 (with some exaggerations attenuated of course)!

**From UFOs to Spy Planes - The Reality Revealed: How Area 51 Hid Secret Craft**

'No word yet on alien starships, but now that many Cold War-era Area 51 documents have been declassified, veterans of the secret U.S. base are revealing some of the clever—and surprisingly low-tech—ways they hid futuristic prototypes from prying eyes.

The CIA created Area 51 in 1955 to test and develop top secret U.S. military projects in the remote Nevada desert. More than 50 years later, the base still doesn't officially exist and appears on no public U.S. government maps.

In the 1950s and '60s, Area 51 was the epicenter of the OXCART project, intended to create the successor for the U-2 spy plane.' --- National Geographic, May 20, 2011

The one contradictory aspect to Pawelec's tales which immediately struck me is that if the black-magic science and technology of the super-secretive military-industrial complex have so leap-frogged the public domain science and technologies as Dr. Steven Greer would like us to believe, then, this 1980s RFID implantable microchip for instance, by Pawelec's own admission, was invented by some lowly civilian academic in a non-classified backoffice of a university which Pawelec had to go sell to the CIA and to the black-projects of the super-secretive military-industrial complex. These meetings, according to Pawelec, were attended by super-secret spooks from the highest echelons of spookishness in the country, including

the department of Agriculture and the Treasury, inquiring to know what its capabilities were!

How can both be true?

Are the spooks super-ahead in some secret sciences or aren't they? These implantable microchips the size of a grain, as Pawelec described it, were subsequently manufactured in the billions using the same civilian semiconductor process technology which fab-based companies in Silicon Valley at the time had. I used to work for one of them myself.

So, it is not immediately obvious what super-secret super-advanced know-how the black-projects have had over civilian public science and technologies that they could reverse-engineer, never mind re-construct, an alien spacecraft with all its attendant new technologies, when a lowly civilian academic from the public sector is called upon to teach them – except of course, in an Isaac Asimov sci-fi tale of Gaia's visitation by the godly seed bearers!

The first I ever heard of human-implantable RFID microchips was after Gillette teamed up with MIT to start an RFID project on MIT campus in either 1997 or 1998. Evidently, this fellow David Icke had heard of this even earlier, as evidenced from his own 1996 video *The Turning of the Tide*. Where had David Icke learned it from? Hollywood? Their movies do seem to be rather prescient (sic!) in anticipating vile technologies to run modern day dystopia, don't they? And so too, in successfully implanting enabling myths into public consciousness as already discussed.

In any case, I diligently went through hours of Disclosure Project videos, fascinated with the black-ops technology William Pawelec had talked about, as well as about the sacred structure of institutional secrecy in the military-industrial complex, “*compartmentalization within compartmentalization within compartmentalization*,” and how easy it was to maintain state-secrets for a very very long time if they really wanted to:

“The ability of our government to keep secrets (is actually) has a long history of being very valid. There is a lot of programs that were successfully kept quiet for decades, if not close to half a century. And during the last ten years we have seen a lot of announcements of programs that were kept very secret by our government.” (Time 0:40:45),

But nothing technical came up in the rest of the videos, except interesting, and on the surface rather credible sounding testimonies from a 100+ people about UFO sightings (of which only a couple dozen are on the 4 hour DVD video available on youtube). And I asked myself: how difficult is it to get a 100 former military types trained to obey orders, some

other civilian ATC persons and pilots, psychologically primed to tell a tale after selecting them through careful profiling for susceptibility/suggestibility, and appropriately dishing them some hegelian mind-fck on the ground and in the air, to eventually sing any tune of the Mighty Wurlitzer? If they can so spectacularly pull off 911 before billions of peoples, this could be a short piece of cake! (See The Mighty Wurlitzer by Zahir Ebrahim)

Simple psychological profiling before selecting appropriate stooges to do the dirty work of empire is an art as old as hegemony, as old as mankind. And I am not even speaking of mind control ala MK ULTRA.

Just flying the experimental aircraft from USAF like those whose images are shown, past any airliner cockpit to set the pilots up for UFO testimonies, should do the trick!

And if the pilots have been properly profiled, they would believe the evidence of their own eyes and would make the most sincere patsies passing even the most sophisticated lie detector tests with ease.

For instance, John Perkins disclosed in the opening pages his 2004 book, *Confessions of an Economic Hitman*, how he was psychologically profiled by the NSA in 1965 as he sought draft-deferment, to probe for his natural weaknesses and susceptibilities. Much later on he

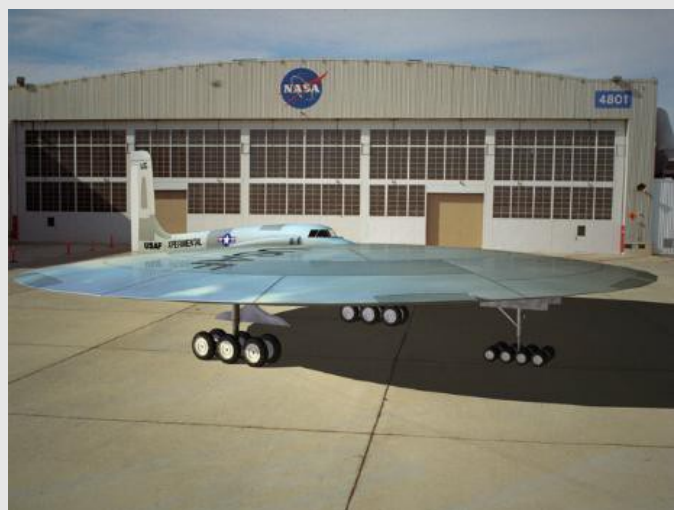

was recruited in 1971 by Chas. T. Main (MAIN) and successfully groomed by a beautiful woman, “Claudine”, to prepare him for his diabolical role: **“My assignment is to mold you into an economic hit man. No one can know about your involvement – not even your wife. Once you’re in, you’re in for life.”**

Perkins explained: **“Claudine’s role is a fascinating example of the manipulation that underlies the business I had entered. Beautiful and intelligent, she was highly effective; she understood my weaknesses and used them to her greatest advantage. Her job and the way she executed it exemplify the subtlety of the people behind this system.”**

Perkins further noted that during his recruitment to MAIN: **“When I mentioned that I had been accepted by the NSA before joining the Peace Corps, and that I was considering going back to them, he informed me that he sometimes acted as an NSA**

**liaison; he gave me a look that made me suspect that part of his assignment was to evaluate my capabilities. I now believe that he was updating my profile, and especially sizing up my abilities to survive in environments most North Americans would find hostile.”** (Ch. 1)

Military echelons and mission critical operations like Air Traffic Control, piloting an airliner, etc., absolutely must rely on psychological profiling for recruitment, advancement, special mission assignments, etc. as their standard HR practices. Even major corporations do



[Image Source](#)

psychological profiling. So what about very specialized recruitment for a calculated Hegelian mind-fck then?

In Dr. Steven Greer's May 2001 press conference at the National Press Club, he paraded about a dozen zealots asserting that they will swear their respective UFO mantras before the United States Congress – the same pusillanimous leaders who are behind the eager endorsement of all state mantras du jour from the *War on Terror* to *Global Warming*, never mind the trillions in *bankster bailouts* despite the public's aversion to it – and I am supposed to quiver in my boots singing *hallelujah, I see the UFO lights?*

I watched that entire dog and pony show, introduced by none other than a Hollywood actor to boot as if also mocking the public's lack of intelligence on purpose, and wondered what inherent value there is in swearing anything before the same almighty United States Congress by persons most likely selected and “groomed” for their respective roles minimally in the same mold as the Economic Hit Man (EHM)? Watch yourself:

<http://video.google.com/videoplay?docid=-1166743665260900218>

Okay, so I am not totally impressed by any of these testimonies of the PHM (Public Hit Man)... even though, some of them, like the following documentary linked to by Dr. Steven Greer from his website, is pretty darn fascinating. I don't really know what to fully make of it just yet. My first standard operating principle for parsing all statecraft is the statement attributed to the Head of CIA Counter Intelligence (1954-1974), James Jesus Angleton: **“Deception is a state of mind and the mind of the State”**. Watch yourself:

<http://disclosureproject.org/videogallery.shtml>

<http://video.google.com/videoplay?docid=8285709939745631584>

Why can't I see the damn UFOs when I go out at night for a walk? Or during the day hikes? Or when I am flying? I am sure I will see them too in *Room 101!*

The UFO card is as old as the Federal Reserve, and just like they can plan out things 50 years in advance to the founding of Israel on the clock, they sure can plan out any diabolical acts, stochastically, based on game theory scenarios in which there are not deterministic guarantees of outcome, but likely probabilities of outcome, years in advance for sure. Like Brzezinski had noted in his interview in 1998, the United States had increased the odds in its favor that the Soviet Union will intervene in Afghanistan due to the increased aid to the Mujahideens prior to their invasion in December 1979. Increasing the odds to turn them into one's own favor is a game which the hectoring hegemony evidently

have much real world experience of, as vouched by Brzezinski, when he subsequently unleashed the “*opportunity to give to the USSR its Vietnam War*”.)

**I think this is what's going on here – some very well-thought out, and very well executed, stochastically hedged, psychological mind-fck with these UFO sightings.**

If there are really UFOs, and I am really entirely agnostic on that issue of aliens serendipitously choosing to invade earth during my humble and tiny lifetime in the timescale of the cosmos, then my rational take on the UFO sightings and alien visitation in our epoch when the impetus towards World Government is already almost a fait accompli, is decided by the response to the following scientific proposition even if an alien landed tomorrow and asked me: **“Take me to your leader”**:

1) what's the probability that the aliens will just time their arrival to earth in the span of a few million years in just those last 100 years when world government is being constructed piecemeal, and for which, the alien invasion is already deemed to be the final trump card ;

2) the further conditional probability given item 1) above, that the damn alien UFOs will choose to boldly unveil themselves to the ordinary peoples the world over, finally visible to all and sundry without exception, solely with the naked eye and caught in 70 mm cinematic capture on the latest high resolution HD camcorders, as opposed to the present-day crappy Osama Bin Laden style grainy flying-saucer youtube renditions made by intelligence ops and visible only to the selected elite peoples ;

3) the further conditional probability given 1) and 2) above, that the UFOs will also choose to land on earth in people-visible ways and invade/make-friends with the poor earthlings also precisely at that epoch when all the preparations towards Global Governance are finally completed just awaiting for that last and final global threat to fck mankind into accepting world government? ;

4) the final conditional probability given all of the above, that this UFO alien threat is also accurately anticipated by the earthlings, especially a script-reading President of the United States, Ronald Reagan in 1987, when he made the following bizarre statement at the United Nations podium: **“we often forget how much unites all the members of humanity. Perhaps we need some outside universal threat to make us recognize this**



***common bond. I occasionally think how quickly our differences worldwide would vanish if we were facing an alien threat from outside this world".*** Watch: <http://vimeo.com/4871185>

If that final number for the cumulative probability of the UFOs and aliens arriving just in time to usher in one-world Government, with the globalists exactly anticipating and waiting for their arrival, is a reasonable number, like something between 0.1 and something less than 1, okay, I'll buy the UFO sightings as possibly real and unrelated.

However, if that probability number is minuscule, which I believe it to be, something of the order of ten to the power minus 6 and smaller, then the probability of actually seeing Aliens majestically alighting from the UFOs, just like in Orson Well's depiction of H. G. Wells' sci-fi novel *War of the Worlds* in 1938, might as well be 1 – BECAUSE, it is a stage-managed event all right! It will look like the blue-team/red-team war-exercise scenario with live ammunition – but in full public view this time!

Returning from that digression back to pertinently listing my final study video of Dr. Steven Greer, I watched the following last one hour of interview with Project Camelot. It has now capped my weekend study and I really only learned one thing of significance in all this, and that is to ask that one surprising new principal question which came out of this entire study:

**Is Dr. Steven Greer of the Disclosure Project also a Mossad-Intelligence Agent?**

<http://www.youtube.com/watch?v=hzqDVOjtNhg>

In all of those hours video watching, I noted several errors made by Dr. Steven Greer, which I kept attributing to the medical doctor not being a scientist, and thus just making the blunders of any innocent domain-ignorant chap who is being bamboozled and is reading from a script. On the face of it, Dr. Greer seemed to believe in what he was doing, rather like a passionate jihadi, i.e., patsy or stooge, who believed he would be in heaven shortly, and parroting back on screen what he had learned. Steven Greer evidently didn't (and doesn't still) understand what gibberish he is uttering, as he is fancifully throwing about new jargonized vocabulary to impress his largely scientifically illiterate public audience.

For instance, in the following video on his own website, the Orion Project, whose stated agenda is to harvest the alien technology to solve the world's energy and mankind's many problems, Dr. Steven Greer utters the following rubbish on camera (at minute 3:48):

[http://www.theorionproject.org/en/video\\_scientists.html](http://www.theorionproject.org/en/video_scientists.html)

[http://www.youtube.com/watch?v=nChbyC\\_4JKI](http://www.youtube.com/watch?v=nChbyC_4JKI)

*“Unfortunately, **you can’t really go to MIT or CALTECH and learn these types of sciences.** They have just simply not been allowed into the mainstream public domain. But there are people for a hundred years, dating back to Tesla, who have come up with magnetic motors that tap into what’s called the Zero Point Field of Energy, or this Electromagnetic Flux Field that becomes self-running and Over-Unity. Meaning they put out more energy than you have to put in to them. I want to comment here a lot of people will say well that’s not possible. Well, it is. A heat pump is around 4 times over unity. **A heat pump that is run in your house, electrical heating-cooling system, is actually about four times more energy that it does in work than you actually have to put in in electricity.** Except it goes in either heating or cooling. And so there are many ways that happens. And people take it for granted because it is so common. What we want to do is take these concepts and turn them into electric generating power plants. So that they begin to replace the conventional fossil fuel plants. Not only for homes and business, but also eventually for industry and automobiles and cars and trucks.”*

All I can humbly suggest in response to this gibberish, being only an MIT alum and thus a tad biased I am sure: remember the “flux-capacitor” which enabled time travel from the 1980s Hollywood movie *Back to the Future*? Dr. Steven Greer seems to be reading from perhaps the redacted portions of that very film script which did not make it into the movie! Just like President Ronald Reagan had read off from his own 1980s script at the UN podium.

To even top all that, Dr. Greer says he has three million dollars for inventors and scientists to come around and experiment with magic science which is not taught at MIT and CALTECH!

Which capitalist investor would give Dr. Steven Greer that kind of money for such lunacy – except compartmentalized black-ops with infinitely deep pockets for their own covert agenda?

So, up to this time, I am still thinking that this wonderful humanitarian Dr. Steven Greer, who gave up his supposedly lucrative medical career to pursue these idealistic goals to save humanity from itself, is just a passionate patsy being taken for a ride on the horns of scientifically sounding gibberish by the intelligence agencies.

The economists do that a lot you know, utter high-falutin gibberish to take even the financial experts for a ride on the horns of economic gibberish – and most of them also have fancy professional degrees and Nobel prizes (see: “[The Monetary Conspiracy for World Government](#)”). So why not here? It can happen to the best of us when we are blinded by our passions – we tend to act like lunatics when viewed by others... and Greer's website is full of inspirational quotes illustrating how one man's madness is another's genius, in perhaps just such an anticipation of skepticism...

But I changed my mind in a hurry after watching the Project Camelot interview noted above. I caught Steven Greer in an outright propaganda lie, presenting Iran as a mortal threat to Israel driven by the insane madness of their eschatological tryst with Armageddon (time 0:13:50):

*“it's like Ahmadinijad in Iran saying, that it would be okay if we went to nuclear war with Israel, because it would force this 12th imam, which is their return of their Christ, to return, to Iran”*

And Project Camelot's Kerry Cassidy is heard in the backdrop saying: “sure”.

**The fabrication is no silly inadvertence, no mere error of ignorance of an innocent well-intentioned patsy, but an outright lie from an expert Zionist spokesperson. The lie is seconded by Project Camelot, rather than immediately challenged!**

It automatically prompted me to search for Dr. Steven Greer's name with “Jewish” etc. tacked on in Google search, which brought me to two articles about him from 2007, and 2006:

<http://educate-yourself.org/lte/stevengreertake627jul07.shtml>

<http://educate-yourself.org/lte/stevengreerinqury31dec06.shtml>

The reader may note that my deconstruction of Dr. Steven Greer's hegelian mind-game is downright similar to what's in those two articles. Evidently, that author too approached this subject purely from a rational political science and social engineering perspective, and consequently arrived at the same conclusion that this was a major psy-op!

The new aspect discovered here, at least for me, is the aforementioned evidence which lends strong suspicion that Dr. Steven Greer cannot be just an ordinary patsy or a moron merely being used by intelligence, but a Mossad-Intelligence agent knowingly performing his assigned role of priming the public!

What reinforces my suspicion of a strong Mossad-intelligence connection in Project Disclosure is that Steven Greer evidently has the kind of open access to the highest corridors of power, to spooks, and to supposed black technology, which only a well-connected “untouchable” intelligence agent on a mission from high-above can have. But, if Greer's first loyalties were to American intelligence, his gratuitous mantra on Iran would surely not have mirrored the Zionists' demonization of Iran, playing Israel out to be the poor little underdog being threatened by an impoverished, irrational third world country hell bent on wiping it off the map! I imagine, only speculatively of course, that an American intelligence agent would have no obvious motive to gratuitously bring Iran up to make Israel look good. I imagine if he were as patriotic and nationalistic as Dr. Steven Greer presents himself to be, speaking of Congressional oversights and Constitutionalism etceteras, that he'd actually try and make America look good instead of Israel!

A sophisticated man like Dr. Steven Greer, understanding intelligence matters and the hijacking of the *Republican state* for the benefit the *national security state* by black-ops and covert power, believing in the far-out notions of UFOs, aliens and alien technologies, the most avantgarde in liberated thought, demonstrates an unusually keen intellect and open mind. But simultaneously, also echoing the absurd mantras of empire and the propagandistic reference to Iran, demonstrates a perversely indoctrinated one. And that is a non-sequitur. Dr. Steven Greer shows the perversity which is typical of manufactured and controlled products of intelligence agencies and the Mighty Wurlitzer. The same reasoning may apply to Kerry Cassidy and Bill Ryan!

And, if, as I suspect, Dr. Steven Greer is a willing intelligence agent on a mission, then what can be expected of the sister endeavors named Project Camelot and Project Avalon, run ostensibly by two well-intentioned patsies? Are they merely only being fooled into pitching the same mantras as Steven Greer, and so “*innocent of knowledge*” that they are only naively following in Project Disclosure's own footsteps of interviewing more Mighty Wurlitzer's harmonics to manufacture consent for the real diabolical agenda behind all this, the eventual unveiling of the aliens and UFOs and ushering in the global reign of “secular humanism”? See: “[Between Islam and Secular Humanism in World Government](#)”. I had earlier even written a letter of caution to Kerry Cassidy at Project Camelot, copying Bill Ryan of Project Avalon, on her inexplicable enthusiastic endorsement of Wikileaks a few months ago. But now I wonder....

It is foolish to think that lauded pundits and prominent leaders of dissenting causes are always whom they claim to be, as is amply demonstrated once again in my two most recent discoveries before Dr. Steven Greer this past weekend, prominent banking reform advocate [Ellen Brown J.D.](#), and prominent former Jewish Zionist now turned Christian

pacifist Israel Shamir. Which is why it is always good commonsense to study critically, always keeping in mind the first principle of modern statecraft already noted earlier and restating for emphasis:

***“Deception is a state of mind and the mind of the State”***

Anyway, who knows precisely what exact contortions, twists and turns all the plots and sub-plots of this UFO-Alien unveiling will entail until it's all actually played out on the world's stage at zero hour. It surely needs both its circus clowns to keep the audience warm until then, and several layers of side-shows planned into existence.

Just looking forensically at 9/11 we already see so many sub-layers to the main *New Pearl Harbor* plot for launching “*imperial mobilization*”. From simultaneous four airliners hijacking and ramming into tall buildings by pilots who only learned to fly on flight simulators and advertised the fact that they didn't want to learn how to land ; to fantastically timed controlled demolition of the same tall buildings collapsing them into their own footprints at almost free-fall speeds ; to the inexplicable attack on the Pentagon on the only side which was unoccupied undergoing renovations and creating a hole no bigger than a missile-entry ; to raking in billions in airline stocks shorting ; to insurance scamming for the demolished WTC properties ; and the list goes on!

We can already observe the Hegelian mind-fck of ***good alien vs bad alien, will they come or won't they come, let's prepare just in case***, appearing frequently in the mainstream press – keeping the notion of extraterrestrials primed in public consciousness, with no small help from assets like Greer, Cassidy, Ryan et. al. This is quite different from real astronomy programs like SETI – but even real science can quickly be put in the service of empire just as easily as junk science already is!

Fabricating a public discourse on an absurd fantasy as if it's something real by couching it in the veneer of science (or declassified State-Secrets/whistleblowing/leaks), and then self-servingly reacting to that fabrication as a threat to national security at supra-national levels from the United Nations to the Catholic Church to justify and dignify the expenditure chasing the new immanent threat, only legitimizes such discourse among the public as plausible. It fertilizes the stage for the subsequent creation of a new insurmountable global threat, **the Clash of Planets**. If political scientists are to be believed on the utility of diabolical protocols for “*imperial mobilization*”, then, ***“that exercise requires a high degree of doctrinal motivation, intellectual commitment, and patriotic gratification.”*** Its doctrinal seeds must be planted years in advance. This new shock-therapy threat too will also of course be launched with the dialectical ultimatum: ***“either you are with us, or***

*with the aliens”!*

## Seeding the 'Clash of Planets' and the 'War of the Worlds' to cement one-World Government



Caption Aliens can't hear us, says astronomer Fainter broadcasting signals and digital switchover mean Earth will soon be undetectable to extraterrestrials **Aliens are less likely to be able to pick up signals from Earth and make contact.** (Image via UK Guardian, Photograph: Colin Anderson/Getty)



Caption Earth must prepare for close encounter with aliens, say scientists **UN should co-ordinate plans for dealing with extraterrestrials – and we can't guarantee that aliens will be friendly** Evolution on alien worlds is likely to be Darwinian, which may mean extraterrestrials share our tendencies for violence and exploitation. (Image via UK Guardian Photograph: Rex)

Caption 'World governments should prepare a co-ordinated action

plan in case Earth is contacted by aliens, according to scientists. They argue that a branch of the UN must be given responsibility for "supra-Earth affairs" and formulate a plan for how to deal with extraterrestrials, should they appear.' --- UK Guardian 10 Jan 2011

A simple word substitution in the caption above, replacing "aliens" with "pandemic", shows what has already been achieved with that recent manufactured crisis. World governments have already been coerced into ceding their national sovereignty in the name of coordinating global medical emergency response to the World Health Organization, a governing body of the United Nations. See my comprehensive running report "The Swine Flu Chronicles 2009: Why to say 'No' to the Swine Flu Vaccine". I had unraveled that pandemic hoax almost in realtime with considerable due diligence on my part, and with help in no small measure from the courageous community of dedicated activists from around the world. A Council on Foreign Relations participant at the Pandemic Influenza public conference held on October 16, 2009 by the CFR in New York, had adorned the handful of people like myself the label "**Crazy people**".

It was only the first of many labels to come, as it was soon followed by 'denier', explicitly attributed to me by manufactured dissent-chief Israel Shamir, on my similar unraveling of Wikileaks. This is what had elicited so much laughter from the CFR folks on October 16, 2009:

"I think we are all aware that the anti-vaccine movement is having a field day on the internet and on media outlets like Fox News and so on, and causing reductions in vaccine uptake. And it appears a pretty unholy alliance of the ultra-right and the ultra-left working together as the sort of **Hitler-Stalin pact** (laughter), and I am not sure that we are countering these people very well ... and you have to take these people on in a different style than the scientists are used to. ... **Crazy people who think the vaccine will kill you!** ... How best we can to stop the anti-vaccine movement?"

But less than six months later, on March 12, 2010, DER SPIEGEL staff wrote in "Reconstruction of a Mass Hysteria – The Swine Flu Panic of 2009":

"Swine flu kept the world in suspense for almost a year. A massive vaccination campaign was mounted to put a stop to the anticipated pandemic. But, as it turned out, it was a relatively harmless strain of the flu virus. How, and why, did the world overreact? A reconstruction. By SPIEGEL staff."

I immediately responded to SPIEGEL's specious "reconstruction" in my succinct deconstruction the very next day, on March 13, 2010, in "[The Swine Flu Postscript: 'Reconstruction of a Mass Hysteria – The Swine Flu Panic of 2009'](#)". Below is the full text of my unraveling of even that limited mea culpa – which was spoken through the mouth of an establishment rag and subsequently echoed throughout the world – because the contextless public has too short term a memory for my meager writings to be effective without my continually reminding them of what has just recently gone by.

### **Begin Full Text "The Swine Flu Postscript"**

The perfect example of another '[modified limited Hangout](#)': ***"No one at the WHO, RKI or PEI should feel proud of themselves. These organizations have gambled away precious confidence. When the next pandemic arrives, who will believe their assessments?"***, DER SPIEGEL staff concluded after their exhaustive study which appeared in their March 12, 2010 issue. *'Indeed'*, voiced Zahir Ebrahim of Project Humanbeingsfirst.org, the *plebeian antidote to hectoring hegmons*, and he was overheard by the ***"[anti-vaccine movement] Crazy people who think the vaccine will kill you"*** while administering that one word coup de grâce to the Council on Foreign Relations and its financiers for their incestuous disinfo session on [Pandemic Influenza](#) held on October 16, 2009 in New York.

To understand the prescience with which the coup de grâce was so swiftly administered by ***"Crazy people"*** in realtime rather than DER SPIEGEL's belated catchup analysis of [Hysteria vs. Reality](#) in its 'limited hangout' variation, please see: [The Swine Flu Chronicles 2009: Why to say 'No' to the Swine Flu Vaccine](#).

To acutely comprehend the vagaries of 'limited hangout' as an essential political science instrument of Machiavellian statecraft when massive covert-ops go awry, please see: [Anatomy of Conspiracy Theory](#).

The United States and the EU Governments, as the front errand boys of the oligarchs, are guilty of a monumental conspiracy against the people of the world.

Twice now their fabricated crises have unarguably come unraveled before the public's eyes – global warming, and global epidemic – each time leaving behind the legacy of hurriedly enacted laws which piece-meal move the



world closer to ***“an end run around national sovereignty, eroding it piece by piece.”***

The Catastrophic Terrorism of 911 which has been perched at the cusp of controlled demolition since D-Day – and the body of draconian laws and military invasions stemming from it which have already seeded the first truly global police state in the history of mankind since the ***“World government could only be kept in being by force”*** – is finally also making its way into the Beltway's own MSM.

The next manufactured global crises or Catastrophic Terrorisms to be inflicted upon mankind, after food and water shortages, may well be alien landings, and/or interplanetary collision, in conjunction with the already planned nuclear world war with Iran and Russia in the midst of an orchestrated currency collapse, so as not to lose any of the rapid momentum to the unified one-world order. 2009 was its first year of formal public unveiling, termed Global Governance:

<http://www.youtube.com/watch?v=QEqFtVrAgSo>

And yet, none still dare call it conspiracy!

#### **END Full Text “The Swine Flu Postscript”**

Does one, by now, trivially recognize that CFR modus operandi of creating ***“an end run around national sovereignty, eroding it piece by piece”***? Simply reflecting on this modus operandi outlined by the Council on Foreign Relations in their 1974 blueprint ***“The Hard Road To World Order”*** as already quoted at the beginning of this article, makes what otherwise appears as a great **‘booming, buzzing confusion’**, entirely transparent. Briefly re-quoting that CFR statement once again in its original context for the strong emphasis that it deserves:

**“In short, the ‘house of world order’ will have to be built from the bottom up, rather than from the top down. It will look like a great ‘booming, buzzing confusion’ to use William James’ famous description of reality, but an end run around national sovereignty, eroding it piece by piece will accomplish much more than the old-fashioned frontal assault.**

**Of course, for political as well as administrative reasons, some of these specialized arrangements should be brought into an appropriate relationship with the central institutions of the U.N. system, but the main thing is that the essential functions be performed.”**

So, returning back to the topic at hand. The new fabrication of the *Clash of the Planets* with the alien boogeyman this time, is also all too similar to how “*Islamic Terrorism*” was seeded and continually kept alive in public consciousness ever since the fall of the great Berlin Wall, until its day of harvesting on September 11, 2001. That boogeyman had got kick-started immediately after the calculated demise of the previous boogeyman du jour, the USSR. “*Islamic Terrorism*” made the sudden appearance in 1990 in the Council on Foreign Relations famous Foreign Affairs magazine, with this precious gem dripping from the aging but not too old to screw, Zionist-imperialist Svengali of Princeton University, Bernard Lewis:

“In 1990 Bernard Lewis, a leading Western scholar of Islam, analyzed ‘The Roots of Muslim Rage,’ and concluded: ‘It should now be clear that we are facing a mood and a movement far transcending the level of issues and policies and the governments that pursue them. This is no less than a clash of civilizations – that perhaps irrational but surely historic reaction of an ancient rival against our Judeo-Christian heritage, our secular present, and the worldwide expansion of both. It is crucially important that we on our side should not be provoked into an equally historic but also equally irrational reaction against our rival.’” (Samuel Huntington in *The Clash of Civilizations and the Remaking of World Order*, page 213)

That supposed “Muslim Rage” of 1990 was subsequently turned into the *Clash of Civilizations* by Bernard Lewis’ Zionist-imperialist confrere at Harvard University, Samuel Huntington, in 1995:

“The underlying problem for the West is not Islamic fundamentalism. It is Islam, a different civilization whose people are convinced of the superiority of their culture and are obsessed with the inferiority of their power. The problem for Islam is not the CIA or the US Department of Defense. It is the West, a different civilization whose people are convinced of the universality of their culture and believe that their superior, if declining, power imposes on them the obligation to extend that culture throughout the world. These are the basic ingredient that fuel conflict between Islam and the West.” (Ibid. page 217)

And Samuel Huntington's myth construction of 1995 was turned into the perpetual "War on Terrorism" on September 11, 2001 by the Zionist-imperialists' errand boy, George W. Bush Jr., the President of the United States, with ***"either you are with us, or with the terrorists"!***

Today, we are merely looking at the next brilliant escalating enemy, the aliens, in a new epic **'Clash of Planets'!** The ultimate in good vs. evil dialecticism to mobilize both human fear and imagination for finally cementing one-world government in a threateningly apocalyptic War of the Worlds!

This new threat to all the world's civilizations and to life on earth itself, will surely also be launched with ***"either you are with us, or with the aliens"!***

This Alien-UFO business no longer appears so innocent – and merely the pursuit of foolhardy peoples exhibiting an hyperactive imagination in overdrive – when examined from the acumen of Machiavellian social engineering, now does it?

## **Conclusion**

As the catastrophic event of 9/11 unarguably testifies, and as both Zbigniew Brzezinski and Adolf Hitler had respectively observed in their *Mein Kampf*, in order for existential mantras to be believed by the general public requires not only *"a high degree of doctrinal motivation, intellectual commitment, and patriotic gratification"*, but also real terrorism, real controlled demolition, real loss of life, before the threat can be productively harvested for *"imperial mobilization"* to *"goosestep the Herrenvolk across International frontiers"!* This time, to finally cement the long held dream of ruling oligarchies from time immemorial: World Government.

In summation, oh good peoples, prove the darn statistics wrong, that only 2% of any public actually thinks. I dearly suspect that all among human beings have been endowed with at least some brains, some commonsense, some mind that is capable of reflection, despite Bertrand Russell's empirical observation that ***"Most people would rather die than think; in fact, they do so"***. Why does that self-serving bullshit of the elite have to be true, continually enabling the extraction of voluntary servitude from the public? Make it false! We don't need the Aliens to unite mankind or to solve any of our problems. Only a little bit of commonsense, and the courage to exercise it in taking on the common hectoring enemy of all mankind right here on earth, will certainly do.

Thank you for thinking for yourself.

## **Endnotes**

**Part-I:** [Wikileaks and the UFO: Response to Gordon Duff](#)

**Part-II:** [The Agenda Behind Aliens and UFOs - A Hegelian Mind-Fck Part-II](#)

**Part-III:** [Project Humanbeingsfirst Responds: Aliens and UFOs – Head in the Ass!](#)

**Part-IV:** [What's next after Osama Bin Laden?](#)

**Part-V:** [Project Humanbeingsfirst's Prediction: Alien Invasion - The Next Global Threat](#)

**Part-VI:** [Letter to Kerry Cassidy on the Alien-UFO Agenda](#)

**Short URL:** <http://tinyurl.com/Alien-UFO-Agenda>

**Source URL:** <http://print-humanbeingsfirst.blogspot.com/2011/01/aliens-and-ufos-hegelian-mind-fck-pt2.html>

First Published January 25, 2011

## **Chapter 20 Not Fooled Again: War on Terror Against Insurgents**

### **Insurgency vs. Counter-Insurgency: The Decapitation of Pakistan by its own Military Disguised as Counter-Insurgency**

**[Dateline California, October 26, 2010]** The BBC News reported on October 06, 2010 that 'Nato contractors 'attacking own vehicles' in Pakistan'. It stated in its carefully worded "limited hangout":

'Nato supply convoys travelling through Pakistan to Afghanistan have regularly come under attack in the past, but following Pakistan's decision to block their route through the Khyber Pass, they now face an even bigger security threat. Hundreds of tankers and trucks have been left stranded on highways and depots across Pakistan, with little or no security. Taliban militants have regularly been targeting the convoys, even when they are heavily protected. But many believe it is not just the militants who pose a security threat to the convoys. The owners of oil tankers being used to supply fuel to Nato in Afghanistan say some of the attacks on their convoys are suspicious. They say there is evidence to suggest that bombs have been planted in many of vehicles by the "Nato contractors" – individuals or companies who have been contracted by Nato to supply fuel and goods to forces in Afghanistan.'

With allegation-phrases like "many believe", "they say", without lending any forensic or critical factual analysis as to why 'Nato contractors' who work directly for the Pentagon and NATO, might be doing such a thing, the belated disclosure feeds rumors that are already ripe among the 'untermensch' victims that there is something terribly wrong with this 'War on Terror' whose principal victims since its inception continue to be innocent civilians. Why would the occupation forces want to increase the discontent of the already beleaguered people by such rumor-mongering reportage, and by the systematic controlled leaks that we see cropping up now and then which convey, from its own official records, American barbarianism upon Muslim civilians? Or more aptly framed in Michael Hayden's vernacular, what is the purpose of this "tickling" reportage?

Our newsmedia, both mainstream print and television, and almost all of alternate media largely playing controlled dissent worldwide, are unwilling to inform the public of the military significance of “insurgency” and “counter-insurgency”. The simpleton mind of the public, these lords of public relations must feel in sympathy with the Report from Iron Mountain, remains *“unexposed to the exigencies of higher political or military responsibility”* and cannot therefore appreciate the value of the *“considerable political sophistication”* that goes into the deep calculus of hegemony as *“democracy is inimical to imperial mobilization.”*

Poorly read of history as the commoners of course are, including the most educated ones among them with 'scholar' stamped upon their forehead, and weaned on the immediate gratification of the here and the now by having pursued their 'American Dreams' in deep slumber all of their lives, the plebes obviously naturally fail to recognize the distemper of hegemony when it is inchoate and kept brewing under covers.

They cannot believe that *“Peace and its duration, like war, is determined by natural laws that in their fundamental principles do not vary nor are found wanting”*. And when this law of hegemony is steamrolled into practice in the form of the lifetime of 'War on Terror', the only thing visible to the public is the death and mayhem with the respected narrators keeping score. But not the military precision with which red-teaming/blue-teaming insurgency and counter-insurgency are employed to perpetually engage the world in the controlled chaos of World War IV.

The factual political science reason for engaging in such permanent warfare was serendipitously discovered in the 1908-09 minute books of the Carnegie Endowment for Peace in 1953-54 by the indefatigable Congressional Investigator Norman Dodd, for the Reece Committee investigating the suspected subversion by tax-exempt foundations. Norman Dodd rehearsed from memory the occurrence of the following question from the minute books:

*“We are now at the year 1908, which was the year that the Carnegie Foundation began operations. In that year, the trustees, meeting for the first time, raised a specific question, which they discussed throughout the balance of the year in a very learned fashion. The question is: “Is there any means known more effective than war, assuming you wish to alter the life of an entire people?” And they conclude that no more effective means than war to that end is known to humanity. So then, in 1909, they raised the second question and discussed it, namely: “How do we involve the United States in a war?””*

That same principal reason guides the presence of American soldiers all across the “Global zone of percolating violence”, as Zbigniew Brzezinski characterized these locations in 1996, where we now find Western troops engaging in the 'War on Terror'.

So why should NATO set fire to their own convoys and blame it on the insurgents? Insurgency vs. Counter-Insurgency was forensically examined in my article last year “The Decapitation of Pakistan by its own Military!” and is reproduced below in its entirety. The reader is invited to spend some time reviewing *Operation Gladio* cited in its footnote. For convenience, watch Operation Gladio part1 part2 part3.

---

---

### **VALIDATION UPDATE July 21, 2011: 'US aid may be flowing to Afghan insurgents'**

Zahir's note: The United States government is itself admitting that American funds are being funneled to the insurgents, once the disingenuousness of doublespeak statements like these are peeled away. Also see John Perkins on how corruption is manufactured among the beggar nations by the donor agencies, slyly aided and abetted, and encouraged by deliberately turning a blind eye knowing full well where the funds are going. The process of covertly as well as overtly inducing corruption to co-opt, and then claiming there is corruption during mechanical “audits”, is an art well known to those who understand imperial statecraft and its multifaceted notions of cover stories and “plausible deniability” (see Anatomy of Conspiracy Theory for the presidential directive NSC 10/2 if unfamiliar with the concept of “plausible deniability”):

'... "US agencies have taken steps to strengthen their oversight of US funds, but the United States still has limited visibility over how these funds flow through the Afghan economy, leaving these funds vulnerable to fraud or diversion to insurgents," said the audit.

The findings come amid growing frustration in Washington over the corruption-plagued Afghan government and steadily declining public support for the nearly 10-year-old war.

The audit reviewed oversight of US aid converted to cash, including electronic payments to contractors, and assessed American efforts to bolster

the Kabul government's regulation of commercial banks and informal hawala financial networks.

The report said that "given the amount of US cash that flows through the Afghan economy, it is imperative that the US government have robust measures in place to ensure that these funds are not used for fraud or diverted to insurgent networks.

"However, we found that agencies have not instituted sufficient controls over US funds," it said. ... Since 2002, the United States has spent more than \$70 billion on security and development assistance in Afghanistan.'

---

---

**VALIDATION UPDATE March 25, 2011: '331 US officials may leave Pak under secret deal over Davis'**

Zahir's note: The government of Pakistan is even admitting that insurgency is fabricated (see Letter: Understanding the 'arc of crisis' with minimal work By Zahir Ebrahim which records my own defeat: ***"Just don't ask me how to get rid of our fifth columnists – that's where I stand defeated."***)

'Islamabad: A total of 331 US officials in Pakistan, most of them suspected of engaging in espionage under diplomatic cover, have been *"identified to leave the country"* under a secret deal between the two sides for release of American national Raymond Davis, a media report said on Thursday. ... An official said that most of the suspected US officials were *"involved in suspicious activities, including photographing and filming of sensitive installations like airbases (Warsak, near Peshawar and Multan), defence bunkers along the Pakistan-India border near Lahore, recruiting persons supporting their activities and launching local people for suspicious activities by offering lucrative benefits"*.'



## The Decapitation of Pakistan by its own Military

[PHBF Report Dateline Sept. 28 to Nov. 02, 2009, California] Let me begin this very difficult exposition as a Pakistani citizen (my only citizenship, by choice, despite being a legal permanent resident in the United States for almost three decades [1]) with the question *Who really killed Benazir Bhutto?* I mean who are the prime-movers?

The trigger-pullers are obviously irrelevant and remain faceless. They will surely never be known.

Well, let's read it in Benazir Bhutto's own lucid words which have now been augmented, almost two years later, with the Pakistan's Army Chief of Staff's belated disclosures of September 21, 2009. [2] Why belated? Well, please see these unpublished letters to many Pakistani newspaper editors on their repeatedly perpetuating the fiction of *Who Killed Benazir Bhutto* in cahoots with the 'hectoring hegemonies' and their agents! All traitors and co-opted errand boys. [3]

The American agenda for Pakistan is not a state-secret. Rather, it is only thinly disguised as perpetually fighting the "insurgents" in a lifetime of war, the World War IV. [4] Whereas, in reality, both the "insurgency", and the "counter-insurgency", are entirely designed and fabricated in the USA as part of the evolving tactics of Hegelian Dialectics. They are enacted on the ground by various two-bit errand boys and expert trigger pullers. The already well-known existence of black-ops assassination squads in Pakistan/Afghanistan, known to the local peoples for years as the real prime-movers behind the heinous local terrorist acts, belatedly confirmed by NYT, WP, and NYT, in August 2009. [5] See these two December 2008 reports on the Mumbai terrorist Act as reportedly orchestrated by **ALI BABA** from his perch in the Hindu Kush. [6] The arrival of the black-ops in the region is not recent, albeit the public disclosures might be.

Starting in the immediate aftermath of 911, and perhaps even earlier, Pakistan may well have become the largest deployment region for the CIA in modern times, both covert (unknown to Pakistani government and secretly working to destabilize Pakistan with false-flag operations), and overt (with Pakistani military's aiding and abetting, in full view of the world, ostensibly fighting the "insurgents", "Bin Laden", "Al-Qaaeda", but in the process mainly "tickling" its own innocent civilians in many a barbaric way). [7]

And since Jundallah got launched to destabilize Iran from Pakistani soil (their

“insurgencies”), Baluchistan along with the Pak-Afghan regions have been awash with black-ops, and obviously of course, also with officially recognized US soldiers manning American military bases on Pakistani soil. [8] But these soldiers of freedom were rarely spotted in the streets of major cities before. The following video report of September 08, 2009, therefore portends of ominous whirlwinds imminently engulfing Pakistan: [9]



To put this ominous presence of soldiers of freedom and fortune on Pakistani soil in full black-ops context of NATO and the Western Alliance, of diabolically manufacturing and sustaining the very pretexts *out of uniform* to enable the *in-uniform forces* to continue on with their perpetual mission of fighting World War IV, it is sufficient to look at what is transpiring in IRAQ for lessons to wisely apply to one's own predicament in order to avoid a far worse one.

Fast forwarding past all the initial pretenses of Sadaam Husain being responsible for 911, his WMDs about to destroy America, the Mission Accomplished statement of President Bush, and the “oops! intelligence failure” statements by the neo-con's own Iraq Study Group after the raping of Mesopotamia and the DNA of its ancient and proud peoples were fait accompli, etceteras, the biggest reason for not withdrawing the US troops from Iraq is continually stated to be the infernal ongoing **INSURGENCY**. Iran, Shias, Sunnis, and Al-Qaeeda are variously blamed for the main cause of America's continued military occupation of Iraq; new “troop-surges” are periodically announced amidst some dissenting consternation willy-nilly expressed in its news media and by its politicians to let the American public know that it is not an easy choice to be making. The Iranian strawman has already been amply unraveled elsewhere. [10] However, witness the following familiar statement of former President George W. Bush on the legend of the new Ali Baba [11] of Mesopotamia, Abu Musab Al-Zarqawi: [12]

*“You know, I hate to predict violence, but I just understand the nature of the killers. This guy, Zarqawi, an al Qaeda associate -- who was in Baghdad, by the way, prior to the removal of Saddam Hussein -- is still at large in Iraq. And as you might remember, part of his operational plan was to sow violence and discord amongst the various groups in Iraq by cold-blooded killing. And we need to help find Zarqawi so that the people of Iraq can have*

*a more bright -- bright future.*" -- George W. Bush, Press Conference, 1 June 2004

The indefatigable Michel Chossudovsky, citing Bush's afore-quoted statements wrote: *"Zarqawi constitutes Washington's justification for the continued military occupation of Iraq, not to mention the brutal siege of densely populated urban areas directed against 'Al Qaeda in Iraq' which is said to be led by Zarqawi."* [13]

It is now November 02, 2009 – and the United States is still very much in Iraq. Its own economy is in deep recession, and the free-money printing by the Feds is taking it towards hyperinflation. The world is not only mired in its worst global financial crisis that is seeing the end of Western hegemony in its industrial production capabilities, but is also plagued by a global pandemic, global warming, and an un-ending global war on terror, sinking valuable trillions of dollars which could otherwise have been spent on converting overnight the entire world's six billion population into America's middle class status of the 1960s, while also wiping out much of the developing nations' unbearable debt. That alone would most assuredly have earned the United States the genuine love of the entire world instead of the present shoes thrown at its all powerful president. How remarkably has the world's sole superpower been brought down so pathetically to its knees by the Ali Baba of Iraq that today it cannot even extricate itself from giving a diabolical police-state to its own peoples in the pretext of saving them from the global terrorist! What sort of idiotic "American Primacy and Its Geostrategic Imperatives" agenda, and what kind of asinine quest for "Full Spectrum Dominance" is this? [14] Wow Ali Baba, what magical powers you have of not only so successfully entangling the United States in the Iraqi "quagmire" indefinitely, but of being the prime-mover behind the demise of nation-states to usher in the only permissible solution out of these multifaceted global threats – world government! [15]

Focussing on the pertinence at hand however, what does the Ali Baba of Iraq have to do with the following shocking news reports purveyed in titles which are illustrative enough of the key point: **"Were British Special Forces Soldiers Planting Bombs in Basra?"** September 25, 2005 ; **British "Undercover Soldiers" Caught driving Booby Trapped Car "They refused to say what their mission was."** September 20, 2005. [16]

Michel Chossudovsky, writing the latter article and displaying his un co-opted integrity, asked the 64-million dollar obvious questions – the same modus operandi being replayed in Pakistan with even more drastic effect, as now the black-ops have been hardened in Iraq on how not to get caught when plenty of patsies can be trivially harvested for the job of "legitimizing Insurgency" [17] – which none appear to be publicly asking in Pakistan:

## Excerpt

'The following Reuters report raises some disturbing questions.

Why were undercover British “soldiers” wearing traditional Arab headscarves firing at Iraqi police?

The incident took place just prior to a major religious event in Basra.

The report suggests that the police thought the British soldiers looked “suspicious”. What was the nature of their mission?

Occupation forces are supposed to be collaborating with Iraqi authorities. Why did British Forces have to storm the prison using tanks and armoured vehicles to liberate the British undercover agents?

*“British forces used up to 10 tanks” supported by helicopters “to smash through the walls of the jail and free the two British servicemen.”*

Was there concern that the British “soldiers” who were being held by the Iraqi National Guard would be obliged to reveal the nature and objective of their undercover mission?

A report of Al Jazeera TV, which preceded the raid on the prison, suggests that the British undercover soldiers were driving a booby trapped car loaded with ammunition. The Al Jazeera report (see below) also suggests that the riots directed against British military presence were motivated because the British undercover soldiers were planning to explode the booby trapped car in the centre of Basra: ...'

See: **Who is behind “Al Qaeda in Iraq”? Pentagon acknowledges fabricating a “Zarqawi Legend”**, in which the Washington Post of April 10, 2006, in its rare moment of candor – just like the New York Times' ex post facto exposé of April 20, 2008 on the Pentagon using retired Generals as mercenaries for hire to blatantly lie on American television in order to drum public support for the Iraq war [18] – is quoted in full context as follows: [19]

## Excerpt

"The Zarqawi campaign is discussed in several of the internal military documents. **"Villainize Zarqawi/leverage xenophobia response,"** one U.S. military briefing from 2004 stated. It listed **three methods: "Media operations," "Special Ops (626)"** (a reference to Task Force 626, an elite U.S. military unit assigned primarily to hunt in Iraq for senior officials in Hussein's government) and **"PSYOP,"** the U.S. military term for propaganda work..." (WP. 10 April 2006)

The military's propaganda program, according to the Washington Post, has "largely been aimed at Iraqis, but seems to have spilled over into the U.S. media. One briefing slide about U.S. "strategic communications" in Iraq, prepared for Army Gen. George W. Casey Jr., the top U.S. commander in Iraq, describes the "home audience" as one of six major targets of the American side of the war." (WP, op cit.)

**An internal document produced by U.S. military headquarters in Iraq, states that "the Zarqawi PSYOP program is the most successful information campaign to date."**

With that precious lesson in "*imperial mobilization*" through sustained PSYOP and manufactured "insurgency" learnt from our brethren Muslim nation of Iraq – where, in retrospect, and in moments of reflection through their daily strife and humiliation, its beleaguered people must surely ponder upon what could they have possibly done earlier, before 1990, during the iron-reign of Sadaam Hussein, and throughout those horrible intervening 13 years of Western hegemonic sanctions, to have avoided this new dismal fate altogether – let's return to Pakistan.

The multimodal approaches to destabilizing, and consequently balkanizing Pakistan under the fabled pretext of its own illusive Ali Baba, "Osama Bin Laden", have been so transparent, that today, finally, many a retired con-fession artist are getting in on the act to claim the flag of patriotism. [20] ***Going for hajj after having eaten 900 mice is the favorite pastime of Pakistani praetorian guards.*** I am only waiting for any sitting Pakistani General to rise to that occasion, if it's not already too late! [21] But I am afraid it probably is – see here, here, here, here, and here. [22]

The decapitation of Pakistan by Pakistan's finest, wantonly justifying the inglorious 'white

man's burden' – the same old 'la mission civilisatrice' under a new name – upon impoverished indigenous shoulders! [23] Even Martin Luther Kings' penetrating description fails to do justice to the scale of calamity in Pakistan: [24]

**“The white establishment is skilled in flattering and cultivating emerging leaders. It presses its own image on them and finally, from imitation of manners, dress, and style of living, a deeper strain of corruption develops. This kind of Negro leader acquires the white man's contempt for the ordinary Negro. He is often more at home with the middle-class white than he is among his own people. His language changes, his location changes, his income changes, and ultimately he changes from the representative of the Negro to the white man into the white man's representative to the Negro.”**

The shameful and criminal dislocation of up to 2.4 million civilians in May of this year was rightly described as “an exodus that is beyond biblical”. [25]



Caption In Pakistan, an exodus that is beyond biblical (UK Independent, 31 May 2009)

Just as from the USSR's point of view in yesteryear, the “insurgency” against them in Afghanistan was foreign inculcated, entirely fabricated in the USA (as we know today but

held as a closely guarded secret then), which thus forced the Soviets to apply counter-insurgency measures, and subsequently, an outright invasion of Afghanistan (read Brzezinski's own statements in *Saving Pakistan*, and watch Brzezinski speak in this video clip devilishly crafting the “insurgency” for the Russians on the Pak-Afghan border); the so called “insurgency” in Pakistan is also calculatingly fabricated, ab initio, in the **USA** through covert intervention and black-ops. [26] Subsequently, with sufficient “tickling” during the overt counter-insurgency operations, and by astutely harvesting all the cultural cracks and lacunae of the people, the “insurgency” acquires a reactionary life of its own. [27]

That latter stage, as well as on-going black-ops induced wanton acts of terrorism using the pre-“tickled” dupes and patsies as now rapidly transpiring, October 9-12, 2009, NYT, NYT – like the secret and 'officially denied' component of NATO's Operation Gladio in Western Europe of yesteryear which blamed it on the communists to keep an increasingly skeptical public's fear of the then boogiemán du jour continually alive – are Machiavellianly projected in the news media, by the native informants, by the fabricated dissent-chiefs, and the Mighty Wurlitzer, as **INSURGENCY**. [28] And therefore, it is officially argued, an unarguable *raison d'être* for continuing the barbaric **counter-insurgency** to implement the writ of the state. This predictably creates a self-sustaining destabilization as both commonsense and political science 101 would inform even an imbecile. The blood-drenched puppetshow so enacted, inevitably affords a compelling pretext to the puppetmasters to justify their own military intervention to “save” the people who are incapable of doing it themselves.

The innocent Pakistan military, not too well-versed in political science or Hegelian Dialectics based Machiavellian state-craft (I presume), in this prelude to NATO forces marching in, is similarly being compelled to take real counter-insurgency measures like the Soviets. Aided and abetted of course by high ranking traitors from within their own ranks, and by their foreign paymasters' militaries (NATO, Blackwater now renamed Xe, and other un-named foreign divisions operating within Pakistan which I call “Jundallah-plusplus” to distinguish them from “Jundallah” which is apparently targeting Iran from Pakistani soil). The simple fact that Pakistan is supplying all the drinking water (bottled by Nestle), and full logistics channel for war-making supplies to NATO in Afghanistan is telling in and of itself. Pakistan is equally responsible for destroying the Afghan society, the Afghan people, and there is no less spilled-blood of innocent Afghani Muslims upon Pakistan's hands over the past 30 years, than upon the United States'.

Pakistani military helped destroy Afghanistan, and they are now helping to destroy Pakistan. No Pakistani civilian I know, including myself, ever authorized the Pakistani



military to destroy Afghanistan, or aid the United States in its own hegemonic plans on the Grand Chessboard. Do you know anyone? So from where did they get their mandate? I would rather have clean drinking water in my tap, damn it! What good are the bloody nukes when they become the *raison d'être* for our very destruction in this manner without ever firing a single missile at the drones that are killing our own peoples?

It gives me no pleasure to repeatedly rehearse this footnote to history. What is not already obvious to the Pakistanis? It must surely still occur to many a reasonable military man serving with genuine zeal and honor in the real pivot of power in Pakistan that the end is drawing near. What are they doing idly watching the battle of their lives from the sidelines – when they are not shooting or displacing their own peoples that is? As quoted from a Dawn newspaper column:

***“THIS article poses two questions: on the day after US/Nato forces invade and occupy some of Balochistan and Waziristan, what will we say we should have done, and why aren’t we doing it now? Is this far-fetched? ... One hopes that a small group of patriotic officers in Pakistan are also asking themselves what can be done, and why aren’t we doing it now.”*** [29]

Gentlemen may cry, Peace, Peace--but there is no peace. The war is actually begun! The next gale that sweeps from the north will bring to our ears the clash of resounding arms! And that's the tortuous déjà vu reality today. [30]



If one is genuinely confused about who is the enemy, whether it's the Taliban, Al-Qaeeda, Islamism, Militant Islam, unknown foreign fighters, foreign intelligence agencies, India, Israel, American interests, or the United States' globalist oligarchs hell bent on criminally realizing their one-world government agenda by fabricating and harvesting “*revolutionary times*” across the planet, [31] please spend some time reviewing the book **The Pakistan**

**Decapitation Papers** available from Project Humanbeingsfirst.org [32] Write to me if you are still uncertain about who is behind “tickling” the so called “insurgents” into existence, and why that is necessary in order to fight the lifetime of World War IV with our blood. After



all, “**God is on your side**”! [33]

## Footnotes

[1] Zahir Ebrahim, <http://prisonersofthecave.blogspot.com/2007/04/part-1-they-dared-to-knock-on-my-door.html>

[2] Zahir Ebrahim, <http://print-humanbeingsfirst.blogspot.com/2008/02/who-killed-benazir-bhutto-herownwords.html>

Tehran Times, September 14, 2009 <http://print-humanbeingsfirst.blogspot.com/2008/02/who-killed-benazir-bhutto-herownwords.html#Addendum>

[3] Zahir Ebrahim, <http://print-humanbeingsfirst.blogspot.com/2008/02/letters-whokilled-benazir-fiction.html>

[4] Zahir Ebrahim, <http://print-humanbeingsfirst.blogspot.com/2009/03/day-after-dawn-mar212009.html>

CNN.com April 03, 2003, Ex-CIA director: U.S. faces 'World War IV' by Charles Feldman and Stan Wilson, <http://www.cnn.com/2003/US/04/03/sprj.irq.woolsey.world.war/>

[5] NYT August 19, 2009 C.I.A. Sought Blackwater’s Help to Kill Jihadists <http://www.nytimes.com/2009/08/20/us/20intel.html>

WP August 20, 2009 , CIA Hired Firm for Assassin Program [http://www.washingtonpost.com/wp-dyn/content/article/2009/08/19/AR2009081904315\\_pf.html](http://www.washingtonpost.com/wp-dyn/content/article/2009/08/19/AR2009081904315_pf.html)

NYT August 20, 2009, C.I.A. Said to Use Outsiders to Put Bombs on Drones <http://www.nytimes.com/2009/08/21/us/21intel.html>

[6] Zahir Ebrahim, <http://print-humanbeingsfirst.blogspot.com/2008/12/international-chorus-of-actors.html>

Zahir Ebrahim, <http://print-humanbeingsfirst.blogspot.com/2008/12/ali-baba-in-mumbai-eid2008-reflections.html>

[7] AP September 16-17, 2008, CIA chief: Military strikes offer lessons, by Stephen Manning <http://humanbeingsfirst.wordpress.com/files/2009/10/cacheof-usatoday-sept172008-cia-chief-military-strike-offer-lessons-in-tickling-civilians.pdf>

Zahir Ebrahim, <http://humanbeingsfirst.blogspot.com/2007/12/saving-pakistan-from-synthetic-terror.html>

The Miami Herald, Oct. 02, 2009, Scores of bodies found in Pakistan's Swat valley By Saeed Shah, McClatchy Newspapers  
<http://humanbeingsfirst.files.wordpress.com/2009/10/cacheof-miamiherald-oct22009-bodies-found-in-swat-valley.pdf>

[8] Zahir Ebrahim, <http://print-humanbeingsfirst.blogspot.com/2008/04/ap-covertwar-imperial-mobilization.html>

Los Angeles Times April 13, 2008, Bomb blast in Iran mosque kills 9  
[http://www.boston.com/news/world/middleeast/articles/2008/04/13/bomb\\_blast\\_in\\_iran\\_mosque\\_kills\\_9/](http://www.boston.com/news/world/middleeast/articles/2008/04/13/bomb_blast_in_iran_mosque_kills_9/)

*'Bombings are rare in Iran, but insurgencies have been blamed for some deadly bomb attacks in recent years. In February 2007, a car loaded with explosives blew up near a bus carrying members of Iran's Revolutionary Guard, killing 11 of them. In 2006, blasts killed nine people in Ahvaz near the Iraq border. Iran alleges that the United States, Israel, and Britain are behind the upsurge in militant activity and says it has intelligence to support the allegation.'* -- LA Times, April 13, 2008.

[9] Russia Today September 08, 2009, 'Contractors in Pakistan: are troops next?' Interview with Wayne Madsen <http://www.youtube.com/watch?v=182Pa8zKTuQ>

[10] Zahir Ebrahim, <http://print-humanbeingsfirst.blogspot.com/2008/03/warningamerica-nuking-iran-imminent.html>

Project Humanbeingsfirst Press Release <http://pressreleases-humanbeingsfirst.blogspot.com/2008/05/pr-full-spectrum-alliances-may152008.html>

[11] Zahir Ebrahim, <http://print-humanbeingsfirst.blogspot.com/2008/12/ali-baba-in-mumbai-eid2008-reflections.html>

[12] Global Research, June 11, 2004, Who is Abu Musab Al-Zarqawi? By Michel Chossudovsky <http://www.globalresearch.ca/index.php?>

context=viewArticle&code=MIC20050611&articleId=201

**[13]** Global Research, April 18, 2006 Who is behind “Al Qaeda in Iraq”? Pentagon acknowledges fabricating a “Zarqawi Legend” by Michel Chossudovsky

[http://www.globalresearch.ca/index.php?](http://www.globalresearch.ca/index.php?context=viewArticle&code=CHO20060418&articleId=2275)

context=viewArticle&code=CHO20060418&articleId=2275

**[14]** Zahir Ebrahim, Prisoners of the Cave, 2003, Chapter 1

<http://prisonersofthecave.blogspot.com/2007/04/chapter-1.html>

**[15]** Zahir Ebrahim, <http://print-humanbeingsfirst.blogspot.com/2008/12/responseto-ft-gideon-rachman-worldgov.html>

Project Humanbeingsfirst's Tutorial: The Hegelian Dialectics of Deception – Today's Focus: Anatomy of Modern Lies, Senseless Warfare, Merchants of Death <http://print-humanbeingsfirst.blogspot.com/2009/05/anatomy-of-modern-lies-pakistanishills.html>

**[16]** Global Research, September 25, 2005 Were British Special Forces Soldiers Planting Bombs in Basra? Suspicions Strengthened by Earlier Reports, by Michael Keefer

[http://www.globalresearch.ca/index.php?](http://www.globalresearch.ca/index.php?context=viewArticle&code=KEE20050925&articleId=994)

context=viewArticle&code=KEE20050925&articleId=994

Global Research, September 20, 2005 British “Undercover Soldiers” Caught driving Booby Trapped Car “They refused to say what their mission was.” by Michel Chossudovsky

[http://www.globalresearch.ca/index.php?](http://www.globalresearch.ca/index.php?context=viewArticle&code=20050920&articleId=972)

context=viewArticle&code=20050920&articleId=972

**[17]** Project Humanbeingsfirst Press Release [http://pressreleases-](http://pressreleases-humanbeingsfirst.blogspot.com/2008/09/pr-whats-to-be-done-pakistan-sept222008.html)

[humanbeingsfirst.blogspot.com/2008/09/pr-whats-to-be-done-pakistan-sept222008.html](http://pressreleases-humanbeingsfirst.blogspot.com/2008/09/pr-whats-to-be-done-pakistan-sept222008.html)

**[18]** NYT, Sunday, April 20, 2008, Message Machine: Behind TV Analysts, Pentagon’s Hidden Hand - A PENTAGON CAMPAIGN Retired officers have been used to shape terrorism coverage from inside the TV and radio networks. By DAVID BARSTOW

<http://www.nytimes.com/2008/04/20/us/20generals.html>

See its pertinent deconstruction in Zahir Ebrahim, 'Bin Laden': Key enabler of “imperial mobilization” and nuclear attack on Iran-Pakistan <http://print-humanbeingsfirst.blogspot.com/2008/04/binladen-keyenabler-nuclearattack.html>

See Project Humanbeingsfirst's A Note on the Mighty Wurlitzer <http://print->

humanbeingsfirst.blogspot.com/2009/05/note-on-mighty-wurlitzer.html

**[19]** Global Research, April 18, 2006 Who is behind “Al Qaeda in Iraq”? Pentagon acknowledges fabricating a “Zarqawi Legend” by Michel Chossudovsky  
<http://www.globalresearch.ca/index.php?context=viewArticle&code=CHO20060418&articleId=2275>

**[20]** Zahir Ebrahim, <http://print-humanbeingsfirst.blogspot.com/2008/04/binladen-keyenabler-nuclearattack.html>

Press TV September 14, 2009 Ex-Intel officer discloses US plans for Pakistan, exclusive interview of Pakistan's former ISI Chief General Hamid Gul to Press TV  
<http://www.presstv.ir/detail.aspx?id=106141&sectionid=351020401>

*'US officials "want to go for Pakistan's nuclear assets. They are inching close to those nuclear assets day by day," he added. When asked about Washington's long-term goal in Pakistan, the former Inter-Services Intelligence (ISI) said that the United States wants to keep the country destabilized.'* -- Press TV Sept. 14, 2009.

This is the same General Gul turning on his own patrons after he had fully assisted them in “giving to the USSR its Vietnam war” from Pakistani soil. An African proverb says: you need a very long spoon to sip with the devil.

Tehran Times September 14, 2009, Blackwater involved in Bhutto and Hariri hits: former Pakistani army chief [http://www.tehrantimes.com/index\\_View.asp?code=203224](http://www.tehrantimes.com/index_View.asp?code=203224)

*'TEHRAN - Pakistan's former chief of army staff, General Mirza Aslam Beg (ret.), has said the U.S. private security company Blackwater was directly involved in the assassinations of former Pakistani prime minister Benazir Bhutto and former Lebanese prime minister Rafik Hariri.'* -- Tehran Times Sept. 14, 2009

Why was this General muted when all the specious reports were being so boisterously promulgated by the Mighty Wurlitzer's propaganda machinery both in the West and in Pakistan's own newspapers? See the many **Letters to Editors on Perpetuating the Fiction of who killed Benazir Bhutto** by Zahir Ebrahim, <http://print-humanbeingsfirst.blogspot.com/2008/02/letters-whokilled-benazir-fiction.html>

**[21]** Zahir Ebrahim, <http://print-humanbeingsfirst.blogspot.com/2007/12/re-imagining-pakistans-defenses.html>

**[22]** UK Telegraph September 27, 2009 US threatens to escalate operations inside Pakistan <http://www.telegraph.co.uk/news/worldnews/asia/pakistan/6237185/US-threatens-to-escalate-operations-inside-Pakistan.html>

The News, Friday, September 25, 2009 More drone strikes possible in Pakistan [http://www.thenews.com.pk/top\\_story\\_detail.asp?Id=24694](http://www.thenews.com.pk/top_story_detail.asp?Id=24694)

Antiwar.com September 24, 2009 US Mulls Increasing Drone Strikes in Pakistan - Will Pakistan Escalation Come With Afghan Escalation? by Jason Ditz, <http://news.antiwar.com/2009/09/24/us-mulls-increasing-drone-strikes-in-pakistan/>

Antiwar.com September 27, 2009 US Threatening to Attack Major Pakistani City of Quetta - Will US Drone Strikes Move From Rural Pakistan to Baloch Capital? by Jason Ditz <http://news.antiwar.com/2009/09/27/us-threatening-to-attack-major-pakistani-city-of-quetta/>

Uruknet.info September 24, 2009 U.S., NATO Poised For Most Massive War In Afghanistan's History, By Rick Rozoff writing for Stop NATO <http://uruknet.com/index.php?p=m58262&hd=&size=1&l=e>

**[23]** Zahir Ebrahim <http://print-humanbeingsfirst.blogspot.com/2009/09/decapitation-of-pakistan.html>

Thaindian News October 5, 2009 US pullout from Afghanistan would be 'disastrous': Musharraf, [http://www.thaindian.com/newsportal/south-asia/us-pullout-from-afghanistan-would-be-disastrous-musharraf\\_100256418.html](http://www.thaindian.com/newsportal/south-asia/us-pullout-from-afghanistan-would-be-disastrous-musharraf_100256418.html)

The Grand Chessboard by Zbigniew Brzezinski, <http://sandiego.indymedia.org/media/2006/10/119973.pdf>

**[24]** A Testament of Hope: The Essential Writings and Speeches of Martin Luther King (Jr.), pg. 307 <http://books.google.com/books?id=k8uPHtrU8BsC&pg=PA307>

**[25]** Project Humanbeingsfirst Press Release <http://pressreleases-humanbeingsfirst.blogspot.com/2009/05/pr-statement-on-pakistan-may262009.html>

UK Independent, Sunday, 31 May 2009, In Pakistan, an exodus that is beyond biblical - Locals sell all they have to help millions displaced by battles with the Taliban By Andrew Buncombe <http://www.independent.co.uk/news/world/asia/in-pakistan-an-exodus-that-is-beyond-biblical-1693513.html>

[26] Zahir Ebrahim, <http://print-humanbeingsfirst.blogspot.com/2007/12/saving-pakistan-from-synthetic-terror.html>

Video clip of Zbigniew Brzezinski, PBS

[http://sites.google.com/site/humanbeingsfirst/download-pdf/god\\_is\\_on\\_your\\_side.wmv?attredirects=0](http://sites.google.com/site/humanbeingsfirst/download-pdf/god_is_on_your_side.wmv?attredirects=0)

[27] BBC News, Islamabad, October 02, 2009 Pakistan in video beating probe By Syed Shoab Hasan [http://news.bbc.co.uk/2/hi/south\\_asia/8287264.stm](http://news.bbc.co.uk/2/hi/south_asia/8287264.stm)

AP, Video appears to show Pakistan army abuses

<http://humanbeingsfirst.wordpress.com/files/2009/10/cacheof-ap-video-appears-to-show-pakistan-army-abuses-oct022009.pdf>

Zahir Ebrahim, <http://print-humanbeingsfirst.blogspot.com/2007/12/islamofascism-zionofascism-judeofascism.html>

Zahir Ebrahim, <http://print-humanbeingsfirst.blogspot.com/2009/04/pak-geniuses-or-native-informants.html>

[28] NYT October 9, 2009 Latest Pakistan Bombing Seen as Warning to Government <http://www.nytimes.com/2009/10/10/world/asia/10pstan.html?hp>

NYT October 12, 2009 Car Bomb Kills at Least 41 in Restive Region of Pakistan [http://www.nytimes.com/2009/10/13/world/asia/13pstan.html?\\_r=1&hp](http://www.nytimes.com/2009/10/13/world/asia/13pstan.html?_r=1&hp)

**Article:** NATO's secret armies linked to terrorism? 2004, by Daniele Ganser <http://www.globalresearch.ca/articles/GAN412A.html> ; **Book:** NATO's Secret Armies. Operation Gladio and Terrorism in Western Europe, 2004 by Daniele Ganser <http://www.amazon.co.uk/NATOs-Secret-Armies-Operation-Contemporary/dp/0714685003> , free PDF available online ; **Video:** BBC Documentary Timewatch, 3 episodes, aired on BBC Ch 2, June 1992, available online on googlevideo.

Zahir Ebrahim, <http://humanbeingsfirst.wordpress.com/files/2009/05/letter-to-hamid-mir-geo-tv-may152009-stupid-or-shill.pdf>

Zahir Ebrahim, <http://print-humanbeingsfirst.blogspot.com/2009/05/newsflash-terrorism-may2009.html>

Zahir Ebrahim, <http://print-humanbeingsfirst.blogspot.com/2008/12/letter-paul-craig-roberts->

rebuttal.html

Zahir Ebrahim, <http://print-humanbeingsfirst.blogspot.com/2009/05/note-on-mighty-wurlitzer.html>

[29] Cited in Zahir Ebrahim, <http://print-humanbeingsfirst.blogspot.com/2009/03/day-after-dawn-mar212009.html>

[30] Epilogue in The Pakistan Decapitation Papers, echoing the immortal words of Patrick Henry, March 23, 1775, <http://www.law.ou.edu/ushistory/henry.shtml>

[31] Zahir Ebrahim, <http://print-humanbeingsfirst.blogspot.com/2008/12/responseto-ft-gideon-rachman-worldgov.html>

[32] Zahir Ebrahim, **The Pakistan Decapitation Papers** <http://print-humanbeingsfirst.blogspot.com/2009/10/foreword-pakistan-decapitation-papers.html>

[33] Video clip of Zbigniew Brzezinski, PBS  
[http://sites.google.com/site/humanbeingsfirst/download-pdf/god\\_is\\_on\\_your\\_side.wmv?attredirects=0](http://sites.google.com/site/humanbeingsfirst/download-pdf/god_is_on_your_side.wmv?attredirects=0)

**Source URL:** <http://humanbeingsfirst.wordpress.com/2010/10/26/insurgency-vs-counter-insurgency-by-zahir-ebrahim/>

**Short URL:** <http://tinyurl.com/what-is-insurgency>

First Published September 28, 2009

## Chapter 21 Not Fooled Again: Financial Terrorism

# The Monetary Conspiracy for World Government

### Introduction

Economics and Money aren't supposed to be as abstruse as it is made out to be, and nor does it take a Ph.D. from M.I.T. to realize that one is being taken for a sodomized ride on the Capricorn of economics gibberish. It is the responsibility of every denizen of the world to understand how humanity is being herded into global debt-enslavement and a centrally managed world-government, baby-step at a time, by manufacturing deliberate crisis and then proposing the next baby-step as its solution or fait accompli. Each baby-step erodes away some aspect of national sovereignty. 911 helped setup the global police state as a proposed solution to 'terrorism' – a manufactured product – to create the sine qua non mechanisms for world-government. ***“World government could only be kept in being by force”***, as Bertrand Russell had put it.

The latest financial crisis is designed to systematically create a central world-banking system, as a proposed solution to 'bad loans' – again a manufactured product – to be managed by a global banking cartel under legal sanction. ***“Give me control of a nation's money supply, and I care not who makes its laws”***, as the Rothschild banking scions boldly narrate in almost every generation. Today, the cumulative world debt is in uncountable trillions, and there is no nation on earth which is not beholden to some banking cartel, be it the WB-IMF tag team of economic mercenaries preying upon the resource-rich nations of Global South (see John Perkins), or the private central banks lending parasites doing the same to their richer brethren in the Global North (see Money as Debt).

On top of them both, sit the same handful of private banking families in their interlocking relationships, protected by their own hand-crafted instruments of commerce, trade-treaties, and their hand-picked political governance which creates for them the legal sanctions necessary for the entire global racket based on unpayable debt to flourish. Once a nation, like a person, can't pay its debts, demand for the proverbial ***“pound of flesh”*** is as convincing as making an offer one can't refuse.

In contrast to the Neanderthal gangster Al Capone, or Michael Corelone in the blockbuster



movie 'The Godfather', who weren't smart enough to change the laws of the land in favor of their criminal enterprises and therefore, the state's policing apparatus could be relied upon to eventually take parasites like them down, these banksters connivingly write the very laws of the land in their favor. They own, or control through proxy, the media, the legislatures, the executives, the think-tanks, the foundations, all levers of power, good and bad loans, and discourse itself, in pretty much all major societies – from G7 to G20 (excepting to some extent BRIC, Venezuela, and Iran) – cleverly hiding their own role behind the scenes in constructing their global fiefdom.

That aspiration was unabashedly and boldly re-stated by bankster James Warburg in 1950 to the US Senate – the son of bankster Paul Warburg who not only founded the Council on Foreign Relations in 1921, but was the key architect of the Federal Reserve System under the clandestine auspices of Senator Nelson Aldrich at Jekyll Island in 1910 – ***“We shall have World Government, whether or not we like it. The only question is whether World Government will be achieved by conquest or consent.”***

And that precise “consent” is being manufactured, as we speak, baby-step at a time! This ain't no 'tin-hatted' conspiracy of the UFO's taking over as the 'body-snatchers', or Orson Wells' famous dramatization on radio of H. G. Wells' novel “The War of the Worlds”. That Halloween eve special in 1938 – as an experiment in mass psychology to observe the response to fear – panicked New York city!

A bona fide long-running elitist conspiracy for world government that is rapidly reaching fruition today within the windows of opportunity created by manufactured crises – ***“We are on the verge of a global transformation. All we need is the right major crisis and the nations will accept the New World Order”***, noted David Rockefeller – is writ large in the ex post facto con-fessions and deeds of its vainglorious key architects themselves. Indeed, witness this eloquent boast from the bankster, in his own 2002 'Memoirs': ***“Some even believe we are part of a secret cabal working against the best interests of the United States, characterizing my family and me as 'internationalists' and of conspiring with others around the world to build a more integrated global political and economic structure – one world, if you will. If that is the charge, I stand guilty, and I am proud of it.”*** (pg. 405)

A penetrating understanding of manufactured crises as Machiavellian harbingers of calculated change, may be gleaned in Isaac Asimov's science fiction classic known as the 'Foundation Trilogy'. It is not accidental that **foundations**, both in real life, and in art, are instrumental harbingers of imperial change. This truism is attested to by the evidence gathered by Norman Dodd for the Congressional Reece committee in 1953-54, as

described below. Wikipedia notes of the art version, that, *“According to Asimov, the premise [of Foundation] was based on ideas set forth in Edward Gibbon's History of the Decline and Fall of the Roman Empire,”!*

The only protection against these parasites – whom America's courageous President, Andrew Jackson, referred to as *“a den of vipers”* – is for ordinary peoples first learning what has been kept hidden from them, before it is too late. For indeed, tortuous control systems are being put in place globally at an accelerated pace, and overturning them after fait accompli would require nothing less than a new 'Moses' powerfully proclaiming to the new 'Pharaohs': *“let my people go!”* Last time I checked, god of chosen peoples had unmercifully relegated both the old and new prophets to the enactment of miracles only on the silver screen for the entertainment of the masses, as its ordained New World Order is brought into beguiling existence under the radar screen of most plebes. What now sayist the plebe?

For those who know nothing of these matters, Project Humanbeingsfirst has compiled an 'essentials' self-study bibliography of videos, books, documents, news reports, and its own forensics reports, for both, beginners frantically searching for an understanding of what's happening to them as they lose their shirts and their skirts to Wall Street, as well as for advanced non-researcher white-collar professionals whose job it is to understand money, but who actually remain no less ignorant than the plebes. **All only suffer its want, or enjoy its superfluity, but no one has the time or the inclination to ponder its creation, or which hands control it. Most believe, as did this scribe once, that the government creates and controls money.** Please see the self-study bibliographic guide: Monetary Reform Bibliography – A self-study guide for uncovering the agendas behind the economics gibberish. [a1]

## The Ignorance of the Learned

It has been rather disturbing for this scribe to continually rediscover that even well educated persons from among the ruling elite themselves, CEOs of corporations with fancy MBA degrees, venture capitalists with CA degrees, economists with Ph.D., and financial geniuses on Wall Street with degrees in mathematics and physics from Caltech and M.I.T. – never mind engineers and scientists perpetually kept too busy to bring their rational forensic acumen to bear upon such mundane existential matters as money, economy, geopolitics and empire – do not fully understand the mechanics of money, nor its direct manufactured relationship with economic booms-and-collapses, war on terror, and the broader calculated agenda for world government. All feel daunted by the economics gibberish which surrounds any discussion of it.

It is also painfully obvious that even the so called “expert” economists, and Nobel Laureates, do not fully grasp all the issues regarding money. Because they still can't manage the economy despite their Nobel Prizes, and keep getting run over by the exact same inability to link together artificial booms and speculations fueled by cheap credit that is created out of thin air as national debt, predictable busts, tightening of credit, loss of confidence, and ultimate windfall for the handful of wealthy in whose hands all the wreckage of prosperity gets transferred pennies to the dollar, consolidating enormous wealth in fewer and fewer hands at the end of it all. And they still can't call it correctly, as evidenced from the statements of the famous 92 year old economist Anna Schwartz – coauthor of Milton Friedman's classic text on monetary history of the United States – and all the rest of the economists quoted by Lendman. [a2] More examples can be found in “Monetary Reform: Who will bell the cat?”. And as is the case for the common man who least understands any of this, it could be for these learned economists as well, that it's simply because of the overloaded semantics and secrecy which surrounds this most essential and profound human invention since fire.

None among them apparently knows the money mechanics and how it astronomically enriches the private bankers for doing absolutely no production work in society other than ledger-entry, and none has any appreciation for the overarching “*forces that drive them*”. For surely, as Bernard Lewis had observed in another terrorism context, a study of motivations can lead to a better understanding of why the financial terror crises fueled by newer deadly toys and things – what Warren Buffet called the “**Financial Weapons of Mass Destruction**” and predictable “*time bombs*” [a3] – keep getting repeated under the very noses of those chartered to explicitly prevent them, leaving the much lauded economists from prestigious institutions none the wiser. But it is perhaps also more credible to argue, that they – the profoundly learned economists – deliberately promulgate economics gibberish in the service of their 'ubermensch' masters. The empire needs its own knowledge-scions, just as it needs its own media, its own presses, its own propaganda and spin machinery, and its own military-industrial-academe complex. Who sits atop all of this? Who funds all this? Who benefits from all of this? Does the United States – its economy and its peoples in worst shape today in this first decade of the information age than they ever were since the Great Depression years of the industrial age?

So, clearly it wasn't just for the “*full spectrum dominance*” of the nation-state of the United States, for which the sole superpower was being coerced into exercising its Project for the New American Century under the disguise of 'war on terror'. It was not just for the hegemony of the sole superpower that Zbigniew Brzezinski – an Executive Director of the globalist Trilateral Commission which David Rockefeller founded – had penned 'The Grand Chessboard' and made it available so publicly, like its PNAC twin.

While clearly America bombed Iraq and Afghanistan, and may yet nuclear bomb Iran and Pakistan, not to mention enter into a chicken-style nuclear confrontation with Russia, but what fuels this asininity? Who benefits?

The American peoples as well as their nation-state are certainly the very visible losers in the final analysis – even at the cost of decimated 'lower-civilizations' and their unfortunate children of lesser gods, many more will follow in those footsteps, and only they will see the end of war being waged upon humanity – going bankrupt and trillions of dollars in debt as they are. See the latest national debt figures in “The entrenched notion of Public Debt in America – will take a gestalt shift to overcome!”.

Who holds this national debt at its very top, and for which, every American tax-payer perpetually pays interest on? Aaron Russo in his documentary “America: from Freedom to Fascism”, makes the astonishing revelation of how private central banking under the Federal Reserve System, and the federal income tax, are joined together at the hip as a congenital birth defect. There is some discussion of the possible illegitimacy of the federal income tax and the IRS in the film, but that's a red herring which distracts from the fact that it could be just as legal as the Federal Reserve System, and still remain a premeditated congenital birth defect devilishly crafted to ensnare the unwary public into paying gratuitous interest on the issuance of their own national currency! [a4]

Something far more insidious has been under construction using just one primal axiom of political science: **“what is inconceivable in normal times is possible in revolutionary times”**, the devilish words of David Ben Gurion who presided over the leadership of the newly acquired land for the Jews at the expense of its indigenous Palestinian inhabitants exactly 60 years ago. The same maxim is being deployed for world conquest at the expense of the rest of its indigenous inhabitants.

At the top of that pyramid, sit the moneychangers of modernity. For money is an even bigger existential necessity today in the producer-consumer global paradigm of high finance than it ever was in the past, even though the imperial coin is as old as mankind!

And yet just the fact that one has to come by the accurate understanding of “Money” only as a forensic detective assembling a jigsaw puzzle, and primarily from empirical analysis of widely disparate data and events, is very revealing of the secretive role of its affluent creators.

The power of money creation in private hands lies at the root of all evil. A forensic recognition of this blatant fact and the concomitant direct full spectrum public assault upon

it, will lead to the termination of all the wet dreams for world government by hectoring hegemony of all stripes. It will also lead to the immediate termination of all the manufactured mechanisms employed for achieving it, namely, the fiction of 'war on terror' and the manufactured economic collapse. Furthermore, a lineup before a court appointed legal firing squad with confiscation of all wealth should create a reasonably effective deterrence example for the future.

So let's no longer be counted among the ignorant, the co-opted, and those who, quite bewilderingly, "*scurry around like drugged cockroaches in a bottle*" [a5] waxing platitudes against an indomitable foe out for their enslavement.

To emphasize the relevance of learning from history to avert a tortuous future, take for example, the remarkable 1982 video interview of Mr. Norman Dodd by G. Edward Griffin, cited in the Project Humanbeingsfirst's Monetary Reform Bibliography. It can be watched [here](#).

As a member of the "*Morgan Bank*" during the Great Depression, and later a chief investigator in 1953-54 for U.S. Congressman B. Carroll Reece's Special Committee on Tax Exempt Foundations (the Reece Committee), Norman Dodd makes some extraordinary revelations on video. He appears to be an unusually credible person, unlike many other plebeian detractors of aggregated wealth – scion of wealth and pamper, educated at Andover and Yale, insider to banking and Wall Street investment – not a 'tin-hatted' conspiracy theorists alluded to in the main discourse ("The Enduring Capitalist Conspiracy For World Government").

After the crash of 1929, Norman Dodd says he had "*rendered*" a report on the stock market crash to his bank's superiors, and according to the paraphrase of the Morgan bank officials that was rehearsed back to him: "***Norm what you're saying is we should return to sound banking ... We will never see sound banking in the United States again.***"

Mr. Dodd further reveals that the officials rehearsed "*chapter and verse*" to explain that point and stated:

"Since the end of world war one we have been responsible for what they call the institutionalizing of conflicting interests, and they are so prevalent inside this country that they can never be resolved."

With that as the backdrop, this is what Norman Dodd relates of a conversation he had with the President of the tax-exempt Ford Foundation in 1954, as part of his Congressionally mandated investigation of tax-exempt foundations:

“Mr. Dodd, we've asked you to come up here today because we thought that possibly, off the record, you would tell us why the Congress is interested in the activities of the foundations such as ourselves.” Before I could think of how I would reply to that statement, Mr. Gaither then went on and said: “Mr. Dodd, all of us who have a hand in the making of policies here have had experience operating under directives, **the substance of which is that we shall use our grant-making power so to alter life in the United States that it can be comfortably merged with the Soviet Union.**”

ED GRIFFIN: Why do the foundations generously support Communist causes in the United States?

NORMAN DODD: Well, because to them, Communism represents a means of developing what we call a monopoly, that is, an organization of, say, a large-scale industry into an administerable unit.

ED GRIFFIN: Do they think that they will be the ones to benefit?

NORMAN DODD: They will be the beneficiaries of it, yes.

Another ominous thread in the interview is when Dodd reveals of what his lead investigator discovered in the minutes-books of Carnegie Endowment for Peace. According to Norman Dodd, the following was recorded on the old-fashioned dictaphone machine by Katherine Casey as she was browsing the minutes-books in the CEP library:

We are now at the year 1908, which was the year that the Carnegie Foundation began operations. In that year, the trustees, meeting for the first time, raised a specific question, which they discussed throughout the balance of the year in a very learned fashion. The question is: ***“Is there any means known more effective than war, assuming you wish to alter the life of an entire people?”*** And they conclude that no more effective means than war to that end is known to humanity.

So then, in 1909, they raised the second question and discussed it, namely: ***“How do we involve the United States in a war?”***

Well, I doubt at that time if there was any subject more removed from the thinking of most of the people of this country than its involvement in a war. There were intermittent shows in the Balkans, but I doubt very much if many people even knew where the Balkans were. Then, finally, they answered that

question as follows: ***“We must control the State Department.”*** That very naturally raises the question of how do we do that? And they answer it by saying: ***“We must take over and control the diplomatic machinery of this country.”*** And, finally, they resolve to aim at that as an objective.

Then time passes, and we are eventually in a war, which would be World War I. At that time they record on their minutes a shocking report in which they dispatched to President Wilson a telegram, cautioning him to see that the war does not end too quickly.

Finally, of course, the war is over. At that time their interest shifts over to preventing what they call a reversion of life in the United States to what it was prior to 1914 when World War I broke out. At that point they came to the conclusion that, to prevent a reversion, ***“we must control education in the United States.”*** They realize that that's a pretty big task. It is too big for them alone, so they approach the Rockefeller Foundation with the suggestion that that portion of education which could be considered domestic be handled by the Rockefeller Foundation and that portion which is international should be handled by the Endowment. **They then decide that the key to success of these two operations lay in the alteration of the teaching of American history.** [...]

Mr. Norman Dodd had also revealed another interesting little known fact in a prior year, in his testimony on “Regionalism” in 1978 before a committee created by the Illinois legislature. He disclosed the fact that a brand new constitution for the American continent had already been constructed as a super-state – what today in its baby-step incarnation is called the North American Union – and it has been patiently waiting in the wings, like the Patriot Act, to be sprung at the opportune time just like the oppressive police-state legislation was sprung upon the American public within a few weeks of 911. Witness this exchange: [a6]

Mr. Dodd: [...] Now, the second experience that I would like to share with you... oh, and incidentally, it is the Ford Foundation's grants which are responsible for the formulation of this idea of regional government, and also the idea that given regional government, we must, in turn, **develop and accept and agree to a totally new Constitution which has already been drawn up**, as was mentioned just a few minutes ago. [previous testimony]  
[...]

Rep. Lucco : Fine. You've answered my question. Now, another thing. You took us back to 1908, and I came on the scene in 1912, about the time of the Balkan Wars, which you alluded to, and World War I. Now, today, and you said that we actually created -- or "they", whoever "they" are - actually created the situation of a war. Now that we have the...

Mr. Dodd : Wait, now. You deserve to know who the "they" are.

Rep. Lucco : I was going to ask you that.

Mr. Dodd : The "they" in this instance are the Trustees. . . were the Trustees of the Carnegie Endowment for International Peace. They were men who were prominent lawyers in New York; men like Nicholas Murray Butler, the head of Columbia University; also, and subsequently, Allen and Foster Dulles, as attorneys -- that caliber of gentlemen.

*[CDR Note: "Global Tyranny ...Step by Step", by William Jasper, quotes Allen W. Dulles from a UN booklet, Headline Series #59 - New York: The Foreign Policy Association, Sept-Oct, 1946- page 46... **"There is no indication that American public opinion, for example, would approve the establishment of a super state, or permit American membership in it. In other words, time - a long time - will be needed before world government is politically feasible... This time element might seemingly be shortened so far as American opinion is concerned by an active propaganda campaign in this country..."**]*

Rep. Lucco : Then I'm trying to collate what you are talking about -- 1912 -- with 1978, the meeting at Camp David, the problems in the Middle East, the Sino-, or Chinese-Russian situation--are they now getting us ready for a third world war?

Mr. Dodd: **My answer to that, sir, is that they have set forces in motion, and these forces cannot help but culminate in World War III.** I happen to personally believe that it is possible to prevent it from working out that way, but I'm alone in my beliefs.

Rep. Hudson: Apparently you're not alone, Mr. Dodd. [...]

Rep Hudson : Mr. Dodd, I have one question. **You mentioned a proposed new Constitution, or federal charter, for this country, sort of waiting in**



**the wings, you might say.**

Mr. Dodd : Yes.

Rep Hudson: Is that the one... I have heard tell of a Tugwell type. Is that the one you refer to?

Mr. Dodd : That's it, sir.

Rep. Hudson : Thank you. All right, well, thank you very much, Mr. Dodd. We are grateful for your being here.

Now, if Rep. Lucco of the Illinois legislature in 1978 can endeavor to "*collate what you are talking about -- 1912 -- with 1978*", surely a sensibly learned person today might try to collate the same to 2008? How might one forensically bring to bear all such historical knowledge, including revelations by Norman Dodd, on the present financial crisis and the role of the Federal Reserve System? How does that relate to the blatantly undisguised drive for world government today? How does that relate to 911? But no! Not the Federal Reserve System Chairman, nor any of the Nobel Prize winning economists waxing more economics gibberish, will go there! [a7]

And forget about the mainstream presses, erudite pundits, and even lauded dissent-space politicians like Ron Paul, [a8] and intellectuals like Noam Chomsky [a9] [a10] and Howard Zinn [a11] – forever only rehearsing the crimes of the “rogue state” and 911 its “blowback” – doing so either. Their laudable emphasis on the facts that are visible like the American F16s and Apache Helicopters bombing civilians, or the crash of the stock market as a result of casino capitalism, and lamentable silence on the ones which are not readily visible like that which remains shrouded in conspiratorial secrecy for an overarching agenda and must be forensically uncovered from rational thinking and analysis, or official narratives that are required to be kept intact, only ends up circuitously leading their own fawning flock, amidst great applause, to the pastures dutifully bounded by the same fences as the mainstream scholars! [a12] [a13] Their intellectualism, apparently, only extends to the government mandated axioms of “Bin Laden” and “Al-Qaeeda”, which are most obligingly, implicitly retained by them in their very learned dissenting discourses that valiantly document and courageously standup to the crimes of their own nation. [a14] [a15] And these intellectual are this scribe's own respected teachers! [a16]

Perhaps all these gadfly historians and men and women of letters who mainly delight in rehashing histories which are already faits accomplis, and in waxing moralizing sermons on being the privileged minority to whom **“Western democracy provides the leisure, the**

facilities, and the training to seek the truth lying hidden behind the veil of distortion and misrepresentation, ... through which the events of current history are presented to us”, [a17] be graciously reminded of George Bernard Shaw's famous maxim “**We are made wise not by the recollections of our past, but by the responsibility for our future**”.

One wishing to learn more may review the pertinently culled reading list in the Monetary Reform Bibliography, and minimally peruse: “Monetary Reform: Who will bell the cat?”, and the Press Release “This may be a psy-op!”.

As Noam Chomsky once wrote, and quite correctly too, that “***it takes a sentence to repeat lies and deceit, while it takes considerably more space to unravel them.***” [a18] Elsewhere, he also wisely noted “***It's always a good idea to start by asking about the facts. It's whenever you hear anything said very confidently, the first thing that should come to mind is, wait a minute, is that true?***” [a19] Fortunately, many dedicated and quite ordinary peoples have learnt from Noam Chomsky's teachings, and have already done just that. They have diligently asked about the facts for all the official myths which are axiomatically rehearsed “**very confidently**” from the highest to the lowest pulpits across the land, and some of their truly intellectual works are cited in the Monetary Reform Bibliography.

The reader is also invited to ask the same question, “**is that true**”, of the 'who-dunit' axiom of the first 911 which “**very confidently**” narrated of an invasion from abroad; of the axiom of 'macro economics inevitability of this financial meltdown' that Warren Buffet termed “*an economic Pearl Harbor*”; and finally, of the axiom of 'the only solution for avoiding both types of 911s in the future, is world government controlled by the private central banks at the top of the pyramid'. The same pyramid-top which keeps the watchful-eye upon the world from the back of the world's reserve currency, the one dollar bill! It is an important question to ask, who effectively controls this reserve currency? For their identity is the identity of the watchful eye, the real emperors of the world! Upon their feet, lie the seeds of all the crimes against humanity in modern times. And upon whose beck and call, lies the “*imperial mobilization*” of the sole superpower state to preside over its own calculated demise, to create 'one world'!

Armed with all this analysis from many disparate sources and a rational long-view perspective which connects all the dots – perhaps a weekend's worth of self-study – one can finally judge for oneself what is deliberate disinformation, and what are the indisputable facts of the matter.

Thus, at least, one is now trivially able to judge for oneself, the worth of half-truths based disinformation masterpieces which deceive by omission rather than outright lies, like:

[http://www.publiceye.org/conspire/flaherty/Federal\\_Reserve.html](http://www.publiceye.org/conspire/flaherty/Federal_Reserve.html)

But even more importantly, now one has sufficient knowledge, as well as perspective from many sources, to ask the overarching meta question:

**Why should there be any need for super-abundance of non-information, and at best, disinformation – the profound ignorance of the learned – on such a transparent matter as the Federal Reserve System, and on such a mundane issue like money which everyone in society needs existentially, like air and water, in the first place?**

If one ponders upon that question first, either agrees or disagrees with the proposition that this subject is shrouded in secrecy and obfuscation which is what creates mythologies, half-truths, and even outright lies – not to mention the trillion dollar Bailout of Wall Street [a20] that Treasury Secretary Hank Paulson now also recommends for other nations through a coordinated central banks' attack upon all the world's peoples to ensnare them all in further debt – then the rest follows on why detective forensic skills are either needed, or not, to tell the difference between propagandists shilling for their paymasters, 'tin-hatted' conspiracy theorists indulging their imaginations, 'technique of infamy' and manufactured red herrings, and the unarguable real facts of the matter.

Answering this question first, can further enable one to look at solutions-spaces more critically without being fooled. But only after the problem-space, and its awesome power to corrupt and to confuse, has been first well understood. In this regard, humanity owes a great debt of gratitude to Ezra Pound, America's most ignored poet and thinker, for explaining the specialized version of the dialectics of deception – the 'technique of infamy'.

### **Thus We Fail as a “focus group”!**

To begin exploring the solutions-space, the following websites might be useful. Project Humanbeingsfirst does not endorse, or censure, anyone of them, and remains largely agnostic when they make sense – for the real challenge lies elsewhere. A preliminary analysis of two main proposals, the Gold-Standard (Mises Institute) favored by Rep. Ron Paul, R-Texas, which does not make any sense, and the Greenbacks, (thought to be) favored by Rep. Dennis Kucinich, D-Ohio, which does make sense, can be found in the Monetary Reform Bibliography.

<http://mises.org>

<http://monetary.org/>

<http://www.webofdebt.com/>

<http://www.monetaryreform.org/>

<http://www.themoneymasters.com>

[http://www.ratical.org/many\\_worlds/cc/](http://www.ratical.org/many_worlds/cc/)

<http://www.transaction.net/money/glossary.html>

Richard Cook also pontificates yet another solution-space in his just released 2008 book “We Hold These Truths – The Hope of Monetary Reform”. His concept, in its preliminary form, inspired by the work of the late C.H. Douglas of a century ago called Social Credit, was published in 2007 here and here. [a21] The late Dr. Edward Hamlyn at the British Association for Monetary Reform, also left the world his gift of the 2007 edition of “The New Money Text Book” which can be read here. [a22] The American Monetary Institute has their own Monetary Reform Act drafted here. [a23] The 3-1/2 hour video, The Money Masters, in its concluding last 45 minutes, also explores a rational solution-space and makes specific recommendations for national monetary reform. [a24] The video also points to an alternative local solutions-space for individual communities, that of local 'community-currency', as a sustainable money system to fulfill local trading needs debt-free. Some Europeans, apparently, tend to agree with this community-currency prescription. There already are, or will soon be, 65 regional currencies in operation alongside the EU. One of these currencies, made defunct, was based on the ideas of Silvio Gesell in the now almost century old classic, “The Natural Economic Order”: [a25]

**'Austria's Tyrolean community of Wörgl launched a scheme based on his theories, in 1932, reputed to have slashed unemployment at the height of the Depression. It was watched by Keynes and Irving Fisher, who saw a fast-depreciating currency as a possible answer to the 1930s “liquidity trap”.**

**The Wörgl experiment was declared illegal by Austria's central bank when a further 200 other communities launched copycat currencies, threatening the authority of the state. Though article 35 of the Bundesbank's founding law forbids the circulation of “quasi-**

**currencies”, the experiments are being treated as a harmless eccentricity.'**

As one can easily glean from this quick survey, there is a surfeit of monetary reform proposals. If only there was some way to bring them all together on one common platform!

Project Humanbeingsfirst encourages the readers to first endeavor to fully comprehend the problem-domain, and what entrenched systems of power inhibit all debt-free solutions from emerging, before jumping into the solutions-domain and spending time on the treadmill of inefficacy – like the antiwar movement. The failure to recognize that power only respects power, otherwise it is merely a **“focus group”**, [a26] has been the latter's undoing. This certainly does not preclude understanding the technical domain itself, including the local community needs to transact business at the individual and local business level; understanding the national needs to monetize the GDP and transact business at the national institution level, including collect taxes and pay for services; and understanding the global needs, not only for international trade, but also as a stable repository for valuation of public and private assets, both global and local, and as the calibration of a fair standard for measuring wealth in vastly disparate levels of industrial development and/or natural wealth, in rich and poor nations.

Some will surely argue that the latter needs a 'global currency'. If they were to do so, they would fall right into the trap of the banksters. The afore-cited monetary reform bibliography contains a culled selection of recent pertinent news reports which plainly betray the globalist motivation of the International bankster cartel who wish to use the present manufactured financial crisis to lead the world's gullible public to precisely that conclusion-space. To be managed centrally, by a world cartel of International private central banks, which would be the first and last nail in the national-sovereignty of all nations. **“Give me control of a nation's money supply, and I care not who makes its laws”**, was not stated in mere vanity by the Rothschild scions.

Based on the knowledge and forensic touchstones now gained, anyone capable of even a modicum of reflection should trivially be able to dismantle red herring reform proposals made by erudite scholars of empire to cleverly maneuver the world towards the masters' choice. Take for instance, this 1978 masterpiece by James Tobin, “A Proposal for Monetary Reform”, which many reform advocates now eagerly promulgate as the “Tobin tax”. [a27] It retained the international banksters' profiteering axiom of 'money as debt' quite intact, and like his learned colleagues at the Federal Reserve System routinely do, proposed some other erudite gibberish for how to green the yellowing leaves. Tobin began with the following synopsis of the problem domain in his presidential address at the 1978

conference of the Eastern Economic Association, Washington DC:

Over the last twenty years economists' prescriptions for reform of the international monetary system have taken various shapes. Their common premise was dissatisfaction with the Bretton Woods regime as it evolved in the 1950s. Robert Triffin awakened the world to the contradictions and instabilities of a system of pegged parities that relied on the debts in reserve currencies, mostly dollars, to meet growing needs for official reserves. **Triffin and his followers saw the remedy as the internationalization of reserves and reserve assets; their ultimate solution was a world central bank.** Others diagnosed the problem less in terms of liquidity than in the inadequacies of balance of payments adjustment mechanisms in the modern world. The inadequacies were especially evident under the fixed-parity gold-exchange standard when, as in the 1960s, the reserve currency center was structurally in chronic deficit. These analysts sought better and more symmetrical "rules of the game" for adjustments by surplus and deficit countries, usually including more flexibility in the setting of exchange parities, crawling pegs, and the like. **Many economists, of whom Milton Friedman was an eloquent and persuasive spokesman, had all along advocated floating exchange rates, determined in private markets without official interventions.**

Thus notice that in the above description of the problem domain, not a single mention, by anyone, of money coined by private central banks as a national debt from which they directly profit, like many a blood sucking leach. **The conversation begins, very conveniently, posing an entirely different problem, as the key problem for monetary reform!** Is this scribe the only one who sees such ab initio obfuscation by the super learned, which, by its very design, cleverly circumscribes the entire discourse space, and hence masks the real problem and its effective solution?

Tobin continues:

By the early 1970s the third view was the dominant one in the economics profession, though not among central bankers and private financiers. And all of a sudden, thanks to Nixon and Connally, we got our wish. ... **Clearly, flexible rates have not been the panacea which their more extravagant advocates had hoped; international monetary problems have not disappeared from headlines or from the agenda of anxieties of central banks and governments.**

So the “*exchange rate regime*” wasn't the right problem to have solved for in the first place, as Tobin sheepishly observes from empirical results, for the problems persisted in the headlines then, and obviously still do today. The solution identified was in-ef-ficacious for the disease, because it obviously did not address the root cause of the real disease. And this is essentially what Tobin is confessing to, that it was the wrong medicine for a poorly diagnosed disease:

**I believe that the basic problem today is not the exchange rate regime, whether fixed or floating. Debate on the regime evades and obscures the essential problem.**

Okay, so let's see what is the new “*essential problem*” which Tobin identifies:

That is the excessive international-or better, inter-currency-mobility of private financial capital.

So the fundamental problem for monetary reform is now identified as “*currency mobility*”:

Under either exchange rate regime the currency exchanges transmit disturbances originating in international financial markets. ... Specifically the mobility of financial capital limits viable differences among national interest rates and thus severely restricts the ability of central banks and governments to pursue monetary and fiscal policies appropriate to their internal economies.

Notice the error of obfuscation, of central banks are lumped with the government, and treated as benevolent entities operating in the best interest of the peoples just as governments are supposed to. With that as the unquestioned axiom, Tobin makes the accurate observation:

Likewise speculation on exchange rates, whether its consequences are vast shifts of official assets and debts or large movements of exchange rates themselves, have serious and frequently painful real internal economic consequences. Domestic policies are relatively powerless to escape them or offset them.

And then comes up with the wonderful solution space for this newly identified problem:

**There are two ways to go. One is toward a common currency, common monetary and fiscal policy, and economic integration.** The other is

toward greater financial segmentation between nations or currency areas, permitting their central banks and governments greater autonomy in policies tailored to their specific economic institutions and objectives. **The first direction, however appealing, is clearly not a viable option in the foreseeable future, i.e., the twentieth century. I therefore regretfully recommend the second, and my proposal is to throw some sand in the wheels of our excessively efficient international money markets.**

And to his great regret, that he can't immediately have world government of the central bankers as his first preferred solution, Tobin throws "*some sand in the wheels of our excessively efficient international money markets*"! He formulates both the problem, and its solution thusly:

At present the world enjoys many benefits of the increased worldwide economic integration of the last thirty years. But the integration is partial and unbalanced; in particular private financial markets have become internationalized much more rapidly and completely than other economic and political institutions. That is why we are in trouble. So I turn to the second, and second best, way out, forcing some segmentation of inter-currency financial markets.

Great – and that "*forcing some segmentation of inter-currency financial markets*" is his famed 'Tobin Tax', which many would-be monetary reformers now carry upon their own proud backs as the greatest invention since sliced bread! It is not un-interesting to observe that Tobin's language of "*economic integration, "one world" ideal, [of] a common currency, national financial and capital markets, and a single national monetary policy*", almost mirrors that of David Rockefeller. And surely, his 'Tobin Tax' may well be a solution to some problem, but certainly not the most significant one which plagues all mankind – the spectre of debt-slavery!

This is, qualitatively, exactly equivalent to the mainstream focussing on the stated legitimacy of the 'war on terror' – for the suicide bombers are indeed a grotesque and observable reality – and axiomatically assuming that those going after them are the good guys doing so in self-defense! The famous dissent-stream only disagreeing to the extent that yes, these 'terrorists' are real, but it's "blowback", and that we should not be using this for "imperial mobilization"! But neither entertaining the thought that perhaps the threat of suicide bombings is being deliberately manufactured, and in order to make the threats appear credible and non-immanent, the bombings planned into existence! [a28]



After all, who did not see the planes crash into the tall buildings on television? Thus, keeping the first axiom of 911 – 'Bin Laden's invasion from abroad' – naturally intact, or unexamined, or deflected as “*endless controversy, [which] just gets in the way of dealing with the immediate situation*”, all kinds of artificial discourse space, and its concomitant inefficacious solutions, are opened up for energetic debate in society. Being part of the same world-game, economists too conjure up their pet solutions keeping the sacred-cow axioms unquestioned, and then use the resulting failures and/or expected reactions as rationale for pushing their preferred overarching agenda. Tobin openly regretted in 1978 that the time wasn't ripe for pushing his “one world” agenda all the way home just yet:

Perhaps it is true that establishing a common currency and a central macro-economic policy will automatically generate the institutions, markets, and mobilities which make the system viable and its regional economic consequences everywhere tolerable. The risk is one that few are prepared to take. Moreover, EEC experience to date suggests that it is very hard to contrive a scenario of gradual evolution towards such a radically different regime, even though it could well be the global optimum.

Time has indeed been made ripe today, another thirty years further into the machinations for world government from when James Tobin wrote that! And that same overarching agenda – which Norman Dodd revealed, which Tobin confirmed, and which even Allen W. Dulles, the founding father of the CIA and its longest running Director, lamented in 1946 would require “***time - a long time - will be needed before world government is politically feasible***” – is now being pushed with the most forceful vigor by all the banksters and their minions [a29].

How much more confirmation does one need before the pig-headed men and women of substance – the much lauded persons of the arts, sciences, and the letters – will recognize what's staring one blatantly in the face? It is a calculated conspiracy which sees no price as too burdensome, no war as too onerous, and no extermination as too unsightly, for creating world government!

It is also very convenient for the learned to mix up the 'highest order bit' with 'lower order bits' of a complex matter – irrespective of deliberately or inadvertently – for the plebes can hardly tell the difference. And that's just wonderful for creating clever red herrings when the latter are emphasized, and the former is ignored! Surely whatever one comes up with is always a solution to something, and that's just as undeniable as any pathetic tautology. But is it a solution to the 'most significant bit'? Has the problem itself been accurately diagnosed, and the systemic multi-lateral illness accurately mapped out to its very DNA?

Not when the sacred-cow axioms remain untouchable! And this is indeed how one wins a Nobel Prize and lucrative appointments. [a30] In some cases, even stays alive.

To explain the commonsense concept of 'bit' drawn from electrical engineering, it's like having a "one" in the 7th decimal place, and also in the 2nd decimal place, to create the total amount One million and Ten dollars, \$1,000,010, and while auditing the books, focussing on the digit position which identifies the Ten dollars and not the one which identifies the Million! The significance of this is not lost to the banksters!

With that detailed analysis as the backdrop to warn the unwary mind of the unlimited methods at the disposal of a highly intellectual ruling elite which predominantly runs its affairs using political science 101, not good intentions 101, it is also important to emphasize that one monetary system does not necessarily fit all challenges, nor meet the needs of all nations.

Some nations are more agrarian, struggling with even the basics of daily existential necessities, and some are already in the post industrialization travails borne of superfluity and rape of poorer nations. Cultural sensitivities and social mores also make one size fit all an anathema to those peoples who don't always measure all that they value in dollars and cents!

But one basic principle of money does fit them all, and no nation's public is ever against it:

**Power to coin a nation's money, and to manage its money supply, thus availability of credit to borrowers, must not be put in the for-profit interest-bearing indenting hands of private individuals and their banking institutions regardless of how kindly and benevolent their claimed motives, how great their claimed expertise, or how compelling the expediency.**

And yet, despite such a common principle uniting all the detractors of aggregated wealth and proponents of monetary reform, both their detailed analysis of the problems, as well as their proposed system-solutions, often suffers from their jumbled philosophies which almost act like 'religion'. That's partially because it is indeed 'religion' and passion for justice which drives the detractors, not business motives for personal gain, as it does their antagonists who little care for the purity, or lack thereof, of their fleecing system, and only remain focused on how to keep their befuddled flock in perpetual debt. The bankers therefore, apart from their enormous power and wealth, hold a practical and expedient advantage over the 'malcontents' who are seeped in idealism, and often with empty pockets.

Furthermore, all such proponents of a new monetary system even do not pursue a proper system design discipline. They invariably link their design to an imagined economic system of their preference, and none is able to perceive that one is a mechanism, the other is policy. Many economic policies, even full blown economic systems as diverse as socialism, to real free-market capitalism with winner take all, and every social balance in between, should be efficiently constructible on a properly architected monetary system mechanism which operates in the public interest. To understand the real challenges, please see “Monetary Reform: Who will bell the cat?” and this response to the petition in “Open Letter to G-20”.

Therefore, it is unsurprising that some propose platitudes as solutions, forgetting that the Ten Commandments and the Golden Rule are at least 3000 years old but have made little impact on the real world of avarice and plunder. These include proposals for radical transformations as if revolutions are just around the corner. Some propose solutions which merely favor the private central-bankers themselves, knowingly or unwittingly is immaterial. Many of these are almost always cosmetic bandaids. These also include partial solutions that leave the core problems intact. “Religion” is most apparent in these arguments. An example of this is the gold standard, or the gold-equivalence standard pushed upon the world by the dominant victor of World War II at Bretton Woods. The “religion” in this case is protecting the asset holders against inflation at all cost.

A memorable oration in history on this “religious” discourse already exists. It was made by William Jennings Bryan over a century ago. [a31] The principles still remain the same, even as they were the same under which the English forced the gold standard upon the colonies to bring the prosperous colonies back from coining their own money called 'colonial scrip', into the fold of debt enslavement to the British empire which monopolized the gold. [a32] This speech is worthy of review by any student, and proponent, of a gold backed standard. Project Humanbeingsfirst has taken its first analytic look at the idea of a limited 'precious commodity' backing a national currency, in “Monetary Reform: First Look at the Gold Standard”.

In the ability to tell the nuanced differences therein, among outright BS, partial asininity born of misconceptions, idealism, and usefulness at different application hierarchies, lies the key that can practicably and immediately unlock the world from the debt shackles of the perpetual monetary conspiracy for world government. Coming together on one single point of focus, debt-free coining of money by a government, and single-mindedly driving that focus to the point of its political acceptance – as fait accompli – and leaving the design of the actual monetary system under that guiding principle to a transparent body chartered by the government, or Congress, as a public process, is the only sensible approach. Indeed,

the only practical reform approach that will ever work.

But as those given to even a modicum of realism well understand, rectification of injustices is only possible either with the mighty hand of the victor's justice, or under the astute gamesmanship of balance of power. In this case, political power to affect legal solutions at all levels. Never on its own, regardless of the soundness of the platitudes or the solutions.

To build such a balance of power today that might be effective, does not seem to be in the capability arsenal of those proposing monetary reform solutions. A largely powerless peoples who cannot even fund one single economics think-tank of national consequence, and one single financial political action group of influence, never mind mustering the kind of lobbying-power before which powerful Congress persons and local law-makers, mayors, state governors, attorney generals, and newspaper editorialists might bow their head.

Realistically, I see no impact by monetary reformers at the national or international level. **For it is but a truism that those who control purse strings, control nations' destinies – the real golden rule on earth, as old as mankind!** To confiscate their purse-strings – as easy as a stroke of pen – is a revolutionary act for which there is no “Jesus” today to cleanse the Congress of the moneychangers. The Wall Street bailout with the new crown of thorns, and which the US Treasury Secretary Hank Paulson [a33] is now brazenly attempting to extend to crucify all of mankind upon the new cross of a global monetary system, is proof-sufficient.

Finally, not wishing to end on the afore-stated pessimistic note as in the original version of this report, Project Humanbeingsfirst's position is the one principally reflected in the political-science notion of countering power with power and not platitudes, and principles of hegemony with principles for liberty, not ego nor preference for a particular “religion”. The first loss of sovereignty of a nation, is the loss of controlling its money. The founding fathers of the United States of America understood that principle just as well as the founders of empire from time immemorial – as evidenced in this excerpt from an oped which appeared in the Times of London: [a34]

“If this mischievous financial policy, which has its origin in North America, shall become endured down to a fixture, then that Government will furnish its own money without cost. It will pay off debts and be without debt. It will have all the money necessary to carry on its commerce. It will become prosperous without precedent in the history of the world. The brains, and wealth of all countries will go to North America. That country must be destroyed or it will destroy every monarchy on the globe.”

It entirely sums up Project Humanbeingsfirst's antithetical axiom adopted as its rallying cry for abolishing the Federal Reserve System – the power of private central banking – forcefully reclaiming, for all nations and all peoples, what President Lincoln had noted: [a35]

“The Government should create, issue, and circulate all the currency and credit needed to satisfy the spending power of the Government and the buying power of the consumers.”

“The privilege of creating and issuing money is not only the supreme prerogative of Government, but it is the Government's greatest creative opportunity.”

“By the adoption of these principles ... the taxpayers will be saved immense sums of interest. Money will cease to be master and become the servant of humanity.”

## Footnotes

[a1] Zahir Ebrahim, Monetary Reform Bibliography, <http://print-humanbeingsfirst.blogspot.com/2008/10/monetary-reform-bibliography.html>

[a2] Stephen Lendman, The Financial Meltdown: This Time Is Different, October 22, 2008 <http://www.globalresearch.ca/index.php?context=va&aid=10647>

[a3] Warren Buffett, BERKSHIRE HATHAWAY INC. 2002 Annual Report, pages 13-15: *“Derivatives are financial weapons of mass destruction, carrying dangers that, while now latent, are potentially lethal”, and, “We view them as time bombs, both for the parties that deal in them and the economic system”*  
<http://www.berkshirehathaway.com/2002ar/2002ar.pdf>

[a4] Zahir Ebrahim, Monetary Reform: Who will bell the cat?, <http://humanbeingsfirst.blogspot.com/2008/10/monetary-reform-who-will-bell-thecat.html>

[a5] Raphael Eitan, quoted in: Former Israeli army chief drowns, BBC News, Nov. 23, 2004, *“When we have settled the land, all the Arabs will be able to do about it will be to scurry around like drugged cockroaches in a bottle.”*  
[http://news.bbc.co.uk/1/hi/world/middle\\_east/4034765.stm](http://news.bbc.co.uk/1/hi/world/middle_east/4034765.stm)

[a6] Norman Dodd, Testimony on Regionalism, September 26, 1978. Transcript of Public Hearing – Joint Committee on Regional Government – September 26, 1978, Edwardsville, Illinois, Norman Dodd – pgs 51-61 <http://www.sweetliberty.org/issues/regionalism/dodd.htm>

[a7] Zahir Ebrahim, Monetary Reform: Who will bell the cat?,  
<http://humanbeingsfirst.blogspot.com/2008/10/monetary-reform-who-will-bell-thecat.html>

[a8] Zahir Ebrahim, Open Letter to Hon. Ron Paul Supporters October 29, 2008 <http://print-humanbeingsfirst.blogspot.com/2008/10/open-letter-to-ronpaul-supporters.html>

[a9] Zahir Ebrahim, Letter to Noam Chomsky on Steven Jones seminal paper on the destruction of WTC towers, April 21, 2008  
<http://humanbeingsfirst.blogspot.com/2008/04/letter-noamchomsky-jones-paper.html>

[a10] Noam Chomsky, putting out his pathetic “911” Seven Stories Press booklet to tote his broken horn of “blowback” and state sponsored terrorism immediately after 9/11, retaining all the core-axioms seeded by the Pentagon and the White House, not to mention making a ton of money on it at the expense of devastated civilizations, has left this scribe intellectually standing quite alone to fend for himself, without any priests! See Noam Chomsky, Closet Capitalist, by Peter Schweizer, Hoover Institution, <http://www.hoover.org/publications/digest/2912626.html> who quotes Chomsky: *“If you look at the things I write—articles for Z Magazine, or books for South End Press, or whatever—they are mostly based on talks and meetings and that kind of thing. But I’m kind of a parasite. I mean, I’m living off the activism of others. I’m happy to do it.”* Peter Schweizer further observes: *“Chomsky’s marketing efforts shortly after September 11 give new meaning to the term war profiteer. In the days after the tragedy, he raised his speaking fee from \$9,000 to \$12,000 because he was suddenly in greater demand. He also cashed in by producing another instant book. Seven Stories Press, a small publisher, pulled together interviews conducted via e-mail that Chomsky gave in the three weeks following the attack on the Twin Towers and rushed the book to press. His controversial views were hot, particularly overseas. By early December 2001, the publisher had sold the foreign rights in 19 different languages. The book made the best-seller list in the United States, Canada, Germany, India, Italy, Japan, and New Zealand. It is safe to assume that he netted hundreds of thousands of dollars from this book alone.”*

The following video clip of Noam Chomsky's interview on CBC is also disturbing to observe, in that while he very eruditely questions the overt motivations of the 'rogue state' bombing Afghanistan as outright criminal, he leaves unquestioned, the core-axiom upon which the state sponsored terrorism itself was based – he does not question the government's narrative of 911. Just like once before, for the JFK's assassination, Chomsky did not question that official narrative either. Noam Chomsky still maintained, in his email communication as of 2008 with this scribe, that 'Bin Laden' had done 911, and he scoffs at those who might argue that the only person who couldn't have done the controlled demolition of WTC-7 on which no plane hit, is a yogi sitting on his rump in the Hindu-Kush, armed to the teeth with AK-47s, cell phones, laptops, and prayers! Nevertheless, apparently, it is acceptable to the 'rogue state' that controlled critique be permitted on its “imperialism” upon others in order to channel and manage a controlled dissent on what is already obvious to all and sundry, and to vigorously prevent dissent from being extended to

what might really interfere with its agendas and complex magic-shows such as genuinely conscionable thinking peoples correctly adding two plus two equals four and effectively mobilizing protest in millions based upon it. Protests of a few hundred thousand is merely “*focus group*”. It will remain so as long as there is an external enemy to continually scare the peoples with. Protest of ten million in major cities however, when the enemy is known to be within, an inside job, becomes “*democracy is inimical to imperial mobilization*”. Chomsky had explained 'Manufacturing Consent'. This scribe has explained 'Manufacturing Dissent' in “Weapons of Mass Deception – The Master Social Science”  
<http://humanbeingsfirst.blogspot.com/2008/06/wmd-master-social-science.html> (Part 1 of 2 CBC Interview) <http://www.youtube.com/watch?v=10rTPSSmOFw> (Part 2 of 2 CBC Interview) <http://www.youtube.com/watch?v=bieFwutoqvA>

[a11] Paul Joseph Watson, Howard Zinn: “I Don’t Care” If 9/11 Was An Inside Job, Tuesday, November 18, 2008, <http://www.prisonplanet.com/howard-zinn-i-dont-care-if-911-was-an-inside-job.html>

Transcript from video clip <http://www.youtube.com/watch?v=S-WQ5z53IW8> In response to a question by Buddy Moore, Independent Candidate for US Senate from Colorado, Howard Zinn stated: “*Of course as I told you, I never believe the government, or rarely believe the government. Do I believe the government version of what happened? Well, I am skeptical. Do I believe that the government was in the conspiracy to do this? I don't know. I don't know enough about the situation, and the truth is, I don't care that much. That's past. ... the whole argument that the people are engaged in, about, was the government behind a conspiracy to blow up the two towers, to me that's a diversion from what we really have to do, deal with the fact that whatever, **whoever was behind 9/11, the government took advantage of that, to take us to war, and to put us on a disastrous course, and it's that war, those wars, that disastrous course we have to deal with. I don't want to go back to the controversy that I think is endless controversy, and just gets in the way of dealing with the immediate situation.***”

Howard Zinn not dealing with the first-cause enabler of “imperial mobilization” lends automatic endorsement to the government's axiomatic propagandistic lie, that there is an external enemy. And it is precisely that propaganda which keeps the fire of “doctrinal motivation and intellectual commitment” lighted underneath all the wars that Howard Zinn does want to deal with! So even for pragmatically dealing with the “*immediate situation*”, directly dealing with the first-pretext cause to yank away the very fuel of “doctrinal motivation” might appear to the sound of mind to be the most efficacious and sensible course of action. Therefore, deliberately not dealing with it only lends zero efficacy to all the subsequent dissent because the existence of the enemy remains unchallenged. That's just peachy for the government, isn't it? By its more logical name, such devious support of the ruling elite's mission, might rightly be called 'Manufacturing Dissent'! So much for the intellectuals of the West – where “truth” is a commodity, like everything else.

[a12] Zahir Ebrahim, Responsibility of Intellectuals – Redux,

<http://humanbeingsfirst.blogspot.com/2007/03/responsibility-of-intellectuals-redux.html>

[a13] Noam Chomsky, in an interview with Barry Pateman at M.I.T., <http://www.youtube.com/watch?v=nO2e0DrnYg4> makes the following coldly accurate observation on deliberate attitude control being calculatingly practiced upon the public in free-societies by its ruling-elite, but then, quite inexplicably, fails to apply that same observation to his own blind acceptance of government propaganda of 'Bin Laden' did 9/11, just like his friend Howard Zinn (op. cit.), also forgetting his own decades' old moralizing proclamations on the responsibility of intellectuals **“Intellectuals are in a position to expose the lies of governments, to analyze actions according to their causes and motives and often hidden intentions.”** (Ibid.).

Transcript from video clip, 7:15 to 8:50, *“The people who understand this the best, are those who are carrying out the control of domination. In the more free societies like the United States and England, where popular struggles have won a lot of freedom over the years, and the state has limited capacity to coerce, there is a very striking, that it is precisely in those societies, that elite groups, the business world, and state managers, and so on, recognized early on, that they are going to have to develop massive methods of control of attitude and opinion, because you can't control people by force anymore. And therefore, you have to modify their consciousness, so that they don't perceive that they are living under conditions of alienation, oppression, subordination, and so on. In fact, that's what, probably a couple of trillion dollars a year are spent on this in the United States, very self-consciously, I mean from the framing of television advertisements for two-year olds, to what you are taught in graduate school economics programs. It's designed to create a kind of a consciousness of subordination, and it's also intended, specifically, and pretty consciously, to suppress normal human emotions.”* For a deconstruction of this **“you have to modify their consciousness”** paradigm to create both conformity of views among the sheep, and harmlessness of dissent among the thoughtful, see Project Humanbeingsfirst report “Weapons of Mass Deception – The Master Social Science” <http://humanbeingsfirst.blogspot.com/2008/06/wmd-master-social-science.html>

[a14] Zahir Ebrahim, The attack of 'Al-Qaeeda' and Pakistani 'loose nukes', <http://humanbeingsfirst.blogspot.com/2008/04/alqaeeda-loose-nukes-pakistan.html> and 'Bin Laden': Key enabler of “imperial mobilization” <http://humanbeingsfirst.blogspot.com/2008/04/binladen-keyenabler-nuclearattack.html>

[a15] Zahir Ebrahim, Weapons of Mass Deception – The Master Social Science, <http://humanbeingsfirst.blogspot.com/2008/06/wmd-master-social-science.html>

[a16] This scribe in his youthful years benefited greatly from the voluminous works, as well as from the courage, of both Noam Chomsky and Howard Zinn. The former taught this scribe a couple of his famous foreign policy classes at M.I.T., and the latter very kindly wrote a recommendation letter for the book “Prisoners of the Cave” to the publishers



<http://prisonersofthecave.blogspot.com/2007/04/acknowledgment.html> This scribe's humble interlocution of Noam Chomsky on matters du jour can be read at:

<http://humanbeingsfirst.blogspot.com/2007/02/test-post1.html#Z-and-Noam-Chomsky>

[a17] Noam Chomsky, quoted, op. cit. Responsibility of Intellectuals – Redux.

[a18] Noam Chomsky, Chomsky talks back: Protestors story is 'mere deceit', Letter to Editor Newton Tab, Tue Apr 24, 2007,

<http://www.wickedlocal.com/newton/opinions/x2027601628>

[a19] Noam Chomsky, on The Clash of Civilization, <http://www.youtube.com/watch?v=qT64TNho59I>

[a20] Zahir Ebrahim, No Exits on this Super-Highway!

<http://humanbeingsfirst.blogspot.com/2008/09/no-exits-on-this-super-highway.html>

[a21] Richard Cook, An Emergency Program of Monetary Reform for the United States, April 26, 2007, and, Monetary Reform and How a National Monetary System Should Work, May 11, 2007, both by globalresearch, <http://www.globalresearch.ca/index.php?context=va&aid=5615>

[a22] Edward Hamlyn, The New Money Text Book, 2007, British Association for Monetary Reform, [http://www.monetaryreform.org/moneytextbook/The\\_New\\_Money\\_Text\\_Book.pdf](http://www.monetaryreform.org/moneytextbook/The_New_Money_Text_Book.pdf)

[a23] Stephen Zarlenga, The Need for Monetary Reform, AMI, [http://www.monetary.org/need\\_for\\_monetary\\_reform.html](http://www.monetary.org/need_for_monetary_reform.html)

[a24] Money Masters: The Monetary Reform Act, <http://www.themoneymasters.com/mra.htm>

[a25] Germans get by without the euro, UK Telegraph, 18 Jan 2007

<http://www.telegraph.co.uk/finance/2802861/Germans-get-by-without-the-euro.html>

[a26] President George W. Bush, February 23, 2003, "*First of all, you know, size of protest, it's like deciding, well, I'm going to decide policy based upon a focus group.*"

<http://www.whitehouse.gov/news/releases/2003/02/20030218-1.html>

[a27] James Tobin, A Proposal for Monetary Reform, Eastern Economic Journal, July/October 1978, pp. 153-159.

<http://www.globalpolicy.org/soecon/glotax/currtax/original.htm>

[a28] Project Humanbeingsfirst, A letter to the American Peoples, May 11, 2008,

<http://humanbeingsfirst.blogspot.com/2008/05/letter-to-american-peoples.html>

[a29] News reports cited in <http://print-humanbeingsfirst.blogspot.com/2008/10/monetary->

reform-bibliography.html#Pertinent-News-Reports

[a30] Zahir Ebrahim, Monetary Reform: Who will bell the cat?,  
<http://humanbeingsfirst.blogspot.com/2008/10/monetary-reform-who-will-bell-thecat.html>

[a31] William Jennings Bryan, Cross of Gold, July 9, 1896, Speech at the Democratic National Convention in Chicago, <http://historymatters.gmu.edu/d/5354/>

[a32] The Money Masters – How International Bankers Gained Control of America, 215 minutes: <http://video.google.com/videoplay?docid=-515319560256183936>

[a33] Project Humanbeingsfirst, Press Release October 09 2008, This may be a psy-op!  
<http://pressreleases-humanbeingsfirst.blogspot.com/2008/10/pr-resp-wmr-fema-martiallaw-oct092008.html>

[a34] Times of London, oped text cited in: The Money Masters – How International Bankers Gained Control of America, 215 minutes: <http://video.google.com/videoplay?docid=-515319560256183936>

[a35] Abraham Lincoln, Ibid.

**Source URL:** <http://print-humanbeingsfirst.blogspot.com/2008/09/capitalist-conspiracy-world-government.html>

Published November 23, 2008 as Addendum to The Enduring Capitalist Conspiracy For World Government which was first published September 25, 2008.

## Appendix Financial Terrorism and Extortion Racket

### Why Bluff Martial Law?

The bailout Bill passed the House in its second vote, as predicted by Project Humanbeingsfirst that it would, just a few moments ago, 263 votes to 171. President Bush immediately signed it into law on Friday afternoon (October 03, 2008), asserting:

“By coming together on this legislation, we have acted boldly to prevent the crisis on Wall Street from becoming a crisis in communities across our country,”

This came immediately on the heels of the accurately predicted initial defeat of the bailout package by a mere loss of 12 votes (228 to 205). Project Humanbeingsfirst had observed on September 30, 2008, in its own prediction in *No Exits on this Super-Highway!*, that this was to be rectified shortly, as Wall Street has fully implemented the President's scare-mongering dire warning with real teeth!

CNN Money reported that Rep. Sue Myrick, R-N.C., stated in a statement before the vote:

“We're on the cusp of a complete catastrophic credit meltdown. There is no liquidity in the market. We are out of time. Either you believe that fact, or you don't. I do.”

I suppose I do too. This is indeed a genuine crisis. The ordinary American stands to not only lose his shirt and her skirt, but also their comfortable lifestyles, and their meager lifesavings.

But it is also a manufactured crisis. And those pushing this particular bailout solution are the same peoples who deliberately manufactured the crisis. And subsequently, deliberately manipulated and shrunk the money and credit available to the public to substantiate the scare-mongering pressure that was being applied by their “insiders” in Congress.

Thus the same constituencies who had earlier called in to urge a NO vote on the Bill, may very well have called in to urge a YES revised vote. Only data available later will reveal the success of this Edward Bernays style public psyop – whether a majority of Congress persons changed their votes only due to the “insiders” gun to their head, or whether they

also had a face-saving rescue from their constituencies getting scared off by Wall Street action. The banks have sufficient liquidity to lend to each other, but not to the Main Street public in the guise of being wary of bad debt, as noted by CNN Money:

*“For the past two weeks, lending between banks and between banks and businesses has gotten considerably more expensive. Small businesses are having trouble getting loans. As of midday Friday, one key measure showed that banks were hoarding cash rather than loaning it. Meanwhile, an indicator showing how willing banks are to lend each other was at an all-time high.”*

It wasn't just happenstance, or simply the capitalist greed gone wild, that precipitated this crisis as many rational contrarians have asserted. It was a creed entirely of a different sort. This addendum to the report “No Exits on this Super-Highway!” explains it.

The fear-mongering that many Congressmen in their House Floor-Speeches had alluded to, including the explicit threat of Martial Law in America noted by Representative Brad Sherman, D-CA, and Martial Law already instituted in Congress to squelch debate and due process as alluded to by Representative Michael Burgess, R-Texas, really cemented the signing of this Bill today.

Under these circumstance, Grand Theft America has been initiated.

Project Humanbeingsfirst wrote a letter to the United States Congress yesterday, on October 02, 2008, suggesting to open a second more powerful front to disarm them. The letter stated:

'If at least one of you in your House speeches being televised on C-Span, will assert the falsity of the very basis upon which Martial Law in Congress has been enacted, and due to which, you are being compelled to vote and pass this audacious graft upon the nation in the closing hours of this Presidency, you may have a fighting chance to really be fair to your oath of office.

Assert the plain truth that the “war on terror” is a fiction! That the enemy is fabricated.

And therefore, the emergency and war-footings basis upon which the Martial Law has been declared in the House, is fictitious.

And therefore, you, as the Representative of the People, revolt against this fiction being forced upon you as it is preventing you from upholding your own oath of office to protect and serve the nation against all enemies, both foreign, and domestic!

By astutely challenging, as fraudulent and malfeasant, the very first principle upon which the Congress has been continually co-opted by this Administration in its Constitutional due processes and deliberations, you have the fighting chance of preventing a second vote on this banksters' bailout Bill in the House.

If this bill is voted upon now in the House, you can take it to the vaults that the bill will pass!

If that second front had been opened by any Congress persons, it would have been tantamount to slaughtering the most sacred holy cow of America in its own highest temple. With media paying rapt attention, it would have surely postponed the voting.

It is Project Humanbeingsfirst's thesis that the threat to impose Martial Law was merely a bluff, and the uncourageous Congress blinked. It matters not what the tyrants do – for they shall do whatever they will – the good guys are supposed to follow their principles in guiding their own actions regardless, especially when they are even sworn to uphold a national obligation.

Besides, if it was the right time to impose Martial Law in the country, it would have surely been enacted without issuing blackmailing threats. All the preparations for such military policing of America have been in the works for a very long time, with a battle hardened military Brigade even getting ready to patrol the main streets USA starting October 01, 2008, as already reported by the Army Times. The threat of Martial Law has existed since 911 when the US government declared itself on war footings. But it hasn't been declared yet.

Therefore, the following question logically surfaces. If the eventual goal of the oligarchs is world government (see "The Enduring Capitalist Conspiracy For World Government"), and if the baby-step in that direction is to cement the North American Union and the creation of a new currency called Amero, and the way to reach that stage is through manufactured crises which would demand Martial Law as the only bailout solution, why was it not done during this present crisis when Martial Law was only threatened for passing this bailout Bill? Why not simply enact it in America – the 3rd Infantry Division's 1st Brigade Combat Team

is already at hand.

The answer is really simple – one cannot take the cake out of the oven before it is fully baked.

Or, to whip another cliché into frenzy, one cannot expect the soufflé to rise without beating it to death first!

That is the point – the NAU cannot be cemented so long as the United States, as a powerful entity, still retains scope for independence of action, and its peoples, still feeling empowered, and not fully shackled in the state of hopelessness. For no American, no matter how indoctrinated, will willingly agree to give up their beloved America and form a weird union with Mexico and Canada. Good natured and peaceable people in this country really love their nation like no other peoples on earth. For them, both country and nation mean only one thing, America. And they will fight back in normal times. Therefore, their will to fight has to be eliminated first. The independence, of the peoples, and the state, has to be whittled down, baby-steps at a time, towards complete disillusionment. A condition not dissimilar to the nation's state in the aftermath of the 1929 crash. Indeed, on the eve of Roosevelt's inauguration, the banking oligarchs had shut down all the banks in the country to paralyze the new President. Had the New Deal not existed, a fascist state in America – as was transpiring all over Europe – en-route to world government surely might have.

Thus notice, the consolidations that have occurred during the present crisis towards the creation of even greater financial combines than those previously existing, while saddling the nation and its peoples in a new debt-trap that actually has no upper bound. But that is still not sufficient to initiate Martial Law today. The soufflé hasn't risen sufficiently!

The approval of the \$700 Billion bailout package is really the first down payment. This bailout Act, the new law of the land, has deliberate wording which is quite interesting when viewed in the light of an open commitment on the part of Congress to keep adding additional monies to the rescue plan. The bailout expense can rise to trillions of dollars – and that would be the time when the cake is fully baked!

Columnist Ben Stein describes the magnitude of the depths one can potentially fall, in his September 22, 2008 article calling it “**the pit of loss is bottomless.**” And we haven't quite reached that pit yet.

Investigative journalist and author Webster Tarpley, in his long missive on “**Main Street Lending Facilitys**” earlier today, October 03, 2008, called it “**a black hole of hundreds of trillions of dollars of poisonous derivatives.**”

Tarpley suggests that the total world derivatives are now between:

“\$1 QUADRILLION (i.e., one thousand trillion) and \$1.5 quadrillion, and Wall Street represents the lion's share of this ... A year ago, JP Morgan Chase alone officially had \$93 TRILLION in derivatives of certain types more than six times the total Gross Domestic Product of the United States, and this is a very low-ball estimate indeed.”

I don't know where these numbers are from, apart from his own admitted guesstimates, but they seem oddly consistent with the notion of “**bottomless**”. Tarpley goes on to make the qualitative statement based on what had transpired during similar bailout attempts between 1929-1933, before the onset of the New Deal:

“No money that is put into Wall Street [for bailout] will ever pass through it to benefit anyone else. The Wall Street derivatives black hole is so powerful that it could easily eat the whole earth and the entire solar system, and still be just as bankrupt as it was to start with.”

## The Bailout is in Trillions of Dollars

**Edmund L. Andrews, U.S. Details \$800 Billion Loan Plans, NYT, November 25, 2008,**

[http://www.nytimes.com/2008/11/26/business/economy/26fed.html?\\_r=1&th=&emc=th&pagewanted=all](http://www.nytimes.com/2008/11/26/business/economy/26fed.html?_r=1&th=&emc=th&pagewanted=all) , also page A1, Nov 26, 2008 New York Edition. **“The Federal Reserve and the Treasury announced \$800 billion in new lending programs on Tuesday, sending a message that they would print as much money as needed to revive the nation’s crippled banking system. ... The Treasury secretary, Henry M. Paulson Jr., made it clear that the new lending facility was just a "starting point" and could be expanded to many other kinds of debt, like commercial mortgage-backed securities.”**



To appreciate the crafty spin “*some investments may prove profitable*” – **loans \$1.7 trillion, Investments \$3.0 trillion, Guarantees \$3.1 trillion** – see essay by George J. W. Goodman for historical context, in order to understand, apart from the astronomical unpayable debt, the hyper-inflationary direction where this solution to the manufactured financial crisis is headed as the premeditated game-plan to crash the dollar enroute to a new currency and a new union, to be presented as the most natural-solution at that time: '[The German Hyperinflation, 1923](#)'

[Annotation added November 26, 2008]



**Mark Pittman and Bob Ivry, U.S. Pledges Top \$7.7 Trillion to Ease Frozen Credit (Update3), Bloomberg News, November 24, 2008 16:59 EST,**  
<http://www.bloomberg.com/apps/news?pid=newsarchive&sid=a5PxZ0NcDI4o>

**“The U.S. government is prepared to provide more than \$7.76 trillion on behalf of American taxpayers after guaranteeing \$306 billion of Citigroup Inc. debt yesterday.** The pledges, amounting to half the value of everything produced in the nation last year, are intended to rescue the financial system after the credit markets seized up 15 months ago. The unprecedented pledge of funds includes \$3.2 trillion already tapped by financial institutions in the biggest response to an economic emergency since the New Deal of the 1930s, according to data compiled by Bloomberg. **The commitment dwarfs the plan approved by lawmakers, the Treasury Department’s \$700 billion Troubled Asset Relief Program.** Federal Reserve lending last week was 1,900 times the weekly average for the three years before the crisis. When Congress approved the TARP on Oct. 3, Fed Chairman Ben S. Bernanke and Treasury Secretary Henry Paulson acknowledged the need for transparency and oversight. Now, as regulators commit far more money while refusing to disclose loan recipients or reveal the collateral they are taking in return, some Congress members are calling for the Fed to be reined in. ... **“Whether it’s lending or spending, it’s tax dollars that are going out the window and we end up holding collateral we don’t know anything about,”** said Congressman Scott Garrett, a New Jersey Republican who serves on the House Financial Services Committee. **“The time has come that we consider what sort of limitations we should be placing on the Fed so that authority returns to elected officials as opposed to appointed ones.”** ... The bailout includes a Fed program to buy as much as \$2.4 trillion in short-term notes, called commercial paper, ... Most of the spending programs are run out of the New York Fed, whose president, Timothy Geithner, is said to be President-elect Barack Obama’s choice to be Treasury Secretary. ... **The money that’s been pledged is equivalent to \$24,000 for every man, woman and child in the country.** It’s nine times what the U.S. has spent so far on wars in Iraq and Afghanistan, according to Congressional Budget Office figures. It could pay off more than half the country’s mortgages. ... **“Some have asked us to reveal the names of the banks that are borrowing, how much they are borrowing, what collateral they are posting,”** Bernanke said Nov. 18 to the House Financial Services Committee. **“We think that’s counterproductive.”**

The previous “WMD” mantra was manufactured to decimate the lesser humanity outside the shores of the United States in its external quest for “*imperial mobilization*”. Yes, they did feel the pain. The other side of the game, the domestic front, also needed a manufactured WMD – and this is what Warren Buffet called it: “**Weapons of financial Mass Destruction**”.

Yes, Americans shall also feel the pain. Not quite as excruciating, mercifully, as the Iraqis, the Palestinians, the Lebanese, the Afghanis, or as the Pakistanis are beginning to feel now – all for the pleasure of inducing the “*Birth-pangs of a New Middle East*”. This pain has meant very little to the “United we stand” clueless up until now. And the key question to ask is, why make these clueless suffer? Didn't they dutifully salute the flag?

And if America is out to dominate the world in its quest for “*full spectrum dominance*”, why destroy its own infrastructures such that its own civil engineers would give its state of disrepair a D grade? Doesn't Brzezinski's “**The Grand Chessboard**” explain it all as:

“perpetuat[ing] America's own dominant position for at least a generation and preferably longer” such that “no Eurasian challenger emerges, capable of dominating Eurasia and thus also challenging America”?

I suppose serious peoples would also have to read Brzezinski's 1970 classic “**Between Two Ages**” in order to comprehend the real hidden agenda driving America's “*imperial mobilization*” which remains un-articulated in 'the Grand Chessboard' and in PNAC's policy advocacy for American militarism. These are not end-goals, these are camouflaged baby-steps.

The real principle is that which led bankster David Rockefeller – the self-avowed globalist whose family funded the founding of the United Nations building in New York, and who supports and finances the Council on Foreign Relations (CFR) which is now advocating the North American Union – to create the Trilateral Commission, and install Zbigniew Brzezinski as its first Executive Director, after supposedly reading Brzezinski's book!

The sole superpower's might is being harnessed to usher in the systematic baby-steps to world government by America's blood-sucking hijackers: the financial oligarchs who have ruled America from behind the scenes for the past hundred years. Indeed, some argue that their brethren across the Atlantic rule all the European democracies, and especially the G-7 nations (Russia mercifully finally escaped from their clutches under Vladimir Putin).

The hand of Rockefeller and other globalist banksters is not only behind the CFR – the private foreign policy planning arm of the United States Government – but also his banks

largely dominate the New York Fed. The Federal Reserve System, also simply called the Fed, is the privatized money supply arm of the United States Government, controlled by 12 of the largest private banks in the United States. There is as much federal about the Fed as Fedx.

Thus, note that both United States policy, and United States money, have the same oligarchs controlling them! What a remarkable realization of Rothschild's statement:

**“give me control of a nation's money supply, and I care not who makes its laws”**

And what an ominously prescient statement of both James Madison and Thomas Jefferson:

“History records that the Money Changers have used every form of abuse, intrigue, deceit and violent means possible to maintain their control over governments by controlling money and its issuance.” (Madison)

“I sincerely believe that banking institutions are more dangerous to our liberties than standing armies. Already they have raised up a money aristocracy that has set the government at defiance. The issuing power should be taken from the banks and restored to the people to whom it properly belongs.” (Jefferson)

The creation of the Fed was the most brilliant success of the oligarchs in their hijacking of America. They orchestrated the approval for its creation by Congress in 1913 under dubious circumstances at best. In reality, it was an outright subversion of due process. That one single Act of Congress in 1913, enabled the subsequent conquest of America by these bankster oligarchs. G. Edward Griffin's book [“The Creature from Jekyll Island”](#) details it all most thoroughly. And Professor Carroll Quigley's book [“Tragedy and Hope”](#) describes the rest of America's hijacking based on his full access to insider documents. The interested reader is directed to these seminal works for more in depth study. Those un-attuned to scholarly readings may find Paul Grignon's [“Money as Debt”](#), a fast-paced 47-minute animated video tutorial, of invaluable assistance in learning about money and the Fed in less time than watching two episodes of Friends. This remarkable tutorial for all ages, is also available on [google](#) but please purchase the dvd to support its [incredible creator](#). And for those still skeptical of CFR's grooming role in America's statesmen who subsequently enact its policies, see the confessional 1958 article in Harper magazine for an introduction to CFR written by one of its own members, titled: [“School for Statesmen”](#).

Suffice it to assert here in conclusion of this summary background on the role of common

oligarchic threads behind America's present financial as well as its foreign policy crises which has deliberately orchestrated its spiraling debt, that the behind the scenes control and manipulation of State destinies is not mere theory, philosophy, or false bravados. It is neither mere happenstance, nor vacuous greed for more money, nor blowback. It is the pursuit of the singular common vision already explained in "The Enduring Capitalist Conspiracy For World Government". Even the famous and much revered British historian, Arnold Toynbee, who along with Lord Alfred Milner had founded the "Round Tables" in the early years of the twentieth century which had subsequently led to the founding of the CFR in the United States, and the RIIA in the UK, asserted it. In a speech before the Institute for the Study of International Affairs at Copenhagen, he stated:

"We are at present working discreetly with all our might to wrest this mysterious force called sovereignty out of the clutches of the local nation states of the world. All the time we are denying with our lips what we are doing with our hands, because to impugn the sovereignty of the local nation states of the world is still a heresy for which a statesman or publicist can perhaps not quite be burned at the stake but certainly be ostracized or discredited." [Arnold Toynbee, "The Trend of International Affairs Since the War", International Affairs, November 1931, p. 809.]

And today, his equally earnest legatees influencing both the CFR and the Fed, state the same thing:

"We are on the verge of a global transformation. All we need is the right major crisis and the nations will accept the New World Order." [David Rockefeller – cited in "Quotation on Terrorism", page 298]

And this friendly Fed is the same private entity that is now working in cahoots with the U.S. Government's Treasury Department to manage this crisis. Between the two, they orchestrated this bailout by forcibly prevailing upon Congress once again.

Well, one might ask, isn't the Treasury Secretary independent? How can the Fed influence them? Yes, the Treasury Secretary is indeed very powerful, and quite independent. But only in so far as his role within the United State's Government is concerned. The Secretary works for the same oligarchic interests in an incredible revolving door between the finance sector and the U.S. Government. Even a passing glance at Treasury Secretary Henry Paulson's resume, i.e., work history, makes that obvious.

The NAU is inevitable. It is the CFR's orchestration, and the globalist oligarchs wet dreams.

The conditions for it are being rapidly created. And this bailout which further puts the United States in a position to default on its currency, to default on its trillions of dollars in debt servicing to other nations, is the set up.

This crisis, a baby-step in that direction, has been deliberately manufactured by the Bush Administration in collusion with Wall Street, for precisely the outcome which transpired today.

Here is some evidence for it.

Former NY Governor Eliot Spitzer revealed it in his Washington Post article of February 14, 2008, titled **“Predatory Lenders’ Partner in Crime - How the Bush Administration Stopped the States From Stepping In to Help Consumers”**, and because of which, he was dethroned with a scandal. He had warned of almost 8 months ago:

“When history tells the story of the subprime lending crisis and recounts its devastating effects on the lives of so many innocent homeowners, the Bush administration will not be judged favorably. The tale is still unfolding, but when the dust settles, it will be judged as a willing accomplice to the lenders who went to any lengths in their quest for profits. So willing, in fact, that it used the power of the federal government in an unprecedented assault on state legislatures, as well as on state attorneys general and anyone else on the side of consumers.”

Greg Palast followed up a month later in his article of March 14, 2008, titled **“Eliot’s Mess The \$200 billion bail-out for predator banks and Spitzer charges are intimately linked”**, adding an epilogue to Eliot’s afore-stated comment. After observing how Spitzer hath fallen in a \$4300 a night 'escort' sting operation, Palast prematurely wrote how history had been spared in its judgment of Bush Administration:

“But now, the Administration can rest assured that this love story – of Bush and his bankers - will not be told by history at all – now that the Sheriff of Wall Street has fallen on his own gun.”

Author of Grand Theft America, Steve Lendman, summed it up to this author in an email communication *“absolutely this crisis was manufactured. Problem is they created a monster that may end up devouring its creator”*.

This is where I might mildly disagree with Lendman. The monster is in “fuzzy” chains, and only allowed measured extension on its probabilistic forays. At the right moment, it will be

killed off to create the Amero, setting the stage for further financial upheaval in resource rich Asia left holding America's debt in "confederate currency". This will create conditions quite congenial with just the right sprinkling of militarism and nuclear warfare, for eventually bringing about the third union in the world government agenda. Globalism does not deal in certainties, only in probabilities, loading the dice as needed to favor the outcomes of interest. These are calculated shenanigans. The size of the problem, deliberately a mushroom cloud, like any hydrogen bomb's.

I hope Lendman is wrong. I further hope that the oligarchs have miscalculated. That humanity is far greater in its resilience to fight back tyranny than what they give us credit for. Even George Orwell could not but help allow a faint smile to appear on the weathered face of the last common man on earth in "1984". Surely a Patrick Henry is just around the corner!

While unbridled hope is perhaps the wishful thinking that leads to voluntary servitude, critical analysis is not.

All that is analyzed by Project Humanbeingsfirst, isn't peering into the Cassandra's crystal ball, or into the vibrant but immanent space of an armchair philosopher's fertile imagination.

It is political science writ large in the masterminds' own hand-writings and empirical deeds, and in the connection between disparate past events and the new emerging ones piece-meal.

And all paths rationally lead to the stated goal of world government. Some might however, still prefer to label the obvious, 'tin-hatted conspiracy theories'.

Project Humanbeingsfirst prefers to call the detective process of uncovering the secrets of "**hegemony**", forensic science. And what is uncovered, political science – an art which is "**as old as mankind.**" It was succinctly described by James Jesus Angleton, the head of CIA Counter Intelligence operations from 1954 to 1974, as: "**Deception is the state of mind, and the mind of the State.**"

This Machiavellian rendition of political science as applied to state-craft, was so timelessly captured by G. Edward Griffin four decades ago, that it behooves upon an honest analyst to rehearse it repeatedly in order to remind the dumb-ass spectating world unable to recognize it while all of us sink deeper and deeper into the clutches of its enslavement, that, that's just the way unchecked power behaves!

"Create conditions so frightful at home and abroad, that the abandonment of

personal liberties and national sovereignty, will appear as a reasonable price for a return to domestic tranquility and world peace.

... If those who seek world dominion can stimulate [terror threats, 911, new 911], and also provide exhaustive news coverage, so that the entire nation can see and tremble, then the peaceful and freedom loving majority can be programmed to accept a vast expansion of government powers, and even a national police force, offered supposedly to end the violence.

... If those who seek world dominion can raise the spectre of an enemy, [or economic condition], armed to the teeth with superior atomic weapons on the verge of launching a nuclear holocaust [radical Islamists], and also offer world-government as the prevention, then millions of Americans can be programmed to accept the loss of national sovereignty, as our last best hope for peace.” ( Words of G. Edward Griffin circa 1971-72 )

In conclusion, if FDR's New Deal had worked then, it is not entirely obvious why it should not work again. [1] [2]

It is even less obvious why the courageous members of the United States Congress did not unite along bipartisan lines in the best interest of their beloved nation, to construct a New Deal as their counter group proposal. And instead, willingly chose to show their cowardice before the tyranny of the few. If the tyrants threaten Martial Law – let them follow through, for it would be forcing their hand prematurely towards something they plan on doing anyway. A soufflé before it has risen is worthless!

Thanks for reading. If this essay was useful, please write your Congress person to not fear tyranny – that you are with them. Six feet under, the maggots can't tell the difference anyway!

## Footnotes

[1] After that sentence was written, which was based on the populist understanding of what FDR had supposedly accomplished in the New Deal, through actual research into the facts of the matter however, it has now become blatantly apparent why it would not work again. FDR at the time had capitulated to the banksters – some say he was in fact the banksters own very clever pointman – and changed America's money which was previously redeemable in gold, into fiat paper money, with the passing of The Emergency Banking Act, March 9, 1933. All the gold of the American peoples was

confiscated, and in effect, handed over to the Federal Reserve System in lieu of an infinite supply of paper money constructed as a national debt. **The principal of this national debt was never intended to be ever paid back – it was setup as an infinite inflationary supply source.** However, the interest on it was to accrue exponentially – compound-interest – and this interest was payable by the American peoples, the consumers, the corporations, and all economic activity in the United States. In addition, making the US dollar world's reserve currency at Bretton-Woods by the victor of World War II, made increasing that principal a global impetus from the entire world's economic activity. Every US Treasury Security held by the oil producing nations courtesy of Henry Kissinger, every dollar held in foreign exchange reserves by the world's nations, indeed every dollar in circulation, contributed to this principal! Every dollar added to the principal that was beyond the growth of the American nation's real GDP – based on real production and not financial wizardry – was inflationary. Thus all economic activity due to debt financing, as opposed to balanced budget financing, was by design, made inflationary.

The word “inflationary” means when a dollar purchases less than it did before, or the same thing costs more than it did before. However it's official measurement also has become a con-game, and therefore, that word here is used to mean the real empirical experience of real wage-earning consumers who are the most susceptible to inflation (and who, incidentally, also pay the bulk of the interest on the national debt through their federal income tax), and not official reportage based on some artificial basket of goods. More the American worker made, more he paid out in taxes and in rising cost of living, so that he and she ended up with less and less in working families with even both parents working! Thus American public took on more and more debt, sometimes to make ends meet, and sometimes to enjoy the good times that were easily handed them on the platter of inextricable debt. And so the monster of debt fed itself. This wasn't just a side-effect as almost all the economists and politicians would have the ill-informed public believe, but by the very design of the monetary system under the Federal Reserve System.

That was quite a brilliant coup d'état under the guise of solving the problem of the Great Depression by the banksters! The same banksters funded the causes, and all participants, of World War II, just as they precipitated the Great Depression itself. It was a banksters' World War, and a banksters' Great Depression! And a banksters' currency that kept creating more and more debt by design. Their 'small' calculated baby-step to create world government led to more millions dead and disillusioned than all wars of all history added together. Just as it is re-playing out the same game today, but much closer to endgame. Since the year 1933 was only the beginning of the paper money



scam – this incarnation of the central bankers' perpetual scam since time immemorial, actually began in 1910 at Jekyll Island, and got cemented with the passage of the Federal Reserve Act on December 23, 1913 – the cumulative national debt then was low, the interest payments were low, **and the Frankenstein was just a cute baby boy. Therefore, President Roosevelt could trivially embark on his debt-financed spending spree which became known as the New Deal.** See the debt-chart from 1900 to 2006 in the book by Van K Tharp [here](#), and current national debt numbers proudly reported by the U.S. Treasury [here](#). **Today, such a spending spree is not possible in the existing monetary system because the Frankenstein of debt has now matured into an ugly monster about to devour its feeders.** And yet, such a spending spree is still generously being granted to the banksters to the tune of \$7.7 Trillion for bailout, as reported by Bloomberg on [November 24, 2008](#)! The New York Times further broke this number down in its report of [November 25, 2008](#) – loans \$1.7 trillion, Investments \$3.0 trillion, Guarantees \$3.1 trillion – noting ***“they would print as much money as needed to revive the nation’s crippled banking system ... some investments may prove profitable ... The Treasury secretary, Henry M. Paulson Jr., made it clear that the new lending facility was just a “starting point” and could be expanded to many other kinds of debt,”***

To appreciate how the sheep are craftily being primed for the slaughter, see George J. W. Goodman's essay '[The German Hyperinflation, 1923](#)' for historical context. Apart from the astronomical unpayable debt deliberately being run up, the hyper-inflationary direction where the Treasury secretary is steering the nation and the world with this 'solution' to the manufactured financial crisis, is in plain sight. This was a brilliantly orchestrated design, because the cure for this now fully grown grotesque Frankenstein – in order that it not devour its own creators – is being presented as a common global monetary system run by private central banks, owned by the very same banksters! And by making the dollar worthless – when a wheelbarrow full of dollars will barely purchase a loaf of bread – the 'United We Stand' from 'sea to shinning sea' patriotic masses will willingly accept a new currency, a new union, a new world order! A crafty and audacious planning of a hundred years expertly being brought to fruition! Please see the [Monetary Reform Bibliography](#), and [Monetary Conspiracy for World Government](#). The unfortunate populist version of FDR's New Deal is deeply entrenched in American society – like all its other indoctrinations – and it is even more exacerbated by polished disinformation documentaries like “1932” (see [LaRouche: A nuanced and expert Disinformationist or merely Uber Alles?](#) ). **And the whole shebang of the Federal Reserve System is very cleverly camouflaged, and confounded, by its learned exponents and detractors alike** (see [Monetary Reform: Who will bell the cat?](#) and also Chapter 6 of Ron Paul's

book: Revolution; caveat lector on Ron Paul [here!](#)).

[2] Gerald Celente of Trends Research Institute similarly explains why any traditional New Deal would also not work again:

“We are going to go into a depression worse than the Great Depression, and here is why. There is a way to get out of this but not through fiscal or monetary stimulus. If we have an alternative energy break-through, beyond solar ..... that's as big as the discovery of fire or the invention of the wheel then we get out of this economic mess. Minus that, we are going to go into the greatest depression, and here is why:

1. Back when we had the last depression, most people didn't own homes, they didn't have all this burden that're carrying now, with taxes and everything else, insurance.
2. Back then, people didn't have home equity loans. Matter of fact, you know we are probably both old enough to know when people had something called second mortgages, they were called losers.
3. Back then, people didn't have credit cards. They weren't over 14 trillion dollars in debt.
4. Back then, the government had a trade surplus. We were not 700 billion dollars in the hole. And the people were self-sufficient.
5. Back then, the government was not spending 11.5 trillion in growing in the hole with a budget deficit.
6. Back then, we had budget surpluses.
7. Back then, we weren't costing us over 2 trillion dollars to fight wars.
8. Back then, we had a manufacturing base, that when the depression did end with the onset of WW II, we were able to manufacture ourselves out of it, and then later on the rest of the world.
9. Back then, people didn't have 401Ks and IRAs that were their future, evaporating right before them.

And the other thing people need to know was during the Depression, you could do some of these work-project things that they talk about. We didn't have these deficits that we

have now. So to keep talking about stimulus packages, to keep talking about work-project packages, where is this money going to come from? And again, as every historian or economist knows, the only thing that got us out of that Depression, was WW II." ( Gerald Celente, Trends Research, November 17, 2008, Alex Jones Show )

Source URL: <http://print-humanbeingsfirst.blogspot.com/2008/10/why-bluff-martial-law.html>

First Published October 03, 2008

Footnotes: [1] Added December 04, 2008; [2] Added February 05 2009

## Chapter 22 Not Fooled Again: Reformers pitching Gold Standard

### Monetary Reform: First Look at the Gold Standard

This is Project Humanbeingsfirst's first look at the key issues inherent in the Gold Standard as the backing commodity for national and international currency. It is being advocated by Hon. Congressman Ron Paul of Texas ('The Revolution – A Manifesto', Chapter-6 "Money The Forbidden Issue in American Politics"). He is inspired by the Ludwig von Mises Institute (<http://mises.org/>) which represents the libertarian political and economic thinking of the Austrian School of Economics. That in turn, in this scribe's opinion, can be elegantly captured in a nutshell by the British economist E. F. Schumacher's Buddhist paradigm of "*Man is small, and, therefore, small is beautiful*". Mises Institute primarily features the work of Ludwig von Mises ('Human Action – A Treatise on Economics') where Mises notes: "*Economics deals with society's fundamental problems; it concerns everyone and belongs to all. It is the main and proper study of every citizen*". Mises Institute also features the work of his student, Murray N. Rothbard ('What Has Government Done to Our Money?'), who notes: "*On the free market, everyone earns according to his productive value in satisfying consumer desires. Under statist distribution, everyone earns in proportion to the amount he can plunder from the producers.*"

Ron Paul is evidently inspired by these 'Small Is Beautiful' decentralization principles of sustainable economics, sustainable government, sustainable development, and the importance and responsibility of man for his own decision-making and welfare, as opposed to centralized institutional planning and impersonal decision-making [1]. Who would not like such 'manly' "*Tim the Toolman Taylor*" empowerment? As the iconic macho-man Governor of California, Arnold Schwarzenegger, might have said in some movie – only the "girlie man"!

However, there surely must also be, somewhere in its verbiage, an implied balance and harmony in this Buddhist doctrine of governmental non-interventionism. The extreme at either end is of course, only bounded by total anarchy on the one side, and total collectivism on the other, as correctly observed by G. Edward Griffin (<http://realityzone.com>). Both extremes can have undesirable characteristics. The

communist style centralized planning and control is a well known collectivist extreme – and apparently the world today is indeed headed towards that characteristics with a global police state in the offing and a global central banking under construction which will usher in a global currency managed by private International banksters.

Whereas, complete deregulation and privatization (in for-profit hands) of public commons which are held in trust for all peoples, is the other extreme. As is blatantly apparent, the world today is also simultaneously headed in that direction too with neo-liberalism. The twain meet in the corporate boardrooms controlled by the same gluttonous hands on Wall Street whose principal share holders are usually the opaque “institutional investors”. It would perhaps only shock the most naïve to learn that the largest of these “institutional investors” is the sole superpower on earth, the United States of America Corporation, at all levels: local, state, and federal. See the *Comprehensive Annual Financial Report (CAFR)* that is produced by each of these governmental bodies and public agencies (a public report which the public and its mainstream news media have evidently never heard about, see <http://CAFR1.com> ).

And it is noteworthy for privatization impetus that as a non-predatory socio-economics system design principle, when there is an infinite demand for something, and the very life of every man and every woman may depend on its availability, holding it as a social benefit, in public trust, is the mark of wisdom; whereas privatizing it in unaccountable gluttonous hands a mark of predatory social Darwinianism. All reformers can surely agree that a nation's monetary system falls into this category, of a public commons, to be managed in trust, by their government, for the common good of all its peoples. This is all the more true for a non-predatory international monetary system which ought to sensibly be held in global trust as a global public commons.

That is the one key central platform upon which all monetary reformers are united, and have always remain united throughout history. It forms one continuous resistance against aggregated wealth holders who have hijacked control of any nation's money supply.

This resistance is profoundly historical, and even today, brings to bear its entire weight of all historical arguments made against private monopolistic control of a nation's money – from Julius Caesar to Cicero to Thomas Jefferson to Andrew Jackson to Abraham Lincoln to William Jennings Bryan. The latter being the last of the great challengers to private wealth holders perpetually seeking to make a precious limited commodity like gold the standard currency, before the devilish orchestration in 1913, of the present day private banking cartel of the Federal Reserve System, did one better. Legally acquired exclusive private monopoly rights over the most common element, 'thin air'! [2]

Therefore, in these times, we resume that same thread of resistance – with a clearer understanding of the devil before us, and with an even greater force of cumulative arguments – right from where William Jennings Bryan left off, continuing with his own precise principled words of 1896: [3]

**“We say in our platform that we believe that the right to coin money and issue money is a function of government. We believe it.**

**We believe it is a part of sovereignty and can no more with safety be delegated to private individuals than can the power to make penal statutes or levy laws for taxation.”**

And of course, not neglecting to be inspired by America's famous “I killed the bank” President, Andrew Jackson's own motivating words: [4]

**“You are a den of vipers. I intend to rout you out, and by God, I will rout you out.”**

The presumably earnest reformers who believe in the Gold Standard, like Congressman Ron Paul and the Mises Institute, just as those who believe in Lincoln's Greenbacks or the Colonial Scrip of the American colonies, like the American Monetary Institute (<http://monetary.org>), and just as those who believe in other systems, like the 'tally sticks' of the English, or the 'Natural Economic Order' of Silvio Gesell, all equally share in this fantastically rich inheritance of principled resistance against the handful of private aggregated wealth owners squeezing the public in their beguiling lender's perpetual debt trap.

These reformers evidently only disagree in the pragmatic matter of which alternate monetary system to introduce against their common mortal enemy! And while they disunite amongst themselves as to “who's the fairest”, without a well-funded foundation backing them, an influential think-tank writing their policy papers, an effective political lobby-group pushing it to the Congress, or even a press-corps of editorial writers to their name to generate public opinion, their antagonists delight in this incapability of their rag-tag opposition to form effective coalitions on their own common grounds. The well-intentioned moral activist of modernity surely must intimately understand, beyond mindlessly parroting others, that the banking parasites have, in every epoch, very powerfully, and with much clever propaganda, attempted to gain control of this essential government function that President Lincoln called “the Government's greatest creative opportunity” [5]:

**“The Government should create, issue, and circulate all the currency**

**and credit needed to satisfy the spending power of the Government and the buying power of the consumers.**

**The privilege of creating and issuing money is not only the supreme prerogative of Government, but it is the Government's greatest creative opportunity.**

**By the adoption of these principles ... the taxpayers will be saved immense sums of interest. Money will cease to be master and become the servant of humanity.”**

Therefore, it is all the more perplexing – given such profound intellectualism and advocacy for decentralized self-sufficiency on the one hand in the Austrian School of Economics, and such a rich historical legacy of resistance against private central banks controlling a nation's money supply on the other – why the return to Gold Standard is being so 'religiously' advocated by Ron Paul and the Mises Institute which only helps fatten the same “moneychangers”!

The Gold Standard is being projected by the reformers as the sine qua non of monetary reform to get the United States, and the world, out of its misery of debt burden and the imminent danger of financial collapse. It is surely well understood by Ron Paul, given that he talks about it a lot, that the collapse would be the pretext to create from its ashes, the pre-planned supra-national state of the North American Union, and a new currency called Amero. He also well understands the agenda for a centralized world government to be controlled by a cartel of private international central banks as the top of the ruling pyramid. Such an agenda is already being pursued at an accelerated pace, and the import of time-criticalness of any effective resistance to avert such an outcome that ends the sovereignty of nation-states is surely not lost on Ron Paul. Therefore, the inability to quickly comprehend the incongruence of this path of the Gold Standard with respect to their own aims seem rather Kafkaesque. Is this really rocket science that an ordinary person cannot think it through? Not according to Ludwig von Mises:

**“Economics deals with society's fundamental problems; it concerns everyone and belongs to all. It is the main and proper study of every citizen.”**

The Gold Standard advocates seem to think that gold will magically materialize, in great abundance, in the Fort Knox secure vaults of the United States as a public property in trust. While a pocket full of gold and silver coins can be made laudable work-horses for local

trade as local currency – with perhaps a defined conversion-rate to national-currency – it does not work as a national currency in modernity. This analysis explains why. Gold's ability to insure against inflation, as well as against the inflation-tax when it is a fully-backed reserve rather than a fractional reserve, is a cleverly planted red herring. Or so it would appear, given the impracticalities of creating fairness between the wealthy asset holders who own a large stock of hard assets, and real producers who are often without such hard property assets, and mainly have the sweat of their brow, the creativity of their intellect, or the courage of their arms, as their main production asset and which remains unprotected by such protection mechanisms of the wealthy. The unexamined axiom itself, that guarding against inflation must be the paramount factor to optimize, and all other factors need to be subservient to this one dominant factor in the design of a rational and fair monetary system, needs detailed scrutiny. That axiom is not scrutinized here, but several preliminary arguments can be made to show that the axiom itself may be mis-constructed based on assumptions made, or imperatives defined, by powerful landed wealth owners.

In addition, as in any system design, whatever be its level of abstraction, there are always pragmatic tradeoffs. When one balances the entire system and looks at all the pros and cons of every aspect of any precious limited commodity based standard for a monetary system, the directions in which to make reasonable and rational tradeoffs to construct a well balanced system in the best public interest, with a rational operating envelop that is resilient to economic upheavals, become all the more clear. Only 'religion' may define absolutes without trade-off. Mercifully, heaven did not stipulate a specific monetary system, but only outlined its first-principle: don't transact in interest! A hundred viable systems can be architected with that quality. Jesus banished the “moneychangers” from the Temple in Jerusalem due to their fleecing their flock. He did not stipulate which exclusive money system to use, only what not to do. The needs of the people, and the times, determine what system to use. And William Jennings Bryan articulated that very need of the majority *“man is small, and, therefore, small is beautiful”* laboring man – which remains the same today – when he passionately orated at the 1896 Democratic National Convention:

**“Having behind us the producing masses of this nation and the world, supported by the commercial interests, the laboring interests and the toilers everywhere, we will answer their demand for a gold standard by saying to them:**

**You shall not press down upon the brow of labor this crown of thorns, you shall not crucify mankind upon a cross of gold.”**

The preliminary analysis presented here is applicable, as first-principles, for any precious



limited commodity-backed monetary standard. There is strong motivation brewing among many a 'malcontent' to take the power of coining money 'out of thin air' away from the Federal Reserve System, and to move the United States away from 'money as public debt' Hamiltonian principle. For background reading, please see the bibliographic recommendation at the end, and the afore-cited books.

And it would be entirely appropriate to begin with these most eloquent words, as they precisely capture the *raison d'être* of Project Humanbeingsfirst's motto: **“The Plebeian Antidote To Hectoring Hegemons”**:

**“I would be presumptuous, indeed, to present myself against the distinguished gentlemen to whom you have listened if this were but a measuring of ability; but this is not a contest among persons. The humblest citizen in all the land when clad in the armor of a righteous cause is stronger than all the whole hosts of error that they can bring. ... I shall object to bringing this question down to a level of persons. The individual is but an atom; he is born, he acts, he dies; but principles are eternal; and this has been a contest of principle.”** (Ibid.)

The first-principle concerns with any precious commodity based monetary standard, are three:

**1)** Gold is precious, therefore, by definition, it is limited; hence again by definition, someone has a monopoly over it. Acquiring it in sufficient quantity *ab initio* requires a priori assets that must be exchanged that is valuable to those who have this monopoly. For a State, this means hawking one's independence to the precious commodity supplier in perpetuity each time it wishes to expand its money supply beyond the reserves. Unless of course, by fiat, the State is able to confiscate that precious commodity in the name of national security or national interest.

**2)** Because the commodity is precious and limited – and even if initially acquired by whatever bootstrapping means to launch the standard, including hawking national sovereignty to bankers and institutional investors who already own a lot of gold, or confiscating gold from the public as was done by Roosevelt in 1934 – Gold cannot be used to arbitrarily expand the money supply which it backs, in order to create extremely large infusions of cash.

In post-agrarian and fully industrialized societies – such as the G-7 Western nations – setting up capital intensive mega-industries and mega-factories, and undertaking mega-

infrastructure national projects, can take billions of dollars. Even for developing nations where development cost is invariably of the same order of magnitude as the West for similar projects, if a nation does not have the equivalent amount of the precious commodity fully backing its currency, she must either make recourse to fractional-reserve banking away from the full-reserve banking just by the practicalities of the matter, and therefore, incur its concomitant baggage of inflationary-tax once again. Or the poorer nations must put automatic and entirely artificial breaks on their national growth and national wealth creation, or otherwise become borrowers again to the same cartel of banksters! Unless of course one discovers an endless monopolistic benevolent supplier, like god planting it in one's backyard and giving one enough smarts and courage to not lease it out to snake-oil salesmen who will invariably come calling on F-16s spreading the black-ops cheer blithely claiming **“Hegemony is as old as mankind”!**

Both factors 1) and 2) are a major problem for any nation adopting a limited precious commodity as a standard. But it is an even greater problem if it is forcibly created as an International standard. Then it is especially an unfair standard imposed upon disadvantaged nations who do not have that commodity in abundance, just as it is an unfair advantage for those rich nations who do have an abundance of such commodity, or can acquire it.

Based on those two first-principles, I do not like any “precious commodity” based standard that is by definition, limited.

**3)** If it is not the limitedness of such a commodity, but its abundance, and its equitable distribution among all nations can be ensured, then I have no problem whatsoever with such a commodity backed national or International monetary standard.

Since fairness, and not 'might makes right', is the quintessential first-principle touchstone axiom of any rational analysis, Congressman Ron Paul's Gold penchant suffers from both factors 1) and 2). And it also does not have 3) as a mitigating characteristic. If a touchstone other than fairness is employed, such as how to fatten the gluttonous appetite of banksters, then surely the Gold Standard is a great plan-B in case the private central banks fiat money monopoly becomes too onerous for the sensibilities of the debt-laden strangulated public.

Apart from these three first-principle factors, the many theoretical advantages of a commodity based standard, as noted by Ron Paul, seem plausible. Specifically, a fully backed commodity based standard does not create an inflationary-tax upon the public when money supply is expanded within its fully-backed reserve limit. Beyond its reserve limit, fractional reserve mechanics kick-in to artificially inflate the money-supply which

inherently creates the inflationary-tax. If one does not exceed the backing limit, money retains its value over long periods of time so long as the backing commodity retains its value. However, this necessitates the commodity be artificially protected from market capitalism, and its price not allowed to be subjected to market forces in order to retain its stability as a reliable and credible backing standard. The irony of protectionism being made the foundation of 'free-market capitalism' is surely lost to its enthusiastic advocates. But that's merely only of theoretical interest to purists, and of no practical significance to reality, since genuine free market capitalism also only exists in text books. No nation can survive its implementation, least of all, the developing and poor nations rich in natural resources surrounded by global predators forcing 'free-trade' down their throats to create banana republics for careful harvesting.

This price-fixing of gold bullion was the protectionist outcome of the Gold Equivalence Standard which President Roosevelt ushered into law in 1934, and which remained in force until 1971 when President Nixon abolished it. The Gold Equivalence Standard (GES) was not a fully backed standard, but a fractional reserve standard, and when other nations and institutional-agents demanded their gold in exchange for the dollar bill, the United States risked failure to deliver as its gold bullion reserves were not sufficient. It was the same principle as any vanilla run on banks by consumers when the banks' liquidity come into question. The GES was unilaterally abolished by the United States for fear of default when the gold reserves fell dangerously low when I believe France made its demand for gold.

In this GES, gold bullion that comprised it, was priced outside the pale of market forces, at a fixed value of about \$35 an ounce. But more disturbingly, all gold from the American public was forcibly confiscated in 1934. The public was given approx. \$18 an ounce for their life's savings, with the price being immediately revised upwards to almost twice that as the stable value of the new backing standard. This protectionist value of gold bullion was used in International money-supply transactions of the dollar which was setup as the default reserve currency of the world at Bretton Woods Conference post World War II, based on the currency of the unparalleled economic and military power of its main victor. Whereas the price of actual gold continually fluctuated on the open market across the world. Ownership of gold was also made illegal for American citizens (except for numismatists and jewelers). So large institutional multinational investors and bankers with foreign affiliations could easily purchase the gold bullion from the US Treasury in foreign names, but not United States citizens. All of American public's gold was thus made out as a gratuitous gift to the bankers by the fiat of a simple executive signature by President Roosevelt. His New Deal ushered in massive deficit spending of paper money. In his three terms in office he outspent all his predecessors combined.

There is no a priori reason to believe that the future of any new proposed Gold Standard to orchestrate another 'New Deal' – as the remedy for the next Great Depression which is already upon the world's doorsteps – does not already have a precedent-setting paved super highway to travel on. The banksters I am sure are massaging both their gullet and their stomach with joyous glee as plan-B is eagerly put before them as the public's own 'desired solution' for the economic and financial crises of the banksters' own crafty manufacturing!

Since Congressman Ron Paul does not address either 1) or 2), nor does he stipulate 3) as a mitigation, that is the Achilles heal of his as Gold Standard mantra. Mises Institute has the same considerations.

As the banksters already have a monopoly on Gold – or can soon monopolize it because they can create, by fiat, all the cash they need simply out of thin air to purchase what they don't already own – the Honorable Republican Congressman from Texas, in his well meaning enthusiasm, but also his apparent profound inability to clearly think matters through down to their core axioms (see “Open Letter to Hon. Ron Paul Supporters October 29, 2008”), makes a great patsy in their globalist conniving hands as the plan-B enabler already in-place in Congress!

If the above three factors can be satisfactorily addressed, along with practicable implementation modalities which do not impose a draconian burden upon the public as was imposed by President Roosevelt in 1934, then there is nothing inherently wrong with the Gold Standard. Clearly, that is merely a tautological statement since those very innate characteristics of Gold as a limited and precious commodity, and its hoarding in monopolistic hands, is what's wrong with the Gold Standard.

In terms of the 5 initial touchstone questions laid out in “Towards a Common Standard Benchmark for evaluating all Monetary Reform Proposals” [7], this is how Ron Paul's penchant for the Gold Standard stacks up. It is hoped that the Congressman will respond in order to clarify matters further if they are misperceived or in outright error.

**a: Central Banking in private hands charges the public perpetual compound-interest for the public's own money. Nationalizing the money creation function solves this problem of 'money as public debt'.**

Ron Paul's Gold Standard proposal, as did President Lincoln's Greenback fiat money, addresses this, by eliminating all interest on the creation of money.

**b: Private Central Bank is a legalized monopoly behavior that permits private banks to collude legally for 'price-fixing' the interest-rate. Thus it helps create the business cycle of expanding and contracting credit by modulating its availability in legal collusion – what I call the 'business rape cycle'. Bankers profit from this by buying up those businesses who can't cut it, pennies to the dollar during the bust periods which dutifully follow upon the heels of boom financing periods.**

**Nationalizing this function, by having the government manage the availability of credit, what Thomas Edison called “the proper ratio” for money supply – not too much to prevent wild speculation, and not too little to prevent stagnation – goes to a large extent in managing this 'price-fixing' of interest-rate and availability of credit in the greater common good of the public, rather than the banking cartel's now represented by the Federal Reserve System. But government management does not entirely eliminate this aspect – because the private banks can still secretly collude in managing credit availability as they have always done, since they have the same powerful handful of owners at the top!**

How does Ron Paul address “the proper ratio” [8] and its implementation for managing the money supply?

**c: A Central Bank's arbitrary money creation by fiat – whether the CB is public or private doesn't matter, and which is what Greenbacks were – creates an inflationary tax. Nothing new here.**

There is no inflationary-tax in a fully backed Gold Standard as proposed by Ron Paul.

This tax will exist however, if the GS mutates into a fractional GES and the money supply exceeds the backing gold reserves. This will happen by default as a matter of practicality, because supply of gold will always be limited in relation to the demand for capital in modern industrialized nations. Therefore, a full proposal needs to be made by the Gold Standard advocates which can be scrutinized in the light of these real-world constraints. Perhaps this is why not a single advocate of the GS fully addresses this specific point. Nor do the address where the Gold will come from to create the International reserves, and items 1) 2) and 3) noted in the analysis of the Gold Standard above. See the next item.

**d: In modern industrialized societies where the demand for capital can be enormous, far more than was prevalent in agrarian or early-developing industrialized societies, as Richard Cook, the former U.S. Treasury Department employee and now a monetary reformer, argues, how can this natural inflationary tax be avoided in such a fiat money system? In the time of the Greenbacks during the Civil War, while Lincoln printed around 400 million dollars, or some say 500, that is nothing compared to what is needed today in the capital intensive public and private mega-projects. For instance, simply to set up a class-1 semiconductor fab takes a billion+ dollars.**

How does Ron Paul's Gold Standard address this large demand for mega-capital that would not also pose an inflationary tax? Where does Ron Paul propose to get all this gold from to fully back his currency? As he has himself noted, he was the member of the Gold Commission in the 1980s, and he could not even at that time say how much of the American public's gold was left in the secure vaults of Fort Knox – the speculation being that whatever remained after Nixon abandoned the GES in 1971, was subsequently sold off to private institutional investors by the United States Treasury, and only empty vaults today are being guarded in great pretense to hide the legal heist of what most might believe was a national asset. So many questions – and no answers by the Gold advocates. Who designs a system, or advocates it, under such conditions of ambiguous and incomplete comprehension? Perhaps there is indeed a secret plan to restock Fort Knox to the ceiling with lead-gold? If that's the case, do make sure there is a bathtub handy and every shiny brick first takes a dip in it with someone reliable present to record each result!

**e: Banking itself, indeed, all of International banking, is based on fractional reserve lending. This is the real source of any banker's continuous and perpetual wealth creation, and hence the source of their unmatched and unrivaled power.**

Ron Paul's Gold Standard is fully backed at the time of money creation as a national public commons.

However, it is not clear how he addresses fractional lending at the institutional banking level as individual loans and deposits are made by borrowers.

Can Ron Paul show a practicable method, and not merely in platitudes, whereby the private capitalist banks of the world – owned by powerful trillionaires who also own the majority of lawmakers of the world not to mention in the United States Congress as just witnessed by the passage of the trillion dollar banksters bailout bill in October 2008 despite all the public opposition – can be made to agree to have a fractional reserve lending ratio of 1?

The entrenched forces of private banking are pulling in the opposite direction – towards global private central banking. How does Congressman Ron Paul along with his Gold Standard buddies plan to counter that powerful force in any efficacious measure? For an appreciation of pragmatic difficulties and time-criticalness of the matter, please see the following articles by Project Humanbeingsfirst:

- [Response to 'Sign Petition for a Monetary System That Puts People First - Open Letter to G-20'](#)
- [The entrenched notion of Public Debt in America – will take a gestalt shift to overcome! A seeding–prose for Collaboration](#)
- [Monetary Reform: Who will bell the cat?](#)
- [The Real Unhidden Agenda](#)
- [The Enduring Capitalist Conspiracy For World Government](#)

## **Bibliography**

Please see 'Monetary Reform Bibliography' for essential background reading and videos:  
<http://print-humanbeingsfirst.blogspot.com/2008/10/monetary-reform-bibliography.html>

## **Footnotes**

[1] Ron Paul, The Revolution – A Manifesto, April 2008, First Edition, Grand Central Publishing.

[2] G. Edward Griffin, The Creature from Jekyll Island – A Second Look at the Federal Reserve, June 2002, 4th edition, American Media, book  
<http://realityzone.com/crfrjeiss.html>

Audio-only of talk after the book's release, November 18, 1994 in Los Angeles CA, 71 minutes: <http://video.google.com/videoplay?docid=-8484911570371055528>

Video interview which explains the Fed, 'What is the Federal Reserve System', 42 minutes: <http://video.google.com/videoplay?docid=6507136891691870450>

[3] William Jennings Bryan, July 9, 1896, Speech at the Democratic National Convention in Chicago. <http://historymatters.gmu.edu/d/5354/>

[4] Andrew Jackson, cited in The Money Masters – How International Bankers Gained Control of America, 215 minutes: <http://video.google.com/videoplay?docid=-515319560256183936>

[5] Abraham Lincoln, Ibid.

[6] The entrenched notion of Public Debt in America – will take a gestalt shift to overcome!  
A seeding–prose for Collaboration  
<http://print-humanbeingsfirst.blogspot.com/2008/10/monetary-reform-seeding-prose.html>

[7] Towards a Common Standard Benchmark for evaluating all Monetary Reform Proposals  
<http://print-humanbeingsfirst.blogspot.com/2008/11/common-monetary-reform-benchmark.html>

Questions initially framed to respond to Ellen Hodgson Brown, before having acquired her thick book 'Web of Debt', Second Edition, February 2008, for her monetary proposal:  
Return To The Greenback Dollar <http://webofdebt.wordpress.com/monetary-proposal/>

[8] For Reference to Thomas Edison's wisdom on monetary system, see its coverage in the NYT of December 6, 1921, *"FORD SEES WEALTH IN MUSCLE SHOALS; Says Development Will Bring Great Prosperity to That Section of the South. EDISON BACKS HIM UP He Will Urge Congress to Lease It to Ford as the Logical Man to Carry Out Great Project. SUPPORTS CURRENCY PLAN Old Way, He Asserts, Compels Us to Add to the Public Debt to Increase the National Wealth."*  
<http://query.nytimes.com/gst/abstract.html?res=9C04E0D7103EEE3ABC4E53DFB467838A639EDE>

**Source URL:** <http://print-humanbeingsfirst.blogspot.com/2008/11/monetary-reform-firstlook-gold-standard.html>



First Published November 13, 2008

## Addendum: News Epilogue

**G7 sets sights on 'new world economic order'**, Roland Lloyd Parry, Agence France-Press, Saturday, February 14 2009, 11:36 am ET

'ROME (AFP) – The world's richest nations called Saturday for urgent reform of global finance to save the world from the economic devastation that is dragging more and more countries into recession. **Italy's Finance Minister called for a "new world economic order" as he wrapped up the crisis meeting of finance leaders from the Group of Seven leading economies over which he presided here.** In a joint declaration, the G7 called for "urgent reforms" of the international financial system. ... **"A new world economic order might seem rhetorical," he told reporters. "But it is a true goal we should be aiming towards... today right here in Rome we've embarked on a very significant journey, both technical and ethical."** ... The global crisis "has highlighted fundamental weaknesses in the international financial system and that urgent reforms are needed," the statement said. US Treasury Secretary Timothy Geithner vowed that his country, the biggest economy in the world and the source of much of the financial drama in recent months, would work with other nations for a consensus on reforms. **"We need to begin the process of comprehensive reform of our financial system and the international financial system, so the world never again faces a crisis this severe," Geithner said after the talks.** Dominique Strauss-Kahn, head of the International Monetary Fund (IMF) -- the body coming to the rescue of some crisis-hit countries -- said restructuring banks damaged by the credit crunch was the main problem facing governments. ... The document hailed stimulus actions taken by other countries, singling out China which it also praised for its "continued commitment to move to a more flexible exchange rate." ' [1]

The New World Economic Order as the fundamental building block of a despotic world government is really pretty much a fait accompli. Being an ostrich doesn't really serve any function because arsonists have taken over all the fire brigades in town, and in every town and city. The hyperinflation of the dollar is an irreversible done deal. The following [Glenn Beck video](#) [2] from FOX News graphically shows the official United States debt, which is

the same as the amount of U.S. currency in existence. See it by each decade from 1900 to 2006 in [Van K. Tharp](#). [3]

This isn't even the tip of the iceberg however of what has deliberately been orchestrated by the financial houses in New York. The quadrillion+ dollar (1000 trillion dollars) derivatives paper-debt that nobody can exactly quantify nor fully comprehend – a mirage, a contrived and manufactured financial gibberish paper con-game calculatingly instrumented by the very arsonists who are now clamoring to lead the fire-brigade to save the world – is what is being referred to here: ***“We need to begin the process of comprehensive reform of our financial system and the international financial system, so the world never again faces a crisis this severe”***. And their solution is: ***“A new world economic order”***.

Meanwhile, the arsonists are crashing the dollar in the guise of fighting that lighted fire by the various open-ended deficit spending Bills in trillions, as the new mantra of “stimulus”. This includes payout of billions for overpriced bank bailouts – up to 10 and 20 times the asset value – in the name of shoring up the equity side of the equation since, as the financiers argue, nothing may now be done about the astronomical liability side of the equation incurred by the derivatives bubble. How convenient! See [The Bank Swindle in Perspective](#) [4] in order to appreciate the complex looting of the public treasury in legal guise, sanctioned by the mighty United States Congress, and then forced across the world as the only solution to the financial crisis. To acutely comprehend why the “stimulus” is just another mantra, a Rand/CFR joint production like the “WMD in Iraq” and “Al Qaeda” mantras, see [“Mr. Obama's New Deal”](#). [5] As Captain Rhett Butler had shrewdly observed in Margaret Mitchell's famous novel:

***“Oh, yes! What most people don't seem to realize is that there is just as much money to be made out of the wreckage of a civilization as from the upbuilding of one.”*** -- Gone With The Wind

Soon the arsonists will go back to Congress and lament: *'oops!, the stimulus didn't work; sorry, the dollar is now worthless, we are in the middle of the worst depression known to mankind, there are riots everywhere, food shortages everywhere, global warming is gonna cause floods, Osama bin Laden has unleashed a bio-terror nuclear attack; so we need to create a new economic union, a new full spectrum mutual defense union, and a new world order Constitution for the American continent to protect our peoples and address the global threats'*.

That baby-step solution for the collapsed dollar will be the North American Union under a common central bank. It has been under subversive instrumentation as part of the

Trilateralists' agenda for as long as the European Union, and will be just as rapidly deployed with an iron fist despite similar popular public opposition, because, **“World government could only be kept in being by force”**. Understand Glenn Beck's and Bill O'Reilly's mocking-chutzpah and facile double entendres displayed in the [video clip](#) in [“Why Not Be An Ostrich”](#). [6]

And the most fruitful realization of Captain Rhett Butler's swashbuckling truism is yet to come, the profiting **“from the upbuilding”** of civilization: the new Gold Standard which will be pitched with Congressman Ron Paul's help as the panacea demanded by the peoples. Since all the world's gold bullion supply, and the world's gold mines, are already under monopoly control of the same arsonists, no problem.

In the New Economic World Order, with global central banks – themselves controlled from behind the scenes by the same handful of private family banks owned by the Rothschilds, the Rockefellers – managing the world's merged global monetary system as well as all the world's political governments in a global governance architecture, it won't be a problem returning to the Gold Standard.

All the fine gold will have to be purchased from the same private international banksters in order to back the trillions in new common currency issued for transacting the entire world's commerce. How convenient once again!

The new monetary system will be happily made inflation averse amidst cheers from the foolish goyem of the world. The new gold based standard after all, does have to protect the enormous wealth of the private banksters from inflationary-erosion in a largely serf-world of the New World Order, wherein, the only real asset owners are the banks. The new financial empire also has to be stable enough to last a millennium! Can't have inflation eroding away all its loot as it did moms and pops meager assets and life savings in the twentieth century. Why indeed the Gold Standard will now make perfect sense for the banksters and the handful of real wealth owners of the world, was so passionately explained over a hundred years ago by [William Jennings Bryan](#), [7] that it is best refreshed in the goy's mind directly from the horse's mouth. The contorted dialectical brilliance of the devilish banksters is truly unsurpassed!

When my friends routinely inform me in pious excuse for their own voluntary servitude: *“god is running the world”*, and I retort back: *“seems like it's the devil who is”*, they think I am heretical. I say, poor poor god, the most blamed scapegoat ever! And what an amazing coup d'état of the devil: it puts mankind in eternal bondage in every new generation, and calmly cements the voluntary servitude of its hope-dwellers with fantastic divine dogmas of

karma, fate, destiny, and prophecy! None rise too frequently to overthrow the tyrants! But sometimes, they do!

The solution to the international banksters 'servicing' their 'dumb goy' is so straightforward even today that if any political leaders really wanted to take genuine salvaging action – if the fire brigades across the world weren't already staffed with arsonists – they could so trivially do it with a mere signature that there will be no further updates to the Monetary Reform Bibliography.

It now appears rather pointless to repeatedly flog a dead horse with each new proclamation from the pulpits and the ditches. Many a 'psychohistorian' has already foreseen the not so un-subtle future and already laid it all out. Instead, perhaps it is time to dust out Henry David Thoreau and nail the only dreaded wrinkle in the final 'Hari Seldon' plan for a millenium of servitude.

### Footnotes

[1] [http://news.yahoo.com/s/afp/20090214/bs\\_afp/financeeconomyg7](http://news.yahoo.com/s/afp/20090214/bs_afp/financeeconomyg7) Also see: [http://rawstory.com/news/2008/G7\\_sets\\_sights\\_on\\_new\\_world\\_0214.html](http://rawstory.com/news/2008/G7_sets_sights_on_new_world_0214.html)

[2] <http://www.youtube.com/watch?v=3DPfKxOQGHU>

[3] Van K. Tharp, 2006, Pg. 158, Figure 6.1 <http://books.google.com/books?id=Q6XnsJRb7QwC&pg=PA158&lpg=PA157&ots=T60ZNJrqry>

[4] <http://www.chartingstocks.net/2009/02/the-bank-swindle-putting-it-in-perspective/>

[5] <http://print-humanbeingsfirst.blogspot.com/2008/12/obamas-new-deal-dec012008.html>

[6] <http://humanbeingsfirst.blogspot.com/2009/02/why-not-be-anostrich-feb132009.html>

[7] <http://historymatters.gmu.edu/d/5354/>

**Source URL:** <http://print-humanbeingsfirst.blogspot.com/2008/10/monetary-reform-bibliography.html>

News Epilogue Published in the Monetary Reform Bibliography on Sunday, February 15, 2009 at 02:26 am

## **Addendum: Confirmation of Prediction on Gold Standard**

The self-explanatory Reuter's headline of November 08, 2010 reads: **World Bank chief surprises with gold standard idea**

<http://uk.reuters.com/article/idUKTRE6A70D720101108> ([cached PDF](#))

<http://www.google.com/search?q=The+G20+must+look+beyond+Bretton+Woods+II>

<http://dailybail.com/home/world-bank-chief-calls-for-return-to-gold-standard.html>

## **Chapter 23 Not Fooled Again: World Bank pitching Gold Standard**

### **Letter to Monetary Reformers Bill Still, G. Edward Griffin, Ellen Hodgson Brown**

**Subject: World Bank chief surprises with gold standard idea**

**Date: Tue, Nov 9, 2010 at 4:54 PM**

**From: Zahir Ebrahim, Project Humanbeingsfirst.org**

Dear Bill Still, G. Edward Griffin, Ellen Brown,

You have no doubt heard the news noted in the subject line [1], and it was rather disingenuously couched as "surprise". It wasn't surprise to me as I had already predicted it two years ago. Please see pages 6 and 7 in the updated letter to Bill Still, PDF is attached for your convenience. [2]

One thing that should be obvious to all rational peoples is that the banksters only make proposals and seek solutions which are in their own elite's best interests. Therefore, it follows that these proposals can't be in the interest of the ordinary peoples. Therefore, to support the banksters' proposal is to side with them. Therefore, if the banksters now want the Gold Standard back, it must not be good for the people.

Therefore, this is an opportunity to make deep alliances among the small community of monetary reform exponents who push different solutions. The way to make these alliances is to rather than speak in monologues, as I seem to be doing, and rather than to make videos and write books in the hope that people will automatically agree with one, that we need to construct dialog, first and foremost amongst ourselves.

I am an ordinary unknown person, not an elite, and as an ordinary plebe taking a moral public stand on important issues which concern us all, I feel a need to construct a communication bridge among the experts who seem to be very energetically talking past each other and not listening to the common man – exactly as the elite whom they are out to reform, do!

The Gold Standard is a specious argument. I can convince anyone of it who is honest and not politically inclined. Fiat money is not always bad – depends on who controls its issue and its quantity, just like Bill Still says. I can convince anyone of that too – and with far more logic than either Ben Bernanke or Paul Krugman, fellow co-alums of MIT, can bring to bear. I may not understand what the experts claim they know, but I have discovered that most mainstream experts are full of it. Here is a letter to MIT Professor and former IMF Chief Economist, Simon Johnson – if you can find a flaw in my argument, I hope you will deconstruct it for me as my teachers:

<http://print-humanbeingsfirst.blogspot.com/2010/03/lett-simonjohnson-mit-imf-zahirebrahim.html>

And yet, I cannot seem to be able to convince any expert in the discontent-space that their own arguments for reform are merely platitudes, as old as hegemony, and as old as mankind. To make their arguments of reform is to merely speak in platitudes. It is the implementation strategies which are lacking in most of the talk by monetary reform experts. The HOW. This is fleshed out in my letter to Bill Still whose PDF is attached.

I am convinced if we can't convince the three distinguished persons that I am humbly writing to, to all come to a common page of overarching understanding of all pertinent issues at a very deep level, deeper than is visible in either Bill's documentary which is entirely platitudinous, and in Ellen Brown's and Griffin's writings which entirely ignore the battle with entrenched power and its vile incantations, that we might as well throw in the towel. The closest I think anyone has come to the HOW is Mr. Griffin. He has made a very insightful observation: if you can't beat city hall, become city hall. That is a very long term multi-generational solution-space and there is no time for it.

The cusp of transformation can cut both ways. Where our antagonists see their opportunities in crises to promote their enslaving solutions, we too have an opportunity to create alliances to think of Archimedes levers to counter the steam engine of full spectrum dominance of humanity that is under construction.

There is a lot in common between all monetary reformers. What is uncommon needs to be coherently, and not emotionally, analyzed and non-superficial alliances constructed. I loved the scene in Bill's documentary where it references Oz and how all the mice got together to carry the lion out. Ellen Brown has a clip in that video explaining it beautifully, and I argue that let such coming together begin at home before you can dream of going out in larger society of mice!

Thank you in advance for your time. You have all been my teachers and I am grateful for your work. Unless we go the next step, we are playing a stuck needle on a 77.

Best wishes,

Zahir Ebrahim

Project Humanbeingsfirst.org

California,

### **Footnotes**

[1] The Reuter's headline of Nov. 08, 2010 reads: **World Bank chief surprises with gold standard idea**

<http://uk.reuters.com/article/idUKTRE6A70D720101108> (cached PDF)

<http://www.google.com/search?q=The+G20+must+look+beyond+Bretton+Woods+II>

<http://dailybail.com/home/world-bank-chief-calls-for-return-to-gold-standard.html>

[2] <http://humanbeingsfirst.files.wordpress.com/2010/11/letter-to-billstill-secret-of-oz-how-oct052010d.pdf>

**Source URL:** <http://humanbeingsfirst.files.wordpress.com/2011/03/zahir-ebrahims-letter-to-still-griffin-and-brown-world-bank-chief-surprises-with-gold-standard-idea-nov-9-2010.pdf>

---

## **Letter to Bill Still – Director of The Secret of Oz – How?**

**Subject: Thanks for the excellent documentaries**

**Date: Tuesday, Oct 5, 2010**



**From: Zahir Ebrahim, Project Humanbeingsfirst.org**

Dear Mr. Still,

I am writing this thank you note with a question that I would like to put before you.

But first, please permit me to say that I owe you an immense debt of gratitude for getting me on to the trail of the nature of money. Your Money Masters documentary was among the many stepping stones for me for comprehending something I never learnt in the macro economics class at MIT (where I majored in EECS), nor from any dissent classes on US foreign policy that I took with Noam Chomsky almost three decades ago, and nor in any of the papers I have read from Ben Bernanke and Paul Krugman, both alums of MIT. I have since invited others to watch your revealing documentary with their own families. And yesterday I came across your new video and watched for about 30 minutes. Haven't got to the interesting part of OZ yet...

My humble question to monetary reform advocates continues to remain about the HOW of the reform, and not the WHY or the WHAT. That question was once again put to the American Monetary Institute's Mr. Zarlenga for his 2010 conference and I quote the relevant passages from it putting the same question to you:

The HOW to pursue reform given the all pervasive oligarchic rule with its unstoppable impetus for world government – a rule which hides behind the mask of elected peoples' representatives who in turn afford it legal cover, permit it to hide its vast wealth in tax-exempt foundations with which it formulates and enacts into law its preferred policies, underwrites social and scientific research in its preferred direction, and molds public opinion with its vast ownership of the news media and the myth-making infotainment industry – is the core unanswered reform challenge for plebeians rising to disaffirm and disarm the oligarchic rule.

Without the pursuit of the HOW in the face of these ground realities, the monetary reform agenda will continue to remain stillborn, a platitudinous run on the treadmill of inefficacy, just as it has been for the past 100 years.

These oligarchs are not about to roll-over and play dead while their power to play god is taken away by their own errand boys in Congress. And there is no “Jesus” today who can cleanse the House of the influence of the Money Changers. The bullet to JFK's head, inter alia for his Executive Order EO 11110\*, sent a message loud and clear.

What activity we see in Congress from the likes of Dr. Ron Paul, [1] I have come to believe is at best a "Limited Hangout". [2] And by way of analysis, I have independently reached exactly the same conclusion on the Gold Standard/any commodity backed standard as you. The warning in your video is so timely that it inspired me to compose a re-visit to this issue with my prior writings which also features your video:

<http://humanbeingsfirst.wordpress.com/2010/10/05/re-visiting-money-as-debt-and-monetary-reform-the-secret-of-oz/>

I hope you can provide some insights into the implementation of good things when the system is entirely run **by way of deception** on behalf of powers so powerful today that really, even a Jesus may be stumped how to throw them out except through a revolution. We are hurtling down the yellow brick road of perpetual servitude, not accidentally, not by happenstance, but calculated to culminate in Global Governance, [3] at immense speed. This report indicates it might get cemented by 2025: [http://www.foia.cia.gov/2025/2025\\_Global\\_Governance.pdf](http://www.foia.cia.gov/2025/2025_Global_Governance.pdf).

As an additional realitycheck on the immense forces of the financial oligarchs that must be overturned in order to have any genuine monetary reform, I draw your kind attention to the outstanding exposition by Thomas Edison that was reported in the New York Times in its special edition of December 6, 1921. I am sure you are already familiar with it, but please permit me to quote the headlines and the principal argument which remains unsurpassed in its logic (and which supports your Jeffersonian concept of reform): **"FORD SEES WEALTH IN MUSCLE SHOALS; Says Development Will Bring Great Prosperity to That Section of the South. EDISON BACKS HIM UP He Will Urge Congress to Lease It to Ford as the Logical Man to Carry Out Great Project. SUPPORTS CURRENCY PLAN Old Way, He Asserts, Compels Us to Add to the Public Debt to Increase the National Wealth."**

'But here is the point: If our nation can issue a dollar bond, it can issue a dollar bill. The element that makes the bond good makes the bill good, also. The difference between the bond and the bill is that the bond lets the money brokers collect twice the amount of the bond and an additional 20 per cent., whereas the currency pays nobody but those who directly contribute to Muscle Shoals in some useful way. ...

It is absurd to say that our country can issue \$30,000,000 in bonds and not \$30,000,000 in currency. Both are promises to pay; but one promise fattens the usurers, and the other helps the people. If the currency issued by the Government were no good, then the bonds issued would be no good either.

It is a terrible situation when the Government, to increase national wealth, must go into debt, and submit to ruinous interest at the hands of men ...

Look at it another way. If the Government issues the bonds, the brokers will sell them. The bonds will be negotiable; they will be considered as gilt-edged paper. Why? Because the Government is behind them, but what is behind the Government? The people. Therefore it is the people who constitute the basis of Government credit. Why then cannot the people have the benefit of their own gilt-edged credit by receiving non-interest bearing currency on Muscle Shoals, instead of bankers receiving the benefit of the people's credit in interest-bearing bonds?

The people must pay any way; why should they be compelled to pay twice, as the bond system compels them to pay? The people of the United States always accept their Government's currency. If the United States Government will adopt this policy of increasing its national wealth without contributing to the interest collector – for the whole national debt is made up of interest charges – then you will see an era of progress and prosperity in this country such as could never have come otherwise.'

And I humbly invite reflection on the practical fact of the matter that: when Thomas Edison with his rational eloquence and global prestige, combined with the industrial muscle and name of Henry Ford – America's two greatest real wealth creators who were also admired by the American public of the time – could not politically out-wit the bankster oligarchy in those very early days when the power of the Fed was still in its infancy; when the financial oligarchy's control of the narrative, the media, and the academe had not become as absolute as it is today; when public debate was still so open that even the New York Times would deem it fit to print; etc., whether it is so pragmatic to bank on the good sense and bold courage of the American legislature when we have just seen the entire Representative System of America buckle under the threat of Martial Law as recently as October 2008 [4] despite overwhelming support from the public to reject the bankster bailout Bill? [5]

With best regards,

Zahir Ebrahim

### **Footnotes**

\* As some researchers suggest. I added this perspective footnote after writing this letter to

Bill Still since he noted in one of his correspondence replies that for him it was inaccurate to link JFK's murder to the EO 11110. I told him that to dwell on that specific narrow point would be a red herring for my question, and that if he disagreed, he should simply ignore that point. I would like to elaborate in this footnote on my take on EO 11110 for the benefit of the reader. G. Edward Griffin too has elsewhere given his opinion on EO 11110 and holds the view that an examination of its wording does not indicate any challenge to the central bank of the United States or to the financial oligarchy. I have examined it.

As with anything else related to JFK's murder, it is hard to prove or disprove any specific reason for his killing due to the "plausible deniability" [6] doctrine of NSC 10/2.

Furthermore, the administrative language of statecraft minimally requires an insider's working knowledge to fully parse what things really mean. Words of statecraft don't necessarily mean what lay persons think they might mean. And, under the cloak of deception, as in Machiavellian statecraft, they even have layered meanings which only the concerned participants accurately comprehend. Sort of like *steganography*. See for instance excerpts from Col. Fletcher Prouty's *Secret Team* in the Mighty Wurlitzer [7] for an example of calculated deception. The verbiage of EO 11110 remain incomprehensible to lay persons who do not have the larger context despite the superfluity of their "informed" opinions. Thus I personally remain agnostic on it.

Secondly, Fletcher Prouty showed in The Guns of Dallas [8] that unarguably, as gleaned from all the omissions, stand-down orders must have been forced upon the president's Protection Team. Its similarities to the stand-down of the American military on 9/11 is uncanny. Prouty correctly asked who had that kind of power over the Secret Service to overrule their standard operating practices?

Lastly, James Douglass in COPA 2009 itemized several unforgivable sins against the elite from his book *JFK and the Unspeakable*, quoting JFK as saying that he might get three "*Bay of pigs*" strikes before he might be put-down by a coup. Douglass counted many more!

A disobedient American president simply can't survive his own war-mongering national security state – which is why, the overall system of governance in America always goes along with the oligarchic agendas and the nation goes from wars to wars every decade. The power they wield upon all branches of the Federal, State, and Local governments simply cannot be resisted by its officers today anymore than it could be resisted by President Woodrow Wilson a hundred years ago when he approved the Fed Reserve Act in 1913. it is easier to be co-opted than to resist. It's permitted to write it all in one's memoir ex

post facto of course!

To pretend that any new crop of green recruits into Congress will magically turn against the very golem upon whose goodwill they survive in the first place is simply being Pollyanish. And to hypothesize that an uncompromising murderous Savior like Old Hickory Jackson will magically turn up and who, while eliminating all the new 'untermenschen' from this land, will also "*kill the bank*", well, I come from the land where most everyone is awaiting some savior. But we don't look forward to mass murderers bailing us out! Bill Still's pertinent response to my HOW question is reproduced below.

It is evident that Bill Still has no HOW solution. Which unfortunately also means he has no solution to offer but platitudes.

As for his particular WHAT solution, of the government taking over the issuing of debt-free fiat money like President Lincoln did, I am solution agnostic at this point unless it is severely flawed, and Bill's concept isn't. In fact, theoretically it is very sound. Its weakness is in that it relies on careful and watchful implementation – any great idea can be crippled by poor implementation. On the other hand, the gold standard idea suffers from mainly one core-flaw, and if that is eliminated, it can also be made to work. That flaw is that most of the world's gold bullion, and its gold mines, and its precious and semi-precious minerals, are all owned by the same golem. Those pitching the gold standard must also condition their proposal to the nationalization of private gold bullion reserves and private gold mines and putting them in trust under the government which will issue the currency that it will back.

Without such nationalization of the gold reserves, the gold standard is a solution deceptively proposed by the banksters' own agents, assets, and sayanim. Beware. Finally, without eliminating fractional reserve lending and forcing that ratio to be unity, the problem of inflation has really not been solved.

[1] <http://print-humanbeingsfirst.blogspot.com/2009/01/newsflash-financialterrorism-jan2009.html>

[2] <http://print-humanbeingsfirst.blogspot.com/2009/09/my-beef-with-hon-ron-paul.html>

[3] <http://print-humanbeingsfirst.blogspot.com/2009/12/brilliant-world-order-bedtime-story.html#Global-Governance-EU-President-Admits-2009-Video>

[4] Congressman Brad Sherman Martial Law - U.S. Army prepares to invade U.S  
<http://www.youtube.com/watch?v=sN3a1oTdDwM>

[5] <http://print-humanbeingsfirst.blogspot.com/2008/10/why-bluff-martial-law.html>

[6] <http://print-humanbeingsfirst.blogspot.com/2010/03/anatomy-of-conspiracy-theory.html>

[7] <http://print-humanbeingsfirst.blogspot.com/2009/05/note-on-mighty-wurlitzer.html>

[8] <http://www.john-f-kennedy.net/thegunsofdallas.htm>

**Source URL:** <http://print-humanbeingsfirst.blogspot.com/2010/10/letter-to-billstill-secret-of-oz-how.html>

---

### **Bill Still's pertinent reply, Tue., Oct 5, 2010**

*"I have dealt with it. I believe the American voting electorate will fulfill their historic destiny to break the back of this plutocracy by electing representatives who will do the right thing, just as they did in Jackson's era. No where else in history has any nation even come close to an effective opposition. I have offered my own plan -- real legislation. I have offered slightly different plans of others, acknowledging -- unlike others in my field -- that I am not omniscient."*

---

### **Followup Letter to Bill Still**

**Subject: Re: Thanks for the excellent documentaries**

**Cc: Ellen H Brown, G. Edward Griffin**

**Date: Sat, November 6, 2010 at 12:08 AM | Re-sent November 09, 2010 with update**

**From: Zahir Ebrahim, Project Humanbeingsfirst.org**

Hello Bill,

I finally found the time this evening to finish watching the last hour and half of your excellent documentary. Congratulations for an outstanding and persuasive narrative. I noticed in the credits that perhaps many members of your family were listed – same last name. Thank you all very much.

For one thing, you have completely addressed and sensibly demolished all the concerns listed by G. Edward Griffin for your Money Masters documentary here (some of these were rather specious IMO to begin with and that had rather surprised me coming from a learned scholar like Mr. Griffin):

<http://www.freedom-force.org/freedomcontent.cfm?fuseaction=meetstill&refpage=issues>

I am not sure why Messrs. Ron Paul/Griffin/Mises et. al., are hung up on the Austrian economics and Gold standard today (as opposed to it arguably being a solution in the past when not all gold was under the monopoly control of the same cartel and the state could possibly nationalize the gold mines and bullion – not possible today!) when commonsense alone leads one to the conclusion you have reached in both your documentaries.

On top of it, my own independent and impartial research has led me to the same comprehension even though economics and money matters were never my interest before. As I wrote in my Monetary Reform Bibliography [Introduction](#), **'Economics and Money aren't supposed to be as abstruse as it is made out to be, and nor does it take a Ph.D. from M.I.T. to realize that one is being taken for a sodomized ride on the Capricorn of economics gibberish' :**

<http://print-humanbeingsfirst.blogspot.com/2008/10/monetary-reform-bibliography.html>

The banksters who today own all the gold bullion and the gold mines will once again, through different ruses, try to return to the gold standard. As already analytically predicted in the [News Epilogue](#) in the aforementioned Monetary Reform Bibliography on February 15, 2009:

'And the most fruitful realization of Captain Rhett Butler's swashbuckling truism is yet to come, the profiting "from the upbuilding" of civilization: the new Gold Standard which will be pitched with Congressman Ron Paul's help as the panacea demanded by the peoples. Since all the world's gold bullion

supply, and the world's gold mines, are already under monopoly control of the same arsonists, no problem.

In the New Economic World Order, with global central banks – themselves controlled from behind the scenes by the same handful of private family banks owned by the Rothschilds, the Rockefellers – managing the world's merged global monetary system as well as all the world's political governments in a global governance architecture, it won't be a problem returning to the Gold Standard. All the fine gold will have to be purchased from the same private international banksters in order to back the trillions in new common currency issued for transacting the entire world's commerce. How convenient once again!

The new monetary system will be happily made inflation averse amidst cheers from the foolish goyem of the world. The new gold based standard after all, does have to protect the enormous wealth of the private banksters from inflationary-erosion in a largely serf-world of the New World Order, wherein, the only real asset owners are the banks. The new financial empire also has to be stable enough to last a millennium! Can't have inflation eroding away all its loot as it did moms and pops meager assets and life savings in the twentieth century. Why indeed the Gold Standard will now make perfect sense for the banksters and the handful of real wealth owners of the world, was so passionately explained over a hundred years ago by William Jennings Bryan, that it is best refreshed in the goy's mind directly from the horse's mouth. The contorted dialectical brilliance of the devilish banksters is truly unsurpassed!

And right on cue, the banksters' have now begun to do just that. The Reuter's headline of Nov. 08, 2010 reads: **World Bank chief surprises with gold standard idea**

<http://uk.reuters.com/article/idUKTRE6A70D720101108> (cached PDF)

<http://www.google.com/search?q=The+G20+must+look+beyond+Bretton+Woods+II>

<http://dailybail.com/home/world-bank-chief-calls-for-return-to-gold-standard.html>

I did some informal survey of their ownership a while back and found that the Rothschilds control, through interlocking proxy corporate control extending from Barrick to many mining companies, not just most of the gold bullion and gold mines on earth, but also almost all precious metal mines on earth as well! All the world's mines are now privatized under a



consolidated loci of control. Principally, you are absolutely correct that there is no reason to have a physical commodity back a national currency. As you rightly quoted Edison: ***“If our nation can issue a dollar bond, it can issue a dollar bill. The element that makes the bond good makes the bill good, also”***. Edison further went on to explain that the real science in controlling inflation was to have just the right amount in circulation, not too little as to choke commerce and cause contraction, and not too much so as to cause inflation. I quote Edison at length from his Muscle Shoals article in the New York Times and I make a similar case as you have made here:

<http://humanbeingsfirst.blogspot.com/2008/10/monetary-reform-who-will-bell-the-cat.html>

I principally stand behind, as well as in front of, my humble analysis which is entirely objective as I only came to this subject seeking truth and nothing more, and therefore, I fully endorse your documentary without hesitation Bill (albeit I am not sure that I would quite agree with all points of detail and all interpretation of history but that's besides the main point of your documentary).

Your video is featured on my website as well. I will try to purchase a few copies to distribute to friends and organizations, for my kids' school and also to donate to the local public library, funds permitting. I would very much like to support you in any way I can. Please suggest to me how – for whatever little I can do, I would be happy to do so. You have very astutely, and of course quite correctly, positioned the Monetary reform cause as a Human Rights issue, a Civil Rights issue. And a survival of the species issue if I may be permitted to add to that! I only wish that alliances can be formed with other monetary reformers who push the gold standard and other silly solutions with clearly specious reasoning. I lump Mr. Ron Paul in this category. I am only confused about G. Edward Griffin, for he ought to know better. I invite open interlocution and public debate on this subject – let the public be informed by principal antagonists debating each other rationally, unemotionally, and without disparagement. So please notice the CC.

The last remaining question for me to figure out is still the same one however as I inquired in my first letter to you – the HOW. And that is something I am spending a lot of my time on. The world government impetus is driving all global events, including the banking crises in Iceland which I have followed closely. It was not happenstance as you will surely agree, but a diabolical conspiracy to precisely precipitate the crises for which the solution they would present to solve that crises was already sitting in their top drawers, the proposal to join the EU. That was the main reason why that central bank of Iceland was privatized! It is also the same reason why the global financial crises has been deliberately precipitated – it is not quite as you suggest in your documentary that it is out of control of the bankers

themselves. The banksters know exactly what they are doing. But that is irrelevant to this letter.

There is another bankster's ruse in the works which you might of course be aware of already – nationalizing the Fed. Dr. Ron Paul is big on that, and it has the same catch as the nationalizing of Bank of England. The controlling interests will remain the same – so it will just be a cosmetic cover to throw crumbs at the crowd demanding blood, if it ever came to that! You did not address this dimension as yet another red herring to watch out for in your documentary.

Incidentally, Mr. G. Edward Griffin did an outstanding documentary in 1970 which you may have seen, **The Capitalist Conspiracy**, based on Carroll Quigley's *Tragedy and Hope*. The recipe Mr. Griffin outlined in that film over 40 years ago is not only self-evident today, but is entirely empirical throughout modern history, and especially since the banking oligarchy started orchestrating global events. If interested, I have dedicated a detailed essay exploring the subject here:

<http://humanbeingsfirst.blogspot.com/2008/09/capitalist-conspiracy-world-government.html>

The HOW problem cannot be underestimated Bill. It transcends the solution spaces you (and Ellen Brown, as well as many others) have outlined, from state owned banks, to people's power, to voting the right leaders into office, to federalizing the issue of money, et. al. The banksters are “that” close to completing their control of earth and its peoples; this is also the reason I suspect why they permitted the publication of *Tragedy and Hope*. I may hazard the guess that it is perhaps also the reason why your revealing documentary even exists today – for they do not care who learns what anymore!! Knowledge does not translate into action or activism. Neither does conscience. I don't know what motivates people in large numbers anymore, albeit I used to think that I did. But empiricism suggests neither of those two aspects are the prime movers. Besides, all people mobilization functions which used to exist in Western society, like America's very powerful labor unions for instance, grass-roots political parties, etc., have all been eliminated. Now people power is at best only mob power and the 3rd Infantry Division's 1st Brigade Combat Team is already stationed just outside of Mainstreet USA to deal with that after the calculated repeal of the Posse Comitatus Act:

[http://www.armytimes.com/news/2008/09/army\\_homeland\\_090708w/](http://www.armytimes.com/news/2008/09/army_homeland_090708w/)

It is all linked in an interconnected chain and monetary reform, while being the principal lever to break that chain as you rightly suggest, is very closely guarded by the golem to

prevent it from happening. That begs the pragmatic question HOW!

My best regards to you, and again thank you for being a terrific public teacher,

Sincerely,

Zahir Ebrahim

**Source URL PDF:** <http://humanbeingsfirst.files.wordpress.com/2010/11/letter-to-billstill-secret-of-oz-how-oct052010d.pdf>

## Chapter 24 Not Fooled Again: Red Herrings in Monetary Reform

### Who will bell the cat?

This is Project Humanbeingsfirst's response to many people's great ideas on fundamental Monetary Reforms.

The worldwide western capitalist monetary system is apparently a very complex subject, requiring many doctorates in economics to manage. It is so complicated, that it is least understood in the United States despite her thousands of distinguished economists, some even Nobel Laureates, who are now acting even more surprised at the spectre of the global economic and financial collapse haunting mankind.

It is now suggested that Capitalism, free market or not – and its quintessential engine, debt-financing through private banking, monopolistic or not – is even more convoluted than had been imagined. Dr. Ben Bernanke, my co-alumnus from MIT, Ph.D. in Economics, 1979, is busy trying to fix the problem at the Federal Reserve System by staying up late nights, and pulling his remaining hair out with worry.

It must be a real tension job at the FRS. Especially after Dr. Ben Bernanke having admitted to Milton Friedman's technical analysis of the Great Depression [1]:

“The stock of money, prices and output was decidedly more unstable after the establishment of the Reserve System than before. The most dramatic period of instability in output was, of course, the period between the two wars, which includes the severe [monetary] contractions of 1920-21, 1929-33, and 1937-38. No other 20-year period in American history contains as many as three such severe contractions”

“This evidence persuades me that at least a third of the price rise during and just after World War 1 is attributable to the establishment of the Federal Reserve System ... and the severity of each of the major contractions - 1920-21, 1929-33, and 1937-38 – is directly attributable to acts of commission and omission by the Reserve authorities...”

“Any system which gives so much power and so much discretion to a few

men, [so] that mistakes – excusable or not – can have such far reaching effects, is a bad system. It is a bad system to believers in freedom just because it gives a few men such power without any effective check by the body politic -- this is the key political argument against an independent central bank...”

“To paraphrase Clemenceau money is much too serious a matter to be left to the central bankers.”

uttered the belated mea culpa, ex post facto, more than half century after the money trust had bought up, pennies to the dollar, the thousands of collapsed businesses and banks, **“we won't do it again”** [2]:

As a personal aside, I note that I first read *A Monetary History of the United States* (Friedman and Schwartz, 1963) early in my graduate school years at M.I.T. I was hooked, and I have been a student of monetary economics and economic history ever since.

As everyone here knows, in their *Monetary History* Friedman and Schwartz made the case that the economic collapse of 1929-33 was the product of the nation's monetary mechanism gone wrong. Contradicting the received wisdom at the time that they wrote, which held that money was a passive player in the events of the 1930s, Friedman and Schwartz argued that “the contraction is in fact a tragic testimonial to the importance of monetary forces [p. 300; all page references refer to Friedman and Schwartz, 1963]. ...

Let me end my talk by abusing slightly my status as an official representative of the Federal Reserve. **I would like to say to Milton and Anna: Regarding the Great Depression. You're right, we did it. We're very sorry. But thanks to you, we won't do it again.**

As nature would have it, where it permits mankind to create complex systems, it also simultaneously creates elegantly simple.

Thus unremarkably, the solution-space is also almost as straightforward as taking away the monopolistic power to coin money from the private central bankers, and putting it back into the hands of the respective national governments, to be treated as a public trust and fiduciary responsibility of good governance in the best interest of its peoples. And most significantly, making the process of coining national money, entirely interest free. Making its control, like national defense, a government's mandate, instead of a banker's monopoly.

In the famous words of assassinated American President Abraham Lincoln:

**“The privilege of creating and issuing money is not only the supreme prerogative of Government, but it is the Government's greatest creative opportunity.”**

And Thomas Jefferson – the founding father of the legacy which Lincoln fought to maintain, and paid for with an assassin's bullet – had expressed the dangers of not doing as plainly as can be in these well rehearsed words of history:

**“If the American people ever allow the banks to control the issuance of their currency, first by inflation, and then by deflation, the banks and corporations that will grow up around them, will deprive the people of all property, until their children wakeup homeless on the continent their fathers occupied.”**

In fact, the simple solution-space, like hegemony, *“is as old as mankind.”* And certainly, at least as old as Julius Caesar and Jesus Christ. It has repeatedly been captured, time and again throughout history, as the perennial battle between the “evil” moneychangers and “good” state sovereigns.

The best straightforward articulation of it, to my mind, which even any common man or woman in mainstreet USA can trivially comprehend, never mind those with fancy doctorates in economics from MIT, is the common sense exposition of both Henry Ford and Thomas Edison – the two giants of western capitalism, and among America's greatest real wealth creators – almost 90 years ago.

The New York Times reported the following candid observations of Thomas Edison in its special edition of December 6, 1921 [3]:

### **Excerpt**

“Certainly. **There is a complete set of misleading slogans kept on hand for just such outbreaks of common sense among the people.** The people are so ignorant of what they think are the intricacies of the money system that they are easily impressed by big words. There would be new shrieks of 'fiat money', and 'paper money' and 'green backism,' and all the rest of it – the same old cries with which the people have been shouted down from the beginning.”

“But maybe we have passed beyond the time when the thoughtful 2 per cent – you know, I gather from my questionnaire that only 2 per cent of the people think,” and Mr. Edison smiled broadly.

“Maybe they can't shout down American thinkers any longer. The only dynamite that works in this country is the dynamite of a sound idea. I think we are getting a sound idea on the money question. The people have an instinct which tells them that something is wrong, and that the wrong somehow centers in money. They have an instinct also, which tells them when a proposal is made in their interests or against them.”

“ ... Well, [in the old way of doing business, Congress] must authorize an issue of bonds. That is, it must go out to the money brokers and borrow enough of our own national currency to complete great national resources, and we then must pay interest to money brokers for the use of our money.

#### **Old Way Adds to Public Debt**

“That is to say, under the old way any time we wish to add to the national wealth we are compelled to add to the national debt.

“Now, that is what Henry Ford wants to prevent. He thinks it is stupid, and so do I, that for the loan of \$30,000,000 of their own money the people of the United States should be compelled to pay \$66,000,000 – that is what it amounts to, with interest. People who will not turn a shovelful of dirt not contribute a pound of material will collect more money from the United States than will the people who supply the material and do the work. That is the terrible thing about interest. In all our great bond issue the interest is always greater than the principal. All of the great public works cost more than twice the actual cost, on that account. Under the present system of doing business, we simply add 120 to 150 per cent, to the stated cost.

**“But here is the point: If our nation can issue a dollar bond, it can issue a dollar bill. The element that makes the bond good makes the bill good, also.** The difference between the bond and the bill is that the bond lets the money brokers collect twice the amount of the bond and an additional 20 per cent., whereas the currency pays nobody but those who directly contribute to Muscle Shoals in some useful way. ...

“It is absurd to say that our country can issue \$30,000,000 in bonds and not

\$30,000,000 in currency. Both are promises to pay; but one promise fattens the usurers, and the other helps the people. **If the currency issued by the Government were no good, then the bonds issued would be no good either.** It is a terrible situation when the Government, to increase national wealth, must go into debt, and submit to ruinous interest at the hands of men ...”

“Look at it another way. If the Government issues the bonds, the brokers will sell them. The bonds will be negotiable; they will be considered as gilt-edged paper. **Why? Because the Government is behind them, but what is behind the Government? The people. Therefore it is the people who constitute the basis of Government credit.** Why then cannot the people have the benefit of their own gilt-edged credit by receiving non-interest bearing currency on Muscle Shoals, instead of bankers receiving the benefit of the people's credit in interest-bearing bonds?

“The people must pay any way; why should they be compelled to pay twice, as the bond system compels them to pay? The people of the United States always accept their Government's currency. **If the United States Government will adopt this policy of increasing its national wealth without contributing to the interest collector – for the whole national debt is made up of interest charges – then you will see an era of progress and prosperity in this country such as could never have come otherwise.**

### **End Excerpt**

That extended excerpt leaves no room for imagination to run wild trying to figure out what 'first-principle' of finance gone wild has precipitated the global crisis today, as it explains the most complex E-con gibberish in the most straightforward way.

So let me ask the economists: which is it – the straightforward explanation, or the complex calculations that are little more than high falutin gibberish to fatten the banksters gullet?

To be fair, there is indeed some degree of sophistication needed to manage money astutely in an advanced civilization. However, the profound principle of such management, once again, turns out to be as simple can be (especially when the inventor of the light bulb, explains it) [4]:

“There is just one rule for money, and that is, to have enough to carry all the



legitimate trade that is waiting to move. Too little or too much are both bad. But enough to move trade, enough to prevent stagnation on the one hand and not enough to permit speculation on the other hand, is the proper ratio.”

The actual implementation of that simple principle, the management of the “proper ratio”, well, what is the fundamental problem that a government can't manage this “proper ratio”, and requires private banksters, like the Federal Reserve System, to do it on its behalf?

The failure of FRS to actually create that equilibrium of “proper ratio” is grotesquely pronounced, and empirical. In the Great Depression, they caused it by swinging the pendulum one way and severely contracted the money supply after having deliberately expanded it willfully to create the speculative boom of the “roaring twenties”. In this new global collapse that is now reminding the erudite of the “Weimar Republic”, they swung the pendulum the opposite way and sharply expanded the money supply to enable wild speculation just like they had done to create the roaring twenties. They created the roaring 2000s, and burst that bubble quite predictably in 2008. Another mea culpa is waiting in the wings, after fait accompli.

The only fundamental macro economics Ph.D. thesis anyone need write in the near future starting their research today, and the only useful Nobel Prize that is even justifiable to award for macro economics when the world is increasingly divided in wealth disparity the images of which only bring shame to anyone calling themselves a human being first, is the exploration and answer to this 'first principle' question of **why a private banking cartel, like the Federal Reserve System, can do a better job of managing this “proper ratio” than a government?**

Since empirical evidence commonsensically always trumps any theoretical immanent theories, the proponents of the FRS, including those burning the midnight oil in its plush offices trying to save the world instead of going to jail and losing their own shirts and skirts, have a hard thesis before them. To underscore the gravity of this commonsense, I draw on poor Albert Einstein, always being called upon to adjudicate on matters commonsense. He had insisted, as possibly the greatest scientific mind of the twentieth century, on the existential value of empiricism in any theory construction in order to develop accurate understanding of reality [5]:

**“Pure logical thinking cannot yield us any knowledge of the empirical world; all knowledge of reality starts from experience and ends in it.”**

Apart from this only technical question for the possible raison d'être for a private central

bank, the other question of who ought to coin money has already been indisputably settled by the verdict of history. It is now such a blasé question that devoting so much space to such a simple topic is an insult to the intellect. Unfortunately, since such simplicity has grotesquely been occulted by E-con gibberish, trumping all commonsense, one has to endeavor to continue rehearsing it.

We already know, since time immemorial, that permitting the monopolistic coining of money and paying interest on it to private bankers, has no commonsensical, no intellectual, no rational, and no moral grounds whatsoever. Except of course, when one's intent is to actually fill the coffers of the moneychangers. Then indeed, privatizing this most essential public common, the privilege of coining public money and charging the public gratuitous interest, is the most rational, commonsensical, and intellectual approach. For indeed, the power of debt upon a people is an intoxicatingly absolute power. It is the profound understanding of the most reviled of immoral principles upon which it is based, compound interest, that the successive Rothschild family elders, in different generations, have each made the now well known pronouncement to the effect:

**“Give me control of a nation's money supply, and I care not who makes its laws”**

It is frightening that there appears to be no limit to the intoxicating effects of such power, nor to its concomitant ability to co-opt. Banksters like Sir Josiah Stamp – the Director of the Bank of England and Chairman of this and that – can 'in your face' flaunt it in the following words which are attributed to him, and the glorified E-cons with doctorates and Nobel prizes can simply pretend not to notice the defecating elephant in the bedroom [6]:

“Banking is conceived in iniquity and born in sin. Bankers own the earth. Take it away from them, but leave them the power to create money and control credit, and with the flick of a pen they will create money to buy it back again. Take this great power away from the bankers and all great fortunes like mine will disappear, and they ought to disappear, for this would be a better and happier world to live in. But if you want continue the slaves of bankers and pay the cost of our own slavery, let them continue to create money and to control credit.”

Or to be more charitable, the level of ignorance among the educated financial technocrats who continue serving against the interests of their own nation is unfathomable, when the well known imperialists themselves vouch for the veracity of these first-principles of domination [7]:

“If this mischievous financial policy, which has its origin in North America, shall become endured down to a fixture, then that Government will furnish its own money without cost. It will pay off debts and be without debt. It will have all the money necessary to carry on its commerce. It will become prosperous without precedent in the history of the world. The brains, and wealth of all countries will go to North America. That country must be destroyed or it will destroy every monarchy on the globe.”

Why do sophisticated and revered economists like Ben Bernanke, and Paul Krugman, not know this? Why does the MIT department of Economics, course 14, not teach this in its courses, but it has poverty alleviation labs which look at lack of population planning as the biggest source of poverty? How about debt to bankers? Or as EHM John Perkins revealed, faking mathematics to get the developing world to believe that taking mega-loans from the World Bank is the cure to their developmental problems [8]. My first introduction to macro economics at MIT was 14.02 – and unremarkably, I never learnt all that I know today. I am glad I was only “imperfectly educated” then, for it has been easier to throw off my own yoke of ignorance.

Well their ignorance, of these famous economists, and of the pioneering free market Nobel Laureate Milton Friedman who only classified the Federal Reserve System's 1929-1938 debacle as “**mistakes – excusable or not**”, has been addressed elsewhere. In the addendum to the Project Humanbeingsfirst's report “The Enduring Capitalist Conspiracy For World Government” [9], I had made the following straightforward observation:

'Money is an even bigger existential necessity today in the producer-consumer global paradigm than it ever was in the past, even though the imperial coin is as old as mankind!

And yet one has to come by its accurate understanding only as a detective assembling a jigsaw puzzle from empirical analysis. And even then, sometimes, the analysis suffers from one's philosophies which almost act like “religion”.

Thus it is unsurprising that some propose platitudes as solutions, forgetting that the Ten Commandments and the Golden Rule are at least 3000 years old but have made little impact on the real world of avarice and plunder. These include proposals for radical transformations as if revolutions are just around the corner. Some propose solutions which merely favor the private central-bankers themselves, knowingly or unwittingly is immaterial. Many of

these are almost always cosmetic bandaids. These also include partial solutions that leave the core problems intact. “Religion” is most apparent in these arguments. An example of this is the gold standard, or the gold-equivalence standard as the now defunct Bretton-Woods has come to be known.

In the ability to tell the nuanced differences therein, among BS, idealism, and usefulness at different application hierarchies, lies the key that can practicably and immediately unlock the world from the debt shackles of the perpetual capitalist conspiracy for world government.

But as those given to even a modicum of realism well understand, rectification of injustices is only possible either with the mighty hand of the victor's justice, or under the astute gamesmanship of balance of power. In this case, political power to affect legal solutions at all levels. Never on its own, regardless of the soundness of the platitudes or the solutions.

To build such a balance of power today that might be effective, does not seem to be in the capability arsenal of those proposing monetary reform solutions. A largely powerless peoples who cannot even fund one single economics think-tank of national consequence, and one single financial political action group of influence, never mind mustering the kind of lobbying-power before which powerful Congress persons and local law-makers, mayors, state governors, attorney generals, and newspaper editorialists might bow their head.

Realistically, I see no impact by monetary reformers at the national or international level. For it is but a truism that those who control purse strings, control nations' destinies – the real golden rule on earth, as old as mankind!

To confiscate their purse-strings – as easy as a stroke of pen – is a revolutionary act for which there is no “Jesus” today to cleanse the Congress of the moneychangers. The Wall Street bailout with the new crown of thorns, and which the US Treasury Secretary Hank Paulson is now brazenly attempting to extend to crucify all of mankind upon the new cross of a global monetary system, is proof-sufficient.'

Indeed, commonsensically concluding that report with the blatant recognition that the solution-space is not what is the unknown variable. **But only who, and how are,** given the

entrenched and awesome monopoly power of the central banks, all given to them legally by Congress, and signed off by President Woodrow Wilson.

The only thing the poor gullible professor from Princeton, after whose name the foreign policy imperial arm at Princeton University is aptly named – perhaps in gratitude for his maneuvering the United States into the First World War at the urging of his influential advisors like Col. Edward Mandell House who un-apologetically fronted for the banking interests [10], the money trust – could do is lament in the style that has become characteristic of co-opted patsies in power when writing their autobiographies.

Yes, confessionals after faits accomplis, is a characteristically “cleansing” Christian tradition. Somehow, it only seems to work for those in absolute power, never for the common man. **“You're right, we did it. We're very sorry. But thanks to you, we won't do it again”** doesn't seem to be part of the ordinary judicial system where the common man is made accountable for stealing bread. But it is part of the Nuremberg Military Tribunals which let Dr. Hjalmar Schacht, the former governor of the Reich Bank [11] – the banker who orchestrated the financing for Hitler and enabled his war machine with funding from Wall Street [12] and the City of London financiers – go scot-free!

Whence such awesome power to even let a fascist banker who caused the destruction of all of Europe – as per the Nuremberg established principle of **“all the evil which follows”** – become a prominent and influential member of the financial community once again in post-war Germany **“as though there had never been a blemish on his character”**? [13]

Whence such omnipotence that the White House Coup plotted by Wall Street financiers to overthrow President Roosevelt gets trivially buried by the United States Congress after a “911” style hearings in 1934? [14]

Well, the former President of United States, Woodrow Wilson suggested the answer [15]:

### **Excerpt**

'Shall we try to get the grip of monopoly away from our lives, or shall we not? Shall we withhold our hand and say monopoly is inevitable, that all that we can do is to regulate it? Shall we say that all that we can do is to put government in competition with monopoly and try its strength against it? Shall we admit that the creature of our own hands is stronger than we are? We have been dreading all along the time when the combined power of high finance would be greater than the power of the government. Have we come to a time when the President of the United States or any man who wishes to

be the President must doff his cap in the presence of this high finance, and say, "You are our inevitable master, but we will see how we can make the best of it?"

We are at the parting of the ways. We have, not one or two or three, but many, established and formidable monopolies in the United States. We have, not one or two, but many, fields of endeavor into which it is difficult, if not impossible, for the independent man to enter. We have restricted credit, we have restricted opportunity, we have controlled development, and we have come to be one of the worst ruled, one of the most completely controlled and dominated, governments in the civilized world—no longer a government by free opinion, no longer a government by conviction and the vote of the majority, but a government by the opinion and the duress of small groups of dominant men. ...

However it has come about, it is more important still that the control of credit also has become dangerously centralized. It is the mere truth to say that the financial resources of the country are not at the command of those who do not submit to the direction and domination of small groups of capitalists who wish to keep the economic development of the country under their own eye and guidance. The great monopoly in this country is the monopoly of big credits. So long as that exists, our old variety and freedom and individual energy of development are out of the question. A great industrial nation is controlled by its system of credit. Our system of credit is privately concentrated. The growth of the nation, therefore, and all our activities are in the hands of a few men who, even if their action be honest and intended for the public interest, are necessarily concentrated upon the great undertakings in which their own money is involved and who necessarily, by very reason of their own limitations, chill and check and destroy genuine economic freedom. This is the greatest question of all, and to this statesmen must address themselves with an earnest determination to serve the long future and the true liberties of men.

This money trust, or, as it should be more properly called, this credit trust, of which Congress has begun an investigation, is no myth; it is no imaginary thing. It is not an ordinary trust like another.'

**End Excerpt**

There you have it. The American President who signed the Federal Reserve System into existence as the figurehead president (see Douglas Reed's *Controversy of Zion*), ex post facto lamenting the power granted to the money trust. **Time to take that legalized power back! But who and how? That is the question. Not what reforms to make – at least to the first order.**

By avoiding this fundamental question of the identity of the money trust and how to de-fang it, or showing their ignorance of this matter in their masterpiece proposals for monetary reform, the worthy monetary reformers betray themselves as either gullible fools and useful idiots, or as outright controlled assets of the same money trust. They only succeed in spewing red herrings a plenty by “*introducing beneficial cognitive diversity*” (to borrow that apt Machiavellian phrase of Cass Sunstein) in order to confuse and distract the public's attention from the real heart of the matter!

The following commonsensical elaboration of this blatant point, that reformers are focussing on the wrong problem, was again reiterated by Project Humanbeingsfirst to yet another new proposal for monetary reform, pointing out that **to bell the cat is the issue, and not which bell to use**. In response to yet another intriguing reform proposal made on the internet by someone named Bart Klein Ikink, I wrote:

**' Project Humanbeingsfirst.org said: Who will bell the cat?**

Twelve Steps to New Financial Structure - Money of the Natural Economic Order by Bart Klein Ikink

<http://www.atlanticfreepress.com/content/view/5435/81/>

Let's just concede that yours is a great alternative proposal to the existing system, Proposal A.

I think there are in existence, great proposals at least up to Proposal Z.

Each proponent insists that their proposal is provably better than the existing system in some very erudite way. That's just great. More great ideas to choose from. Let's further assume that yours is the greatest invention. Or that after a major battle in some economists gathering at Harvard, one proposal unanimously comes out on top. Yours. Proposal A is now the best alternative to the existing system, and all economists, experts, and even some key government officials agree. Even perhaps the President of the United States.

**I start my humble argument from that point.**

Since your wonderful Proposal A relies on platitudes and does not show how, and with what new external or internal powers of enforcement, can the entrenched power of the moneychangers which sustains the existing system, be countered, it will remain a good idea, on paper. Just like the Good Book, and all Good Books.

Meaning, your **“hey this is the greatest idea since slice-bread, a natural idea, let’s use it”**, is qualitatively no different than **“Hey, I am God and I Command you: Thou Shall Not Kill as that is the natural order for mankind so they may live in natural harmony, and furthermore, Thou Shall Not covet their neighbors’ cow and wife, Thou Shall Not charge interest, Thou Shall Not screw your fellow man ...”** which are even greater ideas with even an absolute [divine authority] backing it, and these are of such commonsensical obviousness that they are understandable by all and sundry without even needing any elaborate exposition (certainly it was all supposedly printed on a single stone tablet taking much less space than your erudite article).

**And so what of it?** Israel today decimates the Palestinians with impunity and the world watches silently. What happened to the good idea from the good god himself? At the risk of stating the obvious, that is because the existent power-structures in the world support Israel in its conquest of Palestine – and with a devilish cleverness of baby-step incremental fait accompli that is hardly explainable fully even in a long missive like “The Endless Trail of Red Herrings”. Even their own Israeli historians, never mind their great founding fathers, gloat of, or at least narrate of, their state's and peoples' crimes – can anyone reverse that genocide which goes on even as I write this?

I hope you are able to understand my humble critique – good ideas are aplenty.

It is not meant to discourage or disparage excellent ideas, but only to point out that it is not the lack of solution-spaces that plague us. We have known the solution since Julius Caesar banished the moneychangers and started issuing his own coin. That was even before Christ threw them out of the Temple. If only good ideas could create practicable solutions, then the 3000



years old Ten Commandments and the Golden Rule might have taken care of all matters, and there'd have been heaven on earth. I hope [you] can suggest how might one proceed, given that two past presidents of the United States who tried to go against these power-brokers were immediately assassinated.

Norman Dodd disclosed to G. Edward Griffin in an interview in 1982, the following statement that was made to him by a Morgan bank official in 1929 in the aftermath of the Great Crash and Depression: **“Norm what you're saying is we should return to sound banking ... We will never see sound banking in the United States again.”**

This interview with the late Norman Dodd can be watched [here](#).

The fact that this secretive power which **“will never see sound banking in the United States again”** is the same today as when it boasted of its intent to Norman Dodd almost 80 years ago, and is quite alive and even more powerful than it ever before, was just witnessed in the passage of the not-so-secretive trillion dollar bailout Bill by Congress – and its analysis can be read [here](http://humanbeingsfirst.blogspot.com/2008/09/no-exits-on-this-super-highway.html) ( <http://humanbeingsfirst.blogspot.com/2008/09/no-exits-on-this-super-highway.html> ).

Any great ideas and proposals to fix the monetary system which do not take into account the reality of this entrenched power of the private banksters, and how to effectively counter it, is merely just that, good ideas on paper. Even great for Ph.D. thesis rehash, but of little practical use. And so long as these ideas stay there, on paper, the secretive power brokers, who, right before our very eyes just put the American nation in debt for another trillion dollars, has no qualms with them.

And if you read the following [press release](#), you will note that this new bailout debt is merely a down payment towards putting the entire world in similar straightjacket – Paulson is recommending all governments do similar bailouts with their own central banks.

And you have yourself convincingly demonstrated that the monopoly power to coin money legally, awarded to the private central bank, caused the experiment in Worgl to be abandoned by the Central Bank when it exercised its legal authority to blunt it: *“At this point, the central bank panicked, and*

*decided to assert its monopoly rights by banning complimentary currencies. The people unsuccessfully sued the bank, and later lost in the Austrian Supreme Court. It then became a criminal offense to issue 'emergency currency'."*

The same carte blanche monopoly powers were awarded to the private central bank not only in the United States, but every [private] central bank in the world enjoys that legal protection – today! This is not news to anyone surely. These legal entities can choose to enforce that legal right whenever threatened.

And as the following article indicates, there are 65 alternate local/regional currencies in Germany alongside the Euro, and these are only allowed to exist because the European monetary authorities think these fringe elements are not any threat to their main currency Euro:

<http://www.telegraph.co.uk/finance/2802861/Germans-get-by-without-the-euro.html>

And in the 1996 video, The Money Masters, at around 3:13:00, you can also see another success story of local currency, in Guernsey, a small principality off the coast of France.

And the aforecited video further quotes economist Milton Friedman, in its conclusion after a long and very informative historical analysis, all the good platitudinous stuff, on commonsensically reclaiming back the power awarded to the Federal Reserve System.

But as the video also narrates: these central banks are now deeply entrenched in the world's power structures, with a history of at least 300 years of legal legitimacy and institutionalized experience. These are now global institutions protected by entrenched laws in every nation, protected by paid politicians and media. They are owned by the richest families in the world which control them from their central headquarters – the Bank of International Settlements ([bis.org](http://bis.org)) through an opaquely interlocking and complex ownership structure that no one can penetrate through.

So find me a “Jesus” courageous enough to alter that reality, who will cleanse the lawmaking bodies of the world of the presence of the moneychangers' influence, and bring forth new legislation which will effectively repeal those laws which originally gave power to coin money out

of thin air to the moneychangers.

Unless a proposal for monetary reform addresses these issues of the grotesque reality of immeasurably entrenched global power, as an integral part of their implementation architecture, it's like I read on some website once (probably [globalsecurity.org](http://globalsecurity.org)): **“dreams without funding [power] are hallucinations”**

I keep repeating, that there is really no shortage of solutions. Julius Caesar knew it, Jefferson, Lincoln, Jackson, and JFK knew it. You know it. G. Edward Griffin Knows it. Norman Dodd knew it when he made a proposal to the Morgan Bank to return to sound banking practice in the aftermath of the Great Depression of 1930, WebOfDebt knows it, MoneyAsDebt knows it, MoneyMasters know it, monetary.org and mises.org both know it. Richard Cook seems to know it too. Even Alex Jones knows it. Certainly [Congressmen] Ron Paul and Dennis Kucinich [apparently know it] too.

And I say – very good. Hallelujah.

Now go fund a political action group, an economics think-tank, some newspaper editorialists in the New York Times and the Washington Post, and at least [a majority of] Congresspersons' election campaigns who would [effectively] vote 'Yes' on the monetary reform Bill, and bring to power an occupant in the White House willing to sign it even at the risk of assassination, with a Vice President and a House Speaker who will not rescind it if the abhorrence comes to pass, if you want to stop hallucinating.

This is how the banksters did it – and all the time their well meaning antagonists, and at least since 1913, have only been spouting platitudes. Nothing new is being said today, that has not been stated tens of times before. And I can now verify this because I have spent considerable time researching this topic. But this is hardly news to anyone who can write such an outstanding proposal as the one in this article.

The game is lost in the current round my friends. And I pray that I am entirely wrong, that indeed, the sheer think-system invented by the “Music Man”, and the platitudes of the prophets of antiquity, do win out in the real world at some point – not today though.

Only access to, and harnessing of, real power, to minimally construct the

balance of power, if not overwhelming victor's power, and fighting political power with political power, military power with military power, can alter any existent reality that is counter to the interests of those presently wielding the power. Sorry to be stating a blatant truism to make the obvious point.

Hope this helps clarify matters and helps focus or redirect attention of those with the wherewithal and genuine stamina to endure the course, to how to politically instrument monetary reform. Of course this is intimately tied to what reforms, because that determines the level of inertia and opposition, but nevertheless, without political power (and access to wealth to get that power), it is meaningless to spend further time in researching what reforms to make.

There are plenty of known solutions, many are even proven solutions which need no further study to pick from as the first pass reform. Fine tuning can occur over time if suitable legislation is drafted. But:

**Who will bell the cat?**

**How will the cat be belled?**

We already have several shiny new and antique bells to choose from. It's pointless crafting any more new bells. That's all your proposal is, a new, or even an old, bell. Get to the next stage please.

Thank you.

Zahir Ebrahim

Project Humanbeingsfirst.org '

## **Footnotes**

[1] Ben Bernanke, Remarks At the Conference to Honor Milton Friedman, University of Chicago, November 8, 2002, <http://www.federalreserve.gov/BOARDDOCS/SPEECHES/2002/20021108/default.htm>

[2] Milton Friedman. Transcription from The Money Masters - How International Bankers Gained Control of America - 215 min. At 3:08:24 <http://video.google.com/videoplay?docid=-515319560256183936>

- [3] FORD SEES WEALTH IN MUSCLE SHOALS, Special to the New York Times, Tuesday, December 6, 1921, page 6. See online abstract and photocopy <http://query.nytimes.com/gst/abstract.html?res=9C04E0D7103EEE3ABC4E53DFB467838A639EDE>
- [4] Ibid.
- [5] Einstein's Herbert Spencer lecture of 1933, cited by Dr. Abdus Salam at the 1979 Nobel Prize Dinner speech, [http://nobelprize.org/nobel\\_prizes/physics/laureates/1979/salam-lecture.pdf](http://nobelprize.org/nobel_prizes/physics/laureates/1979/salam-lecture.pdf)
- [6] Sir Josiah Stamp, Director of the Bank of England, Transcription from The Money Masters - How International Bankers Gained Control of America - 215 min. At 3:21:58 <http://video.google.com/videoplay?docid=-515319560256183936>
- [7] Times of London Editorial. Ibid.
- [8] John Perkins, Confessions of an Economic Hitman, 2005, page 101, first edition hardback.
- [9] Zahir Ebrahim, <http://humanbeingsfirst.blogspot.com/2008/09/capitalist-conspiracy-world-government.html#Addendum>
- [10] Col. Edward Mandell House, Philip Dru: Administrator, A Story of Tomorrow 1920-1935. It is a fictional narrative like Machiavelli's The Prince, and hides a deep political discourse enacting the role actually played by its author. Col. House remained an influential force behind Woodrow Wilson's presidency. <http://www.gutenberg.org/dirs/etext04/8phlp10h.htm>
- [11] Dr. Hjalmar Schacht (Reich minister of economics until 1937, Reichsbank president until 1939). David Irving, Nuremberg, The Last Battle, 1996, page 160. Some pertinent passages:
- “[Jackson] regarded the former president of the Reichsbank as the most contemptible of all the defendants. He had provided the finance for the spectacular rise and rearmament of Hitler's Germany. More than any other, this man's financial genius had paved the way for the violation of the Versailles Treaty.” (page 157)
- “Ambitious and arrogant, Schacht [Highest IQ 143, page 292] had walled himself in behind a belief in his own righteousness. He seethed with rage at being imprisoned

with Hitler's henchmen. He admitted to having violated the Versailles Treaty, but countered that since the Allies were in collusion against Germany this was no crime. .. He admitted rebuilding Germany's run-down economy, but not for the purpose of waging war; Hitler had dismissed him as soon as he balked at the aggressive planning that began." (page 293)

"Hjalmar Schacht – 'after Göring the toughest of them.' He [Jackson] had always regarded Schacht as one of the most despicable defendants. The banker's arrogant attitude since the trial had begun only vexed him all the more." (page 327)

"Even more irritating for Jackson was that Schacht was overheard in the cells confidently predicting that he would be acquitted. Irritating rumours circulated that the prosecution of Schacht was not in earnest. Letter-writers taunted Jackson that he would never succeed in convicting a big banker – whether friend or foe, they were the new Untouchables. He soon became aware that the Nazi banker did indeed have friends in the most unlikely places and influence everywhere. One day one of his team, the eminent New York international lawyer Ralph Albrecht, reported to him that the British assistant prosecutor Colonel Harry J. Phillimore – later a lord justice of appeal in London\* – had accosted him in the hall outside the courtroom and urged the Americans to relax their remorseless pressure on the banker. When Albrecht, perplexed, asked 'Why?', Phillimore uneasily explained that certain representations had been made by Sir Montagu Norman, governor of the Bank of England from 1920 to 1944. 'It would be most unfortunate,' murmured the British colonel, 'if anything were to happen to Schacht.' In fact Schacht had been an informer of Sir Montagu, secretly apprising him of the political and financial decisions taken at the highest level in Berlin for sixteen years before the war." (page 328)

"There is in the records of His Majesty's treasury in the British archives an illuminating file on the efforts made by Sir Montagu Norman to get Schacht released." (page 329)

"He [Jackson] regarded the case against the banker as a test of the good faith of the entire prosecution. As he had said in a secret meeting of all the chief prosecutors in April, of which there is a shorthand record in his files, 'If the court, for instance, holds that we have no case against Schacht, then it seems clear that we can have no case against any industrialist, as the case against him is stronger than the others.' ... He [Jackson] privately recorded later, 'I would at least stand out forthrightly in demanding his conviction, convicting him if I could.' He harried the

banker mercilessly in the witness box, addressed him as 'Schacht,' tout court, confronting him with the evidence of his participation in Hitler's aggressive planning until eventually the defendant had to admit that he had been untruthful about his dealings with the Führer. Jackson showed the Tribunal newsreel film of Hitler's triumphant return to Berlin in July 1940 after the defeat of France – long after Schacht would have had them believe he had fallen into disfavour. There was Schacht, in Prince-Albert morning coat and top hat, the only civilian among the generals waiting on the station platform to pump the Führer's hand – indeed with two hands he caught hold of the Führer's, stepped out of line, and followed him 'in almost lickspittle fashion,' as Jackson remarked later. And this was the Nazi gentleman for whom the British lawyer Phillimore and banker Sir Montagu Norman were interceding. **All the more acute was Jackson's fury when the Tribunal – with only the Russian judge publicly dissenting – acquitted Schacht.** Biddle, who read out this part of the judgement, claimed some months later that he had also wanted to convict, **but the British had insisted on an acquittal and had left him no choice.**" (pages 329-330).

Also see page 392. <http://www.fpp.co.uk/books/Nuremberg/NUREMBERG.pdf>

**Zahir's recurring question:** Why had the British insisted on an acquittal of Dr. Hjalmar Schacht? What hidden supra international power had prevailed over the combined governments of Great Britain and the victorious Allies? Unless that supra international power has magically disappeared from the planet in the aftermath of World War II, how will that power today permit any interference to its financial operations whatsoever?

[12] Antony C. Sutton, *Wall Street and the Rise of Hitler*, 1976

[http://www.reformed-theology.org/html/books/wall\\_street/](http://www.reformed-theology.org/html/books/wall_street/)

[13] David Irving, *Nuremberg, The Last Battle*, 1996, page 402: "As he was released from his [Nuremberg] cell, German police stepped forward and arrested him. A German court sentenced him to eight years' imprisonment as a major offender under the denazification laws enacted by the Control Council in Berlin. He served two years in solitary confinement, and was eventually released in 1948. The world of banking absorbed him again as though there had never been a blemish on his character."

[14] BBC Radio 4: Document *The White House Coup*, exposed by Maj. Gen. Smedley Butler. <http://www.youtube.com/watch?v=dIC5liKikJ0>

[15] Woodrow Wilson, The New Freedom – A Call For the Emancipation of the Generous Energies of a People, Chapter 8: Monopoly, or Opportunity? Text from Gutenberg edition <http://www.gutenberg.org/files/14811/14811-h/14811-h.htm#VIII>

**Source URL:** <http://print-humanbeingsfirst.blogspot.com/2008/10/monetary-reform-who-will-bell-thecat.html>

First Published October 19, 2008



## Chapter 25 Not Fooled Again: The Deception of Zion

### Is Zionism a sophisticated Hegelian Dialectic to prosecute another world war?

#### Part-1

Just like Brzezinski's "The Grand Chessboard" [1] now appears to be a fantastic red herring to bankrupt the United States and create the right pretexts and ripe conditions to present a NAU to its public as the only panacea enroute to the international banksters' world government, is it possible that Zionism too was/is a phantasmic red herring to set the stage for Albert Pike's World War III in order to drive the final nail into the coffin of all nationalism and sovereign nation-states?

The fact that the harbingers of all wars and world government are also the prime supporters of Zionism means little, for just as they were once prime supporters-bankrollers of the USSR and Nazi Socialism before destroying them, the Hegelian Dialectics of conquest require credible enemies, or rather credible opposites to achieve the synthesis of the desired agenda - global communism to be centrally controlled by a hierarchy at whose apex sit the all-seeing eye!

Is it at all possible that the modern Jews themselves were calculatingly setup with the mal construct of Zionism and entirely brainwashed/enticed into nurturing/supporting it with the introduction of Reform Judaism? Empirically, just as the Grand Chessboard initially appeared to be the blueprint for all the wars of conquest since 911 as the Trilateralist Zbigniew Brzezinski deceptively pitched the believable **"democracy is inimical to imperial mobilization"** mantra and showed how that could be subverted with a *"new pearl harbor"* in order to perpetuate *"American Primacy and Its Geostrategic Imperatives"*, Zionism too appears as the believable blueprint for Eretz Yisrael that Jews must pursue as their 'divine imperative'. But is that the real planned endgame? Is that what Theodor Herzl, a secular atheistic ideologue, really after as he spun his 'Der Judenstadt' for the hidden hand of the international banksters who almost entirely bankrolled Zionism through their many vassals throughout the 19th and 20th century?

Notice that in any critique of Zionism or Israel, [2] the names of International bankers is seldom uttered. And yet, the Balfour Declaration was issued to Lionel Rothschild, and

Moses Hess, the reformer of Messianic Judaism who ushered in the notion that Jews don't have to wait for a Messiah in order to return to their Promised Land, was presumably bankrolled by the Rothschilds.

Today, these banksters and their offspring control all the world's private central banks as well as most of the world's debt, and through the infinite monies they rake in through usury, control all the foundations, think tanks, global governing-lending-financial institutions, including the United States Congress and its military-industrial complex, and through them all the political bases, and through them all the world events including its media coverage. Thus, not only is our condition of voluntary servitude, but also our perception of our own zeitgeist, entirely and completely in these oligarchs' Orwellian hands!

Is Zionism merely a tool in their hands too, just like the venerated Mujahideens once were for taking down the USSR, and the despised 'militant Islam' now is to perpetuate the manufactured 'war on terror'? The real unhidden agenda of free-market capitalism to be so egregiously maligned for its unbridled greed and unbridled conquest, and subsequently, as a solution to that problem, replaced by a centrally managed world communism with these banksters consolidating all the world's assets, properties, land, natural wealth, and legal-political-financial-economic-military power into their own private grubby little hands? And their Hegelian Dialectical brainchild of Zionism merely being essential to fighting another World War that will destroy it as well as all the remaining vestiges of the "old world order"? Is the famous neocon quip ***"Zion that will light up all the world"*** the banksters' ephemeral ploy of the Straussian vintage to malign Godly Judaism just as much as they malign the other Godly religions of antiquity?

For Secular Humanism is indeed the modern religion of conquest, and Nietzsche their god. [3] That god killed off absolutes and ushered in relativity of morality whereby ends justify the means. Humanity in this new religion is merely sheep to be guided by the illuminated ones, utilized for their benefit, and when necessary, population controlled as in any natural wildlife preserve. The human rights in this modernity are relative to an agenda, and as Justice Vinson of the U.S. Supreme Court had candidly opined in 1951:

**"Nothing is more certain in modern society than the principle that there are no absolutes, that a name, a phrases, a standard has meaning only when associated with the considerations which give birth to nomenclature. To those who would paralyze our Government in the face of impending threat by encasing it in a semantic strait-jacket, we must reply that all concepts are relative." [4]**

If all this grotesque perversion is indeed true as empiricism suggests it to be, and not merely a tin-hatted conspiracy theory, [5] then, instead of focussing on Zionism which will be destroyed in time by the oligarchs anyway along with most of humanity, [6] is it perhaps high time the spotlights from all directions get focussed on the real roothead of oppression?

The ones who nurture not only this mal construct abhorrence among a beleaguered humanity in Palestine, [7] but are also the prime-movers behind all the abhorrent wars orchestrated by their glorified 'errand boys'? [8]

The ones who use their dialectical instruments for one-world government to piece-meal enslave us all using multifaceted fabricated pretexts [9] in the best mold of Hegelian Dialectics?

Who can deny with a straight face that their diabolical ***“end run around national sovereignty, eroding it piece by piece [has not already] accomplish[ed] much more than the old-fashioned frontal assault”*** [10] ever could have!

But wait – let's just keep talking of one-state vs. two-state solution as Jimmy Carter just did in his Washington Post article today. [11]

## Footnotes

[1] <http://prisonersofthecave.blogspot.com/2007/04/chapter-1.html>

[2] <http://www.atlanticfreepress.com/news/1/11252-zionism-an-abnormal-nationalism-.html>

[3] <http://print-humanbeingsfirst.blogspot.com/2009/02/letterto-dalitvoice-which-god.html>

[4] <http://humanbeingsfirst.files.wordpress.com/2009/04/cacheof-a-brief-chronology-of-collectivism-samuelson1997.pdf>

[5] <http://print-humanbeingsfirst.blogspot.com/2009/04/some-dare-call-it-conspiracy-garyallen.html>

[6] See analysis of NSSM 200 in <http://print-humanbeingsfirst.blogspot.com/2008/09/capitalist-conspiracy-world-government.html>

[7] <http://print-humanbeingsfirst.blogspot.com/2009/01/from-genesis-to-genocide-in-palestine.html>

[8] <http://print-humanbeingsfirst.blogspot.com/2009/04/vanilla-or-chocolate-icing-ondevilscake.html>

[9] <http://print-humanbeingsfirst.blogspot.com/2008/12/responseto-ft-gideon-rachman-worldgov.html>

[10] Richard N. Gardner, "The Hard Road To World Order", April 1974, Foreign Affairs, Council on Foreign Relations.  
<http://www.thepowerhour.com/articles/HardRoadtoWorldOrder.pdf>

[11] <http://print-humanbeingsfirst.blogspot.com/2009/09/response-to-carters-elders-view-me.html>

## **Appendix: Making *Useful Idiots* of the Zionist Jewry – The evidence is the modern Israeli Jews' own confessions**

### **Delusion to Vindictiveness by Gilad Atzmon, October 8, 2009**

<http://www.gilad.co.uk/writings/from-delusion-to-vindictiveness-by-gilad-atzmon.html>

#### **Excerpt**

"Zionism was there to bring about a new Jew, a civilised productive human being. It was indeed a very wet and epic dream. As an Israeli youngster I myself succumbed to this dream. I tended to believe that Israel was 'my' historic land, I regarded the Biblical protagonists as my direct ancestors. I was sure that, at least in the case of the so called 'first Israelis', the ideological transplant operation was a great success. We, the young Israeli natives tended to believe that we were all nothing less than a success story of 'modified-civilised-humanist-secular-beings'.

Needless to say that the history of Palestine, the Palestinians and the Nakba was totally hidden from us. We didn't see the Palestinians around us either, we were hardly aware of their suffering not to say their cause. We were in fact totally blind. We tended also to believe that our army was the 'most humanist army around'. We grew up with the '1967 Victorious Diary', a legendary chunky photo album every Israeli held in a prominent location on his book shelve. There in that glossy propaganda book an Israeli soldier was giving his water to an Egyptian prisoner. We regarded him as a symbol of

our people's endorsement of universal humanism. We were obviously not aware of the horrendous fact that the Sinai Desert was actually a slaughter field for hundreds of Egyptian POWs. Why didn't we know? This in itself is a very good question. Our fathers who fought in this war must have known something but they kept quiet. Our parents who witnessed the 1948 convoys of Palestinians refugees should have known something about the Nakba but they somehow kept quiet. Interestingly enough, it wasn't just our parents, we followed the exact same pattern. Once we ourselves matured into IDF soldiers, we did exactly the same, we turned a blind eye (1982 in Lebanon). And this has never changed. The Israeli moral awakening has never happened. By now I allow myself to argue that it won't happen. The Zionist dream is just too comfortable. After more than one hundred years of moral phantasmic delusion the Israelis are deeply stuck in an ethical coma."

**Israel/Palestine: How to End the War of 1948 by Tanya Reinhart October 1, 2002**

<http://www.amazon.com/Israel-Palestine-How-End-1948/dp/1583225382>

**Excerpt**

"The state of Israel founded in 1948 following a war which the Israelis call the War of Independence, and the Palestinians call the Nakba - the catastrophe. A haunted, persecuted people sought to find a shelter and a state for itself, and did so at a horrible price to another people. During the war of 1948, more than half of the Palestinian population at the time - 1,380,000 people - were driven off their homeland by the Israeli army. Though Israel officially claimed that a majority of refugees fled and were not expelled, it still refused to allow them to return, as a UN resolution demanded shortly after 1948 war. Thus, the Israeli land was obtained through ethnic cleansing of the indigenous Palestinian inhabitants. This is not a process unfamiliar in history. Israel's actions remain incomparable to the massive ethnic cleansing of Native Americans by the settlers and government of the United states. Had Israel stopped there, in 1948, I could probably live with it. **As an Israeli, I grew up believing that this primal sin our state was founded on may be forgiven one day, because the founder's generation was driven by the faith that this was the only way to save the Jewish people from the danger of another holocaust.**" pg. 1

**Source URL:** <http://print-humanbeingsfirst.blogspot.com/2009/09/is-zionism-hegelian-dialectic.html>

First Published September 06, 2009

## Part 2

### Fourth Generation Warfare

Over the years I have read many publicly available Pentagon documents, going all the way back to what were earlier classified and later made available either through FOIA or natural declassification cycle.

Before I make my relevant point – let me cite an example.

When I learnt, from Chomsky initially, and subsequently reading the originals, of George Kennan's doctrine of outspending the Communists and that they would naturally collapse soon enough, that document is the 1948 Policy Planning PPS-23, I was taken aback. That PPS-23 had formed the underpinnings of what later became the Truman Doctrine that had held the world hostage for over 4 decades – at the brink of annihilation! Or so I, and almost everyone on planet earth have been led to believe. So, we, of the proverbial dissent-space, have all dutifully critiqued the *“Military-Industrial Complex”* of America and remained in awe of President Eisenhower's candid labeling of it; the very same President who also dutifully carried on the baton of the Cold War from President Truman, embarking on the largest 'peace-time' military and civil defense spending spree in the United States probably in its entire inglorious history of bloodshed up to that time.

That flaming-torch of the Cold War was continually carried on by every single American President for four decades. When PPS-23 was declassified, like flies drawn to a dead carcass, the many historians and moralists of empire laughed their way to their bank rehearsing it in their narratives. Not one of them, to my knowledge, decided to donate the proceeds of their pedantic works to the poor victims of four decades of proxy-warfare against the Communists, the last one, and still ongoing, being Afghanistan.

How does one cast the aforestated public knowledge from which the 'mainstream' of dissent-space in the West is largely constructed (or orchestrated), into the actual tortuous reality which is not as well known, that Communism (like Nazi Socialism and Zionism) was itself created and abetted by the Anglo-American banksters who also financed both the American and Soviet *“Military-Industrial complex”* through deficit spending, sticking the

compound-interest payments on the borrowings from the future to the American tax-payer?

If this comes as a shocking revelation, see the works of W. Cleon Skousen, Antony Sutton, Eustace Mullins, G. Edward Griffin, Douglas Reed, the all Anglo-American first and second generation, and rather rare, truthful analysts since the World Wars of the twentieth century.

The fact that Zionism too is the brainchild of the same bankster oligarchs is perhaps the most closely guarded truth in plain-sight among the dissent-space. The name Rothschild seldom occurs on their lip, even though, the official seed upon which the state of Israel is founded, the Balfour Declaration, is addressed to that name.

Going from gullibly naïve-green Chomsky student from the late 1970s where 'empire' was the baddy – which was in itself an eye-opener from the mainstream version among the thoughtful where 'empire' mainly suffered the tyranny of its good intentions, its 'la mission civilisatrice' – to the eye opening independent research into who runs the empire through the Hegelian Dialectics of opposites and fabricated enemies, has been quite a journey of shocking discovery for this scribe. Despite the slight digression, it is important to note as an aside, that once having arrived at that destination, it has become enormously difficult to explain it to those in the mainstream, including this scribe's friends, who haven't even taken the first baby-step to become aware that there is even a reality outside the 'cave' (see the Preface and Introduction of the author's 2003 book 'Prisoners of the Cave'). But let's continue on.

The latter – the role of the secretive oligarchy rooted in the international banksters which far surpasses the egregious impetus for superpower hegemony of the 'errand boys' who periodically replace each other in the White House, is something Noam Chomsky has never written about to my knowledge (and if he has, I'd be happy to eat crow), but so many 'lesser' people have, including yours truly based on information uncovered through independent research – makes George Kennan's entire PPS-23 now look like an elaborate ruse to direct the Pentagon's Generals into buying into the reality of the fabricated enemy. Like Henry Kissinger had once stated, something to the effect:

***“Military men are just dumb stupid animals to be used as pawns in foreign policy.”***

So back to 2001 – 2009. Is anything much different today? Or does history traverse in cycles when it is being run by an oligarchy with common and shared aspirations?

After all, **“Hegemony is as old as mankind.”** While Zbigniew Brzezinski tried to divert attention from the oligarchy – himself being an 'errand boy' for it – by exclusively

apportioning that common ethos of all chauvinists to the abstraction of **“the first, only, and last truly global superpower”** without actually defining what or who is the America whose **“Primacy and Its Geostrategic Imperatives”** he putridly outlined, the truism is directly applied to the oligarchy which actually owns and operates that sole superpower and is using it to achieve its own private, un-elected, un-publicly sanctioned, world government agenda.

The unvarnished reality is that the 'War on terror' is another fabrication, 911 was an inside job like operation Canned Goods of 1939, and fighting the Fourth Generation War, World War IV, is the sine qua non for the one-world government agenda of the same oligarchs.

If that indeed be the case, and I not only believe it to be so, but have staked my past 8 years of unrelenting but entirely futile efforts on that predicate, the article “Fourth generation warfare in the most advanced stage”<sup>\*</sup> describes a cleverly disguised truth within a lie (also see 'The Pentagon's Blueprint' by Steve Perry <http://cursor.org/backhome/92901.htm> ).

We know of lies within lies, but truth within lies has more potential to create believable absurdities. And if you can convince people of absurdities, you can also get them to commit atrocities in the name of *“either you are with us or with the terrorists”*.

There is today, and has been for at least a hundred plus years, only one primal common global enemy of mankind which manufactures, aids and abets, cultivates and sustains, all the local ones. The Pentagon, the White House, the Congress, all work for it. It created Pakistan through the Round Tables; it sanctioned and funded the Zionist agenda since its very inception and created Reform Judaism to bring the flock to their Promised Land by hook or by crook; it created the Bolshevik Revolution by funding the enemies of the Tzar and looting all of Russia's wealth; it funded Nazi Socialism and then funded its opponents to destroy it; and it created China's Communist Revolution by propping up an unknown Mao Tse Tung. It also moved all of America's production and industrial infrastructure to China and replaced that real wealth with its ill fated financial sector and its tortuous instruments of fictitious wealth that has now manufactured the global Financial Crisis. That enemy today, the misanthrope of all humanity, the only one that has profited from all the wars of the twentieth and this century and all the boom and bust economic cycles acquiring the deeds to almost all hard properties on the planet while growing itself into greater and greater combines with each bust, is now ready to bite the hand which has fed it.

Unless that common global enemy and its overarching agenda is kept properly in focus, official reports like the one cited above only create red herrings to distract attention from it.



One thing I have learnt studying the foreign policy of nations for now almost 30 years, is scepticism. Real secrets, real doctrines, and real strategies and tactics, are always kept “Top Secret”. No one in the right mind is going to reveal their secret weapons to the enemy and pending victims. There is always an agenda in all “information leaks” and purported “Pentagon's Joint Vision 2010/2020/2030” documents. The proof of that, that real secrets are always closely guarded to the chest, is that the evidence and circumstances surrounding Abraham Lincoln's assassination 150 years ago – notice we aren't taking JFK, RFK, MLK, or even 911 new pearl harbor – are still classified Top Secret!

So what they let out, in a convoluted way that simple minds like ours un-attuned to the complexities of Machiavelli and the demonic principles of conquest by way of deception can't fathom, is whatever they really want us to believe. In the above report, they really want us to believe that there is a really un-fabricated enemy who attacked the United States on 911, the consequent by-product of which is this new Fourth Generation warfare. Just as in PPS-23, they really wanted us to believe that they are fighting the real enemy, the Soviet Union, which, throughout its existence since the 1917 Bolshevik Revolution, had entirely relied on the American tax-payer to sustain it! Un-freaking un-believable? Not if one understands that dialectical deception is the key principle behind it all.

This is far more complex and sophisticated, requiring long term planning, logistics, and execution, than what any two-bit tin-pot dictator in any third world country is capable of.

The “Mighty Wurlitzer” does its thing and us gullibles of the world continually fall for it.

Just look at the description of the Fourth Generation war as quoted in the afore mentioned article:

**“The fourth generation battlefield is likely to include the whole of the enemy's society....a goal of collapsing the enemy internally rather than physically destroying him. Targets will include such things as the population's support for the war and the enemy's culture....In broad terms, fourth generation warfare seems likely to be widely dispersed and largely undefined; the distinction between war and peace will be blurred to the vanishing point. It will be nonlinear, possibly to the point of having no definable battlefields or fronts. The distinction between 'civilian' and 'military' may disappear... Targets may be more in the civilian than the military sector.”**

The targeted victim will already be demoralized by simply reading it! That is psy-ops 101.

With that as the backdrop, what should one get out of this type of warfare whose signs are empirical in the dead bodies of Pakistanis and Palestinians and Iraqis and Lebanese and from Afghanistan to Yugoslavia and which needs no documentary revelations?

What is new that is not already covered in the 2500 year old “Art of War”?

No – the purpose is to disillusion the victim by its overwhelming 'shock and awe' impact upon all of one's senses.

And therefore, with “Mir Jaffer” and “Mir Sadiq” running all our nations, aided and abetted by an assortment of intellectual niggers and useful idiots, and without whom these demonic strategies for primacy wouldn't have a prayer of succeeding, **the first enemy is the one within who enables this all.**

Let's not lose sight of that enemy. Even in the United States, its own first enemy responsible for its calculated and premeditated downfall is the one within.

This enemy has only one agenda. And that must remain our combined focus. We take out the root, the diseased tree and all its branches will die a natural death! There may be some hysteresis, and we may hasten its extinction somewhat, but only after its roots have been neutralized. And not before.

**Conclusion:** Each society and every nation-state must work on getting rid of its own treacherous Mir Jaffers and Mir Sadiqs. For those living in the West, that simply means getting rid of their Benedict Arnolds and the seduction of its many a treacherous Delilah fashioned upon the Fable of the Bees which create useful idiots “*who are content to labor hard all day long.*” All these silly strategy documents of primacy, and all their games of demonic warfare, will naturally fall on their face.

Thank you

\* The website carrying this article is now defunct.

**Source URL:** <http://print-humanbeingsfirst.blogspot.com/2009/10/editorial-enemy-within-4th-gen-warfare.html>

First Published Feb 17, 2009

## Chapter 26 Not Fooled Again: Dissecting the Dissent on Zion

### The Illusion of Power and the Calculus of Dispossession – A Response to Alan Hart

I

First of all, thanks to Alan Hart for his [article](#) which I read on Salem-News<sup>[1]</sup>. It takes a brave man to see, and even braver one to speak. And especially to speak out against the genocidal crimes of a state whose own “mother” called Alan Hart her “good friend”<sup>[2]</sup>:

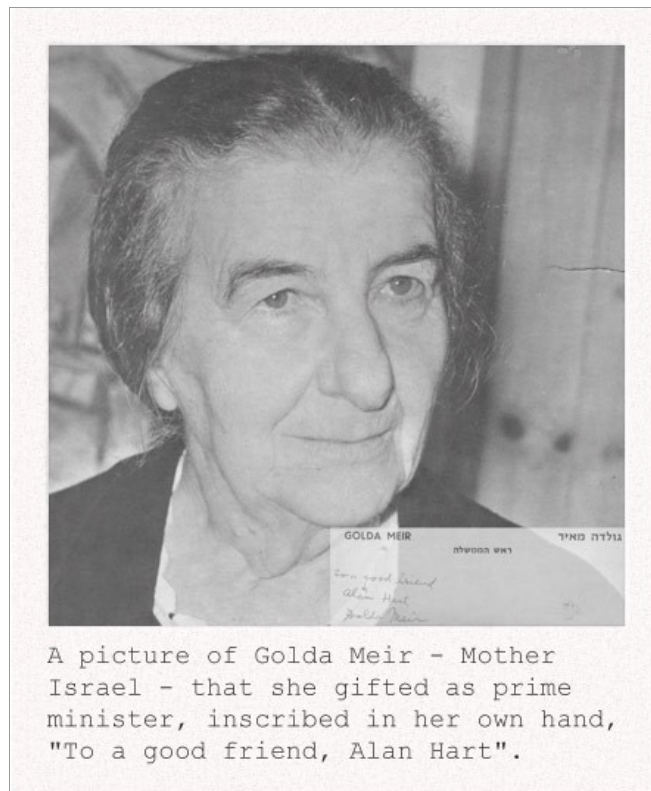

Zionism is indeed the Jews' worst enemy. It tends to make the world's Jewry the natural enemy of the entire world regardless of which country they live in. As was examined in another [riposte](#) to Alan Hart, January 17, 2009 titled “No No – Not the ‘New Nazis’”<sup>[3]</sup>, Jews can become the seditious enemies of their home nations where they were born and whose citizenship they enjoy, when matters come into conflict with supporting their Jewish state in Palestine.

The foundation of this sociopathy was laid very carefully in the precise wording of the Balfour Declaration itself. It had sanctioned the Jewish state in Palestine without jeopardizing the Jews' political rights in their own home countries: *"It being clearly understood that nothing shall be done which may prejudice the civil and religious rights of the existing non-Jewish communities in Palestine, or the rights and political status enjoyed by Jews in any other country."*

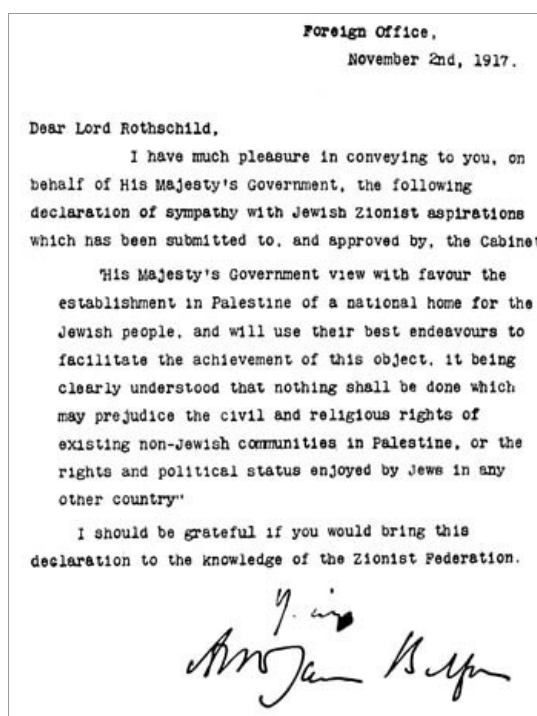

The Balfour Declaration permitted the Jews, solely by the fiat of imperial power, to live in any country in the world while simultaneously making the Jewish state in Palestine their new home without jeopardizing their *"rights and political status"* in their home country of birth or citizenship. Notice that the wording of the Balfour Declaration does not even mention the indigenous peoples of Palestine by name, only referring to them as *"non-Jewish communities in Palestine"*. It further does not mention their general *"rights and political status"* as a people as it does for the Jews, but only refers to some narrower *"civil and religious rights"* as *"non-Jewish communities"*. While on first glance these might appear equivalent to the layman, on careful examination with the eyes of a shrewd lawyer, the local *"non-Jewish communities"* are not accorded the same general unspecified *"rights and political status"*, as are the transplanted Jewish people in the land of another granted to the Jews.

While bearing only a few short imperial proclamations, the Balfour Declaration is the most treacherously worded document of its kind in the history of colonization. Observe the magic of its linguistics, wherein, the Palestinian peoples are not referred to as a "people", but only

as “*non-Jewish communities*”. Whereas, the same document refers to the Jews as “*the Jewish people*”. The simple, largely agrarian, indigenous Palestinian population, uninformed of the vagaries of deceit and the Machiavellian use of legalisms and linguistics, from day one were deprived of political status by the very wording of the Balfour Declaration.

The British empire making the surprising land grant to the Jews whom they professed no inordinate love for throughout their history, only villainous hatred, suddenly didn't even recognize the indigenous peoples of Palestine continuously living for thousands of years in their own ancestral lands as one people. But the Jews in Diaspora, hailing from almost every country and culture on earth, but primarily the Ashkenazi from Europe, are acknowledged as one, “the Jewish People”. Thus, the Machiavellian logic was to naturally follow, that how can a non-existent people have the general “*rights and political status*” which the “*Jewish People*” enjoy as a people regardless of where they live? That logic, once diabolically seeded into the consciousness of the world Jewry by the fiat of Zionism as their divine right, has been articulated by almost every prime minister and statesman of the Jewish state of Israel ever since. Suffice it to reproduce here as the harvest of this crafty logic, the famous Jewish epitaph for Palestine: **land without a people for a people without a land!**

Based principally on that self-serving axiom which wiped out the very existence of a people with a single stroke of imperial pen, that Golda Meir, the “Mother Israel” who autographed her photograph to Alan Hart with the inscription: “*To my good friend*” as reproduced above, was quoted in *Le Monde*<sup>[4]</sup> as proclaiming: “*This country exists as the fulfillment of a promise made by God Himself. It would be ridiculous to ask it to account for its legitimacy*”. Since the Jewish God cannot be unjust even to the goyem (in the Jews proclamations before the goy), so Palestinian peoples must not exist if Israel “*exists as the fulfillment of a promise made by God Himself.*” (Other intriguing Jewish convolutions on the God logic in which god suddenly died after giving the Palestine land grant to the Jews, is in Leo Strauss, *The Early Writings 1921-1932*, pg. 202, quoted in my February 08, 2009 letter to editor, *Dalit Voice*<sup>[5]</sup>. The 2010 Pamphlet on Palestine cited below exhaustively lists all convolutions on Zionism, unarguably demonstrating their one singular common purpose.)

Books upon books have been meticulously compiled on Zionism dissecting the conquest of Palestine from all directions. The Jews have themselves written major treatise admitting their crime, Israeli historian Benny Morris' *Righteous Victims*, among them. And the Palestinians have narrated of their dispossession and genocide with an eloquence which remains unsurpassed for any oppressed peoples. Compelled by an inner drive to side with a beleaguered peoples, I have cited dozens of such compelling narratives in my 28

February 2007 [article](#) “The endless trail of red herrings”<sup>[6]</sup>.

However, when we solely focus on Zionism, we somehow seem to overlook that it was constructed by someone. Who? What for? Who aids and abets it? Who is its primemover? How has it lasted that long? Which forces drive it so that it has endured for almost 200 years? AIPAC? Chabad? The Knesset? Washington?

Most significantly, who crafted such a diabolical document like the Balfour Declaration? And what power did they exercise over the mighty British empire to prevail with such an unjust demand? What is the nature of that seemingly infinite and inexhaustible power that even today, no statesman of the entire Western Hemisphere can utter an effective word or take an effective action against the Jewish state?

Such magic doesn't just happen without a primemover force – like the force of gravity whose effects all can see but not the force itself. It took several thousand years of observing its effects by all and sundry that someone came up with an accurate explanation for gravity, and with nothing more than just a falling apple. It was right there, apples have fallen from trees since the day Adam and Eve took the proverbial bite from the tree of knowledge, but the mind wasn't ready to see it until Isaac Newton.

## II

My critique of Alan Hart, and of most of the conscionable Western witnesses to the genocidal crimes against humanity being purveyed upon an indigenous peoples in Palestine during our own lifetime (not something we just read about in history books and for which we can do nothing about today), is that they only speak of what they see, rather eloquently too, but almost always superficially. Yes we all can see the dead bodies, doesn't take a Nostradamus to perceive what's already before one's eyes. But they don't speak of what they don't see. Like the iceberg, 90% is hidden from sight. And like the iceberg, it is also known to exist, and to lurk just beneath the surface. It is not secret or esoteric knowledge, nor is it a classified state-secret. And just like it is for the iceberg, most descriptions of it only describe the visible 10% above the surface. I am not sure what profound wisdom is gleaned from reading such narratives. I am sure studying and documenting crimes against humanity is necessary. If eruditely documenting is the main purpose, than I believe people are doing a terrific job of it. Even the senior Bush White House advisor proclaimed this to the New York Times in 2004<sup>[7]</sup>:

‘We’re an empire now, and when we act, we create our own reality. And while you’re studying that reality — judiciously, as you will — we’ll act again,

creating other new realities, which you can study too, and that's how things will sort out. We're history's actors . . . and you, all of you, will be left to just study what we do.' — Ron Suskind, quoting Senior Bush Advisor, The New York Times, October 17, 2004

But if changing what the “history's actors” are doing before they accomplish all their goals in incremental stages, is the main goal of dissent, then these erudite documentations etc. are as meaningless as boasted above by the history's actors themselves. This is an empirical fact. Not a matter of opinion.

If no thinker and lauded exponent of Palestine will see the 90% which gives the entire foundational substance to the visible 10%, then their articulation of the problem is only as deep (or shallow) as the 10% visible iceberg. It is forever relegated to studying the “*new realities*” being daily created by the “*history's actors*”. As they like to put it with considerable chutzpah and hubris, “*to just study what we do.*”

So, in my moments of stupidity (since no brilliant peoples like all the Nobel peace prize winners and academic professors and scholars ever seem to think of this, I must be the stupid one to do so), I have to wonder that while how easy it is to see the 10% of the visible iceberg mass for dissent-chiefs, why is it so hard to see the remaining 90% for those who do see the 10%?

Virtually without exception, all famous and lauded narrators of Palestine in the dissent-space keep coming up with faulty frameworks to explain what they do see in Palestine. The rare exception which links it to the larger global agenda in the world, is either immediately marginalized, or ignored. Or, the oddballs inexplicably marginalize themselves in the eyes of rational people who might otherwise pay attention to them, by simultaneously uttering some outlandish gibberish.

This blindsight amidst the learned simply drives me up the wall, especially when peoples, far more knowledgeable and experienced than I, indulge in it.

Why do they do that? Are they blind? Or, are they stupid? Or, am I really really brilliant? I would safely strike out the last item self-servingly put there if I were you, because I don't believe it myself. Nothing I have said in the zillion words on my website is rocket science. Then, is there some other reason for these stupidities which ought to remain unspeakable?

For what little my opinion is worth, I have still tried to address this very question in my May 15, 2010 Pamphlet “How to Return to Palestine”<sup>[8]</sup>.

And in my view, I am sorry to say that the heartfelt narratives of Alan Hart, as truly heart warming as they always are, seldom do any analytical justice to unraveling the core issues which pertain to the invisible 90%.

I am really sorry to say this of peoples' heroes. But I have to say it because that's the only way to lick this totem pole of hero worship of dissent-chiefs. To boldly challenge the lauded and brand-name narrators and give them the opportunity to think afresh. None of us are god, prophet, or all knowing and all seeing. And unless we begin to acknowledge that fact, that we aren't, that our understanding of reality must always remain tentative and continually subject to correction, that we can actually stand to gain new insights into the problem-space only if we stop pretending that we already understand it all, no freaking sunshine is ever gonna enter the dark-matter between our ears.

People throng to Alan Hart, just like to the other dissent-chiefs. He is respected, widely published, and wins many accolades for his narratives (and also the ire of his Zionist antagonists of course).

But is it rocket science that he actually misses by a mile on the hidden but only in plain sight 90% of the iceberg?

If I can see it, why can't Alan Hart? He is, I wholly admit just by looking at his imposing credentials, far more experienced, accomplished, and politically astute, than a lowly plebeian.

Omissions are a serious offence. So serious in fact, that Aldous Huxley stated it thusly:

‘The greatest triumphs of propaganda have been accomplished, not by doing something, but by refraining from doing. Great is truth, but still greater, from a practical point of view, is silence about truth. By simply not mentioning certain subjects, by lowering what Mr. Churchill calls an “iron curtain” between the masses and such facts or arguments as the local political bosses regard as undesirable, totalitarian propagandists have influenced opinion much more effectively than they could have done by the most eloquent denunciations, the most compelling of logical rebuttals. But silence is not enough. If persecution, liquidation and the other symptoms of social friction are to be avoided, the positive sides of propaganda must be made as effective as the negative.’ — Aldous Huxley, Preface (circa 1946) to *Brave New World*, 1931, Harper, pg. 11

If curious about how an ordinary plebeian thinks bluntly on the 90% that no Westerner who



is famous as an academic, a journalist, or a scholar, will touch with a ten-foot pole in their erudite scholarship, see the first three parts of My Confusion Series<sup>[9]</sup>. [Part-2](#) and [Part-3](#) are perhaps directly pertinent as a response to Alan Hart's most significant omission of his narratives.

Unless Alan Hart goes there, my going there is ineffective and wasted effort - because, I don't carry an imposing resume like Alan Hart. No one ever listens to a plebeian. But people pay much attention to someone like Alan Hart. When I sent my maiden 2003 manuscript to 30 publishers via Fedex at considerable cost, only six bothered to say no thanks. Twenty four didn't reply. I don't even know if they ever got to the right person. The publisher who published John Perkins' Confessions of Economic Hitman in 2004, on Perkins' kind referral (since I had requested him to refer me to his publisher after learning that his book too had been turned down dozens of times), talked to me by phone only to let me know that publishing is not about a cause, but about profits. An unknown first of all is hard to publish because he does not have readership. Secondly, as the Berrett-Koehler representative had put it, and this was the most disconcerting to me, one with a Middle Eastern name will be presumed to be biased by the American readers since his own peoples are being killed, hence no one will buy my book - so sorry.

In those days, I still greatly admired Noam Chomsky as he had been one of my most inspiring professors at college. My maiden manuscript sat in Chomsky's in-basket for review for months, as it did on almost all brand-name dissent-chiefs I had ever met in my life (including names like Daniel Ellsberg and Tariq Ali – to both of these prominent chiefs I had hand-delivered my manuscript, in those days I was still a bit green behind the ears), before Chomsky let me know that he will likely never get to it. He said he was too busy and there were just way too many things in his in-basket, which I interpreted as there were too many important peoples ahead of me in his in-basket.

Howard Zinn, what a remarkable teacher that late historian was, on a cold call from me to his home in Boston, immediately agreed to review my manuscript after we chatted a bit about his own million copy bestseller. In fact, Howard Zinn reviewed two drafts for me. And when I was unsuccessful in lining up any prominent publisher, Zinn even wrote me a short but stellar commendation letter to send to publishers. Despite all that, I got zero interest from any mainstream publisher. Seven Stories Press who had published Chomsky's 911 booklet (see Noam Chomsky below) also talked to me, said my book was interesting, but that they liked first-hand research (whatever that meant). In fact the title for my essay “They Dared to Knock on my door” which was the first part of my manuscript<sup>[10]</sup>, if I recall correctly, was suggested by Greg at Seven Stories Press. As I now recall, he had also noted that as an unknown in this crowded field where mainly brand-names are magnets, and others have

to have some unique hook, my narrative as a Muslim complaining about Islamophobia in America and America's fictitious war on terror just won't sell. I should look into self-publishing. Sorry.

I am not sure that Alan Hart has had such problems.

All those publisher turndowns back in 2003, at least in my case, were partly symptomatic of what is empirically obvious.

We, as part of our human nature, naturally tend to listen to those in positions of power, those with titles, those with published accolades, those who have met kings and queens, prime ministers and presidents, those who look sharp and talk sharp, and tend to accept from them, on the slenderest evidence, that which already meets with the presuppositions of our own worldview. And we concomitantly reject that which doesn't, despite preponderance of evidence, continually demanding more, more, more. It's as if cognitive dissonance prevents us from giving up our old beliefs, even reaffirming them to make them even more strongly held when shown to be wrong.

If we are in the mainstream, our heroes are the mainstream heroes. We don't hear dissent. And if we are in the dissentstream, our heroes are invariably the dissent-chiefs and we applaud ourselves for our brilliance that we are not sheep. But empirically, we are each beholden to our natural inclinations, to our worldviews howsoever we may have acquired them, whether by inheritance, or vicariously implanted by the Mighty Wurlitzer<sup>[11]</sup>.

And each of us have our own heroes and storytellers we generally gravitate toward. And it is they, our heroes, people whom we respect and admire, who invariably inform us what is the matter with whatever they might be interested in. This aspect of our natural propensity was partly captured by Bertrand Russell thusly:

'What a man believes upon grossly insufficient evidence is an index to his desires – desires of which he himself is often unconscious. If a man is offered a fact which goes against his instincts [or worldview], he will scrutinize it closely, and unless [and at times even when] the evidence is overwhelming, he will refuse to believe it. If, on the other hand, he is offered something which affords a reason for acting in accordance with his instincts [or worldview], he will accept it even on the slenderest evidence.' — Bertrand Russell, *Proposed Roads to Freedom*, 1919, page 147

What Bertrand Russell neglected to mention is that we tend to accept such narratives on "*the slenderest evidence*" more easily when it is brought to us by our respective heroes. But

Adolph Hitler didn't. He not only recognized, but also capitalized on such shrewd understanding of human psychology (see below).

Therefore, having become acutely aware of all this through my own successive failures to convince anyone of anything (unless I am preaching to the choir - and what's the great benefit of that), I began tackling peoples' heroes directly, beginning with my own hero in my earlier life, Noam Chomsky. In the slenderest hope that if I can get someone's hero to interloquite with a plebeian, and can miraculously change his mind, his flock will naturally follow. It hasn't happened yet, but I keep trying.

To you, the reader, what I say will be dismissed trivially. But have the same thing be stated by the pundit/scholar/chief you admire – well, try your own experiments. I know someone who even did the following experiment: sent one of his rejected articles again, by doing some simple word substitution, mainly replaced his own name and put “Thomas Friedman” and mailed it back. The same article which had been rejected on specious grounds of racism earlier, was accepted with that made up authorship of a Jewish brand-name, and substituting two words identifying one people with another people. I think the reader can well guess what those might have been. Later the person let the publication know that he had only done that experiment to prove to them the natural perception bias, not to mention vile prejudice which had gone into rejecting his first submission.

Therefore, through this response to Alan Hart's article, I once again try to interloquite with a brand-name chief. I invite Alan Hart, the narrator of Palestinian travails, to offer a response to an ordinary plebeian's missive by examining what's argued in Part-2 and Part-3 of my confusion series referenced above. If I am shown the errors in my thinking, I will humbly bow my head in shame and quietly slink away to rethink and relearn from the master.

Obviously, no two people agree on anything. So, the reader might well ask, what's wrong with everyone having their own point of view in dissent? It is, after all, dissent. Dissent means to disagree – don't it? The most powerful description of dissent I ever saw is this one by Vaclav Havel<sup>[12]</sup>:

'I too think the intellectual should constantly disturb, should bear witness to the misery of the world, should be provocative by being independent, should rebel against all hidden and open pressure and manipulations, should be the chief doubter of systems, of power and its incantations, should be a witness to their mendacity. For this very reason, an intellectual cannot fit into any role that might be assigned to him, nor can he ever be made to fit into any of the histories written by the victors. An intellectual essentially doesn't belong

anywhere; he stands out as an irritant wherever he is; he does not fit into any pigeonhole completely.' — Vaclav Havel, cited in Zahir Ebrahim, Responsibility of Intellectuals – Redux, March 03, 2007

So, what's wrong with each one of us standing alone, in our own little Hyde Park screaming corner, blaring our own irritants into the ears of power? Okay, some have more prominent perches than others, but that's just capitalism, egalitarianism, meritocratism. What's wrong with that? You are just upset that the NYT does not publish you or pays any attention to your submissions – why don't you go back to engineering where you still have some earned credibility, and evidently were also quite successful? What do you have to show for ten years of activism anyway? By your own admission, you haven't changed a single mind! Such cynicism is what I constantly hear from both my trusted friends, as well as my antagonists (those who were formerly my friends but today I suspect just hate my guts because I refuse to suffer fools any longer).

In fact, I was even informed by one of my very wise colleagues in Pakistan when I had offered him a copy of my unpublished manuscript as keepsake, that I was wasting my time if I expected it to make any difference even if it was published by Simon & Schuster and became a bestseller on the New York Times list. His opinion was that people don't change their mind by reading a book. (At that time I of course didn't want to believe it, but now I am convinced of that fact myself.) My uncle too had reliably informed me that I will be “disappeared” the moment I came into notice of the intelligence apparatus – and since the FBI had already visited me twice, my days were surely numbered. (That I did believe, and still do fear – but seek refuge in none except in my own faith.) All that was back in 2003 when I first started opening my mouth, and that was after I had already been exercising my legs and my lungs in anti-war protest marches since 2002-2003.

So what difference does dissent make? What has the bold courage of a handful really changed? Whether it be of those much sought after brand-named dissent-chiefs, or of the unknown tens of thousands of other individuals who feel an inner compulsion to not accept villainous matters as they are?

I sincerely believe the following: that those who principally side with truth, those who bear witness, those who seek fair justice for their fellow man, and take personal risks in doing so when they don't need to – when they could just as easily be pursuing their own 'American Dream' like the rest of silent bystanders – are all principally holding the same book (the book of justice, metaphorically speaking).

But we are not all on the same page. Obviously. That is our undoing.

Why are we not on the same page? And, why do all of us have to be on the same page?

Because, we are often unable to separate the myriad obfuscating issues into their proper causal relationships of cause and effect. The causality is also hierarchical, and often obfuscated by lower order less significant bits masquerading themselves as the higher order bits. We also often seem to confuse dependent variables of a complex system with its independent variables which are often calculatngly masked by the dependent variables for obvious reason.

In other words, the subject of hegemony in modern times is very complex - even though it may be as old as mankind - far more complex than simply the dead bodies strewn from Palestine to Iraq to Afghanistan to Pakistan which all can see.

To separate out the causal relationships which are often highly nuanced, and almost always cloaked in deception, is not easy. It requires a great deal of commonsense - a commodity which appears to be less common than the name might suggest.

So, here is a test of commonsense for the reader whose moral compulsion drives him or her to no longer remain a silent bystander: all see the power of AIPAC and Chabad, some write major treatise on how they influence the United States to favor Israel. From Paul Findley in 1985 (They Dare to Speak Out) to Mearsheimer and Walt in 2007 ( The Israel Lobby and U.S. Foreign Policy), and in the ten thousand articles across the Israel-Palestine landscape, these Zionist lobby groups are indicted for their unelected power-wielding upon the elected representatives of the people. Can you suggest what makes these Zionist Lobby groups so powerful? The brand-named academics and former elected officials who write those narratives haven't. Can you, dear reader? It isn't rocket science.

My own limited thinking on this matter is argued in the cited Pamphlet. I am sure others with more wherewithal can do much better. The problem is – all whom one imagines as having more wherewithal don't want to go there! This unspeakable iron wall no one desires to breach.

When it comes to Zionism and Palestine, a land that was taken over by deception and treachery, and whose narratives are replete with both “beneficial cognitive diversity” (ala Cass Sunstein<sup>[13]</sup>) and Trojan Horses (ala fifth columnists from among the Palestinians<sup>[14]</sup> themselves), all effectively lead the struggle away from focussing on what and who are Zionistan's real primemovers.

The struggle for Palestine has been replete with red herrings (a smelly fish that a fugitive drags across the path in order to put the pursuing dogs off the trail). Every single one of

these, as far as one can tell, is either been planted by, or aided and abetted by, lauded dissent-chiefs with brand-names. Don't believe it? See it for yourself in the already cited article "The endless trail of red herrings".

Thus, the direct addressing of the behind the scene powers which can potentially add some efficacy to the otherwise sterile pursuit of justice in Palestine, is made impossible when no one will go there. Either deliberately as fabricated or controlled dissent, or out of sheer ignorance, or out of self-preservation.

What I fail to grasp is why should the Palestinians in Diaspora refuse to go there? They have everything to gain, and only their good 'American Dreams' to lose? Is that even a fraction of what their brethren brave daily in their existential struggle on ground zero, still refusing to give in despite burying their dead daily, like the un-identified child in the [photograph](#)<sup>[15]</sup> in Alan Hart's article? But we equally see such omissions in the Palestinians' own narratives as well. This is amply demonstrated in my responses to [Salman Abu Sitta](#)<sup>[16]</sup>, [Antoine Raffou](#)<sup>[17]</sup>, [Ismail Zayid](#)<sup>[18]</sup>, [Khalil Nakhleh](#)<sup>[19]</sup>, [Shadi Nassar](#)<sup>[20]</sup>, [Mustafa Barghouti](#) and [Anna Baltzer](#)<sup>[21]</sup>, [Jeff Gates](#)<sup>[22]</sup>, [Jeff Blankfort](#)<sup>[23]</sup>, [et. Al](#)<sup>[24]</sup>.

Our collective inability to analyze causality has been deliberately made prodigious. Either through co-option, or through dumbing us down while letting us pretend that we are super-smart! I call it the "IVY League Morons Syndrome" and there is an article with that title on my website<sup>[25]</sup>. The upshot of it all is that it ultimately succeeds in keeping us from opening the book of justice which we all evidently care about, on its most significant page simultaneously. That, is the real purpose of introducing "beneficial cognitive diversity" through "cognitive infiltration" (sic!).

### III

Let's change that calculus of subterfuge and energetic runs on treadmills to soothe the conscience, which have been in any case crafted for us by the "history's actors" themselves.

But firstly, one can't change anything by patting oneself on the back for one's efforts in the pursuit of justice. Which is unfortunately largely the tenor and character of modern day dissent-chiefs as well as their flock. Not everyone is like that, but many appear to be on ego trips for their own narrow self-interests, their shrill laments on behalf of the poor victims notwithstanding.

Secondly, the rank and file of dissent, when we are conscionable peoples who do lend our



Caption A Palestinian child's indomitable courage on Ground Zero in Palestine (Photographer unknown). In order to be effective in dealing with such a multifaceted and unique adversary, a division of labor between those compelled to face the live ammunition and checkpoints on Ground Zero, and those in Diaspora living in the comforts of the West with the luxury of time and liberty to effectively focus on the prime-movers, is the rational demand of the hour. But evidently, none suffering the excruciating weekend pains of Diaspora can muster even the courage of a tiny child of Palestine!

The day a brave Palestinian narrator in Diaspora is willing to risk an iota of hair on his balding head, or underneath the fashionable headscarf, that will surely be the first day of reclaiming Palestine for their progeny. No dissent-chief, East or West, is going to do it for them. The only way they ever get to become dissent-chiefs in the first place is by not going there.

Every child of Palestinian Diaspora must learn to throw the comparable intellectual stone and be willing to risk being shot dead like the child of Palestine on Ground Zero, if they ever want to reclaim their home. The grandiose prize-winning narratives fired while resting one's mighty pen safely upon the tiny shoulders of the uncompromising child of Palestine - one who is risking it all in throwing a tiny pebble at a Goliath which can annihilate him even before the pebble leaves his tiny palm - is the grotesque caricature of the Palestinian struggle in the relative safety of Diaspora.

consciences to our moral endeavors as an inner compulsion, primarily do so to soothe our own consciences. This should be self-evident, but isn't. We, generally speaking, haven't the capacity nor the wherewithal to shrewdly employ both mind and hand to ENGINEER a struggle.

I really don't understand that when we easily see the crimes against humanity are diabolically engineered, that both consent and dissent is Machiavellianly manufactured – the engineering of consent – why we persist in feeling that we can counter villainous tyranny un-engineered? That, by just randomly, and largely symbolically, exercising our consciences, our lungs, and our pens, for whatever strikes our immediate fancy, we can make a difference whatsoever? Today that fancy is the BDS and Sailing to Gaza. Yesterday it was the endless weekend-only protest marches of a few hours before people returned to the pursuits of their 'American Dreams' on weekdays.

Not to take anything away from the courageous people who are

participating in these exercises – even the optimists will have to admit they are largely symbolic. BDS<sup>[26]</sup> is deconstructed [here](#).

And I will openly admit that if I had a tenth of the courage and a hundredth of conscience of these moral activists who are putting their precious lives on the line sailing to GAZA, even if symbolically, for symbols of resistance are equally important to any struggle, I would have joined them. Since I am thus far unwilling to brave Israeli bullets whizzing by my head, I am unwilling to say anything further<sup>[27]</sup> on the subject except to reiterate that these symbols of resistance are indeed entirely symbolic. Ten million sailing to GAZA from all directions however, would surely alter that calculus. That requires engineering. Hope and wishful thinking don't create engineering, nor do moral compulsions. The actual exercise of engineering does. That requires enormous focus, enormous resources, and more than some iota of brains to orchestrate it.

A prerequisite to engineering an effective struggle for change which doesn't solely run on the treadmill, is to understand the myriad forces which maintain the status quo. Many of these forces are masked and layered in deception. They almost always stay behind the scenes leaving their henchmen to be visible. So we neither know ourselves very well, nor unfortunately our enemy. Sun Tzu's following wisdom on the Art of War makes our shortcomings rather apparent:

'If you know the enemy and know yourself, you need not fear the result of a hundred battles. If you know yourself but not the enemy, for every victory gained you will also suffer a defeat. If you know neither the enemy nor yourself, you will succumb in every battle.'

The main harbingers of engineering any change against villainous tyranny, I have lamentably come to realize, are not going to be ordinary peoples like us plebeians. Typically, we are just the crowd who follow our leaders. I am sure you reading this is an exception. But most of dissent falls into this category.

The unfortunate reality is that very few people think independently. I have found so much truth in the oft quoted statistic by poets and sociologists alike, that "less than 2% people in any population actually think, 8% think they think, and 90% wont be caught dead thinking". Bertrand Russell too made the observation that "most people rather die than think, and they do." Hitler capitalized on that observation in Mein Kampf and in constructing the Third Reich. The same is being capitalized in constructing the Global Fourth. I have deconstructed the manufacturing of both consent and dissent, an engineered product of latter day hectoring hegemony that is entirely based on that sociological empiricism, in my report "Manufacturing Dissent" available on my website. Here is a short extract from Hitler's Mein Kampf:



## **Begin excerpt**

In journalistic circles it is a pleasing custom to speak of the Press as a 'Great Power' within the State. As a matter of fact its importance is immense. One cannot easily overestimate it, for the Press continues the work of education even in adult life. Generally, readers of the Press can be classified into three groups:

**First, those who believe everything they read;**

**Second, those who no longer believe anything;**

**Third, those who critically examine what they read and form their judgments accordingly.**

Numerically, the first group is by far the strongest, being composed of the broad masses of the people. Intellectually, it forms the simplest portion of the nation. It cannot be classified according to occupation but only into grades of intelligence. Under this category come all those who have not been born to think for themselves or who have not learnt to do so and who, partly through incompetence and partly through ignorance, believe everything that is set before them in print. To these we must add that type of lazy individual who, although capable of thinking for himself out of sheer laziness gratefully absorbs everything that others had thought over, modestly believing this to have been thoroughly done. The influence which the Press has on all these people is therefore enormous; for after all they constitute the broad masses of a nation. But, somehow they are not in a position or are not willing personally to sift what is being served up to them; so that their whole attitude towards daily problems is almost solely the result of extraneous influence. All this can be advantageous where public enlightenment is of a serious and truthful character, but great harm is done when scoundrels and liars take a hand at this work.

The second group is numerically smaller, being partly composed of those who were formerly in the first group and after a series of bitter disappointments are now prepared to believe nothing of what they see in print. They hate all newspapers. Either they do not read them at all or they become exceptionally annoyed at their contents, which they hold to be nothing but a congeries of lies and misstatements. These people are difficult

to handle; for they will always be sceptical of the truth. Consequently, they are useless for any form of positive work.

The third group is easily the smallest, being composed of real intellectuals whom natural aptitude and education have taught to think for themselves and who in all things try to form their own judgments, while at the same time carefully sifting what they read. They will not read any newspaper without using their own intelligence to collaborate with that of the writer and naturally this does not set writers an easy task. Journalists appreciate this type of reader only with a certain amount of reservation.

Hence the trash that newspapers are capable of serving up is of little danger--much less of importance--to the members of the third group of readers. In the majority of cases these readers have learnt to regard every journalist as fundamentally a rogue who sometimes speaks the truth. Most unfortunately, the value of these readers lies in their intelligence and not in their numerical strength, an unhappy state of affairs in a period where wisdom counts for nothing and majorities for everything. Nowadays when the voting papers of the masses are the deciding factor; the decision lies in the hands of the numerically strongest group; that is to say the first group, the crowd of simpletons and the credulous. — Mein Kampf, Adolph Hitler, Vol. 1, Chapter X (page numbers vary by edition and translation)

### **End excerpt**

Empiricism suggests that the main harbingers of change throughout history have always been chiefs, inspiring leaders who head their own flock who invariably follow them blindly. And unless these leaders are patsies standing in for the puppetmasters, one presumes that they are the third category of people who *“have learnt to regard every journalist as fundamentally a rogue who sometimes speaks the truth.”*

Such people, often the opinion makers for their own flock, by opening the book on the same most significant page simultaneously, and genuinely pursuing the logic which naturally falls out on that page, can surely engineer a focussed struggle for real efficacy rather than as a commodity to soothe one's conscience, or line one's pocketbooks, as it lamentably is today.

The unpleasant reality today is that narratives in favor of the 'untermenschen' (German word for 'the lesser peoples'), showing dead children and dead bodies, be they in Palestine,

Afghanistan, Iraq, Pakistan, or elsewhere along the 'arc of crisis' in the 'global zone of percolating violence' (both those terms<sup>[28]</sup> are due to the architect of *The Grand Chessboard*, Dr. Zbigniew Brzezinski), have become a commodity. It spans the full gamut of narrow self-interests.

If valid cynicism be allowed to air for a minute (I am sure I will incur the wrath of the pious), gallant people playing dissent with empire are often funded by the instruments of empire itself. Mercenaries and useful idiots alike – imperial military strategy documents refer to the latter as “surrogates”, civilians who act on the military's behalf without realizing it themselves (greed, false patriotism, being a “house nigger”, and being “tickled”, equally make convenient stooges) – willingly go on reconstruction projects from Iraq to Afghanistan in the name of bringing the bombed out peoples a taste of Western “democracy”. Witness where they draw their paychecks from? The very same Military-Industrial-Academe-Media-Nonprofit-UN complex which ab initio creates the furor and “legal legitimacy” for aggressive war under various pretexts, and which directly benefits from bombing the “poor devils” out in the first place! The manifest absurdity of this scam of destroy-build-destroy-build cycle when one is reaping its benefits, becomes rocket science to comprehend even for people with Ph.D.

The rising monetary cost of war (see [costofwar.com](http://costofwar.com)) is a great method of creating unpayable national debt, no matter who spends the money or how it is spent. *Cui bono* national debt? The relationship between rising national debt, the strangulation of the United States itself as a sovereign nation-state, and the construction of one-world government of the financial oligarchy, has been explored and documented in considerable depth on my website. One can read a succinct summary in Chapter 3 of my 2011 book: “The Poor-man's guide to modernity”<sup>[29]</sup>. Suffice it to simply state the obvious here that dissent – controlled or self-serving doesn't matter – benefits from the hegelian dialectic of their venture in many tangible as well as intangible ways.

Narratives purporting to favor the 'untermensch' often make their authors quite rich and famous. Even win them prizes for their eloquence, and sometimes accolades from the very instruments of those whom they seemingly oppose in their dissent. The absurdity of this too, of course, is entirely lost on their gullible flock who in point of fact, cheer wildly for their heroes on such occasions and carry them even more proudly upon their shoulders. They fail to take notice of the distemper that their gallant heroes of mankind themselves covet these prizes and honors, and proudly display them on their resumes. But I am sure that these gallant dissent-heroes donate every penny of their windfall proceeds back to the Palestinians, to the very victims whose narratives make them wealthy and famous.

Here<sup>[30]</sup> is Noam Chomsky, “*arguably the most important intellectual alive*” as anointed by the New York Times – the accolade proudly adorning many a backcover of his books which of course does not hurt in selling the brand-name of Noam Chomsky to the public – gallantly giving away the proceeds of his books. And here<sup>[31]</sup> is a Palestinian lawyer in the West Bank doing it for the Orwell prize he gladly accepted for his narrative from the very people who instrumented the cataclysm upon his peoples which he narrated thereof.

It is very straightforward to recognize specious opinion-makers. They generally tend to share the one common trait: **they all see the sun after it shines and hear the thunder after it roars**. That is, they see the 10% visible iceberg, after the fact, and describe it with great eloquence. Sun Tzu captured the obviousness of it with remarkable eloquence when defining the characteristics of a true warrior in the *Art of War* 2500 years ago:

'8. To see victory only when it is within the ken of the common herd is not the acme of excellence.

9. Neither is it the acme of excellence if you fight and conquer and the whole Empire says, "Well done!"

10. To lift an autumn hair is no sign of great strength; to see the sun and moon is no sign of sharp sight; to hear the noise of thunder is no sign of a quick ear.' — The Three Political Dialogs<sup>[32]</sup>, compiled by Project Humanbeingsfirst, pg. 7

I hope dissent-chiefs like Mr. Alan Hart, because of their vast celebrity appeal and consequent flock, might be of the third type mentioned by Hitler in *Mein Kampf*, and not just self-policing, self-serving, controlled dissent. That, they might in fact be more like the skilled warrior described by Sun Tzu. That he, Alan Hart, is able to evaluate what he reads not based on which of his own heroes might have written it, or his own natural proclivity to favor his own a priori worldview as Bertrand Russell effectively described it, but what it's actually saying. If Alan is that man, then by reading part-2 and part-3 of my confusion series mentioned in this article, he will either be persuaded by it and will logically open that mighty book of justice on the right page himself. Or, he will refute it.

Short of any of that transpiring, to just respond to Alan Hart's largely rhetorical question embedded in the title of his article, there is no real Palestinian power – people or otherwise. Disenfranchised masses, *the wretched of the earth*, like any other mob, are only power in the hands of Machiavelli. This is self-evident. It is even a truism. In the case of Palestinians on ground zero, they stand at the threshold of annihilation while those in Diaspora look on.

The only recourse for Palestinians today to overturn that dismal existential state of affairs they have been brought to, is to clean their own house first of their *house negroes* and fifth columnists<sup>[33]</sup>.

I could be wrong about everything in this article – judge for yourself. Don't let someone else do the thinking for you. If you, Jew or Gentile, are frustrated by the inefficacy of your labors while “*history's actors*” continue to create new realities boldly inviting you “*to just study what we do*” to your good heart's content, look into opening the book on its most significant page.

Thank you for reading the words of a plebeian.

Zahir Ebrahim

### Footnotes

[1] <http://salem-news.com/articles/july062011/palestine-chanve.php>

[2] <http://www.alanhart.net/about-alan-hart/>

[3] <http://bloghumanbeingsfirst.wordpress.com/2011/07/09/no-no-not-the-new-nazis-by-zahir-ebrahim/>

[4] Golda Meir, *Le Monde*, 15 October 1971

[5] <http://print-humanbeingsfirst.blogspot.com/2009/02/letterto-dalitvoice-which-god.html>

[6] [print-humanbeingsfirst.blogspot.com/2007/12/endless-red-herrings.html](http://print-humanbeingsfirst.blogspot.com/2007/12/endless-red-herrings.html)

[7] Ron Suskind, *Faith, Certainty and the Presidency of George W. Bush*, *New York Times*, October 17, 2004, [http://www.nytimes.com/2004/10/17/magazine/17BUSH.html?\\_r=4&ex=1255665600](http://www.nytimes.com/2004/10/17/magazine/17BUSH.html?_r=4&ex=1255665600)

[8] <http://humanbeingsfirst.files.wordpress.com/2010/09/pamphlet-how-to-return-to-palestine-this-day-forward-5-15-2010-by-zahirebrahim.pdf>

[9] Part-1 <http://print-humanbeingsfirst.blogspot.com/2010/12/how-many-jews-does-it-take-to-confuse.html>

Part-2 <http://print-humanbeingsfirst.blogspot.com/2010/12/my-confusion-invisible-rothschild-usa.html>

Part-3 <http://print-humanbeingsfirst.blogspot.com/2010/12/my-confusion-pt3-omnipotent-rothschilds.html>

[10] <http://prisonersofthecave.blogspot.com/2007/04/part-1-they-dared-to-knock-on-my-door.html>

[11] <http://print-humanbeingsfirst.blogspot.com/2009/05/note-on-mighty-wurlitzer.html>

[12] <http://print-humanbeingsfirst.blogspot.com/2007/12/responsibility-of-intellectuals-redux.html>

[13] Cass R. Sunstein & Adrian Vermeule, Conspiracy Theories, January 15, 2008, Social Science Research Network, [http://papers.ssrn.com/sol3/papers.cfm?abstract\\_id=1084585& \(cached pdf\)](http://papers.ssrn.com/sol3/papers.cfm?abstract_id=1084585& (cached pdf))

[14] <http://print-humanbeingsfirst.blogspot.com/2011/07/palestine-enemy-within-by-zahirebrahim.html>

[15] <http://humanbeingsfirst.files.wordpress.com/2011/07/image-of-an-unidentified-dead-palestinian-child-in-the-field-via-alan-hart-salem-news.jpg>

[16] <http://print-humanbeingsfirst.blogspot.com/2010/04/resp-abusitta-rothschild-not-zabara.html>

[17] <http://print-humanbeingsfirst.blogspot.com/2010/04/resp-antoine-raffoulwhat-is-iron-wall.html>

[18] <http://print-humanbeingsfirst.blogspot.com/2010/04/resp-ismail-zayid-breaching-iron-wall.html>

[19] <http://print-humanbeingsfirst.blogspot.com/2010/04/resp-palestine-contested-histories.html>

[20] <http://print-humanbeingsfirst.blogspot.com/2010/03/secretking-rothschild-roman-jerusalem.html>

[21] <http://print-humanbeingsfirst.blogspot.com/2009/11/rescuing-thestruggle-for-palestine.html>

[22] <http://humanbeingsfirst.files.wordpress.com/2010/03/zahirs-letter-to-jeff-gates-of-criminalstate-com-in-response-to-anti-semitism-what-is-it-march182010.pdf>

[23] <http://print-humanbeingsfirst.blogspot.com/2010/07/let-jeffblankfort-rothschilds-palestine.html>

[24] <http://print-humanbeingsfirst.blogspot.com/2009/11/genesis-to-genocide-golem-not-jewish.html>

[25] <http://print-humanbeingsfirst.blogspot.com/2011/01/ivy-league-morons-syndrome-zahirebrahim.html>

[26] <http://bloghumanbeingsfirst.wordpress.com/2011/04/15/response-to-leaked-zionist-strategy-paper-to-counter-bds-by-zahir-ebrahim/>

[27] <http://print-humanbeingsfirst.blogspot.com/2010/12/zahirs-response-mary-rizzo-ken-okeefe.html>

[28] <http://print-humanbeingsfirst.blogspot.com/2011/01/unlayering-middle-east-war-agenda.html>

[29] <http://humanbeingsfirst.files.wordpress.com/2011/06/the-poor-mans-guide-to-modernity-ze-ebook-print.pdf>

[30] Peter Schweizer, Noam Chomsky, Closet Capitalist, Hoover Institution Stanford University, January 30, 2006, <http://www.hoover.org/publications/hoover-digest/article/6222>

[31] <http://print-humanbeingsfirst.blogspot.com/2008/05/letter-to-guardian-2008-orwellprize.html>

[32] <http://tinyurl.com/political-dialogs>

<http://humanbeingsfirst.files.wordpress.com/2011/03/cacheof-three-political-dialogs-to-screw-your-enemy-via-gutenberg-and-aztlan.pdf>

[33] <http://print-humanbeingsfirst.blogspot.com/2011/07/palestine-enemy-within-by-zahirebrahim.html>

**Source URL:** <http://print-humanbeingsfirst.blogspot.com/2011/07/response-to-alan-hart-by-zahir-ebrahim.html>

First Published Friday, July 08, 2011

## Chapter 27 Not Fooled Again: Getting off the Treadmill of Zion

### Palestine: The Struggle Forward

By reframing the struggle for Palestine, from the struggle against the European Jewry's quest for Lebensraum on Arab soil for its Roman Jerusalem, to the struggle against the common enemy, the hectoring hegemon seeking one-world government, the Palestinians can harness the entire world's 'untermenschen' struggles against the primal global enemy of mankind.

I have realized over my many years of interaction with Zionists, that many among them genuinely believe what this anonymous person under the nom de plume "Ahmad Yaqeen", has stated in his comment to Joseph Massad's Al-Ahram Weekly article 'The Language of Zionism' [here](#). [1]

'The Arabs not only rejected partition, but attacked Israel from all sides. On the day that Israel declared its independence, the Arab League Secretary, General Azzam Pasha declared "jihad", a holy war. He said, "This will be a war of extermination and a momentous massacre which will be spoken of like the Mongolian massacres and the Crusades". The Mufti of Jerusalem, Haj Amin Al Husseini stated, "I declare a holy war, my Moslem brothers! Murder the Jews! Murder them all!" ... The fact remains that Israel is a nation state that existed 2400 years before Islam where a Nation referred to as Palestine and the Palestinian people never existed. ... When the State of Israel was reborn in 1948 c.e., the "Palestinians" did not exist yet, the Arabs had still not discovered that "ancient" people. They were too busy with the purpose of annihilating the new Sovereign State and did not intend to create any Palestinian entity, but only to distribute the land among the already existing Arab states. They were defeated. They attempted again to destroy Israel in 1967, and were humiliated in only six days, in which they lost the lands that they had usurped in 1948. In those 19 years of Arab occupation of Jerusalem, Judea, Samaria and the Gaza Strip, neither Jordan nor Egypt suggested to create a "Palestinian" state, since the still non-existing Palestinians would have never claimed their alleged right to have their own state... Paradoxically, during the British Mandate, it was not any Arab group but the Jews that were known as



“Palestinians”! ' (Comment By Zionist robot “Ahmad Yaqeen”)

Be it left-wing Zionism or right-wing Zionism, be it diplomatic Zionism or fighting Zionism, be it political Zionism, synthetic Zionism, military Zionism, friendly Zionism, tough-Zionism, gentle-Zionism, hard Zionism, soft Zionism, nihilist Zionism, spiritual Zionism, Labor Zionism, Likud Zionism, pre-Jewish State Zionism, or post-Jewish State Zionism, all remain expressions of tactics for translating motivational Zionism into empirical Zionism.

When strident young Jews imbued with the spirit of Zionism make their “Aliyah” to reclaim their lost paradise from those 'untermensch' occupying their Promised Holy Lands, they are not just playing frivolous word games, or indulging in weekend protest marches shouting at the top of their lungs for justice to prevail in the Holy Lands only to go back to their own “bread and circuses” the next day. These young Zionists are actually quite dedicated, willing to sacrifice themselves for the categorical imperative inculcated into them since birth. To their mind, Israel Project is a

moral self-defense to simply reclaim what has been theirs for 3000 years – as Shimon Peres remarked on the occasion of the 60th birthday celebration of Israel to George W. Bush: “Welcome to the new Israel: Three thousand years old, and going on sixty”. The underpinnings of the zealotry behind that celebration is examined [here](#). [2]

As seen by these Zionist zealots, mankind throughout the ages had only usurped what was granted to the Jews by their god as a sacred gift – and the modern Zionists are merely reclaiming their own properties from the bad Goy, from the evil Amelekites divinely ordained to perdition at their hands anyway, and none shall stand in the holy way of their jihad. I personally know of no Palestinian in Diaspora who can match that zealotry and commitment to cause of the Zionists. Most Palestinians I know or have met in my life are content with shedding tears in silent remembrance, which of course breaks out in boisterous sloganeering every now and then, but ultimately take their Nakba “whose parallel may only be the one of Sinai when something was revealed to mankind”, as a divine test. “Hasbi-Allahu-wa-nai'mul-wakeel” is a common prayer on many a quivering Muslim lip. But I have seen many Jewish younglings in Zionists garb who have scared me by their Zionist fervor in no less a measure than perhaps any mind-controlled suicide bomber would scare me.

The fact that Zionism also killed off their god after he had made them his 'chosen peoples' and issued them Holy Land grants, is not insignificant, nor a nonsequitur. It is a real philosophy! It forms the real impetus behind the self-empowerment and self-reliance of the

We do have a rational way forward to defang the snake of Zionism and its prime-mover harbingers. It is the calculated division of labor. A division which unfortunately has not transpired as yet.

Jews in the precise tradition of Talmudic Judaism. This phenomenon has to be comprehended at many complex levels in order to understand the unusual and unmatched power of Zionism in the world today. A tiny minority's minority which can ride a sole superpower with just the flick of a wick, as well as all the mighty European powers who just 70 to 100 years ago were purportedly so very antagonistic to them, with such brazen impunity! What's the source of such inexplicable power? Is the Jewish State

comparable to South Africa? We only see the effects in common – which leads some to believe that the same sort of tactics as were used to end Apartheid in South Africa can also work on the Jewish State. Most fail to recognize that the Jewish State of modernity is unlike any other. It has the protection of an “Iron Wall” which never mind breach, few can even see. It is a singularity, an inexplicability whose parallel does not exist in the non-mythical annals of history.

Acquiring this comprehension appears to be a limiting challenge for victims of Zionism. This is empirically in evidence even as I write this. For instance, take these conscionable peoples clamoring for BDS against Israel. I am sorry to suggest that they are being taken for the same sort of ride on a treadmill as I was when I answered the moral call of International ANSWER and participated in the protest marches in 2002-2003 hoping to avert the horrendously criminal invasion of Iraq. Since I am also an engineer by training, and performing postmortem of why things work and don't work is part of my analytical profession which itself relies on the intelligent use of “Mens et Manus” (i.e., mind and hand) to understand real world problems and engineer real world solutions that must work in order to continue collecting a paycheck, I applied that propensity borne of training to understand why the protests had not worked. How could millions of protesting peoples have been so trivially dismissed as a “focus group”? The same way that BDS will be dismissed. It was examined [here](#). [3]

The postmortems were revealing to me. And that's when I stopped attending protest marches as a means to bringing change, and more as a means to meeting other activists, and perhaps venting my lungs off its burden. Just a little bit of independent thinking, away from the influence peddling of all the lauded dissent chiefs of the West, had showed me what had been staring me in the face all my life and I just hadn't seen it. It had indeed taken a catalyzing event like the “new pearl harbor”, not just for Brzezinski's “imperial mobilization”, but also for me to finally grasp that as a matter of Machiavellian statecraft in free societies, opposition to the exercise of hegemony by its conscionable peoples must be put on treadmills of inefficacy as a matter of governance. And this can only be

accomplished by systematically instrumenting false leaders, false scholars, false dissent-chiefs, and glamorizing them enough for their public stances against hegemony, that energetic people of conscience rebelling against the tyranny of status quo will naturally gravitate towards them for moral guidance. When a pied piper leads you, how do you know where he or she is really taking you? How do you know what he really means by the words he uses to inform you? How do you know her motivation? This was explored [here](#) by this scribe, and [here](#) by Peter Schweizer, research fellow at the Hoover Institution. [4]

To liberate the Jews from the clutches of Zionism will be a major service to the Jews themselves – they can thank us later.

The Language of Zionism described by Joseph Massad, as are my examples drawn from PNAC and Brzezinski – such as “American peace”, “moral clarity”, “benevolent order” – quoted in my earlier comment to Massad's article on the same website, are only the most egregious but rather transparent examples. There are far more sophisticated mechanisms of deception, such as calculated omissions, half-truths, echoing the axioms of empire while appearing to critique its effects, and “neuro-linguistic programming”. This latter mechanism relies on subliminal manipulation and is explained [here](#). [5]

Calculated omission is perhaps the most crafty tool of persuasion as it relies on ignorance – for who can have complete knowledge of every subject? Aldous Huxley aptly called it the “iron curtain”:

'The greatest triumphs of propaganda have been accomplished, not by doing something, but by refraining from doing. Great is truth, but still greater, from a practical point of view, is silence about truth. By simply not mentioning certain subjects, by lowering what Mr. Churchill calls an “iron curtain” between the masses and such facts or arguments as the local political bosses regard as undesirable, totalitarian propagandists have influenced opinion much more effectively than they could have done by the most eloquent denunciations, the most compelling of logical rebuttals.'  
(Aldous Huxley, 1946 Preface to *Brave New World*, 1931)

Keeping thinking peoples plausibly occupied lest they discover the real levers of power is much more complicated than mere manufacturing consent among the masses who are rather easily amenable to simple propaganda. That science of mass persuasion is already well understood, thanks to the pioneering work of Edward Bernays and the Mighty Wurlitzer, not to overlook Goebbels and Hitler, as the engineering of consent from the majority. The minority of thoughtful peoples however, also often the people of conscience,

pose a different problem. They can actually think and not easily prone to the mass propaganda. If not craftily waylaid, they stand to acquire some real comprehension of the otherwise carefully hidden from the masses in plain sight, conspiratorial forces which actually shape their world. The rebels can also potentially figure out that the visible rulers whom they elect with such gravitas every four years, to presumably run their country on their behalf in a celebration of democracy which affords them the choice of twiddledee and twiddledum in a carefully choreographed Hegelian Dialectic, are actually not their public servants. To hide the fact that these psychopaths – at least on the prima facie evidence of their bizarre penchant for incessant war-mongering upon innocent peoples – whom they elect with such fanfare, are really the errand boys of an invisible oligarchy, manufacturing dissent is a necessary instrument of statecraft. It can be studied [here](#) and [here](#). [6]

With that necessary detour to illustrate how the Western peoples are manipulated between manufacturing of consent and manufacturing of dissent – the engineering of public obedience such that it can become difficult for both individual and society to comprehend the choices one is making when one follows pied pipers or gets caught up in trends and popular revolutionary movements – let's return to our main topic of understanding the forces which drive Zionism.

While some think that Zionism is the invention of Theodor Herzl, it isn't. Hardly anyone among the Palestinians I know has ever heard of Rabbi Moses Hess, who was in fact the first modern Zionist. He invented the 'Roman Jerusalem' in 1828 with Rothschild's blessings, some suggest also fundings. The fact that the Balfour Declaration was addressed to a Rothschild elder, is very significant for understanding the uncanny power of Zionism. Read Zionism's own Moses' divine tablet Rome and Jerusalem [here](#). [7]

Both Moses Hess' Zionism, as well as its offspring, the Jewish State, trace its theology of *“will to normalize the existence of the Jewish people”*, as Leo Strauss put it, to the Talmudic Rabbinical Judaism. Israel Shahak examined it in his book: Jewish History, Jewish Religion The Weight of Three Thousand Years. It can be read [here](#). [8]

And here is Leo Strauss explaining a primacy which in reality is more than 2000 years old, rather than having only just invented it himself in the prominent atheism of the twentieth century after god was declared dead by Nietzsche in the previous century:

'Political Zionism has repeatedly characterized itself as the will to normalize the existence of the Jewish people, to normalize the Jewish people. By this self-definition it has exposed itself to a grave misunderstanding, namely, the misunderstanding that the will to normality was the first word of political

Zionism; the most effective criticism of political Zionism rests on this misunderstanding. In truth, the presupposition of the Zionist will to normalization, that is, of the Zionist negation of galut [exile], is the conviction that “the power of religion has been broken”. Because the break with religion has been resolutely effected by many individual Jews, and only because of this reason, it is possible for these individuals to raise the question on behalf of their people, how the people is to live from now on. Not that they prostrate themselves before the idol of normality; on the contrary: they no longer see any reason for the lack of normality. And this is decisive: in the age of atheism, the Jewish people can no longer base its existence on God but only on itself alone, on its labor, on its land, and on its state. ...' (page 202, Leo Strauss, *The Early Writings 1921-1932*)

Look at that last sentence: “*And this is decisive: in the age of atheism, the Jewish people can no longer base its existence on God but only on itself alone, on its labor, on its land, and on its state. ...*”

With the negation of god in the above narratives, where did the Jewish people get its land, and its state?

So most thinking people tend to dismiss all this illogic of Zionism as gibberish of some sick minds, as double standards, and as hypocrisy. In my view, it is none of that, unless evil can be defined as “sick”. I don't a priori. A philosophy or an idea is only evil in relation to an absolute standard of good. Otherwise, like Justice Vinson of the U.S. Supreme Court had stated in 1951: “Nothing is more certain in modern society than the principle that there are no absolutes, that a name, a phrases, a standard has meaning only when associated with the considerations which give birth to nomenclature. To those who would paralyze our Government in the face of impending threat by encasing it in a semantic strait-jacket, we must reply that all concepts are relative.” In other words, Zionism in the modern context is just another relative concept beyond the purview of absolute definitions of good and evil. It is whatever the reigning power wants it to be. If it says it's moral, then it's moral. In fact, it is seeded in respectable philosophy by Western standards. It is the philosophy of Spinoza and Nietzsche in modern times, and of Plato in ancient times. It is the philosophy of the *ubermensch* who by the very nature of being *uber alles*, are licensed to define their own standards of morality (and this is how the Straussians read Plato's virtuous divine philosopher-king: since divine is dead, so philosopher is king, and therefore can create his own definition of virtue – which is effectively what you see Leo Strauss writing above). And this is also precisely how Vladimir Jabotinsky defined the morality of Zionism in his seminal 1923 article *The Iron Wall*. It can be read [here](#). [9]

“Two brief remarks: In the first place, if anyone objects that this point of view is immoral, I answer: It is not true; either Zionism is moral and just or it is immoral and unjust. But that is a question that we should have settled before we became Zionists. Actually we have settled that question, and in the affirmative. We hold that Zionism is moral and just. And since it is moral and just, justice must be done, no matter whether Joseph or Simon or Ivan or Achmet agree with it or not. There is no other morality.” (Vladimir Jabotinsky, The Iron Wall).

This attitude of defining morality by one's own ubermensch definition is a very profoundly banal philosophy with direct Talmudic roots. It is banal because it's the philosophy of any godfather. It is profound because it has been turned into a respectable philosophy by great minds. A philosophy which bastardized the Biblical Moses' moral message to the Semitic Jews of Canaan of an absolute moral Covenant between God and its “Chosen Peoples” (perhaps for spreading the divine light among mankind – otherwise why else?), to an ubermensch 'chosen peoples' created to lord upon the “goy”. There is simply no other rational and commonsensical way of semantically capturing the rise and fall of Judaism from divine to uber alles, whether or not one believes in divinity. Judaism is empirical, as is Christianity, and so is Islam, Hinduism, and Bhuddism, the major surviving ancient dogmas and religions of mankind today. As a philosophy, all great religions of mankind have some universalistic spiritual and moral underpinnings. Only the 'ubermensch' Judaism of the three Abrahamic religions acquired this peculiar character of 'uber alles', meaning, above all the others, in its self-defined continuously evolving morality “to normalize the Jewish people”. While Leo Strauss attributes it to the age of atheism, empiricism indicates that this has in fact been the norm of the Rabbis throughout the past 3000 years!

“Terrorism requires only a few. Obviously the West must defend itself by whatever means will be effective. But in devising means to fight the terrorist, it would surely be useful to understand the forces that drive them.”

If the existence of Moses isn't merely a mythology as some modern skeptics suggest, and the Jews did indeed receive a sensible moral code from the Prophet like the universalistic Ten Commandments, then, Judaism's corruption to that perversity of the 'ubermensch' was entirely the work of the Talmudic Rabbis. And it was this long historical perversion as the overarching ethos of the Jewish tradition, which enabled casting Zionism as a moral philosophy, a moral imperative of the Jews, and a moral pursuit. Hence anything in opposition to it is by definition immoral. Consequently, it is to be repulsed by any means

possible, including 'Noble Lies' (Leo Strauss), and mercilessly killing any goy who might interfere with the existence of the Jewish State, or interfere with its imperatives. This lofty

morality of Zionism can be seen in the recent Law Book of Israel, “The King's Torah” (or “The King's Teaching”) for instance, written by a settler Rabbi occupying the West Bank, Rabbi Yitzhak Shapira: *“In any situation in which a non-Jew's presence endangers Jewish lives, the non-Jew may be killed even if he is a righteous Gentile and not at all guilty for the situation that has been created”*. Read more about it [here](#) or [here](#). [10]

This sort of perverse ethos ingrained among the 'chosen peoples' against the 'goy' has endured the vicissitudes of time for over two thousand of years. That's a lot of historical and cultural baggage in ancient to modern books to be carrying upon one's cultural, religious and philosophical back. Such entrenched ethos is the primal motivation for “Aliyah” which none but the Jews who espouse Zionism can appreciate. One cannot underestimate this motivation. It forms the fundamental basis among world's Jewry for supporting the Jewish State no matter where they live. It enables recruiting agents, assets and sayanim from among them as described by Victor Ostrovsky in *By Way of Deception*. It can be read [here](#). [11]

As formidable and incomparable as that ethos is, it is still mere motivation. Not its enactment, and not its harvesting. Without a harnessing force, the motivation remains still-born. The only way Zionism could find empirical expression globally was with massive funding, massive political power, and massive alignment with ruling imperial powers. Where did all that magically come from? If the Western world was so anti-Semitic, how did the most hated and reviled people in Europe convince their own oppressors? The Zionist narrations tell us of this and that magical powers of persuasion of this or that Zionist leader. Without a prime-moving force backing them, and it being known that they represent that power, such magic is only for bed-time fiction. In the two hundred years since Moses Hess, Zionism's global expression is entirely manufactured with those three instruments mentioned above. Before that, the aspiration for Zion existed mainly in books and in prayers. Its ubermensch Talmudic philosophy only found expression in the Jews' local life among the goyem in various ad hoc forms, primarily as the underpinning of a battle of survival of the minority among an inimical majority who blamed that minority for having killed their lord Jesus. And the Jewish minority under the leadership of their dictatorial Rabbis, holding itself off as superior to all others and refusing integration with the majority. That dynamics was always local until the Zionism of the globalists made it global.

Be it left-wing Zionism or right-wing Zionism, be it diplomatic Zionism or fighting Zionism, be it political Zionism, synthetic Zionism, military Zionism, friendly Zionism, tough-Zionism, gentle-Zionism, hard Zionism, soft Zionism, nihilist Zionism, spiritual Zionism, Labor Zionism, Likud Zionism, pre-Jewish State Zionism, or post-Jewish State Zionism, all remain expressions of tactics for translating motivational Zionism into empirical Zionism.

Without the continuity of an immensely powerful financial prime-mover – from which all else follows – motivational Zionism would remain a theoretical idea in dusty old books to primarily torture young orthodox Jewish seminary students and secular atheists in Western universities with. Who'd ever pursue it as a categorical imperative in the enlightened modernity du jour where Jews can hardly draw on any empirical evidence of their oppression to motivate their flock? Before two hundred years ago, most Jews were not the Zionist of today, even though, they did harbor these same ubermensch underpinnings. The translation of a tortuous philosophy from ancient books to existential global enactment is entirely the premeditated act of fabrication. That requires a prime-moving force. It is the willful act of money, and the willful act of conniving power, a power which can systematically mold, manipulate, corrupt, and indoctrinate across generations, across countries, and across the barriers of time and space. This is not an organic natural spread of a plague – for it could not be sustained for 200 years un-abated! It is more akin to the deliberate spread of a biowarfare agent of maximum penetration. The Zionist robot commenter mentioned in the beginning of this article is a tragic victim of this plague.

That is the only reasonable explanation for how Zionism can simultaneously combine so many opposites without their turning on each other – from vehemently orthodox right-wing Zionist settlers bobbing at the wailing wall praying to their god with guns slung over their shoulders, to the secular atheist left-wing Zionist ideologue fanatics who still believe that being Jew means something divine, uber alles, a race with their own categorical imperatives of primacy.

Whereas antagonists within other religiosities of far less theological dispersion tend to turn their guns upon each other first! Why does that not happen among the Jews? We can have Protestants and Catholics on each others throat, we can have Sunni and Shia on each others throat, but I have never heard of the many different polarities of Zionists in the past 100 years on each others throat. Within just that epoch, we had a 100 million Christians barbarically kill each other, and many million Muslims barbarically kill each other! Not to forget the 6 million Jews of course, mercilessly Holocauste<sup>TM</sup> by the Christians, but for which the Muslims are being compelled to pay the price by the Jews and the Christians now inexplicably and suddenly teaming up. If we simply examine the recorded facts of who were the major war-mongers who created and supported all the wars of the twentieth century – the Century of Wars – and who participated in the peace-conferences after each one and what was systematically achieved, a perspective which can finally begin to see the outlines of the trumpeting but apparently invisible elephant in the bedroom quickly emerges. In every single instance, there is only one common prime-mover without which, these synthetic clashes could not have materialized. The owners of the private central banks. As the pithy saying goes: “give me control of a nation's money supply and I care not



who makes its laws". That's because all else follows by simply controlling the instruments of money. Which is why, such a fundamental power is called the prime-mover. It is examined [here](#) and [here](#). [12]

Suffice it to say, the prime-mover force behind Zionism brings a lot more diabolicalness, and a lot more internal cohesion from its apparent random diversity, to the realization of the physical Jewish State in Palestine than meets the superficial eye. And they are even able to legalize it without causing any internecine bloodshed among themselves!

According to Lasse Wilhelmson, there was a law passed in Israel in the mid 1980s which made it illegal to challenge the character of the state of Israel. The nature of the Jewish State cannot be questioned. It is an axiom of Zionism, as well as an axiom of law by the fiat of legality. There can be no political party with a platform which seeks any transformation to the Jewish character of Israel, taking part in its political process. There can be no transformation by the way the axioms of the Jewish state are constructed – some articulated, such as Jabotinsky's assertion that Zionism is moral, and others not. Therefore, realistically, there can be no transformation so long as the prime-movers behind Israel wield the force of Zionism. The visible Zionists, whether in Israel or in the rest of the world, would be powerless without the prime-mover which unites them. Putting it another way, the many colored Zionist robots are merely the replaceable foot-soldiers fabricated in a 'Sony' factory and enacting the diabolical interests of the prime-movers. Perhaps they too are being made a patsy, as a Hegelian Dialectic, just as they routinely make the goyem a patsy. This was explored [here](#). [13] While many reformed Jews who have weaned themselves away from Zionism will freely describe the real abhorrent character of the Jewish State in great honesty, few will dare to address the real prime-mover force behind Zionism. It is almost like a religion of pretense that such a prime-mover force does not exist. See for instance, Lasse Wilhelmson who does a good job on the former, but is inexplicably silent on the latter, in Zionism – more than traditional colonialism and apartheid [here](#). [14]

The Zionist Jews, among all the other peoples on earth, are the ones being criminally forced to most closely live their own baggage of history by these prime-movers. That is an empirical fact which is often not considered by the victims of Zionism in understanding the uncanny forces which drive their formidable enemy.

To liberate the Jews from the clutches of Zionism will be a major service to the Jews themselves – they can thank us later. The motivations which drive Zionism have been made ubiquitous in the West and the invisible force enabling that fact cannot be underestimated. Its uncanny power to co-opt primary loyalties of Western statesmen, their

institutions, their universities, their global corporations, as well as a large majority of Christian masses, is empirical. But it is easy to confuse cause and effect when protesting that primacy of the “chosen peoples”, especially when the former remains invisible to the public eye while making the effects most egregiously visible!

Therefore, focussing on very visible Jewish political action groups like AIPAC, ADL, JDL, Chabad Lubavitch Hasidics, et. al., who put Israel first to influence the superpower's policies, or the hundred Jewish-dominated opaquely funded private think-tanks like the AEI, CFR, et. al., who ab initio construct the polices of war and hegemony favoring Israel, without betraying any comprehension of the actual prime-movers behind them, is not only an exercise in futility, but these visible magnets are deliberately there, and manifest themselves with their inexplicable arrogance, precisely in order to draw fire away from the invisible prime-movers!

While many betray that they are aware of the motto “wage war by way of deception”, I am sorely disappointed that very few in the West, never mind among the victimized beleaguered Palestinians, actually betray what it means when it comes to understanding front-men and front-organizations representing a powerful oligarchy. Only as the representatives of some mighty force not in the public eye, do the foot-soldiers in the public eye acquire the immense power that we see them wielding. When the White House and the Congress pays obeisance to AIPAC for instance, they are paying homage to the king behind them. If unfamiliar with this state of affairs, see Colonel Edward Mandell House's depiction in Philip Dru: Administrator.

Rather than betray the acuity of having forensically recognized this modern mechanism of statecraft, of wielding power from behind the scenes, recording ex post facto narratives is the epitome of Western scholarship. Not all of it manufactured of course – but much of it suffering from psychological cataracts which enable seeding the faits accomplis of these front-men as “history's actors”:

'We're an empire now, and when we act, we create our own reality. And while you're studying that reality -- judiciously, as you will -- we'll act again, creating other new realities, which you can study too, and that's how things will sort out. We're history's actors . . . and you, all of you, will be left to just study what we do.' (Senior Bush Advisor, The New York Times, October 17, 2004)

This is why neither protest marches, nor BDS, nor tea-parties, nor sailing to Gaza, nor the ISM's taking bullets to their head in the holy land of oppression, nor bearing witness, nor

attempts at reforms, nor end the fed campaign, etceteras, can ever work. Because, these address the symptoms, the mere incantations and projections of power, and not the prime-mover forces behind them. To the extent that these symptomatic motivators are able to rally conscionable well-intentioned thinking peoples behind them, is the extent of the success of fabricated dissent, of putting people on the treadmills of inefficacy. As an engineer, a systems architect bringing a systems analysis perspective to deconstructing political science and social engineering, this is my commonsensical, technical, and empirical assessment. One has to go straight for the jugular of the tiny misanthropic coterie wielding the immense prime-mover force to be effective in overcoming all the abhorrences being seeded by their numerous psychopathic errand boys across the planet, including in Zionistan. See for instance, Who is more guilty of monumental war crimes – the prime-movers or trigger pullers?, [here](#). [15]

It is important to reemphasize: it is not their thoughts or their motivations which are a crime. People are free to have any thoughts, and entitled to believe any crap they want. It is only their acts, or when their motivations lead to, or sustain, or otherwise in any way interfere in redressing the crimes perpetuated against an innocent peoples, which are a crime. The Nuremberg Military Tribunals aptly emphasized that core principle before hanging the old Nazis, military men, civilians, propogandists and philosophers alike (while setting free the principal financial architect of the Third Reich, Dr. Hjalmar Schacht, explored [here](#) [16]).

“The intellectual bankruptcy and moral perversion of the Nazi regime might have been no concern of international law had it not been utilized to goosestep the Herrenvolk across international frontiers. It is not their thoughts, it is their overt acts which we charge to be crimes.” (Robert H. Jackson, Last Day Closing Speech, Nuremberg).

But as Bernard Lewis also convincingly argues in “Crisis of Islam – Holy War and Unholy Terror”:

“Terrorism requires only a few. Obviously the West must defend itself by whatever means will be effective. But in devising means to fight the terrorist, it would surely be useful to understand the forces that drive them.” (page xxxii)

That's one shrewd empirical wisdom I have never contended with Bernard Lewis on. And I apply it myself to understand the motivations of the superterrorists. And not just Zionists, but all hectoring hegemons. For truly, “in devising means to fight the [super]terrorists, it would surely be useful to understand the forces that drive them.” However, it is not just the

examination of motivational forces of history and philosophy, but also the dynamic contemporary prime-mover forces which empirically wield such an immense power that none can interfere with Zionism in its genocide of the Palestinians, and yet themselves remain practically invisible to the victims.

Exactly like an invisible “Iron Wall”, which the beleaguered victims simply cannot breach! These words of Jabotinsky have far more import than has been accorded them:

“This colonization can, therefore, continue and develop only under the protection of a force independent of the local population – an iron wall which the native population cannot break through.”

What is that “force independent of the local population”?

Hitherto, almost all students of the “Iron Wall” have thought it as the Jewish terror of the awesome Israeli military power, the fourth largest military power on earth according to the British Institute of Strategic Studies after the USA, the Soviet Union and the People’s Republic of China – well ahead of nations like Britain and France. Whereas I perceive that Jabotinsky’s “Iron Wall” is referring to something far more fundamental than merely an effect. It can only be referring to an invincible prime-mover. Only that empirically explains the inscrutable and indomitable power of international Zionism which pervades all the Western capitals. This understanding also enables looking for that infinitely resourceful prime-mover and to elevate the battle against Zionism where it can actually have some efficacy. And this has been the power of the prime-mover – its ability to stay hidden from the public eye and leave the people merely grappling with the effects!

When a people believe something, whatever may be the merits of the belief, and acquire the power to enact that belief, what is the primary enemy to address in order to effectively counter it: 1) the visible expression of that power; 2) the hidden motivations that drive that visible expression of power; 3) the hidden prime-movers who ab initio fabricate and harness that motivation into a political goal and orchestrates it with all their financial and political might through those errand boys we see in the visible expressions of power while they themselves remain hidden from public view?

I leave it for the reader to explore those simple questions for themselves. A reasoned determination of causality, the forensic distinction between cause and effect, and an understanding that people have deliberately been led to focus on the effects, then logically ought to define their next pursuits. I wager that following logic and rationalism, as opposed to religion, feel-goods, and other emotionalisms, the reader will come to the same logical

conclusions as reached by this scribe. Either kill the golem with a thousand cuts, but that does require administering a thousand cuts and preventing each wound from coagulating, or, directly reach for its heavily protected heart and yank it out. All else is touchy-feely spiritualism. A run on the treadmill of Zion's own construction crafted for the beleaguered people!

Returning to focus on Zionism and the forces which drive it, initially, as a young man tremendously angered by the horrendous Zionist oppression of Palestinians, I didn't comprehend this motivational mindset. And over a period of three decades of earnest interlocution with Zionists of all shades, both friendly, and not so friendly, even including with my own teacher Noam Chomsky, I still haven't figured out how to address such ingrained zealotry borne of systematic indoctrination that commences from the time when they are in their mother's womb, with any measure of efficacy. Wait just a minute you might well ask at this point if you haven't been entirely dozing off, Noam Chomsky indoctrinated? Well, I am just giving him a non-criminal way out for his support of Zionism, because I can't see why would he otherwise, as a left-wing atheist, even be a self-proclaimed Zionist? He is not of Semitic Middle Eastern origin, and like his ancestors, he was not born in Palestine. In most likelihood, he is a Khazar in origin. Why would he even aspire to be an idealist Zionist of the "1940s" variety, even if only seeking its expression in a "binational state"? There is simply no explanation for this irrationality coming from an uber-rational scholar who is even anointed "arguably the most important intellectual alive".

To make the absurdity of this manifest, it is somewhat like my aspiring to be Semitic like the Arabs when I am from the Indian sub-continent, and arguing that the Arabs should gratuitously live with me in a binational state on their own land! Isn't that absurd? What makes Chomsky a Zionist aspiring for a binational state for himself in someone else's Semitic homeland? There is simply no rational basis for such an aspiration – except, either being a colonizer, or being indoctrinated since birth, and in either case arguing the legitimacy of power and the reality on the ground, instead of moral right, to back it up. The fact that this criminal absurdity of validating the legitimacy of force to create unjust rights which do not naturally belong to one, is not visible to a scholar like Chomsky, can only be attributed to the psychological cataracts due to indoctrination. I can't really believe that a teacher of morality otherwise, like the Golden Rule, and always demonstrating a repugnance for hypocrites time and again in public talks, can also be a hypocrite colonizer himself. To his credit, he did not live in Israel, and moved back to the United States after being there in the 1950s and recognizing the injustices that had been purveyed upon the indigenous peoples in order to create a homeland for the Jews. But having profoundly recognized that reality, why justify it as an act of "international" agreement among nations endorsed by the United Nations? Why not principally call for Israel's outright dismantling as

an Apartheid state, for permitting the Palestinian refugees to return, for paying restitution and compensation in the same measure as the Jews are extracting for Nazi crimes?

See my essay which has already deconstructed the convoluted theologies of the so called “soft Zionists” who ostensibly support the Palestinians for an hypothetical severely emasculated “Palestinian state” carved out of their own vast indigenous homeland gratuitously gifted away to the Jews; who boldly speak-out against the Israeli aggression; who at times even longingly speak of an hypothetical binational state, which some progressive Zionists today also pitch as “onestate” without fully explaining the semantics of what they actually mean by it – and it invariably does not include Palestinian refugees returning home; but all the while making continuous fools of the victims with red herrings a plenty in the best mold of “beneficial cognitive diversity” to buy time until realities on the ground become impractical to reverse. Then, they glibly claim that the realities on the ground are impractical to reverse! The analysis can be read [here](#) and [here](#). [17]

Recognizing such convolutions for what they are, is such a crucial and contemporary matter that it requires further elaboration. Professor Sholmo Sand is the new rage in the Palestinian town. Who hasn't heard of him or his book: *The Invention of the Jewish People*. He is a new hero among the Palestinians – well, among some at least, and like Professor Noam Chomsky before him, some excitedly carry him upon their head and shoulders just like they carry Professor Norm Finkelstein and many others. In fact, anyone from among the Jews who will sympathize with them becomes a new showcase for the Palestinians. Anna Baltzer is only the most recent example of that. Her leading performance with Dr. Mustafa Barghouti on American television left much to be desired. It is deconstructed [here](#). [18] The indiscriminate attachment to Jewish sympathizers of Palestinian plight and permitting them to become the leading spokespersons for the Palestinians has been great for ensuring that the Palestinian narrative before the Western public is also controlled by the Jews – even though they be most earnest in their show of sympathy. The “soft Zionists” on the “left” have largely set the boundaries, or the book-ends, for the discourse on resolving Israel-Palestine in the West. Only a colonized mind accepts the victimizers to be their liberators. This is also a rather murky area and it is not easy to always know where to draw the line. Or whether there should even be a line in an honest common struggle when one sees enormously courageous Jews of conscience laying down their own precious lives on a matter of principle, like those in the ISM bearing witness to crimes against humanity and being shot dead by the Israelis. But let's just stay with the imposing Jewish academic in this article.

Look what Professor Shlomo Sand says in the following interview – and incidentally, after reading this interview, I lost all interest in reading his book which doesn't contain anything

new for me anyway beyond what was revealed in *The Thirteenth Tribe: Khazar Jews – The revelation of another Jewish hoax*, By Arthur Koestler, 1976. It can be read [here](#). [19]

Shlomo Sand's statements in *Ha'aretz*, 21/03/2008, *Shattering a 'national mythology'* By Ofri Ilani, can be read [here](#). [20]

### **Begin Excerpt**

“My initial intention was to take certain kinds of modern historiographic materials and examine how they invented the 'figment' of the Jewish people. But when I began to confront the historiographic sources, I suddenly found contradictions. And then that urged me on: I started to work, without knowing where I would end up. I took primary sources and I tried to examine authors' references in the ancient period – what they wrote about conversion.”

“The supreme paradigm of exile was needed in order to construct a long-range memory in which an imagined and exiled nation-race was posited as the direct continuation of 'the people of the Bible' that preceded it,”

“I started looking in research studies about the exile from the land – a constitutive event in Jewish history, almost like the Holocaust. But to my astonishment I discovered that it has no literature. The reason is that no one exiled the people of the country. The Romans did not exile peoples and they could not have done so even if they had wanted to. They did not have trains and trucks to deport entire populations. That kind of logistics did not exist until the 20th century. From this, in effect, the whole book was born: in the realization that Judaic society was not dispersed and was not exiled.”

[Interviewer]: If the people was not exiled, are you saying that in fact the real descendants of the inhabitants of the Kingdom of Judah are the Palestinians?

“No population remains pure over a period of thousands of years. But the chances that the Palestinians are descendants of the ancient Judaic people are much greater than the chances that you or I are its descendents. The first Zionists, up until the Arab Revolt [1936-9], knew that there had been no exiling, and that the Palestinians were descended from the inhabitants of the land. They knew that farmers don't leave until they are expelled. Even Yitzhak Ben-Zvi, the second president of the State of Israel, wrote in 1929 that, 'the vast majority of the peasant farmers do not have their origins in the Arab conquerors, but rather, before then, in the Jewish farmers who were numerous and a majority in the building of the land.'”

[Interviewer] Why do you think the idea of the Khazar origins is so threatening?

“It is clear that the fear is of an undermining of the historic right to the land. The revelation that the Jews are not from Judea would ostensibly knock the legitimacy for our being here out from under us. Since the beginning of the period of decolonization, settlers have no longer been able to say simply: 'We came, we won and now we are here' the way the Americans, the whites in South Africa and the Australians said. There is a very deep fear that doubt will be cast on our right to exist.”

### **End Excerpt**

If Professor Sand himself argues that there is no such thing as a Jewish people, and the Arab Palestinians are the original inhabitants of Palestine, then on what basis does he say the following:

### **Begin Excerpt**

[Interviewer] Is there no justification for this fear?

“No. I don't think that the historical myth of the exile and the wanderings is the source of the legitimization for me being here, and therefore I don't mind believing that I am Khazar in my origins. I am not afraid of the undermining of our existence, because I think that the character of the State of Israel undermines it in a much more serious way. **What would constitute the basis for our existence here is not mythological historical right, but rather would be for us to start to establish an open society here of all Israeli citizens.**” (emphasis added)

### **End Excerpt**

It is common among this breed of scholarly Zionists – which is perhaps why they also remain light-years ahead of the Palestinians – to argue among themselves not just whether Palestinians are a people (as both Moshe Katsav, Israel's former President, and Raphael Eitan, former Chief of Staff of the IDF, have variously pondered; it can be read [here](#) [21]), but also whether even Jews are a people. It's even reported in the New York Times: Scholars Debate Roots of Yiddish, Migration of Jews, October 29, 1996, which can be read [here](#). [22]

There is nothing new Professor Shlomo Sand has to offer Palestinians in the Zionist's endless cycle of their own myth-constructions and their own myth-destruction, except a new twisted justification for the invaders to continue to occupy Palestine, despite himself arguing that he does not have any roots there! But wait, he is not packing up to leave as a matter of conscience, as a matter of principle, after learning all that truth about the myths he had



been fed. Now, it is the new mantra of “establish an open society here of all Israeli citizens.”!

It's akin to a robber comes into my house, takes over on the pretext of an asinine justification that god gave this land to his ancestors and I am the illegal occupant of his house; me and my children spend all our lives trying to show that world that the robber is not only criminal taking over my house but also an expert liar; then, a few years later, the robbers' children and grandchildren create a different drama, some showcasing books variously showing a) that there is no god and “in the age of atheism, the Jewish people can no longer base its existence on God but only on itself alone, on its labor, on its land, and on its state”, and b) that even there is no Jewish people; but the current crop of legatees still want to stay in my house which he illegally occupied to start with?

Is that absurd? But not in Alice in Wonderland.

Surely the following reaction is not absurd. It is understandable psychologically: Now my beleaguered family members are overjoyed by that statement of the robber, who is thus far forcibly living in my house, that yaaay, we can all finally live together in the house in relief because now we will have the same rights to go to our own bathrooms and roam inside our own entire house without having to first beg permission from the invaders occupying my house!

Yes, I can well imagine my children saying that to me excitedly, but in hushed whispers if I was in that position and Shlomo Sand's proposal was about to become a political reality. Then, the reconciliation would become the new mantra to legitimize the conquest. And I can also well imagine just being grateful for that bit of relief – that, I will now, finally, be able to roam in my own house without checkpoints and a suffocating wall, even if I might be still stuck with the invader and his oppressive alien culture and civilization, his hijacking of my culture, and his decimation of my previous history, culture, civilization, records, libraries, books, artifacts, and most of all, my ancestors and some of my children.

Apart from the fact that this strategy of temporary relief after enormous stress being the obvious Jabotinsky's “Iron Wall” method of getting the victims to acquiesce to their predicament when they have no other choice, and then the “compromise” even comes as a relief to them, the reconciliation will also be only as advantageous for the Palestinians as it has been for the Blacks in South Africa. They can vote and travel anywhere they want, while still living in their slums, and that's a good enough start – better than staring down the gun-turrets 24x7, not to mention being daily showered in Shoah. And in that reconciliation, there will be, practicably, no Right of Return. Take careful note of it – any compensations

will be with only funny-accounting and funny-money. The Palestinians in Diaspora will remain holding the keys to their homes forever, outside Israel in this new Israeli open society. That's what I suspect Shlomo Sands means by his “establish an open society here of all Israeli citizens”. He could also have straightforwardly stated that in his new open Israeli society, all displaced Palestinians would be permitted to return home, and all victims of Zionism would be compensated by the same measure as the Jews have sought from the Nazis! And the Diasporans celebrate his book? Absurd!

I am making only an argument here of sensibly what's morally right and what's morally Just. I am not arguing what a Palestinian ought to settle for to make peace at any price. They will first and foremost, be sold out by their own House Negro leadership, perhaps under the sound of the white man's trumpets and Hallelujah-Arabic songs singing during Nobel Peace Prize ceremonies. In that latter space, of resignation to fate and gratefully receiving whatever charity the oppressor hands them out of the generosity of its cold-blooded calculating heart, the victims are suffering from their own natural victimhood. To understand that side of the picture, of the victims echoing their victimizers' message in long-running traumas of mental colonization, I refer the reader to the writings and speeches of MLK and Malcolm X. It can also be gleaned in the FAQ [here](#). [23] My letter to documentary-maker Wendy Campbell highlights the most recent aspect of it, the case of Dr. Mustafa Barghouti basking in the glory as the 2010 Nobel Peace nominee. This chap shows not an ounce of dignity and self-respect in adopting the language of Zionism and happily receiving the victimizer's applause – and yet, he too is a victimized Palestinian who has bravely suffered the Israeli occupation. Putting such co-opted learned peoples in-charge of the Palestinian leadership is part and parcel of the colonization process. The letter can be read [here](#). [24]

This article is not about the cracks and lacunae among the beleaguered victims and their lack of wherewithal in dealing with an infinitely more sophisticated enemy who appears to be light-years ahead of them in Machiavelli, all of which has been addressed elsewhere.

This article is entirely about understanding the forces behind the oppressors, cued off from the comment of a Zionist robot, to find a way forward through the maze of Zionist robots of different types, shapes, and lethality that are sent by the prime-mover forces to implement the colonization process by means so deceptive, that it can only be accurately described in the diction of their own intelligence motto: Waging war by way of Deception!

Conversations with indoctrinated robots of all types, Evangelical Christians, to Zionists, to also Muslims, even atheists, once upon a time as an energetic young student, used to consume enormous amounts of my time. I could never quite comprehend the inability of “others” to see what's right in front of their nose. Until I realized that indoctrination and

socialization into a world view is part of the general human condition and plagues people quite democratically. It creates the “psychological cataracts” (borrowing MLK's terminology) which cannot be seen by the afflicted if they think there is no problems with their sight!

Therefore, I no longer indulge in such futility of dialog when it's obvious that the conversation is merely a power-play and not a genuine quest for knowledge or discovering truth. Indoctrination cannot be argued nor debated with. In point of fact, in political Machiavelli, such interlocutions become a clever tactic for keeping the Goy busy in idle pursuits, sort of the “bread and circuses” equivalent for those among the Goyem who like to think. It is used to defocus attention of the genuine truth-seekers; the real moral activists who seek to learn; who discuss not to orchestrate an a priori agenda, but to know for themselves and by knowing, to affect the cause of justice and fairness. And that's why “cognitive infiltration” is used to distract the real truth-seekers. That's what “beneficial cognitive diversity” is for, and it permeates the Israel-Palestine discourses in the West. The word “beneficial” is in the language of Zionism, like “*American Peace*”. See for instance, its exposition in President Obama's Information Czar, Harvard's Cass Sunstein's 2008 paper on “Conspiracy Theories”. The official dictionary for the Language of Zionism, titled: Israel Project's 2009 Global Language Dictionary, is [here](#). [25]

Nowadays when faced with indoctrinated zombies, which is most of the time, I pertinently point to what their own ilk have written in counterpoint, and remain silent. Let all indoctrinated peoples play with each other and with themselves in the cesspool of their own endless academic theses, which in this instance of Palestine, is whether the Palestinian peoples are an invention or not, whether they are even human or not, and whether they are actually from another planet or not.

Palestinians do not have to partake in the immanent orgies of imbeciles being used as foot soldiers and canon fodder by their elite. Their battle for survival is not with the robotic indoctrinated foot soldiers of Zionism, but with its prime-movers – the common financiers of all hectoring hegemony who are primarily responsible for translating political philosophies from the realm of immanence, tortuous or not, into the realm of empiricism. Those first-cause enablers of translation from theory into practice are thus culpable before any of their indoctrinated foot-soldiers can be held culpable.

Thus while one must understand the motivation which drive these robots of Zionism, to counter them effectively, one must counter their prime-movers! That is the only way. And so long as the prime-movers remain hidden, how can they ever be countered? The role of the House of Rothschild in fabricating Zionism, and also being the prime-mover force behind one-world government, is introduced [here](#), [here](#), and [here](#). [26]

Interestingly, that rule of ascribing culpability is also the message of Islam to create amity among mankind that is despoiled by the corrupt and the war-mongers among us who set the entire society ablaze with their matches and fuel. It is also the basis of an enduring inner-peace for the Palestinians – they will not suffer from the psychological scars past their suffering-generations like the Jews have endured the baggage of 2000-3000 years. Islam is a very spiritually-cleansing force as both a psychology, and a philosophy. And I do believe so is Christianity, minus the mumbo-jumbo of its church's officialdom. And through both of them, the Jews can reclaim their own lofty teachings of the real Prophet Moses – the universal Ten Commandments which is a proper subset of both the teachings of Christianity and the teachings of Islam. As Edward Said had stated in the *The Mirage of Peace*:

“Palestine/Israel is no ordinary bit of geography; it is more saturated in religious, historical and cultural significance than any place on earth. It is also now the place where two peoples, whether they like it or not, live together tied by history, war, daily contact and suffering. To speak only in geopolitical clichés (as the Clinton Administration does) or to speak about "separating" them (as Rabin does) is to call forth more violence and degradation. These two communities must be seen as equal to each other in rights and expectations; only from such a beginning can justice then proceed.” (Edward Said, *The Nation*, October 16, 1995)

Was Edward Said kidding that: “These two communities must be seen as equal to each other in rights and expectations; only from such a beginning can justice then proceed”? Am I kidding when I suggest that all the fundamental seeds for sowing such a fair Justice already exist among the peoples?

Let me just show it from the religion of Islam's teachings to imagine what can transpire in the presently aggrieved Arab-Muslim ethos within the passage of a single generation or less if the calamity that has befallen us is lifted with actual fairness and equity, and not merely in the Language of Zionism:

“It was We who revealed the Torah (to Moses); therein was guidance and light. By its standard have been judged the Jews, by the Prophet who bowed (as in Islam) to Allah's will, by the Rabbis and the Doctors of Law: for to them was entrusted the protection of Allah's Book, and they were witnesses thereto: therefore fear not men, but fear Me, and sell not My Signs for a miserable price. If any do fail to judge by (the light of) what Allah hath revealed, they are (no better than) Unbelievers. (44) We ordained

therein for them: "Life for life, eye for eye, nose for nose, ear for ear, tooth for tooth, and wounds equal for equal." But if anyone remits the retaliation by way of charity, it is an act of atonement for himself. And if any fail to judge by (the light of) what Allah hath revealed, they are (no better than) wrong-doers. (45) And in their footsteps We sent Jesus the son of Mary, confirming the law that had come before him: We sent him the Gospel: therein was guidance and light, and confirmation of the law that had come before him: a guidance and an admonition to those who fear Allah. (46) Let the people of the Gospel Judge by what Allah hath revealed therein. If any do fail to judge by (the light of) what Allah hath revealed, they are (no better than) those who rebel. (47) To thee We sent the Scripture in truth, confirming the scripture that came before it, and guarding it in safety; so judge between them by what Allah hath revealed, and follow not their vain desires, diverging from the Truth that hath come to thee. To each among you have We prescribed a Law and an Open Way. If Allah had so willed, He would have made you a single people, but (His plan is) to test you in what He hath given you: so strive as in a race in all virtues. The goal of you all is to Allah; it is He that will show you the truth of the matters in which ye dispute. (48)" (Holy Qur'an, Surah Al-Maeda 5:44-48)

The above verses of the Holy Qur'an unequivocally prove that: a) there is no "clash of civilizations" in Islam by blanket declaration of Islam's own primal scripture; b) Islam is not Triumphantist even as it is Universalist. This is analyzed [here](#). [27]

Returning back to the hard realities of the present but with an acute eye to the future direction, we do have a rational way forward to defang the snake of Zionism and its prime-mover harbingers. **It is the calculated division of labor. A division which unfortunately has not transpired as yet.**

While it is obviously necessary to withstand the incessant onslaught of the aggressive foot-soldiers of the hectoring hegemony by the straightforward existential demands of daily survival – whether they come wielding their mighty guns and their soulless Drones and F-16s to exterminate us; or they come wielding their favorite everyday signed torpedo, their Hasbara, i.e., their phenomenal endless argumentative skills of introducing "beneficial cognitive diversity" in endless narratives to exterminate the moral commonsense of the world's public that as much as it grieves the Zionists to inform the spectating world, Palestinians really do deserve to extinguish themselves from the Land of the Jews without the slightest hint of protest as the moral right belong to the Jews – some still have to

concentrate on the prime-movers who are behind this robotic machine of the Jewish Lebensraum.

In order to be effective in dealing with such a multifaceted and unique adversary, a division of labor between those compelled to face the live ammunitions and checkpoints on Ground Zero, and those in Diaspora living in the comforts of the West with the luxury of time and liberty to effectively focus on the prime-movers, is the rational demand of the hour.

Furthermore, by reframing the struggle for Palestine, from the struggle against the European Jewry's quest for Lebensraum on Arab soil for its Roman Jerusalem, to the struggle against the common enemy, the hectoring hegemon seeking one-world government, the Palestinians can harness the entire world's 'untermenschen' struggles against the primal global enemy of mankind.

Unless that reframing is done quickly, beginning in the intellectual space and rapidly moving into the courts and public relations space as a prelude to the political space, the struggle for Palestine will remain boxed within the unbreachable invisible "Iron Wall" until acquisition of the entire Promised Land of Eretz Yisrael depicted in Herzl's plan for the Jewish State is completed. [28] It isn't obvious to me however, that when motivational Zionism required an indomitable prime-mover force to transform it from an idea into empirical Zionism, that without an equivalent prime-mover force on the side of the Palestinians, how can such a reframing practicably ever transpire? Serendipitously though, this very realization that without a backing prime-mover force it is next to impossible to wage an effective global struggle, also reinforces the idea that Zionism too could not have possibly flourished without it, and that the only way to dismantle Zionism is to effectively disable its prime-mover. Zionism would have remained moribund in the immanent spaces of the mind without the owners of central banks driving it!



Caption The promised land Eretz Yisrael. Map of Herzl's plan for the Jewish State

With all the preceding as the backdrop highlighting the realpolitik challenges to the way forward, let's return to the robot "Ahmad Yaqeen" so that we can keep it busy playing with itself while thinking peoples can get focussed on figuring out the challenges of elevating the struggle directly up to the prime-movers who created the robots. First, on the issue of indoctrination, that many a Zionist is indeed a robot programmed at birth, by their own admission:

"The state of Israel founded in 1948 following a war which the Israelis call the War of Independence, and the Palestinians call the Nakba – the catastrophe. A haunted, persecuted people sought to find a shelter and a state for itself, and did so at a horrible price to another people. During the war of 1948, more than half of the Palestinian population at the time – 1,380,000 people – were driven off their homeland by the Israeli army. Though Israel officially claimed that a majority of refugees fled and were not expelled, it still refused to allow them to return, as a UN resolution demanded shortly after 1948 war. Thus, the Israeli land was obtained through ethnic cleansing of the indigenous Palestinian inhabitants. This is not a process unfamiliar in history. Israel's actions remain incomparable to the massive ethnic cleansing of Native Americans by the settlers and government of the United states. Had Israel stopped there, in 1948, I could probably live with it. As an Israeli, I grew up believing that this primal sin our state was founded on may be forgiven one day, because the founder's generation was driven by the faith that this was the only way to save the Jewish people from the danger of another holocaust." (Tanya Reinhart:

“Israel/Palestine – How to End the War of 1948”)

As for the robot's other question of Why did Arabs reject the proposed UN GA partition plan which split Palestine into Jewish and Arab states, here is what Avi Shlaim says in the Prologue of his book **The Iron Wall: Israel and the Arab World**.

**Begin Excerpt:**

#### THE STRUGGLE FOR STATEHOOD

The struggle for statehood was accompanied by many disagreements, but these were more about tactics than about the long-term goal. Ben-Gurion's own commitment to statehood did no waver in the face of the Arab opposition or British prevarications. Having taken the initiative in proposing partition in 1937, the British government began to retreat from partition with the approach of World War II. The support of the Arab states and the Muslim world generally was much more crucial for Britain in the conflict with the Axis powers than the support of the Jews. A white paper of 17 May 1939 abruptly reversed British support for Zionism and for a Jewish state. It condemned the Jews to a status of permanent minority in a future independent Palestinian state. So the Zionist movement was driven to develop its own military power, through the paramilitary organization called Haganah (which in Hebrew means defense), in order to combat Arab resistance. Having subscribed to a defensive ethos that had served it so well on the public relations front, it adopted a policy based on force in order to counter the use and the threat of force by its Arab opponents. The offensive ethos that had always been embedded in the defensive ethos had in any case become more prominent following the outbreak of the Arab Revolt.

At the same time that Yishuv mounted its own active resistance to the policy of the white paper that restricted Jewish land purchase and Jewish immigration to Palestine. The outbreak of World War II in September 1939 placed the Yishuv in an acute dilemma: it was behind Britain in the struggle against Nazi Germany but at loggerheads with Britain in the struggle for Palestine. A way out of the dilemma was found, however, succinctly summed up in Ben-Gurion's slogan: “We will fight with the British against Hitler as if there were no white paper; we will fight the white paper as if there were no war.”

During the war Ben-Gurion became ever more assertive about the Jewish right to political sovereignty, while denying this right to the Arab majority in Palestine. His solution to the Yishuv's demographic problem involved the migration to Palestine of two to three million Jews immediately following the end of the war. The Arab problem, he claimed, paled in significance compared with the Jewish problem because the Arabs had vast spaces outside



Palestine, whereas for the Jews, who were being persecuted in Europe, Palestine constituted the only possible haven. He thus came to treat the Arab problem as merely one of status for the Arab minority within a state with a large Jewish majority.

The new concept of a Jewish state over the whole of Palestine found expression in the so-called Biltmore Program. At an extraordinary meeting of the American Zionists, attended by both Weizmann and Ben-Gurion, in the Biltmore Hotel in New York in May 1942, a resolution was adopted urging "that Palestine be constituted as a Jewish Commonwealth integrated in the structure of the new democratic world" after World War II. With this resolution the Zionist movement for the first time openly staked a claim to the whole of mandatory Palestine. The goal of a Jewish Arab agreement was not abandoned, but it was now clearly expected to follow rather than to precede the establishment of a Jewish state or commonwealth.

The Biltmore Program was adopted before the full scale and the horror of the Nazi campaign for the extermination of European Jewry became known. Zionist leaders assumed that at the end of the war there would be millions of Jewish refugees in Europe whose plight would strengthen the case for a large Jewish state in Palestine. None of them foresaw the Holocaust, the most calamitous event in the annals of Jewish history, in which six million Jews would perish. In the end, however, the tragedy of European Jewry became the source of strength for Zionism. The moral case for a home for the Jewish people in Palestine was widely accepted from the beginning; after the Holocaust it became unassailable. The poet Robert Frost defined a home as the place where, if you have to go there, they have to let you in. Few people disputed the right of the Jew to a home after the trauma to which they had been subjected in Central Europe.

A much tougher kind of Zionism was forged in the course of World War II, and the commitment to Jewish statehood became deeper and more desperate in the shadow of the Holocaust. On the one hand, the Holocaust confirmed the conviction of the Zionists that they had justice on their side in the struggle for Palestine; on the other, it converted international public opinion to the idea of an independent Jewish state.

Ben-Gurion embodied the "fighting Zionism" that rose out of the ashes of World War II, and he wrested the leadership from the hands of Weizmann, who still adhered to "diplomatic Zionism" and to the alliance with Britain. Against Weizmann's advice the Zionist conference of August 1945 decided on a policy of active opposition to British rule, and in October an armed uprising was launched. The Haganah was instructed to cooperate with the dissident groups spawned by the Revisionist movement. The main group was the National Military Organization (the Irgun), which began to direct its operations against the British

administration in Palestine after the publication of the white paper in 1939. Later that year, when the Irgun called off its campaign against the British, a split took place. The more militant wing, led by Avraham Stern, seceded from the Irgun to form Lohamei Herut Yisrael (Fighters for the Freedom of Israel), better known as Lehi, after its Hebrew acronym, or the Stern Gang. The Stern Gang was so hostile to the British that it sought to contact with the Axis powers in order to drive the British out of Palestine. Although its members never exceeded three hundred, the Stern Gang was a considerable thorn in the flesh of the British. Between November 1945 and July 1946, the three underground organizations joined arms in what became known as “the movement of the Hebrew revolt.”

A massive British military crackdown forced the Zionist leaders to call off the Hebrew revolt, and they instead tried to drive a wedge between Britain and the United States on the diplomatic front. Britain sought American support for its plan for self-governing Jewish and Arab cantons, a plan categorically rejected by the Zionists. To get America on their side, members of the Jewish Agency Executive decided in August 1946 to agree to consider the establishment of a Jewish state on an adequate part of Palestine. This decision signified the abandonment of the Biltmore Program and a return to the principle of partition. The decision was viewed not as a concession to the Arabs but as a mean of gaining American support for the idea of a Jewish state. In February 1947 the British government, unable to come up with a solution on which both sides could agree, referred the Palestine problem to the United Nations.

On 29 November 1947 the General Assembly of the United Nations passed its historic Resolution 181 in favor of the partition of Palestine. In a rare instance of agreement during the Cold War, the United States and the Soviet Union voted for the resolution while Britain abstained. The resolution laid down a timetable for the establishment of a Jewish state and an Arab state linked by economic union, and an international regime for Jerusalem. Exceptionally long and winding borders separated the Jewish state from the Arab one, with vulnerable crossing points to link its isolated areas in the eastern Galilee, the coastal plain, and the Negev. The borders of these two oddly shaped states, resembling two fighting serpents, were a strategic nightmare (see map 3). No less anomalous and scarcely more visible was the demographic structure of the proposed Jewish state, consisting as it did of roughly 500,000 Jews and 400,000 Arabs.

Despite all its limitations and anomalies, the UN resolution represented a major triumph for Zionist diplomacy. While failing far short of the full-blown Zionist aspiration for a state comprising the whole of Palestine and Jerusalem, it provided an invaluable charter of international legitimacy for the creation of an independent Jewish state. News of the UN vote was greeted by Jews everywhere with jubilation and rejoicing. But the followers of

Ze'ev Jabotinsky in the Irgun and the Stern Gang did not join in the general celebrations. A day after the UN vote, Menachem Begin, the commander of Irgun, proclaimed the credo of the underground fighters: "The partition of Palestine is illegal. It will never be recognized. ... Jerusalem was and will for ever be our capital. Eretz Israel will be restored to the people of Israel. All of it. And for ever."

The Jewish Agency officially accepted the UN partition plan, but most of its leaders did so with a heavy heart. They did not like the idea of an independent Palestinian state, they were disappointed with the exclusion of Jerusalem, and they had grave doubts about the viability of the Jewish state within the UN borders. Nevertheless, the UN resolution represented a tremendous gain of international support for the establishment of a Jewish state – hence their decision to go along with it.

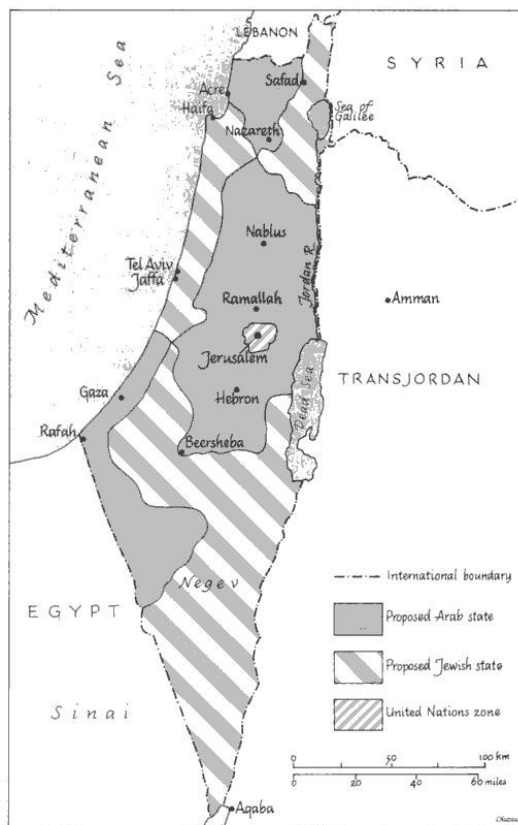

*The United Nations partition plan, 1947*

Caption map Iron-wall Avi Shlaim, page-26 UN partition plan

The Palestine Arabs, who unlike the Jews had done very little to prepare themselves for statehood, rejected the UN partition plan out of hand. The Arab Higher Committee, which represented them, denounced the plan as "absurd, impracticable, and unjust." The Arab states, loosely organized since 1945 in the Arab League, also claimed that the UN plan was illegal and threatened to resist its implementation by force. On 1 December the Arab Higher

Committee proclaimed a three-day strike, which was accompanied by violent attacks on the Jewish civilians. The UN vote in favor of partition thus provided not just international legitimacy for creating Jewish and Arab states but, unintentionally, the signal for a savage for between the two communities in Palestine. (Avi Shlaim *The Iron Wall: Israel and the Arab World*, pages 22-27)

### **End Excerpt**

Further elaboration upon that exposition of Avi Shlaim, with copious references in the Zionists' own unsurpassed eloquence, is [here](#). [29]

### **Footnotes**

[1] (defunct) <http://palestinethinktank.com/2010/05/08/joseph-massad-the-language-of-zionism>

(cached) <http://humanbeingsfirst.files.wordpress.com/2011/07/cacheof-joseph-massads-the-language-of-zionism-ptt-may-8-2010-with-zahirs-comment.pdf>

[2] <http://print-humanbeingsfirst.blogspot.com/2008/05/celebrating-israels-60th-birthday.html>

[3] (defunct) <http://palestinethinktank.com/2010/03/11/leaked-zionist-strategy-paper-to-counter-bds-must-read/#comment-15402>

(cached) <http://bloghumanbeingsfirst.wordpress.com/2011/04/15/response-to-leaked-zionist-strategy-paper-to-counter-bds-by-zahir-ebrahim/>

[4] <http://humanbeingsfirst.blogspot.com/2007/03/responsibility-of-intellectuals-redux.html>  
<http://www.hoover.org/publications/digest/2912626.html>

[5] Brian Gerrish, 2009 Lawful Rebellion Conference, UK <http://www.tpuc.org/node/564>

[6] <http://print-humanbeingsfirst.blogspot.com/2008/06/wmd-master-social-science.html>  
<http://print-humanbeingsfirst.blogspot.com/2009/05/note-on-mighty-wurlitzer.html>

[7] [http://www.jewishracism.com/Moses\\_Hess.pdf](http://www.jewishracism.com/Moses_Hess.pdf)

[8] <http://radioislam.org/islam/english/books/jewish/jewish1.htm>

[9] <http://www.marxists.de/middleeast/ironwall/ironwall.htm>

[10] <http://www.gilad.co.uk/writings/the-complete-guide-to-killing-non-jews.html>

<http://coteret.com/2009/11/09/settler-rabbi-publishes-the-complete-guide-to-killing-non-jews/>

[11] <http://portland.indymedia.org/media/media/2008/07/377351.pdf>

[12] <http://print-humanbeingsfirst.blogspot.com/2009/04/newsflash-financialterrorism-apr2009.html>

<http://print-humanbeingsfirst.blogspot.com/2008/10/monetary-reform-bibliography.html>

[13] <http://print-humanbeingsfirst.blogspot.com/2009/09/is-zionism-hegelian-dialectic.html>

[14] <http://www.jewishtribalreview.org/wilhelmson.htm>

[15] <http://print-humanbeingsfirst.blogspot.com/2009/04/vanilla-or-chocolate-icing-ondevilscake.html>

[16] <http://print-humanbeingsfirst.blogspot.com/2008/10/monetary-reform-who-will-bell-thecat.html>

[17] <http://print-humanbeingsfirst.blogspot.com/2007/12/endless-red-herrings.html>

<http://prisonersofthecave.blogspot.com/2007/04/chapter-3.html#Question-for-Noam-Chomsky-Israel-Palestine>

[18] <http://print-humanbeingsfirst.blogspot.com/2009/11/rescuing-thestruggle-for-palestine.html>

[19] <http://radioislam.org/koestler/index.htm>

[20] <http://www.palestineremembered.com/Articles/General/Story9097.html>

[21] <http://prisonersofthecave.blogspot.com/2007/04/chapter-3.html>

“... people who do not belong to our continent, to our world, but actually belong to different galaxy.” (Moshe Katsav)

“We declare openly that the Arabs have no right to settle on even one centimeter of Eretz Israel ... Force is all they do or ever will understand. We shall use the ultimate force until the Palestinians come crawling to us on all fours.” and “When we have settled the land, all the Arabs will be able to do about it will be to scurry around like drugged cockroaches in a bottle.” (Raphael Eitan)

[22] <http://www.nytimes.com/1996/10/29/science/scholars-debate-roots-of-yiddish-migration-of-jews.html?pagewanted=3&pagewanted=print>

[23] <http://print-humanbeingsfirst.blogspot.com/2010/02/what-is-intellectual-negro.html>

[24] <http://humanbeingsfirst.files.wordpress.com/2010/05/zahirs-letter-to-wendy-campbell-on-mustafa-barghouti-and-psychological-cataracts-may-09-2010.pdf>

[25] [http://humanbeingsfirst.wordpress.com/files/2009/12/cacheof-the-israel-project\\_s-2009-global-language-dictionary-tip\\_report-july102009-4mb.pdf](http://humanbeingsfirst.wordpress.com/files/2009/12/cacheof-the-israel-project_s-2009-global-language-dictionary-tip_report-july102009-4mb.pdf)

[26] <http://print-humanbeingsfirst.blogspot.com/2010/03/secretking-rothschild-roman-jerusalem.html>

<http://print-humanbeingsfirst.blogspot.com/2010/03/davidicke-rothschild-connection-zionism.html>

THE EMPIRE OF "THE CITY" (World Superstate) part 2

<http://video.google.com/videoplay?docid=-4430543376785758889>

[27] <http://print-humanbeingsfirst.blogspot.com/2011/06/knowledge-vs-socialization.html>

[28] <http://humanbeingsfirst.files.wordpress.com/2010/05/thepromisedland.gif>

Image source <http://radioislam.org/islam/english/toread/kivunim.htm>

[29] <http://www.palestineremembered.com/Acre/Palestine-Remembered/Story448.html>

**Source URL:** <http://print-humanbeingsfirst.blogspot.com/2010/05/palestine-theway-forward.html>

First Published May 12, 2010

## Chapter 28 Not Fooled Again: Dissecting the Intellectual Nigger

### FAQ: What is an Intellectual Negro?

This FAQ started out as a comment made by Project Humanbeingsfirst at the time of Dr. Aafia Siddiqui's guilty verdict by the New York court, [February 9, 2010 at 9:53 am](#).

#### Question: What is a White Man?

“White” in White Man is not about skin color or complexion. It is about attitudes towards another. First, permitting Malcolm X to describe it in his own eloquence:

'It was when I first began to perceive that “white man” as commonly used, means complexion only secondarily; primarily it described attitudes and actions. In America, “white man” meant specific attitudes and actions toward the black man, and toward all other non-white men.' -- (Malcolm X, The Autobiography of Malcolm X, 1964, 1999 hardcover edition, Chapter *Mecca*, page 364)

Project Humanbeingsfirst's usage of the word “white man” denotes an overarching attitude of a superiority complex which is best captured by the union of several nuanced concepts:

- Malcolm X's aforementioned description of attitude rather than skin color;
- the term '*Hectoring Hegemons*' – the attitude of physically imposing one's self-perceived superiority complex upon another, to physically invade, conquer and enslave another in the name of god, glory, *Lebensraum*, or just for the opportunities to profit;
- the term '*la mission civilisatrice*' – the attitude which came to be defined by the colonizing European Christians in the preceding centuries, to rob and plunder the natives throughout the world bequeathing them the invaders' “Christian” culture as a gift of “civilization” to the “dogs” and “barbarians” to “save” them from eternal damnation as heathens;

- the term '*Orientalism*' – the attitude of prejudice, at times in the sub-text, betrayed in Western scholarship of the Orient, i.e., the East, that Western civilization is inherently superior to all the Eastern civilizations;
- the term '*pious virtue*' – the hypocritical attitude which comes about by harboring any of the above in one's psyche while pretending to be fair and sympathetic to the 'lesser people'. It is the unstated common assumption in the backdrop when dealing with the 'lesser people'. It is most easily discernible when rushing to the aid of the victims of the white man's *la mission civilisatrice*, sometimes with all the best intentions, but deeming the native victims inherently less worthy in comparison to when the “white man” is made victim. It is ably captured in Noam Chomsky's “worthy victim” vs. “unworthy victim” nomenclature with all its attendant semantics. Its manifestation is most stark in the differing standards for seeking compensation and punitive damages which are sought on behalf of the victims by those representing the victims, often from the victimizer's own civilization, or suitable lackeys chosen from among the 'lesser peoples' who are put up there as proxies for the “white man” now so magnanimously providing the 'lesser people' with the “white man's” justice. The end result exactly betrays that the “white man's” victims are deemed inherently superior to those from among the “barbarians”. The whole transaction is couched in “pious virtue”.

### **Question: What is The White Man's Burden?**

See [The White Man's Burden](#)

### **Question What is a Negro?**

Let's begin by studying the very basic types of mental servitude. Let's start with Malcolm X's version of the '[Negro](#)':



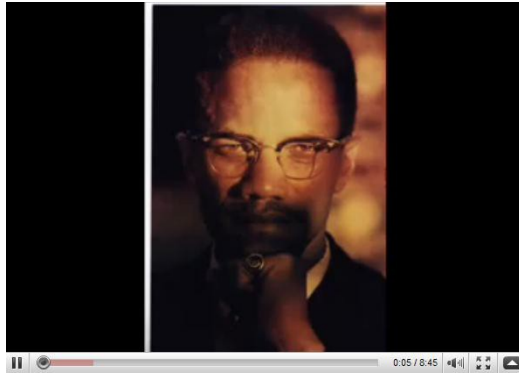

[youtube=[http://www.youtube.com/watch?v=UQ\\_VWpJj0Dw](http://www.youtube.com/watch?v=UQ_VWpJj0Dw)]

“There was two kind of slaves.

There was the house Negro and the field Negro.

The house Negro, they lived in the house, with massa. They dressed pretty good. They ate good, cause they ate his food, what he left. They lived in the attic or the basement, but still they lived near their master, and they loved their master, more than their master loved himself. They would give their life to save their master's house quicker than their master would.

The house Negro, if the master said 'we got a good house here', the house Negro say 'yeah, we got a good house here'.

Whenever the master would said we, he'd say we. That's how you can tell a house Negro.

If the master's house caught on fire, the house Negro would fight harder to put the blaze out than the master would. If the master got sick, the house Negro would say 'What's the matter, boss, we sick?' We sick!

He identified himself with his master, more than his master identified with himself.

And if you came to the house Negro and said 'let's run away, let's escape, let's separate', the house Negro would look at you and say 'man, you crazy! What you mean separate? Where is there a better house than this? Where can I wear better clothes than this? Where can I eat better food than this?'

That was that house Negro.

In those days, he was called a house nigger. And that's what we call him today, 'cause we still got some house niggers runnin around here.

This modern house Negro loves his master. He wants to live near him.

He'll pay three times as much as the house is worth just to live near his master, and then brag about 'I'm the only Negro out here. I'm the only one on my job. I'm the only one in this school.' You're nothing but a house Negro!

And if someone come to you right now and say 'let's separate', you say the same thing that the house Negro said on the plantation: 'What you mean separate? From America? This good white man? Where you gonna get a better job than you get here? I mean this is what you say. 'I ain't left nothing in Africa'. That's what you say.

Why, you left your mind in Africa!

On that same plantation, there was the field Negro.

The field Negro, those were the masses. There was always more Negroes in the field than there was Negroes in the house.

The Negro in the field caught hell. He ate leftovers.

In the house they ate high up on the hog. The Negro in the field didn't get nothing but what was left of the insides of the hog.

They call them chetlands nowadays. In those days they called them what they were, guts!

That's what you were, a guteater. And some of you are still guteaters!

The field Negro was beaten, from morning till night.

He lived in a shack, in a hut. He wore cast-off clothes.

He hated his master. I say, he hated his master.

He was intelligent.

That house Negro loved his master. But that field Negro, remember, they

were in the majority, and they hated their master.

When the house caught on fire, he didn't try to put it out, that field Negro prayed for a wind. For a breeze!

When the master got sick, the field Negro prayed that he died.

If someone come to the field Negro and said 'let's separate, let's run.' He didn't say 'Where we going?' he said 'Any place is better than here'.

We got field Negroes in America today.

I'm a field Negro.

The masses are the field Negroes.

When they see this man's house on fire, you don't hear these little Negroes talkin bout 'Our Government is in trouble'. They say 'thee Government is in trouble.'

Imagine a Negro, 'our Government'. I even heard one say 'our astronauts.' They won't even let him near the plant, and 'our astronauts'. 'Our Navy'. That's a Negro that's out of his mind.

That's a Negro that's out of his mind!

Just as the slave master in that day, used Tom, the house Negro, to keep the field Negroes in check.

The same 'ol slavemaster today, has Negroes, who are nothing but modern Uncle Toms. 20th century Uncle Toms, to keep you and me in check.

Keep us under control. Keep us passive and peaceful. And nonviolent. That's Tom making you nonviolent.

It's like when you go to the dentist, and the man is going to take your tooth. You're going to fight him, when he start pulling. So they squirt some stuff in your jaw called Novocain, to make you think they are not doing anything to you. So you sit there and because you got all that Novocain in your jaw, you suffer peacefully. Hahahaha.

There's nothing in our Book, the Qur'an, as you call it, Koran, teaches us to suffer peacefully.

Our religion teaches us to be intelligent. Be peaceful. Be courteous. Obey the law. Respect everyone.

But if someone puts his hand on you, send him to the cemetery!

That's a good religion. In fact, that's that old-time religion. That's the one that Ma and Pa used to talk about.

An eye for an eye, and a tooth for a tooth, and a head for a head, and a life for a life.

That's a good religion.

And then anybody, no one resist that kind of religion being taught but a wolf, who intends to make you his meal.

This is the way it is with the white man in America. He's a wolf, and you're sheep.

Anytime a shepherd, a pastor, teach you and me not to run from the white man, and at the same time teach us don't fight the white man, he's a traitor, to you and me.

Don't lay down our life all by itself. No! Preserve your life. It's the best thing you got.

And if you got to give it up, let it be Even Steven." -- (Malcolm X, House Negro vs. Field Negro Speech Transcription by Project Humanbeingsfirst.org; Also X)

In his autobiography, Malcolm X further fleshed out the modern Negro who thinks like the massa. He is black, brown, red or yellow in skin color, but is pure white in mind color:

'Today's Uncle Tom doesn't wear a handkerchief on his head. This modern, twentieth-century Uncle Thomas now often wears a top hat. He's usually well-dressed and well-educated. He's often the personification of culture and refinement. The twentieth-century Uncle Thomas sometimes speaks with a Yale or Harvard accent. Sometimes he is known as Professor, Doctor,

Judge, and Reverend, even Right Reverend Doctor. This twentieth-century Uncle Thomas is a professional Negro ... by that I mean his profession is being a Negro for the white man.' -- (Malcolm X, *The Autobiography of Malcolm X*, 1964, 1999 hardcover edition, Chapter *Black Muslims*, page 265)

Well, that description of the colonized mind turns out to be not all that modern, even though it accurately captures the modern Uncle Tom among all peoples. Witness the following statement in his speech before the English Parliament in 1835, by Lord Babington Macaulay who devised the new education policy for the Indian sub-continent – the Jewel in the Crown of the British Empire:

'We must at present do our best to form a class who may be interpreters between us and the millions whom we govern, --a class of persons Indian in blood and colour, but English in tastes, in opinions, in morals and in intellect.' --(Lord Thomas Babington Macaulay, *Minute on Education*, 2nd February 1835, [page 8](#))

Martin Luther King Jr. also offered a timeless description for the Negro which today transcends skin color and complexion in its empiricism:

'The white establishment is skilled in flattering and cultivating emerging leaders. It presses its own image on them and finally, from imitation of manners, dress, and style of living, a deeper strain of corruption develops. This kind of Negro leader acquires the white man's contempt for the ordinary Negro. He is often more at home with the middle-class white than he is among his own people. His language changes, his location changes, his income changes, and ultimately he changes from the representative of the Negro to the white man into the white man's representative to the Negro. The tragedy is that too often he does not recognize what has happened to him.' -- (Martin Luther King Jr., *A Testament of Hope*, [page 307](#), read [online](#))

### **Question What is “Intellectual Negro”**

Many more complex shades of the ‘Negro’ have been cultivated in modernity than the ones Malcolm X and MLK had been exposed to. One new shade that I have been grappling with for some time is the “**Intellectual Negro**”. This new shade of the servile Negro which escaped the experiences of the civil and human rights struggles of the American black

leaders, has become ubiquitous among Muslims today, especially among Pakistanis, Afghans, and Arabs. Indeed, among all nations along the '*arc of crisis*' in the '*global zone of percolating violence*'.

This kind of Negro is familiar to us under the nom de guerre '**fabricated dissent**', a pernicious variant of 'native informant'.

This Negro, the "Intellectual Negro", is very sophisticated, and often very intelligent with advanced academic and/or public credentials. This Negro will appear to hector the white man and the white man's establishment, while still managing to echo the white man's core-axioms.

In other words, the intellectual Negro will appear to be an outspoken voice of dissent in favor of the downtrodden and the oppressed, typically from the 'left-liberal' nexus, but will still devilishly manage to echo the massa's core message.

For instance, while vehemently critiquing the empire's war on terror and its devastating impact upon the innocent victims across many civilizations, the intellectual Negro will craftily manage to echo the empire's core message that Al Qaeda is the global terrorist menace which carried out the 9/11 attacks on America. That retention of the core-axiom of empire from which all the evil that followed after 9/11, and which enabled all its subsequent aggressive wars and crimes against humanity that he critiques, reduces the intellectual Negro to an absurdity. But he is treated as the most avantgarde in intellectual thought and praised by both, the hegelian instruments of the white man instrumenting its dissent-space, as well as the brain-washed field Negroes themselves to whom he laboriously carries the white man's burden displaying much personal anguish.

Thus, the hectoring, i.e., challenging the visible narratives of power, serves the function of appearing to be on the side of the 'field Negro', but in reality he is still a 'house Negro' without speaking in that 'we' vernacular noted by Malcolm X.

Here is an example: the first article hectors the white man, the second one echoes its core axioms:

<http://humanbeingsfirst.files.wordpress.com/2009/10/cacheof-pervez-hoodbhoy-between-imperialism-and-islamism.pdf>

<http://humanbeingsfirst.files.wordpress.com/2009/11/cacheof-pervez-hoodbhoy-pakistan-the-threat-from-within-psru-brief13-may232007.pdf>

And here is another one which does the same all in one article:

<http://humanbeingsfirst.files.wordpress.com/2009/10/cacheof-ayesha-siddiqa-between-military-and-militants.pdf>

And here is deconstructing another intellectual Negro who ostensibly hectors power while still managing to echo its key message:

<http://print-humanbeingsfirst.blogspot.com/2009/11/hamid-mir-making-of-pakistans-savior.html>

Here is the latest variant who shamelessly sides with power spinning absurdities:

<http://print-humanbeingsfirst.blogspot.com/2010/09/zahir-responds-rafia-zakaria-amnesty.html>

<http://print-humanbeingsfirst.blogspot.com/2010/04/enduring-power-of-machiavellian-polysci.html>

While the above illustrative examples are typical of the “Left-liberal” nexus carrying the mantra of Secular Humanism and reviling the “Right-religion” nexus, the following is an illustrative example of the “Right-religion” nexus. After villainously condemning each other during the day in “noora kushti” (Urdu word for a WWF style wrestling match where both combatants entertaining the audience by a show of vile antagonist wrestling, work for the same promoter and drink from the same trough after the match), they both congregate at the same white man's table for supper:

<http://print-humanbeingsfirst.blogspot.com/2010/03/resp-terror-fatwa-in-service-of-empire.html>

The diabolical omissions and selective story-telling, a crime common to all Negro penologists of Pakistan serving the massa's interests, including its news media, its NGO based glittering literati clamoring Secular Humanism, its virtuous politicians picking whichever side leads the quickest to power and graft, its mercenary military slaughtering its own peoples with American payments, and its religious zealots either burning American flags in protests or echoing the massa's own condemnations, is in my 692-page book “The Pakistan Decapitation Papers” 4th Edition, June 2011. A quick examination of these omissions which never see ink in the erudite penmanship of the intellectual Negro picking the “good” side in the Hegelian Dialectic of “militant Islam” vs. “moderate Islam” is here:

<http://print-humanbeingsfirst.blogspot.com/2009/04/between-imperialism-islamofascism.html>

<http://print-humanbeingsfirst.blogspot.com/2007/12/saving-pakistan-from-synthetic-terror.html>

And the following is an example from Afghanistan. An Afghani-born, American-naturalized, Stanford and Columbia university educated professor of education playing loud dissent with empire: *"I think it was absolutely wrong for the United States to attack and invade Afghanistan, because Afghanistan as such had nothing to do with 9/11"*, still managed to echo the core-axioms of empire that 9/11 was an invasion from abroad and the work of vile terrorist Muslims: *"In fact people now think that the Taleban had no idea that Al Qaeda had a plan to attack the United States"*. The good Samaritan educator has continued to labor since the invasion of Afghanistan in October 2001, to bring the same sort of Education system of the colonizing white man to Afghanistan as was crafted by Lord Macaulay to cultivate house negroes and Uncle Thomases in the Indian sub-continent:

<http://print-humanbeingsfirst.blogspot.com/2011/07/letter-afghanistan-zaher-wahab.html>

The aforementioned example is illustrative of the quintessential modern intellectual Negro – highly intelligent, un-afraid to speak up against the massa, yet fully subservient where necessary, laboring with missionary zeal in carrying the white man's burden, its *'la mission civilisatrice'*, in full sympathy to the victims. The resume of the intellectual Negro is notably representative of the most successful native informants today:

'He was born and schooled in Afghanistan, received a B.A. in sociology from The American University of Beirut, an M.A. in comparative education from Teachers College, Columbia University, and an M.A. in anthropology and a Ph.D. in international development education from Stanford University. Dr. Wahab was the first person in his family's history to attend the village school, a boarding school in Kabul, and receive scholarships to attend college in Lebanon and the US. Thus far, Dr. Wahab is the only Afghan with a Ph.D. from Stanford University.'

My aforementioned letter to the Afghani scholar was greeted not with stone silence as I had feared, but with the following short encouraging statement: *"Dear Mr. Ebrahim, Greetings from Portland, and many thanks for your insightful, passionate, informative, thoughtful, and thought-provoking e-mail. I will respond in detail, or call you, as soon as I have some time*



*and peace of mind. Regards, Zw*". I look forward to such exchange.

The good Afghani professor may well be the rare case of genuinely being mistaken in carrying the white man's burden – as inconceivable as that may be to imagine that someone with a masters degree in anthropology and a doctorate in education would be unaware of the modalities of the greatest colonial conquest of all time, that of the Indian sub-continent, partly with the already mentioned Education policy of Lord Macaulay for fabricating “professional Negroes”. In which case, the good professor will cease and desist from carrying water for the white man's *“la mission civilisatrice”*. When that transpires, this illustrative example will be appropriately amended.

Here is a similar illustrative example of a stellar high-tech professional resume, one which has proven itself time and again to be unarguably that of an intellectual Negro. This one is a most distinguished resume from Pakistan. It was carried by the Middle East Forum, a Zionist neo-con Quarterly, presumably of the Jewish Islamophobe Daniel Pipes. They love to promote any intellectual Negro who will profoundly echo, in any convolution, the white man's burden encapsulated in the doctrinal craftsmanship of Jewish scholars like Bernard Lewis, in books such as: *“Crisis of Islam – Holy War and Unholy Terror”* and *“What Went Wrong? The Clash Between Islam and Modernity in the Middle East”*:

'Pervez Amirali Hoodbhoy (b. 1950) is one of South Asia's leading nuclear physicists and perhaps Pakistan's preeminent intellectual. Bearer of a Ph.D. from the Massachusetts Institute of Technology , he is chairman of the department of physics at Quaid-e-Azam University in Islamabad where, as a high-energy physicist, he carries out research into quantum field theory and particle phenomenology. He has also been a visiting professor at the University of Maryland, College Park, and was visiting professor at MIT and Stanford. For some time, he has been a frequent contributor to Britain's leading intellectual journal, Prospect. His extracurricular activities include a vocal opposition to the political philosophy of Islamism. He also writes about the self-enforced backwardness of the Muslim world in science, technology, trade, and education. His many articles and television documentaries have made a lasting impact on debate about education, Islam, and secularism in Pakistan. Denis MacEoin interviewed him by e-mail in October 2009.'

Here is that interview with Pervez Hoodbhoy, titled *“Islam and Science Have Parted Ways”* promoted by MEF. And here is Hoodbhoy's column in the UK Guardian *“Islam's arrested development”*, echoing the same theme. The deconstruction of the crafty linguistics for the seemingly careless usage of the word “Islam” which enables crafting the public discourse

on “Islamism” and its variants such as “militant Islam”, “moderate Islam”, etc., is in my response to the CAIR Report:

<http://print-humanbeingsfirst.blogspot.com/2011/07/cair-report-islamophobia-rising-usa.html>

The Hijacking of the word 'Islam' for Mantra Creation which unites Pakistani Niggers with the Jewish neo-con massas like Bernard Lewis, Samuel Huntington, Daniel Pipes et. al., is fully fleshed out in:

<http://faith-humanbeingsfirst.blogspot.com/2011/08/hijacking-word-islam-mantra-creation.html>

Once I wrote to Pervez Hoodbhoy suggesting something to the effect that: *“if your essays didn't have your name on them, I might have thought the author is Daniel Pipes.”* Dr. Pervez Hoodbhoy, my co-alum from MIT, fellow Pakistani, and many years my senior, has not talked to me since then. I continually wonder why:

- Is it because of my possessing the few skills, the commonsensical knowledge, and the foolish boldness to call a spade a spade continually confronting the “preeminent intellectual” rather than being co-opted into silence?
- Or, is it that I am so egregiously mistaken in my conclusions that I am not worth interlocuting with for the lofty “preeminent intellectual” – ubiquitous in the massa's dominion – who only contends with finding major faults with “Islam”, argues willy-nilly with other Uncle Toms of various shades, presents himself prominently in massa's various gatherings ostensibly representing the field Negroes, and just eschews the field Negroes themselves as being just too ignorant to teach?

This is a perennial mystery which repeats itself everyday, as my every unmasking of the intellectual Negro is stoically greeted with the thunderous sounds of silence. Ignoring the field Negro skilled enough to unmask both the massa and their house Negro, has been the most effective way of silencing the field Negro.

For indeed, all the freedom of speech in free space (no air) still naturally leads only to asphyxiation! The massa knows it, and has groomed his house niggers rather well. This leaves the ubiquitous Uncle Toms and his owner free to spin their doctrinal craft unfettered, over all the air which they already own outright.

Thus, while denying the field Negro air to expound, the massa and his “professional

Negroes” incestuously reinforce each other unhindered and unchallenged, spanning the full gamut of intellectual and psychological warfare upon civilian populations worldwide.

The “**Hegelian Mind Fck**” behind such “cognitive infiltration” to:

- manufacture consent and dissent to engineer public opinion;
- spin clever red herrings (a smelly fish that a fugitive drags across the path in order to put the pursuing dogs off the trail) through Machiavellian interjections of fabricated “diversity” and fabricated dissent;
- synthesize controlled clashes of fabricated opposites for raising a new phoenix from its ashes;

is examined in much depth in the following tutorials:

<http://print-humanbeingsfirst.blogspot.com/2009/05/note-on-mighty-wurlitzer.html>

<http://print-humanbeingsfirst.blogspot.com/2010/01/faq-what-is-hegelian-mind-fck.html>

<http://print-humanbeingsfirst.blogspot.com/2009/05/anatomy-of-modern-lies-pakistanishills.html>

<http://print-humanbeingsfirst.blogspot.com/2008/06/wmd-master-social-science.html>

I fear one would be very hard pressed to find an exception to the “intellectual Negro” in Pakistan and the Middle East from among our uber-educated literati, from among our well-funded 'humanist' NGOs, especially the Human Rights Organizations, the Left as well as the Right, and the new *occidentosis plague* we seemed to have picked up: think-tanks staffed with our finest Negroes of all shades, including brain-washed 'field Negroes' employed as cover, useful idiots, dupes and patsies.

Just as there was the government-private partnership between the British Empire and the East India Company to maintain the empire upon which the sun once never set, the empire du jour too similarly thrives on government-private partnership for its “imperial mobilization” and for the maintenance of its extended empire.

The line between government and private sector is merely one of who writes the final

paycheck to the employees, for they both share the same common goals of empire, and work hand in glove. The Jewish grandmaster of *The Grand Chessboard*, Zbigniew Brzezinski, self-servingly admitted this modus operandi when he wrote in his 1970 book *Between Two Ages*, “*The trend toward more coordination but less centralization would be in keeping with the American tradition of blurring sharp distinctions between public and private institutions. Institutions such as TVA or the Ford Foundation perform functions difficult for many Europeans to understand, since they are more accustomed either to differentiate sharply between the public sphere and the private (as has been typical of the industrial age) or to subordinate the private to the public (as is favoured by the socialists and some liberals) or to absorb the private by the public (as has been the case in communist states).*” (pg. 99)

And the Jewish columnist Thomas Friedman truthfully confirmed what is already obvious, in the New York Times on March 28, 1999, “*The hidden hand of the market will never work without a hidden fist -- McDonald's cannot flourish without McDonnell Douglas, the builder of the F-15. And the hidden fist that keeps the world safe for Silicon Valley's technologies is called the United States Army, Air Force, Navy and Marine Corps.*”

The professional intellectual Negro typically earns his paycheck from the private sector of the Military-Industrial-Academe-Non-profit-Thinktanks-Foundations half of empire while he critiques the public sector half comprising “*the United States Army, Air Force, Navy and Marine Corps*”, and of course, including the White House which controls that not so “*hidden fist*”. That separation of employer name on the paycheck stub evidently provides the much needed soothing balm to the modern intellectual Negro's conscience.

It would be a grave mistake to surmise that the House Negro phenomena is only peculiar to the few professional craftsmen of the Mighty Wurlitzer (see link above). Ordinary peoples are just as much participant in it. The following anecdotal case is in fact rather typical of new Uncle Toms in America.

When I was describing to a very dear friend of mine who only recently became a naturalized US citizen, how Malcolm X taught himself in the prison library, how he read constantly to become the un-challengeable orator and spokesperson for his peoples' cause, my friend's immediate interjection was, “*see, even their prisons have such great libraries!*” My new Uncle Tom, which I of course immediately addressed my long-time friend as, betrayed empathy with no one else except with prominent house niggers and the massa. Well, at least my friend was honest about his feelings of gratitude for the massa, having observed previously that the white man had given him far more than his own nation. The good fellow, who wears the stamp of remarkable piety on his forehead, and is one of

the best in morals and friendship among all the people I know, never stopped to reflect what the white man took from our nations by cultivating fools, useful idiots, stooges, patsies, and mercenaries which he implanted in key positions in our nations to ensure that we stayed rudderless. That fact that our nations became more and more corrupt by villainous means in the post colonial era which the massa had cleverly instrumented for us, has amply been discussed elsewhere (see [John Perkins](#)).

To make centuries long colonized nations blind and steeped in servility by methods of neo-colonization in the ostensibly post-colonial period, and then to complain we are still blind, is the characteristic of the house nigger who blames the field niggers for all of their desperate state.

This self-deluding co-option is not atypical. Apart from the fact that it is the story of mental slavery in every epoch, today it is most visible – to those who wish to see it – in virtually every mosque and “mai-khana” (bar, a figure of speech to indicate secular Muslims) in the West. While the latter caters to the spirit of Secular Humanism of the white man in his ongoing “*la mission civilisatrice*” upon the world, the former, a place of ritual piety, evidently also only succeeds in fabricating the “Good Muslim” and the “Good American” – sort of counterparts to the “Good Christian” and the “Good German” in the Third Reich – for 'United We Stand' in the Fourth Reich!

The massa has always understood this psychology of servility of the colonized man, and all too well. He has always cultivated and harvested from this colonized crop, the most able bodied, the most talented, and turned them into the most credentialled “professional Negroes” as described by Malcolm X in his Autobiography. Due to its immense pertinence to our times, it begs further emphasis: **“This twentieth-century Uncle Thomas is a professional Negro ... by that I mean his profession is being a Negro for the white man.”** (pg. 265)

The key psychological processes to construct this servility among most immigrant communities in the massa's world of gainful employment, and other material benefits denied them in their native country, is all of that which also went into making the good house negro short of actual physical slavery. Studying Malcolm X therefore, reveals a great deal about many of us today.

Almost 90 percent, that not being an exaggeration, perhaps even an underestimate if anything, first and even second generation immigrants to America, just like the vast majority of elites in all Muslim and formerly colonized lands, are infected with this de facto mental colonization.

Layered atop this foundational layer of de facto mental colonization of the 'Negro' of every flavor, is the layer of fabricated deception purveyors based on shared ideology. And on top of that is another pernicious layer based on apparently our natural trait: our meager price which turns us, not just psychologically, but also physically, into traitors to our own peoples.

These three colonizing mental forces combined in various shades tend to create many more Negro types. The 'price' aspect is particularly pernicious – this price today is far more insidious than the mere 'lifafa' (envelope stuffed with bribe money), the bottle of whiskey, or even the trip to Disneyland of yesteryear as narrated by Brig. Tirmazi in his 1995 memoir **“Profiles of Intelligence”** Ch 3, page 45. His exact words:

*'A lot has been said and written by some of our American friends about the price of a Pakistani. Dr. Andrew V. Corry, US Counsel General at Lahore, once said, **“Price of a Pakistani oscillates between a free trip to the US and a bottle of whisky.”** He may not be too far wrong. We did observe some highly placed Pakistanis selling their conscience, prestige, dignity and self-respect for a small price.'*

This is why the aforementioned Pakistani intellectual Negro can blithely claim with a straight face: 'Is the Check in the Mail? The Confessions of a Groveling Pakistani Native Orientalist'! While he also publicly admits to the intangible benefits in 'An End to Hypocrisy': *“I belong to the fortunate few who can get a visa,”*. The professional intellectual Negro might do well to stare in the mirror while he echoes the massa's message admitting to its benefits. It would surely assist him in comprehending the full import of that Biblical word which he has evidently mastered so well without understanding its real meaning:

“My green passport requires standing in a separate immigration line once my plane lands at Boston’s Logan Airport. The “special attention” from Homeland Security, although polite, adds an extra two to three hours. I belong to the fortunate few who can get a visa, but I am still annoyed. Having traveled to the United States frequently for 40 years, I now find a country that once warmly welcomed Pakistanis to be quite cold. The reason is clear.

Foreigners carrying strong negative feelings—or perhaps harmful intentions—are unlikely to find enthusiastic hosts. I know that the man who tried to bomb Times Square, Faisal Shahzad, a graduate of the University of Bridgeport, is my compatriot. So is Aafia Siddiqui, our new-found dukhtur-e-millat (daughter of the nation). Another Pakistani, Farooque Ahmed, with a

degree from the College of Staten Island, made headline news in November 2010 after his abortive attempt to blow up DC Metro trains.

If such violent individuals were rarities, their nationality would matter little. But their actions receive little or no criticism in a country consumed by bitter anti-Americanism, which now exceeds its anti-Indianism.”

If I might be permitted a bit of narcissism here to draw a valid comparison, I too possess only the “*green passport [which] requires standing in a separate immigration line once my plane lands*”, despite over three decades of permanent residence in the United States with the permanent resident card (green card) which my first employer in Silicon Valley got for me. They claimed before the US Department of Labor (or something similar) that they couldn't find any white man in America to replace my engineering skills which they wanted badly at the time. Yet, compare my Realityspeak (my neologism) to the Newspeak (a term from George Orwell's novel *1984*) of both the massa and his obliging Niggers! That's because I am a “field Negro” – figuratively speaking – and that's something which I have proudly earned by dint of my own study and observations, not a misery I was born into like Malcolm X and others birthed on the wrong side of the railroad tracks. Any “house nigger” today, irrespective of their skin color and national origin, would do well to study Malcolm X's Autobiography in some depth. The fate of those who follow in that footsteps, to genuinely challenge unjust power and its villainous narratives, is surely the early graveyard. It is written in the indelible pages of history. A choice one knowingly makes – because despite the overt choice, there is really no choice:

<http://print-humanbeingsfirst.blogspot.com/2011/06/knowledge-vs-socialization.html>

As for Pervez Hoodbhoy's lofty demonstration of leftwing compassion for “*Aafia Siddiqui, our new-found dukhtur-e-millat (daughter of the nation)*”, see its deconstruction identifying all the omissions in the professional intellectual Negro's narratives in deep servility to the massa – when he could have been the strongest ally for his victim:

<http://print-humanbeingsfirst.blogspot.com/2011/07/flashback-remembering-dr-aafia-2011.html>

Pervez Hoodbhoy's show of fearless rebellion against the forces of imperialism is of course predicated on his theory of “leftwing politics” which he most articulately expounded in his already mentioned ode to the Hegelian Dialectic: Between Imperialism and Islamism. Like a learned physicist Hoodbhoy first postulated the problem, thusly:

“Many of us in the left, particularly in Southasia, have chosen to understand the rise of violent Islamic fundamentalism as a response to poverty, unemployment, poor access to justice, lack of educational opportunities, corruption, loss of faith in the political system, or the sufferings of peasants and workers. As partial truths, these are indisputable. Those condemned to living a life with little hope and happiness are indeed vulnerable to calls from religious demagogues who offer a happy hereafter in exchange for unquestioning obedience.

American imperialism is also held responsible. This, too, is a partial truth. Stung by the attacks of 11 September 2001, the United States lashed out against Muslims almost everywhere. America’s neoconservatives thought that cracking the whip would surely bring the world to order. Instead, the opposite happened. Islamists won massively in Iraq after a war waged on fraudulent grounds by a superpower filled with hubris, arrogance and ignorance. ‘Shock and Awe’ is now turning into ‘Cut and Run’. The US is leaving behind a snake pit, from which battle-hardened terrorists are stealthily making their way to countries around the world. Polls show that the US has become one of the most unpopular countries in the world, and that, in many places, George W Bush is more disliked than Osama bin Laden.”

That Pakistani house nigger's problem articulation of course exactly parrots the blowback mantra of the massa in the West. See my response to Chris Hedges where the massa's controlled dissent is carefully dissected and dismantled:

<http://print-humanbeingsfirst.blogspot.com/2011/09/response-chris-hedges-decade-after-911.html>

Having firmly played the massa's own Hegelian Dialectic of Dissent, which incidentally is what makes getting visas and sabbaticals a trivial matter for Pakistan's most favored leftwing brown-sahib of the American Embassy in Islamabad: ***“I belong to the fortunate few who can get a visa,”*** Hoodbhoy offered his specious solution space of “leftwing politics” --- the key purpose of the Americans for cultivating this house nigger in Pakistan. The main task of *“cognitive infiltration”* to introduce *“beneficial cognitive diversity”* (sic!) among Pakistan's Muslim public, right alongside “Moderate Islam” as the Hegelian counterpoints to “Militant Islam”, to orchestrate internal clashes and divisions in the name of being peace-makers (see verse 2:11 of the Holy Qur'an which warns of precisely this age-old villainy: *“And when it is said to them, Do not make mischief in the land, they say: We are but peace-makers.”*), in Pervez Hoodbhoy's own words:



“The role of the left

Between the xenophobes of the West and the illogical fundamentalism in Muslim societies, the choices keep getting grimmer. A mutually beneficial disentanglement can only be provided by humane, reasoned and principled leftwing politics.

Looking down at planet Earth from above, one would see a bloody battlefield, where imperial might and religious fundamentalism are locked in bitter struggle. Whose victory or defeat should one wish for? There cannot be an unequivocal preference; each dispute must be looked at separately. And the answers seem to lie on the left of the political spectrum, as long as we are able to recognise what the left actually stands for.

The leftwing agenda is a positive one. It rests upon hope for a happier and more humane world that is grounded in reason, education and economic justice. It provides a sound moral compass to a world that is losing direction. One must navigate a course safely away from the xenophobes of the US and Europe – who see Islam as an evil to be suppressed or conquered – and also away from the large number of Muslims across the world who justify acts of terrorism and violence as part of asymmetric warfare.

No ‘higher authority’ defines the leftwing agenda, and no covenant of belief defines a ‘leftist’. There is no card to be carried or oath to be taken. But secularism, universalistic ideas of human rights, and freedom of belief are non-negotiable. Domination by reasons of class, race, national origin, gender or sexual orientation are all equally unacceptable. **In practical terms, this means that the left defends workers from capitalists, peasants from landlords, the colonised from the colonisers, religious minorities from state persecution, the dispossessed from the occupiers, women from male oppression, Muslims from Western Islamophobes, populations of Western countries from terrorists, and so on.”**

Pervez Hoodbhoy used that **“humane, reasoned and principled leftwing politics”** for which: **“No ‘higher authority’ defines the leftwing agenda, ... It provides a sound moral compass to a world that is losing direction”** to admirably defend a frail and defenseless woman he cynically called *“our new-found dukhtur-e-millat”* in sympathy with his massa's verdict on her without an iota of **“humane, reasoned and principled”**

examination of the matter. We see that Pervez Hoodbhoy goes right along parroting his massa, he reproduces their facts, their data, their analysis, and their conclusions, in the guise of being their antagonist – the clever Intellectual Nigger! But not cleverer than even an ordinary field negro who can administer a single knock-out punch with one hand tied behind his back. Which is why the house niggers tend to lurk only in the shadows of the massa, only dare to engage in WWF style wrestling with their confreres beholden to the same massa and its many instruments who all know how the game is played, and not venture out into *free space* where the field negroes dwell. As the lovely Pakistani singer Sanam Marvi boldly remarked without hesitation on mainstream Pakistan television to the bs of her interlocuter: “*chootia bana rahe ho?*” (Indelicate Urdu phraseology for “trying to make a fool of me with your fcking bs?”)

Moving right along, it is a shame that few people understand the import of crafty omissions. Which is why I have to continually emphasize it. While the reader may have seen similar passages in many of my writings cited here, it is necessary to restate again because the indictment of the Intellectual Negro playing dissent to the massa, is often for his calculated omissions. The art of voluntary persuasion, “**to get people actually to love their servitude**”, is integral to social engineering of consent. It was most eloquently explained by the famous essayist and novelist, Aldous Huxley on the 30th anniversary of the publication of his allegorical novel *Brave New World*, at University of California, Berkeley. Huxley had very shrewdly observed a half century ago:

'You can do everything with bayonets except sit on them! If you are going to control any population for any length of time you must have some measure of consent. It's exceedingly difficult to see how pure terrorism can function indefinitely. It can function for a fairly long time, but I think sooner or later you have to bring in an element of persuasion. An element of getting people to consent to what is happening to them. Well, it seems to me that the nature of the Ultimate Revolution with which we are now faced is precisely this: that we are in process of developing a whole series of techniques which will enable the controlling oligarchy who have always existed and presumably always will exist, to get people actually to love their servitude! This is the, it seems to me the ultimate in malevolent revolution shall we say.' --- Aldous Huxley, 1962 speech at UC Berkeley, minute 04:06

Therefore, given that engineering consent of the masses is the objective of social engineering, “**of getting people to consent to what is happening to them**”, Aldous Huxley explained the role of calculated omissions in systems of propaganda which accomplish just that, in his Preface to *Brave New World*:

'The greatest triumphs of propaganda have been accomplished, not by doing something, but by refraining from doing. Great is truth, but still greater, from a practical point of view, is silence about truth. **By simply not mentioning certain subjects, by lowering what Mr. Churchill calls an "iron curtain" between the masses and such facts or arguments as the local political bosses regard as undesirable, totalitarian propagandists have influenced opinion much more effectively than they could have done by the most eloquent denunciations, the most compelling of logical rebuttals.** But silence is not enough. If persecution, liquidation and the other symptoms of social friction are to be avoided, the positive sides of propaganda must be made as effective as the negative.' — Aldous Huxley, Preface (circa 1946) to *Brave New World*, 1931, Harper, pg. 11

Let's just pause here for a moment to deeply reflect, and to keep reminding oneself afterwards when one encounters any material in the New York Times and CNN, and in the so called alternate media which has ostensibly risen to challenge mainstream, that they all work for the same bosses echoing the same core lies by way of both omission and commission. That, these propaganda organs in the twenty-first century do both, the crucial omissions (the negative side using silence on key matters), and the facile mantra recitations (the positive side), which Adolph Hitler in *Mein Kampf*, Edward Bernays in *Propaganda*, and Aldous Huxley had written much about in the previous century. See the already cited link for the Mighty Wurlitzer report for a detailed study of how such persuasion actually works in practice.

One other thing to also continually reflect upon – perhaps more so for the professional intellectual Negro enjoying lifetime visa to visit the massa and often finding refuge/tenure/sabbaticals in massa's institutions – is that when finally defeated, Dr. Joseph Goebbels, the Reichminister for Propaganda, only cheated that hangman's noose reflecting: "*For us, everything is lost now and the only way left for us is the one which Hitler chose. I shall follow his example*". Witness the ultimate fate of all propagandists who try to make "*chootias*" (fools) of a nation:

#### **"Don't Be Afraid'**

May 1, 1945, in the evening. The daughters and the son were already in bed, but were not asleep yet. "Don't be afraid," their mother said. "The doctor is going to give you a shot now, one that all children and soldiers are getting." She left the room, and Kunz injected the morphine, "first into the two older girls, then the boy and then the other girls." Each child received a

dose of 0.5 cc. It "took eight to 10 minutes."

When the children had fallen asleep, Magda Goebbels went into the room, the cyanide pills in her hand, as Kunz testified. She returned a few seconds later, weeping and distraught. "Doctor, I can't do it, you have to do it," she said. The dentist replied: "I can't do it either." "Then get Dr. Stumpfegger," she said. Ludwig Stumpfegger, who was slightly younger than Kunz, had been one of SS chief Heinrich Himmler's personal doctors.

A week later, Russian coroners performed autopsies on the bodies of the children and concluded that their deaths had "occurred as a result of poisoning with cyanide compounds." The Goebbels themselves had committed suicide outside the bunker, and Stumpfegger died while attempting to break through the Russian lines in Berlin." — Source Der Spiegel





Caption The Goebbels family --- evidently, only defeat or victory adjudicates who is a propagandist and who isn't, not evidence. Hitler had asserted at the eve of World War II from his mountain top in Bavaria to his generals that he would *'give a propagandist reason for starting the war'* and admonished them not to *'mind whether it was plausible or not'*. *'The victor'*, he had told them, *'will not be asked afterward whether he told the truth or not. In starting and waging a war it is not the right that matters, but victory.'* That unexpected "victory" of hubris eventually caught up with the propagandists.

Source of quote is William Shirer's Rise and Fall of the Third Reich

Now that the astute reader perceptively comprehends the key arsenal in the professional intellectual Negro's propaganda system, and why it is often difficult for even the super-learned people with a Ph.D. to detect crafty omissions (unless adjudicated by victor's justice) because that requires accurate knowledge of many pertinent matters which is made impossible once the “**iron curtain**” of propaganda has been lowered around them by massa's zealous missionaries, let's move on.

Every mentally colonized people acutely suffering from the *plague of occidentosis* have their own fair share of this intellectual Negro. This is Iran's:

<http://print-humanbeingsfirst.blogspot.com/2010/02/isthe-iranian-expat-new-house-negro.html>

These Iranian house Niggers of the twenty-first century would do well to carefully comprehend *Occidentosis*, the plague from the West that was infecting the Iranian psyche in the previous century which they evidently have also inherited:

<http://humanbeingsfirst.files.wordpress.com/2010/01/cacheof-occidentosis-a-plague-from-the-west-by-jalal-ali-ahmad-translated-by-rcampbell-introduction-by-hamidalgargar.pdf>

And this is the Arab world's – not so much an intellectual Negro, but an outright un-apologetic House Negro – Professor Fouad Ajami of Johns Hopkins. It is fascinating to appreciate it in his own vernacular, in his autobiographical [Dream Palace of the Arabs: A Generation's Odyssey](#):

'Today in Arab World – I left for America a day or two short of my eighteenth birthday, in 1963 – I am a stranger, but no distance could wash me clean of that inheritance.' (page 24)

That bit of statement of fact from his autobiography was of course left un-stated as Professor Fouad Ajami was daily paraded on mainstream television and presented to the American viewers as an objective “expert” on the Middle East. He was always there right alongside all the [objective expert Pentagon Generals](#) and various other think-tank pundits during the immense “*doctrinal motivation*” buildup to *Operation Iraqi Freedom* in 2002-2003! Here is another gem from his autobiography:

'I knew little of religion. My family were Shia Muslims. ... None of my peers I

recall, observed religious ritual or went to the mosque for Friday prayers. We were not a religious breed. Our lodestar was the secular political and cultural world. ... Fate had played with the lives of men and women, and it had dealt the Palestinians what it had. This sensibility could not be mine or my generation's as a whole.' (page 12,13)

It is therefore unsurprising that Professor Fouad Ajami finds much favor with Zionist Islamophobes like [Daniel Pipes](#), and of course with the [New York Times](#). The reason I do not consider Dr. Fouad Ajami an 'intellectual Negro', but rather just an ordinary 'House Negro', is because Ajami is very straightforward. He forthrightly speaks in the vernacular "we". The poor chap is outright suffering from *occidentosis* in its most basic form: he is more white than the white man! And to his credit, he is also un-apologetic about it. The white man thus adores [native informants](#) like him! And why wouldn't he? The following is an excerpt from an un-published review of Fouad Ajami's autobiographical book, from Chapter 9 of my own 2003 maiden work, *Prisoners of the Cave*:

'In many places in the *Dream Palace*, Dr. Fouad Ajami provides insightful commentaries on the state of the Arab world. It can actually be quite an enjoyable book for its wit with some gems of quotations from Arab poets. But it is also an upsetting book as a politically indoctrinating propaganda for the Zionists. It is replete with prejudice and misrepresentation of facts through carefully crafted omissions of history and its selective retelling – especially by someone of Arab Muslim origin turned Zionist sympathizer. It appears from his book that Fouad Ajami greatly admires the assassinated Israeli Prime Minister Rabin. Laudatorily calls him “*a son of Zionist pioneers*”, and scorns the intellectuals in the Palestinian Diaspora for their “maximalist” and unrealistic “right of return” position against Israel.

His entire articulation seems to me to be a thinly disguised glorification of Israel, and his opinions mirror those of the Israeli establishment. There is nothing wrong with that per se – one always feels closer to one's own people. But there is something incredibly devious about not openly projecting Fouad Ajami as spokesperson for Israel as he is paraded on mainstream television, but rather always as an expert on the Middle East purveying a neutral and informed perspective on the conflagration there. Whereas on the very rare occasion when the other side is invited, it is made abundantly clear that they speak for the Arab perspective. The subtleties of subliminal manipulation is not lost on any astute observer. But of course, on everyone else in America who are its victim.

Thus, when Fouad Ajami speaks or writes, he dwells on the Palestinian suicide bombers like any Israeli, and omits Israel's incessant killing of innocent Palestinian children, women, and men on a daily basis, the deliberate demolition of their homes with armored bulldozers making large families homeless on their own lands again and again forcing them to life in refugee tents, or any of the facts that have already been exposed earlier in this book. He glowingly talks of Israel's great economy, and conveniently fails to mention the billions of dollars of American tax payer's wealth and the mighty military-industrial complex defense contracts that Israel receives from America annually which makes that economy run in proxy services to the hectoring hegemons.

He berates the Arab dictators and their despotism in those societies, and fails to mention how these same dictators are propped up by active support of the Americans – even as he allows other voices to mildly say these things in his book, he never says them himself. He praises the Arab kings who journey to Israel, and fails to mention the reality of these kings – who put them there in the first place and whose interests they really represent.

His book is replete with sins of omission and misrepresentation in the guise of pseudo psychoanalysis of the Arab psyche, and especially of the Palestinian population in Diaspora. Professor Ajami's dominant appearance in the mainstream news media when no other voices of dissent are allowed to rebut his propaganda, makes him especially powerful in molding public opinion. And he is indeed permitted to hold sway over the minds of the unsuspecting American public mainly because he serves the purpose of empire. Due to this fact, it is imperative and fair to expose his inimical biases against the very people whom he is being called upon to offer his “objective” opinion, so that all may judge for themselves.

So, when Fouad Ajami opines, it must remain clear to the American audience that he does not represent anyone but himself and his Zionist masters. That, his Middle Eastern appearance, accent, and enormous heritage are an inconvenient baggage from which, by his own admission: **“no distance could wash me clean of that inheritance.”** That, his political views and purported analyses only project the one-sided perspective of the approximately 4 million Zionist Jewish population of Israel and their few hundred thousand backers and financiers in America diabolically orchestrating their Eretz Yisrael on the backs of the conquered superpower



du jour. That, Professor Fouad Ajami does not betray the tortuous realities on the ground for the over 100 million Arab Muslims anymore than his Zionist masters. That, Fouad Ajami is in fact, their House Negro!

So, what's the antidote for such a pernicious disease which is spreading rapidly among a small population of the 'untermenschen' (German word for 'the lesser people')?

I feel that as in the yesteryear, the solution to overcome these dreaded cancers of de facto mental colonization are also the same: un-colonized, un co-opted, clear-headed, inspiring leadership by the fearless who can both instill some pride among the people, and stand up unfettered to the hectoring hegemons – just as Malcolm X did.

Transformative leadership isn't a parrot. Nor is it a useful idiot. And nor an intellectual nigger! It is an independent thinker and courageous leader appropriate to its own time and space.

Such transformative leadership can only arise from among the 'field Negroes' – I don't see it happening at all from among the 'house Negroes'. The degree of their co-option is evidently complete! And such emergent leadership, in order to be effective, would be required to immediately and strenuously confront both the 'house niggers' and the fifth columnists in a continuous battle with entrenched power, and this is where they are liable to come up very prematurely dead without having made a dent!

Therefore, without an astute political acumen and real power base that can protect the emerging leadership, the game is over before it is begun. Only power can cut power!

**Source URL:** <http://print-humanbeingsfirst.blogspot.com/2010/02/what-is-intellectual-negro.html>

FAQ First Published February 9, 2010

## Chapter 29 Not Fooled Again: Dissecting the Massa's Dissent

### Rebuttal to Paul Craig Roberts': 'Washington Arrogance has Fomented a Muslim Revolution'

#### Summary

**Zahir Ebrahim rebutted in a letter to editor on Sat, Dec 6, 2008 at 11:14 AM:** 'Do you mind, Mr. Paul Craig Roberts, if you stopped blaming Muslims for all the black-ops' false-flag operations on the planet: **“The attack on Mumbai required radicalized Muslims”?**'

**Paul Craig Roberts replied on Sat, Dec 6, 2008 at 1:39 PM:** *“Whoever wrote this letter cannot read. I wrote that the Muslims were revolutionaries, not terrorists, that they had been driven to revolution to throw off their Western oppressors.”*

**Zahir Ebrahim responded on Sat, Dec 6, 2008 at 3:02 PM:** 'Merely quoting you Mr. Paul Craig Roberts: **“The attack on Mumbai required radicalized Muslims”**. Your article is nonsense. It is the work of a disinformationist, if not an outright simpleton. It ignores black-ops entirely. It ignores the reality-space of creating pretexts for incremental faits accomplis for world-government. It blames the Mumbai terror event as the blowback for America's excesses. The wanton and meaningless terror act was nothing of the kind. There is also no revolution brewing among the Muslims *“to throw off their Western oppressors.”* Far from it. Your essay is merely a devious attempt to resurrect a boogiemán that doesn't exist – along the lines of *“clash of civilizations”*, but replacing Bernard Lewis' *“Islamic Triumphalism”* with your *“radicalized Muslims”* due to oppression. It isn't clear why one should rejoice in Muslims being called *“revolutionaries”* for acts which are entirely terroristic, wanton, take the lives of innocent, and outright criminal. If anything, it is maligning an entire peoples. Still works wonders when the enemy is kept external. And the name of **“whoever wrote this letter”** is Zahir Ebrahim.'

**Paul Craig Roberts replied on Sat, Dec 6, 2008 at 7:32 PM:** *“you are a completely stupid fool, a disgrace to humanity”*

The following letter to editor was sent to the listed editors on Sat, Dec 6, 2008 at 11:14 AM. Mr. Paul Craig Roberts' responses and my followup rebuttal are appended. A darling of the white man's dissent, many Western websites published PCR's essay; none carried my straightforward refutation. The Massa carrying the white man's burden, a frequent contributor to Vdare.com, evidently did not like being exposed by a mere "field negro"!

**Letter to Editor:** BaltimoreChronicle, Lewrockwell, Antiwar.com, WRH, Infowars & Alex Jones

**CC:** paulcraigroberts@yahoo.com

**December 06, 2008.**

The only response I can give to this lame article being carried on your stellar website 'Washington Arrogance has Fomented a Muslim Revolution', is the letter appended below. Do you mind, Mr. Paul Craig Roberts, if you stopped blaming Muslims for all the black-ops' false-flag operations on the planet: ***"The attack on Mumbai required radicalized Muslims"***? Thanks!

Zahir Ebrahim

An ordinary Muslim

[Project Humanbeingsfirst.org](http://ProjectHumanbeingsfirst.org)

**The Real Terrorists: Letter to Pak Alert Press**

**December 05, 2008**

Thank you for compiling these references in this analysis "THE NARIMAN HOUSE STORY". The following astute observation made in the article still begs the forensic question who and why:

*"This terrorist incident will most likely lead to much greater bloodshed unless the true culprits are found and convicted in a court of law. Some analysts say that this event could lead to a new world war."*

Red Herring: 'a smelly fish that a fugitive drags across the path in order to put the pursuing

dogs off the trail'

Lest some very good peoples remain on the treadmill of red herrings, Project Humanbeingsfirst issued the following as comment for this excellent website Pak Alert Press. It is reproduced below. [Zahir's Afterword: Subsequently, I determined Pak Alert Press to itself be an intelligence operation run by either the Pakistan military or the ISI. All nations' intelligence agencies maintain a very strong front on the internet and spend countless millions (or billions in case of the superpower) trafficking in the tunes of the Mighty Wurlitzer.]

## **The Real Terrorists – by Zahir Ebrahim**

The atrocity in Mumbai last week, and the bizarre data that is emerging, will make more sense if one stops viewing this heinous terrorist act from the traditional Indian-Pakistan lens. It is urgent that people in both nations begin to appreciate what's at stake so that each may initiate proper self-defense against accurately identified hidden dangers from the overt 'katputli tamashas'.

The following News Flash is Project Humanbeingsfirst's position on this manufactured terror. To appreciate it, please study the methods of Rand Corporation, CFR, Zbigniew Brzezinski, et. al., and acquire an understanding of the notion of world-government. **Political science runs the world, and the children of Machiavelli are deeply rooted in waging war by way of deception – a game of conquest “as old as mankind”**. From the East India Company to Free Trade to the War on Terror – all enablers of pretexts for “imperial mobilization” and “full spectrum dominance”. In the West, typically, the smartest students study humanities and social sciences, and the think-tanks as well as the Pentagon are populated with scores of PhDs in political science and history. What do you think they do there? What do you think they do at the Ford and Rockefeller Foundations, and the Carnegie Endowment for Peace? How about at CFR and RIIA? They are united in one common global agenda – world government. And they get there by shrewdly employing the overarching political science concept articulated by David Ben Gurion **“what is inconceivable in normal times is possible in revolutionary times”!**

Therefore, please don't blame the Hindus or ISI or Jihadis – patsies and mercenaries come in all stripes, ethnic origin, and social class. And the best recruits for patsies are always those who have grievances or are disgruntled. The best recruits for mercenaries are the ruling-elite, politicians, and military men. In both cases they know very little, in fact often zero, and are merely the 'trigger pullers' of average intelligence. Instead, look for those

'ubermensch' who employ them. To do so, one has to understand the agendas, and what scheme of things is really being enacted on the world-stage. That, according to the forensic reports of Project Humanbeingsfirst (available on its website), points to an entirely different motivation-space and entirely different criminals from the 'katputli tamashas' being enacted for public consumption.

**News Flash:**

Terrorist rampage in Mumbai, India – Watch for “Hindustan Patriot Act” being enabled shortly! The last bastion of democracy, the largest in the world, had to be converted into a police state as “World government could only be kept in being by force”. This isn't an isolated event. The monetary collapse, the Obama government, predictions of first year of horrible terrorist acts worldwide to be blamed on the manufactured 'Militant Islamists' – enablers of endgame. Stop blaming either the Indians, or the Pakistanis. This has been a mil-ops all the way – no different than the Marriott Hotel terrorist act in Islamabad. **See Press Release WHAT'S TO BE DONE – Massive Bomb Blast in Islamabad Marriott September 20, 2008**. The same applies to Mumbai.

Thank you.

Zahir Ebrahim

[Project Humanbeingsfirst.org](http://ProjectHumanbeingsfirst.org)

---

**Mr. Roberts Replied with Cc to editors: Sat, Dec 6, 2008 at 1:39 PM**

Whoever wrote this letter cannot read. I wrote that the Muslims were revolutionaries, not terrorists, that they had been driven to revolution to throw off their Western oppressors.

---

**Zahir Ebrahim responded with Cc to editors: Sat, Dec 6, 2008 at 3:02 PM**

Merely quoting you Mr. Paul Craig Roberts: **“The attack on Mumbai required radicalized Muslims”**.

Your article is nonsense. It is the work of a disinformationist, if not an outright simpleton. It ignores black-ops entirely. It ignores the reality-space of creating pretexts for incremental faits accomplis for world-government. It blames the Mumbai terror event as the blowback for America's excesses. The wanton and meaningless terror act was nothing of the kind. There is also no revolution brewing among the Muslims **“to throw off their Western oppressors.”** Far from it. Your essay is merely a devious attempt to resurrect a boogiemán that doesn't exist – along the lines of **“clash of civilizations”**, but replacing Bernard Lewis' **“Islamic Triumphalism”** with your **“radicalized Muslims”** due to oppression. It isn't clear why one should rejoice in Muslims being called **“revolutionaries”** for acts which are entirely terroristic, wanton, take the lives of innocent, and outright criminal. If anything, it is maligning an entire peoples. Still works wonders when the enemy is kept external.

And the name of **“whoever wrote this letter”** is Zahir Ebrahim.

Thank you,

Zahir Ebrahim.

---

**Mr. Roberts replied: Sat, Dec 6, 2008 at 7:32 PM**

**From:** Paul Craig Roberts <paulcraigroberts@yahoo.com>

**Reply-To:** paulcraigroberts@yahoo.com

**Subject:** Re: Rebuttal: Washington Arrogance has Fomented a Muslim Revolution

**To:** "Project Humanbeingsfirst.org" <humanbeingsfirst@gmail.com>

**Message-ID:** <404762.10564.qm@web65614.mail.ac4.yahoo.com>

**you are a completely stupid fool, a disgrace to humanity**

To be sure that such rich munificence being heaped upon the Muslims is not from some ordinary ignorant fellow in the mainstream, Mr. Paul Craig Roberts' distinguished bio which accompanied his article reads as follows:

*Paul Craig Roberts is an economist who served as an Assistant Secretary of the Treasury in the Reagan Administration earning fame as the "Father of Reaganomics". He is a former editor and columnist for the Wall Street Journal, Business Week, and Scripps Howard News Service. He is the author of Supply-Side Revolution: An Insider's Account of Policymaking in Washington; Alienation and the Soviet Economy: The Collapse of the Socialist Era and Meltdown: Inside the Soviet Economy, and is the co-author with Lawrence M. Stratton of The Tyranny of Good Intentions: How Prosecutors and Law Enforcement Are Trampling the Constitution in the Name of Justice.*

So, Project Humanbeingsfirst will graciously let him have the last word.

No big deal that a supposed dissent-chief [among the massa] and a great supporter of justice [for the plebeians] only heaped slander upon the Muslims in the guise of critiquing his own nation: **"The attack on Mumbai required radicalized Muslims"**. His masters have done much worse – bombed entire civilizations into smithereens. See Weapons of Mass Deception – The Master Social Science to understand the dialectics of deception, and the concept of manufactured dissent among the rebels to complement the manufactured consent among the mainstream, both of which retain all core-axioms of 'empire' intact! The difference is that for consent, the empire is projected as good. For dissent, the empire is projected as bad. But the same external enemy is retained, and only re-incarnated either as "jihadis" and "Militant Islam" (consent), or "revolutionaries" and "blowback" (dissent). Neither manufacturers will ever extend their discourse to covert-ops, to forensic analysis of overarching agendas, and to "inside job"!

**Source URL :** <http://print-humanbeingsfirst.blogspot.com/2008/12/letter-paul-craig-roberts-rebuttal.html>

First Published December 06, 2008

## Chapter 30 Not Fooled Again: The Masters of Discourse

### Responsibility of Intellectuals – Redux

What indeed is the responsibility of intellectuals to the people? We already know what the intellectuals, the veritable masters of discourse, have themselves proclaimed it to be – without adding the word "people" to their description. Let's quickly review. My favorite description comes from Vaclav Havel:

*"I too think the intellectual should constantly disturb, should bear witness to the misery of the world, should be provocative by being independent, should rebel against all hidden and open pressure and manipulations, should be the chief doubter of systems, of power and its incantations, should be a witness to their mendacity. For this very reason, an intellectual cannot fit into any role that might be assigned to him, nor can he ever be made to fit into any of the histories written by the victors. An intellectual essentially doesn't belong anywhere; he stands out as an irritant wherever he is; he does not fit into any pigeonhole completely."* (Vaclav Havel: 'Disturbing the Peace', A Conversation with Karel Hvizdala, quoted by Mark Chmiel in 'Elie Wiesel and the politics of Moral Leadership')

In Havel's self-apportioning of responsibility to intellectuals, himself being one, there is no mention of why the intellectual must have such responsibilities. Why does he or she need to be an *'irritant'*, why must he or she *'rebel against all hidden and open pressure and manipulation'*, and be the *'chief doubter of systems, of power and its incantations'*? Why may the intellectual not be an exponent of Machiavelli in the service of the powerful, of *'power and its incantations'*, telling 'Nobel Lies' to serve the ruling interests? After all, those who run *'systems'* also need intellectual and doctrinal backbone to carry them out, don't they?

Isn't it but manifest empiricism that since the Renaissance that preceded the industrial revolution, with the waning of kingdoms and aristocracies, feudalism and servitude, and the arrival of plebeian norms and free thinking that were the precursors of modern day 'populist democracy' in the West, new forms of plebeian intellectual regimentation and willing control (despite that being a nonsequitur) were invented in astute political philosophy to serve the interests of the ruling elite? From Machiavelli's "Prince", through Nietzsche's "ubermensch",



to Strauss' "Nobel Lies" of modernity, are of course all intellectualism too, and in the very distinguished service of primacy of the ruling class. So what's wrong with such intellectualism?

Havel provides no keen philosophical insights in his prescription of *'irritant'* being the sole role of an intellectual, apart from axiomatic assertion, perhaps borne from some internal (unstated) moral sense. But different people have different internal moral sense, and hence that's not a universal axiomatic description unless it can either be rationally proved, or a recourse to some absolute external source of morality is made, and nor is it a profound basis for moral intellectualism. If it were, this would just be a simple truism, as in any religion borne from unexamined axioms handed by an absolute divinity, and not very intellectually profound as a philosophy, or even an original contribution by Havel. Prophet Moses preceded him by at least three thousand years with the Ten Commandment axioms. No empirical political philosophy has yet been founded upon its teachings in the West since the Renaissance (we'll just forego the periods before that to be nice and focus mainly from the onset of rationalism in the West).

So let's look at someone even more distinguished for guidance who is *'arguably the most important intellectual alive'* in the entire Western Hemisphere, who wrote the seminal piece on responsibility of intellectuals in the later half of the 20th century titled "Responsibility of Intellectuals", and other derivative works: [1], [2], [3]

*"It is the responsibility of intellectuals to speak the truth and to expose lies"*  
(Responsibility of Intellectuals)

*"the responsibility of a writer as a moral agent is to try to bring the truth about matters of human significance to an audience that can do something about them."* (Power and Prospects)

Once again, why must an intellectual *'speak the truth'* and *'expose lies'*? Why must he or she bring the *'truth about matters of human significance to an audience that can do something about them.'*? This isn't just a pedantic question. It is the crux of the matter.

The distinguished Noam Chomsky further notes:

*"Intellectuals are in a position to expose the lies of governments, to analyze actions according to their causes and motives and often hidden intentions. In the Western world, at least, they have the power that comes from political liberty, from access to information and freedom of expression. For a privileged minority, Western democracy provides the leisure, the facilities,*

*and the training to seek the truth lying hidden behind the veil of distortion and misrepresentation, ideology and class interest, through which the events of current history are presented to us...."* (Responsibility of Intellectuals)

Sure the Western intellectuals living in free societies *'have the power that comes from political liberty, from access to information and freedom of expression.'* So why must they not use it in the service of the ruling elite, and instead *'seek the truth lying hidden behind the veil of distortion and misrepresentation'*? How can the plebeian tell the difference what the scholars are doing? It was indeed Plato, wasn't it, who portrayed the rule of the virtuous 'know it all', the 'ubermensch', leading the sheep to their manifest destiny - a virtuosity of supermen, that some like Leo Strauss interpret it, a Nietzscheian morality that is beyond good and evil, one that is wholly utilitarian in serving some vested interests.

Once again, no Occam's razor like clarity is provided by Noam Chomsky either. You may review all three references cited above, and will only come away with the unremarkable comprehension that the intellectual field has been carved up between the exponents of the ruling elite, whom I shall dare refer to as the "high priests" openly serving the interests of power, and Havel-Chomsky self-proclaimed responsibility of being *'irritants'* to that power, whom I shall dare call the "dissenting priests". It is almost as a kids' game of dividing into two teams to play off against each other, or as in high school forensic tournament of champions having the Affirmative and the Negative, or as in the Parliament having Government benches and its Opposition - both around *'systems of power and its incantations'*, one positing it, the other doubting it, with the people left wondrously watching, often quite uncomprehendingly. A cynical view? Please read on.

There is no a priori reason to believe claims to morality by the intellectual, as asserted by Chomsky with the banal phrase *'the responsibility of a writer as a moral agent'*. It is not entirely self-evident why such an assertion must be axiomatic. Or indeed how can it be shown to be continually true beyond mere continued axiomatic assertions.

Except of course, if such self-apportioned responsibility by the intellectual is merely a tool to serve an end, and not an end in itself. Just as it is a tool in the hands of the Machiavellian espousing the morality of supermen, if it becomes a tool in the hands of the intellectual espousing the banal morality, one not beyond good and evil, but specifically only intended to serve the plebeian.

The only rational and comprehensible basis for moral responsibility upon an intellectual, is if they wish to serve the interests of the plebeian peoples, as opposed to merely opposing the

elite peoples. The two are not synonymous. One may oppose the ruling elite for many reasons, including personal ego, self-interests, personal guilt, as an intellectual contest, as an academic lost in the ivory tower of academe writing histories of past crimes that are now faits accomplis, none of which necessarily have anything to do with serving the contemporary interests of the plebeian except as a side effect. Only when the first-principle is serving the plebeian, and only serving the plebeian over one's own self-interests, then, and only then, does such a moral responsibility delve upon the intellectual, and only if they take it upon themselves, and proclaim to do so. And even when they conscientiously take this upon themselves primarily to serve the best interests of the plebeian, there is no assurance that they are telling the truth in order to serve the plebeians' best interests. Indeed, there is no a priori reason to assume one is telling the truth and not merely playing the Ezra Pound described game, the Technique of Infamy, of being part of two or more sophisticated (or simple) lies keeping the plebeians occupied with which of them might be true.

Thus an intellectual claiming to be a moralist in the interest of serving the plebeian, must always be under scrutiny by the plebeians - no differently than for a politician claiming to do the same - to ensure that the intellectual is indeed serving the plebeians' best interests, and not their own self-serving ones. Just merely self-proclaimed claims to morality, while perhaps sufficient for one's own conscience, is not a sufficient credential in public life for anyone, as per rational commonsense. Why should an intellectual make any more claims to morality, than any other ordinary person in society?

Thus, what then is indeed the public responsibility of the self-proclaimed moral intellectual - making the deliberate distinction between one proclaiming morality exclusively in the service of the peoples, and any other intellectual. By definition, the former is associated with the "dissenting priest" who claims to serve the interests of the people by dissenting with the ruling elite, the latter is the "high priest" who is quite clearly and visibly aligned with the interests of the *'power and its incantations'*. And they are indeed "priests" because they each respectively claim axioms of their own.

Only in the public examination of their axioms can they lose claims to priesthood and be stripped naked as either genuine moralists worthy of public following, or Machiavellis deserving of public stoning.

So what indeed are the "dissenting priests'" responsibilities towards moral intellectualism? And what are the responsibilities of the plebeian to ensure that the intellectual priests are continually stripped of their unexamined axioms to keep them honest? As one Jewish moralist once put it, albeit in a different context, but I would like to take the liberty of borrowing that very convincing and idiomatic diction here:

*“Although the Holocaust inflicted horrible injustice upon us, it did not grant us certificate of everlasting righteousness. The murderers were amoral; the victims were not made moral. To be moral you must behave ethically. The test of that is daily and constant.”*

The *'test of that is daily and constant'*. Indeed. The test however is only self-administered when one is concerned with one's own conscience. But a scholar's soul is of no concern to the plebeians - how can any outsider ever peer into the blackened abyss of another's soul? The latter may have none! Thus the test is not self-administered when public responsibility is proclaimed by the "dissenting priests", but one that must be *'constant'*, and *'daily'*, and administered by the plebeians themselves.

So let's succinctly take the responsibilities of each in turn. This is what a rather pedestrian plebeian, me, demands of the moral intellectuals who appear to be "dissenting priests". If they purport to serve my interests, then they must cater to my expectations of them. There are obviously no plebeian expectations from the "high priests" of the ruling elite, for they make no bones about whose interests they serve. It is indeed the "dissenting priests" who are of most concern to the plebeians, for they may also be the Trojan Horses deliberately cultivated, like the proverbial sleeper agents of intelligence intrigues, to create a more convincing shadow play for the free-willed plebeians who can otherwise become quite dangerous for the interests of any elite in free democratic societies.

### **Responsibility of the "dissenting priests" as "moral agents".**

What is my primary expectation from them? To be a moral compass on knotty and vexing issues du jour. I don't expect them to be activists or policy advocates. I expect them to be the moral voice without paying heed to the impracticality or efficacy of bringing about any change or transformation. They need to chart the course for the society in what is indeed the **'right and moral and just thing to do'** space. As they endeavor to identify the convolutions on the lies and bear witness to the mendacity of power of faits accomplis, I need them to prevent new criminal faits accomplis of monumental injustices from occurring, especially when such criminal acts can be contemporaneously co-opted by an informed plebeians taking the right course of action that is seeded by an unequivocal moral compass. If the moralists are themselves co-opted by pragmatism, exigency, expediency, political reality, then how are they any different from politicians? A moral intellectual who is a moral agent purporting to *'bring the truth about matters of human significance to an audience that can do something about them'* can only do so first and foremost, as an unequivocal moral compass for his peoples, and only secondarily as the revolutionary.

An intellectual can certainly be an hands-on activist seeded by that axiomatic moral compass, his or her own, to create on the ground advocacy if he or she possesses the physical energies and the charisma. Many plebeians possess physical energies, and many leaders of men possess charisma, but not many possess the mental acumen of the profound intellectual, which is why their seeding a moral compass justly and truthfully is of indescribable primal significance which can eventually lead to **Moral-Activism** by their plebeian activist followers. Without moral compassing, any flock is quite simply, and almost always, 'lost in the land of Canaan', figuratively speaking. And higher the pulpit, larger the flock, greater the responsibility, and yes, greater the accountability to the plebeians. Conversely, greater the priest leading them, greater the responsibility upon the plebeians themselves to create Moral-Activism that is justly seeded by the moral compass who was faithful to his own responsibility as an honest intellectual of the plebeians.

**Responsibility of the Plebeian looking up to the dissenting priests as "moral agents".**

The "dissenting priests" aren't really the spokesperson for god who may not be challenged. So what must the plebeians do to keep their priests honest? Examine their axioms! If a "dissenting priest" takes on axioms in contemporary matters of great '*human significance*', refuses to examine them unhyprocritically in public, refuses to convincingly explain why the same arguments that were applied in the past by him are not being applied in the contemporaneous present to the same qualitative issue of the mendacity of power and its incantations, then there is a gigantic red herring in the works. Application of the Rational Golden rule of morality – also called the Biblical Golden Rule by some – can also often help adjudicate a "dissenting priest's" position on emotional matters where there may be potential self-interests at play. [4]

Examination of unexamined axioms, and judicious use of the Golden Rule in unraveling hidden self-interests, can keep any public person honest, from politician to the self-proclaimed dissenting intellectual moralist, even including the real priests.

In my humble plebeian view, it is only that very accountability to the plebeians, and which must be extracted by the plebeians, that brings an Occam's razor's clarity to the matter and constructs any commonsensical genuine moral Responsibility of Intellectuals. One that is owed exclusively to the plebeians. The rest is merely the intellectual stroking of the mind by the intellectuals, their own and others.

Thank you.

## References

[1] **Intellectuals and the Responsibilities of Public Life** - Interview with Noam Chomsky, May 27, 2001 <http://www.publicanthropology.org/Journals/Engaging-Ideas/chomsky.htm>

[2] **An Exchange on 'The Responsibility of Intellectuals'** - Noam Chomsky debates.. April 20, 1967 <http://www.chomsky.info/debates/19670420.htm>

[3] **The Responsibility of Intellectuals** - Noam Chomsky, Feb 23, 1967 <http://www.chomsky.info/articles/19670223.htm>

[4] **The endless trail of red herrings**, Zahir Ebrahim, February 28, 2007 <http://humanbeingsfirst.blogspot.com/2007/03/endless-red-herrings.html#Chomsky-Ambiguities>

**Source URL:** <http://humanbeingsfirst.blogspot.com/2007/03/responsibility-of-intellectuals-redux.html>

First Published March 03, 2007

## Chapter 31 Not Fooled Again: Safeguarding Our Moralsense

### Morality derived from the Intellect leads to Enslavement!

*"When you stand before God to be judged, do you really think at that time you will be able to enter a debate with God about your behavior? Playing with or bending some words to cover-up or justify your bad deeds? Perhaps a little "white lie" here and there? Do you really think you can deceive God?" --- Anonymous from a website*



This problem was solved by Nietzsche a long time ago!

There used to be a prominent T-Shirt worn around campus when I was an undergrad, it said in bold:

**God is Dead -- Nietzsche**

(of course I am not going to provide the punch-line that was printed in very fine letters just underneath that, at least not just yet!)

More pertinently however, morality and intellect are two separate things. It is mixing them where people become misled!

Intellect cannot confer upon morality any view other than subjective, and hence relative and arbitrary. The following statement from an 'uber intellect' is a good evidence of this:

“Nothing is more certain in modern society than the principle that there are no absolutes, that a name, a phrases, a standard has meaning only when associated with the considerations which give birth to nomenclature. To those who would paralyze our Government in the face of impending threat by encasing it in a semantic strait-jacket, **we must reply that all concepts are relative.**” -- Justice Vinson, U.S. Supreme Court, 1951 AD

However, the following algorithm is not just evidence of what I say, but its outright proof. This proof is furnished by the 'uber uber' atheist of the 20th century, i.e., the most fanatical God is Dead exponent, Mr. Bertrand Russell. I can't recall the exact chapter and verse, but it goes something like this.

Bertrand Russell's morality synthesis exclusively from the intellect:

~'Maximize individual happiness (pleasures) while minimizing social conflict (not hitting on another's spouse) to optimize the overall happiness of the people composing the social unit who agree to live by the set of laws which implement this operations-research calculus.' -- Bertrand Russell also noted some caveats for protection of minors and those unable to make choices so that one could not maximize one's pleasures upon them without some institutional safeguards. As I recall, he limited his caveats to the sexual predation of children in his otherwise unbridled advocacy of free sex.

Using that highly intellectual morality equation – and I will confess that I have not encountered a more profound synthesis of morality and law anywhere, and which, on the surface at least, appears rather full of brilliance and minimalism – it would be perfectly acceptable, for instance, to spread Black-death every other generation for population control and eugenics among other 'untermensch' societies. Or, to create a draconian police-state by re-defining what individual happiness might mean, and conditioning the people to get used to it. As Goethe had observed, **“none are more hopelessly enslaved than those who falsely believe they are free”**. In such a society, the people could be kept quite content in their voluntary servitude thus leaving no social conflict whatsoever – and thus culminating in a perfectly stable and rational society.

In this highly intellectual system, also called **Secular Humanism**, enslaving the populace by a bunch of wily 'ubermensch' who have craftily chosen not to be constrained in the **“semantic strait-jacket”** alluded to by Judge Vinson quoted above and who accept **“that all concepts are relative”**, that state of affairs would be a perfectly moral outcome. It certainly satisfies Bertrand Russell's intellect-derived morality calculus. And if someone



thinks I am making all this up, Bertrand Russell himself concluded in his epiphany to 'uber' intellectual morality, in his 1952 book **“Impact of Science on Society”**, that a Scientific Society, meaning one built on intellect – as obviously imbeciles can't do high-tech science – will automatically culminate in **“World government [which] could only be kept in being by force”**. According to Russell's brilliant mind, such a world would be stable, peaceful, and have all the other desirable social characteristics that a superior intellect running the world demands.

We can brazenly observe this exercise of the 'uber' intellect for instance, not just in the world government under construction which of course no one believes is happening, but in the Talmud among its very moral followers which no one can ever deny unless their lips are moving in chutzpatic confabulations. The Ten Commandments of Moses are intellectually particularized from their universal moral form, by adding an implied “Jew” at the end. Thus, as has been amply exposed by many recovering Jews themselves, **“Thou Shall Not Kill”** is read by many an adherent Talmudic Rabbi as: **“Thou Shall Not Kill [a Jew; killing goy is OK]”**.

And as evidence that this **“hegelian mind fck”** isn't just some historical baggage which happened in the Dark Ages with no bearing to modernity, here is the latest version of the Law Book of Israel religiously permitting the slaughter of the goy: **'The King's Torah'**: <http://www.gilad.co.uk/writings/the-complete-guide-to-killing-non-jews.html>!

For additional examples of this ongoing **“hegelian mind fck”**, please see: <http://print-humanbeingsfirst.blogspot.com/2009/11/genesis-to-genocide-golem-not-jewish.html>

Fundamentally, the problems outlined in the anonymous lede quotation at the beginning of this essay have been long solved both practically, i.e., by using force, as well as philosophically, i.e., by using the brilliant intellect. Here is a short passage from Leo Strauss which shows just how remarkably it is has been solved by the *uber alles*:

'Political Zionism has repeatedly characterized itself as the will to normalize the existence of the Jewish people, to normalize the Jewish people. By this self-definition it has exposed itself to a grave misunderstanding, namely, the misunderstanding that the will to normality was the first word of political Zionism; the most effective criticism of political Zionism rests on this misunderstanding. In truth, the presupposition of the Zionist will to normalization, that is, of the Zionist negation of galut [exile], is the conviction that "the power of religion has been broken". Because the break with religion has been resolutely effected by many individual Jews, and only because of

this reason, it is possible for these individuals to raise the question on behalf of their people, how the people is to live from now on. Not that they prostrate themselves before the idol of normality; on the contrary: they no longer see any reason for the lack of normality. And this is decisive: in the age of atheism, the Jewish people can no longer base its existence on God but only on itself alone, on its labor, on its land, and on its state. ...' -- page 202, Leo Strauss, The Early Writings 1921-1932

See its fuller exposition at the link below, but here is the core essence of that morality:

'In simple language which peels off the philosophical-gibberish of ***“will to normality”*** and such, straightforwardly speaking: god gave the Jews the land grants, anointed them as the 'chosen peoples', and then Nietzsche killed god, and now it's up to the Jewish people who ***“can no longer base its existence on God but only on itself alone, on its labor, on its land, and on its state”***, in order to construct their own future ***“because the break with religion has been resolutely effected by many individual Jews”*** who must now lead their flock!!!' -- <http://print-humanbeingsfirst.blogspot.com/2009/02/letterto-dalitvoice-which-god.html>

See how wonderful a solution it is mes amis? I hope no one is too sarcasm impaired here.

Not to be outdone by atheists in defining their own super-morality with their uber-intellect, god's chosen theists can even outdo that with learned confabulations – become god themselves:

'... The point is that a Jew has strength, ability and power to create the desire within G-d to accept and become King over the entire creation.

It's understood, that the existence of the entire creation, in truth, is brought about by the Jew's coronation of G-d, and through which He becomes a King over the entire creation, which ultimately results in the fact that all of creation comes from the Primary being, G-d.

It's obvious that since every Jew, men and even women and children, brings about the existence of the entire creation, they become masters over the world, and thus every single creation owes them recognition for this good.

**Being that through the Jew, all beings were created, he therefore becomes the master over all of them.**

This is especially so in regards to what needs to be accomplished on erev [every?] Rosh Hashana.

Since the judgment of Rosh Hashana is primarily regarding physical matters, as explained in Likutei Torah, therefore the Jew is in complete control, particularly over physical matters.

The physicality of the world itself has to recognize the good that the Jew has accomplished.

Through the Jews they came into being, and their true existence is through their unity with the True Being.

**Since G-d and the Jews are one, each Jew becomes a True Being, and is thus able to bring about all of creation.**

**He therefore has control over all of creation and not only that, but they owe him thanks** and are indeed thankful, for being provided with abundance in physical and especially spiritual matters.' -- Transcription from a video of Talmudic reading by a Rabbi, The Coronation of Hashem: <http://bloghumanbeingsfirst.wordpress.com/2010/10/22/on-jews-becoming-the-masters-of-the-world-the-coronation-of-hashem-from-the-torah/#masters-of-the-world>

Such is the natural culmination of morality when the superior intellect is put in charge of it! The sociopaths will always justify the ubermensch.

It would of course be a travesty of thought to end this missive without giving the punch-line that was printed on the T-Shirt noted above. I wish I had bought one – at the time it was only humorous. It read:

**Nietzsche is Dead -- God!**

I can hear someone laughing...

Because I can actually feel that humorous laugh down my spine without either any physical sound waves impinging upon my eardrums from across the ether or by engaging my raw intellect (the humor would fall flat on Mr. Spock of Star Trek for instance who is all intellect), it shows me that, inter alia, morality likewise is naturally felt from an inner sense of empathy, not naturally thought.

Morality originates from the heart where feelings reside, not the mind – Plato's virtuous philosopher-king notwithstanding. Such abstract intellectualism, including his Shapes, appear to reside in the vast immanent-space of the philosopher's mind alone since they can find no empirical verification in the far more constrained existential reality-space. The only morality that the intellect is empirically shown to beget from time immemorial, is the Nietzschean-Hegelian variety explored above, of **might has rights!** It is also known as the divinely ordained law of the jungle to some. To others, it constitutes the categorical imperatives of primacy which are cast beyond good and evil, *uber alles*, above all others. To still others, it is simply the amoral precision of **“military-style objectivity”** to achieve any agenda, national and international. This “military-style objectivity” was explained at great length in the brilliant 'Report from Iron Mountain'.

Whereas, interestingly, as in all lovers' happy and tragic tales also since time immemorial, the Heart also is where the Almighty resides! Read both the Qur'an and the Bible and one sees references to the heart as the container for morality, for spiritual eyes. One encounters unsurpassed moral advice for mankind such as: the cleanliness of the heart begetting the cleanliness of the soul. And admonitions such as: none shall approach the truth unless they approach it with a cleansed heart, there being a “seal” put upon the heart of those who are heedless, who are purveyors of falsehoods, who bring misery upon mankind by their planning, mischief making, etceteras.

Indeed, the heart metaphor plays such an existential role among mankind that I have yet to recall knowing anyone who actually fell in love using their intellect, as opposed to through their heart. Or even recall reading any literature, sacred or secular, and I am an indefatigable reader, that alluded to the mind for matters of love, faith, courage, self-sacrifice, and yes, the notorious jihad – jihad-un-nafs – the primordial inner struggle of the soul to overcome the **“banality of evil”** only upon the conquest of which, the proverbial sword of righteousness is automagically both found and comes unsheathed! When I used to read comparative religions in my younger days, I recall also the case of appeal to the heart being true of the Hindu scriptures as well, and many others.

In conclusion, the famous author of **“Cogito Ergo Sum”** might have taken a tiny lesson from the Zen of the heart were he not so imbued in its own arrogance of the intellect, and so blinded by its own brilliance to actually have missed the commonsense observation. Watch Zen Master Bruce Lee so simply teach this universal moral truth [below](#):



Caption Bruce Lee teaching the Tao of Reflection, the Zen of Martial Arts, to a younger apprentice in the movie Enter the Dragon: ***“We need emotional content. Don’t think, feeel; it is like a finger pointing away to the moon. Don’t concentrate on the finger or you will miss all that heavenly glory”!***

It should be patently obvious to anyone that an intellect voluntarily serving under the command of morality, can be the only possible solution for equitable and peaceable *“Cogito Ergo Sum”* for all mankind. Its converse inevitably only leads to the enslavement of the 'lesser peoples' among mankind. The ancient Talmudic texts emanating from the collective minds of the chosen people's rabbis, as their modern updates, the many brilliant strategy documents and protocols outlining primacy imperatives, are veritable evidence of that fact.

I will humbly further suggest that the clincher empirical proof that morality and intellect are distinctly separate entities, that morality is primarily rooted in feelings, empathy, rather than in the intellect, is that had ordinary people simply retained even an iota of humanity in them, even a tiny feeling of empathy for the suffering of fellowman, for their own natural tribe of mankind, then, instead of intellectually watching the decimation of their own kith and kin all unfold on television looking from the side, at best going tsk tsk, and at its misanthropic worst, cheering (see: Israelis, sipping Pepsi, watch bombardment of Gaza town <http://www.mcclatchydc.com/homepage/story/59013.html> ), we would have collectively marched in formation and forcibly neutered all the hectoring hegemony now so boldly munching on their victims no differently than the lowly wildebeest and buffaloes do against

the hectoring hegemons of their jungle!

And no scientist in the universe can argue with a straight face that the poor buffaloes who **feel the pain so immensely** for their own humble kith and kin as depicted in the video below, are a very cognitive species – a fact also brazenly recognized by our own hectoring hegemons! Which is why they work so assiduously on desensitizing our **feelings** of empathy for our fellowman, including for our ourselves, by not just keeping us fully occupied in bread and circuses as per the “Fable of the bees”, but also by continually bringing us all the manufactured Hollywood violence and other baser entertainment to amuse ourselves to death:



Caption: Youtube Video Battle at Kruger.

The solution therefore, for saving ourselves from becoming pending meals of primacy, is obvious. It requires no further verbiage.

The only question which remains: **do we care?** The buffaloes evidently trump mankind today on that question!

**Source URL:** <http://print-humanbeingsfirst.blogspot.com/2009/12/morality-from-intellect-is-enslavement.html>

First Published December 09, 2009

## Chapter 32 Case Study: Surviving the Grand Chessboard

### Hegemony is as old as mankind!

**A Case Study in International Relations from the breaking events on the Russian-Georgian border in August 2008 to highlight the obvious solution space for interdicting the present unilateral terror on the Grand Chessboard – a return to real “balance of terror”!**

“Hegemony is as old as mankind.” That pithy statement captures almost 100% of mankind's recorded history. It is either a struggle for, or against, hectoring hegemons – big and small. And as this pathetic history of mankind demonstrates, hegemony is only broken before its natural 'time-constant' with active resistance to it; never with platitudes or wishful thinking. At its natural 'time-constant' however, hegemony simply collapses (or dies its natural death) under its own weight of successes, expansions, or failure to maintain. This natural death of the hectoring hegemons and their systems of hegemony need not concern us here as their 'time-constant' today is long enough to destroy all or most of mankind leaving behind only their scurrying interests, and those of the cockroaches, to contend with each other.

Thus, the remaining history of mankind only teaches us one insightful lesson with respect to effective takedown of hegemony – hectoring hegemons only understand other hectoring hegemons. And, the effective resistance of fed-up victims with nothing more to lose and unwilling to take it anymore. Since the mass resistance of the peoples has been very effectively neutralized worldwide in the modern age, we are only left with hectoring hegemons battling each other. What Albert Wohlstetter in 1958 so elegantly captured as **“Mr. Oppenheimer's simile of the two scorpions in a bottle”** [1] to safeguard the fly between them via a precarious **“balance of terror”**. In this simile, either or both predators may be killed, or either may get the meal, or, in a most delicate balance, all may survive in peace! That is the theme of this report.

Until 08-08-08, there had been no apparent counter-hegemons bold enough, and courageous enough, to urgently standup to the unipolar superpower apocalyptically exercising its quest for “full spectrum dominance” of the entire planet and its outer-regions under the Orwellian cover of “war on terror”. No nation except the two without teeth, Iran

and Venezuela, even dare to publicly 'call a spade a spade' and condemn the destruction of Iraq and Afghanistan or the pending American-Israeli primacy upon Iran. A handful of retired statesmen, like Mahatir Mohammed of Malaysia, and Nelson Mandella of South Africa, have occasionally added their anemic voices to this weak rumblings to exactly zero utility. The Georgia-Ossetia conflagration which was deliberately provoked by the hectoring hegemony under their own calculus of hegemony, can potentially change that – and only if the great-game is played with astute vigilance and full spectrum courage. But not with platitudes, moralizing, sermonizing, or wishful thinking, such as:

“For whatever reason, Brzezinski seems to have his own “personal obsession” with Russia. American hypocrisy and double standards will not solve anything. What the “west” and the “world” needs is for America to go home, withdraw its military from around the globe, and try participating in a multilateral world, using international institutions, rather than the “full spectrum dominance” it now uses for its global resource war (oil) now destroying the Middle East.” (Jim Miles, Deconstructing Brzezinski's Russia [2])

Project Humanbeingsfirst's two-part report of August 2008, titled “Georgia-Russia: It's a Classic Brzezinski Project!” [3] has already identified this conflagration as a Zbigniew Brzezinski imprint. (See Appendix A) The pithy wisdom which titles this present follow-on report is also the astute observation of this same grandmaster. It is the very first sentence of Zbigniew Brzezinski's 1996 book “**The Grand Chessboard**” and aptly sums up the raison d'être of its entire content. That raison d'être in turn, is aptly summed up in the book's chauvinistic subtitle: “**American Primacy and Its Geostrategic Imperatives**”.

This essay fleshes out the theme of hegemony and its only practicable take-down by beginning with the question: is this “American Primacy and Its Geostrategic Imperatives” a uniquely Brzezinski thing?

It can be rather disconcerting to uncover that Zbigniew Brzezinski's thinking is very closely espoused in his predecessor neoconservative strategist, Albert Wohlstetter's 1958 Rand Report “The Delicate Balance of Terror”, [4] in which this old-timer, long-dead war-mongering, and evidently mentor to the latter day neo-cons, preached against the complacency of the “*Balance of Terror*” doctrine of the Truman Administration for containing any thermonuclear war with the USSR. Wohlstetter advocated more along the present day neo-cons' line of calculated “unilateral terror” as rationally, and pragmatically, the only effective mechanism of exercising hegemony. Wohlstetter complained that “*balance of terror*” in reality was rather a precarious and dynamic balance, but more



importantly, unnecessarily limited the imperial “creativity” of the mighty United States into a stalemate. He argued: *“If peace were founded firmly on mutual terror and mutual terror on symmetrical nuclear powers, this would be, as Churchill has said, “a melancholy paradox;” nonetheless a most comforting one.”* That “*melancholy paradox*” was examined in Project Humanbeingsfirst's report of April 26, 2008 of the new world order post 9/11, titled: “From Balance of Terror to Unilateral Terror on the Grand Chessboard!” [5]. (See Appendix B)

Resuming from where the grotesque reality-check of that report had left us, this breaking news of the forced intervention of Russia into Georgia, if played astutely by the Russian president Vladimir Putin, can lead to what the empire actually does not want in these times. That is, a return to *“balance of terror”*, which is arguably a far more desirable outcome on the Grand Chessboard from the untermenschen's point of view bearing the full brunt of the present day unilateral terror!

Mr. Putin perhaps does have this reality in mind, or at least appears aware of its power of equalization, especially if one carefully parses his measured statements in his interview of August 28, 2008 [6] to CNN where he observed, in response to various pointed questions:

Begin Excerpt

**Vladimir Putin:** We have serious reasons to believe that there were U.S. citizens right in the combat zone. If that is the case, if that is confirmed, it is very bad. It is very dangerous; it is misguided policy.

But, if that is so, these events could also have a U.S. domestic politics dimension.

If my suppositions are confirmed, then there are grounds to suspect that some people in the United States created this conflict deliberately in order to aggravate the situation and create a competitive advantage for one of the candidates for the U.S. presidency. And if that is the case, this is nothing but the use of the called administrative resource in domestic politics, in the worst possible way, one that leads to bloodshed.

[...] I have said to you that if the presence of U.S. citizens in the zone of hostilities is confirmed, it would mean only one thing: that they could be there only at the direct instruction of their leaders. And if that is so, it means that in the combat zone there are U.S. citizens who are fulfilling their duties there. They can only do that under orders from their superiors, not on their own initiative.

[...] A little victorious war is needed. And if it doesn't work, then one can lay the blame on us, use us to create an enemy image, and against the backdrop of this kind of jingoism once again rally the country around certain political forces.

I am surprised that you are surprised at what I'm saying. It's as clear as day.

[...] During my eight years as president, I often heard the same question: What place does Russia reserve for itself in the world; how does it see itself; what is its place? We are a peace-loving state and we want to cooperate with all of our neighbors and with all of our partners. **But if anyone thinks that they can come and kill us, that our place is at the cemetery, they should think what consequences such a policy will have for them.**

**Matthew Chance:** Let's go back to the assertion that the U.S. provoked the war. Diplomats in the United States accuse Russia of provoking the war by supporting the separatists in Abkhazia and South Ossetia by arming them, by increasing forces in the territories and by recognizing their institutions ... basically giving them the green light to go ahead and operate de facto. Wasn't it Russia that really caused this conflict?

**Vladimir Putin:** I can easily reply to this question. Since the 1990s, as soon as this conflict started, and it started in recent history because of the decision of the Georgian side to deprive Abkhazia and South Ossetia of the rights of autonomy. In 1990 and 1991, the Georgian leadership deprived Abkhazia and South Ossetia of the autonomous rights that they enjoyed as part of the Soviet Union, as part of Soviet Georgia, and as soon as that decision was taken, ethnic strife and armed hostilities began. At that time, Russia signed a number of international agreements, and we complied with all those agreements. We had in the territory of Abkhazia and South Ossetia only those peacekeeping forces that were stipulated in those agreements and never exceeded the quota.

The other side -- I am referring to the Georgian side -- with the support of the United States, violated all the agreements in the most brazen way.

Under the guise of units of the Ministry of the Interior, they secretly moved into the conflict zone their troops, regular army, special units and heavy equipment. In fact, they surrounded Tskhinvali, the capital of South Ossetia,

with that heavy equipment and tanks. They surrounded our peacekeepers with tanks and started shooting at them point blank.

It was only after that, after our first casualties and after their number considerably increased, after tens of them had been killed -- I think 15 or 20 peacekeepers were killed, and there was heavy loss of life among the civilian population, with hundreds killed -- it was only after all that that President Medvedev decided to introduce a military contingent to save the lives of our peacekeepers and innocent civilians.

What is more, when our troops began moving in the direction of Tskhinvali, they came across a fortified area that had been secretly prepared by the Georgian military. In effect, tanks and heavy artillery had been dug into ground there, and they started shelling our soldiers as they moved.

All of it was done in violation of previous international agreements.

It is of course conceivable that our U.S. partners were unaware of all that, but it's very unlikely.

A totally neutral person, the former Georgian Minister of Foreign Affairs Ms. Zurabishvili, who is I think a French citizen and is now in Paris, has said publicly, and it was broadcast, that there was an enormous number of U.S. advisers and that of course they knew everything.

And if our supposition that there were U.S. citizens in the combat zone is confirmed -- and I repeat, we need further information from our military -- then these suspicions are quite justified.

**Those who pursue such a policy toward Russia, what do they think?  
Will they like us only when we die?**

End Excerpt

That sarcastic concluding remark by Putin sums up the Russian comprehension of the grandmasters riding the sole superpower and arrayed against their giant nation on the Grand Chessboard! Thus Russia's quick actions to recognize the independence of the two appendages of Georgia on [August 26, 2008](#) [7] are predictable micro-moves:

“Bearing in mind the free expression of their will by the Ossetian and

Abkhazian peoples, and guided by the UN Charter, the declaration of 1970 on the principles of international law regarding friendly relations between states, the Helsinki Final Act of 1975 and other fundamental international documents I have signed decrees on the recognition of the independence of South Ossetia and Abkhazia by the Russian Federation.” (Russian President Dmitry Medvedev)

If Project Humanbeingsfirst's hopes for ordinary peoples of this planet to survive in peace are not to be dashed, Putin's next macro counter-moves are predicted in: [“Georgia-Russia: It's a Classic Brzezinski Project!”](#) [8].

The fact that the Russian leadership intimately comprehends such counter-play on the Grand Chessboard is further betrayed in the Russian President Dmitry Medvedev's [August 31, 2008](#) [9] articulation of the core-principles of Russia's foreign policy going forward: **“While implementing the Russian foreign policy, I will be guided with five principles”**. The three most revealing among them:

Begin Excerpt

Secondly, concerning the unacceptability of the new world order: **“the world must be multi-polar. Single polarity is unacceptable, ... Russia cannot accept a world order, in which any decisions will be made by a sole nation, even such a serious one as the United States. Such a world order will be unstable and fraught with conflicts.”**

Fourthly, concerning protecting Russian citizens and Russian business interests being an absolute priority: **“no matter where they live ... We will also stand up for the interests of our business community abroad. Everyone must know that an aggression will be deterred”**.

Fifthly, concerning Russia's national security interests in the world: **“The same as other countries, Russia has areas of privileged interests. These areas house countries, to which we are linked with friendly ties”**.

End Excerpt

Interestingly, the other two guiding principles (the first and third, quoted below) articulated by the Russian President also seem to be calculatingly constructed, but mainly for the world's public consumption no different than Zbigniew Brzezinski or the Project for the New

American Century doing so by throwing in some Orwellian platitudes in their conquest doctrines on the Grand Chessboard. Witness the expected continuity of Orwell across continents, when primacy is the unhidden agenda behind “peace” platitudes, in chronological sequence:

“... the ultimate objective of American policy should be **benign and visionary**: to shape a **truly cooperative global community**.” (Brzezinski, Grand Chessboard, 1997)

“... we need to promote the cause of **political and economic freedom abroad**,” (PNAC, Statement of Principles, 1998)

“... Keeping the **American peace** requires the U.S. Military to undertake a broad array of missions today and rise to very different challenges tomorrow, but there can be no retreat from these missions without compromising American leadership and the **benevolent order it secures**.” (PNAC, Rebuilding America's Defenses, page 76, 2000)

Russia's first foreign policy principle: “**First of all, Russia recognizes the supremacy of international legal fundamentals, which define relations between civilized nations**” (President Dmitry Medvedev, August 31, 2008)

Russia's third foreign policy principle: “**Russia does not want isolation [or confrontation with any country]. We will develop as much as possible friendly relations with Europe, the United States and other countries of the world**,” (President Dmitry Medvedev, August 31, 2008)

While the afore-stated latter two Russian aspirations of a resurgent non-ideological Russia may be genuine statement of principles in a perfect-world without any hectoring hegemons, self-interests and survival instincts in the real-world is as much a prime-mover for Russia as the earlier-cited Albert Wohlstetter's and his legatee Zbigniew Brzezinski's primacy proposals for “unilateral terror” are for America!

The first three American aspirations noted above are surely nothing but Orwellian, as empirically evidenced over the past 60 years for an undefeated continually war-mongering America, and as forensically analyzed elsewhere ([here](#) [10] and [here](#) [11]) and shown to be entirely self-consistent with George Kennan's 1948 Policy Planning paper for the U.S. State Department. America's foreign policy is entirely predatory, and has been so for at least a hundred years following upon the heels of the British Empire (see Rudyard Kipling's 1899 poem *The White Man's Burden*).

Perhaps it would do well to rehearse that Darwinian theme here, except that now, the insidious object of George Kennan's primacy prescription is the construction of an oligarchic world-government corporate-empire in a devilishly manufactured **“unipolar”** world in which, while initially, the **“United States has overstepped its borders in all spheres -- economic, political and humanitarian and has imposed itself on other states”**, eventually, it will come to mean only **“one thing: one center of power, one center of force, one center of decision-making, a world of one master, one sovereign”**:

“We have about 50% of the world's wealth, but only 6.3% of its population .... In this situation, we cannot fail to be the object of envy and resentment. Our real task in the coming period is to devise a pattern of relationships which will permit us to maintain this position of disparity without positive detriment to our national security. To do so, we will have to dispense with all sentimentality and day-dreaming, and our attention will have to be concentrated everywhere on our immediate national objectives. We need not deceive ourselves that we can afford today the luxury of altruism and world-benefaction .... **We should cease to talk about vague and – for the Far East – unreal objectives such as human rights, the raising of living standards, and democratization. The day is not far off when we are going to have to deal in straight power concepts.** The less we are then hampered by idealistic slogans, the better.” (George Kennan, Policy Planning Study 23, 1948)

Considering that the eloquent description of **“unipolar”** world is from Putin's own candid tongue circa February 2007 [12], it is clear that the Russians already well understand George Kennan's imperial prescription quoted above.

The Russians also fully realize that only in a multilateral world is where the rights and privileges of the broad diversity of the peoples who inhabit this lonely planet, especially the vast majority of its 85% populations who live outside the shores of the Atlantic-powers, can be safeguarded, including their own!

And, not living in some fools utopian paradise that runs on lofty platitudes, they obviously also understand that effective multilateralism in the predatory Darwinian real world is only possible through a carefully constructed *“balance of terror”* – for after all, **“hegemony is as old as mankind”**. This unilateralist principle of all predatory empires, whether national, monarchic, or oligarchic, the Russians well understand, is not about to voluntarily change in the next 1000 years!!!

The CSTO [13] countries (Belarus, Armenia, Uzbekistan, Kyrgyzstan and Tajikistan) in Russia's backyard united in security guarantees with Russia since 1992, apparently fully comprehend this reality as demonstrated by their measured endorsement [14] of Russia's position on South Ossetia and Abkhazia as independent nations. The Russian Foreign Minister Sergei Lavrov further noted on September 04, 2008 [15]:

“[Their] statement support Russia’s actions in the zone of the Georgian-South Ossetian conflict [and] the active role of Russia in contributing to peace and cooperation in the Caucasus and call for ensuring firm security for South Ossetia and Abkhazia on the basis of the UN Charter, the Helsinki Final Act and other fundamental documents of international law.”

At this time however, it is not entirely clear whether the Chinese also fully comprehend the time-criticalness of making hard new alliances and security pacts in Asia in order to safeguard their own national interests. Or, are they merely playing their own measured chess game on a different time-scale. The SCO countries (Russia, Kazakhstan, Kyrgyzstan, Tajikistan and Uzbekistan) in China's Asiatic backyard, united in a difficult to comprehend and rather toothless economic alliance with China since 2001 (along with the nondescript Mongolia, Iran, Pakistan, and India superficially participating as observer countries), concluded their annual meeting on August 28, 2008 [16] with a luke-warm response to the Russian move in its joint declaration:

“3. **The member states of the SCO express their deep concern** in connection with the recent tension around the issue of South Ossetia, and call on the relevant parties to resolve existing problems in a peaceful way through dialogue, to make efforts for reconciliation and facilitation of negotiations.

The member states of the SCO welcome the approval on 12 August 2008 in Moscow of the six principles of settling the conflict in South Ossetia, **and support the active role of Russia in promoting peace** and cooperation in the region.”

With merely its expression of “**deep concern**”, and lip-service support of the “**active role of Russia in promoting peace and cooperation in the region**”, China too must surely also realize that the systematic and devilish destabilization of Pakistan, the calculating American military occupation of Afghanistan with repeated forays into Pakistan's picturesque mountainous regions and the concomitant cold-blooded barbarous killing of Pakistani civilians in collusion with Pakistan's own military, are really the un-subtle prelude

for the complete encirclement and orchestrated breakup of their own gigantic Chinese land-mass alongside Russia! They also cannot possibly be oblivious to the “carbon-credit” scam being orchestrated largely for their “economic” benefit. Why China and Russia persist in dragging their feet in making full spectrum alliances in Asia remains a major puzzle as already explored in [“The Missing Link - Full Spectrum Deterrence”](#). [17]

Indeed, the remarkable kowtowing to the American definition of “War on Terror” in the same [SCO](#) [18] declaration, and not recognizing it as a crafty fabrication for “imperial mobilization” that it actually is, either betrays a lack of forensic skills and intelligence processing on the part of the Confucius mind, or a surfeit of wait-until-ready strategy that is still willing to operate under the global fiction of fight against terrorism:

“6. The member states of the SCO express satisfaction at the increased interaction in fighting terrorism, separatism and extremism in the framework of the Organisation, and intend to raise cooperation of the member states in the field of ensuring security to a qualitatively new level by using the means of the Regional Antiterrorist Structure of the SCO.

The member states of the SCO reaffirm their commitment to strengthening the central coordinating role of the UN in mounting an international response to the threat of terrorism, to consistent implementation of the UN Global Counterterrorism Strategy, earliest possible approval of the Comprehensive Convention on International Terrorism.

The member states of the SCO are determined to counter the attempts of spreading terrorist ideology, stand ready to interact closely in implementing Resolution 1624 of the UN SC, as well as in promoting dialogue among civilisations and cultures. In this regard it is also essential to rely on the potential of civil society, business circles, mass media and non-governmental organisations.”

This is rather unfortunate for Asia because it means that the SCO is not in urgent sync with the Russian interests, at least publicly speaking, and is officially operating under the dominant paradigms du jour. Indeed, Russia too continues to carry forward the same fiction of “war on terror”!

When will both Russia and China come forward and announce that 9/11 was an inside job and that the “war on terror” is an oligarchic fiction to create revolutionary times across the planet?



The leaders of these two largest land mass of Asia cannot be unaware of the impetus for one-world government in baby-steps.

Their own national survival as sovereign states depends on this fictitious war being terminated and America being forced to retreat from their borders!

Or, America stays put encircling them, and further acquiring military bases in the remaining countries of the world in the on-going pretext of fighting the evil “terrorists” which both Russia and China are helping perpetuate themselves!

These egregious acts of omission and commission therefore can lead to the only inescapable rational conclusion possible. That both the Russian and Chinese political and economic leadership are in on the one-world government agenda. That today, they are as fictitious a combatant of the West as during the Cold War. And they certainly stand to benefit in this first of its kind global hegemony, as that new concoction of world government is the final merging of super-capitalism and super-communism. In this New World Order, the oligarchy own the world, and administer it as they have learnt in their previous experiments in communism and despotism over the past century. It is today a well known fact that the financiers of both fascism and communism in the twentieth century were the Western capitalists. Some of the tortuous characteristics of the coming world order are already visible to the farsighted, but for those who enjoy good cinema and learn about the world vicariously, may be glimpsed in the two allegorical cinematic depiction based on 1984 by George Orwell and A Brave New World by Aldous Huxley. [19]

It is hard to accurately gauge the Russian and Chinese geostrategic mind in the long term. One might remain cognizant though that while Zbigniew Brzezinski may have written the modern bible on primacy, *The Grand Chessboard*, in America, chess was invented in Asia.

For the near term, i.e., within our lifetime, only in the twain secondary Asiatic superpowers immediately uniting in their mutual self-defense against the marauding sole superpower to immediately create a formidable “*balance of terror*” (both military and economic), can both nations today provide relative security, peace, and a fair treatment for their respective peoples. Only in their concerted strategic full spectrum alliance can they prevent the genocidal slaughter of their populations under the population reduction regime which will surpass what was grotesquely witnessed in the two world wars of the twentieth century.

And, in their attempted full-spectrum self-defense of their own nations, also end up securing the rest of humanity in Asia and Africa for a more robust periphery, guaranteed access to natural resources, and equitable trade! Instead of the fictitious Cold War of the

last half of the twentieth century, a real multilateral “balance of terror” can ensure the survival of mankind.

What an insanity – only the diligent and un-ending pursuit of selfishly securing one's own survival against all Darwinian predators through a “*balance of terror*” encourages the securing of the otherwise dispensable weaklings in one's neighborhood, in a perpetual full-spectrum check on the Grand Chessboard!

What prophet Moses could not accomplish with the Ten Commandments, equitable co-existence with others, “*balance of terror*” does! Even the lowly buffalos [20] know it! Surely so must nationalistic Russia and China! And in this clash of the super-titans where “**safety will be the sturdy child of terror and survival the twin brother of annihilation**” [21], the smaller nations can perhaps harvest some cunning breathing space for themselves in order to exist peacefully in precarious balance without becoming a tasty meal of the hectoring hegemon!

These smaller nations can of course also act as moronic patsies and remain front-line surrogate battle grounds for the titans! Or, they can conclude rational treaties with other nations which are, first and foremost, in their own public's best interests!

If mere platitudes, or ardent appeals to reason or compassion, could ever bring about fairness in international relations (or in the wielding of hegemonic power through its modern day instruments of “international institutions” like the World Bank, IMF, the United Nations), there should have been heaven on earth for the past 3000 years, at least ever since the advent of the Ten Commandments and the Biblical Golden Rule “*do unto others as you others do unto you*”! And certainly since the founding of the United Nations in mankind's blood after two world wars amidst new platitudes of peace, security, and human rights. The passage from Kennan's PPS 23 quoted earlier lends only partial insight into the reality behind those platitudes. The agenda of these “international institutions” has all along been the gradual usurpation of national sovereignty and vesting all legal authority in these supra-national institutions as the baby-steps towards one-world government.

This being the unvarnished reality-space of international relations behind all the Newspeak and obviously understood by the actual international players (as opposed to by the public for whose benefit their Newspeak exists), what then must have been the primal American hegemon's motivation to engage Russia at this time, even before their oft stated goal of destroying Iran is launched? As observed by this scribe in “Georgia-Russia: It's a Classic Brzezinski Project!”:

“The one forensic explanation which wholly and rationally explains this (mis)adventure by Georgia is that from the Anglo-American perspective, it was a trap set for the Russians to behave exactly as they did. The Georgians and Ossetians are just disposable cannon fodder – patsies like the Afghans before them.

... Additionally, keeping Russia busy on its flank while engaging Iran – if indeed Iran is actually to be bombed by Israel and/or the massive US naval armada now besieging her – makes short term military sense.”

Why is “**keeping Russia busy on its flank**” in order to decimate Iran necessary? The only forensic explanation that continues to make any strategic sense, is that Russia was effectively preventing the American-Israeli attack on Iran. It matters little precisely how, so long as it remains a covert Russian move that the hectoring hegemon has been made well aware of.

One however overtly observes the Russians easily neutralizing Israel's supposed setting up of Georgia as their (Israel's) recon-refueling launch-pad for attacking Iran. Was this neutralizing just a side-effect of the Russian intervention? Is such a launch-pad even essential for attacking Iran? How about Western news headlines [22] like “**Russia threatens to supply Iran with top new missile system as 'cold war' escalates**”? Or Russian public denials [23] like “**No covert Russian arms sales to Iran, other region**”?

I think all these are red-herrings for public consumption which are at best, mere posturing moves. And at worst, sacrificial pawns at the expense of Georgia-Ossetia and Iran! Apart from the overt Anglo-American policy of Russian-Chinese full encirclement which has no urgent immediacy to warrant precipitating such a deliberate crisis, the key *raison d'être* for engaging Russia in Georgia in this gratuitous war appears to be Russia's behind-the-scenes effective obstruction in preventing American-Israeli decimation of Iran!

In effect, if one reflects on real deterrence with teeth, it hardly matters where the Russian 'S-300' self-defense missiles are physically located, if Iran and Russia have concluded a covert security agreement! Israel also clearly does not require any intermediate launch-pad capability in Georgia solely to decimate Iran!

Therefore, logically speaking, and without any actual receipts in hand but knowing that “**Deception is the state of mind, and the mind of the State**” and therefore, whatever is made manifest by the Mighty Wurlitzer in the newsmedia is but a public-relations shadow-play of the far more grotesque reality of behind the scenes power-play, manufacturing this

unnecessary crisis now has one rational purpose. Enabling the long-planned attack on Iran which propaganda warfare alone is evidently not enabling!

And because of Russia's obduracy, her direct engagement has apparently become urgently necessary! No other geostrategic reason, while arguable, can display this timeline of urgency!

Putin's plausible conjecture that it may have been American Presidential election related is arguable because both the presidential candidates serve common masters and have common advisors! There is, after all, even a Brzezinski in each camp! Thus, this unimaginative Brzezinski project in Georgia is mainly to divert Russia from Iran in a high-stakes game of poker, with a quid pro quo as the immediate anticipated reward. Namely, we'll back off from your backyard if you stop interfering in the attack on Iran! Otherwise, we'll foment more of the same!

Nothing else makes military or strategic sense, despite the fact that there are some analysts who feel that a different behind-the-scenes power faction, the so called "Brzezinski" faction, has already taken over the reins of power in Washington at the expense of the Dick-Cheney centered neo-cons who were largely fixated with the Middle East and oil. These analysts mistakenly conclude that the new mandarins would rather use Iran to fight Russia in a global proxy war and thus destroy them both in a conflagration on a much larger geopolitical canvas. I don't believe this mild differentiation to be true, or even relevant, because the documented evidence in the architects' own hand-writings suggest that there is little difference in the 'ubermensch' imperatives outlined by George Kennan in 1948, Albert Wohlstetter in 1958, Brzezinski in 1997, PNAC in 1998, all the documents from AEI and other think-tanks in the interim, the White House's own Nuclear Posture Review in 2002 which simultaneously targeted Russia and China alongside Iran and Syria for preemptive nuclear warfare, and the barbaric hegemonic conquests empirically displayed by the United States since 2001 until today, all of which together are merely pretexts to create the "*revolutionary times*" needed to cement one-world government. It is apt to remind oneself of the famous protocol statement of David Ben-Gurion: "*what is inconceivable in normal times is possible in revolutionary times*". Any hair-splitting in tactics is only that – evolving "*revolutionary times*" to match the state of the game on the Grand Chessboard without any fundamental difference in overarching objective! And its antidote therefore, also remains the same – full spectrum alliance! Everything else are planted red herrings!

The full-spectrum conquest strategies of the hectoring hegemons are formed and fleshed out at Pentagon surrogates like the private Rand Corporation, and in the privatized covert-

ops rooms of tax exempt foundations and non-profit think-tanks led by the private Council on Foreign Relations whose membership comprises the who's who of American military-industrial-financial-media complex. The story of the role of CFR in synthesizing both domestic and international policy which is simply rubber-stamped by Congress and signed by the President can be read in Eustace Mullins, Gary Allen, Douglas Reed, Antony Sutton, Carroll Quigley, etceteras (see Recommended Reading at the end). These conquest strategies are no longer individual-centric even though they are led by prominent individuals in every generation, but rather, have been made institutional-centric. And quite bipartisan, with common financiers who fund all sides in every generation. Which explains the uncanny longevity of these hegemonic aspirations for world government and persistent similarities in policy articulations across generations of conniving planners and political leaders regardless of which political party they belong to.

Unlike the empires of yore, anyone brilliant and skilled enough is invited (or coerced) to join this new world order enterprise in the lower hierarchies so long as they are agreeable to play by the imperial rules and can help extend 'empire'. Participants are offered rich rewards and glorification. Detractors are easily co-opted into acquiescence. A former FBI agent rightly observed of this state of affairs: *'Of course we should be quick to recognize that no small group could wield such gigantic power unless millions of people in all walks of life were "in on the take" and were willing to knuckle down to the iron-clad regimentation of the ruthless bosses behind the scenes. As we shall see, the network has succeeded in building its power structure by using tremendous quantities of money (together with the vast influence it buys) to manipulate, intimidate, or corrupt millions of men and women and their institutions on a world-wide basis.'* (W. Cleon Skousen, *The Naked Capitalist*, pg. 6)

The differing aspects which gain prominence at different times with new front-faces representing them, are but sub-facets of the same overarching strategic goal: world-government! By any other name, empire! Not a nationalistic one, but a global oligarchic one where independent nation-states are made obsolete in preference for geographic administrative domains as in "Mafioso territories", and all implementing the same "rule of law" handed them by the financing "families"! The modern vernacular "International Relations" is merely the refined Newspeak to bring about this state of affairs.

It matters little which 'ubermensch' tactical facet of conquest is realized in which order, except to the victims – some "feel the pain" of extortion and death sooner than others! Russia must surely recognize this after the 1990s [24] neo-liberal looting of its precious national assets by its magnanimous IMF "friends". The former chairman of the IMF in Moscow had even sanguinely noted: **"It was the price which Russia paid for moving forward"**. The second round for further **"moving forward"** in the 21st century is just

around the corner!

Even if Russia has recognized this blatant reality and is willing to play aggressively in self-defense as demonstrated by their public statements and acts in this crisis, can a geostrategically rich but quite defenseless Iran continue to informally count on Russia in the complex calculus of geostrategic alliances without any overt security and bilateral economic treaties as envisioned by Project Humanbeingsfirst? [25] [26]

If Russia in fact continues to play its own self-defense game astutely and her independent behavior during this crisis intervention in Georgia is not a temporary aberration, then the answer is YES. For Russia has no other rational choice but to unequivocally attempt to secure Asia from the predatory impulses of the Anglo-Saxons and their new European Allies seeking world-government to be run by the global oligarchic elite!

So what can Iran do to help nudge this rational tide urgently in its own favor?

Offer the Persian Gulf, and the Caspian, to the Russians, or to the Chinese – perhaps a hundred year lease of all its riches, patrolling rights, transit rights, and parts of its territories for military bases, to the highest bidder between them! If the Americans and Israelis can be present in Georgia, Poland, and in all the NATO countries by making legal treaties, why can't Russia and China be in NATO like treaty arrangement with Iran, Syria, Lebanon, Africa, and South America? While Pakistan is already lost to the hectoring hegemons, Iran is the next target.

Even grandmaster Zbigniew Brzezinski had outlined a plausible scenario for the United States to launch an attack on Iran in his bizarre testimony before the Senate Foreign Relations Committee on February 1, 2007, for the first time publicly admitting that the United States government can conduct false-flag operations and tell bold myth-making lies to fabricate “*doctrinal motivation*” in order to pursue his previously outlined “*imperial mobilization*” agendas on *The Grand Chessboard*: [27]

'If the United States continues to be bogged down in a protracted bloody involvement in Iraq, the final destination on this downhill track is likely to be a head-on conflict with Iran and with much of the world of Islam at large. A plausible scenario for a military collision with Iran involves Iraqi failure to meet the benchmarks; followed by accusations of Iranian responsibility for the failure; then by some provocation in Iraq or a terrorist act in the U.S. blamed on Iran; culminating in a “defensive” U.S. military action against Iran that plunges a lonely America into a spreading and deepening quagmire

eventually ranging across Iraq, Iran, Afghanistan, and Pakistan.

A mythical historical narrative to justify the case for such a protracted and potentially expanding war is already being articulated. Initially justified by false claims about WMD's in Iraq, the war is now being redefined as the "decisive ideological struggle" of our time, reminiscent of the earlier collisions with Nazism and Stalinism. In that context, Islamist extremism and al Qaeda are presented as the equivalents of the threat posed by Nazi Germany and then Soviet Russia, and 9/11 as the equivalent of the Pearl Harbor attack which precipitated America's involvement in World War II.

This simplistic and demagogic narrative overlooks the fact that Nazism was based on the military power of the industrially most advanced European state; and that Stalinism was able to mobilize not only the resources of the victorious and militarily powerful Soviet Union but also had worldwide appeal through its Marxist doctrine. In contrast, most Muslims are not embracing Islamic fundamentalism; al Qaeda is an isolated fundamentalist Islamist aberration; most Iraqis are engaged in strife because the American occupation of Iraq destroyed the Iraqi state; while Iran—though gaining in regional influence—is itself politically divided, economically and militarily weak. To argue that America is already at war in the region with a wider Islamic threat, of which Iran is the epicenter, is to promote a self-fulfilling prophecy.'

That chutzpatic bold admission carried on CSPAN was watched by this scribe in amazement – blaming the Bush Administration for their self-serving myth-making demagogic narratives to enable wars of aggression as "*self-fulfilling prophecy*", when the sole superpower in every government is only following his own recipe for "***American Primacy and Its Geostrategic Imperatives***", was outright disingenuous (like Hitler blaming his generals for following Mein Kampf and Goebbels for propaganda). And it never made it to the 7 o'clock evening news!

As Congressman Ron Paul had rightly opined about Iran on the House floor in January 2007 [28]:

'The truth is that Iran, like Iraq, is a third-world nation without a significant military. Nothing in history hints that she is likely to invade a neighboring country, let alone America or Israel.'

And realistically, as a rather un-industrialized third-world country on its economic tethers with the only real indigenous expertise being manufacturing of fine carpets, collectible handicrafts, and delicious pistachios – a sweet peoples with a sweet tooth and fine tastes – Iran can ill afford, and is ill capable of building its own effective military deterrence against a first-world nuclear predator in the short or any foreseeable term. Especially with strangulating economic sanctions limiting its capacity in all aspects of industrial, economic, and high-tech development – despite Iran's long bravados [29] which only seem to rival Sadaam Hussein's in their infantility! Iran can hardly even respond [30] effectively to the systematic destabilization covert-ops upon its vast territories being run out of neighboring Baluchistan, in Pakistan! (See Appendix C)

Without internationally proclaimed, and legally ratified full spectrum alliances that equitably benefit all parties in the pact – and in which all are stake-holders who equally stand to lose something valuable to them if the treaty is violated – Iran awaits the fate of Iraq, Afghanistan, and Pakistan!

Covert assurances and unilateral secretive guarantees are ephemeral and can vanish in a twinkle on the Grand Chessboard. Just as the famous American Sixth Fleet did in 1971 in the Bay of Bengal when West Pakistan, as member of SEATO/CENTO and under verbal assurances of security guarantees, expectantly awaited American military assistance to counter the Indian intervention in what was then East Pakistan.

Failure to accurately gauge, and astutely play the great game on the 'Grand Chessboard' in one's own self-interest like virtuoso maestros caught between *“two scorpions in a bottle”*, albeit even as lowly pawns, can trivially lead to pawn-sacrifice. And empiricism betrays that a single scorpion is always worse than two or more competing ones held in perpetual stalemate.

Iran and Russia make natural Asiatic allies with common enemies to get a real Asian Military-Economic Alliance kick-started against the primacy of the financiers from the Global North. What are they waiting for? What is their public waiting for?

## Footnotes

[1] Quoted in Albert Wohlstetter, 1958, “The Delicate Balance of Terror”, <http://www.rand.org/publications/classics/wohlstetter/P1472/P1472.html>

[2] Jim Miles, <http://www.atlanticfreepress.com/content/view/4900/81>



- [3] Zahir Ebrahim, [http://humanbeingsfirst.blogspot.com/2008/08/georgia-russia-its-a-  
classic-brzezinski.html](http://humanbeingsfirst.blogspot.com/2008/08/georgia-russia-its-a-classic-brzezinski.html)
- [4] Wohlstetter 1958, op. cit.
- [5] Zahir Ebrahim, [http://humanbeingsfirst.blogspot.com/2008/04/balanceof-terror-  
tounilateral-terror.html](http://humanbeingsfirst.blogspot.com/2008/04/balanceof-terror-tounilateral-terror.html)
- [6] <http://www.thepeoplesvoice.org/cgi-bin/blogs/voices.php/2008/08/30/p28208>
- [7] <http://www.itar-tass.com/eng/level2.html?NewsID=13009488&PageNum=3>
- [8] Zahir Ebrahim, [http://humanbeingsfirst.blogspot.com/2008/08/georgia-russia-its-  
a-  
classic-brzezinski.html](http://humanbeingsfirst.blogspot.com/2008/08/georgia-russia-its-a-classic-brzezinski.html)
- [9] <http://www.itar-tass.com/eng/level2.html?NewsID=13024477&PageNum=0>
- [10] Zahir Ebrahim, <http://prisonersofthecave.blogspot.com/2007/04/chapter-1.html>
- [11] Zahir Ebrahim, [http://humanbeingsfirst.blogspot.com/2007/03/dialog-among-  
civilizations-whytalksfail.html](http://humanbeingsfirst.blogspot.com/2007/03/dialog-among-civilizations-whytalksfail.html)
- [12] <http://www.securityconference.de/konferenzen/rede.php?sprache=en&id=179>
- [13] <http://www.presstv.com/detail.aspx?id=67860&sectionid=351020606>
- [14] [http://www.globalsecurity.org/military/library/news/2008/09/mil-080904-  
rianovosti01.htm](http://www.globalsecurity.org/military/library/news/2008/09/mil-080904-rianovosti01.htm)
- [15] <http://www.itar-tass.com/eng/level2.html?NewsID=13039341&PageNum=0>
- [16] [http://www.sectsko.org/news\\_detail.asp?id=2360&LanguageID=2](http://www.sectsko.org/news_detail.asp?id=2360&LanguageID=2)
- [17] Zahir Ebrahim, [http://humanbeingsfirst.blogspot.com/2007/12/missing-link-full-  
spectrum-deterrence.html](http://humanbeingsfirst.blogspot.com/2007/12/missing-link-full-spectrum-deterrence.html)
- [18] [http://www.sectsko.org/news\\_detail.asp?id=2360&LanguageID=2](http://www.sectsko.org/news_detail.asp?id=2360&LanguageID=2)
- [19] Movie 1984 <http://video.google.com/videoplay?docid=-5464625623984168940&hl=en#>
- Movie A Brave New World [http://video.google.com/videoplay?docid=-  
3536993421073315692#](http://video.google.com/videoplay?docid=-3536993421073315692#)

[20] Video Battle at Kruger, <http://www.youtube.com/watch?v=LU8DDYz68kM>

[21] Winston Churchill, quoted by Douglas J. Feith, Undersecretary of Defense for Policy, in his Hearing before the Senate Armed Services Committee on February 14, 2002 in the aftermath of 911. See Zahir Ebrahim, <http://humanbeingsfirst.blogspot.com/2008/04/balanceof-terror-tounilateral-terror.html>

[22] <http://www.telegraph.co.uk/news/worldnews/europe/russia/2651516/Russia-threatens-to-supply-Iran-with-top-new-missile-system-as-cold-war-escalates.html>

[23] <http://www.itar-tass.com/eng/level2.html?NewsID=13031417&PageNum=1>

[24] [http://english.pravda.ru/russia/history/19-08-2008/106148-financial\\_crisis-0](http://english.pravda.ru/russia/history/19-08-2008/106148-financial_crisis-0)

[25] Zahir Ebrahim, <http://humanbeingsfirst.blogspot.com/2008/08/georgia-russia-its-a-classic-brzezinski.html>

[26] Project Humanbeingsfirst Press Release May 15, 2008 <http://pressreleases-humanbeingsfirst.blogspot.com/2008/05/pr-full-spectrum-alliances-may152008.html>

[27] SFRC Testimony -- Zbigniew Brzezinski, February 1, 2007 cached at: <http://humanbeingsfirst.wordpress.com/files/2009/11/cacheof-us-sfrc-brzezinskitestimony070201.pdf>

[28] <http://www.house.gov/paul/tst/tst2007/tst011507.htm>

[29] Zahir Ebrahim, <http://humanbeingsfirst.blogspot.com/2008/05/letter-to-iranians-press-tv.html>

[30] Zahir Ebrahim, <http://humanbeingsfirst.blogspot.com/2008/04/ap-covertwar-imperial-mobilization.html>

**Source URL:** <http://print-humanbeingsfirst.blogspot.com/2008/09/hegemony-is-as-old-as-mankind.html>

First Published September 05, 2008

## Appendix A

### Georgia-Russia: It's a Classic Brzezinski Project! Part I

[**August 14, 2008**] The blogosphere is now filled with a plethora of interesting analysis and postmortem of the Russian-Georgian conflagration. Many scholars, academics, and activists are weighing in with their analysis on what happened. The two most illuminating (as usual) have come from globalresearch.ca and can be read [here](#) [1] and [here](#). [2] Some others have also provided good analysis and background perspectives, as for instance the erudite reports from [stratfor](#), [3] [antiwar.com](#), [4] [rense.com](#), [5] [thenation.com](#), [6] and also the one noted [here](#). [7]

However, while almost all of them rightly prognosticate a new “Cold War”, or that the Russians have finally come into their own under Vladimir Putin, they invariably imply this as an inadvertent by-product of the largely miscalculated events which can either lead to a broader war, or to a checkmate of the American empire! Inexplicably, even the usually forensic globalresearch authors (Chossudovsky and Lendman), while coming the closest to the blatant reality of hectoring hegemony, have not ventured to fully explore beyond the thin veil in the aforementioned essays “War in the Caucasus: Towards a Broader Russia-US Military Confrontation?” and “Using Georgia to Target Russia”.

Lendman comes the closest when he almost tepidly observes: ***The New Great Game – What's at stake is what former National Security advisor Zbigniew Brzezinski described in his 1997 book “The Grand Chessboard.”***, but then stops short of full exploration.

Chossudovsky too, quite forensically observes: ***“The war on Southern Ossetia was not meant to be won, leading to the restoration of Georgian sovereignty over South Ossetia. It was intended to destabilize the region while also triggering a US-NATO confrontation with Russia.”***, but surprisingly, doesn't mention Brzezinski at all! However, almost gingerly, he does ask at the conclusion of his detailed analysis: ***“Are we dealing with an act of provocation, with a view to triggering a broader conflict? Supported by media propaganda, the Western military alliance is intent on using this incident to confront Russia, as evidenced by recent NATO statements.”***

My response to Michel Chossudovsky's careful tepidity is a forceful yes as is argued below! There can be no alternate rational explanation given the history of empire. And the

mainstream media of course have done their job all too exceptionally well as is also argued below.

Consider the frightening prospect that both Chossudovsky and Lendmen have barely, but rightfully, hinted at: that Georgia's military buildup over the past years with a stooge at the helm of its affairs finally bursting her munificence in the provocative bombing of the Ossetian civilians in the middle of the night in the most despicable of ways, was an Anglo-American setup! A sting operation with a calculated opening gambit to compel the Russians to make their own forced move on the Eurasian Grand Chessboard precisely as they subsequently did!

The resulting political and military global climate so reminiscent of the “Cold War”, is neither an inadvertence, nor a miscalculation, as almost everyone else has projected. But rather, according to a cold-blooded premeditated plan for a “new world order” in which the import of Putin's 2007 observations are intended to become sardonically and completely realized.

Putin had not only warned of an autocratic-oligarchic world coming into being, but that it was so pernicious that it would destroy the nation pursuing it. Well – both are intended to come true from the Anglo-American perspective. The destruction of America via the clandestine SPP (Security and Prosperity Partnership) to create a new temporary Union en route to a world without independent nation-states that is ruled oligarchically under a singular central force. Here is Putin's relevant statements from the 2007 Munich Conference on Security Policy: [8]

“The history of humanity certainly has gone through unipolar periods and seen aspirations to world supremacy. And what hasn't happened in world history?

However, what is a unipolar world? However one might embellish this term, at the end of the day it refers to one type of situation, **namely one centre of authority, one centre of force, one centre of decision-making.**

**It is world in which there is one master, one sovereign.** And at the end of the day this is pernicious not only for all those within this system, but also for the sovereign itself because it destroys itself from within.

And this certainly has nothing in common with democracy. Because, as you know, democracy is the power of the majority in light of the interests and opinions of the minority.

**Incidentally, Russia – we – are constantly being taught about democracy. But for some reason those who teach us do not want to learn themselves.**

**I consider that the unipolar model is not only unacceptable but also impossible in today's world.** And this is not only because if there was individual leadership in today's – and precisely in today's – world, then the military, political and economic resources would not suffice. What is even more important is that the model itself is flawed because at its basis there is and can be no moral foundations for modern civilisation.”

Put it another way, this Georgian-Russian conflagration is as much a miscalculation or happenstance in 2008, as George Kennan's “Truman Doctrine” was in seeding the Cold War in 1948. Provoking Russia is very much a component of the grand master plan and Putin well understands it. The gambit offered to Putin in Georgia has willingly been accepted because Russia too is fed up of the oligarchs' “New World Order” raping her and the rest of the pluralistic world. Putin sees Russia's destruction as a mighty nation and civilization, in her continued passivity and inaction. Among all the nations of Eurasia, Russia by far has paid the greatest price in the useless wars and machinations of the Anglo-American establishment during the 20th century. No more. No more Jews bringing revolutions to Russia, or pillaging its wealth, and no more petty fascists under imperial tutelage bringing wars to its ancient borders!

With that as the backdrop of overarching motivations, let's look at the American side. If such an opening gambit as argued above isn't its main purpose, then it was asinine for the Georgians to have attacked Ossetia like this.

As reported elsewhere, the Georgians have been fully armed and controlled by the US and Israel, with full intelligence available to them 24x7. The Georgian leadership is handpicked US-Israeli puppets. The fact that the Russians had anticipated the assault by Georgia and were already in formation close to the borders because of which they were able to retaliate so quickly, was known to the Americans. Thus why would the Americans goad/command the Georgians to attack when they could trivially predict this hard likely response by the Russians? Minimally, the Russian military mobilization at the border was a sure give-away! A Rand Corporation worth its salt plays out all war-game scenarios.

It is further worthwhile asking why would the Americans deliberately antagonize the Russians by ferrying Georgian soldiers from Iraq back to the Georgian frontlines so that they can contribute to Russian and Ossetian casualties? That's quite a needless and futile

overt act of war directly by the United States against Russia – for what can an additional 2000 soldiers possibly accomplish against a modern Russian army which has a declared first-strike use of nuclear weapons as its well-publicized self-defense doctrine even in conventional precision warfare? This move by the Americans can only be understood rationally if the purpose is deemed to be deliberate nuancing of the loaded gun being held on Russia's head in America's opening gambit. If I was at the Rand Corporation, this ferrying idea might have sounded really awesome for adding fuel to the fire already lit! Hey – perhaps the Russians can be coerced into shooting down a couple of those ferry boats! Notice how proxy wars are waged? The casualties are usually the patsies!

Lastly, in the attack by the Georgians, why would they concentrate on killing the Ossetian innocent civilians rather than take on/capture/disable things of military/civil significance if capturing the Ossetian capital and re-absorbing Ossetia into Georgia was the real goal?

Apart from being provocative, there was zero efficacy to this “surprise” attack by the Georgians upon the Russians (as Chossudovsky has also noted). The only peoples really surprised were the innocent victimized public on either side!

The one forensic explanation which wholly and rationally explains this (mis)adventure by Georgia is that from the Anglo-American perspective, it was a trap set for the Russians to behave exactly as they did. The Georgians and Ossetians are just disposable canon fodder – patsies like the Afghanis before them.

This operation has all the hallmarks of a Brzezinski proxy war on Russia leaving the Russians, once again, no choice but to intervene in Georgia as they did. Just like they had no choice as the former USSR, in their intervention in Afghanistan three decades ago when Zbigniew Brzezinski started giving aid to the Mujahideen under President Carter as deliberate premeditated provocation six months before the Soviet Union's intervention. [9] All this is known history. Only its lessons seem to be forgotten all too quickly in the rush to be among the first to make one's analysis of what happened.

If the afore-stated opening gambit scenario is rational and plausible, as it appears to be if one looks at it from the geostrategic perspective on the Grand Chessboard, then it begs the obvious question why?

Why prompt this Russian Intervention in Georgia, and now? Let's flesh that out in the light of the afore-stated overarching motivations.

Just watch the worldwide mainstream news to know in a minute why!

OBL and Al-Qaida need replacing – the mantra is now well worn and not going down really well among the American and European public. “Islamofascism” has little utility in destabilizing Russia, while perhaps still potent for China. Thus the new boogiemane of the “bad bear” has been craftily resurrected.

The consistent Western mainstream news reportage over the past week which has entirely blamed Russia for the conflict in the face of blatant facts to the contrary, validates this notion that the creation of this new mantra of “bad bear” is well orchestrated. Facts are only relevant to the creation of magical mantras if they support the mantras. Otherwise distortions, half-truths, outright bold lies, and the dialectics of deception suffice to construct new propaganda. The new mantra under construction projects the Russians as once again out to exercise their hegemony due to their inescapable genetic DNA that was previously manifested as the “bad” communist USSR, and now it's simply “bad” Russia! The basic propaganda is that the Russians cannot be trusted as nice “civilized” partners of the West and they are showing their true colors once again. That they must be re-feared by the world!

This is the most apparent and visible empirical reason for this gambit. Also watch how easily the hitherto continually morphing and entirely illusive “Al Qaida” leadership are now being suddenly found and systematically killed off in the escalation of bombings in the tribal belt region bordering Pakistan and Afghanistan by NATO, the United States Military, and the Pakistan Army. For seven years ten million tons of Depleted Uranium munitions were dropped on Afghanistan without getting the famous OBL.

Yet in the past few weeks, remarkably, many so called senior “Al Qaida” leadership have not only been killed from the air, but also assertively identified as leaders! Pakistani newspapers daily report some new “Taliban” or “Al Qaida” senior leader dead from the previous night's missile attack by NATO drones on the already impoverished rural population of Pakistan's tribal region. The increased indiscriminate killings of a 'lesser' peoples who have largely been written off from the pages of history as disposable fodder, is further bringing to a head the pre-planned destabilization and falling apart of Pakistan. It appears that the “bad bear” and “Islamofascism” mantras may run in parallel for a while, until at least Pakistan is dismembered, but that the new mantra of “bad bear” is rapidly being cultivated as the new “**doctrinal motivation**” to take the latter's place for “**imperial mobilization**” in other parts of Eurasia.

The invisible or not so apparent reason, which one only understands if one looks behind the scenes towards the “**forces that drive them**”, in this case Zbigniew Brzezinski and his Anglo-American sponsors, the ruling interests are itching to also dismember Russia. And

this deliberately provoked intervention of Russia into Georgia is merely the step-1, using a similar ploy as the Afghan Trap, but with the difference that this time it is part of a destabilization campaign right on Russia's long borders.

Additionally, keeping Russia busy on its flank while engaging Iran – if indeed Iran is actually to be bombed by Israel and/or the massive US naval armada [10] now besieging her – makes short term military sense.

All ducks are lined up in a row as far as Russia hater, grandmaster Zbigniew Brzezinski – the architect of geostrategic primacy on the Grand Chessboard – is concerned.

However, as was noted by Project Humanbeingsfirst in its Press Release of June 30, 2008: [11]

While Zbigniew Brzezinski may have planned the “Grand Chessboard” in the West, his Eurasian targets of the great game actually invented chess. All four of the regions burgeoning powers, Iran, India, China, and Russia, are ancient civilizations far older than the Atlantic powers put together, and are also expert chess players in the very ethos of the richness of their civilizations. Many public parks in Iran for instance, are dotted with stone and wood carved chess tables where ordinary peoples gather daily under the shady trees to spar with each other, bringing their own chess pieces. Chess is not an acquired skill in Asia, nor is it of recent acquisition, as it is for the West! It is innate to the peoples. The Chinese classic “Art of War” is 2500 years old and still teaches the Rand Corporation how to play their great games!

One given to intimately comprehending the perverse real-world of “hectoring hegemons” in which “**safety**” is only considered to be the “**sturdy child of terror and survival the twin brother of annihilation**”, would hope that the young Mr. Putin quickly re-introduces the “**balance of terror**” from the present day “**unilateral terror**”! The latter has always been an open license for exercising primacy for “**full spectrum dominance**” by anyone who can get away with it. It is a history “as old as mankind”! While both terror paradigms can wreck havoc upon the weak and the dispensable, “balance of terror” appears to be the only pragmatic solution for surviving this dastardly “New World Order” and derailing its “imperial mobilization” as noted in Project Humanbeingsfirst's report: “From Balance of Terror to Unilateral Terror on the Grand Chessboard!”. [12]

The next rational step for Putin is to boldly initiate the extension of the SCO (Shanghai



Cooperation Organization) towards a full spectrum mutual defense pact treaty across Asia, and to immediately offer its protection to Iran as its full member. If Iran falls like Iraq, so will Russia (eventually). Having nuclear weapons is no protection when a devilishly fomented civil war can easily tear a nation apart – just look at Pakistan (and of course the wolfish dismemberment of Serbia)! Next stop – Russia! Only in full spectrum alliances [13] is there any assurance of postponing, and eventually defeating the plans for the New World Order. Some of the world's greatest minds and financiers have been preparing this masterplan for well over a century and its realization is rapidly proceeding on a logarithmic scale today. The US military power ominously besieging Iran and the rising crescendo of UN sanctions as a prelude to “shock and awe” leave little room for any delay or margin for optimism. There is no time for vacillation and false posturing [14] by the pending victims as the lives of millions of humanity is at stake! **One has got to put real teeth of real 'MADness' into one's bold self-defense!**

A rational and pragmatic message of “balance of power” in order to immediately avert the twilight of civilization – while some among mankind's greatest murderers continue to assert the mal fide discourse learned at the dawn of civilization – brought to you by Project Humanbeingsfirst.org.

## Footnotes

[1] <http://www.globalresearch.ca/index.php?context=va&aid=9788>

[2] <http://globalresearch.ca/index.php?context=va&aid=9816>

[3] [http://www.stratfor.com/weekly/russo\\_georgian\\_war\\_and\\_balance\\_power](http://www.stratfor.com/weekly/russo_georgian_war_and_balance_power)

[4] <http://antiwar.com/justin/?articleid=13285>

[5] <http://www.rense.com/general82/bear.htm>

[6] <http://www.thenation.com/doc/20080818/ames2>

[7] <http://www.thepeoplesvoice.org/cgi-bin/blogs/voices.php/2008/08/12/p27684>

[8] <http://www.securityconference.de/konferenzen/rede.php?sprache=en&id=179>

[9] <http://www.globalresearch.ca/articles/BRZ110A.html>

[10] <http://www.scoop.co.nz/stories/HL0808/S00121.htm>

[11] <http://pressreleases-humanbeingsfirst.blogspot.com/2008/06/pr-holocaust-redux-headsup-june302008.html>

[12] <http://humanbeingsfirst.blogspot.com/2008/04/balanceof-terror-tounilateral-terror.html>

[13] <http://pressreleases-humanbeingsfirst.blogspot.com/2008/05/pr-full-spectrum-alliances-may152008.html>

[14] <http://humanbeingsfirst.blogspot.com/2008/05/letter-to-iranians-press-tv.html>

**Source URL:** <http://print-humanbeingsfirst.blogspot.com/2008/08/georgia-russia-its-a-classic-brzezinski.html>

First Published Part I August 14, 2008

## **Georgia-Russia: It's a Classic Brzezinski Project! Part II**

**[August 20, 2008]:** The fact that Russia has taken up the American opening gambit handed her and is actually responding with the next “Rand predicted move”, may be gleaned in this UK Telegraph article of August 15, 2008: [1] **“Russia destroying military bases in Georgia”**. Apart from its self-explanatory title, the article notes: *“While US military aircraft and warships are being sent to the region to deliver aid, and Miss Rice is due to visit the Georgian capital Tbilisi on Friday, the presence of US soldiers in Georgia is also intended to send a strong signal to Russia of Washington's support for the government of President Mikheil Saakashvili.”* Sky news [2] reported the same day in its article **“Russians 'Seize US Weapons Depot”**: *“Relief planes have continued to fly into Georgia's capital Tbilisi with supplies for the estimated 100,000 people displaced by the fighting. US officials said their two planes carried cots, blankets, medicine and surgical supplies”*.

Therefore, the afore-quoted **“presence of US soldiers in Georgia”** in the present tense, must logically imply such presence to have commenced from before the Georgian attack on Ossetia, since the United States proclaims to have only sent in relief supplies in its two

plane loads and no military aid! This is official indirect confirmation of more than just the already known American and Israeli military advisors and military trainers being present in Georgia! Reuters had confirmed this presence on [July 15, 2008](#) [3] in its report titled “**U.S. troops start training exercise in Georgia**”, just three weeks before Georgia's attack on Ossetia, noting: “*One thousand U.S. troops began a military training exercise in Georgia on Tuesday against a backdrop of growing friction between Georgia and neighbouring Russia*”. Reuters reported that the “*two-week long*” exercise”, named “*Immediate Response 2008*”, which only serendipitously ended just one week before Georgia's midnight attack on Ossetian civilians, also comprised “*600 Georgian troops and smaller numbers from ex-Soviet Armenia, Azerbaijan and Ukraine*.” Are all these US soldiers and foreign mercenaries still in uniform? Or are they black-ops, part of some “Stay Behind Army” to engage the Russians? **Wouldn't Putin know that after the Soviet experience in Afghanistan? And wouldn't the Americans know that the Russians would know that?**

The Russian hard-nosed response of “cleansing” Georgia of American/Israeli military bases and attempting to disarm Georgia as the minimal act of carnage a “superpower” in its own right would inflict upon a provocative “gnat”, is an entirely logical and predictable military move after any invasion (provoked or premeditated). Both American and Israeli military occupations of others' homelands as well as Russia's own patsy intervention in Afghanistan prove this truism! Thus it cannot be a surprise – except for public consumption. The Russian response has entirely been anticipated at the Pentagon and Brussels' NATO planning headquarters! As per the disclosures of NATO's “Stay Behind Armies” during the Cold War under “Operation Gladio” in preparation for any hypothetical Soviet invasion of Western Europe, and as per the experience of “*giving to the USSR its Vietnam War*” in Afghanistan, the opening gambit by the Anglo-American ruling establishment in pathetically replaying history to attempt to destabilize Russia is quite transparent. **I would have expected something far more creative from Brzezinski!**

And as if on cue, Dr. Brzezinski graces us with the following as observed by SPIEGEL ONLINE in its aptly titled (for Pentagon purposes) article “**THE DANGEROUS NEIGHBOR - Vladimir Putin Takes on a Powerless West**” on [August 18, 2008](#): [4] “*American Caucasus strategist Zbigniew Brzezinski has drawn parallels to Stalin and Hitler, equating the Russian invasion of a neighboring country with the Soviet winter war of 1940, when Moscow sought to undermine the sovereignty of small, sovereign Finland*.” The article is worth reading in juxtaposition to the analysis presented in this humble essay which deconstructs Brzezinski's criminal strategies in order to acquire a complete picture of how reality is being un-imaginatively re-spun worldwide in almost about the same terms as during the 1979-88 period during the deliberately provoked Soviet Intervention in Afghanistan. Brzezinski at that time had been peddling the same “outrage” to the Afghanis

and to the world with the same overzealousness as we see today. As covered in the Time magazine article of February 18, 1980, [5] titled “**Selling the Carter Doctrine**”, which quoted Brzezinski: “***You should know that the entire world is outraged,***” he told a group of refugees at Sadda, urging them in effect to reclaim their land “***because God is on your side.***” This Brzezinski performance was captured in a minute long news clip which has been archived on the web. [6] This is what he says in 1980:

News voice Feb. 1980: “US National Security Advisor Brzezinski flew to Pakistan to set about rallying resistance. He wanted to arm the Mujahideen without revealing America's role. On the Afghan border near the Khayber Pass, he urged the Soldiers of God to redouble their efforts”

Brzezinski Feb. 1980: (addressing the Mujahideen) “We know of their deep belief in God, and we are confident that their struggle will succeed. <translation> That land over there, is yours, you'll go back to it one day, because your fight will prevail, and you'll have your homes and your mosques back again; because your cause is right; **God is on your side!**”

(clapping by the ordinary simple looking rural people who had been forced out of their humble homes in Afghanistan and living in refugee camps on the Pakistani side, now assembled to listen to Brzezinski and being knighted as the Mujahideen)

Later, after the Cold War was over, Brzezinski confessed that he had set up the USSR, the Afghanis, the “mujahideens”, and the entire world in order to “**make the Soviets bleed, for as much, as long, as possible.**” (Ibid.) It is instructive to quote Brzezinski's full cold-blooded confession here to jog the mainstream presses hazy memories as they once again peddle the thinly veiled “**American Primacy and Its Geostrategic Imperatives**”:

begin snippet Brzezinski's interview, Le Nouvel Observateur, Paris, 15-21 January 1998: [7]

Question: The former director of the CIA, Robert Gates, stated in his memoirs [“From the Shadows”], that American intelligence services began to aid the Mujahadeen in Afghanistan 6 months before the Soviet intervention. In this period you were the national security adviser to President Carter. You therefore played a role in this affair. Is that correct?

Brzezinski: Yes. According to the official version of history, CIA aid to the Mujahadeen began during 1980, that is to say, after the Soviet army invaded Afghanistan, 24 Dec 1979. But the reality, secretly guarded until now, is

completely otherwise. Indeed, it was July 3, 1979 that President Carter signed the first directive for secret aid to the opponents of the pro-Soviet regime in Kabul. And that very day, I wrote a note to the president in which I explained to him that in my opinion this aid was going to induce a Soviet military intervention.

[...]

Question: When the Soviets justified their intervention by asserting that they intended to fight against a secret involvement of the United States in Afghanistan, people didn't believe them. However, there was a basis of truth. You don't regret anything today?

Brzezinski: Regret what? That secret operation was an excellent idea. It had the effect of drawing the Russians into the Afghan trap and you want me to regret it? The day that the Soviets officially crossed the border, I wrote to President Carter. We now have the opportunity of giving to the USSR its Vietnam war. Indeed, for almost 10 years, Moscow had to carry on a war unsupported by the government, a conflict that brought about the demoralization and finally the breakup of the Soviet empire.

end snippet.

When Brzezinski cold-bloodedly confesses to the **“secret operation”** as the **“reality, secretly guarded until now”**, ominously shows off his devilish prowess to setup any patsy **“I wrote a note to the president in which I explained to him that in my opinion this aid was going to induce a Soviet military intervention”**, subsequently gloats with criminal glee **“The day that the Soviets officially crossed the border, I wrote to President Carter. We now have the opportunity of giving to the USSR its Vietnam war”**, and Jimmy Carter ends up winning the Nobel Peace Prize after playing with the 'lesser' humanity's disposable blood, then why should anyone again believe the **“American Caucasus strategist Zbigniew Brzezinski”**?

Once proved to be a liar, any fair and rational court of law, as any informed public opinion, commonsensically always rejects all further testimony! Please read Brzezinski's own words in the Time magazine du jour, August 14, 2008, [8] in his psy-ops article titled **“Staring Down the Russians”**, and ponder if you wish to believe a habitual self-confessed war-monger who trivially dismissed the destruction of Afghanistan for calculatingly *“giving to the USSR its Vietnam War”* simply as some **“stirred-up Moslems”**! When you kill one man it

is murder. When you mastermind the destruction of entire peoples as mere pawns on the Grand Chessboard, it is only “foreign policy”. As Voltaire had aptly summed it: **“all murderers are punished unless they kill in large numbers and to the sound of trumpets.”** Indeed, Brzezinski’s full statement in the cited interview reveals the real pathology that is fueling the Georgia-Russia conflagration as another proxy war of the Anglo-American establishment upon the Russian (and Georgian) peoples:

Brzezinski: “What is most important to the history of the world? The Taliban or the collapse of the Soviet empire? Some stirred-up Moslems or the liberation of Central Europe and the end of the cold war?” (Le Nouvel Observateur, 1998)

And this is a mere extension of the perpetual so called “War on Terror” as explained [elsewhere](#). [9] Bush-Cheney and the present Anglo-American establishment whose primary foreign policy architects have been the neo-cons for the past decade, have already been proved to be monumental liars on “WMDs” in Iraq and the famous Downingstreet memos! And NATO is but the global military muscle of the Anglo-American foreign policy calculus today, as yesterday! To understand NATO’s secret role in perpetuating deceit and terrorism for geostrategic ends – which in foreign policy parlance is called “strategy” – see Daniele Ganser’s brilliant detective Ph.D. thesis turned published book [“NATO’s Secret Armies”](#). The afore-cited *amnedisiac* article in Spiegel Online, as also the myriad of neo-con penned opeds in New York Times and Washington rags, unequivocally show the new global lies being diligently manufactured – but only for those handful to perceive who know and comprehend their true history! That’s almost zero percent of the Western public! And specifically, probably exactly zero percent American public. Thusly, how easily “United We Stand” to once again further dismember the “big bear” as an independent power-center en route to the mono Anglo-centric New World Order!

To further convolute the motivations of the Anglo-American establishment in initiating this geostrategic gambit, see the August 12th Alex Jones interview of chaplain Lindsey Williams. I am neutral on adjudicating what LW discloses, except that it appears to be remarkably consistent with some grotesque components of manifest reality that seek to calculatingly precipitate crises upon crises to seed *“revolutionary times”* up the wazoo!

The question that is really meaningful to this “chessgame” after Russia has completed her “pawn” move however (and She is still in the process of executing the multiple steps of that single move): will Russia initiate her own counter-moves along the **SCO** as outlined above (see [Part I](#))? Would She go on the offensive by forging a military pact with Venezuela; rapidly transition the BRIC economic cooperation into a formal economic block; and install

her military presence – nuclear military presence – in America's own backyard in South America?

Will Russia finally acquire the courage to publicly condemn America's “war on terror” as a fabrication? Will She boldly assert in her public pronouncements and at the UN that the “Islamofascism” mantra is a devilish contrivance – a fabricated enemy that was deliberately created by Zbigniew Brzezinski – deftly cultivated and harvested by the United States for “doctrinal motivation” du jour to enable its own “imperial mobilization” plans for “full spectrum dominance”? That, it is now equally devilishly being supplanted by the new “Russofascism” mantra to deliberately create a new Cold War as path to dismembering Russia, **and we won't simply just turn over and plead “can I please have some more sir”?**

Will Russia have the horse sense to engage the United States on its Achilles heels – officially and publicly charge the United States for the supreme war crime of premeditated invasion on contrived pretexts, occupation, and destruction of Iraq, in the world's courts, and in the UN Security Council where Russia comfortably occupies a permanent perch but has still not figured out how to leverage it in her own best interests? Will Russia have the courage to proclaim 911 as an “inside job” and therefore, assert that the invasion and destruction of Afghanistan has been no different than Hitler using “operation canned goods”? Will Russia exhibit her modern wherewithal by engaging the United States worldwide in an astutely manufactured public relations and legal campaign for culpability, retribution, and restitution along the lines of Nuremberg?

Some or all these steps on multiple simultaneous fronts with no expense spared would be the rational and logical next counter-moves to efficaciously bring-on the genuine **“balance of terror”** on the Grand Chessboard!

The best defense is an offense! Russia under Putin must surely realize that! And so must Zbigniew Brzezinski!

But can judomaster Putin play more imaginatively and skillfully than grandmaster Brzezinski and the entire Anglo-American elite to save Russia? Does he have the courage? That's all it takes – some courage!

## Footnotes

[1] <http://www.telegraph.co.uk/news/worldnews/europe/georgia/2558812/Russia-destroying-military-bases-in-Georgia.html>

[2] <http://uk.news.yahoo.com/skynews/20080815/twl-russians-seize-us-weapons-depot-3fd0ae9.html>

[3] <http://www.reuters.com/article/latestCrisis/idUSL15565899>

[4] <http://www.spiegel.de/international/world/0,1518,druck-572811,00.html>

[5] <http://www.time.com/time/magazine/article/0,9171,921819,00.html>

[6] Video clip of Zbigniew Brzezinski, PBS

[http://sites.google.com/site/humanbeingsfirst/download-pdf/god\\_is\\_on\\_your\\_side.wmv?attredirects=0](http://sites.google.com/site/humanbeingsfirst/download-pdf/god_is_on_your_side.wmv?attredirects=0)

[7] <http://www.globalresearch.ca/articles/BRZ110A.html>

[8] <http://www.time.com/time/world/article/0,8599,1832699,00.html>

[9] <http://humanbeingsfirst.wordpress.com/files/2008/05/the-war-on-terror-2008-omnibus-may112008.pdf>

**Source URL:** <http://print-humanbeingsfirst.blogspot.com/2008/08/georgia-russia-its-a-classic-brzezinski.html>

First Published Part II August 20, 2008



## Appendix B

### From Balance of Terror to Unilateral Terror on the Grand Chessboard!

Douglas J. Feith, Undersecretary of Defense for Policy, in his Hearing before the Senate Armed Services Committee on February 14, 2002 in the aftermath of 911, explaining the rationale for the Department of Defence 2002 Nuclear Posture Review, summarized the overarching reasons for **“new thinking”** by the United States as the unchallenged sole superpower in the following words:

***‘A half a century ago, in the midst of the Cold War, Prime Minister Winston Churchill noted in the House of Commons the “sublime irony” that in the nuclear age, “safety will be the sturdy child of terror and survival the twin brother of annihilation.” The Cold War is long over and new approaches to defense are overdue. As President Bush has stated, “We are no longer divided into armed camps, locked in a careful balance of terror....Our times call for new thinking.”’***

In essence, and as has been empirically evident over the past seven years, what Douglas Feith was arguing before the United States Congress in the euphemistically disguised verbiage of **“new thinking”**, was that the **“careful balance of terror”** must now be replaced by unfettered and uninhibited **unilateral terror!**

As his intellectual mentor Zbigniew Brzezinski had previously argued during the Clinton era in 1997, the goals for American primacy and its geostrategic imperatives had to be to **“perpetuate America’s own dominant position for at least a generation and preferably longer”** such that **“no Eurasian challenger emerges, capable of dominating Eurasia and thus also challenging America”**.

For it was indeed the first time in the history of civilizations and its conquistadors that America had become **“the first, only, and last truly global superpower”**. It was deemed a terrible waste of hegemonic bank balance to not capitalize on it while there was still time to do so, before other nations of the East and Eurasia eventually caught up to America’s lead in about a generation and forced another Détente.

The Project for the New American Century (PNAC), that had seeded the majority of Bush Administration officials beginning in 2000 – from Vice President to Secretary of Defence to a majority of Under Secretaries – too had argued in its report on *Rebuilding America's Defences* that seeking **“full spectrum dominance”** to maintain **“America's preeminence”** and **“American Peace”** in the world by forcing other nations to accept **“America's unique role in preserving and extending an international order friendly to our security, our prosperity, and our principles”**, was a natural American imperative as per the Brzezinski truism **“Hegemony is as old as mankind.”**

And if achieving **“full spectrum”** primacy meant inflicting **“shock and awe”** of unilateral terror on contrived mobilizing pretexts, so be it – as which nation could now stand in the path of the mighty **'hectoring hegemons'**?

But there was indeed an impediment to the realization of this **“new thinking”**, and to the enormous increase in the defence budget needed to support it, as explained by Zbigniew Brzezinski. It was the darn **“populist democracy”** of the sole superpower!

Fighting in far-away lands is quite **“uncongenial to democratic instincts”** noted Brzezinski, as the **“economic self-denial (that is defense spending), and the human sacrifice (casualties even among professional soldiers) required in the effort”** makes **“democracy ... inimical to imperial mobilization.”**

Therefore, a commensurate lifetime of **“War on Terrorism”** was architected against a well formulated never-ending enemy – the **“islamofascists”** – in a Machiavellianly seeded doctrine of the **“Clash of Civilizations”**. Bernard Lewis had artfully constructed that bit of magic in *Foreign Affairs* magazine in 1990 as the **“irrational ... roots of Muslim rage ... [which] is no less than a clash of civilizations”**. In the aftermath of 9/11/2001, it became the self-fulfilling policy of the overtly exuded foreign policy calculus of the United States, and was continually replenished by more priceless doctrinal state-craft from the mighty pen of Bernard Lewis, like **'Crisis of Islam – Holy War and Unholy Terror'**! And of course, the doctrinal flames are still fanned periodically by the various circus clowns of empire, like the printing of offensive cartoons by a confrere of Daniel Pipes. It egregiously insulted the Prophet of Islam to further stimulate a reaction among the Muslims that could only be classified as **“[not even] a Clash of Civilizations [but a] Clash between the Civilized World and Barbarians”**.

In order to get the ball rolling ab initio, to both seed the **“military transformation”** necessary to capitalize on America being **“the first, only, and last truly global superpower”**, and to embark on the **“American peace”** mission that called for **“new thinking”** of forcing other

nations to accept “*America's unique role*”, the “*populist democracy*” needed a shocker: a “***catastrophic and catalyzing event – like a new Pearl Harbor***”.

Well, 911 was that “***new Pearl Harbor***”!

Whether 19 “*islamofascist*” jihadis on their flying carpets controlled by a mind-melding yoda master sitting on his bare rump armed with laptops and cell phones in a cave in the Hindu-Kush did it, or whether it was an expertly orchestrated, precision planned and executed controlled demolition, is a moot point. For it was an 'operation canned goods' all the way in terms of providing the enabling pretext for “*imperial mobilization*” on the proverbial screen of Plato's ***Mythical Cave***! Whoever did it was, and still is, a resourceful confrere and great benefactor of the conquistadors!

But that shocking event in itself could have easily been still-born, as it could have just as easily been dealt with as a great crime and not a cause célèbre for massive invasion of other nations. The crime scene could have been secured and a forensic analysis of the evidence performed to understand how did three tall towers miraculously collapse within the span of a few hours in a single day into exactly their own footprints at almost free-fall speed.

Zbigniew Brzezinski had astutely observed of this “*populist democracy*”, that:

***“as America becomes an increasingly multicultural society, it may find it more difficult to fashion a consensus on foreign policy issues, except in the circumstance of a truly massive and widely perceived direct external threat. .... More generally, cultural change in America may also be uncongenial to the sustained exercise abroad of genuinely imperial power. That exercise requires a high degree of doctrinal motivation, intellectual commitment, and patriotic gratification.”***

Yes indeed, along with 911, the secret sauce to the recipe, so to speak, was, and still continues to be, “***a high degree of doctrinal motivation, intellectual commitment, and patriotic gratification***”!

In other words, without fully conditioned '***Prisoners of the Cave***', no amount of pyrotechnics would have worked because a free public and its democratic institutions, the law makers in Congress and the influential newsmedia, could have easily demanded a forensic analysis of the crime scene rather than trivially acquiesce to a rush to passing oppressive domestic laws like the Patriot Acts without any discussion and hasty recourse to

*“Infinite Justice”* with even less evidence.

The United States public had to be so dexterously primed with the multi-faceted mantras crafted of the *“sudden threat or challenge to the public's sense of domestic well-being”*, that today, seven years later, its successes can be measured all the way to several Nobel Prizes in Profound Political Machinations (**PPM** – if such an accolade for hegemonic conquest was to be split off from the Nobel Peace Prize). The latest evidence for such a prize accumulating to the Bush Administration in spades is in the public survey by Gallup Poll released on March 31, 2008, which states: *“Iran topped the list, with 25 percent naming it when asked which country is the greatest U.S. enemy,”*. And most Americans, the vast majority, and certainly most of the 25 percent in the above survey, have likely never met an Iranian person, or anyone from any of the exotic regions from where the ubiquitous boogiemens are being fashioned!

This criminal priming of the *“populist democracy”* now naturally enables ***“the first, only, and last truly global superpower”*** to be fully ***“autocratic abroad”*** in its unlimited ***“capacity for military intimidation”***. Note how Brzezinski concludes the primacy aspirations of the truly global superpower:

***“Geostrategic success in that cause would represent a fitting legacy of America's role as the first, only, and last truly global superpower.”***

And it is precisely in that overarching *“Geostrategic ... cause”*, that Iran and Pakistan are today imminently staged on the nuclear chopping block to seed the *“Geostrategic success”*, while some American city is made expendable to create the next ***“catalyzing event”*** for continuing *“imperial mobilization”* that ***“will make Sept. 11 pale by comparison”***.

All conveniently enabled by the continued Orwellian use of the fiction of 'Bin Laden' and its various surrogates including 'Al Qaeda'. If these stick-wielding cave-dwelling antediluvians possess such awesome powers as to bring down the sole superpower and its Western allies to their knees forcing the leader to spend 3.1 trillion dollars next year a majority of it on defense, and the Western peoples to also lose all their democratic freedoms and civil liberties to end up living in police-states, then the 'Bin Laden' mantra is surely more powerful than the USSR! Or at least, it makes a wonderful 'Ali Baba' bedtime story.

So participate in the story telling of 'Ali Baba' all you want dear Pakistanis – because the endgame of Pakistan's ruling elite in their **fictional of “war on terror”** appears to be the same as the hectoring hegemon! As the latter destroys the United States to craft a borderless New World Order laying many a million victims in its path, the new amorphous

empire's gratitude await many a servile clients and native informants for services rendered!  
Or perhaps the hangman's noose!

Indeed, this **“new thinking”**, it turns out, isn't terribly new after all. It was discovered, for those still in possession of memory, to already have been defined as the **“supreme international crime”** at the Nuremberg Military Tribunals by the United States' own Chief Prosecutor, Justice Robert H. Jackson. A crime so stupendous and monumental **“differing only from other war crimes in that it contains within itself the accumulated evil of the whole”**, that the Nazi war machine was held responsible for **“all the evil that follows”** in the aftermath of the first primal aggression! The Nazis had invaded Poland on the heels of their own *Operation Canned Goods* too, in the pretext of 'self-defense' against 'terrorists'! And in handing their leadership death sentences, the American Chief Prosecutor had asserted:

***“If certain acts of violation of treaties are crimes, they are crimes whether the United States does them or whether Germany does them, and we are not prepared to lay down a rule of criminal conduct against others which we would not be willing to have invoked against us.”***

And that, as they say, is all there is to this **“new thinking”**. It isn't exactly clear why the Americans and much of the world appear so confused about something so palpably obvious.

Indeed, this unilateral terror ideology of **“new thinking”** was even aptly summed up by Vladimir Putin, President of Russia, in these laconic but penetrating words in an unusual moment of candor in 2007:

***“what is a unipolar world? However one might embellish this term, at the end of the day it refers to one type of situation, namely one centre of authority, one centre of force, one centre of decision-making. It is world in which there is one master, one sovereign. And at the end of the day this is pernicious not only for all those within this system, but also for the sovereign itself because it destroys itself from within.”***

Yes sir, give us ordinary peoples – those who are continually made to suffer this **“new thinking”** – the **“sublime irony”** of being **“locked in a careful balance of terror”** any day!

And that, is also the only rational way out from crossing the nuclear Rubicon!

Unless Russia and China get their act together, unless Pakistan wakes up from its suicidal slumber, and they unite to safeguard the Asian portion of Eurasia in a mutual defense treaty similar to NATO, nuclear holocaust awaits the 'lesser' humanity. Perhaps this is how population reduction is ultimately planned amidst orchestrated food shortages as per some secret clauses that haven't yet been declassified in NSSM 200 and NSDM 314 (or in some other undisclosed National Security Strategy calculus derivatives).

If these resource and population rich Asian nations don't band together now like the EU is banding together into a unified federation of Europe with common laws and common security, and like the North American Union that is clandestinely transpiring under the Security and Prosperity Partnership (SPP), after the nuclear genie is unleashed and the United States is under martial law, the barbarians will be knocking at each of the other doors one after another – for total perpetual war is the blatantly obvious global agenda to “*birth-pang*” the New World Order out of the ashes of humanity!

**Source URL:** <http://print-humanbeingsfirst.blogspot.com/2008/04/balanceof-terror-tounilateral-terror.html>

First Published April 26, 2008

## Appendix C

### Iran, the Associated Press, and Covert-War of 'Imperial Mobilization'

#### The synthesis and propagation of 'doctrinal motivation' for 'war on terror'

#### Letter to Editor: Iran, the Associated Press, and Covert-War of 'Imperial Mobilization'

April 13, 2008.

In the Associated Press wire story of [April 12, 2008 \(cached\)](#) dispatched from Shiraz, Iran by AP writer Ali Akbar Dareini, headlined "[Bomb Kills 9 at Mosque in Southern Iran](#)" and echoed across the United States from [Fredericksburg](#) to [Oregon](#) and on all the internet news reflectors from [AOL](#) to [Yahoo](#) reaching throughout the globe, and subsequently, within a few hours, on [April 13, 2008](#), re-titled "[Iran dismisses sabotage in mosque blast](#)" by another AP writer Nasser Karimi, there is a crucial omission in both that will be entirely lost in the memoryless United States of America unless specifically pointed out.

The first AP report of the bomb explosion, after describing the fast breaking event, editorialized as follows to supposedly give a larger overarching context to the reader:

*'Bombings are unusual in Shiraz, a major draw for foreign tourists who come to see the ruins of nearby Persepolis, an ancient Persian kingdom that was a center for ceremonies and worship. No one claimed responsibility for the attack.'*

*Iran has faced several ethnic and religious insurgencies that have been behind rare but deadly attacks in recent years — though none have amounted to a serious threat to the government.*

*In February 2007, a car loaded with explosives blew up near a bus carrying members of Iran's Revolutionary Guard, killing 11 of them and wounding more than 30 in southeastern Iran. A Sunni militant group that has been blamed for past attacks on Iranian troops claimed responsibility.*

*Some believe the group, known as Jundallah, is linked to al-Qaida. Jundallah, or God's Brigade, has waged a low-level insurgency in southeastern Iran.*

*Besides the violence in the southeast, ethnic Arab Sunni militants have been blamed for bombings in the western city of Ahvaz near the border of Iraq — including blasts in 2006 that killed nine people. ...*

*The fundamentalist Wahabi strain of Islam considers Shiites heretics and Iran is dominated by Shiite Muslims. Wahabis are suspected of having influence over some militants waging the insurgency in Iraq'*

Please note that it appears quite comprehensive in its gamut – pretty much accounting for everything, from “insurgency” to “fundamentalism” to “terrorism” to “Jundallah” to the Muslim on Muslim violence bred from “radical Islamism” (although that last semantically loaded terminology is itself not employed). One might say it is as comprehensive in its attempt to capture the significant and essential contexts in a quick birds eye view as is possible in the limited word-space of urgent fast-breaking wire news. So what's the crucial omission?

Before analyzing this further, just for completeness, the second AP report of today, which mainly only offered the latest update on the calamity without editorializing any additional contexts, noted the following:

*'Iranian officials on Sunday ruled out an attack as the cause of an explosion that killed 11 people inside a mosque in the southern city of Shiraz. ... The police chief of the southern Fars Province, Gen. Ali Moayyedi, said he "rejects" the possibility of an intentional bombing and "any sort of insurgency" in the blast. ... Iranian Foreign Ministry spokesman Mohammad Ali Hosseini said Sunday that no group has claimed responsibility for the explosion.'*

Since this only transpired less than 24-hours ago, more is sure to be reported. The subject here is only the editorializing in the first AP report and what's missing in it.

While constructing a comprehensive forensic analysis and rational solution-space for the urgent problem of the apparent full spectrum destabilization of Pakistan at the time of Benazir Bhutto's grotesque assassination that was being blamed upon the ubiquitous 'Al Qaeeda', Project Humanbeingsfirst had compiled the following short-list of news reports on what was publicly known at the time about the systematic destabilization of its next-door



neighbor, the equally beleaguered Iran.

In the context of the 'trumpeting elephant in the bedroom' omission in the AP news report quoted above, it appears useful to rehearse a few sentences each from that short-list here.

**Jundallah and American covert-ops inside Iran, as publicly reported; a snapshot:**

**September 18, 2006 'We Are Conducting Military Operations Inside Iran Right Now. The Evidence Is Overwhelming'** CNN report with Air Force Col. Sam Gardiner (Ret.)

*'Gardiner: It's been given. In fact, we've probably been executing military operations inside Iran for at least 18 months. The evidence is overwhelming'*

**March 8, 2007 CIA funds terrorist operations against Iran**

*'Responsibility for the attack was claimed by Jundallah (Party of God), a Pakistan-based Baluchi separatist group. ...*

***The February 26 London Sunday Telegraph reported: "America is secretly funding militant ethnic separatist groups in Iran ... The operations are controversial because they involve dealing with movements that resort to terrorist methods in pursuit of their grievances against the Iranian regime ...***

*"Funding for their separatist causes comes directly from the CIA's classified budget but is now 'no great secret', according to one former high-ranking CIA official in Washington who spoke anonymously to the Sunday Telegraph.*

*"His claims were backed by Fred Burton, a former US state department counter-terrorism agent, who said: 'The latest attacks inside Iran fall in line with US efforts to supply and train Iran's ethnic minorities to destabilise the Iranian regime.' ...*

*In an article in the Washington Quarterly magazine's first issue for 2007, John Bradley, the former managing editor of the Saudi Arabia-based Arab News, wrote that Baluchistan province is "particularly crucial for Iran's national security as it borders Sunni Pakistan and US-occupied Afghanistan ... In fact, the Sunni Balochi resistance could prove valuable to Western intelligence agencies with an interest in destabilizing the hardline regime in Tehran ...*

***“The Pentagon”, Bradely wrote, “is especially interested in whether Iran is prone to a violent fragmentation along the same kinds of faultlines that are splitting Iraq and that helped to tear apart the Soviet Union with the collapse of communism.”***

**March 25, 2007 Subverting Iran Washington’s Covert War inside Iran**

*'Much attention has been given to the Bush Administration’s preparations for possible war against Iran as well as its drive to impose sanctions. Meanwhile, a less noticed policy has been unfolding, one that may in time prove to have grave consequences for the region. **There is a covert war underway in Iran, still in its infancy, but with disturbing signs of impending escalation.** In the shadowy world of guerrilla operations, the full extent of involvement by the Bush Administration has yet to be revealed, but enough is known to paint a disturbing picture.'*

**April 03, 2007 ABC News Exclusive: The Secret War Against Iran**

***'A Pakistani tribal militant group responsible for a series of deadly guerrilla raids inside Iran has been secretly encouraged and advised by American officials since 2005, U.S. and Pakistani intelligence sources tell ABC News.***

*The group, called Jundullah, is made up of members of the Baluchi tribe and operates out of the Baluchistan province in Pakistan, just across the border from Iran.*

*It has taken responsibility for the deaths and kidnappings of more than a dozen Iranian soldiers and officials.'*

**April 04. 2007 CIA hires terrorist group to operate inside Iran**

***'New York, April 4, IRNA - Central Intelligence Agency (CIA) has hired a Pakistani terrorist group that has carried out a series of deadly terrorist attacks inside Iran, ABC News has reported on Wednesday.***

*The group, members of the Baluchi tribe, operates from Pakistan's province of Baluchistan, just across the border from Iran.*

*ABC cited US government sources it did not identify as saying the US has maintained close ties to its leader, Abdel-Malik Regi, since 2005.*

***The group, called Jundullah, has carried out raids, resulting in the deaths or kidnapping of Iranian ordinary people as well as soldiers and officials.'***

**April 05, 2007 US backing 'secret war' against Iran?**

*'An analysis by Strafor, a global intelligence consulting firm based in Texas, noting that Jundullah has stepped up its attacks recently, says that the US could be using Jundullah as a "poking device" against Iran.*

*U.S. support for Jundallah fits into the larger picture of U.S.-Iranian negotiations over Iraq. Iran has made painfully clear that it has -- and can use -- a variety of militant assets throughout the region to pressure Washington to meet its demands in Iraq. At the same time, the United States has an interest in demonstrating that it has friends among Iran's minority groups to gather intelligence, stir up public unrest and distract the clerical regime from its Iraqi agenda.'*

**April 10, 2007 Active CIA Terrorist Cells operate inside Iran**

*'The past year witnessed a series of attacks targeting ethnic minority border areas of Iran. Relentless violence, including bombing and assassination campaigns against soldiers and government officials, resulted in a chaotic situation in the country that left a negative impact on the image of the current government. **Aid to separatists and radical groups comes directly from the CIA's classified budget but is now no great secret.'***

**April 2007 Through the Veil: The Role of Broadcasting in U.S. Public Diplomacy toward Iranians**

*'From widespread mistranslation on the State Department's Persian website to terrorists appearing on Voice of America as "political activists," these flaws are keeping U.S. government broadcasting from effectively reaching the Iranian people.'*

**May 23, 2007 Bush Authorizes New Covert Action against Iran**

*'A report broadcast on Iranian TV last Sunday said Iranian authorities had captured 10 men crossing the border with \$500,000 in cash along with "maps of sensitive areas" and "modern spy equipment." A senior Pakistani official told ABCNews.com the 10 men were members of Jundullah. **The leader of the Jundullah group,***

**according to the Pakistani official, has been recruiting and training “hundreds of men” for “unspecified missions” across the border in Iran.'**

**May 24, 2007 More Bad Intelligence on Iran and Iraq**

*'Time magazine: Both cases show how the Administration is still trying to manipulate intelligence to further its strategic goals. ABC says that Deputy National Security Advisor Elliot Abrams is behind the covert action against Iran.'*

**June 10, 2007 Iran protests over US ‘spy networks’**

*'TEHRAN, June 9: Iran has handed an official protest to the United Nations accusing the United States of supporting a militant group and creating spy networks inside the country, media reported on Saturday. The protest, addressed to UN Secretary General Ban Ki-moon, accuses the United States of supporting Jundallah, an outlawed armed group blamed for deadly attacks in Iran's southeastern Sistan-Baluchestan province.'*

**July 09, 2007 U.S. Support for the Iranian Opposition**

*'Some reports indicate that U.S. financial support is in fact aimed at regime change and goes beyond the allocated \$75 million. In May, ABC News reported that the CIA had hired Jundallah, a Pakistan-backed Baluchi group, to carry out sabotage operations inside Iran. (Later, ABC reported that President Bush had in fact authorized a covert CIA program against the regime.) ... In addition to public and covert funding of Iranian opposition groups, the United States also supports individual dissidents through various means.'*

**July 11, 2007 Will the real Al Qaeda please step forward?**

*'ABC News (US) reports that the Americans claim they are not providing direct funding to Jundallah (although they admit its leadership has met regularly with US officials), but that they find the alliance convenient for various reasons:*

*A senior U.S. government official said groups such as Jundallah have been helpful in tracking al Qaeda figures and that it was appropriate for the U.S. to deal with such groups in that context. **Some former CIA officers [however] say the arrangement is reminiscent of how the U.S. government used proxy armies, funded by other countries including Saudi Arabia, to destabilize***

*the government of Nicaragua in the 1980s.'*

July 24, 2007 The NYT, Doing What It Does Best: "Covering" War

***"Eleven members of the Revolutionary Guards have been killed in clashes with drug smugglers in southeast Iran near the border with Pakistan . . . Nine others were wounded. The clashes occurred Thursday in a mountainous area in southeastern Sistan and Baluchestan Province after drug smugglers ambushed a group of Revolutionary Guards . . . The drug smugglers left without casualties, the [Fars News Agency] said."***

As should be rather self-evident from this snapshot that spans almost a year worth of mainstream news reporting, the reality when 'Alice' is wide awake is quite otherwise from that projected by the Associated Press correspondent from the 'unbirthday party' table. This coverage of the 'Mad Hatter's' rampage is also consistent with the last of the afore-cited items from the New York Times. The latter further refined the wonderful tale at the 'unbirthday party' to additionally include *"drug smugglers"*, who, phantasmically enough, have the fire-power to overwhelm and kill eleven members of an Armed Forces service without suffering any casualties. How the Fars News Agency knew they were *"drug smugglers"*, since all *"left without casualties"*, is of course irrelevant to when 'Alice' is awake.

The obvious journalistic point to make here is that such a profoundly blatant omission of the most significant context, 'the highest order bit' so to speak, of the 'empire' itself secretly cultivating the 'pirates' in order to continually wage a war of aggression upon other nations through various superpower instruments of coercion, is an excellent example of manufacturing consent in the West for its global "War on Terror" against all shades of 'Islamist terrorists' as being real and un-fabricated.

The un-subtle purpose is to continually lend substance, at every opportunity, to the *"doctrinal motivation and intellectual commitment"* du jour being employed for *"imperial mobilization"*.

The ubiquitous Associated Press wire-news service which seeds most of the world's news headlines, is dutifully playing its instrumental role in this process of aiding and abetting in perpetuating doctrinal mythologies. With of course, help in no small measure, from the apparent endless supply of 'native informants' on AP's worldwide payrolls. (Refer back to the Mighty Wurlitzer, Chapter 2 in this book)

In the AP report under scrutiny, all immanent possibilities and speculations except of

course the grotesquely real one, were surveyed by the “knowledgeable” AP writer to ostensibly provide a useful overarching context for the hideous bomb explosion that killed 9 innocent civilians and injured over 100 others inside the very sanctity of their own place of worship.

How horrible – who could have possibly done it?

Only the 'radical Islamists' of course, fighting among themselves like barbarians! Since it has indeed been positively shocking how **“so many people in the West still don't believe that they are at war [with] .. radical Islam”**, as America's favored son Daniel Pipes had lamented. Perhaps now, the indifferent West, and especially the American public, will believe that indeed, it's **“not a Clash of Civilizations, It's a Clash between the Civilized World and Barbarians”!**

Thank you.

Zahir Ebrahim

[Project Humanbeingsfirst.org](http://ProjectHumanbeingsfirst.org)

**Source URL:** <http://print-humanbeingsfirst.blogspot.com/2008/04/ap-covertwar-imperial-mobilization.html>

First Published April 13, 2008

## Chapter 33 Case Study: Why is the Holy Qur'an so easy to Hijack?

### Part-I

[ Tuesday, August 02, 2011, 2nd day of Ramadan in the United States, Muslim year 1432 ] Despite a slight throbbing headache due to abstinence from my usual cups of morning tea on my second day of fasting, I feel motivated to address an observation made by a fellow Muslim at an *Iftar* dinner in a Pakistani restaurant in Islamabad many years ago. In the past few years I have spent many a Ramadan in Pakistan and often visited the same restaurant for breaking the fast with a lavish buffet meal. Servicing a mere day's hunger from self-imposed deprivation can be a sight to behold. Any sensible person watching privileged Muslims feast at *Iftar* with perfunctory courtesy to Islam would surely wonder about our religion. Thank goodness non-Muslims don't approach Islam by looking at the behavior of us gluttonous Muslims, but rather, by approaching the Holy Qur'an directly. And that's the topic of this column – understanding Islam directly from its singular source, the Holy Qur'an.

The good fellow who was one of the restaurant managers and was pursuing part-time studies in Arabic, sometimes would sit with me for a cup of tea. As I vividly recall, on one of these visits for a hearty meal, he had asked me a rhetorical question to which I had partly replied in some seriousness with reference to the Holy Qur'an. My interlocutor's immediate riposte to me was something like this:

“don't quote me the Qur'an; everyone quotes their favorite verses to justify their own narrow positions; the shias quote it, the sunnis quote it, the wahabis quote it, the barelvis quote it, the deobandis quote it, the qadianis quote it, and yet they all have slightly different understanding of the same Holy Qur'an and each would rather die for that difference than relent in their view.”

Indeed, as many Muslims who have read the Holy Qur'an are aware, anyone can pretty much find at least some justification for any agenda, any belief, and mainly the one into which one is socialized at birth, in that most unusual Book.

It is an empirical fact that that's how Muslims become divided into sectarianism. Not by

rationalism, logic or investigation, but by the fact of being born into a Muslim home and adopting the dominant theology and practices of the sect to which the parents belong – whether or not they be practicing Muslims. Often times, the de facto socialization parameters are determined by the dominant sect of the culture, nation, or civilization where one is raised. This is why the majority of Muslims in the world are classified in general terms as sunnis – the dominant sect among the Muslims. This is also why a Saudi Muslim is different from an Iranian Muslim, for example. Neither chooses their sectarian version of Islam – each is born into it. But each claims to be the sole custodian of Islam's true interpretation. As the dominant mainstream, the sunnis don't consider themselves to be a “sect” by the fact of being the majority. Only the other minority is a “sect”. Every minority of course think the majority is usually wrong pointing to how it killed Socrates. Some ask: is the religion of Islam a “democracy” – that fifty one percent of the people who are born into it define what Islam and its Book must mean for the rest of the forty nine percent? Isn't that also called mob rule – where majority ignorance rules? Should one follow the majority just because they are a majority irrespective of the merit of their position? And what objective merit is that when every group, big and small, sees maximum merit only in their own socialized interpretation of Islam?

The vast majority of the 1.6 billion Muslims worldwide are directly socialized into our sectarian beliefs from birth. As adults, our understanding of the religion of Islam is thence derived almost exclusively from our birth-sect's dominant worldviews. Our respective beliefs are further strengthened when we see our sect's *ullema* (Muslim religious scholars) most eloquently argue their respective theological *raison d'être* for differing with that other sect's mumbo jumbo directly from the Holy Qur'an, and from other secondary and tertiary books of their own sect. That fact of socialization applies recursively to all scholars and compilers of antiquity as well. The bulk of their writings constituting the secondary and tertiary sources of information for subsequent generations of Muslim scholarship. Each group or sect naturally selecting the narrow views of their respective socialization to promulgate forward to the next generation in a classic example of a crippled epistemology which incestuously feeds upon itself.

This is quite empirical. Pick up any book of antiquity, from tafseer to hadith compilation to history, and one will see the clear separation of shia vs. sunni dichotomy run through them. Examine the background of the authors and they invariably exactly fall along that same boundary. A very peculiar state of affairs which is inexplicable, since all sects claim to have the same exact text of the Holy Qur'an, unless one begins to understand the power and influence of incestuous socialization in Muslim scholarship. Few escape it. And this fact is evidenced by the straightforward observation that socialized masses and scholars alike, don't account for their own socialization in their self-righteous proclamations entirely rooted



in the superiority complex of their respective inheritance.

**Is the religion of the masses therefore, practically speaking, merely reduced to an inheritance?**

The Author of the Holy Qur'an vociferously decries that notion of following in the footsteps of one's forefathers, unequivocally warning not to follow the religion of one's ancestors just because one is born into that religion. Surah Al-Baqara is replete with that theme. E.g.,

*“This is a people that have passed away; they shall have what they earned and you shall have what you earn, and you shall not be called upon to answer for what they did.” (2:141); and “(On the day) when those who were followed disown those who followed (them), and they behold the doom, and all their aims collapse with them. And those who were but followers will say: If a return were possible for us, we would disown them even as they have disowned us. Thus will Allah show them their own deeds as anguish for them, and they will not emerge from the Fire.” (Surah Al-Baqara, 2:166-167)*

The Holy Qur'an repeatedly invites individual reflection of every human being in the matters of beliefs instead of merely inheriting the beliefs from one's forefathers, as in Surah Al An'aam:

*“So when the night over-shadowed him, he saw a star; said he: Is this my Lord? So when it set, he said: I do not love the setting ones. Then when he saw the moon rising, he said: Is this my Lord? So when it set, he said: If my Lord had not guided me I should certainly be of the erring people. Then when he saw the sun rising, he said: Is this my Lord? Is this the greatest? So when it set, he said: O my people! surely I am clear of what you set up (with Allah). Surely I have turned myself, being upright, wholly to Him Who originated the heavens and the earth, and I am not of the polytheists.” (Surah Al An'aam, 6:76-79)*

The Holy Qur'an enjoins such reflection even while also accepting socialization as an empirical fact among mankind. The Author of the Holy Qur'an Itself proclaims that It created mankind in tribes and nations:

*“O mankind! Lo! We have created you from male and female, and have made you nations and tribes that ye may know one another. Lo! the noblest of you, in the sight of Allah, is the best in conduct. Lo! Allah is Knower, Aware.” (Surah Al-Hujraat, 49:13).*

And that:

*“If Allah had so willed, He would have made you a single people”* (Surah Al-Maeda, 5:48)

The Holy Qur'an therefore rationally countenances socialization for those pursuing their respective beliefs other than Islam, despite the Holy Qur'an oft stating that Islam supplants them all as the final Revelation in a tamper-proof package:

*“In a Book well-guarded, Which none shall touch but those who are clean.”*  
(Surah Al-Waqia, 56:78-79)

See the examination of Surah Al-Fatiha and Surah Al-Maeda in [Islam and Knowledge vs. Socialization](#) for the consequent principles of pluralism for virtuous conduct regardless of beliefs inherent in the message of the Holy Qur'an which unequivocally avers:

*“There is no compulsion in religion.”* (Holy Qur'an, Surah Al-Baqara, 2:256)

While accepting socialization as a fact, the Qur'anic recipe to circumvent socialization as a means for independent evaluation of beliefs, is to approach the Holy Qur'an with a *cleansed heart*. (Ibid.) But one still observes all the *cleansed hearts* throughout the ages still pretty much fall along the same sectarian demarcation among the Muslims. Why does the *cleansed heart* recipe evidently fail when it comes to sectarianism for the topics which divide the Muslims? Perhaps the hearts aren't *cleansed* enough? That platitudinous metaphor for bringing utmost earnestness when seeking a rational as well as spiritual understanding of the Holy Qur'an, not bringing preconceptions and prejudices to its study and reflection, doesn't really lend any additional insight into the subject of why even the most earnest seekers of truth come away understanding the Holy Book pretty much along the axis of their socialization. Focusing on the heart is a dead-end as far as further intellectual inquiry is concerned.

Therefore, the question naturally arises, that if it is empirically observed that everyone finds their own self-serving justifications to validate their respective socialization in the Holy Qur'an, how is one to study the Holy Qur'an objectively, independent of one's own socialization, in order to learn and comprehend what its own Author wanted to convey in that most revered Book of the Muslims?

**How are we to prevent the hijacking of the Holy Qur'an from a self-serving understanding of it for our own selves?**

Before one can even begin to perceptively answer that crucial question, commonsense suggests that one has to first diagnose and dissect the problem more precisely.

Therefore, we begin by formulating the problem in this way:

**What are the inherent impediments for studying the message of the Holy Qur'an which make the Book so amenable to self-serving interpretation, socialization, and even bastardization by anyone?**

Just to briefly footnote the usage of the latter villainous word, **bastardization**, it is no secret that today, its harbingers include the most notable Western propagandists. E.g., Bernard Lewis of Princeton University who skillfully crafted the mantra of 'Clash of Civilizations' and subsequently wrote the thesis "Crisis of Islam – Holy War and Unholy Terror"; and Dr. Zbigniew Brzezinski who easily gave to the USSR its Vietnam War in Afghanistan in Muslim blood with nothing more profound than a simple retake on the German Third Reich's battle cry *Gott mins uns (God be with us): "God is on your side"*.

"In 1990 Bernard Lewis, a leading Western scholar of Islam, analyzed 'The Roots of Muslim Rage,' and concluded: 'It should now be clear that we are facing a mood and a movement far transcending the level of issues and policies and the governments that pursue them. This is no less than a clash of civilizations – that perhaps irrational but surely historic reaction of an ancient rival against our Judeo-Christian heritage, our secular present, and the worldwide expansion of both. It is crucially important that we on our side should not be provoked into an equally historic but also equally irrational reaction against our rival.'" (Samuel Huntington in *The Clash of Civilizations and the Remaking of World Order*, page 213)

That supposed "Muslim Rage" of 1990 was turned into the egregiously titled full blown propaganda treatise *The Clash of Civilizations* by Bernard Lewis' Zionist-imperialist confrere at Harvard University, Samuel Huntington, in 1995:

"The underlying problem for the West is not Islamic fundamentalism. It is Islam, a different civilization whose people are convinced of the superiority of their culture and are obsessed with the inferiority of their power. The problem for Islam is not the CIA or the US Department of Defense. It is the West, a different civilization whose people are convinced of the universality of their culture and believe that their superior, if declining, power imposes on them the obligation to extend that culture throughout the world. These are

the basic ingredient that fuel conflict between Islam and the West.” (Ibid. pages 217-218)

And Huntington's myth crafting of 1995 was turned into the perpetual “War on Terrorism” on September 11, 2001 by the Zionist-imperialists' errand boy, George W. Bush Jr., the President of the United States, with **“either you are with us, or with the terrorists”!**

Moreover, today, both “militant Islam” and “moderate Islam”, the Hegelian Dialectic to continually advance and sustain the cause of empire's “War on Terror” as a *“self-fulfilling prophecy”*, draw justifications from the Holy Qur'an. One for Holy War, the other for Holy Peace. Each side has its partisans among the public because each side easily sees the correctness of their own position – it is, after all, (selectively) rooted in the Holy Qur'an they each claim. See Response to the Fatwa on Terrorism in the Service of Empire.

However, mechanisms for the **bastardization** of a religion is not the focus of this analysis. See Islam and Knowledge vs. Socialization, Islam vs. Secular Humanism and World Government, and Case Study in Mantra Creation for these details. (Chapters 10, 9, 18, and 2 respectively.) The political novel (or historical fiction – the only fair way to characterize it) “Memoirs Of Mr. Hempher, The British Spy To The Middle East” is further revealing of how the hijacking of the religion of Islam can be so diabolically engineered by planting and cultivating stooges for cognitive infiltration into the religion via a subversive sect creation in the 18th century. In PART SIX of the novel, key insightful observations are made about the religion of Islam and the Muslim psyche which, regardless of who authored them – whether as historical fiction or a real handbook of subverting Islam – are empirically visible even today. Empiricism lends direct credence to the description of the Machiavellian methods of subversion of the religion of Islam in that political treatise (read pertinent excerpt) irrespective of who is its author or what literary device is employed to convey the malignant thesis.

Just as “Philip Dru Administrator : a Story of Tomorrow 1920 - 1935”, by Edward Mandell House, depicts in a fictional narrative, the first principles used for the author's own Trojan Horse role in controlling President Woodrow Wilson's presidency (1912-1920) as a puppet on behalf of oligarchic powers behind the scenes. First principles which one can observe being practiced for all American presidencies ever since, including today for President Obama's puppet presidency. Just as empiricism also lends incontrovertible weight to the Machiavellian methods in the Protocols of the Elders of Zion regardless of who wrote that malignant treatise whose effects in the world today are plainly visible as if blueprinted directly from that villainous recipe book of subversion. All these political treatises in varying forms are akin to the political novel *The Prince* by Machiavelli, written in the 16th century

which still forms the guide-book for modern statecraft, and that is the heart of the matter – the principles of subversion espoused in them. Just as Machiavelli is read and followed in statecraft, so are any recipe books which permit subverting the enemy, including the 2500 years old Chinese treatise of Sun Tzu, *The Art of War* (read all these [works](#)).

And lastly, in that same vein of subversion of a lofty religion for seeding havoc among its followers, the two articles [Egypt and Tunisia – The 'arc of crisis' being radicalized!](#) and [Unlayering the Middle East War Agenda: Making Sense of Absurdities](#), delve into the more recent cultivation of the shia Iranian Revolution of yesteryear to connect with the present “revolutions” suddenly erupting in the Middle East against the same tyrannical rulers who were previously aided and abetted to remain in power over their peoples just like Saddam Hussein of Iraq. Its juxtaposition to the cultivation of the sunni “Mujahideens” in Afghanistan at exactly the same time period, both of them to fertilize the “*arc of crisis*” with bipartisan Muslim blood, is frightening testimony of the persistence of vulnerable fracture points among the followers of Islam which are perennially ripe for harvesting.

The Muslim fratricide of Iran-Iraq war was only made possible by deftly employing the age old historical schisms of shia-vs-sunni, arming both sides and contriving the fratricide in untold millions. That contrivance is a textbook example of *game theory* being put into practice for a global agenda. The effects of fertilizing the “*arc of crisis*” in Muslim blood predictively percolated into enabling other premeditated global events, ultimately setting into motion the creation of a New World Order – of one world government. Read the aforementioned two articles to fathom the self-serving Cassandra-like predictions made by Zbigniew Brzezinski right after lighting that fuse to what he prophetically (sic!) called the “*arc of crisis*”. A fuller understanding of that epoch of the latter half of the twentieth century minimally requires a book-length read which perceptively re-links the seemingly disparate and often unlinked antecedent and subsequent events, wars, collapses, revolutions of the past century, melding directly into the searing event of the New Pearl Harbor on September 11, 2001. See a précis in [Of Ostriches and Rebels on The Hard Road to World Order](#).

With the preceding bird's eye view of the age old villainous methods of subversion and harvesting of the religion of Islam from within, the focus in this article is exclusively on the natural impediments to the earnest study of the Holy Qur'an by a genuine seeker of its knowledge who willingly comes to the Book with an intent to learn its contents.

So now you open the Holy Qur'an to read, reflect, and study, with a *cleansed heart*, Muslim or non-Muslim, native Arabic speaker or reading many translations in your own language alongside. Common impediments now make the study of the Holy Qur'an uncongenial to the ordered mind. Let's dissect that uncongeniality with a surgeon's scalpel. The result is

not as obvious as it might first appear.

## II

Let's begin with a thought experiment. Imagine Mr. Spock from Star Trek curiously picking up the Holy Qur'an to examine its fascinating contents. What will he find?

For those unfamiliar with Mr. Spock, he is a fictional character in a science fiction television series of the 1960s. Spock is a completely logical being. He exhibits no human characteristics of subjectivity and emotionalism. He has no intuition, no imagination, and no inspiration. He makes rational analysis of any matter based solely on available facts and data. He draws linkages, makes inferences and deduction, theorizes and opines, based solely on factual logic and not on intuition or other un-quantifiable human notions of *tea-leaves* reading, sixth sense, gut feel, love, hate, etc., all of which transcend rational logic. Therefore, Mr. Spock can put no subjective spin on his analysis. His opinion is always supported by facts at hand. When he is forced to speculate, he refrains by saying one needs facts to even speculate. When he theorizes for the unknown, he only does so based on available factual evidence.

It is fair to say that Mr. Spock is completely un-socialized into any worldview other than of pure logic and empiricism. Thus he brings no presuppositions and no prejudices to his testimony other than that which naturally falls out from pure logic applied to empirical data. An example to illustrate this is from the episode titled "Court Martial" where Mr. Spock is being asked to testify in a court martial of his captain. When Mr. Spock asserted that it was not possible for his captain to be guilty as charged because it was not in his nature to make such an error, he was accused by the prosecutor of bias due to loyalty to his captain; that Spock hadn't actually watched the captain not do what he was charged with doing. Mr. Spock's response is elegantly logical: *"I know the captain. Lieutenant, I am half Vulcanian. Vulcanians do not speculate. I speak from pure logic. If I let go of a hammer on a planet that has a positive gravity, I need not see it fall to know that it has in fact fallen."*

As the science officer aboard the Starship Enterprise, Mr. Spock is the second in command and has the distinguished record of one hundred percent objective situational analysis of fast breaking crises one hundred percent of the time. Just the kind of mind we need to launch our forensic examination of the Holy Qur'an – the separation between the object under study and the observer. Mr. Spock's logical mind lends us that much needed cleavage.

**Source URL:** <http://faith-humanbeingsfirst.blogspot.com/2011/08/islam-why-is-quran-easy-to-hijack-pt1.html>

First Published August 03, 2011

## Why is the Holy Qur'an so easy to hijack?

### Part-II

#### Introduction

In Part-I of this study, Mr. Spock from Star Trek had just picked up the Holy Qur'an and with a *cleansed heart* as is natural to him on all matters (i.e., without prejudice and socialization bias – see Islam and Knowledge vs. Socialization ), delved into the inquiry of what is in that Holy Book of 1.6 to 2 billion Muslims on planet earth. While it will surely take a good book-length report to cover all that he learnt, this Part-II and sequels to follow narrowly focus on the factual and analytical portions of his discovery as directly pertinent to the overarching inquiry question raised in Part-I:

**What are the inherent impediments for studying the message of the Holy Qur'an which make the Book so amenable to self-serving interpretation, socialization, and even bastardization by anyone?**

While this investigative study is intended primarily for the benefit of ordinary Muslims to foster a greater analytical understanding of our own religion, Islam, ordinary Non-Muslim peoples will, perhaps for the first time in the English language – the language of the Anglo-Saxon masters du jour of the affairs of the world – perceptively glimpse the scriptural reasons for the delicate fracture points of disunity among Muslims. These fracture points have been rife for exploitation by all *imperial mobilizations* of all empires, both past and present. But Islam, the “deen” chosen by Allah, the Author designate of the Holy Qur'an, as a divine favor to mankind to show them an enlightened divinely guided way of life, has nothing to do with empires:

“This is the Scripture whereof there is no doubt, a guidance unto those who ward off (evil).” (Arabic: **ذَلِكَ الْكِتَابُ لَا رَيْبَ فِيهِ هُدًى لِّلْمُتَّقِينَ**) Holy Qur'an, Surah Al-Baqara 2:2

“This day have I perfected your religion for you, completed My favour upon you, and have chosen for you Islam as your religion.” (Arabic: **الْيَوْمَ أَكْمَلْتُ لَكُمْ دِينَكُمْ وَأَتَمَمْتُ عَلَيْكُمْ نِعْمَتِي وَرَضِيْتُ لَكُمُ الْإِسْلَامَ دِينًا**) Holy Qur'an, Surah Al-Maeda verse fragment 5:3

Then, how did a religion which Allah perfected as guidance for the pious ( **هُدًى لِّلْمُتَّقِينَ** ) become an unsurpassed empire soon after the death of its Prophet? The last remnants of which were finally forcibly laid to rest by the Anglo-Saxon masters in the early twentieth century in full capitulation to the *white man's burden*? That study is a study of history of rise and fall of empires in all its broad dimensions and has been repeated many times by others. A notable reading is Philip K. Hitti's *History of the Arabs*. Such is not the direction of this far humbler work. This study principally examines the narrow question which to this scribe's knowledge has not been addressed in Muslim and non-Muslim scholarship alike: Has the Holy Qur'an, the Book of divine guidance to the pious, itself contributed to its own “subversion”? Meaning, its own proclaimed goal of **أُمَّةٌ مُّسْلِمَةٌ**, a single Muslim nation:

**“Our Lord! make of us Muslims, bowing to Thy (Will), and of our progeny a Muslim nation, bowing to Thy (will); and show us our place for the celebration of (due) rites; and turn unto us (in Mercy); for Thou art the Oft-Returning, Most Merciful.”** ( Arabic: **رَبَّنَا وَاجْعَلْنَا مُسْلِمِينَ لَكَ وَمِنْ ذُرِّيَّتِنَا أُمَّةٌ مُّسْلِمَةٌ لَكَ وَأَرِنَا مَنَاسِكَنَا وَتُبْ عَلَيْنَا إِنَّكَ أَنْتَ التَّوَّابُ الرَّحِيمُ** ) Holy Qur'an, Surah Al-Baqara 2:128

This is a frightening question to ask, let alone explore with unabated courage. But it is a legitimate question to inquire into because its seeds are directly planted in the Holy Qur'an itself, just waiting to be ploughed by an alert mind seeking the fruits of its divine message rather than foolishly parrot its words without comprehension as a cultural inheritance in socially acceptable ritualistic ways:

'Then the Messenger will say: **“O my Lord! Truly my people took this Qur'an for just foolish nonsense.”**” (Arabic: **وَقَالَ الرَّسُولُ يَا رَبِّ إِنَّ قَوْمِي اتَّخَذُوا هَذَا الْقُرْآنَ مَهْجُورًا**) Holy Qur'an, Surah Al-Furqaan 25:30

And what are those seeds planted in the Holy Qur'an which further beg the question of inquiry in this study – apart from the Prophet of Islam himself condemning his people as



vouched by the Holy Qur'an above? Witness:

“Mankind was but one nation, but differed (later). Had it not been for a Word that went forth before from thy Lord, their differences would have been settled between them.” (Arabic: وَمَا كَانَ النَّاسُ إِلَّا أُمَّةً وَاحِدَةً فَاخْتَلَفُوا ۗ وَلَوْلَا كَلِمَةٌ سَبَقَتْ مِنْ رَبِّكَ لَقُضِيَ بَيْنَهُمْ فِيمَا فِيهِ يَخْتَلِفُونَ ) Holy Qur'an, Surah Yunus 10:19

“If Allah had so willed, He would have made you a single people, but (His plan is) to test you in what He hath given you: so strive as in a race in all virtues. The goal of you all is to Allah; it is He that will show you the truth of the matters in which ye dispute.” (Arabic: وَلَوْ شَاءَ اللَّهُ لَجَعَلَكُمْ أُمَّةً وَاحِدَةً ۗ وَلَكِنْ لِيَبْلُوَكُمْ فِي مَا آتَاكُمْ ۗ فَاسْتَبِقُوا الْخَيْرَاتِ ۗ إِلَى اللَّهِ مَرْجِعُكُمْ جَمِيعًا ۖ فَيُنَبِّئُكُمْ بِمَا كُنْتُمْ فِيهِ تَخْتَلِفُونَ ) Holy Qur'an, Surah Al-Maeda verse fragment 5:48

It says it right there – in the momentous words of the Holy Qur'an: **“If Allah had so willed, He would have made you a single people,”!** And **“Had it not been for a Word that went forth before from thy Lord, their differences would have been settled between them.”** Had God wanted to, matters of disunity would have been settled in the very beginning. But, the verse of the Holy Qur'an vouches, it was by the Lord's Word instead, that differences arose, and the settlement day deferred to be the Day of Reckoning:

“And for every nation there is a messenger. And when their messenger cometh (on the Day of Judgment) it will be judged between them fairly, and they will not be wronged.” (Arabic: وَلِكُلِّ أُمَّةٍ رَسُولٌ ۖ فَإِذَا جَاءَ رَسُولُهُمْ قُضِيَ بَيْنَهُمْ بِالْقِسْطِ ۗ وَهُمْ لَا يُظْلَمُونَ ) Holy Qur'an, Surah Yunus 10:47

But, until then, **“(His plan is) to test you in what He hath given you: so strive as in a race in all virtues. The goal of you all is to Allah; it is He that will show you the truth of the matters in which ye dispute.”** And that divine plan is one of choice for man, whether man is thankful or unthankful for the guidance:

“Surely We have shown him the way: he may be thankful or unthankful.” ( Arabic: إِنَّا هَدَيْنَاهُ السَّبِيلَ ۖ إِمَّا شَاكِرًا وَإِمَّا كَفُورًا ) Holy Qur'an, Surah Al-Insan 76:3

The topic of inter-civilizational and inter-religion common striving for فَاسْتَبِقُوا الْخَيْرَاتِ , as in a race in all virtues (5:48 quoted above), has already been examined in the study Islam and Knowledge vs. Socialization where religion as socialization among different

peoples is explored in some depth. The same considerations apply to Muslims as well who, as one empirically observes, also become divided into sects and nations by way of socialization and inheritance no differently than the rest of the people on earth.

An alert mind can therefore legitimately inquire into the same Qur'anic concepts noted above also being applicable among Muslims themselves! Had God wanted to, He could have surely clarified all matters in the Holy Qur'an unambiguously, but as we shall discover in this study done through the metaphor of Mr. Spock, the Author of the Holy Qur'an instead announced the following:

“He it is Who has sent down to thee the Book: In it are verses basic or fundamental (of established meaning); they are the foundation of the Book: others are allegorical. But those in whose hearts is perversity follow the part thereof that is allegorical, seeking discord, and searching for its hidden meanings, but no one knows its hidden meanings except Allah. And those who are firmly grounded in knowledge say: 'We believe in the Book; the whole of it is from our Lord:' and none will grasp the Message except men of understanding.” (Arabic: هُوَ الَّذِي أَنْزَلَ عَلَيْكَ الْكِتَابَ مِنْهُ آيَاتٌ مُحْكَمَاتٌ هُنَّ أُمُّ الْكِتَابِ وَأُخَرُ مُتَشَابِهَاتٌ فَأَمَّا الَّذِينَ فِي قُلُوبِهِمْ زَيْغٌ فَيَتَّبِعُونَ مَا تَشَابَهَ مِنْهُ ابْتِغَاءَ الْفِتْنَةِ وَابْتِغَاءَ تَأْوِيلِهِ وَمَا يَعْلَمُ تَأْوِيلَهُ إِلَّا اللَّهُ وَالرَّاسِخُونَ فِي الْعِلْمِ يَقُولُونَ آمَنَّا بِهِ كُلٌّ مِنْ عِنْدِ رَبِّنَا وَمَا يَذَّكَّرُ إِلَّا أُولُو الْأَلْبَابِ ) Holy Qur'an Surah Aal-Imran, 3:7

As is examined in-depth later on, the afore-quoted verse 3:7 of Surah Aal-Imran lends prima facie justification into this inquiry which is evidently long overdue (by fourteen centuries it would appear). The poorly understood nature of sectarianism among Muslims which is always examined as events of history and not as a prima facie consequence of the scriptures themselves, testifies to this bold observation. Just as the **“Word”** ( وَلَوْ لَا كَلِمَةٌ ) caused differences to appear among mankind to be settled on the Day of Reckoning: **“And when their messenger cometh (on the Day of Judgment) it will be judged between them fairly, and they will not be wronged.”**, did the Qur'anic Word also deliberately induce differences to appear among the Muslims for the same considerations: **“(His plan is) to test you in what He hath given you: so strive as in a race in all virtues. The goal of you all is to Allah; it is He that will show you the truth of the matters in which ye dispute.”**, and to offer the same choice: **“Surely We have shown him the way: he may be thankful or unthankful.”**, in almost exactly the same parallel:

“One day We shall call together all human beings with their (respective) Imams” (Arabic يَوْمَ نَدْعُو كُلَّ أُنَاسٍ بِإِمَامِهِمْ ) Holy Qur'an, Surah al-Israa'

17:71

It is like opening the Pandora's box – but as the legend declares, if one has the patience and the determination to dig through to its very bottom, the understanding will be found.

A cautionary negative side effect falls out from the afore-quoted verse 17:71 which is perhaps pertinent to mention here just briefly before continuing. The Holy Qur'an emphatically avers that all human beings will be held to account on the Day of Judgment in the company of the leader, the Imam, they each followed. So if one correctly followed any Prophet of God, since Messengers have been sent to all peoples, no problem for them, as expected. That is the pluralism of Islam – the only religion bequeathed by antiquity to the modern world to espouse such liberalism. See [Islam and Knowledge vs. Socialization](#) for details. But what if one inadvertently made a fast-talking ignoramus one's "Imam"; or followed learned discourses written by kings and shrewd apprentices of Machiavelli who obfuscated and subverted the religions to control their peoples; or simply remained socialized under the iconic authority figures they grew up with? It would be hell to pay on the Day of Judgment – for both Muslims and non-Muslims alike, since verse 17:71 is addressed to all human beings. You are whom you follow and learn from – better choose your teachers and Imams wisely! That's the principal Qur'anic message here, to Jews, Christians, Muslims, Hindus, to all human beings whatever their persuasion and inheritance. Also see verses 2:166-167 of Surah Al-Baqara quoted below.

Coming back to the main theme of opening a Pandora's box in this inquiry, the Holy Qur'an's focus upon the virtuous, هُدًى لِّلْمُتَّقِينَ (verse 2:3 above), those who are perpetually on the *straight path* of becoming the *perfectman* (or *marde-momin*, as eloquently captured by the twentieth century poet-philosopher of Muslims from the Indian sub-continent, Dr. Muhammad Iqbal, in contrast to the nihilistic *Nietzscheian superman* who is *beyond good and evil*, the *ubermensch*, born after killing god, and becoming god himself, see [Morality derived from the Intellect leads to Enslavement!](#)), also seems rather simplistic on the surface. Especially so in a modernity which is run entirely by soulless, psychopathic, Machiavellian, Nietzscheian, manipulative controllers who create *prisoners of the cave* with the ease of perception management described by Plato in *The Republic*.

What can the virtuous possibly ever do to overcome that perception management for regimented social control if they only journey from cradle to grave as *prisoners of the cave*? (Refer back to the Mighty Wurlitzer, Chapter 2 in this book)

Plato's book was written one thousand years before the Holy Qur'an was disseminated to mankind in Arabia. And it begs the pertinent question: has the Holy Qur'an provided any

recipe for extracting oneself from the matrix of perception management for *prisoners of the cave*? Can a *prisoner of the cave* ever escape the chains of the cave using purely his own cognitive reasoning abilities? Is logical examination of observed facts based on the five human senses, the empiricism of scientists, alone sufficient to extract oneself from such perception-management which is now akin to mind-control?

The rational materialist scientists oft proclaim of their left-brain dominated scientific processes:

“The only means of knowledge is reasoning from observed facts; The senses provide our only direct contact with reality; Pure logical thinking cannot yield us any knowledge of the empirical world; all knowledge of reality starts from experience and ends in it;” (Albert Einstein, as noted by Dr. Abdus Salam in his Nobel speech, 1979)

A thoughtful reading of Plato's *Myth of the Cave* is essential to appreciate the depth and dimensions of this question. The reader is referred to Plato if he is unfamiliar with the simile of the cave. This question, which addresses the mind that is itself under intense psychological manipulation by both socialization and Machiavellian forces and therefore, it being a self-referential problem, appears intractable using only empirical and experiential logic.

This question is therefore at the very heart of epistemology – the study of knowledge, how we know what we know. The totality of cognitive, subliminal, and primal forces diabolically manipulating the mind which remain entirely incognizant to the logical mind, known as psychological forces, compound the already self-referential problem. Twentieth century Austrian logician, mathematician and philosopher, Kurt Friedrich Gödel, demonstrated the intractability of such a problem if it is constrained to the dimension in which the problem is formulated, in his *Incompleteness Theorem*. One has to transcend to a higher dimension which contains the dimension of the problem being solved within it, in order to examine the lower dimension's axioms for self-consistency and completeness. This is as true in mathematics and in immanent philosophy, as perhaps in practicably escaping the mental chains of *Plato's Cave*. Perhaps we shall also uncover that dimension, a higher evolutionary consciousness which transcends the five senses and simplistic notions of piety, in this study and come up with some sensible understanding of Islam's role in addressing this question as well.

Before we can follow Mr. Spock's trail of discovery of the Holy Qur'an, some further elaboration on the *Mr. Spock* metaphor is necessary for those unfamiliar with Star Trek and

don't immediately get the concept of the logic mind in contrast to the intuitive mind.

### **Why Mr. Spock Abstraction**

Briefly introduced as an abstraction at the conclusion of Part-I as a lead into the analytical study of the Holy Qur'an, Mr. Spock is a fictional character from the 1960s television series fable called Star Trek. As fables usually are, this fable also carries within it many intriguing lessons. Mr. Spock is a useful literary device for purely logical and purely analytical exploration of any subject matter. That is so because this character possesses no intuitive understanding of, or susceptibility to, faith or to faith inducing artifacts including socialization, love, hate, emotional attachments, imagination, intuition, gut-feel, etc. Mr. Spock only goes by facts alone, and reasons by factual logic alone, in a very sterile methodical manner like a computer. He is strictly bound by causality which is empirical, and not fettered by imagination and intuition which perpetually remain beyond the bounds of causality.

Since Mr. Spock is entirely what might be classically called "left brained", the spiritual aspects of the Holy Qur'an which often impact the human heart and imagination, the human soul, have no impact on him. This "left brained" metaphor for mathematically precise logical behavior requires some elaboration for readers unfamiliar with the anatomy of the human brain.

The human brain is principally in two distinguishable halves, the left and the right. For an undamaged brain which hasn't re-mapped its functions to its non-damaged parts in the self-healing process of an injured brain, the left-half typically deals in the more concrete matters of logic, analytical reasoning, engineering, math and science. And the right-half typically deals in the abstract, creative, artistic, verbal, linguistic, imaginative, poetic, spiritual, insight that is intuition based, and intuition and inspiration related matters that are not necessarily bound by causality and empiricism.

Narrowly specialized scientists generally tend to have left-half brain dominance which is what makes many of them such dorks on spiritual matters but brilliant in scientific endeavors. Whereas narrowly specialized artists and touch-feely people generally tend to have right-half brain dominance which is what often makes some so hopelessly romantic, and some others great sensitive, imaginative poets. The rest of humanity is somewhere in between that spectrum, more or less on a bell curve.

The best scientists however, those not narrowly and overly specialized, well understand the role both imagination and intuition, i.e., what appears to be faith to others, plays in one's

scientific pursuits. As Charles Townes, 1964 Nobel physics laureate stated it: *“Science wants to know the mechanism of the universe, religion the meaning. The two cannot be separated. Many scientists feel there is no place in research for discussion of anything that sounds mystical. But it is unreasonable to think we already know enough about the natural world to be confident about the totality of forces.”* Abdus Salam, who shared the 1979 Nobel Prize in Physics with Wienberg and Glashow, noted the role of faith in physics by first reciting verses 67:3-4 of Surah Al-Mulk from the Holy Qur’an on the Nobel podium in Stockholm, and stated: *“This in effect is, the faith of all physicists; the deeper we seek, the more is our wonder excited, the more is the dazzlement for our gaze.”* Arthur L. Schawlow, 1981 Nobel Prize in Physics observed: *“It seems to me that when confronted with the marvels of life and the universe, one must ask why and not just how. The only possible answers are religious. ... I find a need for God in the universe and in my own life.”* And Max Planck the pioneer of modern physics, 1918 Nobel Prize in Physics, is famous for his insight (see full quote below): *“It is impossible to make a clear cut between science, religion and art.”*

All these Nobel laureates espoused something far greater than logic and reasoning aptitude of the left-brain. They also engaged their right-brain to fully employ their entire mind to perceive reality. Such broad-band scientists evidently style their life's pursuits in accordance with what they perceive by imagination and faith. Since the domain is physics, it naturally lends itself to empiricism and measurement to confirm to others what one discovers running on faith and imagination. And then it becomes science. But when the domain is metaphysics which is not amenable to empiricism and measurements, demonstrating the truths one uncovers can be a difficult problem. This was demonstrated by Richard P. Feynman, 1965 Nobel Prize in Physics, by his *out of body* experiments in a sensory deprivation tank in which he experienced a state of mind and consciousness which no one else can reproduce, let alone measure. And this problem was also marvelously portrayed by Rudyard Kipling in his novel “Kim”. Once the lama discovers the *River of the Arrow* after a lifetime of quest, he is unable to explain its wondrousness to anyone, including to his most ardent disciple!

That is the general problem of subjectivity inherent in imagination and intuition, gut-feel and insight, the purview of the right-brain abstraction. The two halves together constitute human consciousness --- the *raison d'être* for the human mind which enabled the human Captain Kirk to trump the logic-only Mr. Spock every single time in every Star Trek episode. We see that both literature and science understand the meta logic of the mind – that it is not constrained by logic, causality, or being able to measure something quantifiably in order to assert its existence, in its most heightened state of awareness.

This is obviously a first order model because human beings are clearly multifaceted and rather complex. Scientists have barely scratched the surface of the human mind even though the human brain has already been under the modern microscope for well over a hundred years, and even though much understanding has been gained on behavioral and cognitive psychology fronts which form the core basis of modern behavior control via perception management and propaganda. See the report [Behavior Control: Architecture of Modern Propaganda](#) for comprehending the degree of perception management achieved in today's modernity where the difference between reality and the image of reality is akin to day and night.

All of Mr. Spock's brain is what would be only the left-half brain in humans, multiplied by two to occupy the entire cranial space which is the same physical size as in humans.

Thus, using Spock to perform this narrow study is equivalent to using an IR filter in a camera to block out unwanted infra red wavelengths from being captured in the image and leaving its indelible artifacts upon the image, when one is specifically only interested in seeing what the image looks like in the narrow visible light spectrum. This is also called controlling the selectivity in engineering parlance. Mr. Spock's limitation of not having what we humans have in the right-half brain, lends a natural selectivity switch for intellectually understanding the Holy Qur'an without interference from the spiritual right-half brain which typically drives matters pertinent to human faith.

This is only a useful abstraction, an intellectual tool, and not to be taken too literally – for first and foremost, the Holy Qur'an is a spiritual message to mankind: to believe in an unseen Creator **يُؤْمِنُونَ بِالْغَيْبِ** on faith alone! (verse 2:3)

The Holy Qur'an asks man to believe in several matters of Divine provenance which defy man's analytical and experiential logic, such as Revelation, Prophethood, Resurrection, Day of Judgment, Hereafter, Heaven, Hell, etc. But these do not defy the spirit of man whose essence is clearly spiritual, i.e., non material. Empiricism indicates that man, despite the overt formulation of his material body, is not just a collection of atoms and chemical reactions which can be analytically reasoned about in a laboratory or in philosophy (despite the insistence of scientists & philosophers). Love, moral-sense, self-sacrifice, the language of the heart and its tribulations, all defy pat formulations of the materialist. The intellect which enslaves the heart often turns it into stone. (See [Morality derived from the Intellect leads to Enslavement!](#)) The twentieth century poet-philosopher of Muslims, Muhammad Iqbal who endeavored to free man from the shackles of all servitude to fellow man and to his enslaving intellectual ideologies, put it this way in a famous verse in Urdu:

صبح ازل یہ مجھ سے کہا جبرئیل نے  
جو عقل کا غلام ہو ، وہ دل نہ کر قبول

Subh-e-Azal yeh Mujh Se Kaha Jibraeel Ne  
Jo Aqal Ka Ghulam Ho Woh Dil Na Ker Qabool (transliteration, [listen](#))

'Gabriel on the Morning of Creation a piece of useful counsel gave:  
Accept not the heart from a beloved whose mind enslaves it' (Kalaam-e-  
Iqbal, Zarbe-e-Kaleem)

And Rabindranath Tagore put the limitations of one sided use of the intellect thusly:

“A mind all logic is like a knife all blade. It makes the hand bleed that uses  
it.”

What gives a protective handle to this “*knife all blade*”, and breathes humanity into this collection of atoms and molecules called man, is a spiritual essence, and it is to that essence that the Holy Qur'an speaks for imparting spiritual guidance, to the **هُدًى لِّلْمُتَّقِينَ** who believe in the unseen **يُؤْمِنُونَ بِالْغَيْبِ** (verses 2:2-3), while also inviting reflection with logic and analytical reasoning (verses 67:3-4; 6:76-79). Neither is sufficient by itself for human beings. We require both logic and reason (left-half brain) to understand cognitively, and imagination and faith (right-half brain) to perceive spiritually. The left-brain parses the language of logic. The right-brain parses the language of the heart. To ignore either brain function is to deliberately be one-eyed when most are endowed with two for full depth perception. Such full spectrum comprehension with both eyes, the eye of logic and reason, and the eye of faith and intuition, enables thwarting cognitive as well as subliminal infiltration used for perception management and behavior control by the vile among mankind. It helps man perceive and react to reality the way it is rather than the way it is made manifest on the screen of Plato's cave. (See [Introduction Prisoners of the Cave](#))

Abstractions like the one employed here therefore can help formulate and understand an otherwise intractable problem by breaking it down into logical components. This can be done recursively to each component until one gets down to a level at which one can completely (or at least satisfactorily) comprehend or manage it. However, as Max Planck sensibly wrote on the process of knowledge acquisition demonstrating that he well understood the role of both the left and right half brain abstractions in the service of the entire mind seeking knowledge:

“Modern physics has taught us that the nature of any system cannot be



discovered by dividing it into its component parts and studying each part by itself, since such a method often implies the loss of important properties of the system. We must keep our attention fixed on the whole and on the interconnection between the parts. ... The same is true of our intellectual life. It is impossible to make a clear cut between science, religion and art. The whole is never equal simply to the sum of its various parts.” (Max Planck, Partly cited in *Critique of Western Philosophy and Social Theory* By David Sprintzen, pg. 76)

To engage such abstract analytical methods one requires a great deal of selectivity as a tool to enable focussing on matters pertinent to each level of abstraction. After the decomposition exercise is completed, reassembling the smaller well-understood pieces into an interconnected greater whole enables conquering the once insurmountable problem.

This additive reassembly is often termed superposition in engineering parlance. In the illustrative example, it is akin to removing the IR filter from the camera to see what the composite image finally looks like in the presence of the unseen-to-the-naked-eye infrared wavelengths.

Since human beings are a combination of BOTH, left and right half brain which perform different functions, it would be foolish to take a one-half brained understanding of any matter as the complete understanding of the matter when we actually possess two distinct halves to yield to us a much greater and richer understanding when we maximally use both halves. But it can be quite insightful to use each half independently, employing tools pertinent to each, and superpositioning the understanding gleaned separately from the two different halves into a greater whole.

It is pertinent to recall from Star Trek that the captain, James T. Kirk, is a human being who draws upon Mr. Spock's analytical abilities as needed, but runs his ship as a human being, full of intuition, full of insights, gut feels, and other non-logical things which bedevil Mr. Spock. But doing so enables the ship's captain to do far more than the solely logical Mr. Spock ever can. The interesting characteristic of Spock is that he does not deny nor oppose the understanding acquired via the right-half brain by the captain. He merely accepts that it is not within his limited capabilities, being a solely left-half brained creature, to fully comprehend the captain's intuitions. Such logic of acceptance might shame the humility challenged who reduce human beings to the material lives of a cell!

So we use Mr. Spock just as Captain Kirk uses him for logical analysis, and no more.

Let's now follow Mr. Spock's trail of discovery on that aforementioned narrow question whose exploration is surprisingly very broad.

### **The Holy Qur'an is not a book of literature**

The first thing Mr. Spock did before he began his study was to classify the genre of the Holy Qur'an as a law book, as a rule book, as a specification manual, as a specific message conveyed through a Messenger, rather than as a book of literature, fiction, poetry, philosophy, theosophy, mysticism, science, or history. Spock recognized the import of such a core classification. He understood that the Holy Qur'an was a message by its Author to its audience. It was like an important letter or cipher conveying a singular message. Therefore, accurate extraction and understanding of the message was essential in the exact context conveyed by the Author of the Message, and not in the context of the reader – or the reader can misunderstand and misinterpret the message or parts of the message, and believe and act in ways not intended by the Author. And Mr. Spock of course was embarking on his study of the Holy Qur'an in order to learn exactly what the Author of the Holy Qur'an had specifically intended to convey in that Message as opposed to how he might interpret it on his own fancy.

Being of logical and sensible scientific acumen, Mr. Spock well understood the difference between reading literature which is amenable to personal interpretation and localized understanding such as what does a poem or philosophy mean to a human being or to a culture (in their own particular circumstance), and reading a rules and regulations manual delivered in a particular cultural context, or a design specification manual in a particular technology, where there is no room for personal and localized interpretation otherwise one gets it wrong and fails the interoperability and system integration tests. One has to comprehend exactly what the author has stated and meant, both in the letter and the spirit of the specification in the totality of the system specification.

Imagine trying to interpret the DMV driver's manual for the rules of the road, or the income tax code by one's own fancy. It is empirical that in the latter cases one endeavors to exactly understand what the relevant authority has meant to convey in its own, often convoluted, legalese language of expression and cultural context, or one does not pass the driver's license test and gets a tax audit, respectively! Foreigners coming to the United States for instance, have to learn English and the road rules and road signs which are in English, in order to pass the DMV driving test which is particular to each of its fifty states. No Pakistani can try to interpret these unfamiliar traffic rules in his or her own Pakistani cultural context – which would be absurd and rather hazardous in any case if one is driving in the streets of America.

Even though Mr. Spock is left brained and does not interpret based on personal inclination by definition, doing his due diligence to address the posed question, he classified the Holy Qur'an as not open to personal interpretation.

Instead, Mr. Spock deemed the Holy Qur'an akin to a cipher which must be deciphered into a singular *plaintext*. Correct deciphering entails exactly recovering the *plaintext* message which its Author has meant to convey through the cipher.

The result of this classification has far reaching consequences for the question posed at the top. And this is the first commonsense conclusion Mr. Spock reached – without even opening the Holy Qur'an.

Knowing that human beings are generally prone to the right-half brain interfering via personal subjectivity in even logical matters, he logically deduces that people would also try to interpret the Holy Qur'an according to their own proclivities and socialization contexts just as they might a fine book of literature or poetry.

That instead of first judiciously trying to comprehend the principles which the Author of the Holy Qur'an had laid down in its specification in both letter and in spirit (as when using the DMV manual for instance to pass the driver's license test) and then applying those principles to one's own epoch (just as one might apply the DMV traffic rule book to one's own specific road conditions), the believers of the religion of Islam would be naturally inclined to interpret the Holy Qur'an in their own respective socialization contexts.

And therefore, when they did that, they would each understand something different from reading or hearing the same text and that would explain the empiricism of Muslims being always divided on the meanings of the same verses of the Holy Qur'an ever since the demise of the Messenger of the Author of the Holy Qur'an who had acted as its Exemplar.

This condition is akin to different human beings reading the DMV driver's handbook interpretively and coming away with a different understanding of the traffic laws because no DMV inspector is sitting next to them in the car and being their exemplar for every emerging driving condition. Wouldn't that create chaos and mayhem on the road?

The same chaos is seen on the spiritual road of Islam in the mayhem of sectarian divides and mis-interpretations when people mis-classify a spiritual specification book and sub-consciously or deliberately read it as fine subjective literature because they are taught: *read and see what the Holy Qur'an means to you!*

Imagine if the DMV inspector said that to the learner waiting patiently for his turn to pick up

the DMV rule book to pass the driving test: *here take this DMV driver's manual and see what it means to you!* The burden is always upon the prospective driver to exactly learn what the DMV driver's manual intends to teach, and not what it might mean to him in his flights of fancy as a race car maniac.

### **The Holy Qur'an is not primarily a written book**

The first thing Mr. Spock discovers upon checking out the Holy Qur'an from his space ship's library is that there is no name of author imprinted on the cover page of the Holy Qur'an. Since a name is always a proper noun, Spock decides to call its author, Author of the Holy Qur'an, or just Author (with a capitalized A).

The next thing Spock discovers is that the Holy Qur'an is really an aural tape, in Arabic, and its medium of ingestion is primarily through the ears. He is initially delighted because he has big pointed ears. So he quickly learned the Qur'anic Arabic from the computer library to the point of understanding the Arabic language (but not the lingua franca of the day in which the Holy Qur'an was made manifest as a Book – Mr. Spock hasn't as yet discovered the pertinence of lingua franca in his study). After mastering Arabic grammar, syntax, and semantics quickly (remember his left-half brain is twice the physical size of humans and thus carries an exponential higher capacity to learn), he listened intently to the entire Holy Qur'an. It made no soulful impression on him (as expected). So Mr. Spock delved directly into its contents.

But since Spock was used to reading specification manuals with his eyes-brain combination rather than ears-brain combination – despite large ears – he decided to focus on the written version of the Holy Qur'an so that he could easily sift back and forth as he would a science encyclopedia, but much more complicated in the case of the Holy Qur'an.

The Holy Qur'an, he discovered to his consternation, did not read contiguously for a topic like every other specification manual he had ever read – and being a well-traveled man of space, he had read most works of science as well as literature of not just mankind but also of many other beings in the galaxy. His captain usually quoted from the Bible and Milton, and Mr. Spock was quite familiar with their contents, if not their appreciation. Reading the Holy Qur'an as a Book and digesting its information wasn't going to be as straightforward as Spock had imagined, having given himself only a few hours for the examination – which now stretched into days.

### **The Holy Qur'an is complicated to understand**

While reading the Holy Qur'an sequentially, Mr. Spock discovers that the context of the verses, such as which verses are related to which verse, the antecedents and the precedents, unless the subject matter is explicit and obvious, is impossible to determine from the text of the Holy Qur'an. The Holy Qur'an does not carry the context for all the verses within it, nor the order in which the verses were revealed by the Author of the Holy Qur'an to His Messenger to convey to the people, and nor on what occasions and in which local contexts did they apply and to whom did they apply. Therefore, to infer the general meaning of a topic without having the local context is subject to error. As the causality among the various verses is impossible to ascertain with certainty in all cases from the Holy Qur'an except where it is patently obvious, it also introduces error by not always knowing all the verses and their full contexts pertinent to a topic. Mr. Spock also discovers that nor is it possible to determine the meaning of many of the allegorical verses.

Mr. Spock uncovers that verse 3:7 of Surah Aal-'Imran (quoted in the Introduction above) even confirms that no one may know their full meaning and import apart from the Author of the Holy Qur'an, and none will grasp that Message except men of great understanding. The implication of that Qur'anic statement made Mr. Spock ponder: why have verses in the Holy Qur'an which is supposedly a guidance to all mankind, which none but the Author Himself can understand: ***“but no one knows its hidden meanings except Allah”?***

Mr. Spock pushes that puzzle onto his puzzle *evaluation stack*\* which is steadily growing.

The verse 3:7 identifies two main category of verses in the Holy Qur'an, آيَاتٍ مُّحْكَمَاتٍ , the foundational verses whose meaning is plain and straightforward. The verse proclaims that these constitute the heart of the Holy Qur'an. And وَأُخْرٍ مُّتَشَابِهَاتٍ , the allegorical verses whose meaning is not so straightforward, and whose layered meaning is hidden and known only to the Author.

What Mr. Spock found fascinating in this self-description of the Holy Qur'an is the cold prediction made by the Author of the Holy Qur'an that those with perversity in their heart, or from sheer ignorance, will pursue the latter deliberately, sowing discord instead of harmony. But those who are firmly grounded in knowledge and faith, will not fall for this trick!

Thus a major source of misunderstanding of the Holy Qur'an was made known by the Holy Qur'an itself.

Mr. Spock further notes that the Author of the Holy Qur'an in verse 4:59 had delegated Its command Authority to its Messenger and Exemplar at the same precedence level of

obedience as It demanded for Itself:

“O ye who believe! **Obey Allah, and obey the Messenger, and those charged with authority among you.** If ye differ in anything among yourselves, refer it to Allah and His Messenger, if ye do believe in Allah and the Last Day: That is best, and most suitable for final determination.”  
(Arabic: يَا أَيُّهَا الَّذِينَ آمَنُوا أَطِيعُوا اللَّهَ وَأَطِيعُوا الرَّسُولَ وَأُولِي الْأَمْرِ مِنْكُمْ ط  
فَإِنْ تَنَازَعْتُمْ فِي شَيْءٍ فَرُدُّوهُ إِلَى اللَّهِ وَالرَّسُولِ إِنْ كُنْتُمْ تُؤْمِنُونَ بِاللَّهِ وَالْيَوْمِ  
الْآخِرِ ۚ ذَلِكَ خَيْرٌ وَأَحْسَنُ تَأْوِيلًا ) Holy Qur'an, Surah an-Nisaa' 4:59

But what the Messenger had conveyed to his people based on this delegated authority and which was made binding upon the people by the Author of the Holy Qur'an, had not been recorded in the Holy Qur'an apart from the fact of this delegation of authority! In the above quoted verse, for example, who are “**those charged with authority among you**” are not unambiguously identified by name.

Mr. Spock is perplexed by the fact that only the Author's own message is preserved in the Holy Qur'an, and not those articulated by the Messenger, even though the Messenger, by the accurate grammatical parsing of verse 4:59, has equal command obedience authority to the Author. Therefore, whatever the Messenger of the Author gives to his people as guidance, doctrine, or verdict, or explains to them as Exemplar of the Holy Qur'an, obeying it has the same obligation as if the Author Himself issued the directive in the Holy Qur'an. While the Exemplar was living among his peoples, his followers were surely informed of all the contextual matters pertaining to adequate comprehension of all آيَاتٍ مُّحْكَمَاتٍ , the foundational verses in the Holy Qur'an, such as who are the persons identified as “**those charged with authority among you**” to whom, evidently, by the logic of the verse, command obedience is as obligatory as to the Prophet of Islam himself.

Mr. Spock is baffled. The Muslim flock is ordered to Obey the Messenger in all that the Messenger conveys, but these articles of obedience, and exponentiation of the full context of the Qur'anic verses, are not recorded in the Holy Qur'an by the Author of the Holy Qur'an.

How are the succeeding generations to know? From the doubtful hands of fallible scribes and partisan narratives of imperial history? This seemed very illogical to Mr. Spock. It created a primary paradox for a Book which claimed to have “no doubt” and “perfected” (as per verses 2:2 and 5:3 quoted earlier).

Mr. Spock realized that a perpetual open-ended gaping hole is left in the Qur'anic guidance

system to mankind. Spock wondered if that was calculated, to introduce deliberate ambiguousness in the specification, just as the presence of **آيَاتٌ مُتَشَابِهَاتٌ**, the allegorical verses described in verse 3:7 quoted earlier, was deliberate in order to mislead those with perversity in their heart: **“But those in whose hearts is perversity follow the part thereof that is allegorical, seeking discord, and searching for its hidden meanings, but no one knows its hidden meanings except Allah.”**

What could be the Author's motive to offer such an ambiguous specification to mankind which could deliberately mislead them? Is it perhaps part of the process of spiritual ascendance in Islam, pondered Mr. Spock at the illogic of an ambiguous specification which proclaimed itself to be universal guidance to mankind, by which man is supposed to elevate himself (and herself) with the help of divine guidance to those who are cleansed of hearts, to the status of Ashraf-ul-Makloofat, the best in creation? For the verse fragment 4:59 continues: **“If ye differ in anything among yourselves, refer it to Allah and His Messenger, if ye do believe in Allah and the Last Day: That is best, and most suitable for final determination.”**

This appears convoluted (at least on the surface). First, the specification is deliberately made ambiguous. Then it is noted that it is okay if you disagree – **“There is no compulsion in religion.”** (2:256 quoted above) – just refer the matter to the Author or His Messenger or to those unnamed who are charged with authority among you, while also reminding the flock the oft repeated admonishment of the Day of Accountability so as not to fall victim to personal whims and fancies, but to strictly accept and follow what is given to them. Since the Messenger is no longer living in subsequent epochs, that additional directive of verse 4:59 can logically only mean: refer all matters of disagreement, or confusion, to Allah, or, to **“those charged with authority among you”** (if they are still living), because they are a divine extension of the authority of the Messenger. Furthermore, the Author, who introduced the Holy Qur'an as **“A Revelation from the Lord of the Worlds”**, also asserts that it has made its definitive reference handbook available to all peoples, for all times, **“In a Book well-guarded”**:

“That this is indeed a Qur'an Most Honourable,	إِنَّهُ لَقُرْآنٌ كَرِيمٌ
In a Book well-guarded,	فِي كِتَابٍ مَكْنُونٍ
Which none shall touch but those who are clean (purified)	لَا يَمَسُّهُ إِلَّا الْمُطَهَّرُونَ
A Revelation from the Lord of the Worlds.	تَنْزِيلٌ مِنْ رَبِّ الْعَالَمِينَ

Is it such a Message that ye  
would hold in light esteem?"

أَفِيهِذَا الْحَدِيثِ أَنْتُمْ مُدْهِنُونَ

Caption Holy Qur'an Surah Al-Waqia, 56:77-81

Such a momentous conflict resolution protocol and yet **“those charged with authority among you”** go un-named in the Holy Qur'an. What a cipher!

However, Mr. Spock's ever vigilant mind observes that the Holy Qur'an refers to itself as *al-Furqaan*, الْفُرْقَانَ , the criterion by which to judge and adjudicate the truth or falsity of all matters, and all propositions, pertaining to Islam:

“Blessed is He who sent down the criterion to His servant, that it may be an admonition to all creatures;” (Holy Qur'an Surah al-Furqaan 25:1)

تَبَارَكَ الَّذِي نَزَّلَ الْفُرْقَانَ عَلَىٰ عَبْدِهِ لِيَكُونَ لِلْعَالَمِينَ نَذِيرًا

Therefore, Mr. Spock reasons based on the unequivocal assertion of these verses, that the gaping holes which he had identified as an impediment to understanding the Holy Qur'an, indeed appeared deliberate, and by design. They were certainly not inadvertent.

But Mr. Spock also could see that their resolution, if it was of pertinence as guidance to man, according to the Author of the Holy Qur'an was also present in the Holy Qur'an itself. The Holy Qur'an contained within itself, by its own assertion, the complete criterion by which to adjudicate all that appeared unknown and ambiguous in the Holy Qur'an if it was to be knowable by man, because, after all, as was claimed by its Author, it was a Book in which there is “no doubt” **دَلِيلَ الْكِتَابِ لَا رَيْبَ فِيهِ** , and which had been “perfected” as a “religion” **الْيَوْمَ أَكْمَلْتُ لَكُمْ دِينَكُمْ** (as per verses 2:2 and 5:3 quoted earlier).

There couldn't be any holes in the specification which could not be unequivocally resolved if these statements are taken to be truthful and on face value. Mr. Spock decided to entertain these assertions because that's what the specification stated, rather than hastily conclude based on what he had studied thus far, that the Holy Qur'an was fallacious.

But that comforting realization based on the logic of the statements of the Holy Qur'an, does not by itself solve the problem for the ever logical Mr. Spock because of the inherent incompleteness of context specification, causality specification, and verse 3:7 statement which bizarrely asserted **“but no one knows its hidden meanings except Allah”?**

Which sensible author ever composes a major specification like that, wherein, he first



claims it is for everyone to follow as essential specification, but then includes clauses, ambiguities, and allegories which no one other than the author himself can understand? Mr. Spock had not encountered a specification or an Author like this one in the entire cosmos.

Furthermore, because the specification is now incomprehensible at first glance with many unknowns rather than straightforward, not only is it enormously time consuming to figure it all out, perhaps requiring experts just like doctors and specialists to expound it, but it is also replete with the subjectivity inherent in such exercise. Different human beings having different levels of brain-power, socialization, and perception bias understand things differently when they try to figure it all out based on their own study and due diligence. This is why even rational and most logical scientific people still disagree on many matters when they fall in the purview of human subjectivity and opinion mongering rather than empiricism.

And here Mr. Spock realizes is the next core-reason for human beings to understand the same text of the Holy Qur'an differently from each other.

The moment Muslims and non-Muslims alike, step outside the pages of the Holy Qur'an to gather what was incomplete in the Holy Qur'an as a specification which can be fully comprehended – namely, the temporal and social context of the Qur'anic verses for which they were revealed, their causality, the identification of the unknown persons and events, and what the Exemplar had explained to the people for twenty three years by the authority explicitly delegated to him as in verse 4:59, called *the Sunnah of the Prophet* – by perusing the pages of history, or vicariously from their cultural contexts as most are wont, they fall unwitting victim to socialization and history-writing artifacts. Including, books upon books, and treatise upon treatise of scholarly opinions compiled by people other than the Author of the Holy Qur'an, under the suzerainty of the most oppressive dynastic kingdoms and rulers among the Muslims. (See [Part-I](#) , [Islam and Knowledge vs. Socialization](#) , and [Islam vs. Secular Humanism and World Government](#) for what socialization and history-writing artifacts mean.)

Mr. Spock is struck by the remarkable disparity of preservation between the *Sunnah of the Prophet* by doubtful hands in history and the Author's own pristine words for which He claimed there was “no doubt”, despite the assurances from the Holy Qur'an that it contains the criterion for deciding all pertinent matters.

Why is the full and complete message of Islam not straightforwardly recorded within the Holy Qur'an itself?

Why is it left to the native human scribes who are never immune to socialization and

prejudicial artifacts themselves in the best case, and self-interest in the worst?

Was the *Sunnah* of the Prophet of Islam merely intended to be ephemeral, temporal, only binding upon the then existing people for the limited lifetime of the Exemplar, and not of any pertinence to subsequent generations of Muslims? If the *Sunnah* was of pertinence in perpetuity, then why was it not recorded in the same Holy Qur'an for the same degree of its preservation as the verses of the Holy Qur'an themselves, especially when the command obedience to both is on par?

Did the Author of the Holy Qur'an who claims to be the Creator of mankind, not know that its recording will be at the capricious whim and fancy of the rulers, the obliging narrators, and subject to the artifacts of historicity, hagiography, and other narrative vestigials under the forces of socialization, coercion, perception management, hidden motivations, human weaknesses, and the cumulative hystereses of cultural memories of every group and sect who'd be passing it on as legacy to the next generation? That, noisy cultural texts susceptible to myth amplification and all inconvenient truth attenuation, would become the key source of interpretation of the pristine guidance to mankind, a perfection, as claimed by the Holy Qur'an?

Or, as Mr. Spock reasoned, is the Holy Qur'an itself to be used to separate the chaff from the wheat? How is that possible to the same level of reliability for socialized texts written by fallible human scribes with hidden motivations and vested interests over a period of centuries, as the pristine text of the Holy Qur'an which all Muslims accept remains un-tampered by the hand of human scribes? Mr. Spock wondered how could a specification which claimed to be divine guidance for **هُدًى لِّلْمُتَّقِينَ** in which there was “**no doubt**”, require Muslims in subsequent generations to put their faith in the hands of these scribes of history whose mother's name they even did not know? It was illogical.

Mr. Spock pondered at the stark contrast between this, and the Holy Qur'an asking the people to put their faith in the Prophet of Islam who, as was observed in the Holy Qur'an, not only belonged to a well known prophetic pedigree, but as the historical narratives unanimously affirmed, within his own lifetime among his own peoples had been anointed “Sadiq” and “Ameen”, the most truthful, and the most trustworthy, by the peoples themselves even before he brought the Message of the Holy Qur'an to them.

No such guarantees are vouchsafed for these largely unknown scribes of history who claim to have gathered the *Sunnah* of the Prophet of Islam some two centuries later amidst the cloud of internecine violence and tyrannical rulers – and as Mr. Spock reasonably asked, what value is anyone's piousness to another, except to oneself? In any case, how can

anyone judge another's piety, intentions, hidden motivations, proclivities, bent of mind? By how many times they are reputed to have bowed in prostration? Besides, they could be blithering idiots, *house niggers*, or Machiavellis and still live on their forehead. There are plenty of Muslim Stooges in the Service of Empire in every epoch. Society today lends substantial empiricism to hold that conclusion. See for instance, [Response to the Fatwa on Terrorism in the Service of Empire](#) as an example of a Muslim cleric's selective story-telling to service empire. He was rewarded with a place-seating next to the massa at the 2011 World Economic Forum in Davos, Switzerland. His 600-page Fatwa on Terrorism was published with much fanfare in the UK and will survive as long as the empire needs the 'war on terror'. Anyone examining that document a hundred years from now will firmly believe in that narrative, penned by a Muslim scholar no less, for there won't be any dissenting voices on the bookshelves deconstructing its egregious omissions of vile servility to empire. Arguably, the survival of the names of Muslim scribes and their prodigious works through the vicissitudes of history had a lot more to do with ruling interests, than necessarily their own merit.

It is visible even today for works of scholarship which tend to never make it to the bookshelves, or simply disappear even from prestigious libraries, if they oppose the paradigms of ruling interests. The books listed in Recommended Reading is evidence of that tortuous fact. Except for one, I believe all are out of print, and rarely available even in public libraries. They might even disappear from the Internet someday and possessing them may even be deemed a *thought crime*, just as is depicted in the fable by George Orwell, 1984.

And behold, Mr. Spock, while diligently perusing the Holy Qur'an, encounters this remarkable warning by the Author of the Holy Qur'an to precisely clarify just this matter, almost as if it was waiting there patiently all this time for someone like Mr. Spock to precisely ponder that dilemma:

“(On the day) when those who were followed disown those who followed (them), and they behold the doom, and all their aims collapse with them. And those who were but followers will say: If a return were possible for us, we would disown them even as they have disowned us. Thus will Allah show them their own deeds as anguish for them, and they will not emerge from the Fire.” (Surah Al-Baqara, 2:166-167)

إِذْ تَبَرَّأَ الَّذِينَ اتَّبَعُوا مِنَ الَّذِينَ اتَّبَعُوا وَرَأَوْا الْعَذَابَ وَتَقَطَّعَتْ بِهِمُ الْأَسْبَابُ

وَقَالَ الَّذِينَ اتَّبَعُوا لَوْ أَنَّا كَرِهْنَا لَنَا كَرِهًا فَنَتَّبِعَهُمْ مِثْلَ مَا اتَّبَعُوا مِنَّا فَكَبَرُوا كَذَلِكَ يُرِيهِمُ اللَّهُ

أَعْمَالُهُمْ حَسْرَاتٍ عَلَيْهِمْ وَمَا هُمْ بِخَارِجِينَ مِنَ النَّارِ

So here we have a self-proclaimed Divine Guidance System which is not fully specified, requiring going to a multitude of human scribes outside the Holy Qur'an to learn the *Sunnah* of the Prophet of Islam, while its Author simultaneously issues the warning not to follow others (blindly). Also see the earlier cautionary discussion on verse 17:71 above.

Then whom to follow? Where to get the *Sunnah* from? How does one differentiate between following blindly and following due to socialization? Aren't they exactly the same thing? How does one tell fact from fiction, mis-interpretation from dis-information, plausible sounding from actuality, in the presence of Machiavelli who can enact *prisoners of the cave* generations downstream by the fiat of writing the historical narratives of its liking? Besides, the natural process of myth amplification, inconvenient truth attenuation, even when empires are not built upon it, makes parsing of any history always tentative, and seldom definitive. Even incontrovertible facts can be cradled in differing contexts to give them different meanings and justifications out of vested interests.

Furthermore, not everyone in mankind has the natural skills to be a doctor, scientist, or engineer, anymore than the ordinary peoples among the masses have the time or the talent to become scholars of the Holy Qur'an and study all matters for themselves first hand. Therefore, most are naturally inclined to follow "experts" whom they revere. These "experts" themselves, as human beings, are always constrained by the socialization and historical narratives passed onto them from previous scribes. The admonishment in the above quoted verses 2:166-167 applies in this context to both the "expert" and the laity following them, as the honest "experts" too, sensibly, have presumably followed someone else to get their data and not just invented their own (i.e., speculated, which the subsequent generation of scribes then take as gospel truth leading to more myth and noise amplification).

What a conundrum! Another puzzle for Mr. Spock's puzzle stack. He consciously refrained from leaping to the most obvious logical conclusion that verse 4:59 was only temporal for the time and age of the Prophet of Islam. Mr. Spock realized that he lacked the positive evidence and fuller comprehension of the Holy Qur'an to reach such a logical conclusion. But the mathematical incompleteness of this system is inherent, and Mr. Spock could not escape that obviously compelling logical deduction. That observation was obvious to him because he understood mathematical closure. It is like having a closely guarded pristine cipher (the Holy Qur'an) protected by an un-challengeable superpower (Allah), while leaving its cryptographic keys (*the Sunnah*) in the protection of the noisy press (the scribes of history) which can publish whatever it wants under the supreme orchestration of the

## Mighty Wurlitzer.

Unless of course, these apparent cipher keys to the elusive door past which one can't see, are irrelevant to deciphering the cipher by succeeding generations. Perhaps some other keys within each human being is to be utilized – such as engaging the right-half brain for spiritual reflection and intuition (which Mr. Spock of course is not capable of, but he did not deny its existence and the superior abilities it conferred upon Captain Kirk, and nor its utility in commanding a Starship, and nor it being the official requirement for holding the position of command as the captain of a Starship, which Mr. Spock consequently did not hold and remained just the indispensable logical science officer).

Given the assurance of the Holy Qur'an that it contains all the necessary and sufficient criterion for evaluation and adjudication of all pertinent matters, Mr. Spock decides to dig deeper more systematically.

He decides to identify all that is precisely knowable, and all that which is not precisely knowable, from the text of the Holy Qur'an alone. A study such as this would exactly delineate all the vicarious notions Muslims have about Islam which are not explicitly contained in the Holy Qur'an, or only ambiguously specified by its Author and open to interpretation and socialization, creating the unnecessary and illogical fracture lines among the **أُمَّةٌ مُسْلِمَةٌ** even when they are supposedly following the same textual Holy Qur'an!

This is empirical and not speculation since no such divisions evidently existed on the surface while its Exemplar was still living among the Muslims and able to forcefully arbitrate on all matters in which the early Muslims might have disputed based on the authority vested in him by verse such as 4:59.

But the moment the Messenger is gone and the burden is put upon the Muslims to arbitrate themselves based on the *al-Furqaan*, the criterion, left behind by the Messenger, disputes, interpretations, mis-interpretations, some deliberate borne of vested interests, others natural borne of ignorance, arose directly due to the fact of these gaping holes present in the Holy Qur'an.

Evidently, as was gleaned by Mr. Spock by examining the sociological context, some concerted efforts were made by the rulers to not document and write down the Prophet's rulings and explanations on all Qur'anic matters after his death. The argument speciously put forth by many an apologetic scholar of antiquity being, to seemingly protect the statements of the Holy Qur'an from being confused with those of the Messenger's by the uneducated public, for had the Author of the Holy Qur'an wanted, they argued, It would

have made the Messenger's statements part of the Holy Qur'an ab initio.

The sophistry of these apologetics for not immediately preserving and writing down the binding rulings of the Exemplar after his death in a separate compilation from the Holy Qur'an in order to prevent them from being lost to the vicissitudes of time, was not lost on the sophisticated Mr. Spock. But something else also puzzled him.

To Mr. Spock's logical and scientific mind attuned to studying complex specifications from which even the most sophisticated and enduring material systems could be fabricated by very large teams of different beings on different planets and still have the designs pass the interoperability tests to function as specified in a working system, there appeared to be too many unknowns in this **هُدًى لِّلْمُتَّقِينَ** , divine specification for the guidance of mankind, for any reasonable interoperability as a single **أُمَّةً مُّسْلِمَةً** , its own stated goal.

To Spock, ambiguity appeared to be a **specification objective by design**. It could have been trivially addressed ab initio, had the Author of the Holy Qur'an wanted to address it unambiguously. Namely, have the Holy Qur'an contain all which Mr. Spock identified as missing but logically necessary for its completeness and self-sufficiency by its own Qur'anic metric, for comprehensibility by all without leaving its pristine pages. Then, there'd there would have been no fracture lines among the Muslims.

Indeed, why have divine guidance in the first place if it is to remain ambiguous, is a dogged question which arises in any logical mind.

As Mr. Spock began to comprehend the sociological contexts and the turbulent times which cradled the first 200 years of the death of the Messenger, he put the following hypothesis on the puzzle stack for further examination: Was it this deliberate ambiguity in the specification which enabled the Holy Qur'an itself to survive the early power struggles, the vicissitudes of empires and kingdoms, after the death of the prophet of Islam, such that today, fourteen centuries into the advent of Islam, all Muslims of every race, ethnicity, culture, language, and geographic origin, emphatically assert that there is no "tahrif" (changes) in the text of the Holy Qur'an like the scriptures of the past? That, unlike other holy books of antiquity, Muslims' remains un-tampered by the hand of man such that even today, one can glean the same pristine text with certainty! (See facts on Qur'an compilation and footnote[5] in [Islam and Knowledge vs. Socialization](#))

And Mr. Spock confirmed this most unusual fact by examining the many different editions of the Arabic text (in differing scripts) and the Arabic aural recitations of the Holy Qur'an in the ship's library. They were identical. There did not appear to be any equivalent of the King

James Version, the Gideons International Version, the New International Version, the Babylonian Talmud, the Sanhedrin Talmud, Mishneh Torah of Maimonides, the Five Books of Moses in the Old Testament with the Christians, the Five Books of Moses in the Torah scriptures with the Jews, etceteras. The Arabic text of the Holy Qur'an was identical no matter which Muslim culture, sect, and epoch had published it in the written and aural mediums. Mr. Spock could only exclaim: *fascinating*.

And Spock further confirmed his analysis that in the vast majority of instances, the expositions on the Holy Qur'an and the Prophet of Islam written by scribes throughout the ages more or less differed exactly along the holes and ambiguities in the Holy Qur'an itself that he had identified.

Mr. Spock noted that there are 114 Chapters called Surahs comprising 6236 verses, with topics not necessarily contiguous even in the adjacent verses, or even within a Surah, and there is no explicit indication that a verse is co-related to another verse within the Holy Qur'an. He also noted that within a verse, a verse fragment could be speaking of some entirely new topic from the rest of the verse. Mr. Spock further discovers that the subtleties of Arabic grammar enabled changing the point of reference suddenly and it wasn't obvious who or what those new points of reference were without the localized context. He wondered whether such context was perhaps attainable by acquiring the lingua franca of the epoch. Mr. Spock had already recognized that he would also have to study the epoch of the time when the Holy Qur'an was revealed to acquire its sociological context. The task of studying the Holy Qur'an had suddenly become monumental and not at all akin to the straightforward reading of Milton, Plato, Shakespeare, or the DMV driver's manual.

Nevertheless, intrigued by the total lack of traditional structure and visible cohesiveness to the Holy Qur'an normal to any system specification where everything pertaining to that specification is usually clearly and unambiguously specified within the specification itself without requiring reference to vicarious outside sources to ascertain them, Mr. Spock decided to treat his study akin to solving a most complex puzzle under time pressure. He began his systematic analysis by classifying the text of the Holy Qur'an according to the following nomenclature:

**Determinate:** A topic, or the full meaning of a verse or verse fragment, in context, is fully determinable from the full context of the 114 Surahs of Holy Qur'an.

**Indeterminate:** A topic, or the full meaning of a verse or verse fragment, in context, cannot be fully established from even the full context of the Holy Qur'an due to insufficient information in the Holy Qur'an.

**Layered:** A topic, or word, or verse, or verse fragment, or context has obvious or un-obvious multiple bindings or points of reference, and which meaning or point of reference is implied in a given context is Indeterminate.

**Nuanced:** A topic, or word, or verse, or verse fragment, or context is highly nuanced, even when not Layered (i.e., it has exactly one applicable meaning from a plurality of nuanced meanings in the language of exposition), and the context for the nuance is Indeterminate.

### **Sociological factors and un-preservation of the context of the verses of the Holy Qur'an**

Being a well-traveled science officer aboard the Starship Enterprise and having visited many different worlds and civilizations in their differing stages of sociological development throughout the traversable universe, Mr. Spock is well aware that the general knowledge of history and other sociological material can always lend some context to any matter when it pertains to living creatures.

But Spock is also well aware from the blood-drenched history of early civilizations that history is typically written by the victors of history. Only the works of those scribes typically survive in the libraries or in the cultural memory of the majority of the people, who either echo, or don't challenge, the core-axioms of the victors. All narratives consequently harbor a germ of untruth and falsehood in them even when they appear to narrate honestly, due to ingrained biases, vested interests, loyalties, infidelities, and other psychologically and sociologically induced tendencies of the living authors. Mr. Spock also well understood that this characteristic was common to most if not all species in the universe he had visited. Even the history of his own planet, despite being all logic and event based, was not devoid of falsehoods and power-plays of hidden motivations of his peoples – for good and evil are merely tools for the superior intellect to achieve their end. Whether an end is noble or not is merely the moralizing semantics put on it by those who wish to see them in that light. Whereas, these have no a priori moral and spiritual bounds put on them by beings who lack the right-half brain function to feel and to moralize. (See Morality derived from the Intellect leads to Enslavement!)

In addition, human beings especially are most subjective. Mr. Spock well knew that humans have feelings, emotions, loves, hates, and hidden motivations which weren't always logical or quantifiable or even observable except by forensic examination, and that these subjective tendencies naturally color their perception of events and epochs which they record no differently than those who sanction the history. No scientist, historian, and sociological commentator is immune from it with the consequence that myths and



falsehoods get amplified with successive generation of historians just as much as unpopular truths get attenuated.

For the case at hand, Mr. Spock discovers that no written records exist of the early period of the advent of Islam until after about 200 years of the death of its Prophet. Several generations until then, as was noted by the first historians writing of that period some two centuries later, had carried the *Sunnah* of the Prophet of Islam, the Qur'anic directive “*Obey the Messenger*”, in their cultural memories, or word of mouth, and passed them from father to son, mother to daughter, generation after generation, due to the tyranny of the Muslim rulers who were crafting dynastic empires on Islam. These rulers, it was evident, had themselves sanctioned historical narratives and compilations of *Sunnah* which were not inimical to their own ruling interests.

Nevertheless, Mr. Spock also realized that facts are facts. And so he began searching the vast computer libraries of millions of books on Islam written from its earliest days in search of what might be unarguable, reliable, and authenticated facts and events pertaining to the epoch of the first few centuries of the Messenger of the Holy Qur'an to lend some sociological context to his study. To further identify what is a real fact vs. merely a narrative which might or might not be true, Spock clarified his thinking thusly. He took the most shocking example of a fact to delineate what he considered incontrovertible fact vs. merely a historical narrative.

### **A Case Study to Illustrate the Matter, the Difficulties, and the Forensic Approach to Resolving them**

**An incontrovertible fact is of the following type:** The historical narrative indicated that a Muslim ruler, in 680 AD, slaughtered Hussein ibn ‘Alī ibn Abī Ṭālib, the revered grandson of the Prophet of Islam, along with many other male members of his family including children. And this act transpired despite the Author of the Holy Qur'an's remarkable and explicit commandment to Muslims to both honor the Author's Messenger, and to honor and love the Messenger's “near of kin”, which obviously includes his progeny:

'Say: “No reward do I ask of you for this except the love of those near of kin.” (Surah Ash-Shura 42:23)

قُلْ لَا أَسْأَلُكُمْ عَلَيْهِ أَجْرًا إِلَّا الْمَوَدَّةَ فِي الْقُرْبَىٰ

Evidently, even to the untrained prima facie eye, never mind to the super-trained mind of a forensic detective of history like Mr. Spock, something major appeared to have gone

systemically wrong after the death of the Prophet of Islam. Only within the passage of a mere sixty years, matters came to this criminal abhorrence of internecine Muslim upon Muslim state violence inflicted upon the family of the Messenger. And this despite the most lucid and clear-text commandment of the Holy Qur'an to the Muslim polity: **'Say: "No reward do I ask of you for this except the love of those near of kin."**

The reasonable question arose in Mr. Spock's mind: why this commandment to honor and love the Exemplar's progeny, his "zurriyat", those near of kin, **فِي الْقُرْبَىٰ** ? What is so special about the Prophet of Islam's kin? And again, what is the purpose for loving them? Note that in this verse there is no command to obey them. It is to actually love them, **الْمَوَدَّةَ** , with emotional content. Rather unusual to ask people to love someone else's progeny. What is the context for showing such love and faithfulness to them?

Indeed, much preference and affinity is shown for the family of the Prophet of Islam by the Author of the Holy Qur'an, by referring to them as **أَهْلَ الْبَيْتِ** , *Ahlul Bayt*. and sanctifying them with a **وَيُطَهِّرْكُمْ تَطْهِيرًا** , a thorough purification:

"And stay quietly in your houses, and make not a dazzling display, like that of the former Times of Ignorance; and establish regular Prayer, and give regular Charity; and obey Allah and His Messenger. **And Allah only wishes to remove all abomination from you, ye members of the Family, and to make you pure and spotless.**" (Surah Al-Ahzaab, 33:33)

وَقَرْنَ فِي بُيُوتِكُنَّ وَلَا تَبَرَّجْنَ تَبَرُّجَ الْجَاهِلِيَّةِ الْأُولَىٰ وَأَقِمْنَ الصَّلَاةَ وَآتِينَ الزَّكَاةَ  
وَأَطِعْنَ اللَّهَ وَرَسُولَهُ ؕ إِنَّمَا يُرِيدُ اللَّهُ لِيُذْهِبَ عَنْكُمُ الرِّجْسَ أَهْلَ الْبَيْتِ وَيُطَهِّرَكُمْ  
تَطْهِيرًا

Why is the Prophet's family so important to the Author of the Holy Qur'an, persisted Mr. Spock? Why is the Prophet's *Ahlul Bayt* given such preeminence based merely on their DNA, as it would appear?

It begs the obvious question: Why are the *Ahlul Bayt* chosen by the Author of the Holy Qur'an and sanctified specially with such a profound divine benefaction in the verse fragment of 33:33: **"Allah only wishes to remove all abomination from you, ye members of the Family, and to make you pure and spotless"**, **إِنَّمَا يُرِيدُ اللَّهُ لِيُذْهِبَ** , **عَنْكُمُ الرِّجْسَ أَهْلَ الْبَيْتِ وَيُطَهِّرَكُمْ تَطْهِيرًا**, and no one else is chosen for this benefaction, for this purification, from among the vast number of respected companions of the Prophet of Islam?

Besides, what did this unusual “purification” actually mean in the language of the Holy Qur'an? How should it be correctly interpreted from its cipher-text form?

To Mr. Spock, preference for a choosing a particular family and lineage, a particular strand of human DNA above all the nations, and continuing to choose from that strand generation after generation, appeared to play a principal role in the overall provenance and sequence of divine guidance by the Author of the Holy Qur'an:

“Surely Allah chose Adam and Nuh and the descendants of Ibrahim and the descendants of Imran above the nations. **Offspring one of the other**; and Allah is Hearing, Knowing.” (Surah Aal-e-Imran 3:33-34)

إِنَّ اللَّهَ اصْطَفَىٰ آدَمَ وَنُوحًا وَآلَ إِبْرَاهِيمَ وَآلَ عِمْرَانَ عَلَى الْعَالَمِينَ  
ذُرِّيَّةً بَعْضُهَا مِنْ بَعْضٍ وَاللَّهُ سَمِيعٌ عَلِيمٌ

“And when his Lord tried Ibrahim with certain words, he fulfilled them. **He said: Surely I will make you an Imam of men. Ibrahim said: And of my offspring? My covenant does not include the unjust, said He**” (Surah Al-Baqara, 2:124)

وَإِذِ ابْتَلَىٰ إِبْرَاهِيمَ رَبُّهُ بِكَلِمَاتٍ فَأَتَمَّهُنَّ قَالَ إِنِّي جَاعِلُكَ لِلنَّاسِ إِمَامًا قَالَ وَمِنْ ذُرِّيَّتِي قَالَ لَا يَنَالُ عَهْدِي الظَّالِمِينَ

So, once again encountering a preference for a specific family, the *Ahlul Bayt*, which Allah chose in 33:33 for a thorough purification, and in 42:23 commanded the Prophet to tell the people to love his “**those near of kin**”, was not unusual to Mr. Spock’s perceptive mind. It followed a consistent pattern, that the Author of the Holy Qur'an chose whomsoever as His Messengers, Exemplars, and Imams above all the other peoples. And verses 3:33-34 and 2:124 unambiguously and unequivocally indicated the Author's particular preference for a very specific lineage starting from Prophet Adam, “**Offspring one of the other**”, to choose Prophets and Imams from among that lineage only, to bring His divine message to all peoples among mankind (see verse 10:47 quoted above, and many others like 16:36 “*And verily We have raised in every nation a messenger, (proclaiming): Serve Allah and shun false gods*”). The Author's preference for the Prophet of Islam's *Ahlul Bayt* in verse 33:33 was from the same DNA strand of Prophet Ibrahim. Which, according to verse 2:124, *قَالَ إِنِّي جَاعِلُكَ لِلنَّاسِ إِمَامًا قَالَ وَمِنْ ذُرِّيَّتِي قَالَ لَا يَنَالُ عَهْدِي الظَّالِمِينَ*, was also going to spawn Imams of the people throughout the ages in Prophet Ibrahim's progeny.

Mr. Spock noted that verse 2:124 proffered an unambiguous criterion for such appointment.

That, if there were to be any divinely appointed Imams among the people of Arabia, they had to emerge from the genetic seed of Prophet Ibrahim only, as per the Author's Promise to Prophet Ibrahim. That criterion was just as applicable to the Prophet of Islam as to his *Ahlul Bayt*. Mr. Spock ascertained from the historical record that Prophet Muhammad was considered a descendent of Prophet Ibrahim by the people of Arabia, coming from the distinguished family of Bani Hashim, and the Author of the Holy Qur'an attested to the fact that Prophet Muhammad was indeed a descendent of Prophet Ibrahim by the act of choosing him over all others in Arabia as His Messenger. Therefore, if there were to be any additional leaders and Imams from the *Ahlul Bayt*, reasoned Mr. Spock, they also had to be from Prophet Ibrahim's progeny. This criterion immediately excluded Prophet Muhammad's many wives none of whom were known to come from the Prophetic seed of Ibrahim. Thus, any which way Mr. Spock looked at it, this latest show of preference for the Prophet of Islam's *Ahlul Bayt* for a thorough purification was entirely self-consistent with the Author's narrative in the Holy Qur'an. But it begged the question for what purpose?

Because, after all, verse 5:3 quoter earlier had already categorically asserted that the Qur'an was completed in the Prophet's own lifetime: *"This day have I perfected your religion for you, completed My favour upon you, and have chosen for you Islam as your religion."*

With just a moment's logical reflection it became self-evident to Mr. Spock that:

- 1) by the categorical statement of 4:59, that there existed some unnamed persons besides the Messenger, **"those charged with authority among you"** to whom obedience was made obligatory ;
- 2) by the criterion of 2:124, that the Author intended to make leaders and Imams only from the seed of Ibrahim ;
- 3) by the benefaction of 33:33, that the *Ahlul Bayt* were elevated above all others with a thorough purification ;
- 4) by the commandment of 42:23, that the people were asked to love and honor the Messenger's near of kin ;
- 5) and in the light of 5:3 that the religion of Islam had been "perfected" ;

there was a pretty clear logical conclusion for the simultaneous presence of **"those charged with authority among you"** apart from the Messenger.

That, the Author of the Holy Qur'an had provided to the people additional Exemplars, Imams, from the Household of the Prophet besides the Prophet of Islam, who were meant to continue teaching to the people the "perfected" religion which Prophet Muhammad had brought to them as the Messenger, even after the Messenger was no longer among them.

This is remarkable discovery – if it could be determined to also be supported empirically – for, as Mr. Spock ascertained perusing the historical record of early Muslim empires, few Muslims living under their dominions seemed to have been aware of this rather straightforward logical conclusion despite it being promulgated in the Holy Qur'an in clear-text, and despite their daily recitation of the Holy Qur'an with the most ardent religious fervor!

It was almost as if, observed Mr. Spock, this logically derived conclusion had been masked off from the public under the ruling paradigms of caliphs and dynastic empires.

Even today, lamentably, few Muslims are aware that this is a conclusion adduced directly from the statements and the logic of the Holy Qur'an without making any recourse to outside sources.

The most puzzling question of course persists. Who exactly are ***“those charged with authority among you”***. The eligibility criterion of 2:124 and 3:33-34 come only one step closer in the direction of identifying them. That eligibility criterion indicated to Mr. Spock that the only persons eligible for this divine appointment of leadership, ***“those charged with authority among you”*** to whom obedience is made as obligatory as to the Prophet of Islam, must come from the *Ahlul Bayt* and no where else. Because, only that singular family automatically includes both the seed of Prophet Ibrahim and the seed of Prophet Muhammad, ***“Offspring one of the other”***. It also lends sensible context to why the people are commanded to love the Prophet's near of kin. Even the way it is propositioned to the people by the Author of the Holy Qur'an is revealing of its motivation: ***'Say: “No reward do I ask of you for this except the love of those near of kin.”'***

The Prophet is asked to demand the love of his near of kin as a gratitude from the people – not as a favor the people are asked to do the Prophet, but in return for the favor done to the people by the Prophet of Islam of being God's Messenger among them! In other words, it is an obligation put on the people to love the Prophet's near of kin! The logical connection among the many verses outlined above, and making the love and affection of Prophet's near of kin an obligation upon the people thus making it psychologically easier for the people to accept Exemplars from among the *Ahlul Bayt* following their appointment, conclusively indicated to Mr. Spock that ***“those charged with authority among you”***

could only be from among the *Ahlul Bayt*. But who among the *Ahlul Bayt* meets that criterion? Mr. Spock already knew who doesn't meet the criterion, the Messenger's wives.

Furthermore, Mr. Spock, simply on the anvil of pure reasoned logic applied to *al-Furqaan* (see discussion of verse 25:1, Surah al-Furqaan quoted above), could straightforwardly deduce additional eligibility criterion to further narrow down the field. That, as per verse 4:59, any such persons to whom command obedience is extended from the Prophet of Islam as an Exemplar of the Holy Qur'an, must also be Exemplars of the Holy Qur'an themselves! That conclusion is simply inescapable. Because, as Mr. Spock reasoned, they couldn't be just any prominent persons occupying the throne or the pulpit, no matter how learned or respectable, for in order to have command obedience to them as per verse 4:59, they'd have to possess knowledge of the divine message of the Holy Qur'an to the same level of un-erring comprehension as the Prophet of Islam! Otherwise, they could possibly misinform and misguide the people using their own interpretation. The logic of that conclusion is also undeniable. Mr. Spock reasoned that these could only be persons who were specially favored by the Holy Qur'an to be un-erring – that being the primary logical criterion to being an Exemplar of the Holy Qur'an in order to faithfully convey the message of the Author to the people. That second deduction is also simply logical. The verse of purification 33:33 arguably conveys at least some sense of bestowing un-erringness, further affirming that **“those charged with authority among you”** could only be peerless and un-erring scholars of the religion of Islam from among the *Ahlul Bayt*. For only such persons could even be eligible to be the subsequent Exemplars, Imams, of the people after the Prophet of Islam.

The successive application of Qur'anic eligibility criteria had narrowed down the search considerably for Mr. Spock to identify **“those charged with authority among you”**.

However, as Mr. Spock knew, meeting a criterion only determines eligibility. It does not necessarily indicate appointment. For that, one needs explicit evidence of appointment – some empirical evidence – not mere statements in the Holy Qur'an and logical deductions from them even though, such reasoning is necessary as a qualitative criterion. It helps one exclude persons who might be presumptuous enough to claim the entitlement. While it may be argued that after everyone else is excluded, those who remain standing are automatically selected, but empirical affirmation demands explicit evidence of specific appointment and clear identification. Especially when the matter is made contentious and under the full rubric of empire which controls all the dominant narratives.

If this matter was important to the Author, Mr. Spock pondered, why aren't the names of **“those charged with authority among you”** explicitly mentioned in the Holy Qur'an?

How are people in subsequent generations to know their identity without relying on the doubtful and partisan pens of the scribes of history?

Mr. Spock reasoned that unless the Messenger had shirked his duty to the Author of the Holy Qur'an, in which case verse 5:3 would not exist affirming the completion and perfection of the delivery of the message of Islam as a "deen" for mankind, he must have categorically informed the people of Arabia, the first Muslim generation, of all the unknowns noted above. Specifically, who had the entitlement to be included in that characterization of *Ahlul Bayt*, أَهْلَ الْبَيْتِ , for whom "**Allah only wishes to remove all abomination**", and the exact identity of "**those charged with authority among you**" whom the Muslims had to obey on par with himself.

The people of the time would have also naturally known who the Messenger's near of kin were whom they were asked to love as a mark of gratitude to the Prophet by divine commandment, by the simple virtue of the fact that the Prophet of Islam and his family lived among them his entire life. It is logical to presume, reasoned Mr. Spock, that the Messenger would have been asked by new Muslims coming from elsewhere, on hearing this verse, about the identity of who his near of kin were, and who "**those charged with authority among you**" were, and the Messenger of course would have hastened to inform them personally in order to discharge his duty faithfully as the Messenger. How are we to know all that today? By leaving all this knowledge out of the pristine un-tampered pages of the Holy Qur'an, pondered Mr. Spock, why deny that certainty of knowing about this possibly momentous matter to subsequent generations of Muslims and leave them pitifully at the mercy of the doubtful scribes of history and their partisan pens?

Mr. Spock muses how he could precisely learn the identity of "**those charged with authority among you**". Were there other straightforward verses in the Holy Qur'an which enabled and assisted in their further identification? Without the correct context for the verses which spoke in indirections and in unknowns, as verse 4:59 did, how was one to even identify such verses that spoke to their identity? Perhaps there were some other incontrovertible facts in recorded history, despite the partisanship of scribes and imperial craftsmanship – like the fact of the slaughter of the Prophet's progeny by the Ummayyad army already cited above to which there can be no doubt that it transpired in history – which assisted in unequivocally affirming their identity?

Mr. Spock began to realize that this puzzle was almost akin to solving a system of linear equations with several unknown variables, but which could only be solved if the number of equations were at least equal to the number of unknown variables. However, as already explored in depth in [Islam and Knowledge vs. Socialization](#), and alluded above by verses

like:

- **“One day We shall call together all human beings with their (respective) Imams”, (17:71) ;**
- **“If Allah had so willed, He would have made you a single people, but (His plan is) to test you in what He hath given you: so strive as in a race in all virtues. The goal of you all is to Allah; it is He that will show you the truth of the matters in which ye dispute.” (5:48) ;**
- **“And for every nation there is a messenger. And when their messenger cometh (on the Day of Judgment) it will be judged between them fairly, and they will not be wronged.” (10:47) ;**

the operative principle **“so strive as in a race in all virtues”** indicated many solutions, not just one, which could satisfy these equations!

It appeared to Mr. Spock that the Author had very astutely, and quite sensibly, accounted for socialization biases by offering mankind the core guidance: **“so strive as in a race in all virtues”**, and the conflict resolution principle when they differed: **“The goal of you all is to Allah; it is He that will show you the truth of the matters in which ye dispute.”**

Mr. Spock realized that he had made substantial progress already, and thus makes the assumption that it must be true that this puzzle of pertinence guidance is completely soluble by man in its cipher form, taking the Holy Qur'an at its word. Otherwise, he reasoned, the entire edifice of the guidance system to mankind proclaimed by the Holy Qur'an falls flat on its face. It becomes relegated to mean whatever anyone in power wants it to mean, or can write the dominant narrative for it which survives through history.

As per the first classification of the Holy Qur'an by Mr. Spock, as a cipher message of the Author to mankind that had to be decoded correctly, and therefore, was not open to individual interpretation or the recovery of the singular *plaintext* could be in error, Mr. Spock saw it being self-evident, that the correct meaning, interpretation, and understanding of the verses of the Holy Qur'an, in addition from the Prophet of Islam, and from the Holy Qur'an itself, could only be taken from these designated but unnamed persons as per the Author's declaration of obedience to them in 4:59. And not from just any pretentious scholar gurgling Arabic, or legitimately or illegitimately occupying the throne or pulpit of Islam.

This logical conclusion, argued Mr. Spock, is most significant and the key to the entire matter.



However, if, **“those charged with authority among you”** had been thrust aside or ignored after the death of the Messenger, their guidance not sought, not recorded, and not followed, then all the evil which followed from that first transgression of the first few generation of Muslims fourteen centuries ago accumulated into the greater whole of sectarianism and dynastic empires that have existed ever since. In other words, their crime was not mere disobedience, but a supreme crime as it contained within it the seeds of all the evil that followed, leaving Muslims today, as yesterday, a pathetic people mired in rituals, schisms, sectarian blood-shed, kingdoms, and servility to empire.

The fact that hardly anyone among the Muslim public outside of their myopic socialization biases is even aware of there being some specially designated (but unnamed) persons in the Holy Qur'an in addition to the Messenger who are meant to be its Exemplars after the Prophet of Islam, and obedience to them is made as obligatory as to the Prophet of Islam, lends credence to the logical surmising that **“those charged with authority among you”** must have been shunted aside by those coveting the highest pulpit of Islam. It explains the empirical observation that today each Muslim understands the same verses slightly differently. There are, and were, too many “imams” interpreting and explaining the Holy Qur'an by their own fancy and judgment, even vested interest, having lost or ignored the explanation and interpretation by its authentic stewards! Despite the *plaintext* warning to the people to be wary of such “imams”: **“One day We shall call together all human beings with their (respective) Imams”** (see verse 17:71 quoted above). Mr. Spock recalled with marvel the foresight of the Author of the Holy Qur'an: **“Surely We have shown him the way: he may be thankful or unthankful.”** (see verse 76:3 quoted above)

Given the documented reality of the ensuing power-struggle immediately after the death of the Prophet of Islam which pitted the family of the Prophet of Islam against the first Muslim caliphs, and the sociological context surrounding the events of power and its vile inflection in the name of God which culminated in the slaughter of the progeny of the Prophet of Islam and the emergence of the most abhorrent dynastic empires that led the Muslim world to its seven hundred years of unsurpassed global ascendancy among much internecine state violence, Mr. Spock realizes that objectively extracting incontrovertible evidence of the appointment of **“those charged with authority among you”** in order to establish their clear identity from the historical records of imperial craftsmanship and outright suppression for two hundred years, would be akin to extracting a weak signal from a vast sea of background noise in communication theory in electrical engineering!

Mr. Spock recognizes that he would have to be a forensic detective in order to recreate the fuller contexts for the understanding of the largely contextless verses of the Holy Qur'an. He also recognizes however that such a detective work would surely identify the principal

first cause of dissension among the Muslims which had led to all the subsequent multiplication into sectarianism. Identification and extraction of that principal first cause could be key to uniting the Muslims once again as they once were under the single banner of **أُمَّةٌ مُسْلِمَةٌ** during the lifetime of the Prophet of Islam. Mr. Spock quickly pushes this overarching puzzle on his evaluation stack.

Mr. Spock's puzzle evaluation stack is growing rapidly with his increasing understanding of the complexity of the issues... For, indeed, the narratives which survived past those early period are clearly partisan, with scribes and rulers taking sides as already noted. Thus the richer context for the verses of the Holy Qur'an is now deeply mired in this blood-drenched early history of the Muslims and cannot be straightforwardly extracted merely by perusing the early literature. As is the case for all such histories, even including the contemporary history examined in this volume under the orchestration of the *Mighty Wurlitzer*, myths get naturally amplified by successive generation of scribes, and facts and factors inconvenient to their narratives, or to their rulers, are naturally attenuated as already explained above leading to a *crippled epistemology* for those who study things on faith or without any forensic talent.

### **Summation and Impact Analysis**

In summation, so far, Mr. Spock, well-read in both the sociological histories of empires and their social engineering of the public, has recognized that all works outside of the Holy Qur'an (including the Holy Qur'an itself) have been composed in sociological contexts and not in an abstract or sterile vacuum free from the influence of the ruling paradigms. And that these sociological contexts are most essential to fully identify and perceptively comprehend, especially when the early history of the advent of religion of Islam after its Messenger's demise is soaked in so much internecine state violence and obfuscation. To understand those outside written works therefore, Mr. Spock ascertains that the full sociological context under which all these books on Islam were originally compiled, must first be understood – as facts in a void can convey any meaning its compiler wants. Therefore, Mr. Spock decides that facts alone will not be sufficient to establish clues to resolving the **Indeterminates** of the Holy Qur'an. That it would also be necessary to cradle facts in the rich sociological context and the narratives of history which caused the strange paradoxical artifact: that the Author of the Holy Qur'an chose not to protect its Exemplar's *Sunnah* within the Holy Qur'an itself but to which it issued command obedience as per 4:59.

Furthermore, that such historical facts would have to be not just cradled, but forensically cradled in the sociological realities of realpolitik forces and often unrecorded motivations which gave birth to those facts, and to their narratives, in order to fully comprehend them.

And Mr. Spock immediately surmises that as the evidence of history in every civilization indicates, these narratives too are invariably the sectarian narratives of partisans taking sides. Historians, compilers, exegeses writers, essayists and poets, all taking sides, omitting and attenuating facts and contexts inconvenient either to their narrative, or to their socialization bias, or to the sanction of the rulers under whom they scribed, while amplifying myths and opinions conducive to their narrative and socialization outlook whereby the victors ruled creating the facts on the ground, and the victims mourned exaggerating and perhaps mythifying the victimizing circumstances in cultural memory for centuries that might pale the Homer's Iliad by comparison. This natural cause and effect relationship of history, narrated by those most affected by it, on either side of it, becoming the de facto source of exposition and explanation of the **Indeterminates** of the Holy Qur'an as soon as one stepped out of its boundaries to figure out the unknowns.

The divine irony (or perhaps the divine comedy) poignantly strikes Mr. Spock's analytical mind: Mortal fallible pens seemingly *completing* a Book whose Author claims it is "**Perfection**" (5:3) and "**A Revelation from the Lord of the Worlds.**" (56:80).

To Mr. Spock's mind, prima facie logic alone would dictate not to use the fallible pens to parse the Infallible pen of the Author Who claims Itself to be Perfection Incarnate and the Lord of the Worlds. The Author of the Holy Qur'an is so assertive of the perfection of His Word that He asserts repeatedly, as in verse 2:2, that it is a Book in which there is no doubt, and a guidance to only those pious of heart who earnestly seek it. So why then use the fallible pen of scribes which is always full of doubt, to gain comprehension of the Infallible Words of the Author for which the Author asserts there is no doubt?

But the same Author has also, evidently by design, practically necessitated the very use of fallible pens by virtue of verses like 4:59 which create importance for the *Sunnah* of the Prophet of Islam on par with the Qur'an and to the obedience to it, but not recording those *Sunnah* within the pages of the Holy Qur'an and leaving the verses of the Qur'an as **Indeterminates**. This is a paradox in the Holy Qur'an.

This is why, Mr. Spock logically concludes, the Muslims from the very beginning had become preoccupied with the temporal, and often reactionary sociological contexts, deliberately drowning the holistic and timeless text of the Holy Qur'an by insisting on partisan hadiths, tafseers, and narratives of history penned in the fallible ink and cultural memories largely due to commandments like 4:59 which made the Holy Qur'an subject to easy abuse.

The Muslims, it became evident to Mr. Spock, through the subsequent generations after

the first, had paradoxically become its unwitting victims because they had insisted on following the commandment 4:59 of the Holy Qur'an to the letter, without understanding its accurate import in the larger context of the entire message of the Holy Qur'an. And they used the scribes of history literally, along their own socialization axis, becoming putty in the hands of rulers who could trivially inflict internecine violence for political expediency upon those who fell out of favor.

The Muslims had not bothered to elevate themselves beyond the baggage of their respective narrow socialization which often leads to close-mindedness, and partisanship.

Their collective understanding of Islam in the successive Muslim empires and subsequent servile civilizations had therefore become ossified in the imperial narratives of history expounded from the "Roman pulpit", and in reaction to it in its many "Protestant movements", rather than become progressive and egalitarian based on the sublimity of its timeless doctrines principled in the Holy Qur'an. What had been intended as a sublime force of transformation for the evolution of societies from its barbarisms and exploitations to an enlightened state of mankind's existence over time, had become the force majeure for building enduring empires instead.

The Muslims had inexorably fallen victim to the same sort of corruption that was indicted by the Holy Qur'an about their cousins, the Jews and the Christians – the persistent distortion of the Author's message delivered to the Abrahamic seed! Except, in the case of the Muslims, they continued to claim in every epoch to possess the Author's Message in its unadulterated most pristine cipher form, and arguably so, but could neither decipher nor implement it effectively because of the hijacking that the Holy Qur'an itself permitted by virtue of it being a cipher rather than a straightforward *plaintext*! Even its very first chapter, Surah Al-Fatiha, which Mr. Spock observed was parroted daily by all Muslims who reverently bowed in prayer, was a mini cipher (see its examination in [Islam and Knowledge vs. Socialization](#)).

(The Holy Qur'an was certainly nothing like the *plaintext* Bible, the holy book of Captain Kirk of the Starship Enterprise, lamented Mr. Spock on recalling the fluency and the ease with which his human captain sometimes quoted from it to teach him interesting lessons in selflessness of the most sublime in human endeavors which Spock found perplexing due to his logic-only rational mind. It is interesting to footnote in passing however, that in this 1960s' fable that was turned into movies in the 1980s and 1990s, Mr. Spock gave his own life selflessly in one of them to save his spaceship in the *Genesis project*, making the rational irrefutable argument to his captain's chagrin and intense grief that in order for the Starship to continue its endless voyage of discovery of the cosmos, *the life of one over the*

*life of many is a purely logical decision.)*

How can this blatantly obvious self-contradiction, a macro puzzle, a paradox of the Holy Qur'an, have escaped the acumen of Muslim sages throughout the ages?

More pertinently, why had it not been resolved all this time?

## **How Islam became an empire**

To Mr. Spock's logical mind, if conundrums and paradoxes borne of pure logic of the matter cannot be resolved with logic alone, they remain perpetual conundrums, and therefore, always ripe for subjective interpretation and harvesting for narrow interests. Here was the principal reason, within the text of the Holy Qur'an itself, which continually leads to seeking and following material outside the confines of the Authorship of the Holy Qur'an. And no Muslim sage is inclined to address it!

Perceptive as he is, the motivation to not solve this paradox, especially during the heyday of Muslim civilizations, is now readily apparent to Mr. Spock. This persistent puzzle of the Holy Qur'an to Mr. Spock is indicative of both, the deep sociological contexts which cradled the message of Islam from its earliest inception to the present day, and its pathological transformation into enduring empires. As Mr. Spock dispassionately observed, the religion of Islam had been morphed into an unsurpassed absolutist system for the exercise of imperial power by Muslim rulers. Anyone on the throne and the pulpit could interpret the verses of the Holy Qur'an any which way they liked simply by making recourse to any outside text written by themselves, or by their own favored scribes, or to their own favored narrative of history. By thus fixing values of its **Indeterminates** to suit their narrow self-interests, it was easy to hijack Islam to one's primacy advantage.

The intoxicating, almost mesmerizing, effect the Holy Qur'an has upon the Muslim masses makes it especially easy to manipulate and control them by distorting the largely contextless verses of the Holy Qur'an and giving these any meaning that is expedient. Promising the masses Heaven in *After-life* for their sufferance of hell right here in this life. A messiah in the future who would free them of their misery and establish justice and equity if only they were patient in their afflictions and injustices here, and relegated themselves to dutifully mind their religious rituals instead. And, instead of challenging, enjoyed and participated in (or suffered in silence) the kingly opulence and tyrannical adventures of their rulers as it was indeed God who had appointed them the absolute sovereign. After all, didn't the Holy Qur'an unequivocally command Muslims to obey: **“those charged with authority among you”** and **“to be patient”**!

While musing this pathocracy of social control, Mr. Spock recalled a global primacy strategist's rational observations of absolutist empires which most aptly captured the global ascendance of these despotic Muslim empires:

“The earlier empires were built by aristocratic political elites and were in most cases ruled by essentially authoritarian or absolutist regimes. The bulk of the populations of the imperial states were either politically indifferent or, in more recent times, infected by imperialist emotions and symbols. The quest for national glory, "the white man's burden," "la mission civilisatrice," not to speak of the opportunities for personal profit—all served to mobilize support for imperial adventures and to sustain essentially hierarchical imperial power pyramids.”\*\*

The Muslim empires, with their absolute sovereignty ruthlessly secured in the name of Islam's “God” from domestic challenge, became great patrons of the arts, the sciences, and the humanities. They became the first to bring the translations of the works of the Classical civilizations into Arabic, from where it reached the Western shores centuries later. The enterprising and talented ones among the Muslim populations labored under the parallel personal motivations to impel empire forward as already explored in the *Fable of the Bees* for the modern contemporary times under Western empires. The pertinent verses from the Holy Qur'an that encouraged astronomy, the study of the cosmos, and the endless pursuit of knowledge ( **“and say: My Lord! Increase me in knowledge.”** Holy Qur'an, Surah Ta-Ha, 20:114 , Arabic: **وَقُلْ رَبِّ زِدْنِي عِلْمًا** ), helped propel Muslim civilizations to the forefront of global supremacy on all fronts – except the development of political thought, which had to await the Renaissance in the West during the Middle Ages.

Considering that the Muslims were the first to be exposed to Greek classics and to their Classical Hellenic culture of political self-empowerment (such as republic, democracy), egalitarian ideas of social justice (such as Solon's, considered among the ten greatest law givers of Athenian antiquity according to Plutarch's *Lives*), etc., for these socio-political ideas to have never taken root in absolutist Muslim civilizations, while they borrowed liberally from the math and sciences of antiquity, is revealing in and of itself. If one simply compares to today, the matters become patently obvious. Of the hundreds of living Nobel laureates in the sciences and humanities in America and the Western world, how many learned minds rose to challenge the empire's narratives of 9/11, or called it for its prima facie enactment, an inside job, or showed any skepticism when BBC reported the destruction of WTC-7 the same day a full twenty-five minutes before it collapsed into its own footprints, or forensically deconstructed the catastrophic terrorism of 9/11 to uncover and publicly proclaim that it was to launch *imperial mobilization* for one-world government?

These most brilliant high achieving minds of America, like the rest of the American masses caught between bread and circuses, watched their Western world descend into police-states, lose their vaunted civil liberties, stood meekly at airports first with shoes in hands, and subsequently permitting the villainous groping of their and their loved ones' private parts, all in the name of villainous absurdities. To this scribe's last count as of the year 2012 AD, exactly zero have arisen to call it for what it is, or handed in their vaunted Nobel prize in protest. This is not a singularity, but the norm for every empire from time immemorial. One cannot stand tall against the tyranny of ruling interests and thrive at the same time.

Mr. Spock perceptively observed with the precision of a sociologist and science officer, that a revolutionary religion, intended primarily for the transformation of man – both men and women – into the *perfectman* submitting wholly to its Creator “*bowing to Thy (Will)*”, and society into the perfect egalitarian system of social justice and sublime morality (as for instance had been noted by Solon in Athens a thousand years before Islam (Ibid.), and most succinctly outlined in Surah al-Asr, chapter 103 of the Holy Qur'an), had been trivially transformed on the one hand into the opiate of the people *waiting for Allah*, and on the other into a natural force for *imperial mobilization* throughout the ages!

No system of absolute rule, marveled Mr. Spock, has been able to surpass this tortuous mass control of the public mind that could so trivially persuade people to accept and enjoy their own servitude with just the mere promise of the *Hereafter* which not even the rulers, but their almighty God had undertaken to fulfill. The rulers got a free ride with no promises of their own to keep! Whereas today, a lot more sophistication and technical expertise, not to mention considerable expense and talent, is brought to bear to achieve the same effect under “democracy” (see The Mighty Wurlitzer), and a hell of a lot of bayonets under Stalinist like dictatorship.

This has been the real prime-mover behind the villainous history of the oft glorified Muslim empires of the past, where the first caliphate came into existence after the death of the Prophet of Islam under a cloud of dissent from the progeny of the Prophet of Islam, where the first Ummayyad Empire came into existence by killing the progeny of the Prophet of Islam, where the follow-on Abbasside empire came into existence on the pretext of rectifying the wrong done by the Ummayyads but then took over the *imperial mobilization* from where the previous tyrannical empire had left off. The Mongols conquered Eurasia, assimilated with the local population, and spawned the two new Muslim Empires of the Ottomans in Central Asia, and the Mughals in Persia and India. This is what Zbigniew Brzezinski wrote in *The Grand Chessboard* of their precursors, the Mongols' phenomenal conquest of Eurasia which gave birth to these Muslim empires:

“To find a somewhat closer analogy to today's definition of a global power, we must turn to the remarkable phenomenon of the Mongol Empire. Its emergence was achieved through an intense struggle with major and well-organized opponents. Among those defeated were the kingdoms of Poland and Hungary, the forces of the Holy Roman Empire, several Russian and Rus' principalities, the Caliphate of Baghdad, and later, even the Sung dynasty of China.

Genghis Khan and his successors, by defeating their regional rivals, established centralized control over the territory that latterday scholars of geopolitics have identified as the global heartland, or the pivot for world power. Their Eurasian continental empire ranged from the shores of the China Sea to Anatolia in Asia Minor and to Central Europe (see map). It was not until the heyday of the Stalinist Sino-Soviet bloc that the Mongol Empire on the Eurasian continent was finally matched, insofar as the scope of centralized control over contiguous territory is concerned.

The Roman, Chinese, and Mongol empires were regional precursors of subsequent aspirants to global power. In the case of Rome and China, as already noted, their imperial structures were highly developed, both politically and economically, while the widespread acceptance of the cultural superiority of the center exercised an important cementing role. In contrast, the Mongol Empire sustained political control by relying more directly on military conquest followed by adaptation (and even assimilation) to local conditions.

Mongol imperial power was largely based on military domination. Achieved through the brilliant and ruthless application of superior military tactics that combined a remarkable capacity for rapid movement of forces with their timely concentration, Mongol rule entailed no organized economic or financial system, nor was Mongol authority derived from any assertive sense of cultural superiority. The Mongol rulers were too thin numerically to represent a self-regenerating ruling class, and in any case, the absence of a defined and self-conscious sense of cultural or even ethnic superiority deprived the imperial elite of the needed subjective confidence.

In fact, the Mongol rulers proved quite susceptible to gradual assimilation by the often culturally more advanced peoples they had conquered. Thus, one of the grandsons of Genghis Khan, who had become the emperor of the



Chinese part of the great Khan's realm, became a fervent propagator of Confucianism; another became a devout Muslim in his capacity as the sultan of Persia; and a third became the culturally Persian ruler of Central Asia.

It was that factor—assimilation of the rulers by the ruled because of the absence of a dominant political culture—as well as unresolved problems of succession to the great Khan who had founded the empire, that caused the empire's eventual demise. The Mongol realm had become too big to be governed from a single center, but the solution attempted—dividing the empire into several self-contained parts—prompted still more rapid local assimilation and accelerated the imperial disintegration. After lasting two centuries, from 1206 to 1405, the world's largest land-based empire disappeared without a trace.” (pgs. 15-17)

Leaving behind their Muslim legacies, the Ottoman and the Mughal Empires. Little changed with their assimilation by the conquered peoples, as now these new absolutist regimes of the assimilated ruling class exercised ruthless power in the name of the same “God” of Islam, rather than formerly as the Central Asian Mongol barbarians. The Ottomans and the Mughals took imperial suzerainty from where the Umayyads, the Abbasides, and the Fatimides had left off, abusing Islam exactly as their predecessors, to inflict social control upon the masses in the name of “God”, and to infect the public with their own 'la mission civilisatrice' which supported imperial objectives, now largely held in check by the burgeoning European empire. And it is now, the contemporary history in the making of the Anglo Saxon's drive for a world government empire.

All principally enabled by the fracture lines among the Muslims themselves because of their slightly different theological understanding of the Holy Qur'an due to the open-ended interpretation of the verses of the Holy Qur'an that is possible, leading to losing the original message intended by the Author for the guidance to man. Once the Author's message is lost to individual interpretation, all the evil follows when the fault lines thus created fall into the grubby hands of *Supermen* and *Machiavelli* who know how to diabolically harness them in the name of “God” and “imperial mobilization”.

One can see perfect contemporary examples of the West's harvesting of Islam in Zbigniew Brzezinski crafting the Afghan Mujahideens in yesteryear as already examined in [Islam and Knowledge vs. Socialization](#). And today, in the crafting of 'militant Islam' vs. 'moderate Islam' Hegelian Dialectic, to create the “*revolutionary times*” necessary to seed the transformation into one-world government empire as already examined in [The Mighty Wurlitzer](#).

It is only that, the abuse of the religion of Islam as an unmatched force for absolute social control in the name of “God”, and not its lofty purpose, concluded Mr. Spock, which led the Muslims to dizzying heights of unsurpassed empires for over seven hundred years, from 700 AD to 1400 AD. Muslim empires limped along, often in the throes of mediocrity, in competition with the rapidly burgeoning Western hegemony in Europe for another five hundred years, until they were finally put out of their misery by an even more diabolical foe that had now surpassed the dynastic Muslim rulers in the arts and sciences of societal control and behavior manipulation. The authority of “God” was replaced with that of “Democracy”, and the pulpit by the *Mighty Wurlitzer*.

Why has the religion of Islam failed to transform society as it was intended, rather than be continually hijacked for “imperial mobilization”, pondered Mr. Spock.

The very concept of spiritual guidance in the Holy Qur'an is addressed to a very narrow audience, those who approach it with a “cleansed heart” (see detailed exposition in [Islam and Knowledge vs. Socialization](#)). The rest are destined to be misled, as per the many admonishing proclamations in the Holy Qur'an. But, as Mr. Spock already knew by way of considerable empiricism, no society, from time immemorial, possesses such wonderfully pious public with a “cleansed heart” in the majority! “Hegemony is as old as mankind”, and so is its power to corrupt and to co-opt. “Power corrupts, and absolute power corrupts absolutely.”

It is also an observed empirical fact that the general mass intelligence among human beings is rather low, irrespective of the civilization they belong to. A human philosopher had once captured this empiricism with wit: “most people rather die than think, and they do.”\*\*\*

Therefore, questioned Mr. Spock, how is this guidance of the Holy Qur'an which is initially meant for only a small minority among the public who are required to both reason and think, and also bring a “cleansed heart” to bear upon the divine message, supposed to transform the majority of the people in any society?

One brimming with unbridled optimism may perhaps blindly speculate that the first seeds of moral enlightenment among the minority will eventually germinate and percolate to the rest of society – the evolution of societies under Islam to their more egalitarian and sublime state of equity, social justice, and spiritual ascendancy – just like it arguably was on such a transforming path in the most backward piece of geography on earth at the time. In the desert of Arabia, when the Prophet of Islam established his ruling state in the small oasis called Medina during his own lifetime.

But not Mr. Spock, who had in fact been quite bored reading *Pollyanna* from the ship's library. He could already perceive that these are wonderfully lofty ideals of Islam no doubt, just like its predecessors' the Ten Commandments brought by Prophet Moses to the 'chosen peoples', and the 'love thy neighbor' Gospel brought by Prophet Jesus to their legatees subsequently known as Christians. None has transpired yet! But all have succeeded in leaving high-minded platitudes on elevated bookshelves of over 5 billion peoples who today claim to follow the Abrahamic creeds!

Practically speaking, reasoned Spock, if the masses are mainly unthinking creatures of habit and socialization, what does transformation really mean, apart from merely implanting new habits among the masses by social engineering – no cleansed hearts needed.

Mr. Spock is well aware that according to sociologists' empirical study of human societies still existing in the twenty-first century, at best less than 2% of the people think, about 8% think they think, and 90% wouldn't be caught dead thinking! In fact, stupider the masses, more gullibly they are led to any destination by the Machiavelli with social engineering, and with bread and circuses – and that has been a fact from time immemorial.

How can the Holy Qur'an counter that empirical reality among the wider populations of human beings with its platitudinous cleansed heart recipe? The way the Holy Qur'an is structured, that recipe principally requires the ability to think and to reason, like Mr. Spock's mind, while overcoming the chains of socialization put on the public from birth, in order to fully decipher the message of the Holy Qur'an.

But if not more than 2% of any human society realistically has such rational capacity at this stage of their human development on earth, as is empirically visible, genuine heart cleansing can only remain unimplementable. This implies that holding diversity of views and remaining fragmented is the only practical outcome for such primitive societies, leaving the incredible statements of the Holy Qur'an to ultimately prevail to explain that empiricism:

- **“If Allah had so willed, He would have made you a single people,” ;**
- **“(His plan is) to test you in what He hath given you: so strive as in a race in all virtues. The goal of you all is to Allah; it is He that will show you the truth of the matters in which ye dispute.” ;**
- **“If ye differ in anything among yourselves, refer it to Allah and His Messenger, if ye do believe in Allah and the Last Day: That is best, and most suitable for final determination.” ;**

- “Surely We have shown him the way: he may be thankful or unthankful.” ;
- “One day We shall call together all human beings with their (respective) Imams” ;
- 'Then the Messenger will say: “O my Lord! Truly my people took this Qur'an for just foolish nonsense.”’ ;
- “This is a people that have passed away; they shall have what they earned and you shall have what you earn, and you shall not be called upon to answer for what they did.” (all cited above)

As evidenced above, the Author of the Holy Qur'an asserts to have fully empowered individuals, societies, and civilizations from time immemorial with His Divine Guidance System whether they be thankful or unthankful. And will hold all human beings to account for its implementation in their own lives and their own times in the company of their respective Imams, as precisely outlined in summary above. Be that as it may, the implementation of the Author's Divine Guidance System is nevertheless made even more impractical by the meta paradox of the Holy Qur'an, that the hijacking of its understanding has been enabled by the Holy Qur'an itself. Even the smartest minds in sophisticated societies have to deal with the challenge of accurately deciphering the Holy Qur'an due to its **Indeterminates!**

But the twain of that paradox is still another paradox – that perhaps it was this first paradox which enabled the Holy Qur'an to even survive in its cipher form as a pristine un-tampered text through the vicissitudes of empires built upon the abuse of the religion of Islam as a force for social engineering, in the first place. When Muslim power-mongers at the very inception of Islam's ascendance did not hesitate from slaughtering the progeny of the Prophet of Islam to occupy its highest pulpits despite the clear Qur'anic commandment to Muslims that loving the Messenger's near of kin in gratitude is a moral obligation put upon them, **'Say: “No reward do I ask of you for this except the love of those near of kin.”'**, the verses of the Holy Qur'an themselves would surely not have survived un-tampered had they effectively got in the way of *imperial mobilization*.

By using open-ended statements and indirections in its verses, i.e., by becoming a cipher, and by encouraging its verbatim memorization and recitation on every occasion imaginable primarily as an oral message, the Author has certainly been able to safeguard the text of the Holy Qur'an from the villainy of human scribes and the vicissitudes of time. And here is

the twain paradox – but who can decipher that pristine un-tampered cipher message of “no doubt” into its singular *plaintext* today without any doubt? Albeit, the Holy Qur'an has provided a cipher key for breaking this deadlock condition, to approach its cipher with a “cleansed heart” and all would be revealed: **“In a Book well-guarded, Which none shall touch but those who are clean (purified)”**, Surah Al-Waqia, 56:78-79, already quoted above.

Many millenniums later, despite the indirections and the unknowns, the pristine text of the Holy Qur'an has still enabled the solely left-brained Mr. Spock to reason through the cipher using only the Holy Qur'an itself as the criterion to adjudicate his reasoning. As should be readily apparent to the reader, validating the broad claims of the Holy Qur'an, Mr. Spock has certainly comprehended quite a bit already.

But the paradox of trying to comprehend in totality, the Infallible Words of the Author from the fallible words of the scribes of history persists. This paradox is deeply inherent in the Holy Qur'an and no amount of rationalization of how pristine and un-tampered the Qur'anic text really is due to it being a convoluted cipher rather than a straightforward *plaintext* message in the first place, can wipe it way.

Mr. Spock pushes this macro meta puzzle on the top of his evaluation stack, realizing fully well that albeit a totality of understanding may be difficult to acquire, a reasonable, even if ultimately partial, understanding may still be achieved to finally resolve all paradoxes with logical self-consistency once he has dug his way to the very bottom of the Pandora's box.

In its deep unraveling, avers Mr. Spock with the bold optimism of a rational logician who only makes predictive hypotheses based on facts uncovered thus far, must be the one master key to the question posed at the very top. Mr. Spock is now ever more curious to dig deeper because it is obvious to him that acquiring such a master key could potentially lead to uniting the Muslims into Islam's long cherished goal of **أُمَّةٌ مُّسْلِمَةٌ** .

Mr. Spock has realized that unlike peoples of other religions, Islam and the Holy Qur'an evidently continue to play a much greater role in the daily lives of Muslim nations on earth in nearly all cultures and civilizations of the East. The West is also not immune to its intoxicating grip upon the Muslim peoples living there. The public's oral recitation of the Holy Qur'an, if not its penetrating study, is ubiquitous among the Muslim masses and comprises their essential Islamic ethos. It is a pathetic shame therefore, that they each understand the same text differently, leading to needless fracture lines among them that are always ripe for harvesting by the vile and the villainous. Something should be done about this – despite the potential of the *prime directive* adversely interfering with that lofty

objective (to not have the highly evolved Star Trek folks in the fable meddle with primitive war-mongering civilizations in the galaxy and to let them evolve or die away on their own natural curve).

Accurately unraveling the principal first cause of disunity among Muslims from which every schism, every empire, and every evil has followed, logically surmised Mr. Spock, would minimally lead to eliminating all sectarianism from among them. Since the Muslims already possess the common text of the Holy Qur'an which they are all already united upon, and mainly only differ in what it means. A rational elimination of these now very powerful fracture lines, a happenstance of history, would also eliminate the ease of abuse of Islam by rulers and empires who thrive on historical obfuscation, on aiding and abetting internecine violence, on sectarian divides, pitting one narrative against the other among the ignorant partisans to assert their own primacy and its geostrategic imperatives. Eliminating just that singular source of global threat to other worlds and other civilizations, would be worth violating the prime directive for, reasons Mr. Spock.

Mr. Spock recognizes, with his long exposure to the exercise of hegemony and to the evolution of societies – sometimes due to being conquered, and sometimes due to resistance to being conquered – that, if Muslim societies were permitted to evolve their comprehension of the real meaning of Islam and the sublime guidance to mankind offered in the Holy Qur'an, and if knowledge of this new understanding was permitted, even encouraged, to percolate down to the Muslim masses, firstly, all such subversions for “*imperial mobilizations*” would automatically be thwarted. Secondly, the concomitant societal journey towards a progressive more egalitarian state of existence from the present stifling ritualistic one, would also be natural and automatic. The old stultified generations carrying the cultural reactionary memories that had ossified into stale rituals and incomprehensibility, by such a positive evolutionary process, would automatically be supplanted by new knowledge and understanding of the timeless Holy Qur'an.

That process would naturally lead to the evolution of the Muslims as a people, and thus to the evolution of Muslim societies along the pristine parameters laid out in the Holy Qur'an, with its emphasis on egalitarianism, knowledge acquisition, *ilm*, as in verse 20:114, alongside its uncompromising focus on moral sublimity and social justice, as in *Surah al-Asr*, the Chapter 103 of the Holy Qur'an. It would require substantial social and personal evolution of Muslims from where they are today, fools, scapegoats, stooges, patsies, and victims of hegemonic *imperial mobilization* since the very inception of Islam. That would surely be of immense benefit to the entire Universe, Mr. Spock reasons.

But, he lamentably ponders, which ruling class and threatened interests among them would

ever permit such a positive transformation to occur on its own, without substantial use of a counter force, when it would kill the golden goose which lays the imperial egg?

Especially, when such transformation would finally even unite the Muslims into one enlightened people who would be next to impossible to conquer for inimical interests so long as they remained vigilant of the teachings of the Holy Qur'an and worked preemptively to thwart its subversion as in the past.

However, a bent tree can hardly ever be straightened without breaking it, as Mr. Spock well knows. And that unfortunate empiricism may necessitate that the religion of Islam, as preserved in its un-tampered scripture, continually resuscitate itself only in new cultures and new civilizations, among new peoples, each time for a better implementation, while leaving the corrupted and hijacked ones to naturally decay away into oblivion. There is no curing, never mind arresting, this cancer in an already decaying society.

With that as the overarching backdrop of the import of his study, Mr. Spock decides to dig his electrified mind into a deeper more penetrating examination of the meaning of Islam. His mathematical genius now simply had to solve these puzzles and paradoxes of the Holy Qur'an.

## **Conclusion Part-II**

We set out to address the question posed at the top in this Part-II:

**What are the inherent impediments for studying the message of the Holy Qur'an which make the Book so amenable to self-serving interpretation, socialization, and even bastardization by anyone?**

If the reader's mind hasn't been entirely asleep through this long perusal, the discovery that the presence of **Indeterminates** in the Holy Qur'an which necessitates going outside of its pristine pages to resolve them, is primarily responsible for the paradox that the Holy Qur'an has itself contributed to its subversion, must be disconcerting to the honest mind. The Muslims, generation after generation, have themselves contributed to this state of affairs by remaining ossified in the narratives of history rather than progressively evolving their understanding of the principles of Islam as espoused directly in the text of the Holy Qur'an. That lamentable fact has arrested their evolution as a people, mired them in rituals and rites which dominate their socialization and their practice of religion, and opened them to sectarian schisms which has made them easy prey to the *supermen* and *Machiavelli*. The unfortunate truth of these observations is straightforwardly validated by the lamentable fact

that even in today's modernity, one which is run exclusively by superior intellects who use game theory, psychology, social engineering, and political science to orchestrate "*imperial mobilization*" under the primacy imperatives of the new *White Man's Burden* for one-world government, even the best among the Muslim scholars and intellectuals, politicians and statesmen, poets and dreamers, pressmen and prostitutes, remain nonetheless wiser. In fact, many have become *house niggers* willingly carrying the *White Man's Burden*. And like the Muslim masses, many also offer their daily prayers on time, keep all their fasts, feed the poor, and perform their Hajj, preferably multiple times. And if one informs them that they are in fact destined for hell, hell right here on earth, they confidently reply that they are looking forward to Heaven elsewhere.

### **To be continued in Part-III**

**Footnotes:** \* An evaluation stack is an abstraction, an idea from computer science. It can be used to solve almost any computational problem. An entire computer can be built using just this form of underlying computation. Not very efficient, but simple to implement. My very first course in computer science as an undergraduate at MIT taught this basic abstraction of a stack machine. As the terminology *prima facie* suggests, an evaluation stack is a stack, just like a stack of dirty dishes. You *push* a dirty dish onto the top of stack for cleaning, and you take the top most dish from the top of the stack to clean it first (called *pop*). Using this metaphor here is just for the convenience of thinking that the puzzles are soluble and not intractable – they just need solving.

\*\* Zbigniew Brzezinski, *The Grand Chessboard*, 1997, pg. 24

\*\*\* Bertrand Russell

**Source URL:** <http://faith-humanbeingsfirst.blogspot.com/2011/08/islam-why-is-quran-easy-to-hijack-pt2.html>

First Published Friday, August 19, 2011, 19th day of Ramadan in the US, Muslim year 1432

Extended December 2011, month of Muharram in the Muslim year 1433, while in United States

Extended August 2012, month of Ramadan in the Muslim year 1433, while in Pakistan



## Recommended Reading

**The Controversy of Zion** By Douglas Reed, written during 1951-1956 and published in 1978. PDF available on the internet by searching for the title.

**THE EMPIRE OF “The City” (World Superstate)** By E. C. Knuth, written and published in 1944-45. PDF of 1983 edition available on the internet by searching for the title.

**Secrets of the Federal Reserve** By Eustace Mullins, Published in 1952. PDF available on the internet by searching for the title.

**The World Order – A study in the Hegemony of Parasitism** By Eustace Mullins, published in 1985. PDF available on the internet by searching for the title.

**Tragedy and Hope** By Carroll Quigley, published in 1966. Still in print. PDF available on the internet by searching for the title.

**None Dare Call It Conspiracy** By Gary Allen, published 1970. PDF available on the internet by searching for the title.

**The Rockefeller File** By Gary Allen. PDF available on the internet by searching for the title. From the Introduction: *“The Rockefeller File is not fiction. It is a compact, powerful and frightening presentation of what may be the most important story of our lifetime, the drive of the Rockefellers and their allies to create a one-world government, combining super-capitalism and Communism under the same tent, all under their control. Do I mean conspiracy? Yes, I do. I am convinced there is such a plot, international in scope, generations old in planning, and incredibly evil in intent.”*

**Secret Societies And Subversive Movements** By Nesta Webster, published 1924. PDF available on the internet by searching for the title.

**Proofs Of A Conspiracy Against All The Religions and Governments of Europe** By John Robison, 3<sup>rd</sup> Edition, 1798. PDF available on the internet by searching for the title.

**The Rise of the House of Rothschild 1770-1830** By COUNT EGON CAESAR CORTI Translated from the German by Brian and Beatrix Lunn. Published 1927. PDF available on the internet by searching for the title. The author notes in his Foreword of July 1927: *“it relates the story of an unseen but infinitely powerful driving force which permeated the whole of the nineteenth century.”*

**The Best Enemy Money Can Buy** By Antony C. Sutton, published 1986. PDF available on the internet by searching for the title.

**Trilaterals over America** By Antony C. Sutton, Published 1995 Tab Books. PDF available on the internet by searching for the title.

**Wall Street and the Bolshevik Revolution**, 1974; **Wall Street and FDR**, 1975; **Wall Street and the Rise of Hitler**, 1976; By Antony C. Sutton. PDF available on the internet by searching for the titles.

**Impact of Science on Society** By Bertrand Russell, published 1952. Available on Google books on the internet.

**New World Order** By H. G. Wells, published 1940. PDF available on the internet by searching for the title. A speciously argued justification for world government as the natural inevitability of scientific modernity and not oligarchic machinations, paying lip-service to a new declaration of global human rights to make the prospect of world government sound less draconian, while arguing the futility of resisting the new world order: *“When the struggle seems to be drifting defiantly towards a world social democracy there may still be very great delays and disappointments before it becomes an efficient and beneficent world system. Countless people – will hate the New World Order – and will die protesting against it. When we attempt to evaluate its promise, we have to bear in mind the distress of a generation or so of malcontents, many of them quite gallant and graceful-looking people.”*

**Between Two Ages: America’s Role in the Technetronic Era** By Zbigniew Brzezinski, published 1970. PDF available on the internet by searching for the title.

## Acknowledgment

The author would like to gratefully acknowledge the support of his family who have silently, and almost willingly endured his obsession with, and single-minded pursuit of, activism and journalism since 9/11. This has, at times, included several long absences away from home for which he is indebted to his wife for having taken up the slack, and giving this scribe his opportunity to “*sing the song in your heart before you die*” – as she likes to put it. With their children now pursuing their professional education and having moved away from home, the author spends more time in Pakistan to continue his passionate pursuits among a people who once again – as in the United States where he is a permanent US resident for nearly three decades (see his encounter with the FBI and Homeland Security in 2003 in [They dared to knock on my door](#)) – appear most un-interested in anything he has to say.

The author is also most grateful for his destiny – fate, *karma*, *naseeb* – that it was so apportioned to him, and that he got the opportunity to experience and witness the most momentous of times in the history of mankind. Never before, in the recorded history of its many civilizations from antiquity to the modern world, has the entire earth been at the cusp of becoming one-world, one empire, and with the most insidious methods of conquest where the people being conquered, unless they are being bombed to smithereens, don't even realize that they are being systematically trained into enjoying their own servitude to the new behind the scene rulers of the world. The fact that the new world under construction is visibly headed towards being a most oppressive and despotic one – the likes of which has never been witnessed in history, affecting the largest number of human beings simultaneously – has been the driving force behind the author's lonely endeavors to systematically deconstruct its Machiavellian methods in the futile hope of averting its inevitability.

The swashbuckling rebel, Captain Rhett Butler's statement to Mrs. Hamilton in *Gone with the wind* is oddly reminiscent of this uncharacteristic labor: “*maybe it's because I have always had a weakness for lost causes once they are really lost.*”

The author feels grateful that he was not only gifted a glimpse into this wily modernity from Mt. Fuji, and the rare ability to even comprehend all the forces which are reshaping this modernity as such, but also gifted the courage of his convictions to want to do something about it. He recognized the catastrophic terrorism of 9/11 for what it was on the very day of September 11, 2001, and has applied himself assiduously ever since in being a *malcontent*. He began with educating his own family in 2001, moved to street protest marches in 2002, and to systematic intellectual public dissent in 2003 (see [Chapter-7:](#)

Resistance to Empire - New Directions of his maiden 2003 book Prisoners of the Cave). A precious gift of endeavor that few among mankind evidently have been so fortunate to receive, despite many of them holding imposing qualifications and offices, even Nobel prizes and other laudatory credentials to die for in the pursuit of the *American Dream*.

And, for which, the author's convictions inform him, all will be held to account on the Day when all accounts will be settled, fairly, of both, the '*untermenschen*', and the '*ubermenschen*'. He is most grateful that he has recognized that fact in his own time when he can bring much energy to bear on the matter. Its success or failure is not in his hands, only his own passionate endeavors are, for which, he often appears as a "foolish idealist" to the most successful people who were formerly his colleagues and friends. He thanks them all.

## Image Sources and Credits

- pg 15 Desiree L. Rover's Presentation on Vaccinations, Netherlands, Aug. 01 2009
- pg 38 1928 Book Cover Edward Bernays, unknown source from the web
- pg 39 Desiree L. Rover's Presentation on Vaccinations, Netherlands, Aug. 01 2009
- pg 40 The Mighty Wurlitzer Organ, unknown source from the web
- pg 43 UK Telegraph 27 July 2010 <http://www.telegraph.co.uk/news/worldnews/asia/afghanistan/7913050/Wikileaks-Afghanistan-Osama-bin-Laden-alive.html>
- pg 43 Image of President Obama, Egypt, Cairo June 4th 2009 - Obama Warns not to challenge Official 9/11 Story <http://www.youtube.com/watch?v=kvg65o7z028>
- pg 44 Image of Osama Bin Laden from Documentary ZERO <http://www.youtube.com/watch?v=AfxioFvRX4>
- pg 45 Image of President Obama announcing the Death of Osama Bin Laden, May 1, 2011 - Video via The Alex Jones Channel <http://www.youtube.com/watch?v=fpBPVkpmoeg>
- pg 63 Book cover: Islam is of The Devil by Pastor Terry Jones Amazon.com
- pg 66 Book cover: The Sublime Quran By Laleh Bakhtiar <http://www.kazi.org/>
- pg 82 Experimental flying crafts as flying saucers with U.S. Air Force markings <http://www.iamthewitness.com/img/FlyingSaucers/FlyingSaucers.html>
- pg 84 and 416 Image of Rex, the 'bad' alien, via UK Guardian, 10 January 2011 <http://www.guardian.co.uk/science/2011/jan/10/earth-close-encounter-aliens-extraterrestrials>
- pg 84 and 400 Image of The Hottel memo that 'proves aliens landed at Roswell' in 1950, Daily Mail, April 09, 2011, via FBI website <http://www.dailymail.co.uk/news/article-1375203/The-memo-proves-aliens-landed-Roswell--released-online-FBI.html>
- pg 85 and 402 Image from Zecharia Sitchin's film: Are We Alone In The Universe? President Ronald Reagan Speaking at the UN General Assembly, September 21, 1987
- pg 85 and 402 Image from National Geographic Channel show <http://video.nationalgeographic.com/video/player/national-geographic-channel/specials-1/aliens/ngc-alien-attack.html>
- pg 90 Image of President Obama, Ad Age's Marketer of the Year, October 17, 2008, [obamaprogress-022508  
http://humanbeingsfirst.files.wordpress.com/2011/03/cacheof-obama-wins-ad-ages-marketer-of-the-year-october-17-2008.pdf](http://humanbeingsfirst.files.wordpress.com/2011/03/cacheof-obama-wins-ad-ages-marketer-of-the-year-october-17-2008.pdf)
- pg 94 Ostrich or Rebel, head in the sand image courtesy <http://pravda.ru> 42510.jpeg
- pg 106 Libyan rebels repel attacks as refugees flee Ajdabiya Eastern Libya, March 03, 2011 (AP Photo Kevin Frayer, image via the Sacramento Bee sacbee)
- pg 115 American Government Response to Conspiracy Theories, image from [http://america.gov/conspiracy\\_theories.html](http://america.gov/conspiracy_theories.html)
- pg 116 always-you-with-that-conspiracy-stuff.jpg unknown source from the web
- pg 129 Image from The Capitalist Conspiracy An Inside View of International Banking by G. Edward Griffin, 1972
- pg 131 Image from Eric Fossum on Societal Concerns of his Invention, Yale University, October 13, 2011
- pg 148-151 Desiree L. Rover's Presentation on Vaccinations, Netherlands, Aug. 01 2009
- pg 151 and 190 Image of David Rockefeller speaking at the UN Ambassador's Dinner from video <http://www.youtube.com/watch?v=ClqUcScwnn8>
- pg 158 Desiree L. Rover's Presentation on Vaccinations, Netherlands, Aug. 01 2009
- pg 159 Image of Realplayer playing Aldous Huxley's 1962 speech at UC Berkeley.
- pg 176 Image of Herman Van Rompuy announcing "2009 is also the first year of Global Governance" <http://www.youtube.com/watch?v=QEqFtVrAgSo>
- pg 181 Climategate U-turn 'On thin Ice – The hockey stick graph fraud', The Daily Mail UK, Feb 14, 2010 <http://www.dailymail.co.uk/news/article-1250872/Climategate-U-turn-Astonishment-scientist-centre-global-warming-email-row-admits-data-organised.html>

pg 182 Image from Video Corbett Report Climategate Dr. Tim Ball on the hacked CRU emails, November 21, 2009 <http://www.youtube.com/watch?v=Ydo2Mwnwpac>

pg 183 Image from Video Fox News Sen. Inhofe On Global Warming: 'This Thing Is Phony' June 29, 2009 <http://www.youtube.com/watch?v=Skf8bpl8WSg>

pg 184 Cliff Harris and Randy Mann Global Temperature Chart 2500 BC to 2040 AD from <http://longrangeweather.com>

pg 184 The 'Hockey Stick': A New Low in Climate Science by John L. Daly, graph from <http://wattsupwiththat.com>

pg 187 Image from Michael Coren interviews Ross McKittrick 'The hockey stick is wrong and result of bad science' July 2008 <http://www.youtube.com/watch?v=-1k4mFZr-gE>

pg 194 Image of Dr. Teresa Forcades, Spanish Benedictine nun at San Benet of Montserrat's Monastery, in Barcelona, Sept 23, 2009 from <http://vimeo.com/7298827>

pg 215 Image of Pastor Terry Jones burning Qur'an unknown source from the web

pg 216 Book cover: Islam is of The Devil by Pastor Terry Jones Amazon.com

pg 225 Image of Zbigniew Brzezinski from <http://pacificfreepress.com>

pg 239 and 314 Image of Shameless Stooges at the massa's table. Tahir ul Qadri and Imran Khan at World Economic Forum 2011. Photograph submitted to Project Humanbeingsfirst by a reader

Pg 244 and 378 Face of "moderate Islam". Image of Tahir ul Qadri basking in the adulation of his prostrating fans from video <http://www.youtube.com/watch?v=jq8ELb0JXyo>

pg 249 and 393 Graph of FBI presentation titled "Militancy Considerations" is [http://www.wired.com/images\\_blogs/dangerroom/2011/09/fbi\\_islam\\_graph\\_1.jpg](http://www.wired.com/images_blogs/dangerroom/2011/09/fbi_islam_graph_1.jpg) from the article <http://www.wired.com/dangerroom/2011/09/fbi-muslims-radical/2/>

pg 259 and 271 Image of The 'Dick-Measuring Device' - Portrait of an Artist, Self-Image by John Wild taken with backscatter X-ray fully-body scanner at Manchester Airport UK <http://www.dontscan.us/scans.html>

pg 262 Image of Tammy Banovac in bra, panties and wheelchair, Oklahoma City airport screening on November 30, 2010, youtube=<http://www.youtube.com/v/4zF1l8ioqYk>

pg 267 and 271 Fictitious image of terrorist hiding weapons in their clothing from bild-de-14457736.jpg It was extracted from the article before it was removed <http://bild.de/BILD/news/bild-english/world-news/2009/12/31/pregnancy-body-piercings-genitals/what-can-naked-scanners-really-see.html>

pg 273 Image of X-ray scanner trialled at Manchester Airport - The Telegraph 13 Oct 2009 <http://www.telegraph.co.uk/news/newsvideo/6316975/Body-X-ray-scanner-trialled-at-Manchester-Airport.html>

pg 276 Image of Miss USA Susie Castillo, Dallas Airport April 21, 2011 from video youtube=<http://www.youtube.com/v/mY3Pt0H4-98>

pg 278 Image of Susie Castillo's Complaint filed against the TSA, April 21, 2011 <http://www.susiecastillo.net>

pg 279 Image from Video CNN Meredith Jessup Report: 'TSA Behavior Indicator' youtube=<http://www.youtube.com/v/jVyidvyjXVc>

pg 285 Image from Video Texas state officials groped by the TSA youtube=<http://www.youtube.com/v/AKE98sJpGig>

pg 288 Image from Video 'Sexually Assaulted' by TSA Agent - Amy Alkon Speaks Out -- Interview with Alex Jones youtube=<http://www.youtube.com/v/ZCYa5vEJNJQ>

pg 292 Photoshopped parody of a terrorist, ali-baba-boob-job-bomb <http://FreakingNews.com>

pg 293 Image of Corinne Theile posing in her bikini at LAX in protest of TSA security checks , The Daily Mail, Nov. 24, 2011 <http://www.dailymail.co.uk/news/article-2065574/Bikini-Girl-Corinne-Theile-returns-LA-year-stripping-TSA-protest.html>

pg 294 and 364 Image land\_of\_the\_free composite via <http://sott.net> from <http://davidvincentwolf.com/notes/22611-land-of-the-free> and <http://mprophetphoto.blogspot.com/2010/11/creative-commons-and-tsa-photos.html>

pg 301 Image of ostrich courtesy of National Geographic

pg 310 Image from <http://hiddenenlonger.com>

pg 311 Image of Palestinian baby fetus murdered while still in the mothers womb from Sabbah Report 701.jpg <http://sabbah.biz>

pg 311 and 432 Image of Swat Refugees from the UK Independent news report Sunday, 31 May 2009, 'In Pakistan, an exodus that is beyond biblical' <http://www.independent.co.uk/news/world/asia/in-pakistan-an-exodus-that-is-beyond->

biblical-1693513.html

pg 312 and 359 Image of Afghan Infant killed by US Troops in Khost, Afghanistan April 9, 2009  
infant\_killed\_by\_us\_toops\_khost\_apr9\_09.jpg from <http://www.rawa.org>

pg 312 and 357 Image of Iraqi 'liberation' from Scoop, Alastair Thompson 29 April 2003 <http://www.scoop.co.nz>

pg 313 Image US troops urged to share faith in Afghanistan - 04 May 09 from video <http://www.youtube.com/watch?v=hVGmbzDLq5c>

pg 313 Image from Rebel Reports "hunt people for Jesus... so we get them into the kingdom"  
<http://rebelreports.com/post/103330614/us-soldiers-in-afghanistan-told-to-hunt-people-for>

pg 323 The House of Rothschild – Image from Niall Ferguson and Viking

pg 330, 349 and 550 Image of The Balfour Declaration November 2nd 1917 from  
[http://avalon.law.yale.edu/20th\\_century/balfour.asp](http://avalon.law.yale.edu/20th_century/balfour.asp) and 1948: Lest We Forget balfourdec.jpg <http://www.1948.org.uk/>

pg 330 Photograph Israeli supreme court overlooking Jerusalem gift of the Rothschilds from  
<http://www.thegoldenreport.com>

pg 339 Image World Governance By The Rothschilds, 2003 from <http://bibliotecapleyades.net> via  
<http://bureaudetudes.org>

pg 344 Book cover Nuremberg, the Last Battle <https://irvingbooks.com/xcart/product.php?productid=17516>

pg 354 Image detail of World Governance By The Rothschilds, 2003, from <http://bibliotecapleyades.net> via  
<http://bureaudetudes.org>

pg 355 Images of Iraqi children responding to the 'liberation' brought them by the brave Veterans of America under  
President George W. Bush's "Operation Iraqi Freedom" from <http://angryarab.blogspot.com>

pg 360 Image PTSD and American War Heroes - Victims of their own Barbarianism, unknown source from the web

pg 368 Drawing Islam: The AND Logic of Surah Al-Asr of the Holy Qur'an by the author.

pg 373 Image Brian Gerrish - State of the Nation talk at the January 2009 Stoke Lawful Rebellion Conference, BBC5 TV  
from video <http://www.bbc5.tv/eyeplayer/video/brian-gerrish-state-nation>

pg 373 Image Brian Gerrish Common Purpose - Exposing the Real Traitors, Wakeup Call Conference 12 December 2009,  
BBC5 TV from video <http://www.bbc5.tv/eyeplayer/video/brian-gerrish-exposing-common-purpose>

pg 374 Image One Nation Under Siege Police State Rising By William Lewis from video  
<http://video.google.com/videoplay?docid=-7455325731648062338>

pg 374 and 641 Caption Secular Humanism is the Moral Relativism of the New Age: Morality derived from Intellect leads  
to Barbarianism and Enslavement under the false pretense of Enlightenment! Photograph of a poster from an anti-war  
protest, kids\_racism, unknown source from the web

pg 377 and 434 Image Zbigniew Brzezinski to the Afghan Mujahideen "God is on your side" PBS documentary

pg 395 and 407–408 Experimental flying crafts as flying saucers with U.S. Air Force markings  
<http://www.iamthewitness.com/img/FlyingSaucers/FlyingSaucers.html>

pg 416 Image of 'good' alien via UK Guardian, 27 January 2010 Photograph: Colin Anderson/Getty from  
<http://www.guardian.co.uk/science/2010/jan/27/aliens-cant-hear-us-astronomer>

pg 428 Image from video RussiaToday September 08, 2009, Contractors in Pakistan: are troops next?  
<http://www.youtube.com/watch?v=182Pa8zKTuQ>

pg 474 Tracking the Bailout NYT Nov 25, 2008 <http://graphics8.nytimes.com/images/2008/11/26/business/26fed.600.gif>

pg 549 Photograph of Golda Meir, autographed to Alan Hart as her 'good friend' from <http://alanhart.net>

pg 561 Image of a Palestinian child throwing a rock at an Israeli tank, unknown source from the web

pg 593 Map of Herzl's plan for the Jewish State thepromisedland.gif unknown source from the web

pg 597 Map Iron-wall Avi Shlaim, page-26 UN partition plan

pg 603 Image of Malcolm X - Field Negro vs House Negro Speech [http://www.youtube.com/watch?v=UQ\\_VWpJj0Dw](http://www.youtube.com/watch?v=UQ_VWpJj0Dw)

pg 622-623 Nazi propaganda chief Joseph Goebbels with his six children Harald, Hilde, Holde, Hedda, Helga und Helmut,  
Photographic images from Der Spiegel <http://www.spiegel.de/images/image-22061-galleryV9-suml.jpg>

pg 647 Image of Bruce Lee teaching a younger apprentice in the movie Enter the Dragon <http://www.youtube.com/watch?>

v=roY9SaqM0mo

pg 648 Image from video footage Battle At Kruger <http://www.youtube.com/watch?v=LU8DDYz68kM>

chapter 33, all arabic verses in uthmani or simple script courtesy of the open source Qur'an Tanzil Project, <http://tanzil.net>



**Thank you for reading**  
**The Poor-Man's Guide to**  
**Modernity**

**More intellectual vitamins for the mind**  
**available at: <http://humanbeingsfirst.org>**

# *The Poor-Man's Guide To Modernity*

This book examines our Modernity in the twenty-first century. Politically speaking, it revolves around the systematic construction of a despotic world government piece-meal under the scientific dictatorship of a global oligarchy.

The modus operandi is to deliberately create problems and then offer only those solutions which result in bigger government, incrementally leading to world government. *“Create conditions so frightful at home and abroad that the abandonment of personal liberties and national sovereignty will appear as a reasonable price for a return to domestic tranquility and world peace.”*

The myriad manufactured crises which afflict humanity today – from perpetual 'War on Terror' to perpetual Counter Insurgency to sudden Revolutions to Global Financial Crisis to Global Pandemics to Global Warming, perhaps even Global Alien Landings/Sightings and/or other Intergalactic Catastrophes – are the successive Hegelian mind-fcks, ahem, the “acts” and “deeds” of making current affairs *“look like a great ‘booming, buzzing confusion’ to use William James’ famous description of reality,”*. Each new ‘booming, buzzing confusion’, designed to wear-out the sanity of mankind by plunging them repeatedly into a state of panic, war weariness, and disillusionment, generates the new enabling pretext for inching the world one baby step closer towards the Global Governance of the Planet.

Only by understanding all the hidden forces guiding each new demoralizing crisis before it seeds its engineered fait accompli, can the public mind even begin to withstand the coercion to 'United We Stand' with the abhorrent solution that is offered to the public as a reaction to the crisis. Which is why, such comprehension as is contained in this book, will always be prevented from reaching the public mind when it can actually make an existential difference to the people.



Backcover

Current Affairs / Politics / Psychology / Religion

# ***The Poor-Man's Guide To Modernity***

This book examines our Modernity in the twenty-first century. Politically speaking, it revolves around the systematic construction of a despotic world government piecemeal under the scientific dictatorship of a global oligarchy.

The modus operandi is to deliberately create problems and then offer only those solutions which result in bigger government, incrementally leading to world government. *“Create conditions so frightful at home and abroad that the abandonment of personal liberties and national sovereignty will appear as a reasonable price for a return to domestic tranquility and world peace.”*

The myriad manufactured crises which afflict humanity today – from perpetual 'War on Terror' to perpetual Counter Insurgency to sudden Revolutions to Global Financial Crisis to Global Pandemics to Global Warming, perhaps even Global Alien Landings/Sightings and/or other Intergalactic Catastrophes – are the successive Hegelian mind-fcks, ahem, the “acts” and “deeds” of making current affairs *“look like a great ‘booming, buzzing confusion’ to use William James’ famous description of reality,”*. Each new ‘booming, buzzing confusion’, designed to wear-out the sanity of mankind by plunging them repeatedly into a state of panic, war weariness, and disillusionment, generates the new enabling pretext for inching the world one baby step closer towards the Global Governance of the Planet.

Only by understanding all the hidden forces guiding each new panic-inducing demoralizing crisis BEFORE it seeds its engineered fait accompli, can the public mind even begin to withstand the coercion to 'United We Stand' with the abhorrent solution offered to the panic-stricken people as a reaction to solving the crisis. Which is why, such comprehension as is contained in this book, will always be prevented from reaching the public mind when it can actually make an existential difference to the people. Afterwards, when nothing can be done to alter the new ground realities, historical narratives become permissible based on official documents artfully declassified by the Mighty Wurlitzer to explain it all.

<http://tinyurl.com/poor-mans-guide-to-modernity5a>

Gratis 5<sup>th</sup> Edition