



Version  
03.00

May  
2008

## R&S® NRP Power Meter Family

The ultimate solution for power measurements

- ◆ Power measurements with a base unit or with USB sensors alone
- ◆ Average, peak and peak-to-average power measurements from DC to 40 GHz
- ◆ Versatile USB sensors with superior performance
- ◆ Accurate measurements for GSM/EDGE, 3G, WLAN, WiMAX, LTE and beyond
- ◆ Solutions for radar and EMC applications



**ROHDE & SCHWARZ**

# The R&S®NRP family

Accurate determination of RF power is one of the most challenging tasks in the field of electrical test and measurement. No matter whether an application involves characterizing the RF components used in mobile communications equipment, for example, or assessing the transmit power of complex radar systems, base stations or mobile telephones, there is always a need to measure RF power as accurately as possible. This includes applications in R&D, production and maintenance as well as in calibration laboratories.

The R&S®NRP family is ideal for such applications. In addition to the R&S®NRP base unit, there are a number of sensors available to perform diverse measurements. Complex signals with

digital modulation (e.g. as required by advanced mobile radio standards such as WCDMA and WiMAX) are handled as easily as are CW signals, carriers with analog modulation (e.g. AM, FM) and pulsed RF.

## Versatile, user-friendly R&S®NRP base unit

- ◆ Small, lightweight and ruggedized base unit for production, laboratory and mobile applications
- ◆ Simple operation due to window-based graphical user interface
- ◆ Presets for fast, standard-compliant measurements
- ◆ Simultaneous operation of up to four sensors

- ◆ Remote operation via Ethernet (R&S®NRP-B4 option), GPIB or USB
- ◆ Sensor check source (R&S®NRP-B1 option)

## Intelligent sensors for every need

- ◆ Solutions for average, peak and peak-to-average power measurements from DC to 40 GHz
- ◆ Intelligent plug & play USB sensors with calibration data stored directly in the sensor
- ◆ Direct operation of sensors via USB interface with highest accuracy, repeatability and functionality in its class

*R&S®NRP base unit with sensor*



- ◆ R&S® Smart Sensor Technology™
- ◆ R&S® NRP-Z1x/-Z2x true universal power sensors with up to 90 dB dynamic range for CW and modulated signals
- ◆ R&S® NRP-Z22/-Z23/-Z24 high-power sensors with detachable attenuator for a wide power measurement range with only one sensor
- ◆ R&S® NRP-Z9x average power sensors for measurements in the frequency range from 9 kHz to 6 GHz
- ◆ R&S® NRP-Z5x thermal power sensors with outstanding accuracy (linearity uncertainty <0.02 dB)
- ◆ R&S® NRP-Z81 wideband power sensor with up to 30 MHz video bandwidth and up to 80 dB dynamic range
- ◆ Special R&S® NRP-Z27/-Z37 and R&S® NRP-Z28/-Z98 sensors for use with measuring receivers and signal generators
- ◆ Two-year calibration cycle

### Accurate measurement of TDMA-based signals

- ◆ Trace mode of the R&S® NRP-Z1x/-Z2x/-Z81 sensors for graphical signal analysis
- ◆ Timeslot measurement function for simultaneous power measurement in individual timeslots
- ◆ Easy definition of exclude times and trigger conditions for precise determination of the measurement range
- ◆ Up to four fully independent measurement gates
- ◆ With the R&S® NRP-Z81 wideband power sensor, additional definition of a fence per gate or timeslot for masking signal components

### Ready for the future – 3G signals and beyond

- ◆ Test solution for mobile radio standards based on CDMA and OFDM such as 3GPP FDD, CDMA2000® and LTE (UMTS long term evolution)
- ◆ Accurate average power measurement of signals with high peak-to-average ratios
- ◆ Statistical signal analysis using the R&S® NRP-Z81 wideband power sensor, CCDF measurement with one million samples in <25 ms
- ◆ Trace mode with peak and peak-to-average measurement

### Superior performance for WLAN/ WiMAX

- ◆ Trace mode for graphical time-domain analysis (with the R&S® NRP-Z1x/-Z2x/-Z81)
- ◆ Highly repeatable wideband power measurements with the R&S® NRP-Z81 power sensor due to very low zero drift
- ◆ Time gating function, e.g. for measurement of preamble and burst power

### Specialized in radar/EMC applications

- ◆ Time-domain measurement of brief pulses with the R&S® NRP-Z81 wideband power sensor
- ◆ Marker functions for determining time differences (e.g. rise and fall times)
- ◆ Precise internal and external triggering (continuous or triggered by single events) for reliable pulse detection

- ◆ Specialized R&S® NRP-Z9x average power sensors for EMC applications in the frequency range from 9 kHz to 6 GHz with up to 90 dB dynamic range

### Component tests with minimized uncertainty and high throughput

- ◆ Computation of results from different measurement channels to form derived measurands (SWR, power ratio, reflection coefficient, return loss, etc.)
- ◆ Reduction of mismatch errors by  $\Gamma$  correction
- ◆ Compensation of the influence of attenuator pads, couplers, etc. based on S-parameter sets stored directly in the sensor
- ◆ Enhanced auto averaging function for optimization of measurement time versus required accuracy
- ◆ High measurement speed (up to 1500 measurements/s)

### Test and measurement setups made easy

- ◆ Easy system integration using VXI, LabVIEW and LabWindows/CVI drivers
- ◆ BNC outputs on the R&S® NRP for outputting a voltage proportional to the measured value or a pass/fail indication
- ◆ Standalone operation of the R&S® NRP-Zxx sensors via USB interface as a cost-efficient production solution
- ◆ Use of the R&S® NRP-Zxx sensors together with signal generators, spectrum and network analyzers as well as measuring receivers

# Versatile, user-friendly R&S® NRP base unit

A state-of-the-art power meter must meet diverse requirements. In addition to excellent measurement accuracy, other requirements include suitability for the task at hand and straightforward operation. The R&S® NRP was designed to be a base unit that is as versatile and easy to operate as possible.

## Ease of use

With its ruggedized but compact design, battery supply option (R&S® NRP-B3) and low weight, the R&S® NRP is optimally suited for laboratory and production applications as well as mobile use. The clear menu structures and window-based operating concept make operation

extremely straightforward. Ten user-programmable save/recall memory locations allow fast access to personal settings. Presets for all of the major mobile radio standards enable correct measurement of signals with only a few steps: Just plug in the sensor, select the preset and measure!

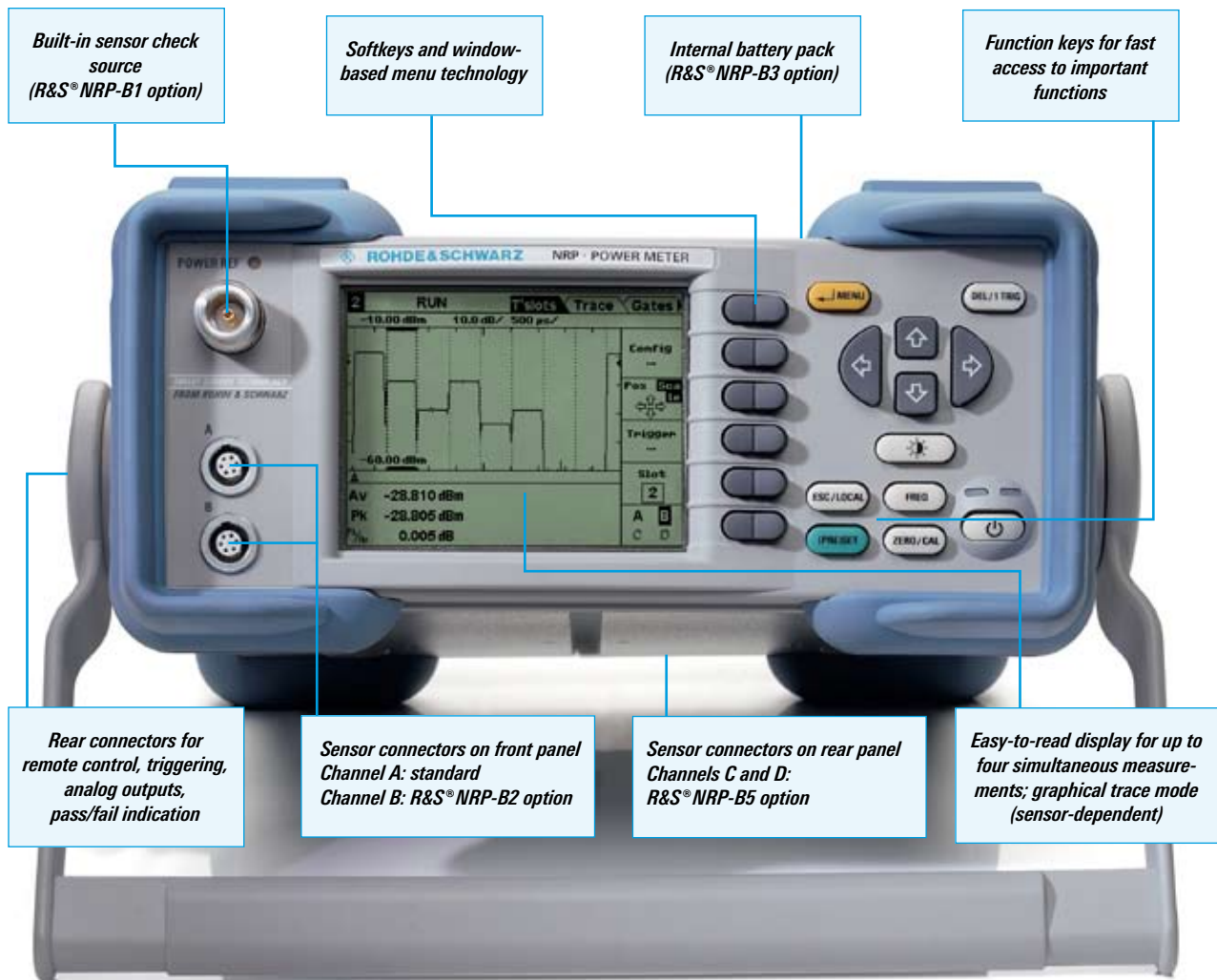

## Connectivity

Simultaneous measurements are possible on up to four different measurement points by connecting up to four sensors (depending on the option). A trigger input also allows externally triggered, synchronous measurements. Two BNC outputs are available for status indication (e.g. limit monitoring). The Ethernet (R&S®NRP-B4), GPIB and USB remote-control interfaces ensure optimized integration into automated test setups. An optional sensor check source is useful for fast verification of the sensors (R&S®NRP-B1). Calibration of the sensors immediately prior to each measurement is not required due to the innovative sensor technology that is used.

## Display of measured values

The high resolution 1/4" VGA display ensures good readability of measurement results. Results can be presented in digital, analog or graphical display formats (trace & statistics mode). The marker functions allow time-domain analysis similar to that provided by an oscilloscope (with the R&S®NRP-Z1x/-Z2x/-Z8x).

Diverse computation facilities are provided for results from different measurement channels to simplify determination of derived measurands (e.g. SWR, power ratio, reflection coefficient, return loss). Statistical analyses can be presented in graphical format as a complementary

cumulative distribution function (CCDF), cumulative distribution function (CDF) or probability density function (PDF) (using the R&S®NRP-Z81).



# Intelligent sensors for every need

All of the sensors of the R&S®NRP family function as independent measurement instruments due to their integrated signal processing. The measured values undergo complete processing in the sensor and are output in digital format. Any additional error sources such as interference acting on the sensor's connecting cable or due to the base unit itself are consistently eliminated in the R&S®NRP family owing to digital data transfer via USB.

For the entire range of sensors, the R&S® Smart Sensor Technology™ ensures top accuracy, repeatability and usability.

## General sensor features

- ◆ Intelligent plug & play USB sensors that are fully characterized at the factory
- ◆ No influence of base unit on measurement accuracy
- ◆ Operation of sensors via USB interface
- ◆ Connection to:
  - R&S®NRP base unit
  - Personal computer, laptop
  - Rohde & Schwarz spectrum/network analyzers (model-dependent)
  - Rohde & Schwarz signal generators (model-dependent)
- ◆ Excellent impedance matching
- ◆ All sensors capable of automatic internal triggering
- ◆ Enhanced auto averaging function for optimization of measurement time versus required accuracy
- ◆  $\Gamma$  correction to minimize influence of mismatches
- ◆ S-parameter correction to eliminate the influence of components in the test setup such as attenuator pads, cables, etc.
- ◆ Electrically and mechanically ruggedized
- ◆ Two-year calibration cycle
- ◆ Traceability to national calibration standards



R&S®NRP-Z23 sensor

## R&S®NRP-Z11/-Z2x universal power sensors

- ◆ True universal power sensors for a vast number of applications
- ◆ 10 MHz to 8 GHz (R&S®NRP-Z11)
- ◆ 10 MHz to 18 GHz (R&S®NRP-Z2x)
- ◆ Innovative three-path diode power sensor with enhanced inter-range performance
- ◆ 90 dB dynamic range for CW und modulated signals
- ◆ R&S®NRP-Z22/-Z23/-Z24 high-power sensors for measurements up to 30 W
- ◆ Continuous average, burst average, timeslot average, time gating and trace mode supported (video bandwidth 100 kHz)
- ◆ Automatic burst detection and acquisition
- ◆ Up to 1500 measurements/s (buffered mode)
- ◆ Low sensitivity to harmonics



R&S®NRP-Z55 sensor

## R&S®NRP-Z5x thermal power sensors

- ◆ Suitable for very demanding reference applications
- ◆ Industry-proven DC-coupled thermoelectric test cell
- ◆ DC to 18 GHz (R&S®NRP-Z51, R&S®NRP-Z52)
- ◆ DC to 40 GHz (R&S®NRP-Z55)
- ◆ Level range –30 dBm to +20 dBm
- ◆ Highly accurate continuous average power measurements
- ◆ Linearity uncertainty <0.02 dB



*R&S®NRP-Z91 sensor*

### R&S®NRP-Z9x average power sensors

- ◆ Specially designed for EMC applications
- ◆ 9 kHz to 6 GHz
- ◆ Measurement of continuous average power
- ◆ 90 dB dynamic range for CW and modulated signals
- ◆ Low sensitivity to harmonics



*R&S®NRP-Z81 sensor*

### R&S®NRP-Z81 wideband power sensor

- ◆ Frequency range 50 MHz to 18 GHz (50 MHz to 500 MHz with reduced video bandwidth)
- ◆ Peak power measurements of radar and mobile communications signals with up to 30 MHz RF video bandwidth; sensor rise time <13 ns
- ◆ Automatic burst detection and acquisition
- ◆ Ultra-fast statistical analysis (one-million point CCDF within <25 ms)
- ◆ Accurate continuous power measurements on modulated and unmodulated signals in the range from –60 dBm to +20 dBm
- ◆ High measurement repeatability due to very low zero drift of <150 nW for single-shot events and statistics, <2 nW for repetitive measurements

### Outstanding dynamic range and accuracy

Signal details can be analyzed in the range down to –50 dBm. Continuous average power measurements are even possible in a dynamic range of 80 dB (–60 dBm to +20 dBm). The R&S®NRP-Z81 sensor fulfils practically any accuracy requirements. A complete sensor characterization over the entire temperature range produces excellent stability.

### High-speed data acquisition

Using a single-shot bandwidth of 80 Msample/s and a video bandwidth of 30 MHz, it is possible to measure pulses with a width of only 50 ns. The time resolution can be increased to up to 500 ps/div for repetitive pulse sequence. The fast rise time of typ. 11 ns enables accurate determination of the peak power both for the standard signals used in mobile communications nowadays and for the proprietary pulse sequences that are common in military applications, for example. Due to the high trigger sensitivity of typ. –22 dBm to +20 dBm (at 30 MHz video bandwidth), automatic recording of measured values is ensured for the usual signal levels.

# Intelligent sensors for every need



*R&S®NRP-Z28 sensor*

## R&S®NRP-Z28/-Z98 level control sensors

- ◆ Integrated one-box solution for classic power splitter/power sensor combination
  - ◆ Special directional power sensors with integrated power splitter
  - ◆ For applications requiring a precisely known level to be fed in (e.g. calibration of measuring receivers)
- ◆ Based on the R&S®NRP-Z21 and R&S®NRP-Z91
  - ◆ 10 MHz to 18 GHz (R&S®NRP-Z28), 9 kHz to 6 GHz (R&S®NRP-Z98)
  - ◆ Improvement of the absolute level accuracy of signal generators



*R&S®NRP-Z37 sensor*

## R&S®NRP-Z27/-Z37 power sensor modules

- ◆ Power sensors with additional RF signal output
- ◆ Developed for use with the R&S®FSMR measuring receiver
- ◆ For precise calibration of signal sources
- ◆ DC to 18 GHz (R&S®NRP-Z27), DC to 26.5 GHz (R&S®NRP-Z37)
- ◆ Level range  $-24$  dBm to  $+26$  dBm



# Applications and benefits

## Applications

- ◆ Power measurements on base stations and mobile equipment
- ◆ Measurement of pulsed radar signals
- ◆ EMC applications
- ◆ Design and production of components (e.g. power amplifiers)
- ◆ Statistical analysis of signals
- ◆ Antenna measurements
- ◆ Calibration of test and measurement equipment
- ◆ External level correction for signal generators

## Selection of benefits

### **Rohde & Schwarz is the most experienced supplier of USB power sensors...**

... this leads to reliable, mature and future-proof products and helps to reduce investment risks

### **USB sensors without compromises...**

... the R&S® NRP-Zxx sensors are USB sensors that can be used standalone and have no downside regarding versatility, accuracy and functionality

### **R&S® SmartSensorTechnology™...**

... makes it possible to achieve higher accuracy compared to classic designs for sensor and base unit

### **Wide variety of sensors...**

... the right sensor for every application

### **Measurements that are fast and accurate at the same time...**

... high throughput paired with measurement results that can be trusted

# Accurate measurement of TDMA-based signals

The analysis of the TDMA-based signals encountered in GSM/EDGE, DECT and PDC, for example, is a common application for state-of-the-art power measurement. The R&S®NRP-Z1x/-Z2x/-Z81 sensors are very powerful tools for such work. The trace mode makes graphical analysis of any signal very straightforward. The ability to easily modify the time axis plus the auto-scaling function provide useful support during in-depth analysis of relevant signal components.

The special timeslot function allows simultaneous analysis of multiple equidistant timeslots. Up to four timeslots can be simultaneously measured on the R&S®NRP base unit. During remote operation via GPIB or standalone operation of the sensor via USB, the number of timeslots that can be evaluated simultaneously increases accordingly.

| Operating mode                           | Sensor | R&S®NRP-Z1x,<br>R&S®NRP-Z2x | R&S®NRP-Z81 |
|--|--------|-----------------------------|-------------|
| R&S®NRP base unit (manual operation)     |        | 4                           | 4           |
| R&S®NRP base unit (remote GPIB)          |        | 28                          | 16          |
| Standalone operation of the sensor (USB) |        | 128                         | 16          |

### Number of timeslots that can be simultaneously evaluated

Exclude times at the edges of a timeslot make it possible to mask interfering signal components. By setting a measurement gate, it is possible to specifically measure individual signal components. Up to four measurement gates can be independently managed by the base unit. The R&S®NRP-Z81 wideband power sensor also provides a separate

fence function for each gate. This allows the user to keep track of the power at all times during the time segments of interest.

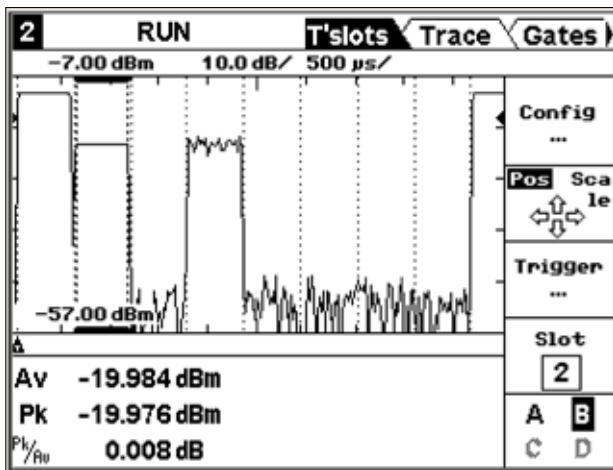

Timeslot mode for measurement of a GSM/EDGE signal

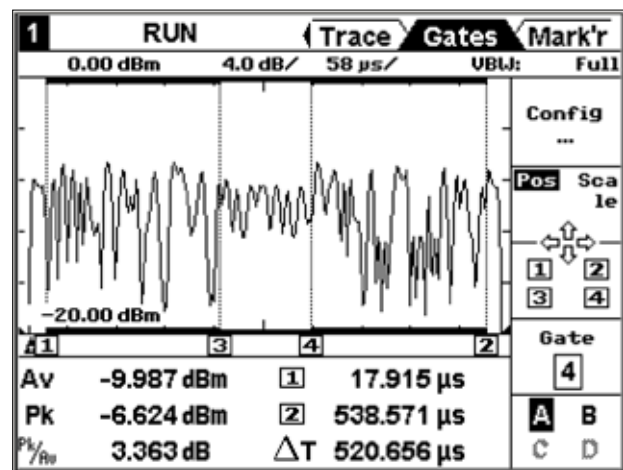

Determination of the power of an EDGE burst with the R&S®NRP-Z81 using the gate function; exclusion of the training sequence in the center of the signal by defining a fence

# Ready for the future – 3G signals and beyond

Radiocommunications standards such as 3GPP FDD, CDMA2000® as well as emerging standards such as 3GPP LTE (= long term evolution) exhibit very different power profiles depending on their channel utilization. Assessing these power profiles is a routine job with the sensors of the R&S®NRP family. This is true no matter whether you need to make a precision measurement of the average power, peak power or peak-to-average ratio in the time domain or you need fast statistical analysis to precisely determine the amplitude distribution.

Precision measurement of the average power is possible with the R&S®NRP-Z5x thermal power sensors and also using the advanced R&S®NRP-Z1x/-Z2x/-Z91 three-path diode sensors. This is true even for signals with a high peak-to-average ratio. Due to the continuous transition region of 6 dB between the different measurement ranges of the three-path diode sensors, measurements are always fast and precise even at the limits of the measurement paths. The innovative sensor architecture avoids the problem of having measurement range switching accompanied by a discontinuity in the measured values and by extended measurement times.

For peak power measurements, the R&S®NRP-Z81 wideband power sensor is available. This sensor has a maximum video bandwidth of 30 MHz to allow exact determination of the amplitude statistics for a specific signal. A measurement of the CCDF or PDF using one million samples can be performed by the R&S®NRP-Z81 sensor within a maximum of 25 ms at full video bandwidth. In addition, it is possible to perform statistical analysis in sync with the signal, i.e. limited to individual measurement gates. This means that the R&S®NRP-Z81 is well equipped for current mobile radio standards as well as future standards.

CDMA2000® is a registered trademark of the Telecommunications Industry Association (TIA - USA).

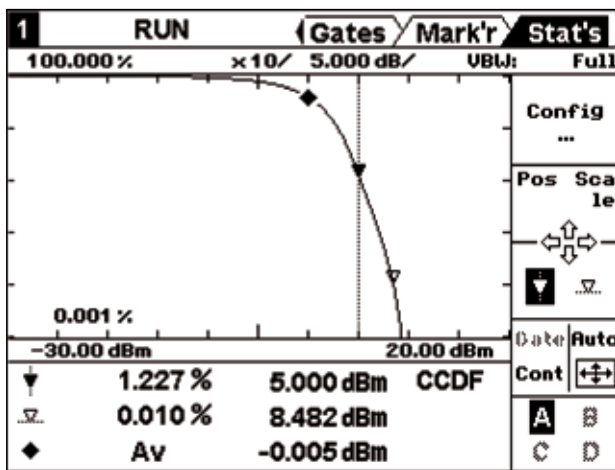

Signal statistics: CCDF of a 3GPP EUTRA/LTE signal; one million samples were recorded by using the R&S®NRP-Z81 within 25 ms at 30 MHz VBW

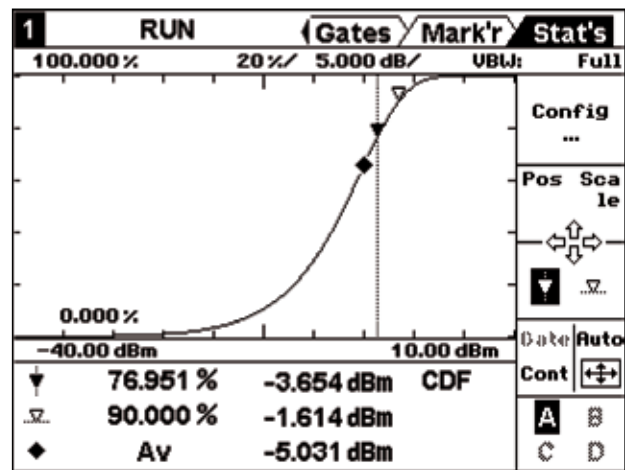

Signal statistics: CDF of a 3GPP FDD signal recorded by means of the R&S®NRP-Z81; the horizontal and vertical markers enable precise analysis work (as with the PDF and CCDF)

# Superior performance for WLAN/ WiMAX

The broadband signals encountered in wireless local area networks (WLANs) and wireless metropolitan area networks (WMANs) make special demands when it comes to power measurements. WiMAX in particular necessitates economical exploitation of available power resources. Achieving the longest possible battery life for mobile phones, for example, is only one of the many challenging design objectives here.

## Measurement of OFDMA signals

To accomplish this task, users can rely on the R&S®NRP-Z1x/-Z2x universal power sensors and the R&S®NRP-Z81 wideband power sensor. The trace mode allows uncomplicated time-domain analysis of the signals. As a result of their architecture, both the R&S®NRP-Z1x/-Z2x three-path diode sensors and the R&S®NRP-Z81 wideband power sensor can process broadband signals with OFDM or OFDMA modulation without any loss of accuracy or functionality. The continuous average power is measured over wide ranges with an accuracy comparable to that of a thermal sensor. Peak power measurements and analysis of signal statistics become routine tasks when using the R&S®NRP-Z81.

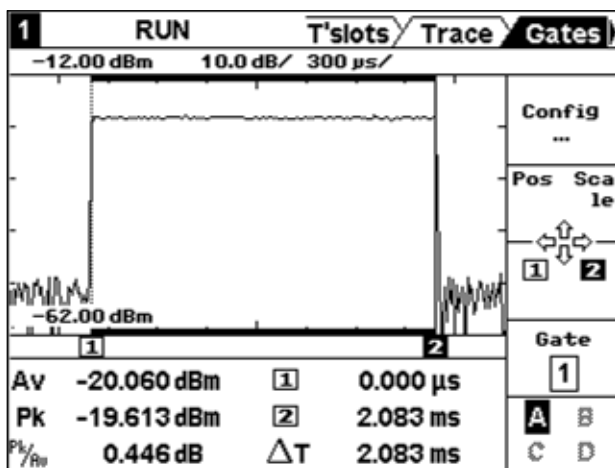

Measurement of the average power of a WLAN IEEE 802.11n signal using the R&S®NRP-Z21

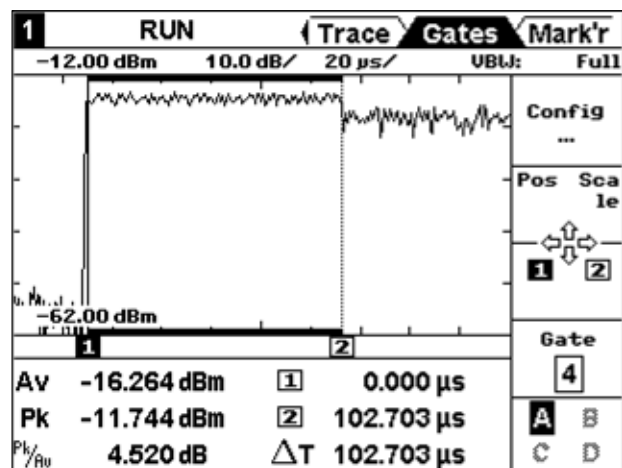

Time gating for measuring the preamble power of a modulated WiMAX IEEE 802.16-2005 OFDMA signal using the R&S®NRP-Z81

# Radar applications and EMC measurements

## Radar applications

The R&S®NRP-Z81 wideband power sensor is suitable for the time-domain analysis of pulses. With its 30 MHz bandwidth and typical rise time of 11 ns, even steep edges can be handled (such as occur in radar signals).

Even non-repetitive pulse sequences where each pulse exhibits a different power level can be precisely measured. Using the sensor's buffered mode at 1500 measurements/s, the measurements are performed so fast that it is possible to reliably measure the power of all of the pulses even in the presence of high pulse repetition rates and short pulses. Measured values are buffered in the sensor and the content of the result memory is transferred block by block to the R&S®NRP base unit or a control PC. This ensures reliable detection even of rarely occurring signal phenomena.

## EMC measurements

In EMC applications, usually only the average power is of interest. This is where the R&S®NRP-Z91/-Z92/-Z98 sensors come into their own. They cover the measurement ranges that are used in radiotelecommunications (up to 6 GHz) as well as the important lower frequency bands (down to 9 kHz).

As before, users benefit from the excellent properties of the three-path diode sensors, including a dynamic range of up to 90 dB, very low influence of the modulation on the measurement, outstanding impedance matching and minimal influence from harmonics.



*R&S®NRP-Zxx sensors for accurate measurement of pulsed radar signals*

# Component tests with high throughput

With components such as MCPAs, the primary focus is on measuring the transmission behavior with a spectrum analyzer and also on precisely determining the rms output power, the gain and the input impedance matching.

The R&S®NRP family provides an outstanding solution for such applications. The R&S®NRP base unit enables the simultaneous evaluation of the results delivered by the sensors used. This makes it possible to correctly measure the input and output power of a power amplifier as well as to accurately determine the gain and impedance matching by calculating the ratios.

| Sensor                | Windows | Measurement    | File               | System            |
|-----------------------|---------|----------------|--------------------|-------------------|
| <b>1 Input Power</b>  |         |                |                    |                   |
| A                     |         | <b>1.960mW</b> | R                  | 3.400GHz          |
| <b>2 Output Power</b> |         |                |                    |                   |
| C                     |         | <b>0.137W</b>  | C                  | 3.400GHz          |
| <b>3 Input Match</b>  |         |                |                    |                   |
| RC (A,B)              |         | <b>0.210</b>   | $\bar{x}$ 2.096e-1 | $\sigma$ 6.903e-5 |
| <b>4 Gain</b>         |         |                |                    |                   |
| C/A                   |         | <b>18.44dB</b> | $\bar{f}$ 18.452dB | $\pm$ 18.434dB    |

*Simultaneous display of up to four different measurement results; mathematical calculation of reflection coefficient and gain*

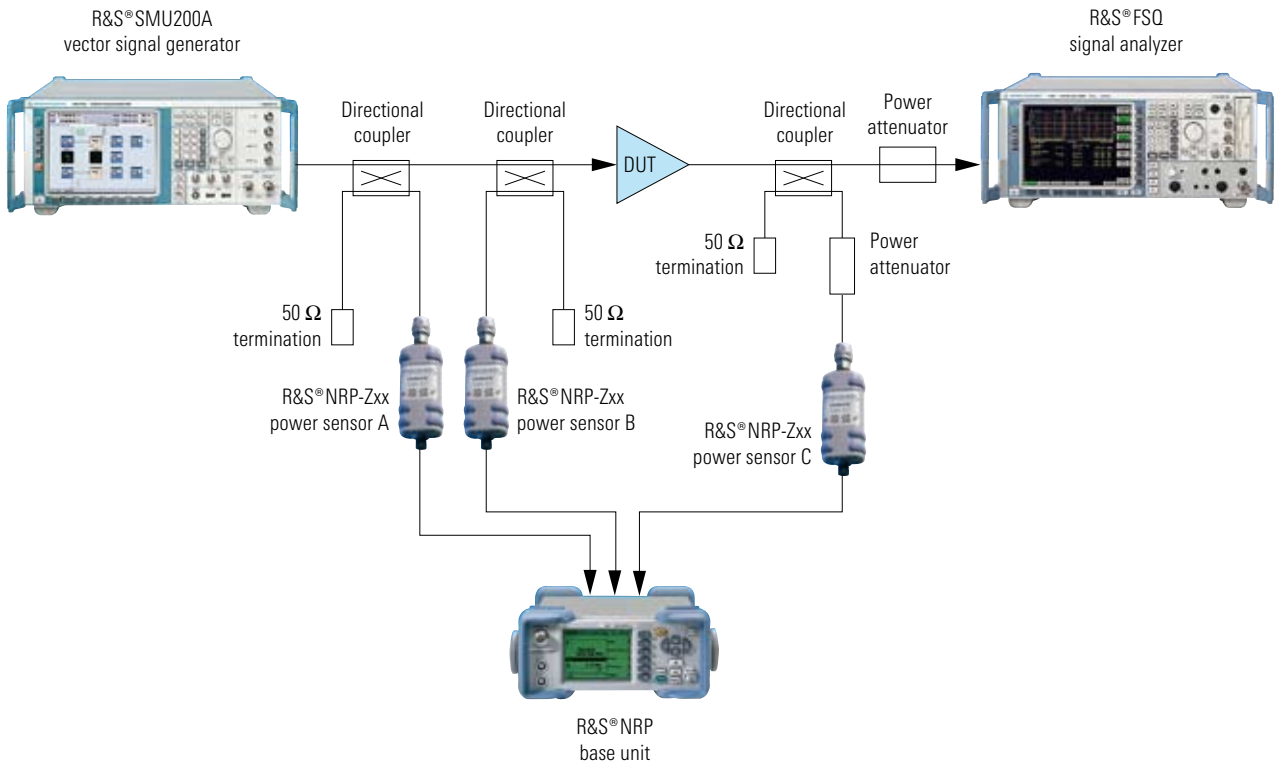

*Typical test setup for MCPA tests; calculation functions of the R&S®NRP allow impedance matching and gain to be determined*

## Minimized uncertainty

Even complex test setups represent no challenge for the sensors of the R&S®NRP family. Interference effects are easily compensated using offset, S-parameter and  $\Gamma$  correction. Offset correction helps to take into account non-frequency-dependent attenuation. S-parameter correction is used to mathematically shift the reference plane directly to the device under test (DUT) by taking into account the S-parameters for any components connected upstream.  $\Gamma$  correction makes it easy to reduce mismatch.

## Enhanced auto averaging filter

Using the enhanced auto averaging function (a feature of all the sensors of the R&S®NRP family), any measurement can be optimized in respect of measurement time and accuracy. After entry of the maximum permissible noise content, the measurement filter is automatically set for the optimum value. This helps to achieve the shortest possible measurement time and thus the maximum production throughput with a specified accuracy.

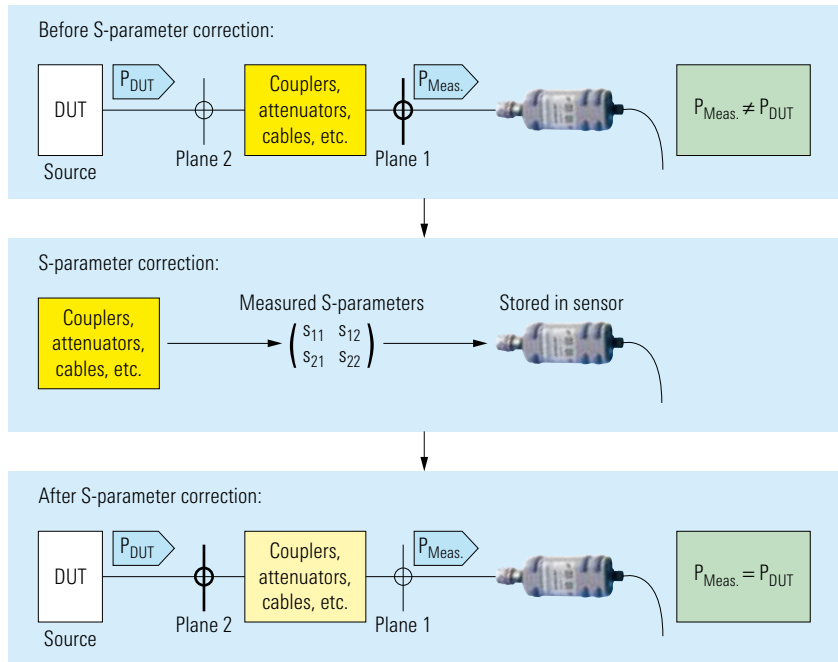

*Shifting the measurement plane from 1 to 2 by means of S-parameter correction; the influence of additional components is compensated*

| Sensor Windows Measurement File System |               |           |            |
|--|---------------|-----------|------------|
| 1                                      | A (T'gate 1)  |           | System     |
| $\Sigma$                               | 0.0500 dB S/N |           |            |
| $\bar{x}$                              |               |           |            |
| $\sigma$                               |               |           |            |
| $\Sigma$                               |               |           |            |
| <b>A<sub>1</sub></b>                   |               | $\bar{x}$ | -2.556 dBm |
| <b>-2.518 dBm</b>                      |               | $\sigma$  | 0.021 dB   |
|  |               | $\Sigma$  | 465        |

*Time-gated measurement with fixed noise content for defined accuracy*

| Sensor Windows Measurement File System |  |                 |  |
|--|--|-----------------|--|
| Auto Filter                            |  |                 |  |
| A B C D                                |  |                 |  |
| Normal                                 |  | Fixed Noise     |  |
| Ref Timeslot                           |  | Noise Content   |  |
| 1                                      |  | 0.0500 dB       |  |
|  |  | Max. Sett. Time |  |
|  |  | 4.00 s          |  |

*Configuration window for enhanced auto averaging filter*

# Test and measurement setups made easy

The R&S®NRP base unit and the USB sensors are easy to integrate into systems. Particularly in applications on production lines, investment costs can be cut to a minimum owing to the standalone operation of the USB sensors.

## Easy system integration

The base unit and sensors are easily integrated into automated test setups with the available drivers (LabVIEW, LabWindows/CVI, VXI). The R&S®NRP base unit can be remote-controlled via GPIB, LAN (R&S®NRP-B4) or USB.

## Standalone use of sensors

Each R&S®NRP sensor is an independent test instrument and can be operated directly via USB. Due to the large dynamic range of the sensors, no external triggering is required in many cases. The sensors are typically connected using the R&S®NRP-Z4 passive USB adapter. An alternative choice is the R&S®NRP-Z3 active USB adapter with its external trigger input.

Regardless of the type of sensor connection used, no sensor calibration is required prior to making measurements since calibration data is stored directly in the sensor at the factory.

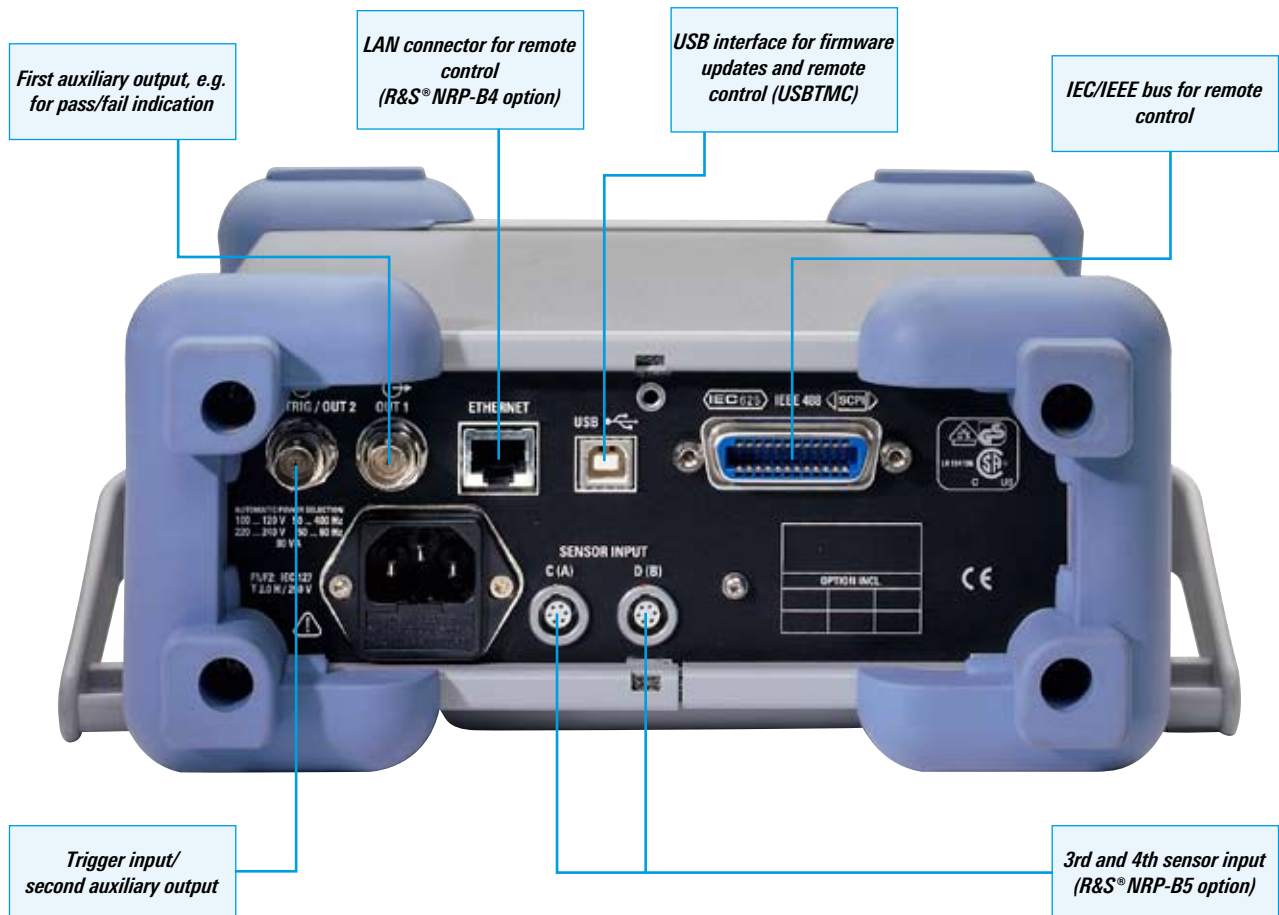



## Flexible operation

When using the R&S®NRP-Zxx sensors, you are not limited in your choice of operating system on the control PC. The R&S®NRP-Zxx sensors work reliably with both the Windows and Linux operating systems.

Greater distances between the point of measurement and the evaluation computer (up to 100 m) can be reliably bridged using USB extenders.

## Connection to other Rohde & Schwarz equipment

The latest generation of signal generators, spectrum analyzers and network analyzers can all be connected to the R&S®NRP-Zxx sensors. This allows you to directly display the average power measured with the sensor without the need for an R&S®NRP base unit or PC. This also provides a simple solution for automatic level correction in a signal generator. The spectrum analyzers use the measured power as an absolute reference for increasing the measurement accuracy.

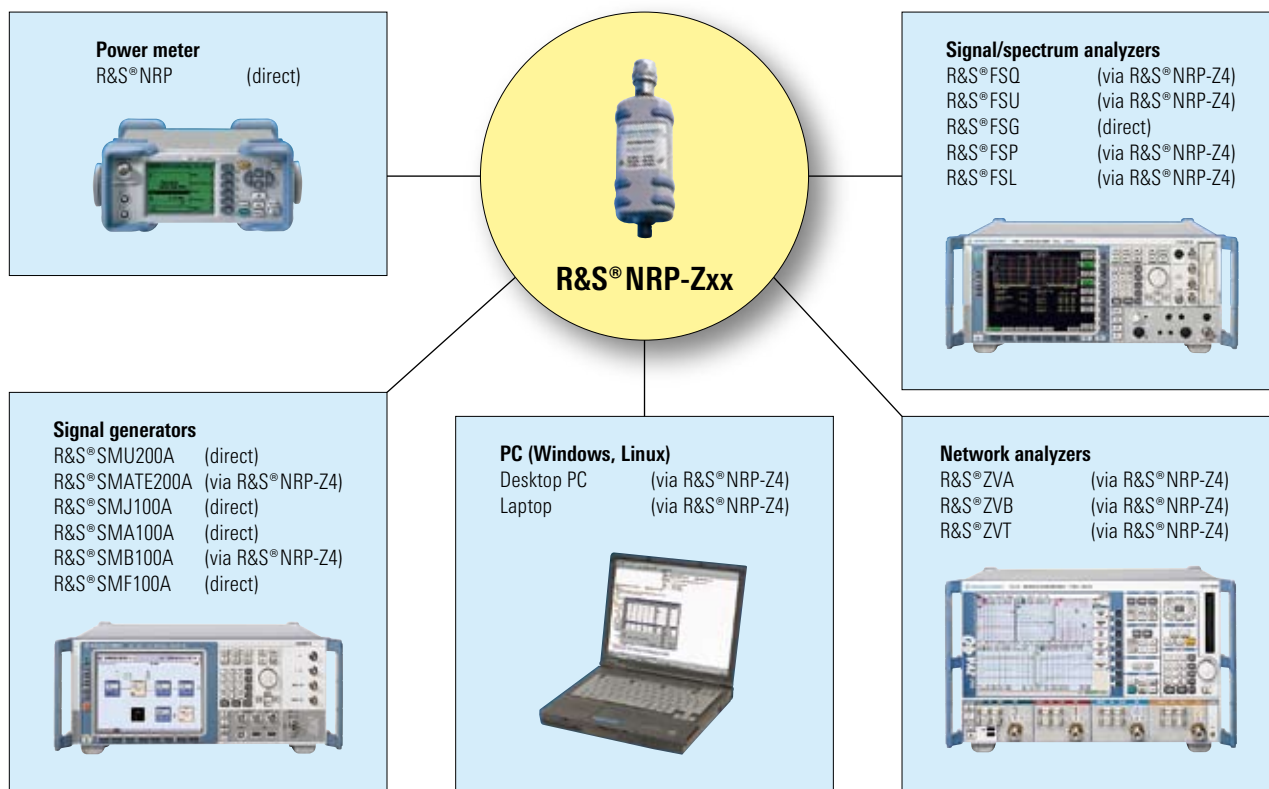

Versatile use of the R&S®NRP-Zxx power sensors

# Special tasks – special sensors

## Level correction for signal generators

When connected to signal generators from Rohde & Schwarz, the sensors of the R&S®NRP family allow automatic level correction. This involves two-dimensional correction not just for a specific level but also across the entire frequency and level range of the sensor. This optimization ensures, for example, a flat frequency response at the device under test – even for different output levels of the signal generator.

### Supported signal generators

- ◆ R&S®SMU200A
- ◆ R&S®SMJ100A
- ◆ R&S®SMATE200A
- ◆ R&S®SMA100A <sup>1)</sup>
- ◆ R&S®SMF100A <sup>1)</sup>
- ◆ R&S®SMB100A <sup>1)</sup>

## Level control sensors

The R&S®NRP-Z28/-Z98 with integrated power splitter was developed especially for monitoring the power fed into the device under test (DUT). The sensor is a permanent part of the test setup. To perform a power measurement, it is not necessary to disconnect the DUT from the RF source. Optimal impedance matching to the DUT is also obtained for the measurement. Additional uncertainties caused, for example, by the cable loss between the signal generator and DUT are avoided. Distances of up to 1.2 m are bridged by a low-loss microwave cable. Besides a pure power measurement, the R&S®NRP-Z28/-Z98 level control sensors allow automatic level correction together with the Rohde & Schwarz signal generators.



**Automatic level correction for the R&S®SMJ100A signal generator using the R&S®NRP-Z11/-Z21 terminating power sensor**

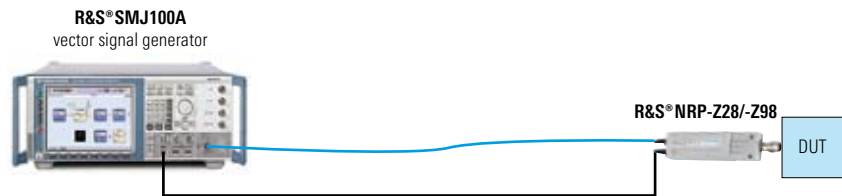

**Constant monitoring of signal generator output power and/or automated level correction using the R&S®NRP-Z28/-Z98 level control sensor**

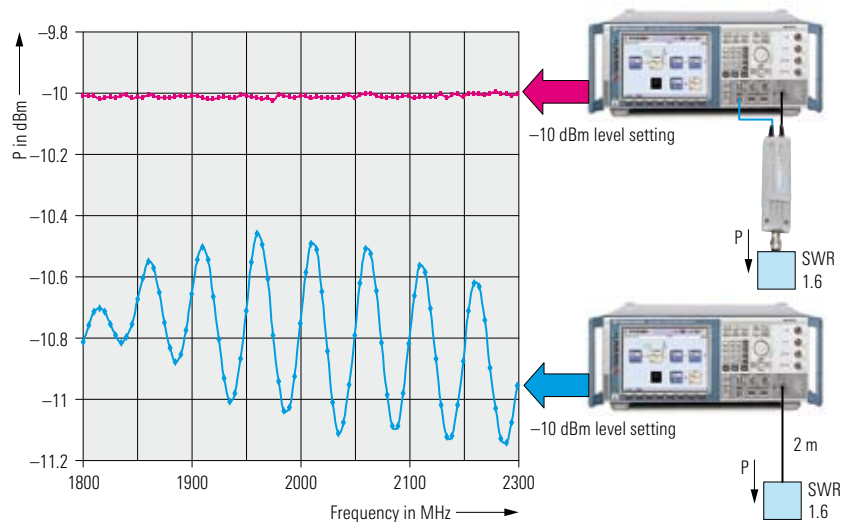

**Frequency response after automatic level correction using the R&S®NRP-Z28 level control sensor (upper graph) and measurement results in a conventional setup due to mismatch (lower graph)**

## Solution for accurate calibration

Due to their accuracy, the R&S®NRP sensors are ideally suited for applications in calibration laboratories. All power sensors from Rohde & Schwarz can be traced directly to the power standards of the German Standards Laboratory (PTB).

The R&S®NRP-Z27 and -Z37 power sensor modules were developed especially for level calibration using the R&S®FSMR measuring receiver. These sensors act as highly accurate references for determining the absolute power level. Together with the excellent linearity of the R&S®FSMR, this enables precise power calibration over the entire level range of the measuring receiver. Using an integrated power splitter, the power is fed to the integrated R&S®NRP-Z27/-Z37 thermal power sensor module and simultaneously to the measuring receiver via a phase-stable cable.

Where used together with the R&S®FSMR, the intelligent power sensor module achieves excellent calibration accuracy.

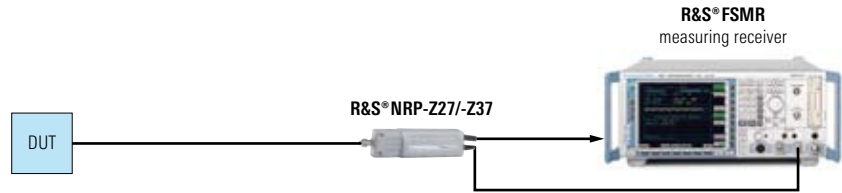

*R&S®FSMR measuring receiver with the R&S®NRP-Z27/-Z37 power sensor module*



*R&S®FSMR measuring receiver with the R&S®NRP-Z37 power sensor module*

<sup>1)</sup> Only one-dimensional correction for set output level.

# R&S®NRP-Zxx sensor overview

| Sensor connector  | Frequency range  | Power measurement range; maximum input power                              | Impedance matching (SWR)  | Rise time, video BW     | Accuracy <sup>1)</sup> |
|---|------------------|---|---|-------------------------|------------------------|
| <b>Universal power sensors</b>                              |                  |   |   |                         |                        |
| R&S®NRP-Z11<br>N connector                                  | 10 MHz to 8 GHz  | 200 pW to 200 mW (–67 dBm to +23 dBm);<br>400 mW (AVG), 1 W (PK, 10 µs)   | 10 MHz to 2.4 GHz <1.13<br>>2.4 GHz to 8.0 GHz <1.20  | <8 µs,<br>>50 kHz       | 0.058 dB               |
| R&S®NRP-Z21<br>N connector                                  | 10 MHz to 18 GHz | 200 pW to 200 mW (–67 dBm to +23 dBm);<br>400 mW (AVG), 1 W (PK, 10 µs)   | 10 MHz to 2.4 GHz <1.13<br>>2.4 GHz to 8.0 GHz <1.20<br>>8.0 GHz to 18.0 GHz <1.25  | <8 µs,<br>>50 kHz       | 0.058 dB               |
| R&S®NRP-Z22<br>N connector                                  | 10 MHz to 18 GHz | 2 nW to 2 W (–57 dBm to +33 dBm);<br>3 W (AVG), 10 W (PK, 10 µs)          | 10 MHz to 2.4 GHz <1.14<br>>2.4 GHz to 8.0 GHz <1.20<br>>8.0 GHz to 12.4 GHz <1.25<br>>12.4 GHz to 18.0 GHz <1.30   | <8 µs,<br>>50 kHz       | 0.085 dB               |
| R&S®NRP-Z23<br>N connector                                  | 10 MHz to 18 GHz | 20 nW to 15 W (–47 dBm to +42 dBm);<br>18 W (AVG), 100 W (PK, 10 µs)      | 10 MHz to 2.4 GHz <1.14<br>>2.4 GHz to 8.0 GHz <1.25<br>>8.0 GHz to 12.4 GHz <1.30<br>>12.4 GHz to 18.0 GHz <1.41   | <8 µs,<br>>50 kHz       | 0.087 dB               |
| R&S®NRP-Z24<br>N connector                                  | 10 MHz to 18 GHz | 60 nW to 30 W (–42 dBm to +45 dBm);<br>36 W (AVG), 300 W (PK, 10 µs)      | 10 MHz to 2.4 GHz <1.14<br>>2.4 GHz to 8.0 GHz <1.25<br>>8.0 GHz to 12.4 GHz <1.30<br>>12.4 GHz to 18.0 GHz <1.41   | <8 µs,<br>>50 kHz       | 0.088 dB               |
| <b>Wideband power sensors</b>                               |                  |   |   |                         |                        |
| R&S®NRP-Z81<br>N connector                                  | 50 MHz to 18 GHz | 1 nW to 100 mW (–60 dBm to +20 dBm);<br>200 mW (AVG), 1 W (PK, 1 µs)      | 50 MHz to 2.4 GHz <1.16<br>>2.4 GHz to 8.0 GHz <1.20<br>>8.0 GHz to 18.0 GHz <1.25  | <13 ns,<br>up to 30 MHz | 0.13 dB                |
| <b>Average power sensors</b>                                |                  |   |   |                         |                        |
| R&S®NRP-Z91<br>N connector                                  | 9 kHz to 6 GHz   | 200 pW to 200 mW (–67 dBm to +23 dBm);<br>400 mW (AVG), 1 W (PK, 10 µs)   | 9 kHz to 2.4 GHz <1.13<br>>2.4 GHz to 6.0 GHz <1.20   | –                       | 0.058 dB               |
| R&S®NRP-Z92<br>N connector                                  | 9 kHz to 6 GHz   | 2 nW to 2 W (–57 dBm to +33 dBm);<br>3 W (AVG), 10 W (PK, 10 µs)          | 9 kHz to 2.4 GHz <1.14<br>>2.4 GHz to 6.0 GHz <1.20   | –                       | 0.085 dB               |
| <b>Thermal power sensors</b>                                |                  |   |   |                         |                        |
| R&S®NRP-Z51<br>N connector                                  | DC to 18 GHz     | 1 µW to 100 mW (–30 dBm to +20 dBm);<br>300 mW (AVG), 10 W (PK, 1 µs)     | DC to 2.4 GHz <1.10<br>>2.4 GHz to 12.4 GHz <1.15<br>>12.4 GHz to 18.0 GHz <1.20  | –                       | 0.061 dB               |
| R&S®NRP-Z52<br>3.5 mm connector                             | DC to 18 GHz     | 1 µW to 100 mW (–30 dBm to +20 dBm);<br>300 mW (AVG), 10 W (PK, 1 µs)     | DC to 2.4 GHz <1.10<br>>2.4 GHz to 12.4 GHz <1.15<br>>12.4 GHz to 18.0 GHz <1.20  | –                       | 0.068 dB               |
| R&S®NRP-Z55<br>2.92 mm connector                            | DC to 40 GHz     | 1 µW to 100 mW (–30 dBm to +20 dBm);<br>300 mW (AVG), 10 W (PK, 1 µs)     | DC to 2.4 GHz <1.10<br>>2.4 GHz to 12.4 GHz <1.15<br>>12.4 GHz to 18.0 GHz <1.20<br>>18.0 GHz to 26.5 GHz <1.25<br>>26.5 GHz to 40.0 GHz <1.30                            | –                       | 0.068 dB               |
| <b>Level control sensors</b>                                |                  |   |   |                         |                        |
| R&S®NRP-Z28<br>N connector                                  | 10 MHz to 18 GHz | 200 pW to 100 mW (–67 dBm to +20 dBm);<br>>700 mW (AVG), >4 W (PK, 10 µs) | 10 MHz to 2.4 GHz <1.11<br>>2.4 GHz to 4.0 GHz <1.15<br>>4.0 GHz to 8.0 GHz <1.22<br>>8.0 GHz to 18.0 GHz <1.30   | <8 µs,<br>>50 kHz       | 0.058 dB               |
| R&S®NRP-Z98<br>N connector                                  | 9 kHz to 6 GHz   | 200 pW to 100 mW (–67 dBm to +20 dBm);<br>>700 mW (AVG), >4 W (PK, 10 µs) | 9 kHz to 2.4 GHz <1.11<br>>2.4 GHz to 4.0 GHz <1.15<br>>4.0 GHz to 6.0 GHz <1.22  | –                       | 0.058 dB               |
| <b>Power sensor modules (for use with the R&amp;S®FSMR)</b> |                  |   |   |                         |                        |
| R&S®NRP-Z27<br>N connector                                  | DC to 18 GHz     | 4 µW to 400 mW (–24 dBm to +26 dBm);<br>500 mW (AVG), 30 W (PK, 1 µs)     | DC to 2.0 GHz <1.15<br>>2.0 GHz to 4.2 GHz <1.18<br>>4.3 GHz to 8.0 GHz <1.23<br>>8.0 GHz to 12.4 GHz <1.25<br>>12.4 GHz to 18 GHz <1.35                                  | –                       | 0.075 dB               |
| R&S®NRP-Z37<br>3.5 mm connector                             | DC to 26.5 GHz   | 4 µW to 400 mW (–24 dBm to +26 dBm);<br>500 mW (AVG), 30 W (PK, 1 µs)     | DC to 2.0 GHz <1.15<br>>2.0 GHz to 4.2 GHz <1.18<br>>4.3 GHz to 8.0 GHz <1.23<br>>8.0 GHz to 12.4 GHz <1.25<br>>12.4 GHz to 18.0 GHz <1.30<br>>18.0 GHz to 26.5 GHz <1.45 | –                       | 0.075 dB               |

# Ordering information

| Designation   | Type        | Order No.    |
|---|-------------|--------------|
| <b>Base Unit</b>  |             |              |
| Power Meter   | R&S®NRP     | 1143.8500.02 |
| <b>Options</b>  |             |              |
| Sensor Check Source   | R&S®NRP-B1  | 1146.9008.02 |
| Second Sensor Input (B)                                     | R&S®NRP-B2  | 1146.8801.02 |
| Battery Supply  | R&S®NRP-B3  | 1146.8501.02 |
| Ethernet LAN Interface 10/100 BaseT                         | R&S®NRP-B4  | 1146.9308.02 |
| 3rd and 4th Sensor Inputs (C, D) <sup>2)</sup>              | R&S®NRP-B5  | 1146.9608.02 |
| Rear-Panel Sensor Inputs A and B <sup>3)</sup>              | R&S®NRP-B6  | 1146.9908.02 |
| <b>Universal Power Sensors</b>                              |             |              |
| 200 pW to 200 mW, 10 MHz to 8 GHz                           | R&S®NRP-Z11 | 1138.3004.02 |
| 200 pW to 200 mW, 10 MHz to 18 GHz                          | R&S®NRP-Z21 | 1137.6000.02 |
| 2 nW to 2 W, 10 MHz to 18 GHz                               | R&S®NRP-Z22 | 1137.7506.02 |
| 20 nW to 15 W, 10 MHz to 18 GHz                             | R&S®NRP-Z23 | 1137.8002.02 |
| 60 nW to 30 W, 10 MHz to 18 GHz                             | R&S®NRP-Z24 | 1137.8502.02 |
| <b>Thermal Power Sensors</b>                                |             |              |
| 1 µW to 100 mW, DC to 18 GHz                                | R&S®NRP-Z51 | 1138.0005.02 |
| 1 µW to 100 mW, DC to 18 GHz                                | R&S®NRP-Z52 | 1138.0505.18 |
| 1 µW to 100 mW, DC to 40 GHz                                | R&S®NRP-Z55 | 1138.2008.02 |
| <b>Wideband Power Sensors</b>                               |             |              |
| 1 nW to 100 mW, 50 MHz to 18 GHz                            | R&S®NRP-Z81 | 1137.9009.02 |
| <b>Average Power Sensors</b>                                |             |              |
| 200 pW to 200 mW, 9 kHz to 6 GHz                            | R&S®NRP-Z91 | 1168.8004.02 |
| 2 nW to 2 W, 9 kHz to 6 GHz                                 | R&S®NRP-Z92 | 1171.7005.02 |
| <b>Level Control Sensors</b>                                |             |              |
| 200 pW to 100 mW, 10 MHz to 18 GHz                          | R&S®NRP-Z28 | 1170.8008.02 |
| 200 pW to 100 mW, 9 kHz to 6 GHz                            | R&S®NRP-Z98 | 1170.8508.02 |
| <b>Power Sensor Modules (for use with the R&amp;S®FSMR)</b> |             |              |
| 4 µW to 400 mW, DC to 18 GHz                                | R&S®NRP-Z27 | 1169.4102.02 |
| 4 µW to 400 mW, DC to 26.5 GHz                              | R&S®NRP-Z37 | 1169.3206.02 |
| <b>Recommended extras</b>                                   |             |              |
| Sensor Extension Cable to 5 m                               | R&S®NRP-Z2  | 1146.6750.05 |
| Sensor Extension Cable to 10 m <sup>4)</sup>                | R&S®NRP-Z2  | 1146.6750.10 |
| USB Adapter (active)  | R&S®NRP-Z3  | 1146.7005.02 |
| USB Adapter (passive)                                       | R&S®NRP-Z4  | 1146.8001.02 |
| 19" Rack Adapter (for one R&S®NRP)                          | R&S®ZZA-T26 | 1109.4387.00 |
| 19" Rack Adapter (for two R&S®NRPs)                         | R&S®ZZA-T27 | 1109.4393.00 |

<sup>1)</sup> Uncertainty for absolute power measurements; CW, 1 GHz to 4 GHz, 0 dBm, +20 °C to +25 °C. For complete specifications, please refer to the R&S®NRP power meter data sheet (PD 5213.5539.22).

<sup>2)</sup> R&S®NRP-B2 option required.

<sup>3)</sup> Not in conjunction with the R&S®NRP-B5.

<sup>4)</sup> Not in conjunction with the R&S®NRP-Z81.



More information at  
[www.rohde-schwarz.com](http://www.rohde-schwarz.com)  
(search term: NRP)



[www.rohde-schwarz.com](http://www.rohde-schwarz.com)

Europe, Latin America, Africa, Middle East Tel. +49 1805 124242\* or +49 89 4129 13774 customersupport@rohde-schwarz.com  
North America 1 888 837 8772 customersupport@rohde-schwarz.com  
Asia | Pacific +65 65 130 488 customersupport@rohde-schwarz.com