



***The US Natural Gas Compression
Infrastructure:
Opportunities for Efficiency
Improvements***

Klaus Brun, Ph.D.

Director R&D, Elliott Group

University Turbine Systems Research Symposium

October 2018

The Journey of Natural Gas

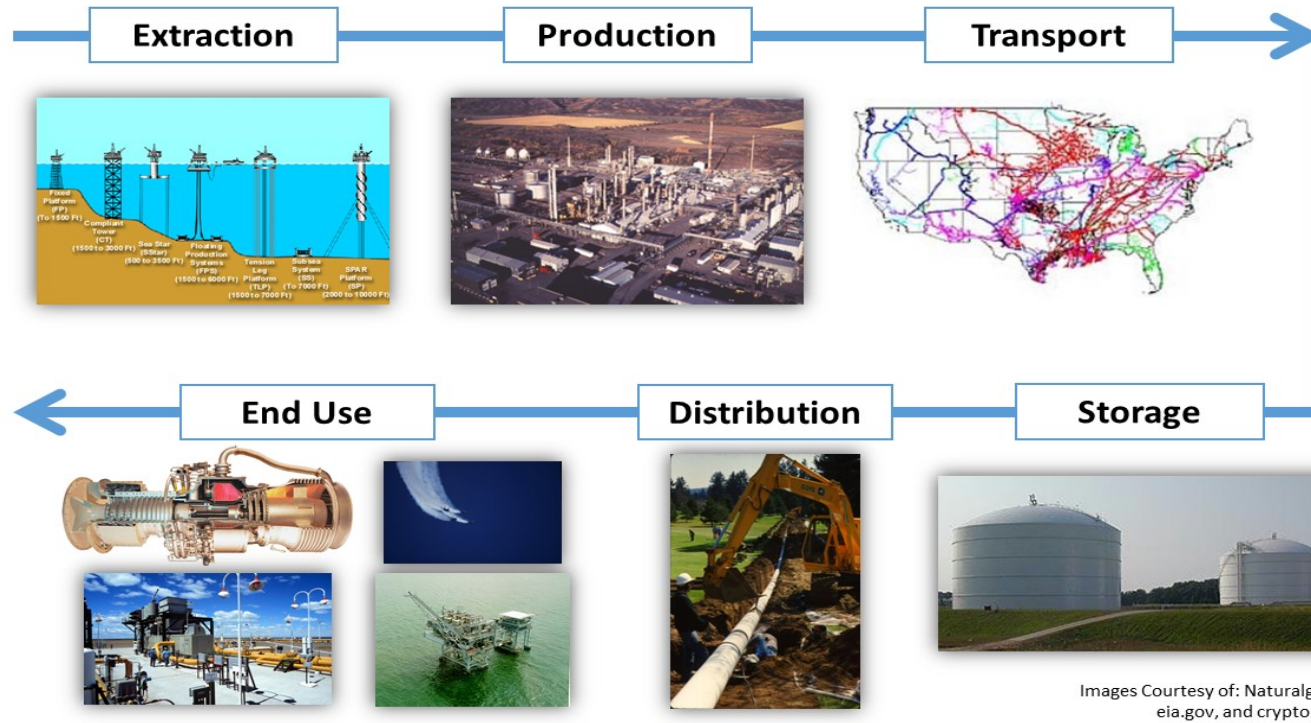

Machinery Applications

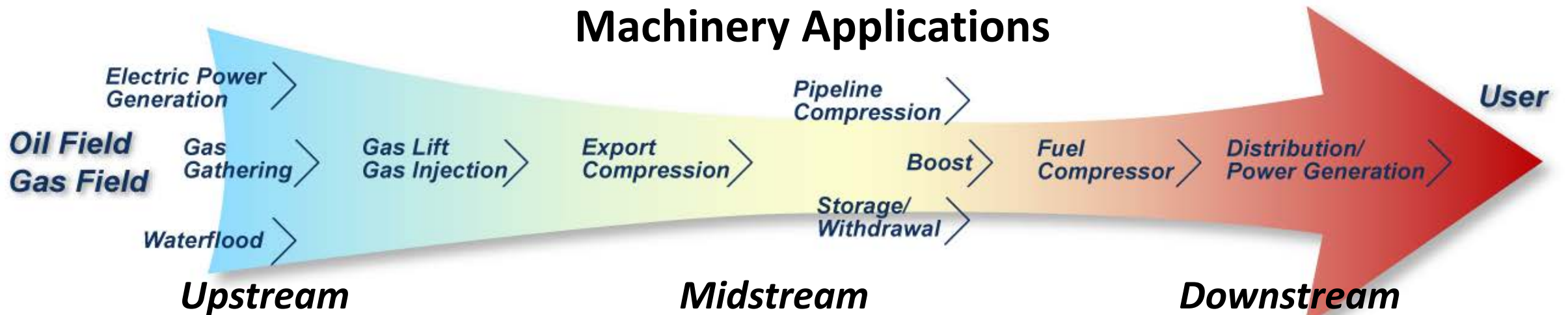

Background: Oil & Gas Compressors

- Compressors are used for natural gas gathering, transport, processing, storage, and distribution (fuel gas)
- US has approximately 1,700 midstream natural gas pipeline compressor stations with a total of 5,000-7,000 compressors
- US has approximately 13,000-15,000 smaller compressors in upstream and 2,000-3,000 compressors (all sizes) in downstream oil & gas and LNG applications.
- DOE estimates that 2-3% of US natural gas is utilized by oil & gas compressors (includes consumption and leakage)

Oil & Gas Compressors are High Visibility Targets for Efficiency Improvements

US Natural Gas Production

U.S. Dry Natural Gas Production By Resource Type

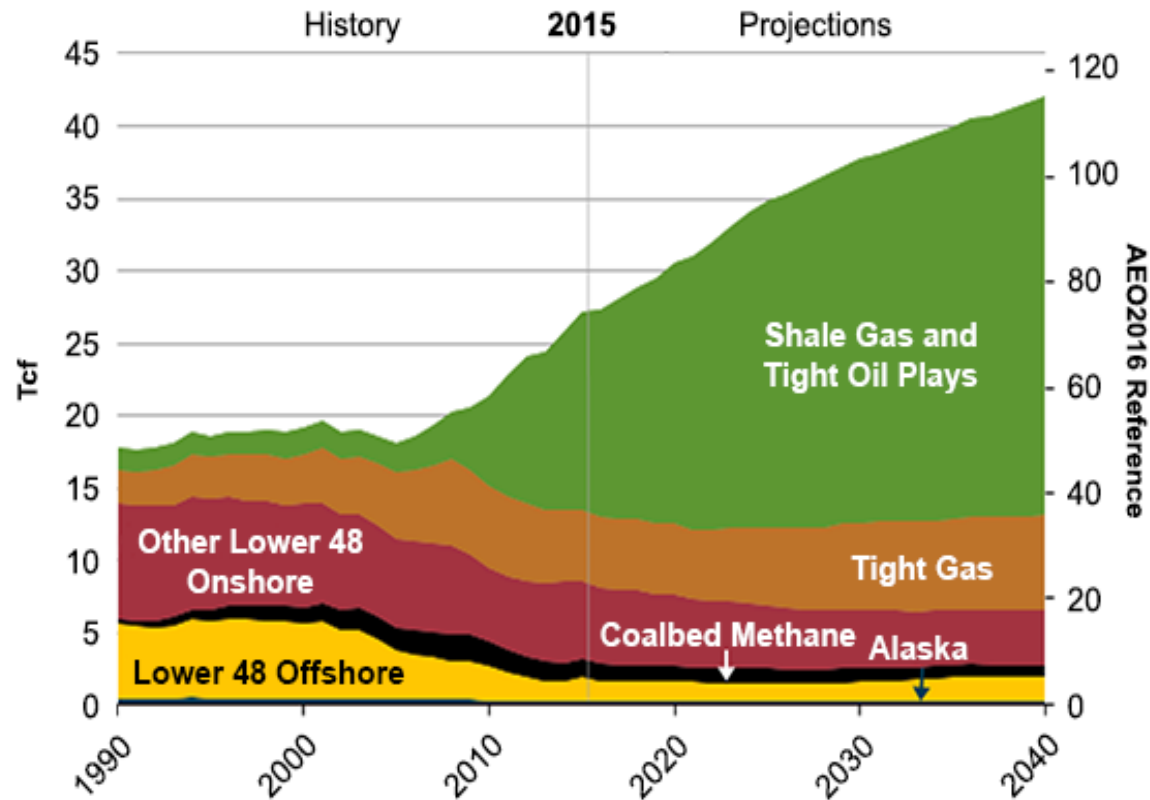

Source: EIA Annual Energy Outlook 2016

U.S. natural gas consumption by sector (2000-2050)

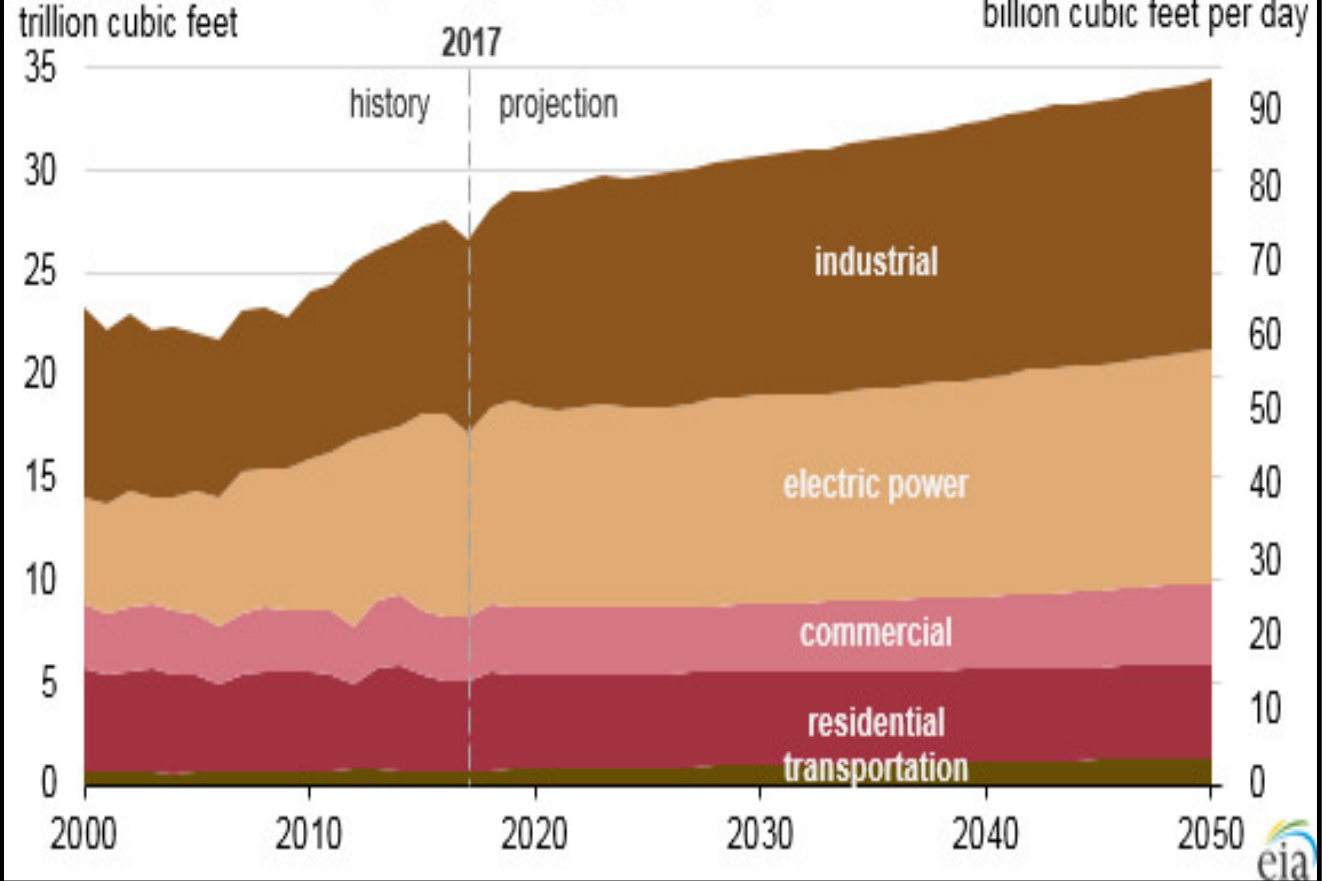

Source: US DOE EIA, Wood Mackenzie

Plenty of Gas for Growth...and then some for LNG Export

Energy Costs – What it means to an economy!

Natural Gas Prices by Region in US Dollars Per Million BTU

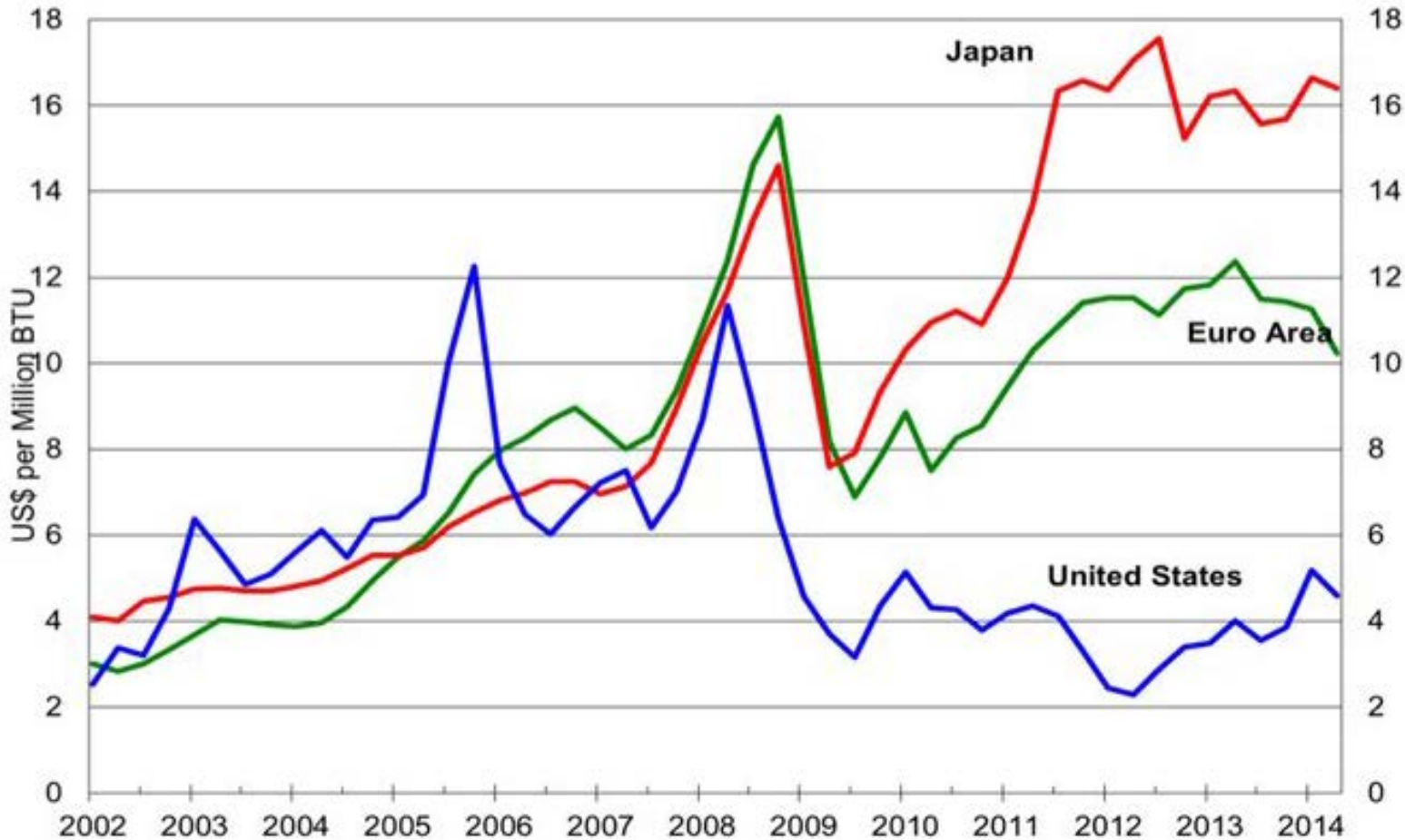

Sources: World Bank and Citi Research

2015 USA:
75 bcf/d consumption at
\$4.5/MMBTU

= 335 million Dollars per day
= 122 billion Dollars per year

≈ The price of 80-100 new
large NGCC (750MW Each)
power plants per year

Pipeline Compression History: Horizontal Compressor

- Original pipeline prime mover first installed in the 1930s.
- Internal combustion spark ignited, four cylinder unit (1700 bhp supercharged) running at 125 rpm.
- Power cylinders are horizontal-opposing.
- Most of these units (Cooper and Worthington) have been replaced with integral horsepower
- Some remain in operation with Tennessee Gas, Northern Natural and Panhandle Eastern.

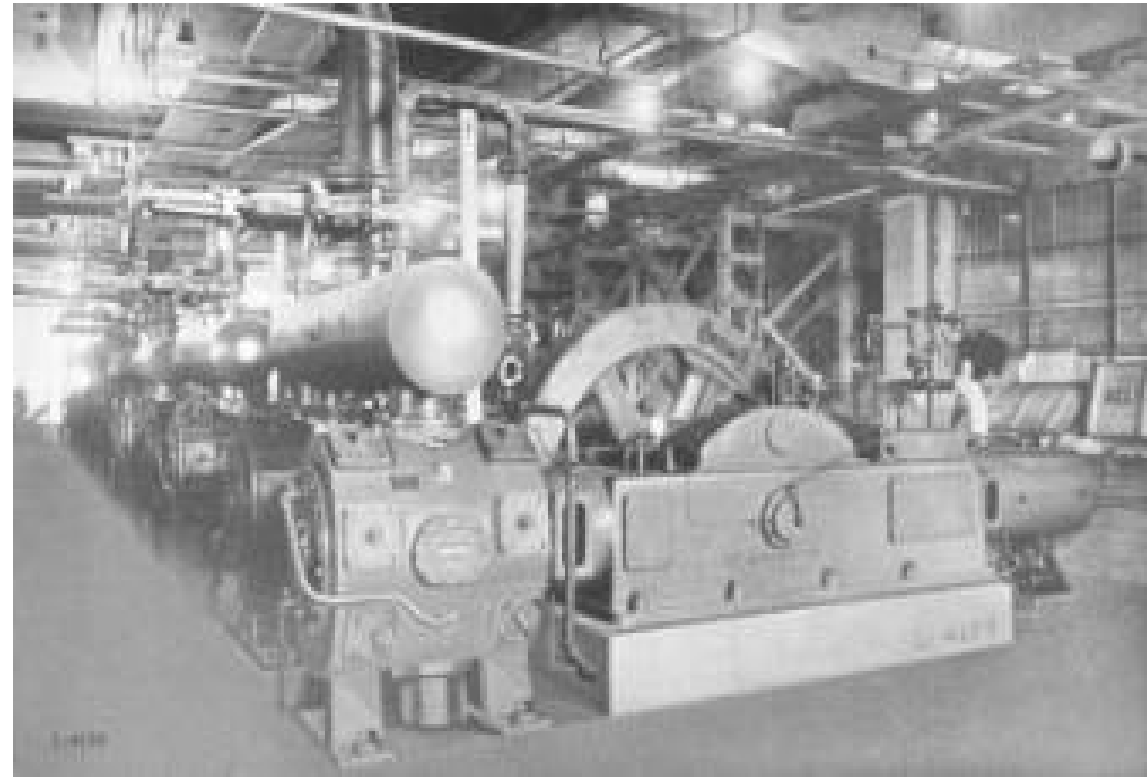

Pipeline Compression History: Gas Integral Compressors

- Internal combustion, spark ignited, engine driver with integral reciprocating compressor (the engine and compressor share the same crankshaft).
- Majority of these units were installed from the 1950-1970. Integrals are still the workhorse for the industry.
- Units are either 2 or 4 cycle and are typically supercharged. Horsepower ranges 600 - 17,000 bhp.
- Manufacturers have included Cooper-Bessemer, Dresser Rand, Ingersoll Rand, Worthington and Clark.
- Massive in size, complex auxiliary systems, costly to operate.
- Excellent efficiencies above 40%.



Pipeline Compression History: Gas Separable Compressors

- The engine and compressor have individual crankshafts and are coupled as separate devices on a unitized skid.
- Introduced late 1960s and still major market player.
- Initially suffered as they were high speed machines (350 - 1200 rpms) with unacceptable vibrations.
- Recent years made a come back and are now displacing some of the larger integral units.
- Pipelines purchase primarily Ariel Compressors through “packagers”. Other vendors are GE, Cameron, and Dresser.



Pipeline Compression History: Gas Turbine Driven Centrifugals

- Since the 1970s, Industrial Gas Turbines are currently the prime mover of choice for most mainline applications.
- Gas Turbines are more reliable than internal combustion engines, have very low maintenance costs and are basically “clean burn” units (low emissions).
- Relatively low efficiency of 20% to 35%.
- The original gas turbines (1960s-1970s) were classified as aero derivative machines and are typically “jet” engine platforms converted to drive a centrifugal compressor. Later “industrial” gas turbines were introduced.
- Gas turbine units are normally used for higher horsepower (7,000-40,000 bhp) applications.
- Most US operators use Solar Turbines, GE, and Siemens.

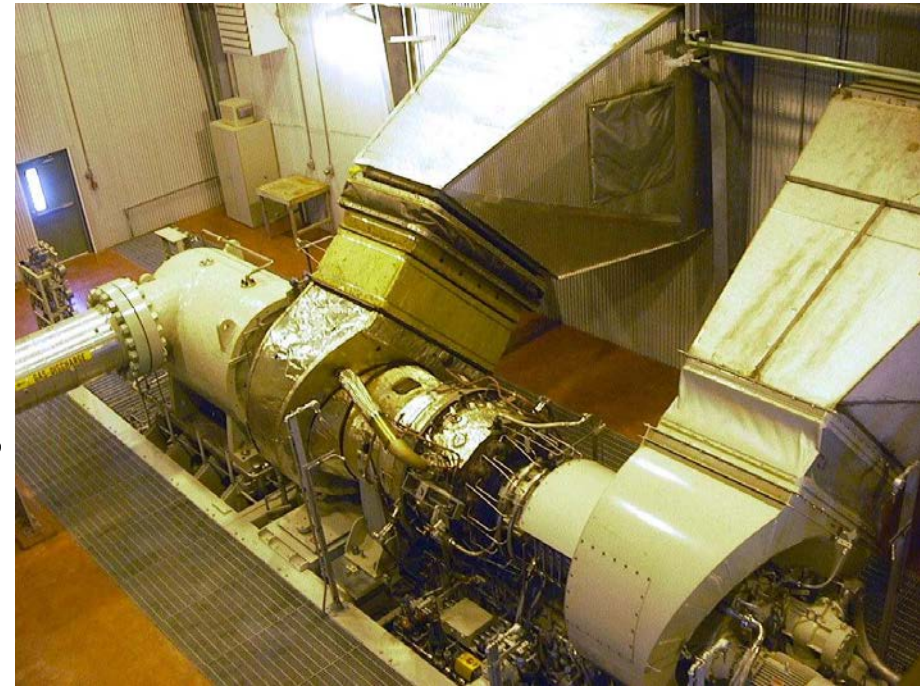

Pipeline Compression History: Other Equipment Configurations

- Fixed Low Speed Electric Reciprocating
- Fixed Medium Speed Electric Reciprocating
- VFD Reciprocating
- Conventional Fixed-Speed Electric Centrifugal
- Conventional Fixed Speed with Voith Vorecon Hydrodynamic Fluid Coupling
- **Conventional EMD VFD-Geared Centrifugal**
- Screw Compressors and other PD Compressors
- **High Speed Motor VFD Direct Drive Centrifugal**

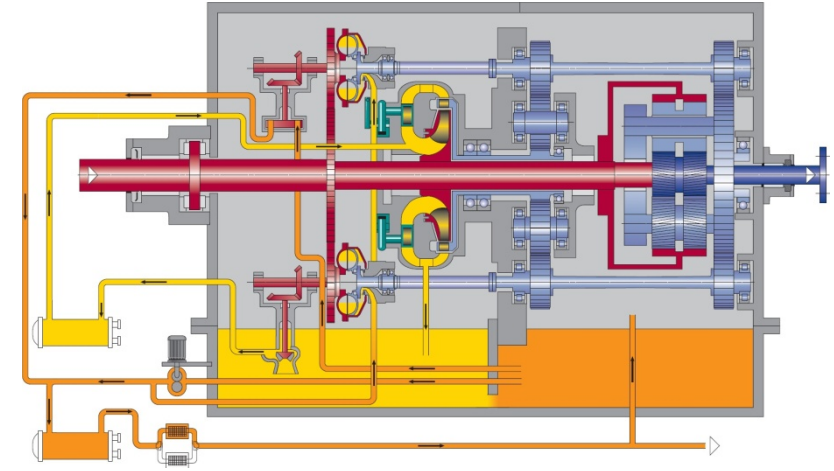

Voith Vorecon



US Natural Gas Pipelines and Compression Stations

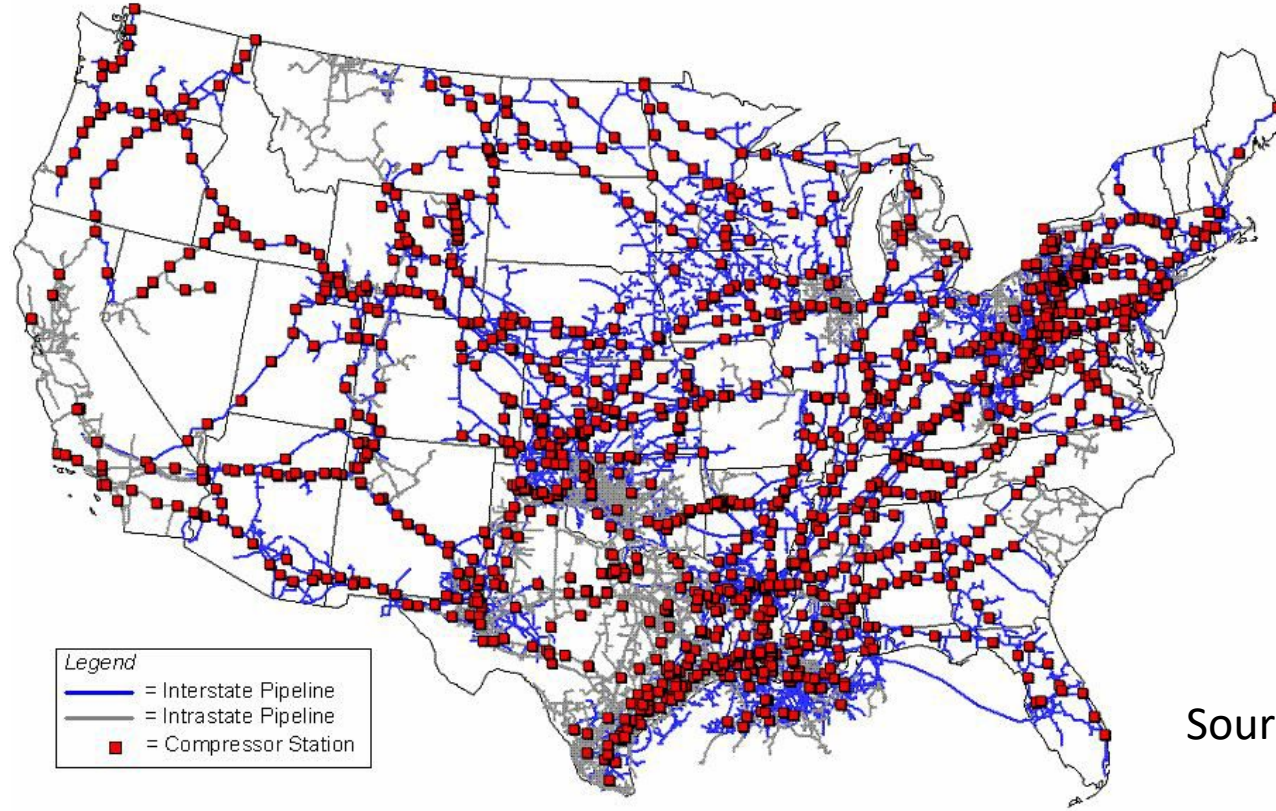

Source: US DOE EIA, Wood Mackenzie

- 2.3 million miles of pipelines
- 850-900 mainline compressor stations, 800-900 booster stations (+ 15,000 gas gathering machines)
- Average age of pipeline compressors: 25-30 years
- Consume/lose about 2.5-3.5% of US NG = 0.7 tcf/y = 3-4 billion US Dollars per year

Minimum of 5,000,000 hp of Compression must be replaced in next 15 years on US pipelines.

World's Pipelines

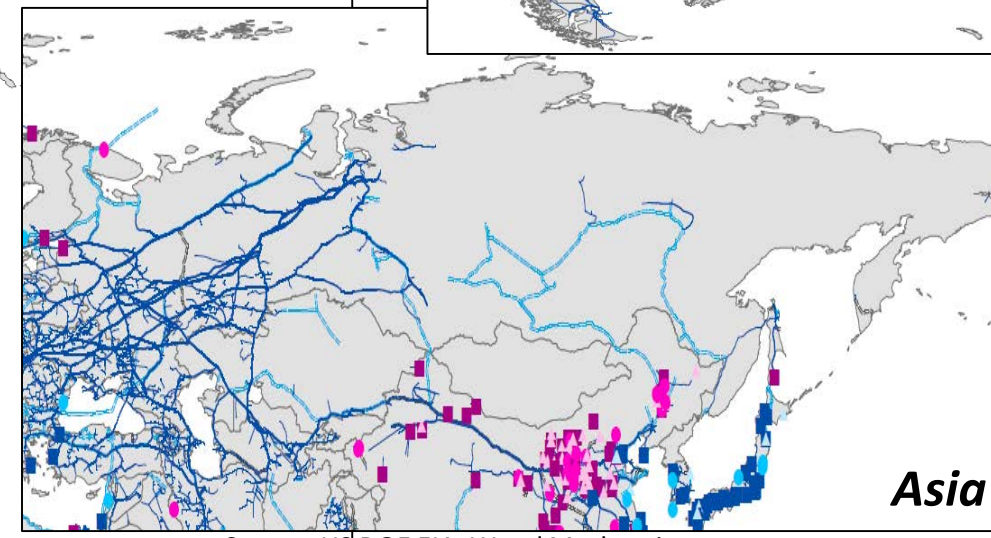
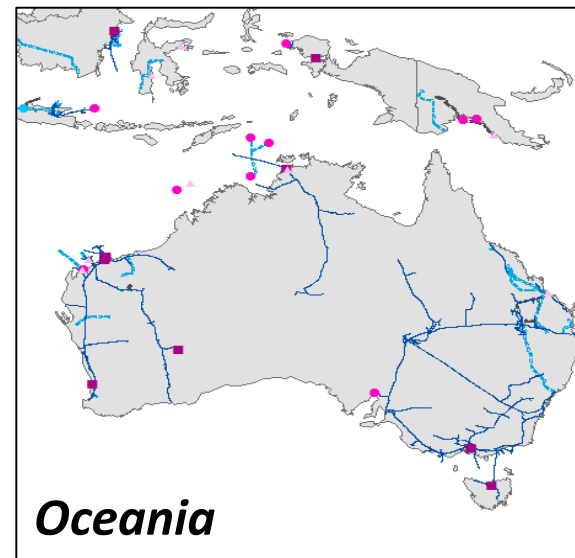
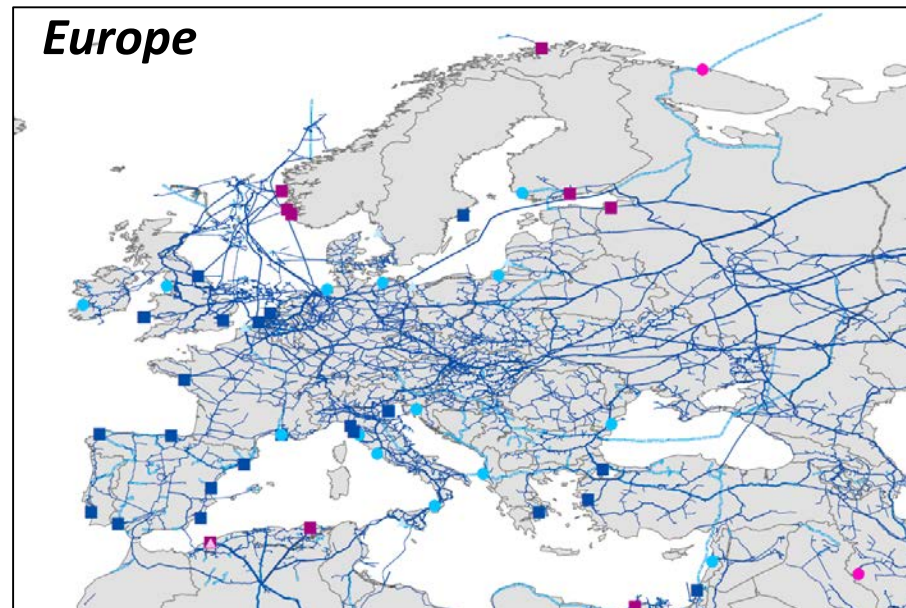
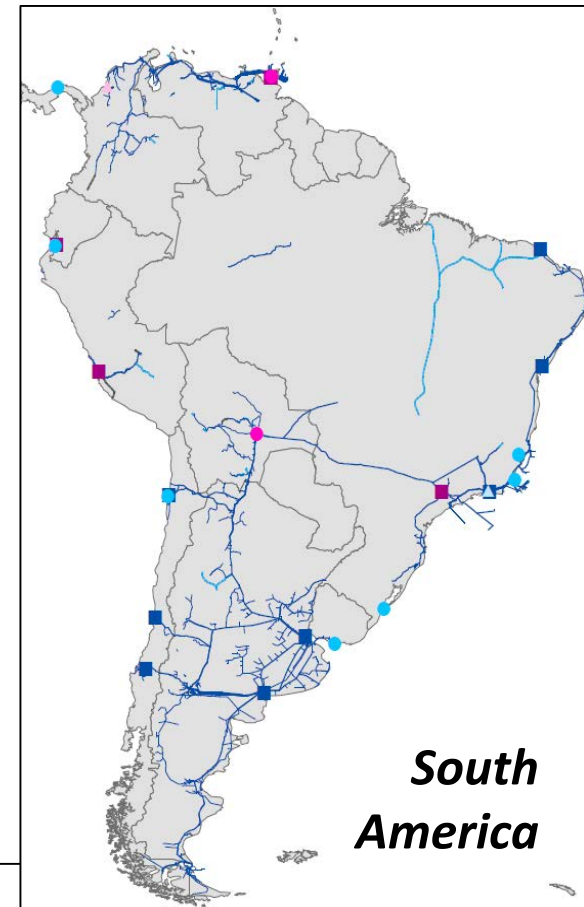
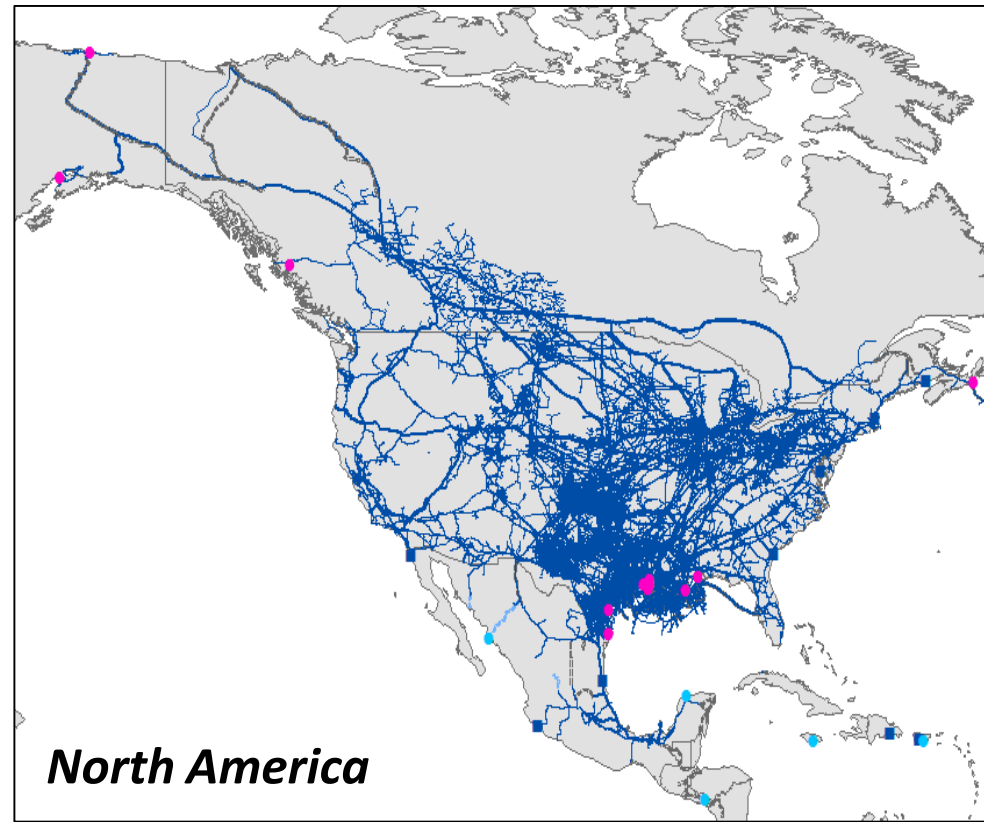
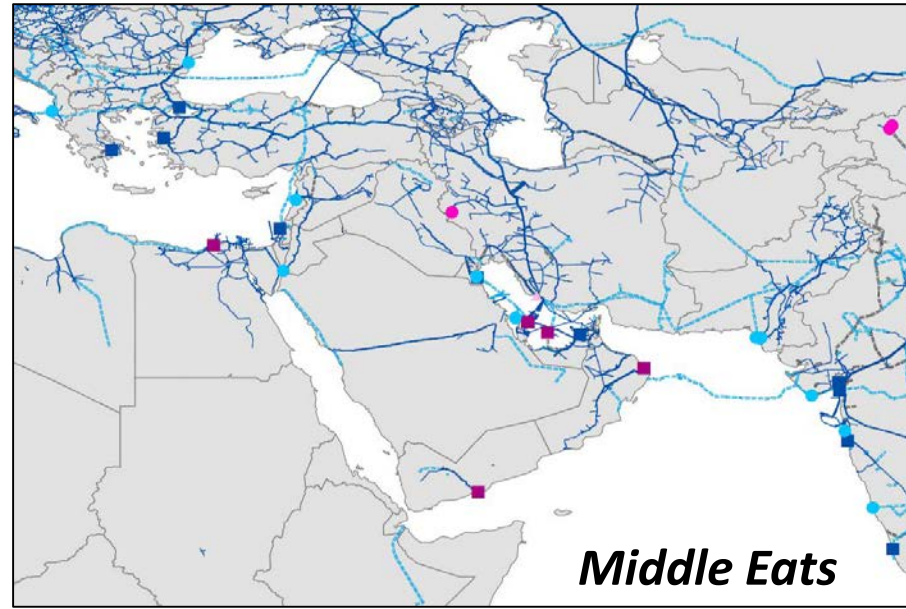

Largest Number of Installed Machines: Upstream - Gas Gathering: Mostly Small Recip (4khP)

Push vs. Pull Compression

Distributed Compression



2250 bhp Diesel Engine: 15,000lbs

- Flexible installation and operation
- Often high leakage

Central Compression

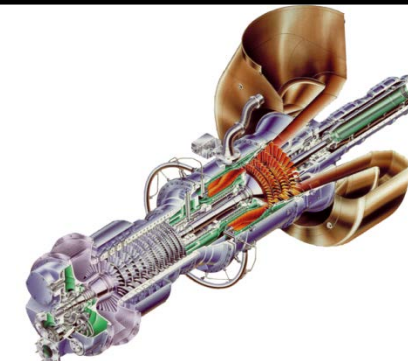
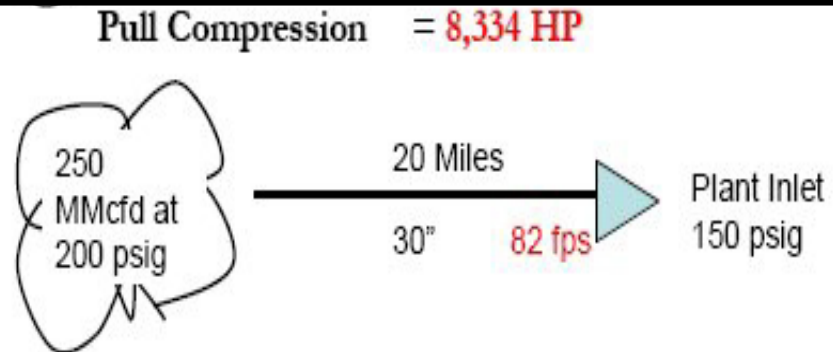

7800 hp (ISO) Gas Turbine: 11,000 lbs

- Low emissions
- High reliability
- Lower efficiency

Well-head compression versus central compression:

- Wet gas compression technology impact
- Air emissions requirements impact

Pipeline Operating Conditions

Design

Reality

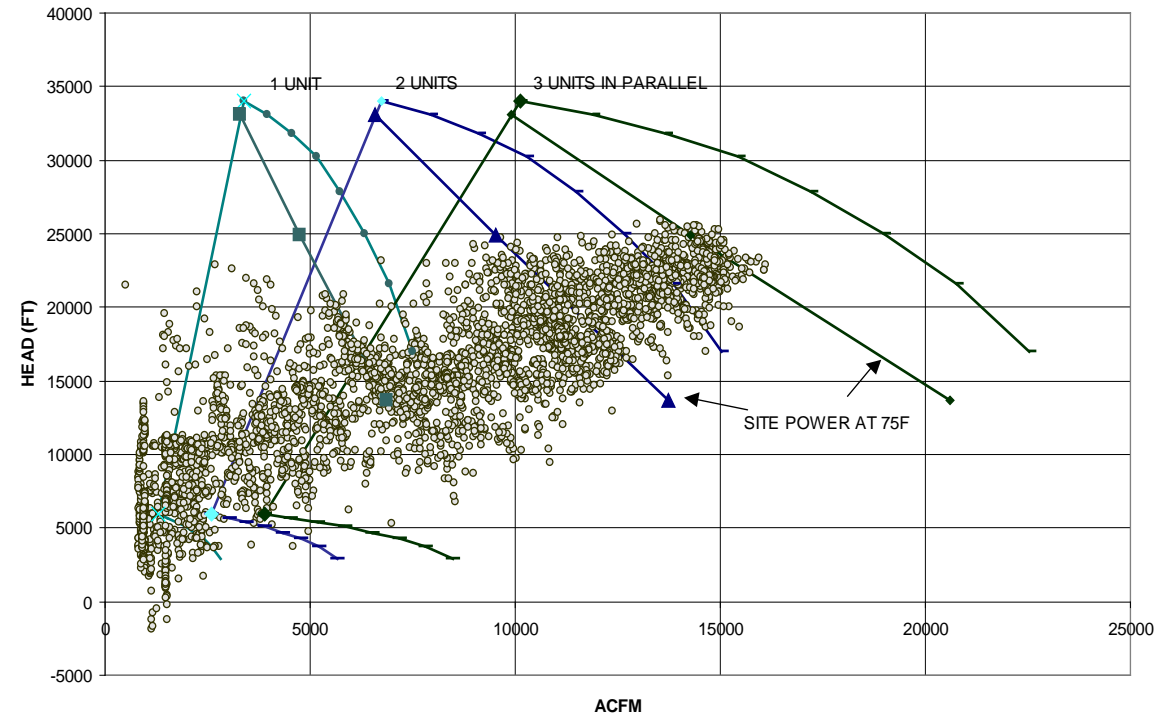
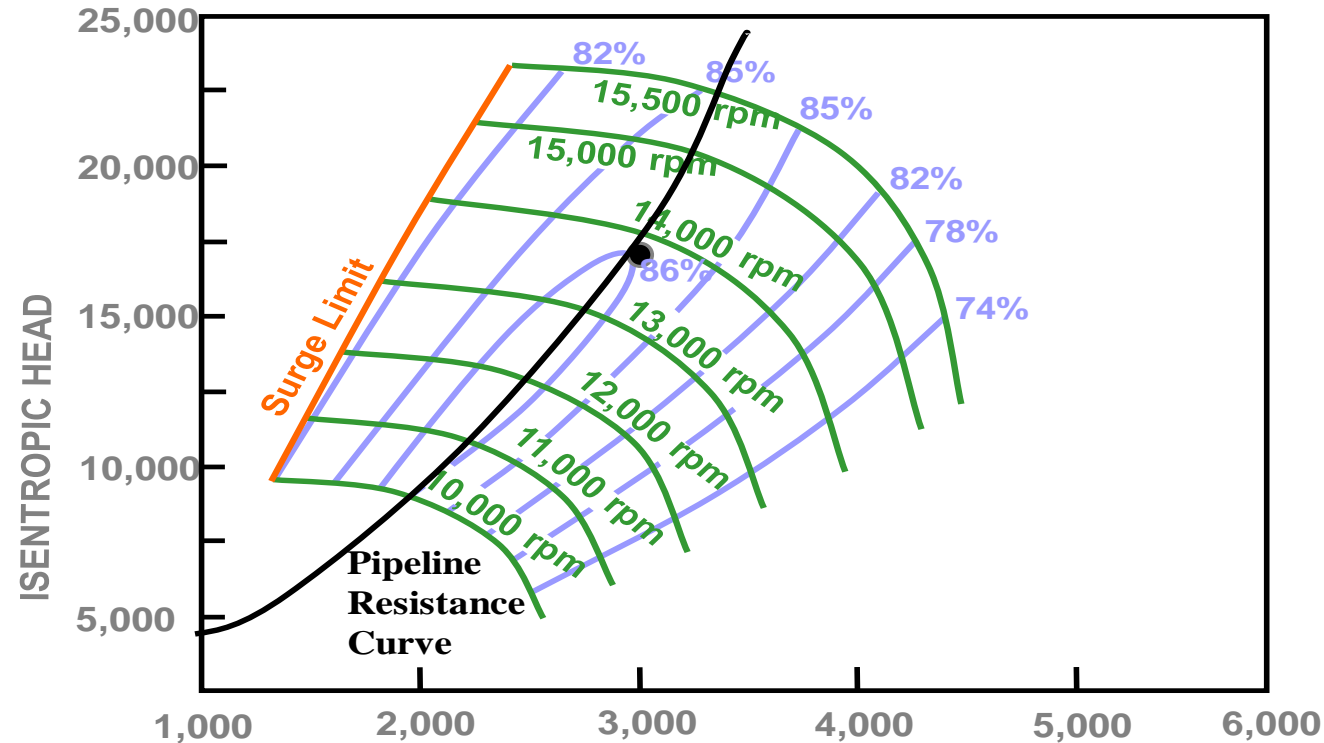

Pipeline compressors rarely operate near their design point:

- Reduced driver efficiency
- Reduced compressor efficiency
- Gas recycling or other flow control losses

O&G Machinery Compression HP Requirements

Upstream	Midstream	Downstream
Gas Gathering Gas Plant Reinjection Gas Lift PowerGen Field Export	Pipeline	Distribution (PowerGen) (LNG/GTL)
20-40 kHp per 100 MMSCFD (Compression power per NG production rate)	5-15 kHp per 100 MMSCFD	1-5k Hp per 100 MMSCFD

**Upstream production has largest HP requirements.
Most of it for gas gathering utilizing <2000 Hp recip compressors.**

Applications-Pipeline Transmission and Boost

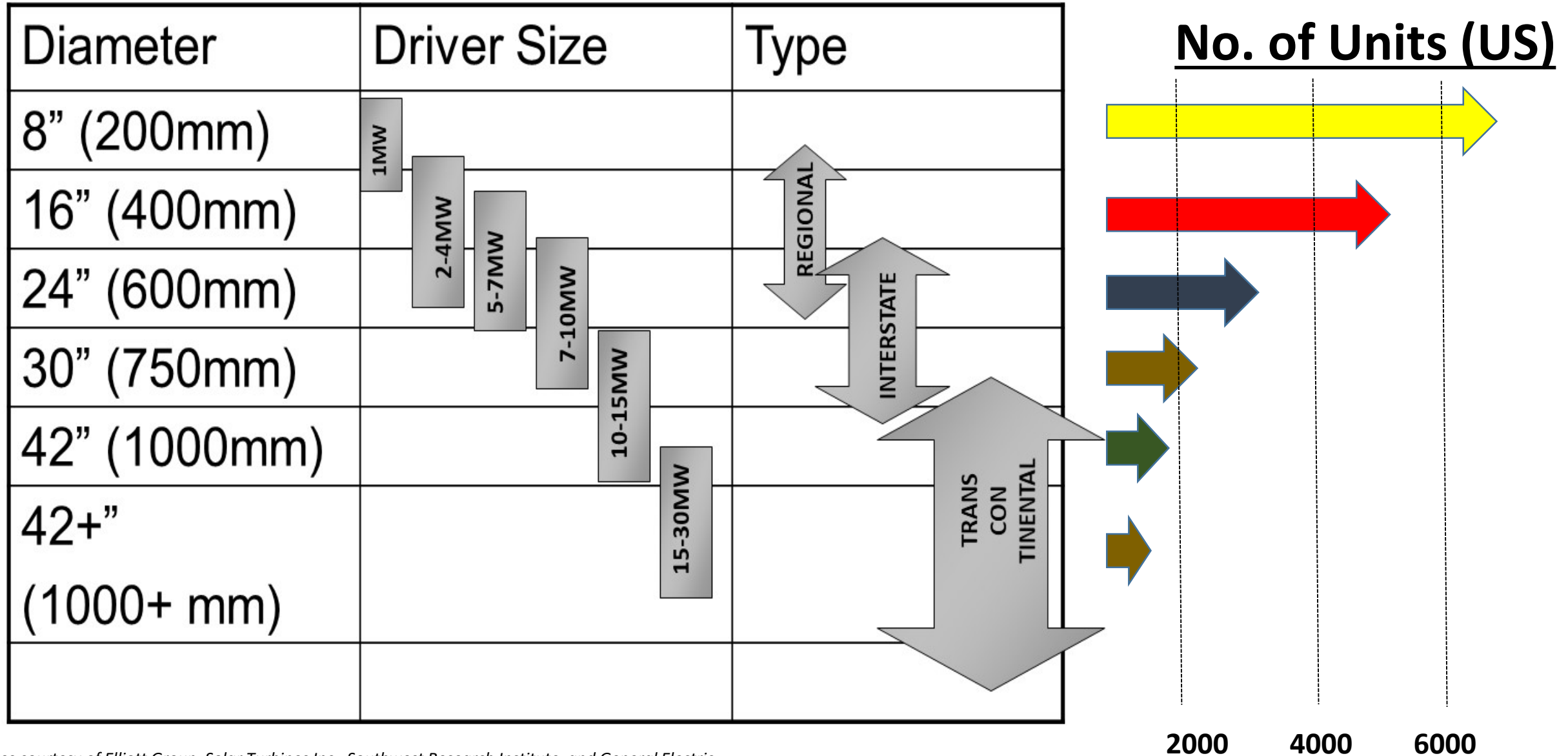

Pipeline Compression Equipment Most Commonly Used

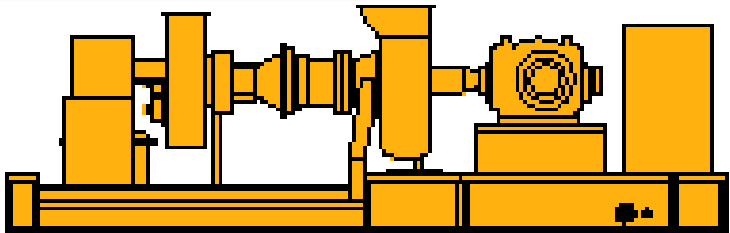
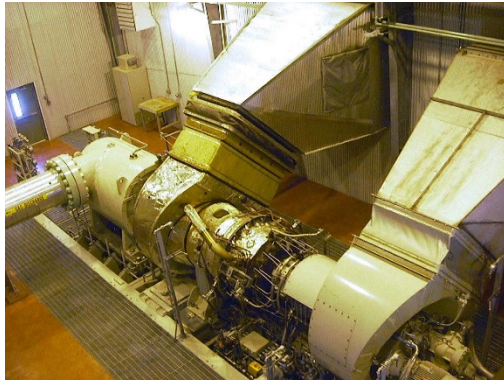

Gas Turbine Driven Centrifugal Compressor:

- Simple cycle gas turbine driver
- Direct drive compressor (6,000-20,000 rpm)
- Centrifugal compressor with 1-2 impeller stages



High Speed Separable Recip Compressor:

- Gas Engine driver
- Direct drive compressor (1200-1600 rpm)
- 2-4 double acting cylinder stages



Electric Motor Drive:

- Centrifugal and recip compressors
- With or without gearbox
- Fixed speed or variable speed (VFD)



Pipeline Compression Basic Efficiency Problem

- Driver Efficiency (GT, Engine, Motor): 25-40%
- Driven Equipment (Centrifugal, Recip): 75-90%
- Plant Losses (Bottles, Scrubbers, Filters): 2-5%
(Losses)
- Off-Design Operation, Recycle : 0-70%
(Losses)
- Leakage and Blowdown: 0-50%
(Equivalent Efficiency Losses)

Total Average Compressor Station Efficiency is Always Well Below 20%.

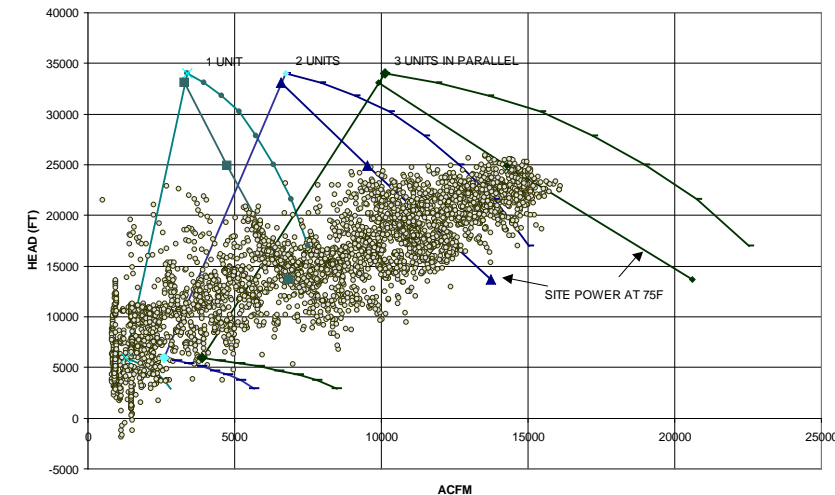
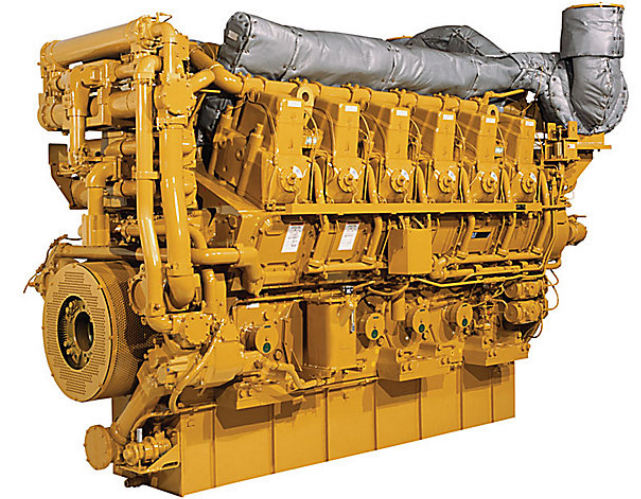

Major O&G Two Shaft Gas Turbines

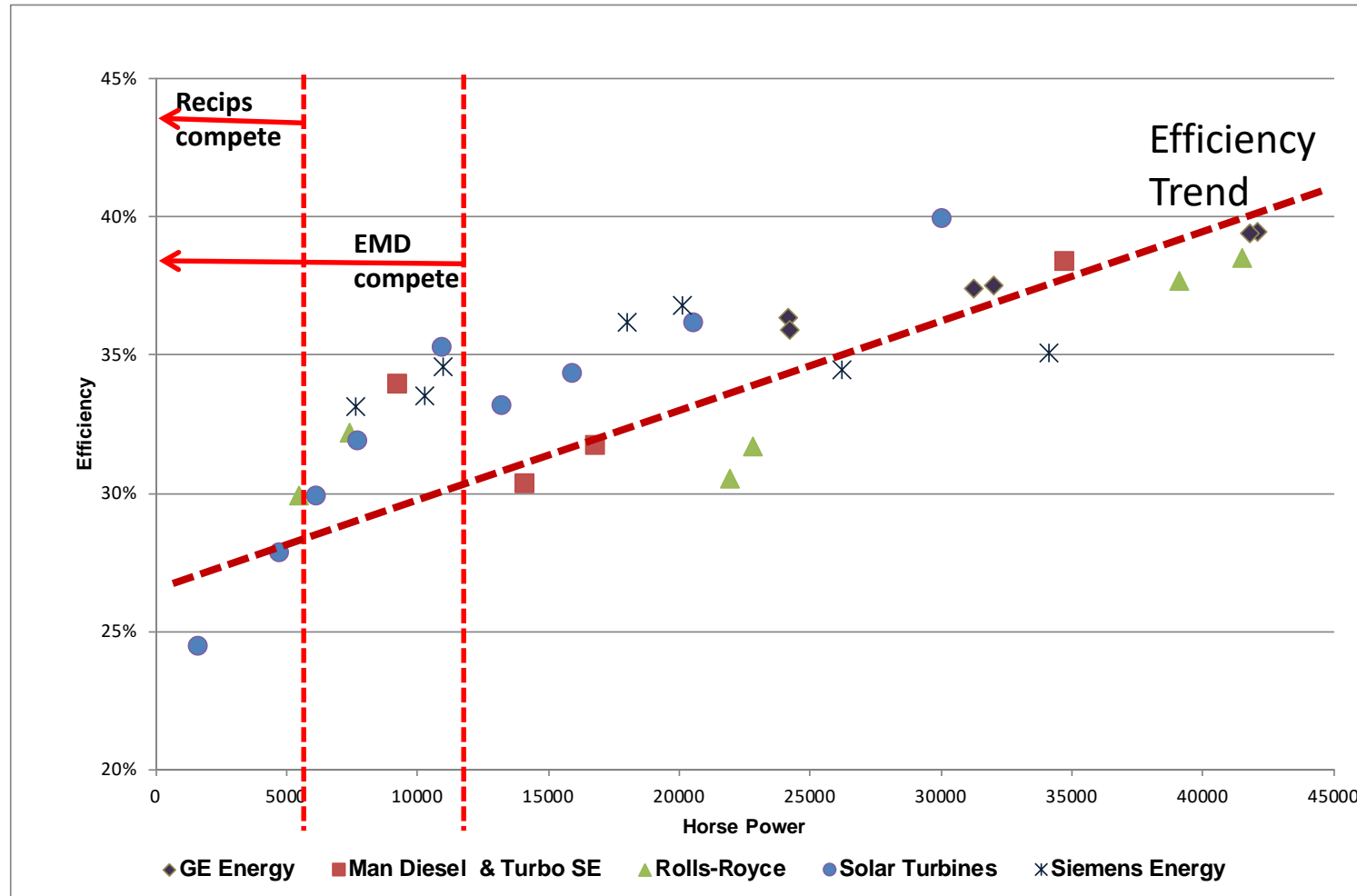

Larger gas turbines tend to have higher pressure ratios, thus, higher efficiencies.

Making Pipeline Compression More Efficient

<u>Approach</u>	<u>Possible Efficiency Gain</u>	<u>Funded R&D</u>
• Improve Driver Efficiency	3-10%	OEM, DOE
• Improve Driven Equipment Efficiency	2-5%	OEM
• Add Recuperation	0-10%	OEM
• Add Waste Heat Recovery	15-35%	DOE
• Improve Balance of Plant Efficiency	1-5%	Users
• Reduce Leakage	0-30%	OEM, DOE, Users
• Avoid Blowdowns	0-10%	Users
• Optimize Pipeline & Station Operation	0-30%	Users

Total US R&D Budget WAG: OEMs: \$100-300M DOE: \$50-150M Users: \$20-60M

Natural Gas Leakage and Blowdown / Venting

Typical Leakage sources:

- Recip packings
- Dry Gas Seals
- Venting and Blowdowns
- Pneumatic Valves
- Leaks in valves, floating valves, leaking through gaskets, fittings, etc.



A loss of 1% flow is equivalent to reducing the driver efficiency by 70%.

(With the following standard pipeline assumptions: 3,000 HP engine with 40% efficiency LHV of 21,496 btu/lb(50,000,000 J/kg), 80% efficient reciprocating compressor, Pressure ratio of 1.5, ambient suction temperature, Natural gas process fluid)

Venting Avoidance

- Increase equipment reliability
- Extend maintenance intervals
- Local blowdown instead of full station vent
- Part load operation to avoid shutdowns
- Pressurized hold for extended periods
- Improve operator training
- Redundant instrumentation
- Reduce human interference in process (unmanned stations)
- Carefully review all shutdown requirements and consider alarm instead of shutdown
- Flare instead of vent

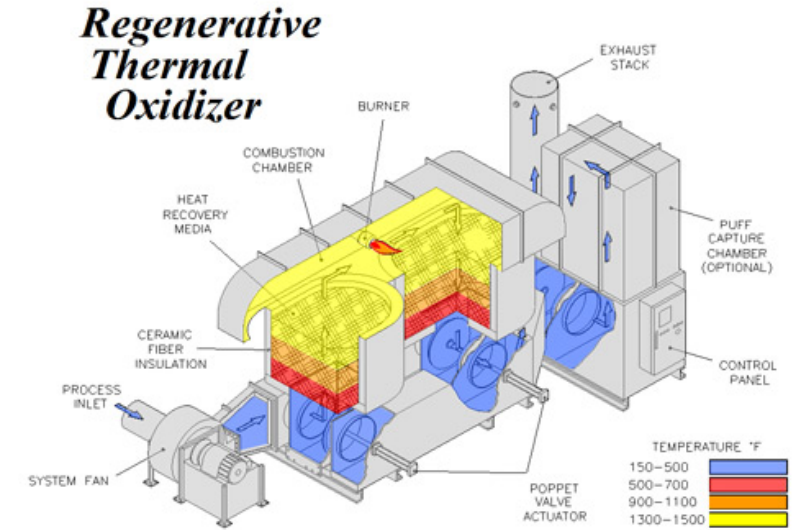

Opportunity for Technology Improvements

- Efficiency of gas turbine
 - Aero compressor design
 - Recuperator
 - Higher pressures and temperatures
 - Intercooling compressor and
 - Staged combustion
 - Pressure gain combustion
- Efficiency of centrifugal compressor
 - Aero impeller and diffuser design
 - Intercooling (isothermal)
 - Magnetic or gas bearings
 - Hermetically sealed
 - Carbon composite impellers (higher speed)
 - Additive manufacturing

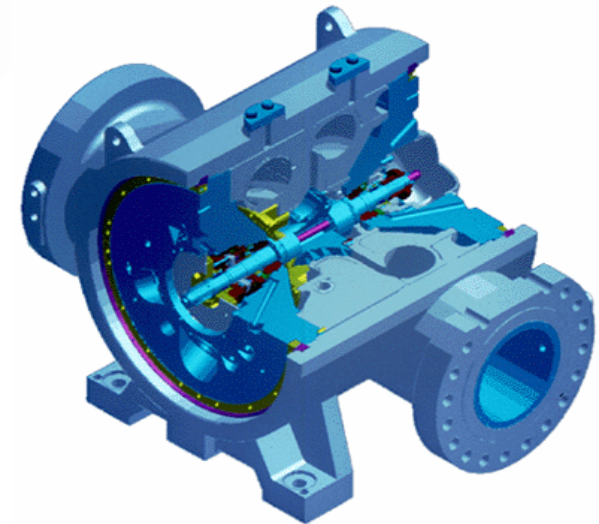
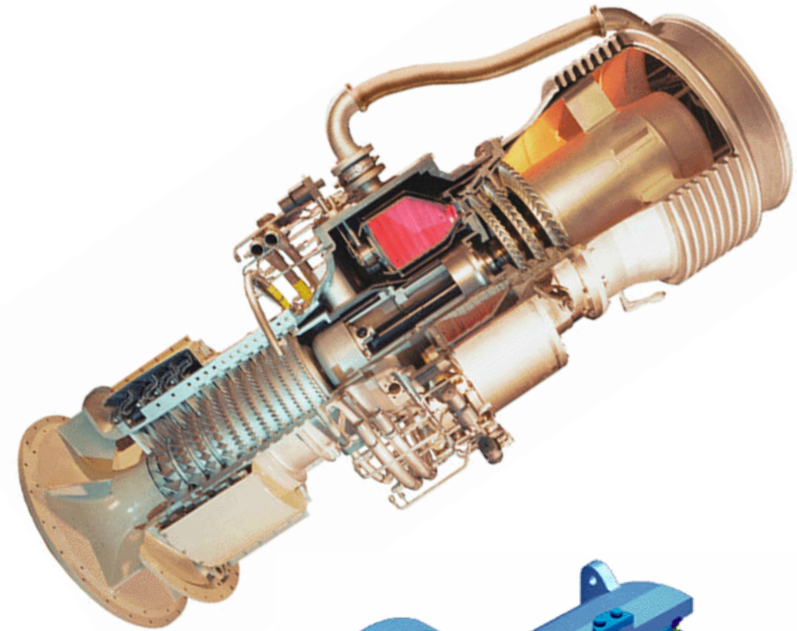

Opportunity for Technology Improvements – Cont.

- Efficiency of recip compressor
 - Low loss valves (or automatic valves)
 - Hermetically sealed casing
 - Low leakage packings (or dry gas seals)
 - Improved flow control
- Reducing Balance of Plant losses
 - Low loss bottles, scrubbers, coolers, filters
 - Reduce plant outages (blowdowns)
 - Optimize equipment load share operation
- Waste heat recovery
 - Steam, organic Rankine, sCO₂, others
 - WHR mechanical drivers
 - Energy Storage



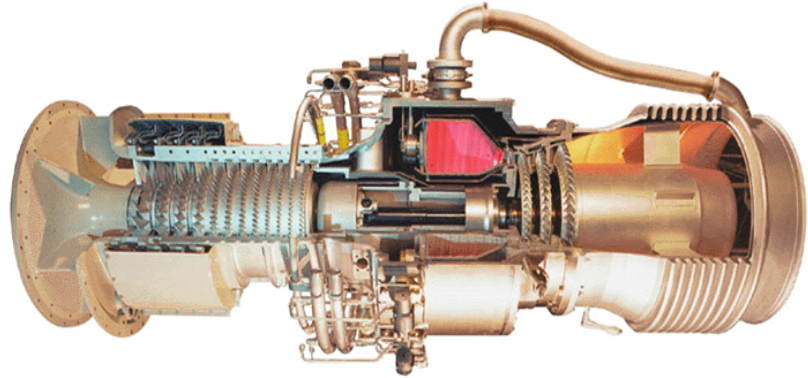

Technology Trends

Recuperation versus Higher Pressure Ratio Gas Turbines

Waste Heat Recovery

- Supercritical CO₂ Power Cycles

- Organic Rankine Cycles

Hermetically Sealed Machines

Intercooling

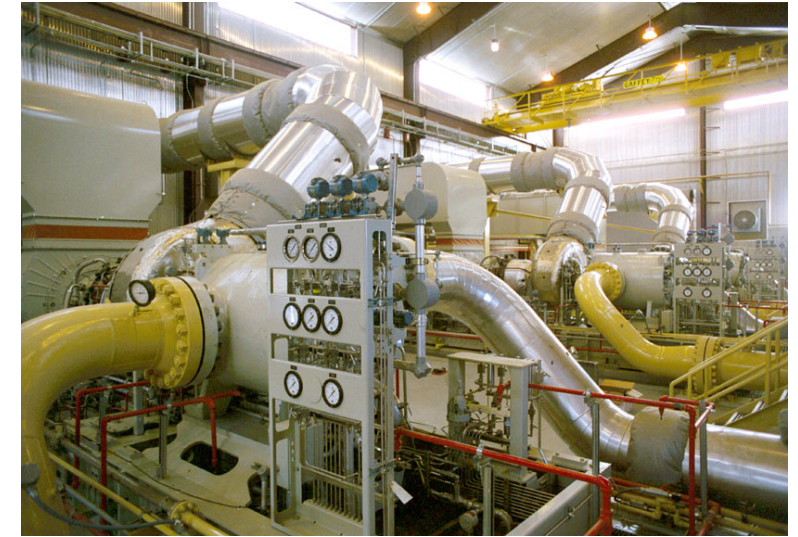

Recuperated Gas Turbine

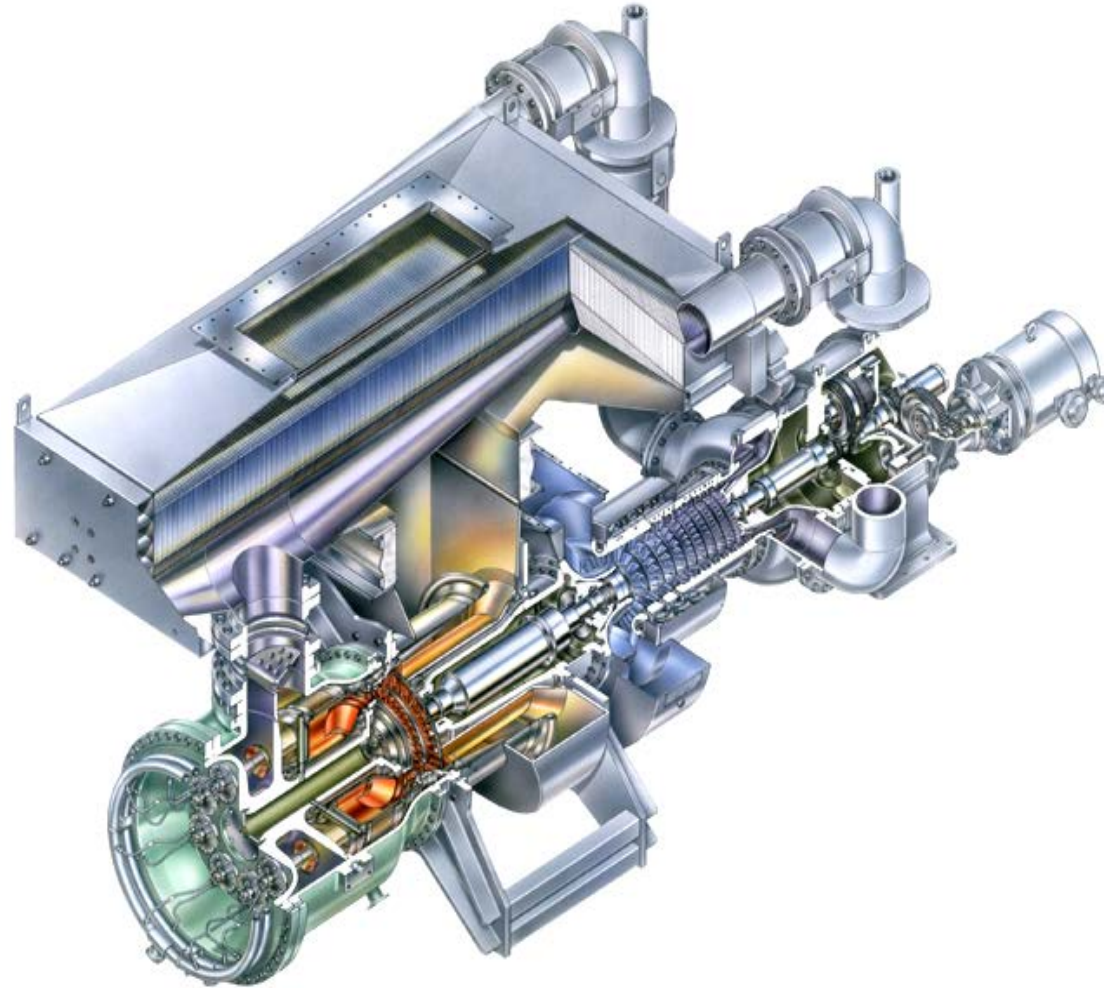

Solar Turbines Mercury 50:
Development Funded by DOE Advanced Gas Turbine Program

All figures courtesy of Elliott Group, Solar Turbines Inc., Southwest Research Institute, and General Electric

Recuperation versus Pressure Ratio

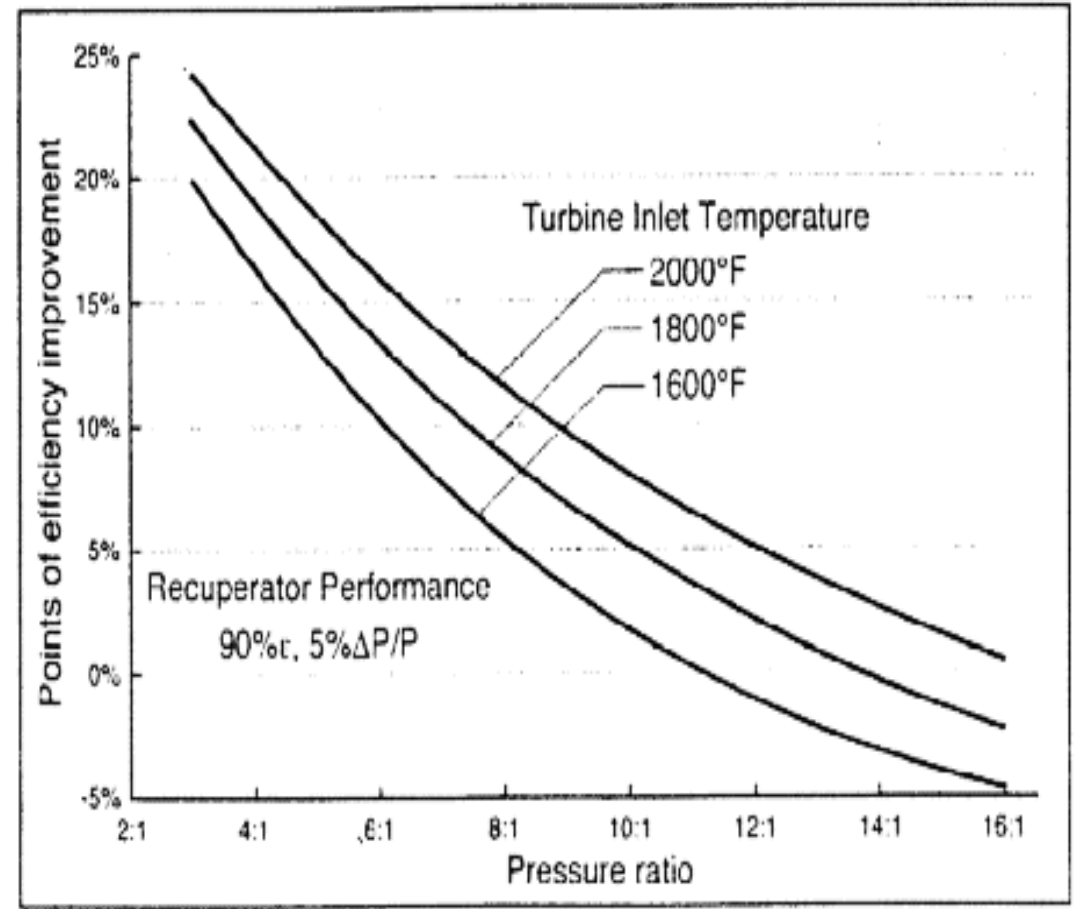
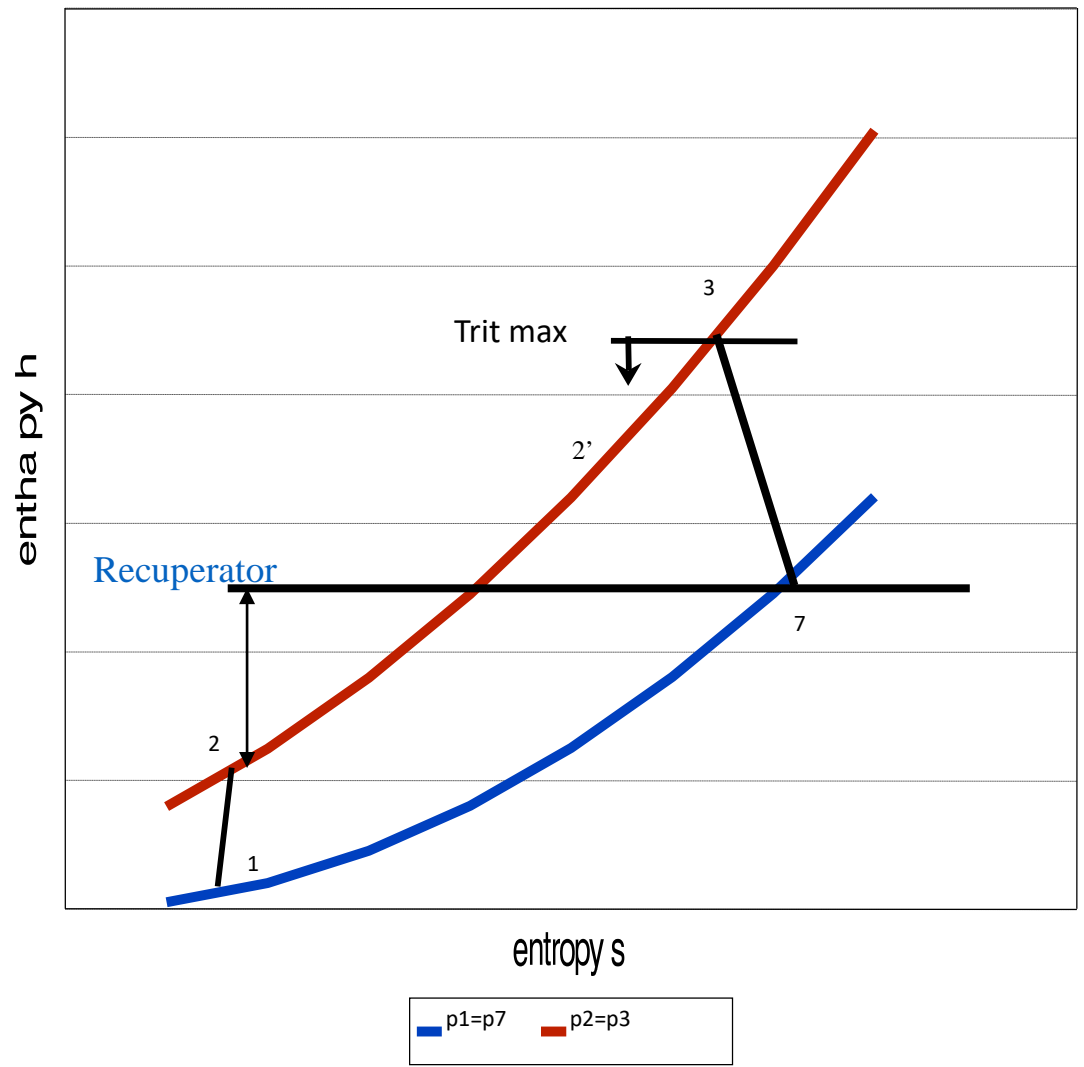

Recuperated versus High Pressure Ratio Gas Turbines

Solar Turbines
Mercury 50 (ISO 4.6 MW)
Distributed Power

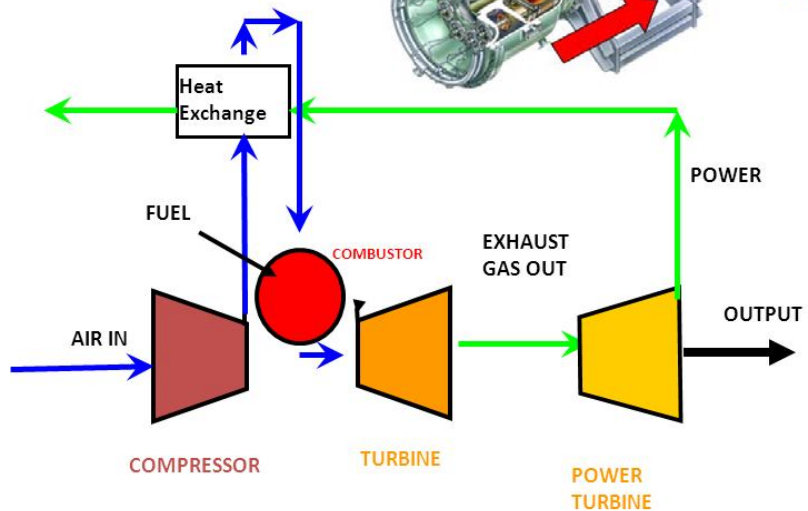
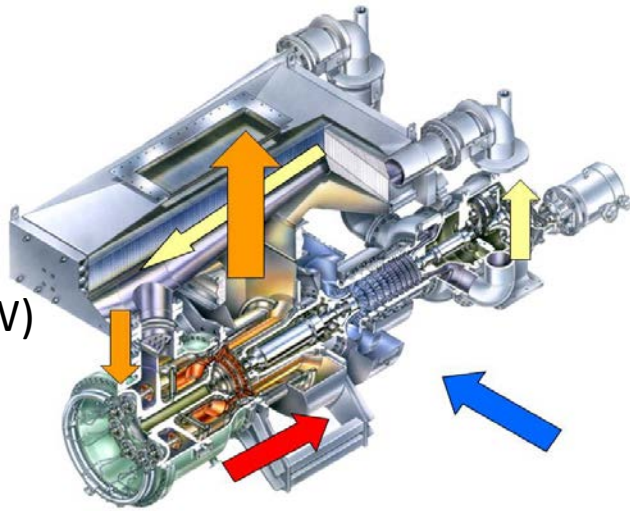

Recuperation:

Pre-heat combustor inlet air using exhaust heat.

- Mostly small GTs
- Problems with recuperator durability
- Difficult for variable speed applications

General Electric
LMS 100 (ISO 100 MW)
Peaker and intermediate base load

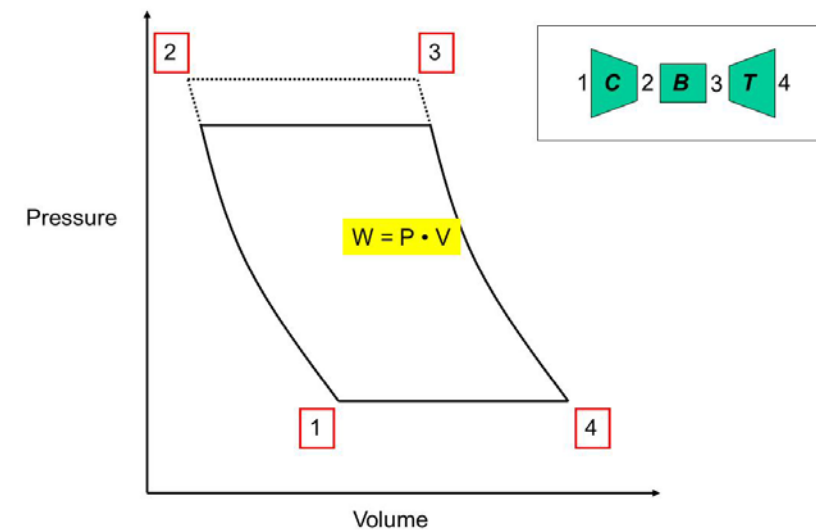
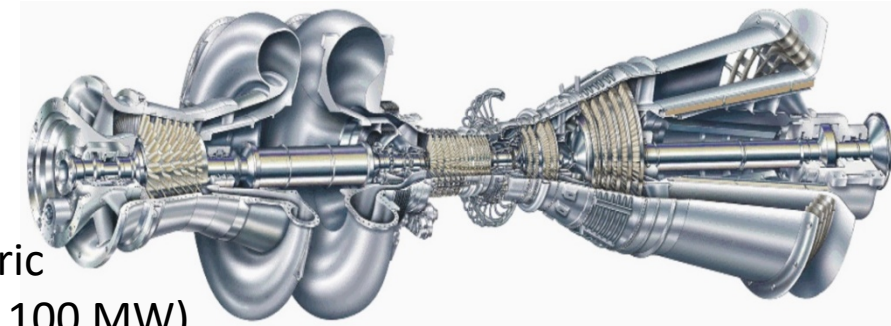

Higher Pressure Ratio:

Increases cycle efficiency.

- Large aero GTs
- Problems with DLN combustion
- Problems with compressor cooling

Other Gas Turbine Driver Improvement

Intercooled Compression

- Commercially available: Overspray, stage cooling, blade cooling
- Improves cycle efficiency
- Needed for high pressure ratio GT's

Staged Combustion (Reheat)

- Commercially available
- Improves cycle efficiencies
- Reduces NOx emissions

Pressure Gain Combustion

- R&D TRL 5
- Improves cycle efficiency significantly

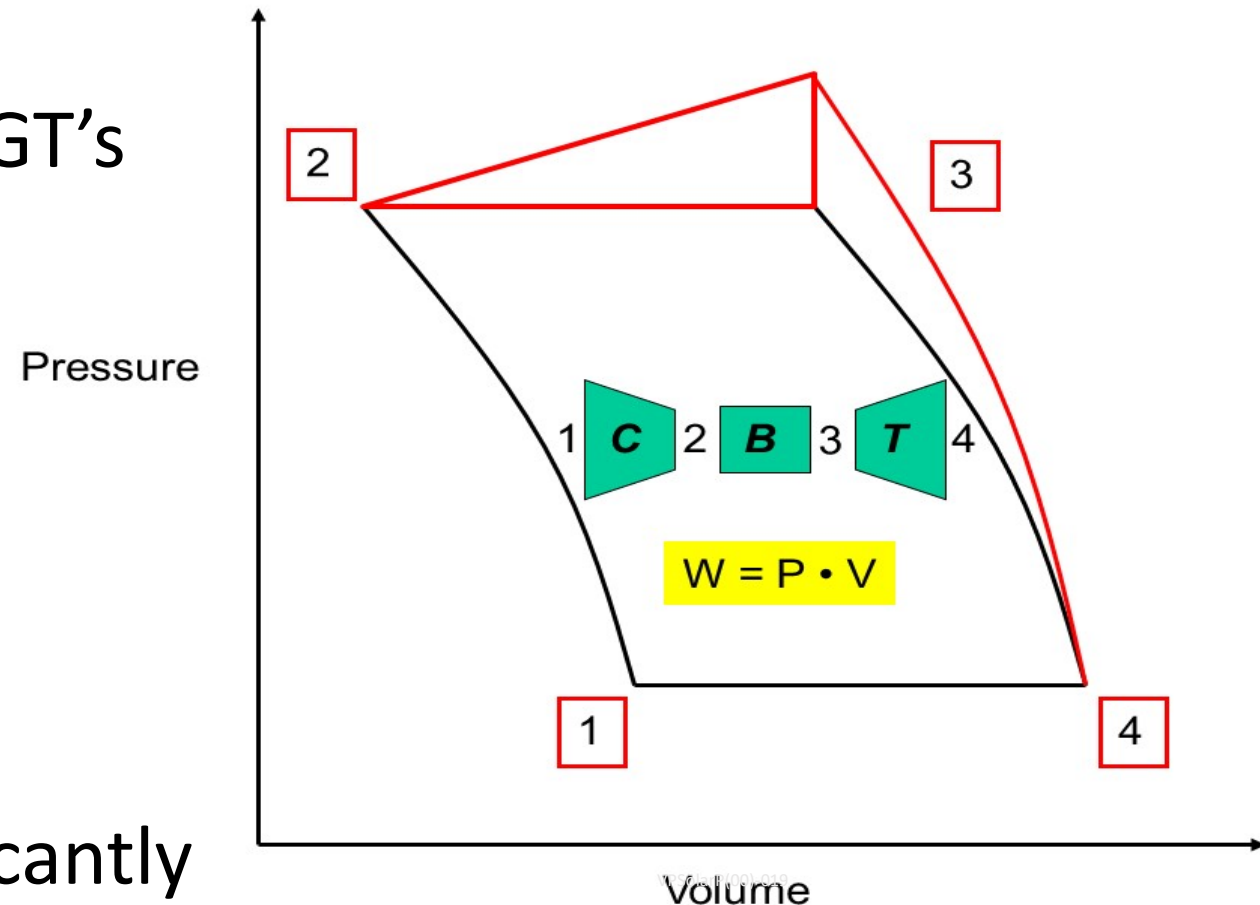

Advanced Compressor Technology

Technology Contributions:

- Advanced computational tools (CFD, FEA, FSI, CHT)
- Rapid prototyping / additive manufacturing
- Advanced metal alloys
- Carbon composite materials
- Interstage seals (novel polymer and carbon material),
- Internal and external stage intercooling

Efficiency Improvements:

- >10% point efficiency gain over last 20 years
- Wider operating Range
- Optimized design and staging / restaging to

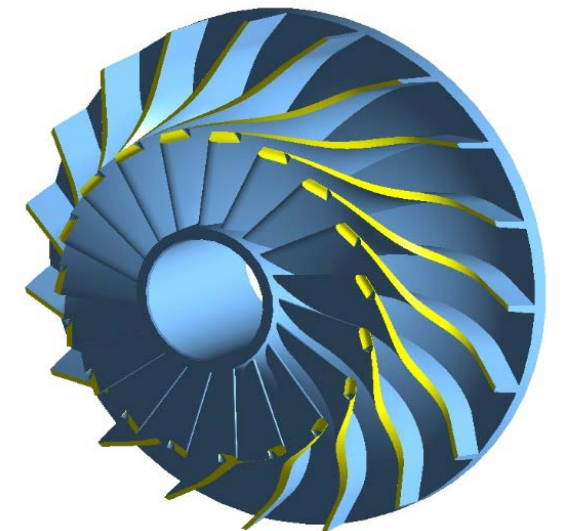
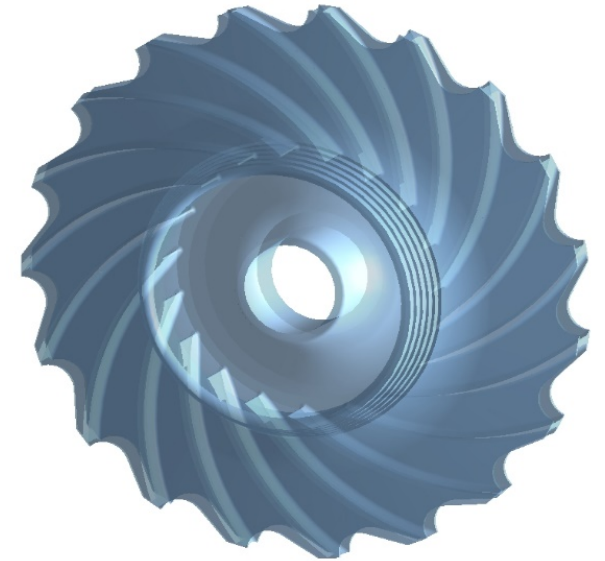

Waste Heat Recovery

Using the remaining heat/thermal energy to create useful energy

Useful Energy Forms

- *Electricity*
- *Power/Torque*
- *Preheat & Refrigeration*
- *Low Grade Steam*
- *Hot Water*

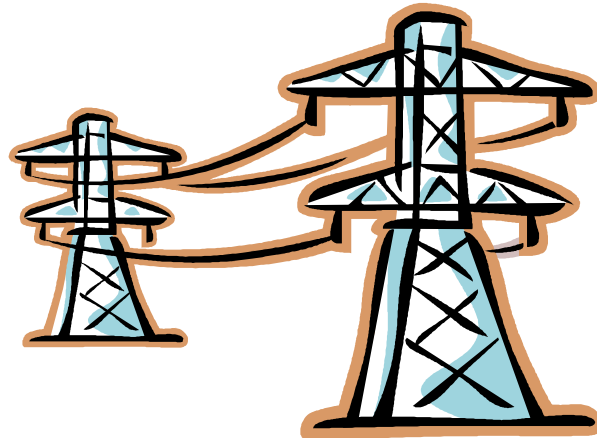

Common Heat Losses

- *Gas Turbine Exhaust* *
- *65%*
- *IC Engine**
 - *Exhaust* 35%
 - *Jacket Cooling* 10%
 - *Lube Cooling* 15%
 - *IC Engine Total* 60%

Waste Heat Recovery

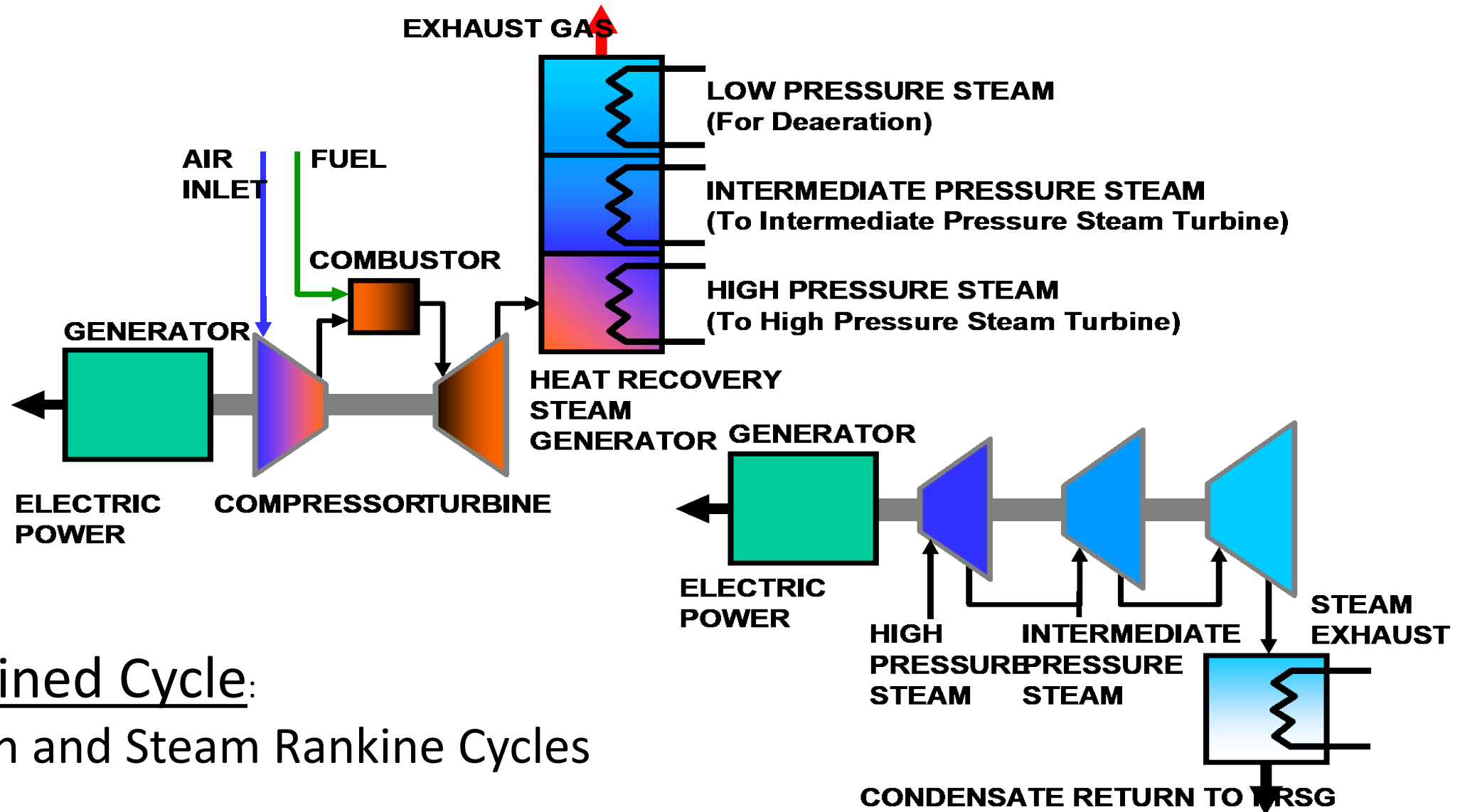

Combined Cycle:
Brayton and Steam Rankine Cycles

WHR Used in Pipeline Service

Large Scale (~5MW)

- Approximately 10 compressor stations have power generation from gas turbine exhaust
- Large installation expenses - \$2000 to 2500/kW
- Success largely dependent on 1) Availability of waste heat source and 2) pricing contract between station and power company

Conventional Compressor Station

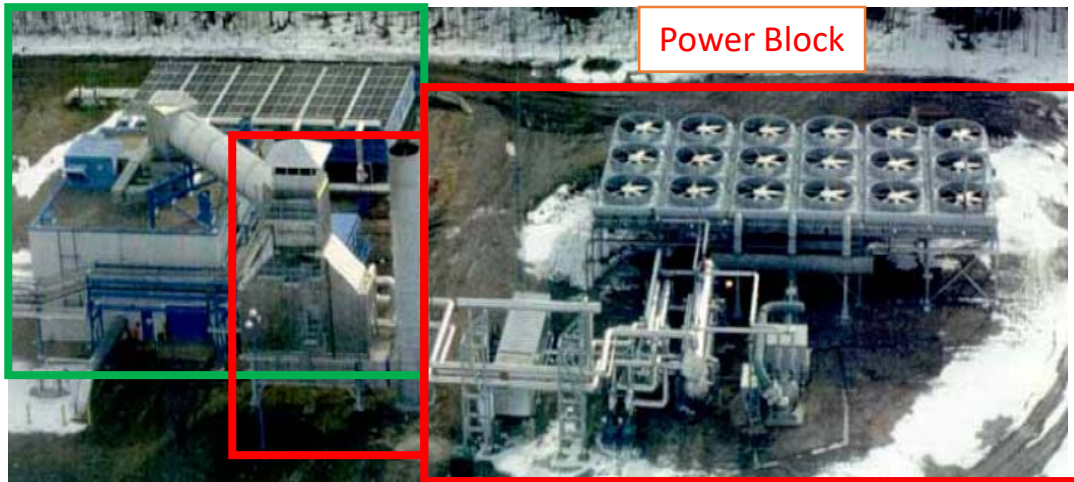

6.5 MW ORC Cycle Plant

Gold Creek Compressor Station, Canada

Small Scale (~250kW)

- Use for low grade heat applications
- Limited applications
- No power sale to electrical company, must use on-site
- Success largely depends on economics of use on-site

Waste Heat from an ICE

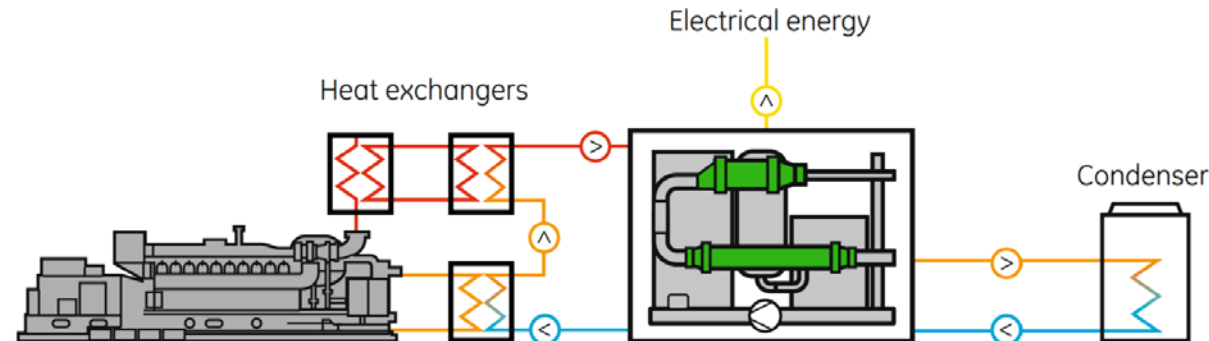

Primary Application being pursued

Pipeline WHR: Other uses

Non-electrical production options

Heating requirements on-site

Gas Treatment using Waste Heat

Mechanical Drive:

- On shaft with primary compressor
- Driving a second compressor

Fuel Gas Pre-heating

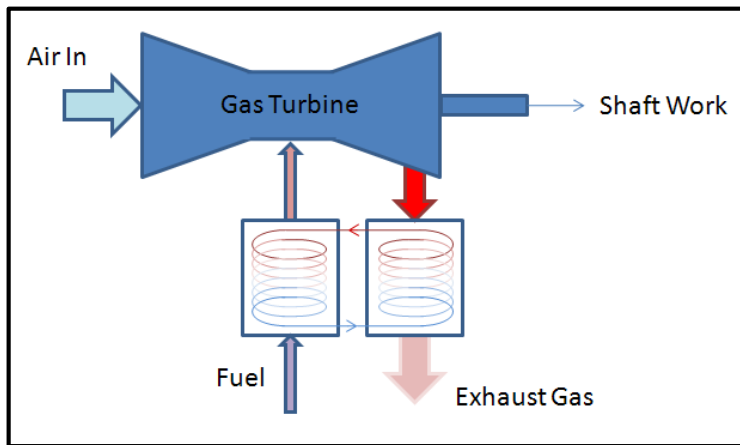

Pipeline Gas Cooling

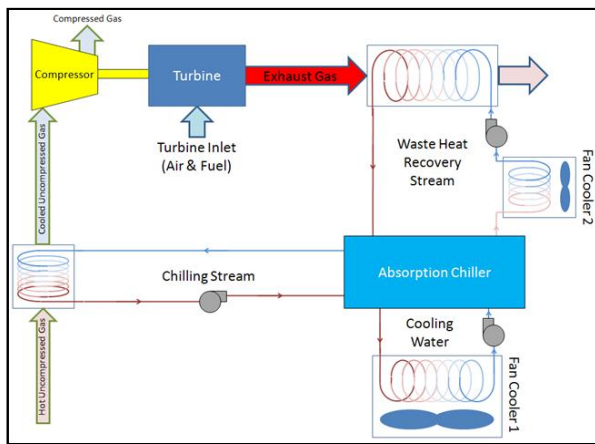

Gas Turbine Inlet Cooling

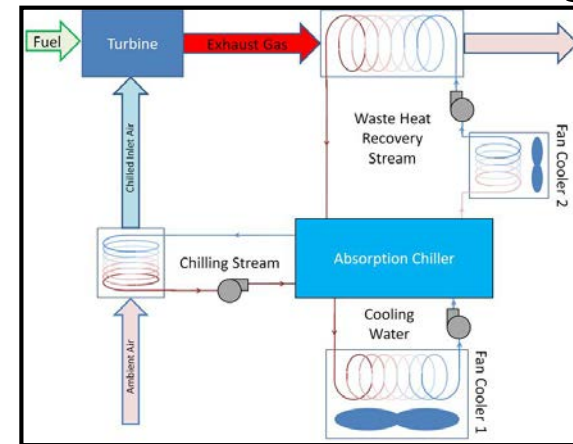

WHR: Advanced Cycles

Supercritical Carbon Dioxide

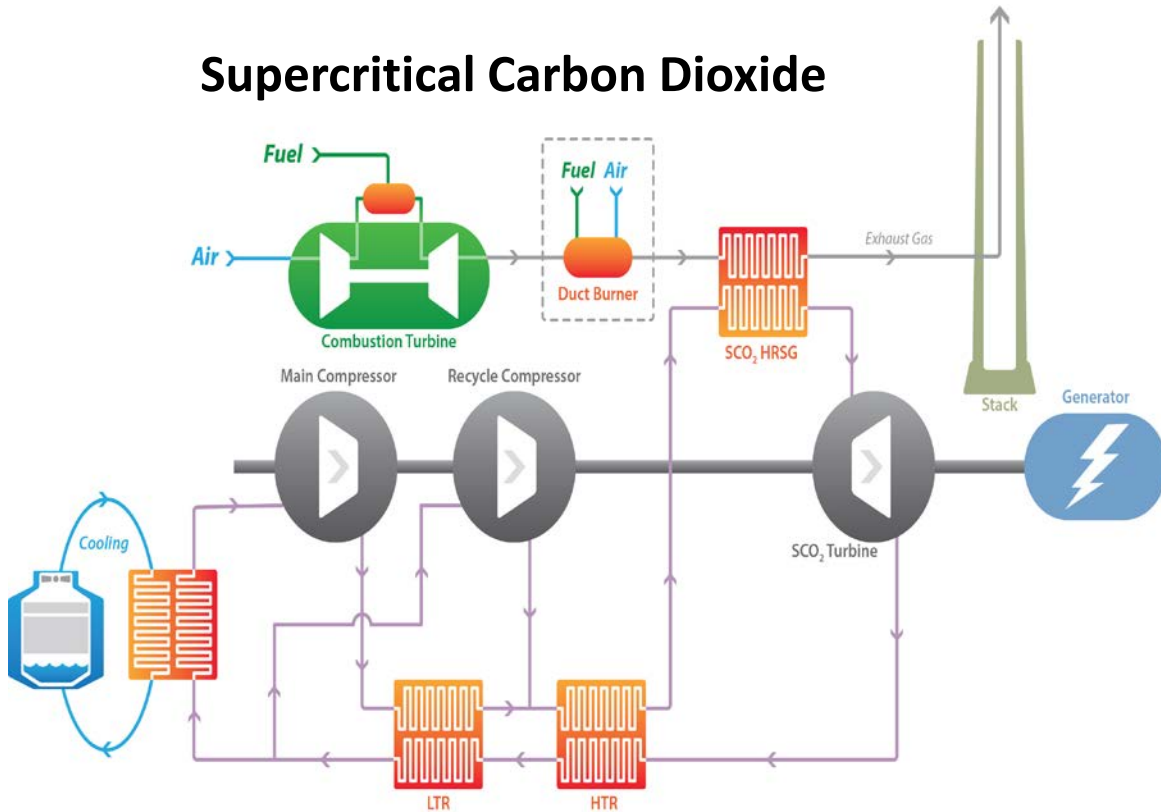

Organic Rankine

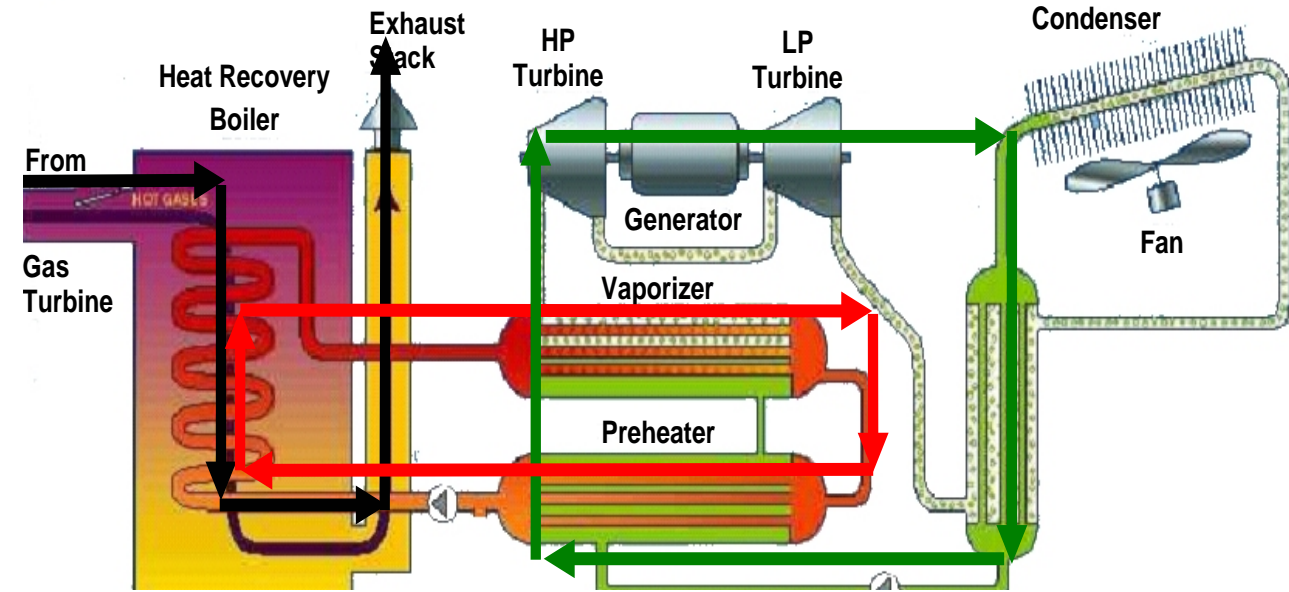

Improvement over Steam:

- Higher efficiency
- No water usage
- Small and modular

Electric Motor Drive Compression General: Advantages and Disadvantages

Advantages:

- Lack of point source emissions (although this does not mean the overall carbon footprint is lowered).
- Reduced station noise possible (for driver machinery only).
- Wide variable speed/load (with VFD).
- Fuel quality independence.
- No performance derating (elevation)
- Can be lower maintenance.

Disadvantages:

- Stringent installation requirements
- Startup torque and torsional considerations
- Critical speed and aero instabilities at part speed/load
- VFD for variable speed required
- Electrical interconnect, sub-station, transformers, VFD, etc..
- Electric utility dependency/cooperation.
- Users: Often lack of trained personnel and operating experience.

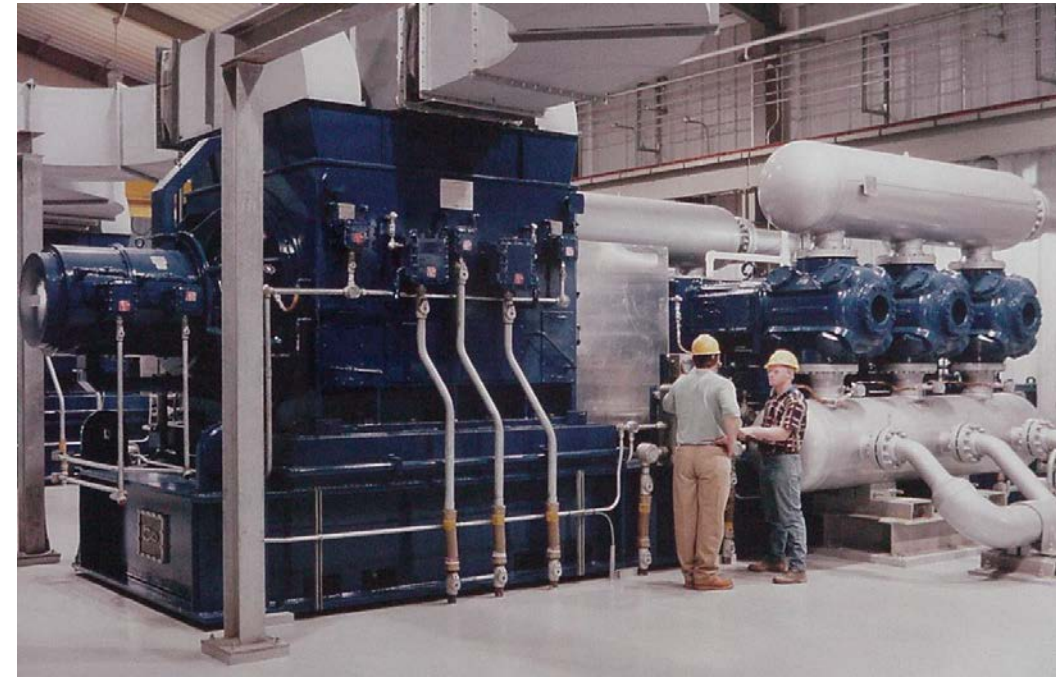

VFD EMD – Gear - Compressor

Technology Developments: Hermetically Sealed Direct Drive Compressors

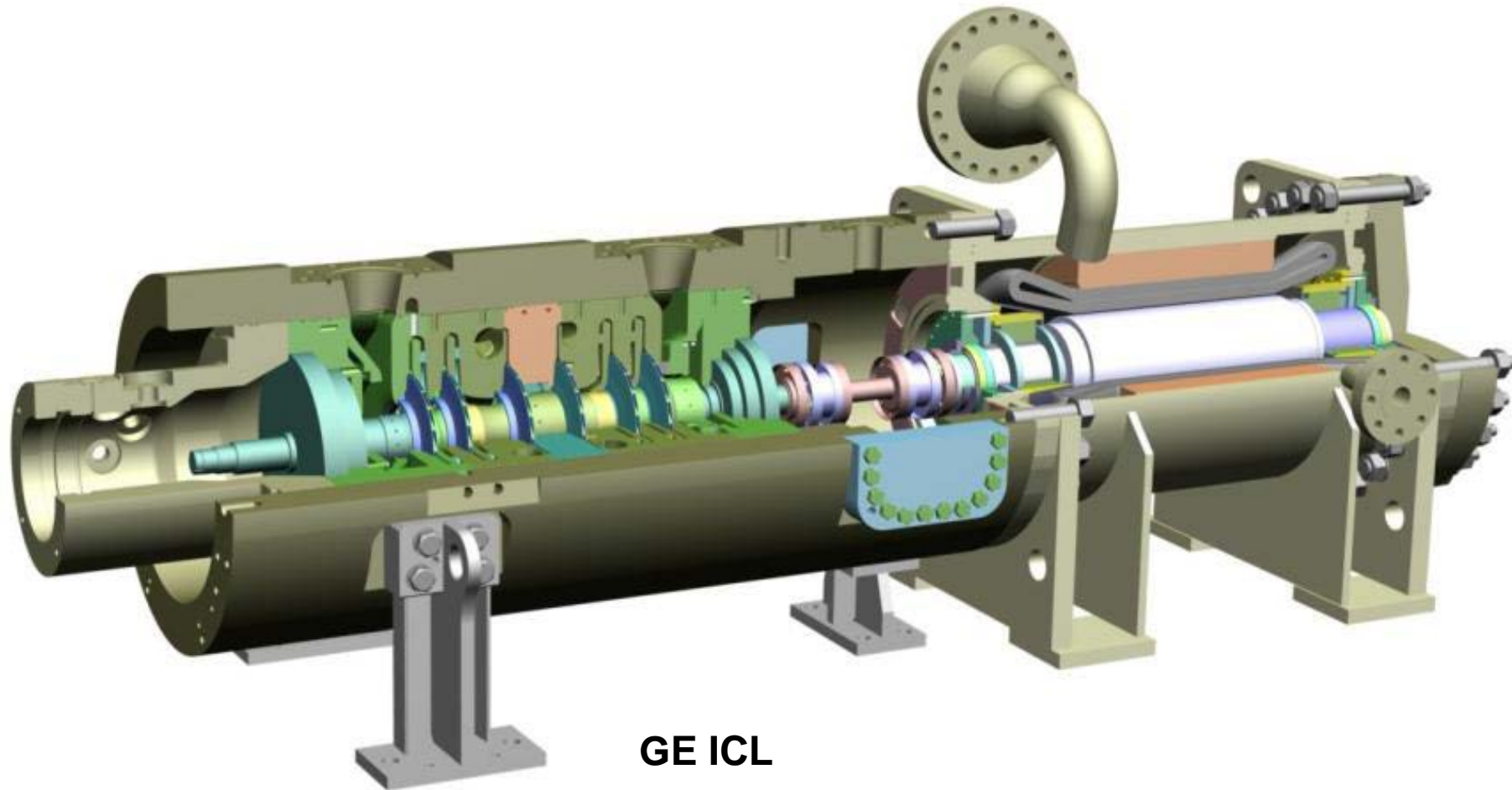

Integrated High Speed EMD Compressor Products



GE ICL



GE ICL

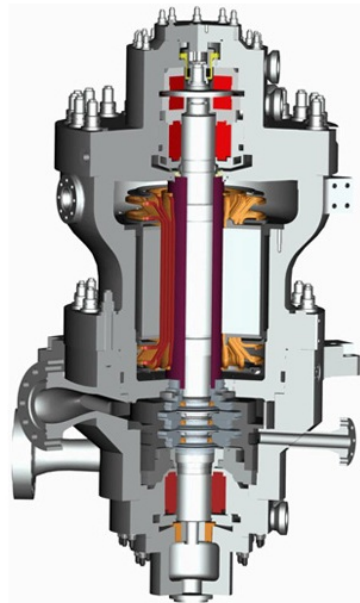

**Siemens
STC-ECO**

**MAN
Hofim**

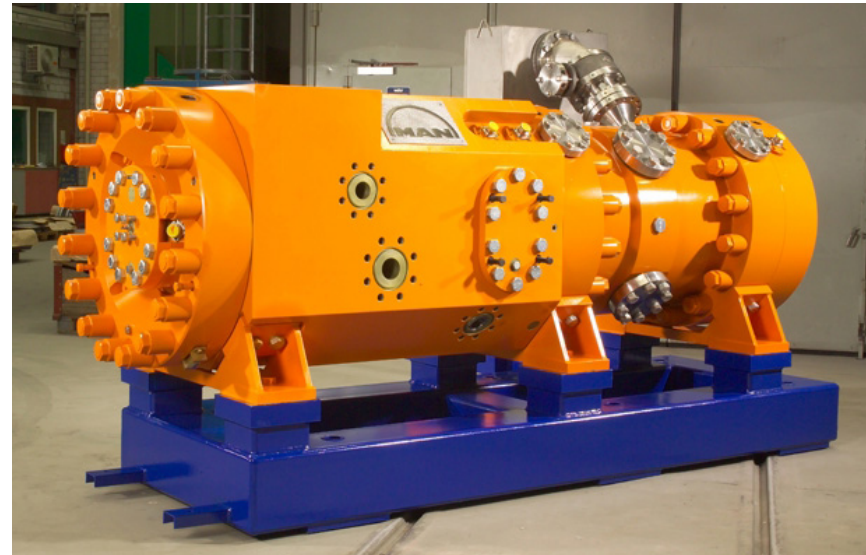

Integrated High Speed EMD Compressors: Clap-Trap avoidance

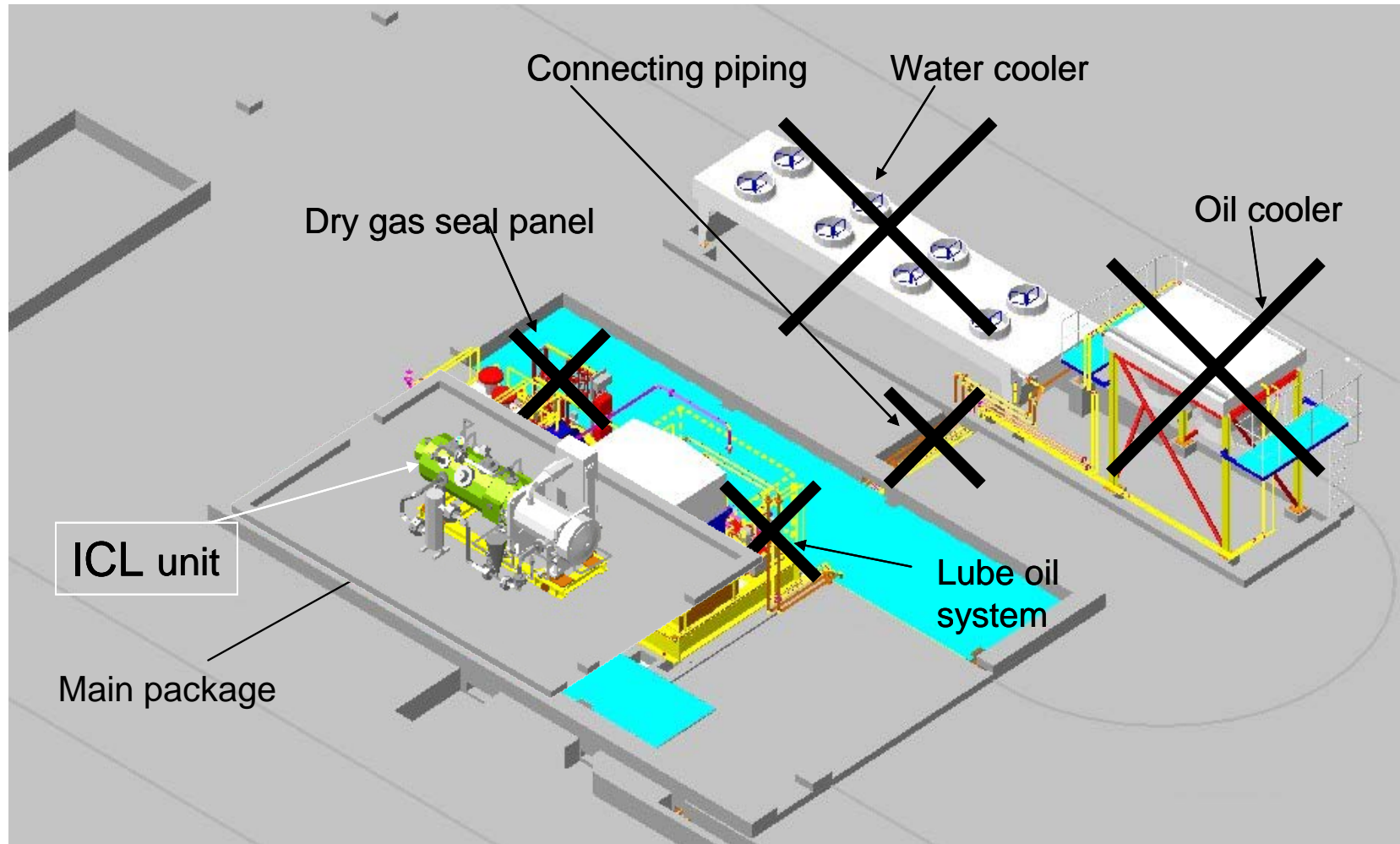

Integrated High Speed EMD Compressors: Clap-Trap avoidance

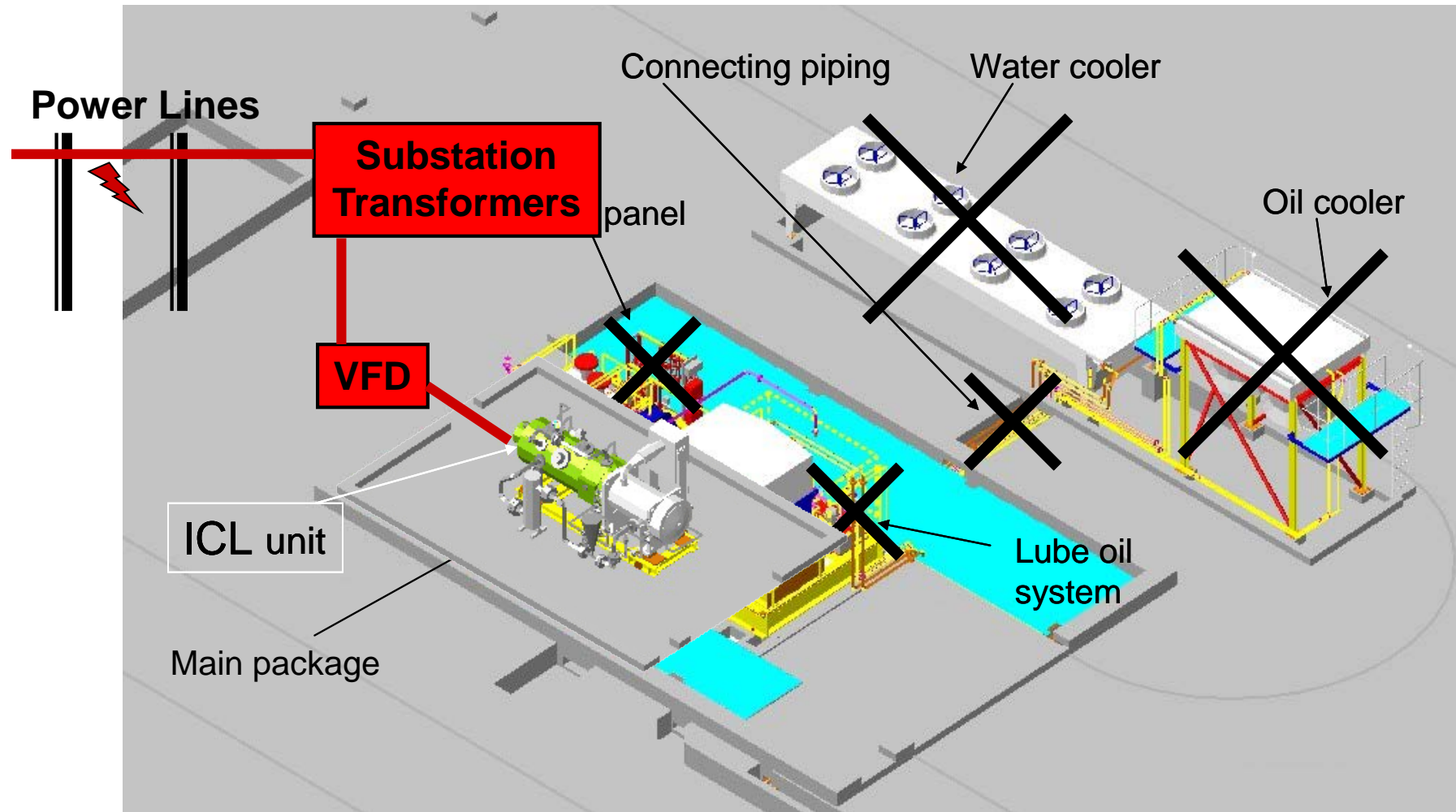

But must add a lot of electrical clap-trap

Efficiency Standards for Compressors

- 1975 Energy Policy and Conservation Act (EPCA)
 - Gives DOE broad powers to regulate efficiency requirements of consumer products and certain industrial equipment
 - List 11 types of equipment and allows the secretary of energy to add other types of equipment
 - Rules must be documented to be technically feasible, economically justified, and result in significant conservation of energy
 - Steps: Framework Document, Preliminary Analysis, Notice of Proposed Rule, Final Rule
- 2012 DOE issues Proposed Determination of Coverage for commercial and industrial compressors
- 2014 DOE issues Request for Information for compressor efficiency standards (includes natural gas compressors)
- 2014 DOE issues Framework Document (air compressors only)
- 2016 DOE issues Minimum Efficiency standards (Final Rule) for air compressors only
- 2017 Administration delays implementation of Final Rule

DOE has Authority to Regulate Oil & Gas Compressor Efficiencies

Future: Natural Gas Compressors

- Unlikely current administration will pursue rulemaking for natural gas compressor minimum efficiency standards
- EPA (both federal and state) can enforce efficiency limits in air permitting process (CO₂ emissions reduction). This is in litigation in several states.
- Current administration's focus for oil & gas appears to be:
 - Energy independence
 - Improved production and distribution infrastructure
 - Supply reliability
 - Less focus on greenhouse gas emission reductions

Machinery Efficiency

Oil & Gas Industry Needs to Address Machinery Efficiency Requirements:

- There will be DOE or EPA rules (eventually)
- Some state EPAs already enforce new station efficiency requirements
- Improves operations economics

Concerns: Efficiency Standards

- What does it apply to?
 - Driver, compressor, train, station, size range, full/part load, type of equipment
- How do you measure it?
 - Continuous, field test, factory, prediction, factors, uncertainties
- How is it defined?
 - Energy balance methods, degradation, leakage, margins
- How is it enforced?
 - Permitting, penalties, require retrofits/upgrades
- What can you do?
 - Machinery/station efficiency, energy recovery, operating range limits, newer machines
- What do you do with the recovered energy?
 - Grid, local use, conversion, storage

Industry needs to address this...or someone else will do it for us



Thank You Very Much!

Questions?

Klaus Brun, Ph.D.

Director R&D

Elliott Group

University Turbine Systems Research Symposium

October 2018