

ATP 1-0.2

Theater-Level Human Resources Support

JANUARY 2017

DISTRIBUTION RESTRICTION. Approved for public release; distribution is unlimited.

Headquarters Department of the Army

This publication is available at the Army Publishing
Directorate site (<http://www.apd.army.mil>),
and the Central Army Registry site
(<https://atiam.train.army.mil/catalog/dashboard>)

Theater-Level Human Resources Support

Contents

	Page
PREFACE	iv
INTRODUCTION	v
Chapter 1 HUMAN RESOURCES (HR) OPERATIONS	1-1
HR Functions and Tasks	1-1
Supporting Relationships.....	1-1
Sustainment Organizations	1-4
Human Resources Sustainment Center (HRSC)	1-8
Support Operations (SPO) Human Resources Operations Branch (HROB) ...	1-12
HR Organizational Structures.....	1-19
Chapter 2 CASUALTY OPERATIONS	2-1
Principles of Casualty Operations	2-1
Battlefield Flow	2-2
Organizational Responsibilities	2-6
Human Resources Operatons Branch (HROB).....	2-10
HR Company	2-10
HR Platoon	2-11
Casualty Liaison Team (CLT).....	2-11
Chapter 3 PERSONNEL ACCOUNTABILITY (PA) OPERATIONS	3-1
Personnel Accountability	3-1
Organizational Responsibilities	3-3
HRSC, Personnel Accountability (PA) Division	3-4
Theater Gateway Personnel Accountability Team (TG PAT).....	3-6
HROB	3-10
HR Company	3-11
HR Platoon	3-11
Personnel Accountability Team (PAT)	3-11
Chapter 4 POSTAL OPERATIONS	4-1
Military Postal Service Mission	4-1
Mail Flow.....	4-2
Organizational Responsibilities	4-5
HRSC, Postal Operations Division (POD) Responsibilities.....	4-7

Contents

	Military Mail Terminal (MMT) Team	4-10
	HROB	4-14
	HR Company.....	4-14
	Postal Platoon	4-15
	Other Postal Information	4-16
Chapter 5	CONDUCT HR PLANNING AND OPERATIONS	5-1
	Plans and Operations.....	5-1
	HRSC, Plans and Operations Division Responsibilities	5-3
	Elements of HR Planning.....	5-5
	HR Planning Using the Military Decisionmaking Process (MDMP)	5-6
	Rapid Decisionmaking and Synchronization Process	5-7
	HR Input to Operations Orders	5-8
Chapter 6	HR AUTOMATION SUPPORT	6-1
	HR Databases.....	6-1
	HR Automation Systems.....	6-2
	Other Automation Systems and Equipment.....	6-4
Appendix A	RELIEF IN PLACE (RIP) AND TRANSFER OF AUTHORITY (TOA)	A-1
Appendix B	RULES OF ALLOCATION (ROA) AND EQUIPMENT REQUIREMENTS	B-1
	GLOSSARY	Glossary-1
	REFERENCES.....	References-1
	INDEX	Index-1

Figures

Figure 1-1. HR sustainment supporting relationship.....	1-2
Figure 1-2. HR tasks and functions conducted at the operational level	1-3
Figure 1-3. Theater sustainment command.....	1-5
Figure 1-4. Expeditionary sustainment command	1-6
Figure 1-5. Sustainment brigade.....	1-7
Figure 1-6. Human resources sustainment center (HRSC)	1-9
Figure 1-7. Human resources operations branch – ESC/SUST BDE (HROB).....	1-13
Figure 1-8. Theater gateway personnel accountability team (TG PAT)	1-19
Figure 1-9. Military mail terminal (MMT) team	1-20
Figure 1-10. HR company.....	1-22
Figure 1-11. HR platoon.....	1-22
Figure 1-12. Postal platoon.....	1-23
Figure 2-1. The casualty reporting flow.....	2-3
Figure 2-2. Casualty reporting and tracking flow (reporting process).....	2-4
Figure 2-3. Casualty operations responsibilities	2-6
Figure 3-1. Personnel processing center conceptual sketch – inbound	3-8
Figure 3-2. Personnel processing center conceptual sketch – outbound.....	3-8
Figure 3-3. Conceptual sketch of a PAT processing point.....	3-12

Figure 4-1. Mail flow 4-2

Figure 4-2. Example MMT layout 4-11

Figure 5-1. Plans and operations synchronization 5-3

Figure 5-2. The military decisionmaking process (MDMP) 5-7

Figure 5-3. Sample operation plan/operation order 5-10

Figure B-1. HR (SRC 12 HR) rules of allocation B-1

Figure B-2. HR equipment requirements..... B-2

Preface

ATP 1-0.2, *Theater-Level Human Resources Support*, guides human resources (HR) actions and enables decision making in conducting HR support at the operational-level in a deployed theater of operation. It provides a comprehensive view of HR doctrine at the operational-level and focuses on key functions and tasks required in the execution and management of HR support. These functions and tasks include casualty operations; personnel accountability (PA) operations; postal operations; HR planning and operations; and HR automation support. While FM 1-0, *Human Resources Support*, is the Army's source of doctrine for HR support, this publication coupled with FM 1-0 and ATP 1-0.1, *G-1/AG and S-1 Operations*, provides a complete library detailing HR support at all levels of execution.

The principal audience for ATP 1-0.2 is all members of the profession of arms. Commanders and staffs of Army headquarters (HQs) serving as joint task force of multinational headquarters should also refer to applicable joint or multinational doctrine concerning the range of military operations and joint or multinational forces. Trainers and educators throughout the Army will also use this publication.

Commanders, staffs, and subordinates ensure that their decisions and actions comply with applicable United States, international, and, in some cases, host-nation laws and regulations. Commanders at all levels ensure that their Soldiers operate in accordance with the law of war and the rules of engagement. (See FM 27-10).

ATP 1-0.2 uses joint terms where applicable. Selected joint and Army terms and definitions appear in both the glossary and the text. Terms for which ATP 1-0.2 is the proponent publication (the authority) are italicized in the text and marked with an asterisk (*) in the glossary. Terms and definitions for which ATP 1-0.2 is the proponent publication are boldfaced in the text. For other definitions shown in the text, the term is italicized and the number of the proponent publication follows the definition.

ATP 1-0.2 applies to the Active Army, Army National Guard/Army National Guard of the United States, and United States Army Reserve unless otherwise stated.

The proponent of ATP 1-0.2 is the United States Army Training and Doctrine Command. The preparing agency is the United States Army Adjutant General (AG) School, Soldier Support Institute. Send comments and recommendations on a Department of the Army (DA) Form 2028 (*Recommended Changes to Publications and Blank Forms*) to the Director, Capabilities Development and Integration Directorate, Soldier Support Institute, ATTN: ATSG-AG-CD, 10000 Hampton Parkway, Fort Jackson, South Carolina 29207-7025; or submit an electronic DA Form 2028 by email to US usarmy.jackson.93-sig-bde.list.jackson-atsg-cdid-ag-doc@mail.mil. In addition to submission of DA Form 2028, provide same comments and recommendations in MilWiki for rapid dissemination to doctrine authors and for universal review at <https://www.milsuite.mil>.

Introduction

ATP 1-0.2 is in the first revision of this publication. It outlines key HR functions and tasks which the HR professional must know to ensure reliable, responsive, and flexible support to personnel who deploy with the force. ATP 1-0.2 defines objectives and standards for conducting continuous theater-level HR operations from initial entry into theater to cessation of hostilities and redeployment. It focuses on the HR support provided by standard requirements code (SRC) 12 HR organizations in the key functions and tasks of casualty operations; PA; postal operations; HR planning and operations; and HR automation support.

ATP 1-0.2 outlines the roles, missions, and responsibilities of HR organizations and sustainment elements involved in theater-level HR operations. HR organizations include the human resources sustainment center (HRSC), theater gateway personnel accountability team (TG PAT), military mail terminal (MMT) team, and HR companies and their subordinate platoons. Sustainment elements involved in HR operations include elements enabling HR organizations to accomplish the mission. They include the Human Resources Operations Branch (HROB) located in the expeditionary sustainment commands (ESCs) and sustainment brigades (SUST BDE).

ATP 1-0.2 makes numerous changes from the initial version. The most significant change to the publication is the removal of Corps and Division assistant chief of staff, personnel (G-1)/adjutant general (AG) duties and responsibilities from chapter 2, Casualty Operations and chapter 4, Postal Operations; this information was added to the first revision of ATP 1-0.1. Other changes include administrative revisions; minor revisions to chapter 6, HR Automation Support, Glossary, and Reference section; and revisions to figures throughout the publication.

ATP 1-0.2 contains six chapters and two appendices.

Chapter 1 discusses theater-level HR operations, which include HR functions and tasks conducted at the operational-level. It provides an overview of the HR and sustainment structure and supporting relationships along with overviews of organizational structures and responsibilities of sustainment organizations (for example; theater sustainment command [TSC], ESC, and SUST BDE) and theater-level HR organizations.

Chapter 2 describes theater-level casualty operations which include battlefield flow and organizational responsibilities of theater-level HR organizations.

Chapter 3 describes theater-level personnel accountability (PA) duties and responsibilities of the HRSC, TG PAT, HROB, HR company, HR platoon, and personnel accountability team (PAT).

Chapter 4 describes theater-level postal operations which include mail flow and organizational responsibilities of Department of Defense (DOD) and DA postal organizations and theater-level HR organizations.

Chapter 5 discusses HR planning and operations which includes specific responsibilities of the HRSC, Plans and Operations Division, elements of HR planning, HR planning using the military decisionmaking process (MDMP), the rapid decisionmaking and synchronization process, and HR input to operations orders.

Chapter 6 provides information on HR databases and systems HR professionals are required to access and operate. Described are specific automated HR databases and systems and other automation systems and equipment needed to perform HR missions in a deployed theater of operation.

Appendix A provides essential core activities during the relief in place (RIP) and transfer of authority (TOA) process.

Appendix B provides rules of allocation (ROA) and equipment requirements for SRC 12 HR organizations which allow HR planners to determine required resources to execute the HR concept of support and also determine positioning and command and support relationships.

ATP 1-0.2 was developed in close coordination with the United States Army Combined Arms Support Command and input taken from throughout the Army HR community.

ATP 1-0.2 does not introduce, modify, or rescind any Army terms or acronyms.

This page intentionally left blank.

Chapter 1

Human Resources (HR) Operations

Theater HR operations include HR functions and tasks planned, coordinated, integrated, or executed by operational-level SRC 12 HR organizations and Human Resources Operations Branches (HROBs) located within expeditionary sustainment commands (ESCs) and sustainment brigades (SUST BDEs). These functions and tasks include casualty operations, personnel accountability (PA), postal operations, and HR planning and operations. HR operations at theater-level are often complex and involve an integrated action by the organizations.

HR FUNCTIONS AND TASKS

1-1. The focus of ATP 1-0.2 is identify HR functions and tasks conducted at operational and tactical levels by HR units or teams:

- Casualty Operations.
- Personnel Accountability (PA).
- Postal Operations.
- HR Planning and Operations.
- HR Automation Support.

1-2. All Army operational and tactical tasks align under one of the six warfighting functions (see ADRP 3-0, *Unified Land Operations*, for additional information on warfighting functions). For HR support, all HR functions and tasks integrate into the sustainment warfighting function. As such, mission command of all HR organizations and units align under the sustainment community. FM 1-0 describes the full range of HR functions and tasks accomplished by units at the operational-level. Only HR specific organizations conduct casualty operations, PA, postal operations, and HR planning and operations.

SUPPORTING RELATIONSHIPS

1-3. The United States Army Human Resources Command (HRC) is the Army G-1's field operating agency responsible for executing personnel strategy policies. Strategic policy execution focuses on developing business rules and procedures to deal with current and anticipated functional processes. The Army Service Component Command (ASCC) links the supported organizational operations to personnel strategy and measures overall progress toward established goals. Figure 1-1, found on page 1-2, depicts the HR sustainment supporting relationship.

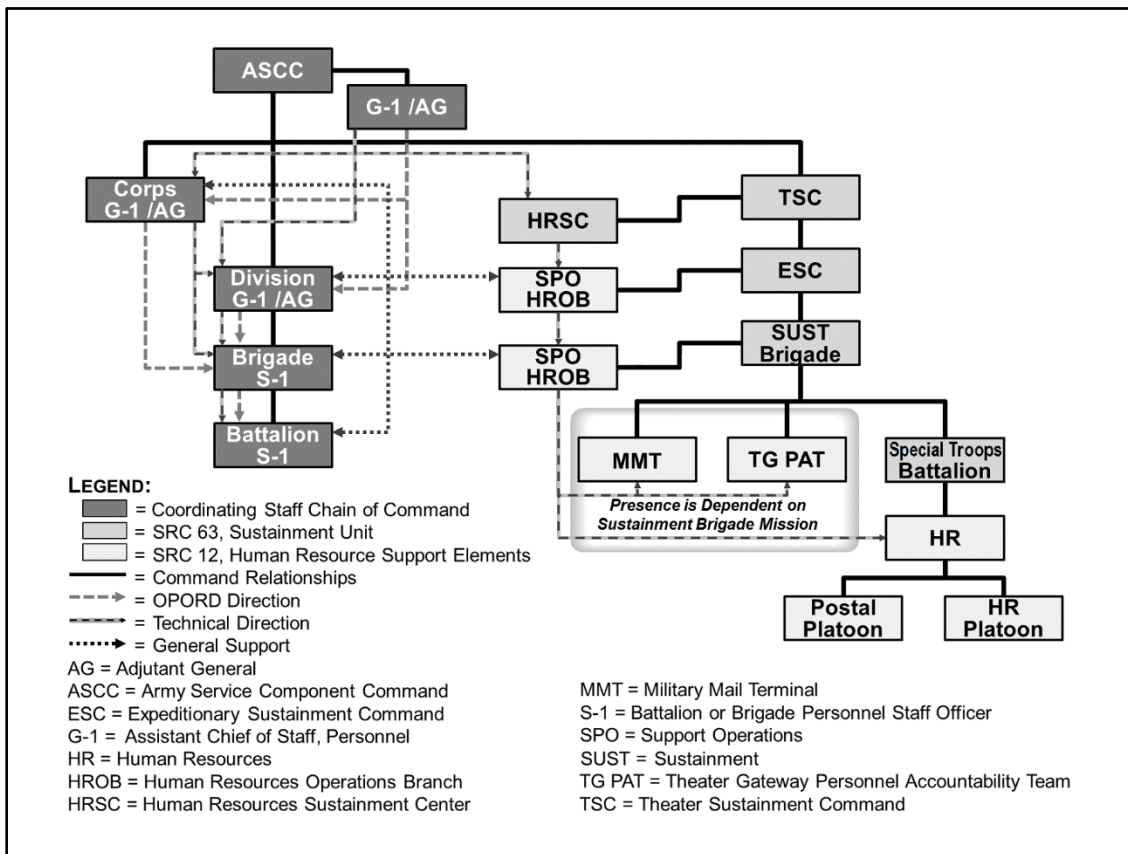

Figure 1-1. HR sustainment supporting relationship

1-4. The HRSC plans, integrates, and coordinates casualty operations, PA, and postal operations support of Army forces within a theater of operations; coordinates and synchronizes HR capabilities with those of the TSC support operations (SPO) section; and supports the ASCC G-1/AG.

1-5. The integration of HR capabilities with those of the TSC SPO provides the basis for coordinated and synchronized HR support to operations throughout theater. When executed properly, integrated HR support is a combat multiplier.

1-6. Figure 1-2, found on page 1-3, depicts HR tasks and functions conducted at the operational-level. Key HRSC tasks requiring synchronization and coordination with the TSC SPO section include, but are not limited to:

- Developing deployment and redeployment plans.
- Determining, in coordination with the TSC assistant chief of staff, operations (G-3) and SPO section, the number, type, and location of HR resources.
- Assessing the current situation and forecasting HR requirements.
- Directing action to apply HR resources and support at decisive points and time.
- Coordinating the execution of transportation support for mail movement within theater, to include enemy prisoner of war (EPW) mail.
- Determining casualty operations support requirements.
- Coordinating the execution of transportation support to move transiting personnel within a theater of operations.
- Coordinating life support for arriving replacements and transiting personnel.

Task	Task Management	Task Execution	Task Supporting
Casualty Operations	HRSC (COD)	HRSC (COD) HR Co (HR Plt)	HROB
Personnel Accountability (PA) Operations	HRSC (PA)	TG PAT (PA) HR Co (HR Plt)	HROB
Postal Operations	HRSC (POD)	MMT HR Co (Postal Plt)	HROB
HR Planning and Operations	HRSC	TG PAT, MMT HR Co	HROB Sust Bde
HR Automation Support	HRSC (PA)	HRSC (PA) HR Co	HROB

LEGEND:

Co = company	PA = Personnel Accountability
COD = Casualty Operations Division	Plt = platoon
HR = Human Resources	POD = Postal Operations Division
HROB = Human Resources Operations Branch	Sust Bde = Sustainment Brigade
HRSC = Human Resources Sustainment Center	TG PAT = Theater Gateway Personnel Accountability Team
MMT = Military Mail Terminal	

Figure 1-2. HR tasks and functions conducted at the operational level

1-7. The end product of this integration effort is synchronized and coordinated HR support to Army forces sustaining operational readiness, and a unity of effort which reduces the HR impact on logistics resources. FM 1-0 provides detailed information on HR support.

1-8. Of special interest is the requirement for HR planning and execution to support theater opening operations. Theater opening HR support is critical to the success of the reception, staging, onward movement, and integration (RSOI) process. To ensure establishment of initial HR capabilities prior to the arrival of the main flow of forces, HR support elements are included as part of the early entry element of the SUST BDE assigned to the theater opening mission. Planning requirements include the placement and number of HR elements and units within a theater of operations. HR support responsibilities for early entry elements include the following:

- Initiate and establish theater PA and personnel tracking.
- Establish and operate theater casualty assistance center and conduct casualty operations.
- Establish, operate, and maintain the theater personnel database.
- Coordinate and synchronize the establishment of a military mail terminal (MMT) to support postal operations for theater.
- Estimate intra-theater mail movement usually by ground between the MMTs and Army post offices (APOs).

1-9. Additional theater gateway personnel accountability teams (TG PATs) and MMT teams, with corresponding HR companies and platoons, are required if more than one inter-theater aerial port of debarkation (APOD) and sea port of debarkation (SPOD) is used for RSOI and postal flows.

1-10. To be successful in accomplishing the HR mission, it is important for HR leaders, technicians, and individuals to understand the varying relationships between HR units and teams and how to provide HR support. The HR community should have knowledge and understanding of how other sustainment organizations support the HR mission, especially non-HR tasks. An excellent example of supporting HR tasks of postal operations requires coordination with transportation elements to ensure ample vehicles and

other equipment are available to transport mail once it has been processed by the MMT to other postal facilities. Another example is personnel in transit need transportation, food, and shelter.

1-11. HR organizations have varying relationships within the deployed theater as they provide HR support. Key relationships include the command and support relationship within the sustainment structures, the provision of technical guidance from the HRSC (through the HROB within the SPO section), and the supported to supporting relationship between HR organizations, G-1/AGs, and the battalion or brigade personnel staff officer (S-1). All HR organizations deployed to a theater of operations are assigned or attached to an ESC or SB, except for the HRSC. Sustainment brigades also provide training readiness oversight of HR organizations. The HRSC, if deployed, normally attaches to the special troops battalion (STB) supporting the TSC or ESC.

1-12. The ASCC establishes policies and priorities and provides commander's intent and planning guidance. The HRSC ensures execution, synchronization, and integration of casualty, PA, postal, and strength reporting key functions consistent with policy, guidance, and priorities established by the ASCC G-1/AG.

1-13. The HRSC provides planning operations for the ASCC G-1/AG in the areas of casualty, PA, postal, and strength reporting, and ensures synchronization, execution, and compliance within sustainment war fighting functions (for example; build up, draw down, and force structure realignment).

1-14. The TSC is the senior sustainment organization for a theater of operations and is the key linkage between the ASCC G-1/AG and the HRSC. The TSC provides a centralized sustainment mission command of most deployed sustainment organizations and is responsible for planning, controlling, and synchronizing all operational-level sustainment operations for the ASCC or joint task force (JTF), while conducting unified land operations, employment, sustainment, and redeployment. The TSC G-1/AG's focus is on TSC specific (internal) HR support, while the HRSC focus is theater-wide. (Refer back to Figure 1-1, on page 1-2, for TSC relationships).

1-15. In most cases, mission command of all SRC 12 HR organizations resides within the deployed theater sustainment organizations. (Note: See Appendix B, Figure B-1, for a listing of SRC 12 HR organizations). The highest level of "pure" HR mission command found is in the HR company.

1-16. Technical Guidance is provided by the various divisions of the HRSC and is passed to subordinate HROBs (SRC 63) in the ESC and SUST BDEs, and then ultimately to the SRC 12 HR organizations to execute casualty, PA, and postal support.

1-17. The establishment of a close relationship between G-1/AGs, S-1s, and the supporting HROBs is critical for timely support. G-1/AGs and S-1s have a supported and supporting relationship with the sustainment structure of the theater and integrate their requirements through the HROBs of either the ESC or the SB.

SUSTAINMENT ORGANIZATIONS

1-18. The TSC is the senior sustainment organization responsible for providing the capabilities and support for all theater sustainment. The TSC executes its mission through the use of modular forces, to include ESCs, SUST BDEs, combat sustainment support battalions (CSSBs), STBs, and other modular sustainment organizations such as the HRSC, HROBs, HR companies, and staff elements for HR support. Note: The TSC, ESC, or SUST BDE has mission command responsibility for HR units. The HRSC is a staff element of the TSC. While the TSC does not normally deploy, it may deploy an ESC to provide mission command for sustainment units in an area of operation as defined by the TSC. Figure 1-3, found on page 1-5, depicts the TSC with an HRSC. See ATP 4-94, *Theater Sustainment Command*, for additional information on TSCs.

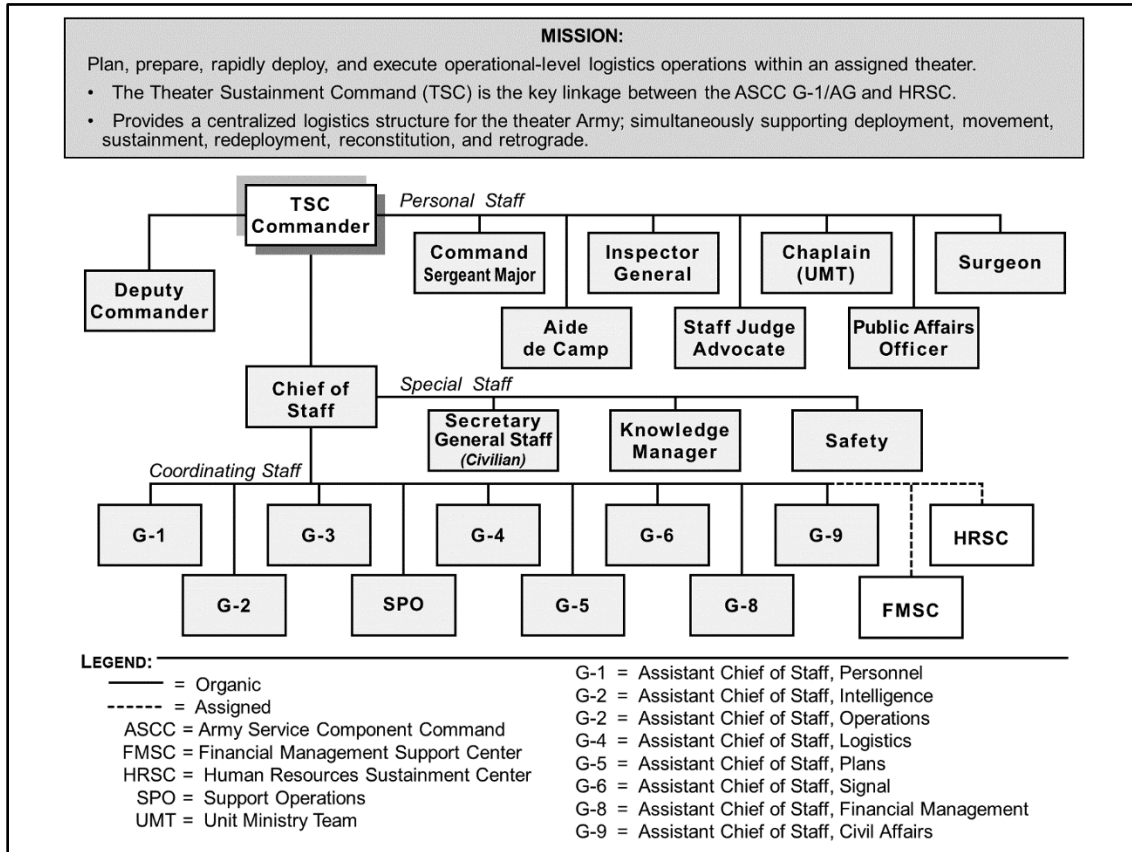

Figure 1-3. Theater sustainment command

1-19. The SUST BDE is a flexible, modular sustainment organization. Organic to the SUST BDE are the brigade headquarters (HQs) and an STB. All other assets are task organized to the SUST BDE to enable it to accomplish its sustainment warfighting roles and mission. The SUST BDEs provide sustainment support at the operational and tactical levels and are capable of providing mission command for theater opening and theater distribution missions. All HR organizations providing support to theater or joint operations area (JOA) are under the operational control of the SUST BDEs.

1-20. Each ESC and SUST BDE has an organic SPO section. This section is comprised of several branches which focus on specific sustainment support. For example, the HROB provides technical guidance and resources for HR units executing casualty, PA, or postal missions. The HROB also conducts range of military operations planning and staff analysis for HR support. This planning and staff analysis is not only for HR units, but all supported organizations within the SUST BDE's area of operations (AO).

EXPEDITIONARY SUSTAINMENT COMMAND (ESC)

1-21. The ESC, attached to a TSC, provides mission command for attached units in an AO as defined by the TSC. As a deployable command post for the TSC, the ESC provides operational reach and span of control. The ESC plans and executes sustainment, distribution, theater opening, and RSOI for Army forces within the range of military operations. The ESC may serve as the basis for an expeditionary joint sustainment command when directed by the combatant commander or his designated representative.

1-22. The role of the ESC is to provide forward-based mission command of assigned units. It normally deploys to the AO and/or JOA and provides mission command when multiple SUST BDEs employ or when the TSC determines a forward command presence is required. This capability provides the TSC commander with the regional focus necessary to provide effective operational-level support to Army or JTF missions. The TSC may employ multiple ESCs within theater.

1-23. The forward deployment of the ESC facilitates agile and responsive support by placing the ESC in relative proximity of the supported force and its AO. Positioned to provide a regional focus, the optimal placement of the ESC refines that portion of the TSC logistics preparation of the theater assessment applicable to the JTF AO and to array logistics forces accordingly.

1-24. Depending on the command structure within theater, ESCs may employ to support specific Army forces within a specific AO and/or JOA or to support other ESCs or SUST BDEs with theater opening or theater distribution capabilities.

1-25. The ESC provides essentially the same range of support staff capabilities but not to the scale and scope of the TSC. It lacks orientation planning and full scale materiel management capabilities.

1-26. The ESC focuses on synchronizing operational-level sustainment operations to meet the day-to-day and projected operational requirements of the JTF or supported force. It accomplishes this, in part, by establishing commitment and contingency planning horizons which are derived from the JTF operation plan (OPLAN), commander’s intent, commander’s critical information requirement (CCIR), operational tempo, and distribution system capacity.

1-27. ESC staffs provide commanders with relevant information in usable forms which help commanders achieve accurate situational understanding. Situational understanding enables commanders to make well informed and timely decisions and allows staffs to rapidly synchronize and integrate actions in accordance with (IAW) the commander’s intent. Each ESC SPO section accomplishes this essential function by processing information, employing decision support aids, and conducting comparative analyses in order to quickly turn information into knowledge, create situational understanding, and share a common operational picture (COP). Figure 1-4 depicts the ESC organizational structure.

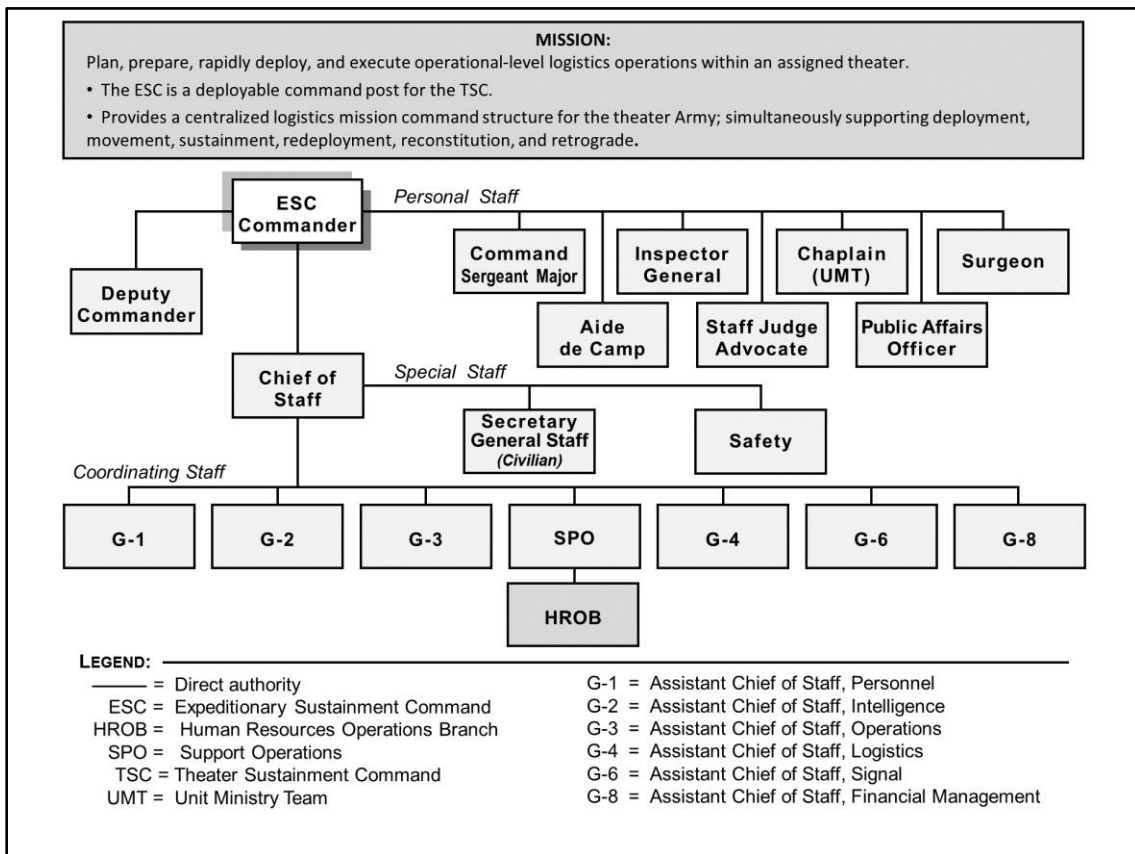

Figure 1-4. Expeditionary sustainment command

SUSTAINMENT BRIGADE (SUST BDE)

1-28. Sustainment brigades consolidate selected functions previously performed by corps and division support commands and area support groups into a single operational echelon and provide mission command of theater opening, theater distribution, and sustainment operations. ATP 4-93, Sustainment Brigade, provides greater detail on the mission and organization of the SUST BDE. Combat sustainment support battalions are the building blocks of the SUST BDEs. Their HQs designs are standardized and they can consist of up to eight companies. They are modular and task organized to support theater opening, theater distribution, area sustainment, or life support missions.

1-29. Sustainment brigades provide mission command and staff supervision of life support activities, and distribution management to include movement control as an integral component of the theater distribution system. With augmentation, they are capable of performing theater opening functions. Commanders and leaders use operational and mission variables to determine the mix of functional and multifunctional subordinate battalions under their control. See ADRP 3-0, Unified Land Operations, for more information regarding operational and mission variables.

1-30. Sustainment brigades are an integral component of the joint and Army battlefield communications network. They employ satellite and network-based communications enabling mission command, visibility of the distribution system, and identification (ID) of support requirements.

1-31. The SUST BDE materiel management effort focuses on the management of its supply support activities IAW TSC plans, programs, policies, and directives. The SUST BDE may also provide materiel management of bulk supplies through oversight of stockage areas such as bulk fuel and ammunition storage areas. The SUST BDE coordinates and controls supply functions, including the redistribution of intra-theater excess, to meet the operational requirements of the TSC and its supported units, employing near real-time situational awareness of stock records and asset visibility to provide responsive and agile support. Analysis of stock status and mission requirements enables the SUST BDE to effectively manage its workload and control potential backlogs or bottlenecks generated by competing requirements and/or priorities. Figure 1-5 depicts the SUST BDE organizational structure.

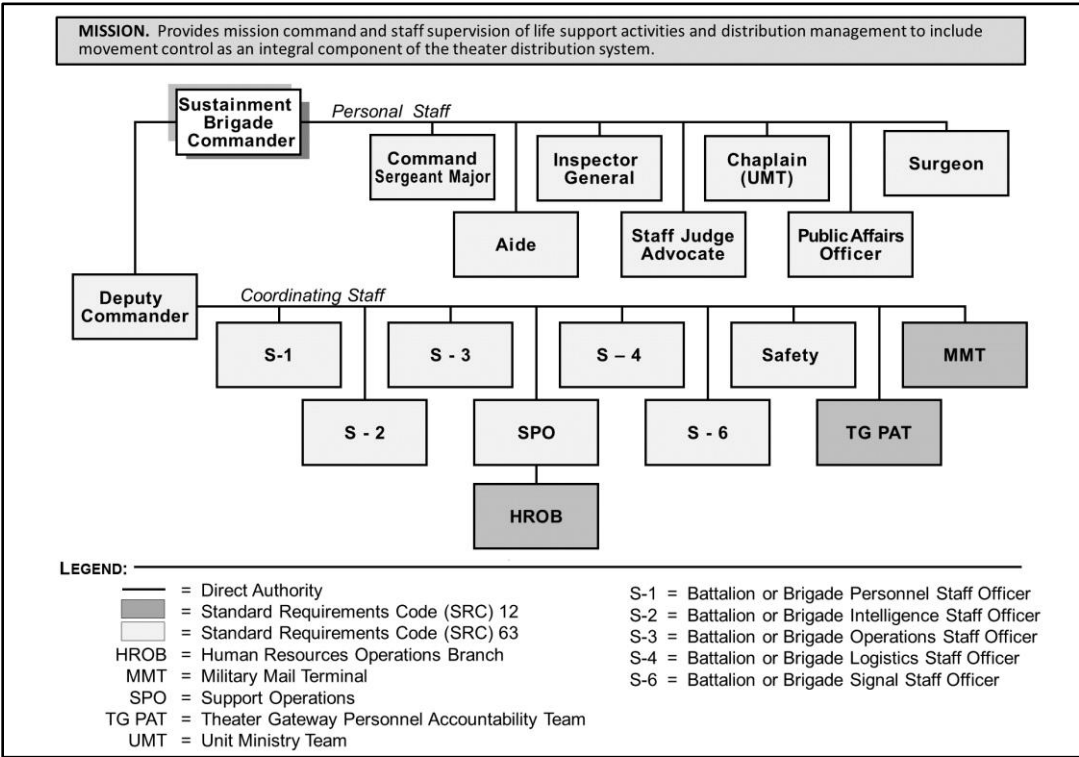

Figure 1-5. Sustainment brigade

COMBAT SUSTAINMENT SUPPORT BATTALION (CSSB)

1-32. The CSSB is the building block upon which the TSC sustainment capabilities are developed. Typically attached to an SUST BDE, the CSSB tailors to meet specific mission requirements. Attached capabilities, drawn from the Army's Sustainable Readiness Process, may include transportation, maintenance, ammunition, supply, mortuary affairs (MA), airdrop, field services, water, and petroleum.

1-33. Employed on an area basis, the CSSB plans, coordinates, synchronizes, monitors, and controls sustainment operations (less health service support) within a specified AO and supports units in or passing through its geographic area.

SPECIAL TROOPS BATTALION (STB)

1-34. The SUST BDE's only organic subordinate unit is the STB. The STB provides mission command for assigned and attached personnel and units. The STB has a HQs company which consists of a food service section, a maintenance section, trial defense team, a treatment section (medical), and a unit ministry team. The STB integrates the functions of the battalion or brigade personnel staff officer (S-1), battalion or brigade intelligence staff officer (S-2), battalion or brigade operations staff officer (S-3), battalion or brigade logistics staff officer (S-4) and provides the company for personnel assigned to the brigade and STB. The staff also provides information and advice to supported commanders. When augmenting the SUST BDE, financial management and HR companies may also attach to the STB.

HUMAN RESOURCES SUSTAINMENT CENTER (HRSC)

1-35. The HRSC functions as a staff element of the TSC. The HRSC provides theater-level support to the ASCC G-1/AG and enables the TSC commander to plan, integrate, and execute HR support to theater. The TSC is the key linkage between the ASCC G-1/AG who provides policy, direction, and guidance for HR support to theater, and the HRSC who plans, coordinates, and executes theater-level responsibilities for casualty, PA, and postal operations. The HRSC has a defined role to ensure the theater HR support plan is developed and then supported with available resources within the TSC. The HRSC is the technical link to HR organizations which execute casualty, PA, and postal support functions. Figure 1-6, found on page 1-9, depicts the HRSC organizational structure.

1-36. The HRSC is a multifunctional, modular organization integrating and ensuring execution of HR support throughout theater as defined by the policies and priorities established by the ASCC G-1/AG. The HRSC provides planning and operations technical support to the TSC distribution management center. The HRSC provides technical guidance to the HROB in SUST BDEs and ESCs, and HR companies and teams. The HRSC's flexible, modular, and scalable design increases the HRSC director's ability to recommend HR support based on operational and mission variables. The HRSC's ability to directly coordinate needed sustainment resources with the TSC distribution management center to support postal and personnel accountability team (PAT) operations is critical to mission success.

1-37. The HRSC provides technical guidance and ensures execution of the casualty, PA, and postal core competencies performed by SRC 12 HR elements, including the TG PAT, MMT team, HR companies, platoons, teams, and HROBs in the SUST BDEs and ESCs. The HRSC provides operational planning and current and future operations management. It coordinates support for the TSC and ASCC G-1/AG, ensures connectivity and resource support for casualty, postal, and PATs, integrates personnel data when necessary, and participates in the TSC distribution management process. HRSC responsibilities include:

- Providing timely, accurate, relevant, and reconciled information to the ASCC G-1/AG enabling the decision making process.
- Planning, coordinating, integrating, and executing HR support as defined by the ASCC and TSC commander (especially in the core competencies of casualty, PA, and postal operations).
- Providing technical guidance and support to subordinate HROBs, HR companies and their subordinate platoons, and in some areas, supported G-1/AG and S-1 sections.
- Maintaining oversight of PA; data access, reporting, and analysis; and casualty, postal, and PAT operations executed by SRC 12 HR organizations IAW ASCC G-1/AG policy.

- Establishing the deployed theater casualty assistance center linked to the casualty and mortuary affairs operations center (CMAOC) at HRC.
- Establishing the infrastructure supporting the theater deployed personnel database, currently supported by the Deployed Theater Accountability System (DTAS). Operates and maintains the DTAS database in coordination with the ASCC G-1/AG.
- Establishing linkages to continental United States (CONUS) based postal national-level agencies such as the military postal service agency (MPSA) and the joint military postal activity (JMPA).
- Providing policy recommendations, through the TSC to the ASCC G-1/AG, for inclusion in the Department of the Army (DA) G-1 personnel policy guidance which is routinely updated to reflect requirements for deployed forces.

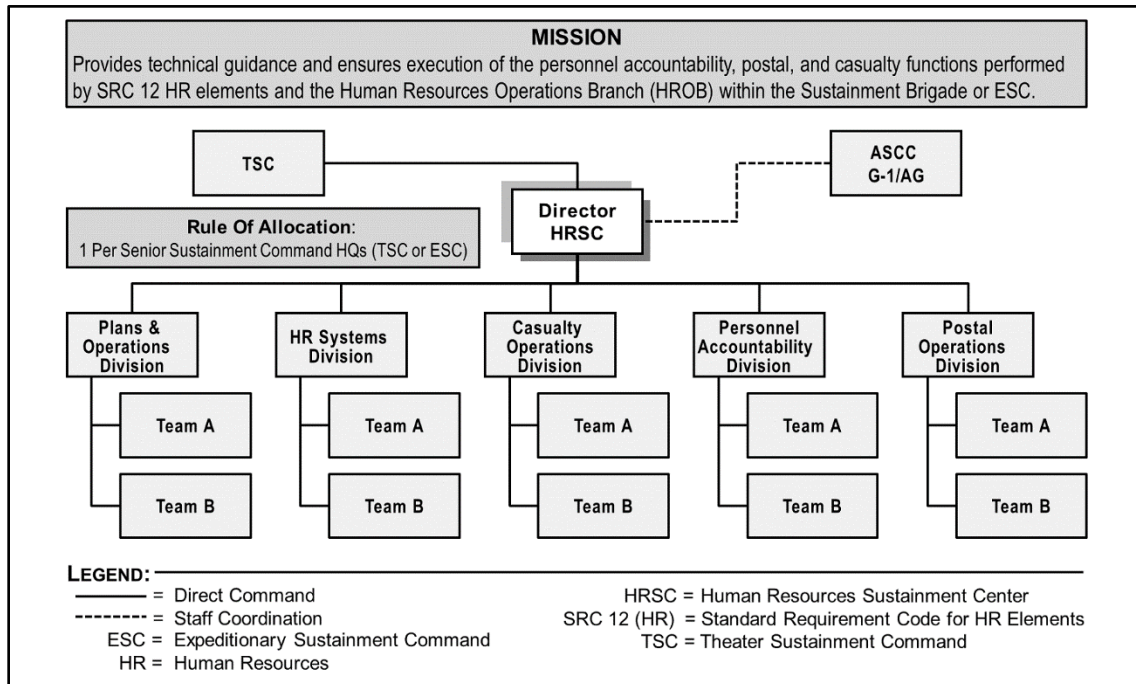

Figure 1-6. Human resources sustainment center (HRSC)

HRSC, HEADQUARTERS SECTION

1-38. The HRSC, Headquarters Section plans, integrates, and coordinates plans and operations, HR systems, casualty operations, PA operations, and postal operations missions as defined by the policies and priorities established by the ASCC G-1/AG. The section consists of the Director, Deputy Director, and Chief HR Sergeant. The Headquarters Section, in coordination with the TSC, has a defined role ensuring the theater HR support plan is developed and supported with available resources within the TSC organization. As the senior Army HR organization within theater, the Headquarters Section is the technical link and advisor to theater HR organizations for HR systems, PA, and casualty and postal operations. Critical functions for the HRSC, Headquarters Section include:

- Integrating and executing the casualty, PA, and postal missions as defined by the policies and priorities established by the ASCC G-1/AG.
- Providing technical guidance (and training assistance) to the ESC and SUST BDE SPO HROB's, who then pass the information to the HR organizations assigned to sustainment units.
- Establishing the deployed theater casualty assistance center.
- Providing technical support to the TSC SPO/distribution management center and then the ASCC G-1/AG.
- Establishing, operating, and managing the theater personnel database providing theater-wide assistance for database issues and access.

- Conducting at least annual inspections and audits of contingency military post offices (MPOs) within the HRSC AO.

HRSC, HEADQUARTERS SECTION PERSONNEL RESPONSIBILITIES

1-39. The duties and responsibilities for personnel assigned to the HRSC, Headquarters Section include, but are not limited to the following:

- Director:
 - Oversees the execution of all HR systems, casualty, PA, and postal operations in theater.
 - Coordinates with the TSC HQs as appropriate.
 - Determines and organizes internal support requirements for the HRSC.
 - Provides technical guidance and support to HR organizations as required.
- Deputy Director:
 - Maintains and manages organizational budget.
 - Prepares and attends all staff briefs for higher HQs to include coordination and tasking from higher.
 - Consolidates HRSC divisional information updates for the director.
 - Acts as the Defense Travel System approval authority.
 - Appointed as the Government Purchase Card billing official (can further delegate to Plans and Operations division).
- Chief HR Sergeant:
 - Senior enlisted advisor to the director.
 - Assists the director in establishing HR systems, casualty, PA, and postal operations.
 - Maintains communications with the TSC SPO section for planning and resourcing HR operations.
 - Coordinates with the TSC HQs for Soldier related issues.
 - Ensures internal support requirements for the HRSC are accomplished.
 - Monitors all morale, welfare, and quality of life issues for the organization.
 - Monitors unit and enlisted personnel training.
 - Administers and monitors the unit noncommissioned officer (NCO) development program and low-density functional training.
 - Administers and chairs unit selection and Soldier boards for enlisted personnel.
 - Receives and integrates newly assigned enlisted personnel.
 - Assists in inspecting command activities and facilities.

PLANS AND OPERATIONS DIVISION

1-40. The Plans and Operations Division provides the HRSC Director the capability to manage current operational requirements and planning for both long and short range HR operations. Specific responsibilities of the division include, but are not limited to the following:

- Provides long and short range planning for the execution of HR tasks supported by HR organizations (for example; casualty operations, PA, and postal operations).
- Assists the director in managing current HR operational requirements.
- Tracks force flow and monitors down-trace HR organizations deployment plans, deployment preparations, and support of contingency operations in the allocated AO.
- Manages internal HRSC deployment plans, deployment preparation, and support of contingency operations in the allocated AO.

HR SYSTEMS DIVISION

1-41. The HR Systems Division is responsible for establishing and maintaining systems within theater. Specific responsibilities of the division include, but are not limited to the following:

- Ensures all systems remain active and properly synchronized to receive data from both the supporting PAT elements and the S-1 and G-1/AG sections operating in the AO.
- Participates and ensures all systems are included in the planning, deployment, sustainment, and redeployment process for current and future HR operations.
- Continues to assess and analyze the effectiveness of systems throughout current operations.
- Coordinates with the TSC and ESC to ensure systems are established and resourced to effectively perform missions.
- Deploys adequate personnel as part of the early entry element in order to establish initial theater systems.
- Provides data support, information, and reports to the TSC and Army/ASCC G-1/AG as necessary.

CASUALTY OPERATIONS DIVISION (COD)

1-42. The COD establishes the theater casualty assistance center and manages casualty reporting within theater of operations IAW policies established by the ASCC G-1/AG. Specific responsibilities of the division include, but are not limited to the following:

- Serves as the point of contact for all CMAOC actions by establishing a direct link to CMAOC.
- Reports all casualties from Department of Defense (DOD) civilians, contractors, and personnel from other Services (if the sponsoring Service is not in the immediate area).
- Receives, processes, and forwards all casualty reports in theater.
- Maintains and provides casualty data and briefings for the ASCC G-1/AG.
- Assists CMAOC through monitoring formal line of duty (LOD) investigations on deceased Soldiers.

PERSONNEL ACCOUNTABILITY (PA) DIVISION

1-43. The PA Division is responsible for planning and providing technical guidance, and maintaining visibility of personnel transiting inter/intra theater APOD/aerial port of embarkation (APOE). Specific responsibilities of the division include, but are not limited to the following:

- Establishes and maintains the theater deployed database.
- Uses DTAS, electronic Military Personnel Office (eMILPO), and other HR systems to prepare, collect, and analyze required reports to maintain situational awareness of theater PA status and PA operations.
- Manages the theater database hierarchy and makes adjustments as the ASCC G-1/AG and G-3 updates and modifies task organization.
- Provides assistance and support to the ASCC G-1/AG in developing and executing the rest and recuperation (R&R) program.
- Monitors and recommends distribution and emplacement of PATs.
- Conducts staff assistance visits (SAVs) for APODs and PATs.
- Coordinates with the Plans and Operations Division and the TSC SPO section (Mobility Branch) for deployment and redeployment plans.
- Coordinates with appropriate agencies for external sustainment support, life support (food and billeting), and onward transportation for transiting personnel.

POSTAL OPERATIONS DIVISION (POD)

1-44. The POD provides postal assistance and technical guidance to HROBs and HR companies and ensures they are in compliance with postal operations policies and regulations. The POD directly supports the execution of the theater postal policy and EPW mail mission and identifies appropriate resources to support the theater postal mission. Specific responsibilities of the division include, but are not limited to the following:

- Provides technical guidance and compliance support to all subordinate HROBs.
- Assists the ESC HROB in the establishment of theater opening postal operations.

- Establishes the deployed AO postal inspection plan.
- Establishes direct coordination with both the MPSA and the servicing JMPA and conducts detailed postal planning and coordination with the MPSA.
- Ensures DOD Civilian, contractor, and multi-national support requirements are determined and disseminated.
- Monitors and determines appropriate mail flow rates and ensures current data integrates into all TSC and ESC SPO planning.

SUPPORT OPERATIONS (SPO) HUMAN RESOURCES OPERATIONS BRANCH (HROB)

1-45. The HROB, assigned to the SPO section of the ESC and SUST BDE, is part of the documented SRC 63 Table of Organization and Equipment. The HROB is a critical element responsible for the synchronization of theater HR support within sustainment organizations with mission command of SRC 12 HR organizations. The HROB is the key integrator between G-1/AGs, casualty, PA, and postal organizations supporting the execution of subordinate key functions.

1-46. The mission of the HROB is to plan, coordinate, integrate, and manage the emplacement and operations of subordinate HR elements in synchronization with the concept of support plans for casualty, PA, and postal operations throughout the ESC and SUST BDE's AO. The HROBs provide technical guidance to SRC 12 HR organizations and are the most important planning and coordinating elements on the battlefield for the delivery of HR support. The HROB conducts range of military operations planning and coordination within the SPO section to synchronize SRC 12 HR support organizations attached, assigned, and supported within the ESC or SUST BDE AO. The HROB receives technical guidance from the HRSC and operational guidance from mission command channels. Figure 1-7, found on page 1-13, depicts the ESC and SUST BDE HROB organizational structures.

1-47. The following list of responsibilities provides focus for both HR and sustainment leadership on the principal duties and roles for the HROB section of the SPO. This list is not restrictive or complete, but highlights major tasks and responsibilities.

- Receives HR mission support requirements for attached, assigned or supported SRC 12 HR organizations.
- Conducts mission analysis, develops and analyzes courses of action (COAs), and recommends to the SPO and ESC/SUST BDE commander COAs which support priorities of support, available HR resources, and composition of the supported population.
- Plans and coordinates for sufficient HR organizations in order to provide HR support based on rules of allocation (ROA) and the commander's intent.
- Plans, coordinates, synchronizes, and monitors HR support (casualty, PA, and postal) during military operations.
- Coordinates and executes the preparation of plans and orders.
- Develops mitigation strategies.
- Coordinates and synchronizes with the assistant chief of staff, signal (G-6) and/or battalion or brigade signal staff officer (S-6) for HR connectivity requirements and software updates (for example; voice, Nonsecure Internet Protocol Router Network [NIPRNET], and SECRET Internet Protocol Router Network [SIPRNET]).
- Collects, correlates, analyzes, and reports HR support information to the ESC and SUST BDE commanders.
- Plans and recommends the placement of HR organizations within the ESC and SUST BDE AO.
- Provides the SPO section and commander the estimate for HR support requirements and the availability of HR organizations needed to provide the forecasted support.
- Coordinates and/or provides technical training to supported and supporting units.
- Provides operational guidance to supporting HR companies.
- Coordinates and assists in the development of performance work statements for HR contracts and interacts with contracting officers and contracting officer representatives (CORs) within the AO.

- Coordinates and conducts HR unit force management using force tracking numbers and the HR crosswalk and identifies gaps or excessive overlaps.
- Conducts HR focused military decisionmaking process (MDMP) or rapid decisionmaking and synchronization process.
- Provides HR input to OPLANs/operation orders (OPORDs).
- Develops the HR running estimate.
- Prepares the HR concept of support.
- Provides current and future HR input to the staff planning process.
- Conducts SAVs in the areas of casualty, PA, and postal operations.
- Maintains liaison with higher or lateral sustainment HQs to manage and coordinate HR operations within the AO.
- Assists HR organizations in receiving required resources needed to accomplish assigned tasks.
- Recommends CCIRs for HR operations.
- Coordinates with other SPO section branches to establish and execute recurring logistic requirements for casualty, PA, and postal operations.
- Coordinates with other SPO section branches and sustainment units for the execution of life support (for example, billeting and feeding) for transiting personnel.
- Coordinates all mobile postal and PAT missions within the AO.

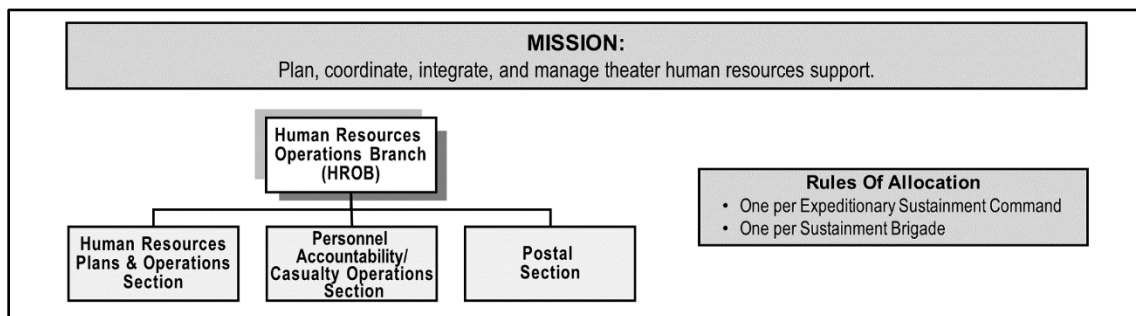

Figure 1-7. Human resources operations branch – ESC/SUST BDE (HROB)

ORGANIZATIONAL FUNCTIONS

1-48. The critical functions of the ESC and SUST BDE HROB are:

- Serves as integrator between the HRSC and assigned or attached HR organizations (for example; HR company, MMT team, and TG PAT) for execution of HR support.
- Serves as integrator between supported units (for example, G-1/AG and S-1s) and sustainment organizations for the execution of external HR support.
- Synchronizes non-HR support requirements with other sustainment elements and organizations (for example; transportation, billeting, and feeding for transient personnel).
- Plans, projects, and recommends HR support requirements for current and future military operations (for example, MDMP).
- Ensures the emplacement and displacement of HR support organizations are in synchronization with the concept of support plans for casualty, PA, and postal operations.
- Deploys as part of the ESC or SUST BDE early entry element to assist in establishing initial theater casualty, PA, and postal operations.

HROB PERSONNEL RESPONSIBILITIES

1-49. A typical HROB consists of 5 to 7 personnel depending on whether it is supporting the ESC or SUST BDE. Roles and responsibilities for these personnel include, but are not limited to the following:

Expeditionary Sustainment Command (ESC) Level HROB

1-50. HR Support Operations Officer:

- Analyzes, projects, and recommends HR force structure and capabilities required to support current and future military operations.
- Monitors execution of the HR crosswalk and resolves critical force management issues as required.
- Prepares staff summary actions, decision briefings, mitigation plans, and information papers in order to provide coordinated recommendations and situational awareness to the command.
- Monitors and provides technical oversight to the orders process.
- Responsible for planning, coordinating, synchronizing, monitoring, and technical oversight of PA, casualty, and postal elements in the ESC operational area, while developing adjacent unit coordination among the HRSC, SUST BDE HROBs, and staff.
- Prepares or assists in preparation of the HR annex of the ESC OPOD and HR concept of support, and compiles HR concept of support for the entire theater of operations.
- Participates in the MDMP and risk management process.

1-51. HR Officer:

- Responsible for planning, coordinating, synchronizing, monitoring, and technical oversight of postal elements in the AO.
- Reviews, monitors, and recommends postal asset distribution within the AO and reviews OPODs and fragmentary orders (FRAGORDs) for HROB mission impact.
- Serves as the section historian responsible for documenting lessons learned; tactics, techniques, and procedures; and maintaining the diary of events which contribute to the HROB's standard operating procedures (SOP) and continuity book.
- Assesses the current situation and forecasts HR requirements based on the progress of the operation.
- Executes and adjusts postal plan to exploit opportunities or unforecasted requirements.
- Directs actions to apply HR resources and support at decisive points and time.

1-52. HR Technician:

- Serves as the section's subject matter expert on HR-enabling systems and provides technical classes as required.
- Conducts SAVs and gives advice on HR best practices; lessons learned; and tactics, techniques, and procedures to supported APOs, MMT, casualty liaison teams (CLT), and PA elements.
- Coordinates and reviews monthly Performance Evaluation Boards for contractors within the ESC.
- Overall responsible for the training of enabling systems within SRC 12 HR units under the ESC.
- Establishes and maintains the HROB's SOP and continuity book.
- Provides support for Automated Military Postal System (AMPS) and DTAS account requests for all supported postal platoons, and serves as the Human Resources Command Identity Management System manager for all SRC 12 HR elements within the ESC operational area when required.
- Assists postal platoons with technical guidance involving COR duties and responsibilities.
- Assists the HR Officer with special projects as required.

1-53. Senior HR Sergeant (E-8):

- Responsible for ensuring accountability of personnel, weapons, and equipment within the HROB section.
- Manages administrative actions and data, including leader book for section.
- Assists the HR Technician with SAVs and staff inspections, including maintaining direct contact with the postal platoon and MMT chain of command.
- Assists the HR Officer or HR Technician with report and briefing preparation.
- Attends NCO meetings chaired by the SPO section Sergeant Major or ESC Command Sergeant Major as required.

- Assists with systems training or technical questions as required.
- Assists the HR Officer or HR Technician with projects as required.

1-54. Senior HR Sergeant (E-7 x 2):

- Assists in providing technical support and guidance for HR enabling systems to all HR elements in the AO.
- Assists, reviews, monitors, and recommends postal asset distribution within the AO and reviews OPORDs and FRAGORDs for HROB mission impact.
- Assists the HR Technician with conducting SAVs and staff inspections at all APOs and receives and transmits postal reports.
- Monitors and tracks mail movement throughout the AO.
- Assists the HR Officer with section historian duties; documenting lessons learned; tactics, techniques, and procedures; and maintaining the diary of events which contribute to the HROB's SOP and continuity book.
- Identifies CLT locations within the ESC operational area for inclusion in the HR annex and HR concept of support.
- Assists the HR company in establishing required communications (voice and data) links for HR company units.
- Provides technical guidance to units when developing casualty SOPs.
- Maintains and updates casualty reference sites for units on common user websites and shared servers on NIPRNET and SIPRNET.

1-55. HR Sergeant:

- Assists with technical support and HR systems guidance to all elements throughout the AO.
- Assists, maintains, and updates the section's shared folders.
- Serves as HROB Knowledge Manager responsible for maintaining and updating common user websites or shared servers on both NIPRNET and SIPRNET (for example; SharePoint, Army Knowledge Online (AKO) collaboration sites, or shared network hard drives).
- Assists with developing and maintaining a help desk website in both NIPRNET and SIPRNET shared drives and AKO and AKO-Secure.
- Assist with conducting SAVs and staff inspections at all APOs and receives and transmits postal reports.

Sustainment Brigade (SUST BDE) Level HROB

1-56. HR Support Operations Officer:

- Conducts integral interaction and communications with the HRSC Plans and Operations Officer; COD Chief; PA Division Chief, and POD Chief.
- Analyzes, projects, and recommends HR manning and capabilities required to support current and future military operations.
- Monitors execution of the HR crosswalk and resolves critical force management issues as required.
- Prepares staff summary actions, decision briefings, mitigation plans, and information papers in order to provide coordinated recommendations and situational awareness to the command.
- Monitors and provides technical oversight and input to the orders process.
- Responsible for planning, coordinating, synchronizing, monitoring, and technical oversight of casualty, PA, and postal elements in the AO.
- Responsible for planning and synchronizing issues while developing adjacent unit coordination among the ESC HROB and staff.
- Prepares or assists in preparation of the HR annex of the SUST BDE OPORD and HR concept of support, and compiles HR concept of support for the SUST BDE AO.
- Understands the MDMP and risk management process.

- Reviews, monitors, and recommends postal asset distribution within the AO and reviews OPORDs and FRAGORDs for HROB mission impact.
- Serves as the section historian responsible for documenting lessons learned; tactics, techniques, and procedures; and maintaining the diary of events which contribute to the HROB's SOP and continuity book.
- Executes and adjusts postal plan to exploit opportunities or unforecasted requirements.
- Directs actions to apply HR resources and support at decisive points and time.

1-57. HR Technician:

- Serves as the section's subject matter expert on HR-enabling systems and provides technical classes as required.
- Conducts SAVs and gives advice on HR best practices; lessons learned; and tactics, techniques, and procedures to supported APOs, MMT, CLTs, and PA elements.
- Coordinates and reviews monthly Performance Evaluation Boards for contractors within the ESC.
- Assists postal platoons with technical guidance involving COR duties and responsibilities.
- Overall responsible for the training of enabling systems within SRC 12 HR units under the SUST BDE.
- Establishes and maintains the HROB's SOP and continuity book.
- Requests AMPS and DTAS accounts for all supported postal platoons, assists with installing HR computer programs to include the Tactical Personnel System (TPS), and serves as the Human Resources Command Identity Management System manager for all SRC 12 HR elements within the SUST BDE AO.
- Assists the HR Support Operations Officer with special projects as required.

1-58. Senior HR Sergeant:

- Responsible for ensuring accountability of personnel, weapons, and equipment within the HROB section.
- Manages administrative actions and data, including leader book for section.
- Assists the HR Technician with SAVs and staff inspections, including maintaining direct contact with the postal platoon and MMT chain of command.
- Attends NCO meetings chaired by the SPO section Sergeant Major or brigade Command Sergeant Major as required.
- Assists with systems training or technical questions as required.
- Assists the HR Support Operations Officer or HR Technician with report and briefing preparation.
- Assists, reviews, monitors, and recommends postal asset distribution within the AO and reviews OPORDs and FRAGORDs for HROB mission impact.
- Monitors and tracks mail movements throughout the AO.
- Assists the HR Support Operations Officer or HR Technician with special projects as required.

1-59. HR Sergeant x 2:

- Assists in providing technical support and guidance for HR enabling systems, SOPs, and requests for information to all HR elements in the AO.
- Serves as HROB Knowledge Manager responsible for maintaining and updating common user websites or shared servers on both NIPRNET and SIPRNET (for example; SharePoint, AKO collaboration sites, or shared network hard drives).
- Identifies all SRC 12 HR asset locations, equipment, and resources within the SUST BDE AO for inclusion in the HR annex and HR concept of support.
- Assists the HR company in establishing required communications (voice and data) links for HR company units.
- Maintains and updates casualty reference sites for units on common user websites and shared servers on NIPRNET and SIPRNET.
- Prepares postal reports and trends briefings as needed.
- Maintains and updates the section's shared folders.

- Develops and maintains a help desk website in both NIPRNET and SIPRNET shared drives and AKO and AKO-Secure.

EMPLOYMENT

1-60. The HROB employs as an element of either the ESC and/or SUST BDE SPO section. The HROB is part of the early entry element of the SPO, focusing on the establishment of PAT support and initial postal support. The HROB requires voice, NIPRNET, and SIPRNET connectivity to communicate with the HRSC, subordinate HR organizations, and supported organizations and laterally with other HROBs. The HROB requires access to Army Battle Command System (ABCS) in order to maintain visibility to the COP. The Battle Command Sustainment Support System, Force XXI Battle Command, Brigade and below, and other systems fielded in the deployed AO provide the COP. The HROB operates out of the SPO area of the ESC and/or SUST BDE main command post. The HROB receives technical guidance from the HRSC and higher level HROBs, while receiving sustainment and execution guidance from the SPO section and the commander.

1-61. The HROB provides technical guidance and resources to SRC 12 HR organizations (supporting units) ensuring they have the capability to provide the required casualty, PA, and postal support directed in the HR concept of support. Guided by supported and supporting relationships, the G-1/AGs and S-1s request support and resources for postal and PAT operations through the HROB. The HROB processes and prioritizes requests based on the availability of HR resources, and scope of requested support to determine supportability. If the HROB is unable to support the request with HR assets internal to its SUST BDE, the HROB forwards the request to the HROB in the ESC or the HRSC for support by other HR organizations.

1-62. The location of the HROB allows rapid coordination for required sustainment resources to execute the postal and PAT missions. HR personnel serving in the HROB of a SPO section are encouraged to complete the Support Operations Course, Postal Supervisor Course, and Postal Operations Course.

ESC/SUST BDE COMMANDERS CRITICAL INFORMATION REQUIREMENTS (CCIRs) FOR HROBs

1-63. A CCIR is an information requirement identified by the commander as being critical to facilitating timely decision making. CCIRs enable commanders to make informed decisions during planning and COA selection. During preparation and execution, CCIRs address information commanders are required to have in order to make informed decisions associated with decision points. CCIRs are not all inclusive. HR planners further develop CCIRs for operations based on operational and mission variables, along with the commander's guidance. The following recommended list is provided to facilitate the HR planner's thoughts as part of HR planning considerations, but do not supersede any CCIRs established by the unit:

- Casualty:
 - Casualty rates greater than 15% of any HRSC divisional organizations available strength.
 - Unauthorized release of casualty information.
 - Loss of Director, Deputy Director, Sergeant Major, or division staff.
 - Capture of friendly personnel.
 - Interrupted access to the Defense Casualty Information Processing System (DCIPS).
 - Loss of communication between CLTs, unit S-1s, and the theater casualty assistance center.
 - Initial casualty reports, from time of incident, greater than 12 hours, to HRC CMAOC – tracked and reported by the theater casualty assistance center.
- PA:
 - Loss of a replacement flight or convoy.
 - Delay in replacement flow of more than 24 hours.
 - Interrupted access to eMILPO, Defense Enrollment Eligibility Reporting System (DEERS) and Real-Time Automated Personnel Identification System (RAPIDS).
 - Exceeded max capacity of theater gateway transient billeting bedding space (initiated overflow plan).
 - Number of days personnel remain at the APOD/theater gateway IAW theater policies.

- Postal:
 - Loss of any mail flight or convoy.
 - Delay of mail flow.
 - Failure to update postal directory daily.
 - Accountable mail and casualty mail accounted for and redirected.
 - Received/delivered wet or damaged mail.
 - Number of postal offenses.
 - Number of days mail is static or undelivered (based on theater policy).
 - Storage capacity for mail based on combat operations (for example, offense might require a delay in mail delivery).

ESC/SUST BDE COMMANDERS KEY PERFORMANCE INDICATORS FOR HROBs

1-64. Key performance indicators are provided to facilitate an HR planner's thoughts as part of the HR planning considerations, but do not supersede any CCIRs established by the unit:

- Casualty:
 - Uninterrupted access to DCIPS.
 - Loss of communication between CLTs, unit S-1s, and the theater casualty assistance center.
 - Initial casualty reports, from time of incident, greater than 12 hours, to HRC CMAOC – tracked and reported by the theater casualty assistance center.
- PA:
 - Number of days personnel remain at the APOD/theater gateway IAW theater policies.
 - Visibility of inbound and outbound transportation.
 - TPS and DTAS operational and updated daily.
 - Access to systems (uninterrupted).
- Postal:
 - Number of days mail is static or undelivered.
 - Registered, accountable, and casualty mail not accounted for and redirected.
 - Storage capacity for mail based on combat operations (for example, offense might require a delay in mail delivery and exceed capacity).

HR OPERATIONS AT THEATER-LEVEL

1-65. As previously discussed, HR units, companies, or teams attach to sustainment organizations for mission command. While it remains the sustainment commander's decision for HR unit attachments, they are normally attached to the SUST BDE STB or CSSB. S-1s/G-1s should not supervise HROBs as these HR organizations perform separate mission sets.

1-66. Military operations generally support military, Civilian, joint, and multi-national organizations; however, Table of Organization and Equipment units are built based on Army specific missions. If HR units are supporting more than Army organizations and personnel, the number of HR organizations may need to expand to support the additional forces. For example, an element of the HRSC or HR company may be required to establish a casualty section or CLT at joint force command HQs. However, no additional HR forces or personnel provide support to this mission. It is critical for HR planners at the HRSC and within the HROB to be aware of all HR support requirements and the ROA in order to resource additional teams or personnel.

1-67. Successful HR operations require HR leader participation during all phases of military operations. This includes deployment planning, participating in early entry operations, and through the end of redeployment. Lessons learned have validated the need for some HR functions to be available immediately when the first troops have boots on the ground. These functions include casualty and PA operations. As with all military operations, success is dependent on the careful planning, coordination, and synchronization required prior to, during, and after military action.

HR ORGANIZATIONAL STRUCTURES

1-68. HR organizational structures have varying relationships within the deployed theater as they provide HR support.

THEATER GATEWAY PERSONNEL ACCOUNTABILITY TEAM (TG PAT)

1-69. The TG PAT provides PA support to theater of operations by coordinating and providing PA operations and database inputs as Soldiers enter, transit, and depart theater at the inter-theater APOD, and executes tasks supporting the PA function. The TG PAT establishes a theater-level TG PAT center with augmentation of an HR company at the primary inter-theater APOD. The team establishes in and out flow processes and procedures for all personnel (for example; R&R, emergency leaves, temporary duty, and deployers/redeployers), and establishes accountability reporting procedures and specified reports through the supported chain of command. Figure 1-8 provides the organizational design for the TG PAT.

1-70. The TG PAT coordinates for operational work space at terminals, ensuring access to relevant flight tracking systems such as the Global Air Transportation Execution System, Single Mobility System, and Transportation Coordinators Automated Information for Movements System II. The team also coordinates logistics support requirements for onward movement of personnel, including but not limited to billeting and transportation.

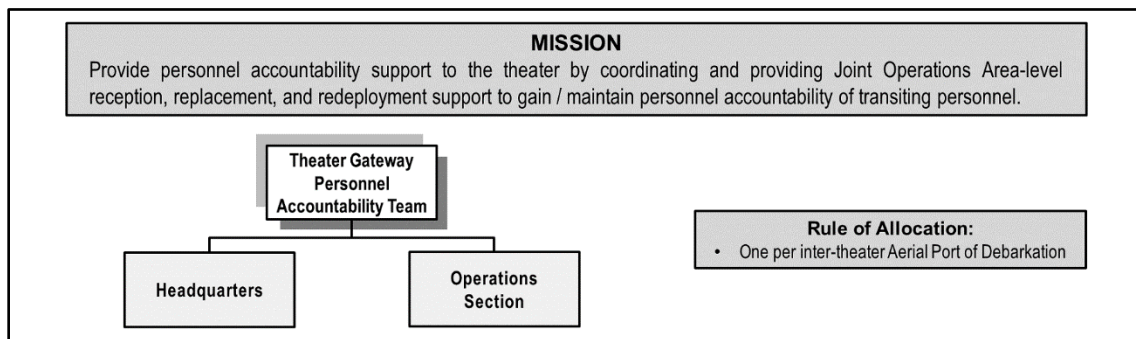

Figure 1-8. Theater gateway personnel accountability team (TG PAT)

MILITARY MAIL TERMINAL (MMT) TEAM

1-71. The MMT team provides postal support to an AO by coordinating, receiving, and processing incoming mail, and dispatching mail to CONUS. The team establishes and runs the Army component of a joint military mail terminal (JMMT) with the manpower support of an HR company at the APOD. The MMT team provides specialized postal expertise and experience to process incoming mail and dispatch mail to CONUS at the APOD. The MMT may serve as the COR when postal operations are contracted. Figure 1-9, found on page 1-20, provides the organizational design for the MMT team.

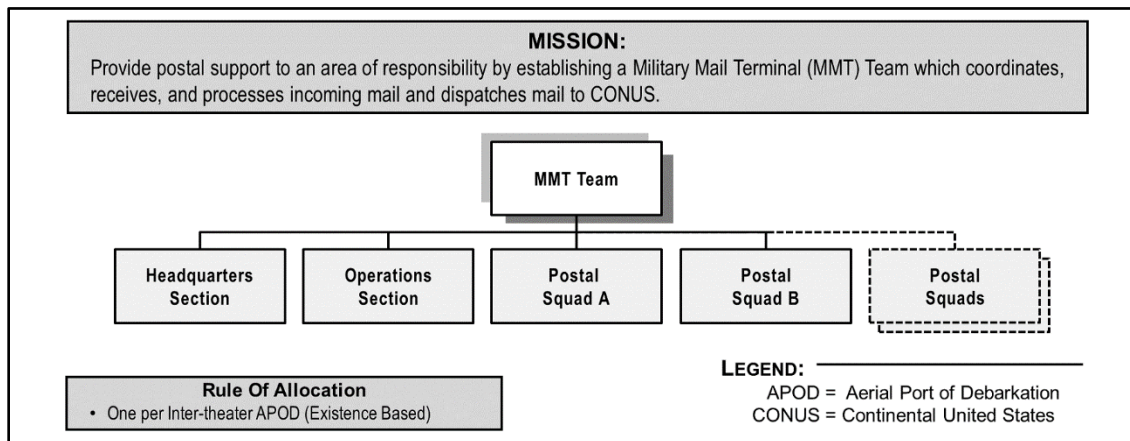

Figure 1-9. Military mail terminal (MMT) team

HR COMPANY HQS

1-72. The HR company HQs provides mission command, planning, and technical support to all assigned or attached HR and postal platoons. It is both an existence and workload-based modular HQs. The HR company delivers HR area support for casualty, PA, and postal operations in the deployed AO. The HR company is tailored for a CLT, PAT, postal, and/or combined mission by task-organizing the company HQs with specialized casualty, PA, or postal operation teams. All platoons should cross-train to enable the HR company to be prepared to accomplish any mission. Figure 1-10, found on page 1-22, provides the organizational design for the HR company.

1-73. The Command Section exercises mission command over assigned HR platoons based on restricted operations areas and operational and mission variables. This section administers discipline and Uniform Code of Military Justice, and assumes operational control over attached and co-located HR elements. It coordinates external support functions such as life support, personnel protection, logistics, and transportation. Responsibilities include, but are not limited to the following:

- Ensures local HQs security.
- Arranges for the HQs, unit training, and morale, welfare, and recreation activities.
- Identifies all early returning Soldiers to the rear detachment commander and provides contact information.

1-74. The Plans and Operations section provides policy review and direction for HR operations, coordinates the consolidation of critical wartime function reports for the commander, and advises and coordinates with higher, lateral, and subordinate organizations on personnel matters. This section provides long and short range planning and guidance during the execution of current operations and coordinates with the HR commander, the SUST BDE, and ESC HROBs for all related operations. This section also prepares OPLANs and OPORDs, exercises control, and provides guidance regarding casualty operations. Responsibilities include, but are not limited to the following:

- Casualty Operations:
 - Oversees placement of CLTs at the medical treatment facility (MTF), G-1/AG, General Officer HQs, and HRSC.
 - Identifies and tracks manning requirements.
 - Monitors number of casualties within the last 24 hours (formatted report).
 - Verifies CLT communications in coordination with G-6 and S-6.
 - Provides system access to NIPRNET and SIPRNET.
 - Utilizes current version of DCIPS.
 - Tracks last visit (by leadership) and inspection.
 - Monitors latest arrival date and boots on ground tracking.

- Reports units within 90 days of latest arrival date.
- Identifies high risk Soldiers, and determines and coordinates rotation cycle for CLTs within the HR platoon.
- PA Operations:
 - Establishes PAT locations.
 - Monitors operational status.
 - Plans, coordinates, and executes passenger movement.
 - Tracks previous 24 hours of passenger movement.
 - Monitors backlog numbers (24, 48, and 72 hours).
 - Monitors number of days at APOD.
 - Establishes system access to include: TPS, DTAS, NIPRNET and SIPRNET.
 - Coordinates SAVs.
 - Monitors latest arrival date and boots on ground tracking.
 - Tracks units within 90 days of latest arrival date.
 - Monitors status of replacements (boots on ground).
 - Identifies accountability issues for military, Civilian, contractors authorized to accompany the force (CAAF), and joint (or other services).
 - Verifies departure locations (intra-theater APODs).
 - Identifies population served.
 - Monitors unit redeployment schedule.
 - Tracks and monitors billeting and feeding.
 - Coordinates for transportation.
 - Assists with DEERS RAPIDS readiness (common access cards (CACs)).
 - Ensures there is adequate band-width to support.
 - Monitors Very Small Aperture Terminal usage.
 - Monitors system usage, connectivity, and updates.
 - Monitors system training (Site Security Manager and Verifying Official).
 - Maintains visibility of floats and theater requirements.
 - Tracks CAC stock threshold.
 - Provides military, Civilian, and CAAF support.
 - Tracks HR related contracts to include contract renewal and surge periods.
- Postal Operations:
 - Identifies postal unit locations and forward operating base (FOB) locations.
 - Provides current operational status.
 - Conducts SAVs.
 - Monitors population serviced (for example, area population).
 - Monitors mail volume (for example, 20' military van = approximately 8,000 pounds of mail).
 - Monitors delivery delays.
 - Monitors transportation and storage issues.
 - Establishes and closes APOs in coordination with the HROB and HRSC, with the approval of MPSA.
 - Coordinates postal plans with the HROB.
 - Reconciles postal issues.
 - Tracks and monitors APO reports (for example, status and submission).
 - Plans for and monitors execution of postal support to authorized contractors.
 - Monitors postal related contracts to include COR support.

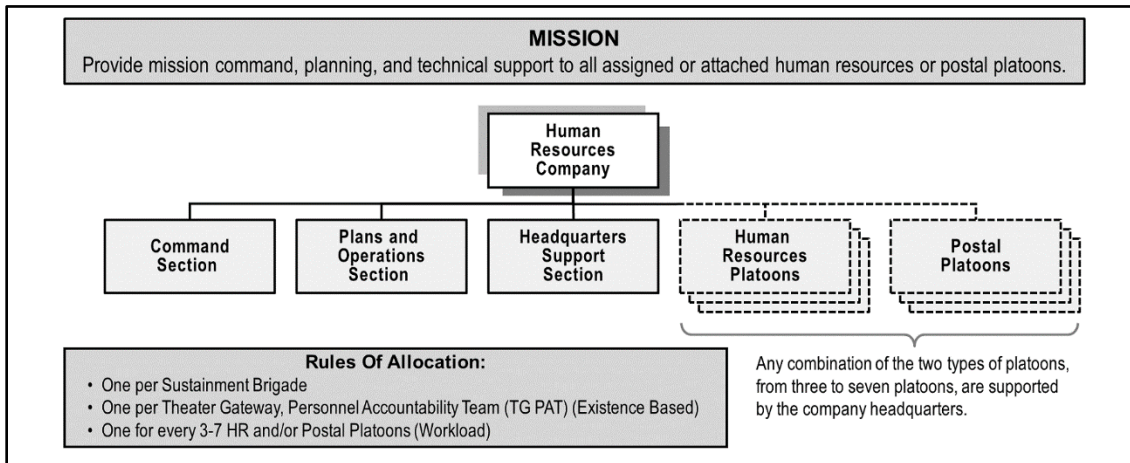

Figure 1-10. HR company

HR PLATOON

1-75. The HR platoon is a multifunctional platoon consisting of three HR squads. Each squad has the capability to perform either CLT or PAT missions. Figure 1-11 provides the organizational design for the HR platoon.

1-76. The HR platoon has the capability to form CLTs or PATs, depending on mission requirements. This capability increases the mission flexibility and its ability to support theater casualty operations or PA mission. The HR platoon has a 3-person leadership team and three squads. Each squad can perform either a casualty or PA mission (one squad equals one CLT or one PAT). The platoon provides the mission command, leadership, technical guidance, and other support required for each squad. Depending on its mission, squads can be co-located or located at multiple FOBs. For example, if supporting the TG PAT, the entire platoon is located at the personnel processing point. If needed, one squad may be located at an intra-theater transportation point and at FOBs if daily flow rates are greater than 600 per day.

1-77. Each platoon requires the capability to communicate (voice and data) with each squad, the HR company, the HROB, TG PAT, supported G-1/AGs and S-1s, HRSC, and logistics support element (for example, movement control team (MCT)).

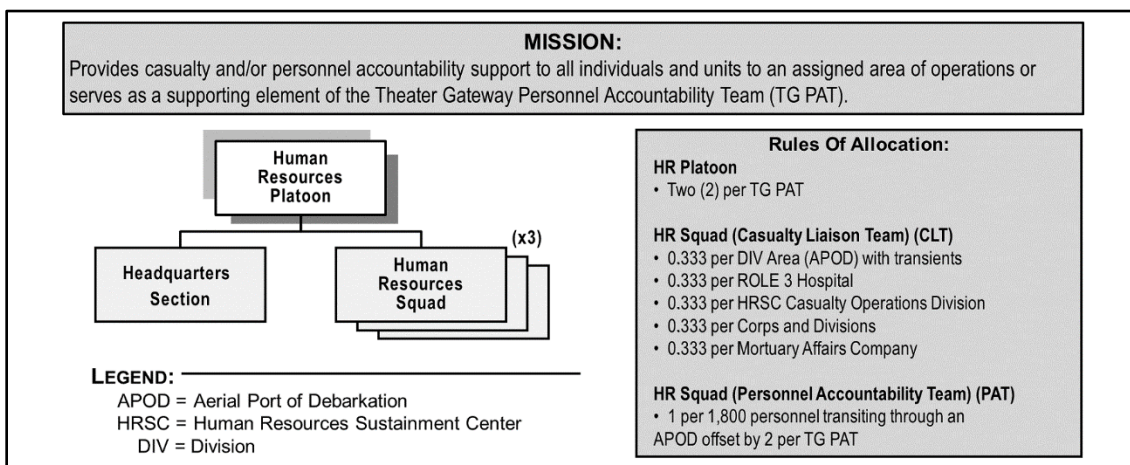

Figure 1-11. HR platoon

POSTAL PLATOON

1-78. The postal platoon provides all postal support to all authorized individuals and units in an assigned AO or to serve as an element of an MMT. Postal platoons operate in conjunction with the Plans and Operations section within the HR company. Figure 1-12 provides the organizational design for the postal platoon.

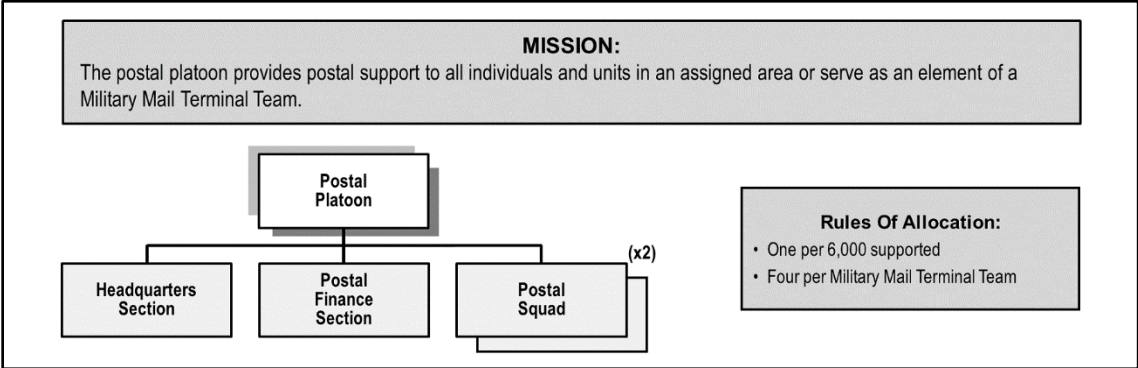

Figure 1-12. Postal platoon

This page intentionally left blank.

Chapter 2

Casualty Operations

Early planning and continued assessment is essential to efficient and successful casualty operations. When casualties occur, information must reach the right people as quickly as possible with 100% accurate and verified information. Casualty reporting has a zero defect tolerance and procedural mistakes must not be allowed to occur as they could potentially lead to improper notification or false information being publicly released. Although next of kin (NOK) notification is a CMAOC and casualty assistance center responsibility, commanders, their designated casualty representatives, and unit Soldiers must train on the casualty reporting and notification process.

PRINCIPLES OF CASUALTY OPERATIONS

2-1. Casualty operations record, verify, report, and process casualty information from unit-level to DA, notify appropriate individuals, and provide casualty assistance to the NOK. A clear, collaborative system for casualty operations information is critical for effective management. When developing theater casualty operations policies and procedures, casualty managers must not only consider doctrinal guidance, but also decisions and agreements made by the JTF/combatant commander allowing subordinate commanders (corps-level) to approve and release casualty reports directly to the CMAOC.

2-2. Casualty operations include all actions relating to the production, dissemination, coordination, validation, and synchronization of casualty reporting. It includes submission of casualty reports, notification of NOK, briefing and assistance to the NOK, LOD determinations, disposition of remains and personal effects (a responsibility of the MA organization of the supporting sustainment command), military burial honors, and casualty mail coordination. The role of the casualty assistance center varies during contingency operations. The theater casualty assistance center is more involved in casualty reporting functions, and installation casualty assistance centers are engaged in the notification and assistance aspect of casualty operations as prescribed in AR 638-8, *Army Casualty Program*. The following paragraphs describe critical responsibilities in a contingency operation.

2-3. Casualty Reporting - Units report all casualties as they occur. Accurate and timely casualty reporting is paramount. Contingency related casualty reports are forwarded to the appropriate theater casualty assistance center where all information is verified and sent to the CMAOC within 12 hours from the time of the incident. The CMAOC is the functional proponent for Army-wide casualty operations, interface and synchronization of all casualty and MA operations between deployed units and commands, the installation casualty assistance centers, and DOD agencies supporting Family members.

2-4. Casualty Notification - Casualty assistance centers are responsible for notifying the NOK residing within their areas of responsibility. The method of notification varies, depending upon the type of casualty and circumstances surrounding the incident. CMAOC must approve any exception to the established notification procedures outlined in AR 638-8.

2-5. Casualty Assistance - Provided to those receiving benefits and/or entitlements in cases of death, missing, or categorized as duty status whereabouts unknown (DUSTWUN)/excused absence whereabouts unknown (EAWUN). Installation casualty assistance centers are responsible for providing assistance to the NOK residing within their areas of responsibility. There is no time limitation for casualty assistance officers (CAOs) to provide assistance; however, during contingency operations, the duties of the CAO may last 6-months or more.

2-6. An Army Fatal Incident Family Brief is the presentation of the facts and findings of a collateral investigation of all operational and training deaths, friendly fire, and suicide incidents. The intent of the brief

is to provide a thorough explanation of releasable investigative results to the primary NOK and other Family members (as designated by the primary NOK) in a timely, equitable, and professional manner. Additional information is available in AR 15-6, *Procedures for Administrative Investigations and Boards of Officers*, and AR 638-34, *Army Fatal Incident Family Brief Program*.

2-7. The CLT consists of HR personnel attached to Role 3 hospitals, theater MA activities, and G-1/AG sections with the mission to obtain, verify, update, and disseminate casualty information to the appropriate personnel or organization in the casualty reporting chain. The CLTs begin coordination with patient administration offices to handle those casualties evacuated to military or Civilian hospitals within their AO. Mass casualty incidents or transfer of injured personnel may require treatment at hospitals outside theater. The CLTs are essential for providing updated information on all incapacitated, injured, and ill personnel through the theater casualty assistance center to CMAOC. CMAOC then notifies the installation casualty assistance center, who in turn provides updated information to the Family. CLTs also provide updated information as personnel transit through MTFs.

2-8. The Office of the Surgeon General is responsible for identifying the MTFs within the sustaining base to treat patients in the AO through MTF sourcing and outside of the deployed AO for patients who evacuate from the deployed AO. Once identified, the theater casualty assistance center ensures the CLT network is established, positioned, and resourced to support the deployed AO for casualty reporting.

2-9. Casualty assistance centers ensure the availability, training, and preparation of military personnel to provide casualty notification and assistance to the NOK of deceased Soldiers. Casualty assistance centers ensure the availability of CAO information and instruction kits. The CMAOC has prepared numerous training tools to better prepare casualty notification and assistance personnel to effectively perform their tasks. Trained and certified casualty notification officers and CAOs are critical elements in taking care of Families.

BATTLEFIELD FLOW

2-10. Collect casualty information from all available sources on the battlefield and report through official channels as quickly as possible. Casualty managers at each echelon of command need to deploy as part of each echelon's early entry elements. In the absence of an HRSC, the senior element G-1/AG must be ready to immediately assume the role of the theater casualty assistance center. The casualty reporting mission needs to take priority and additional requirements for information from higher levels may increase the complexity of the reporting requirements. Battlefield tracking and accountability of CAAF includes providing casualty information to the theater casualty assistance center and/or the CMAOC. Figure 2-1, found on page 2-3, depicts the casualty reporting flow.

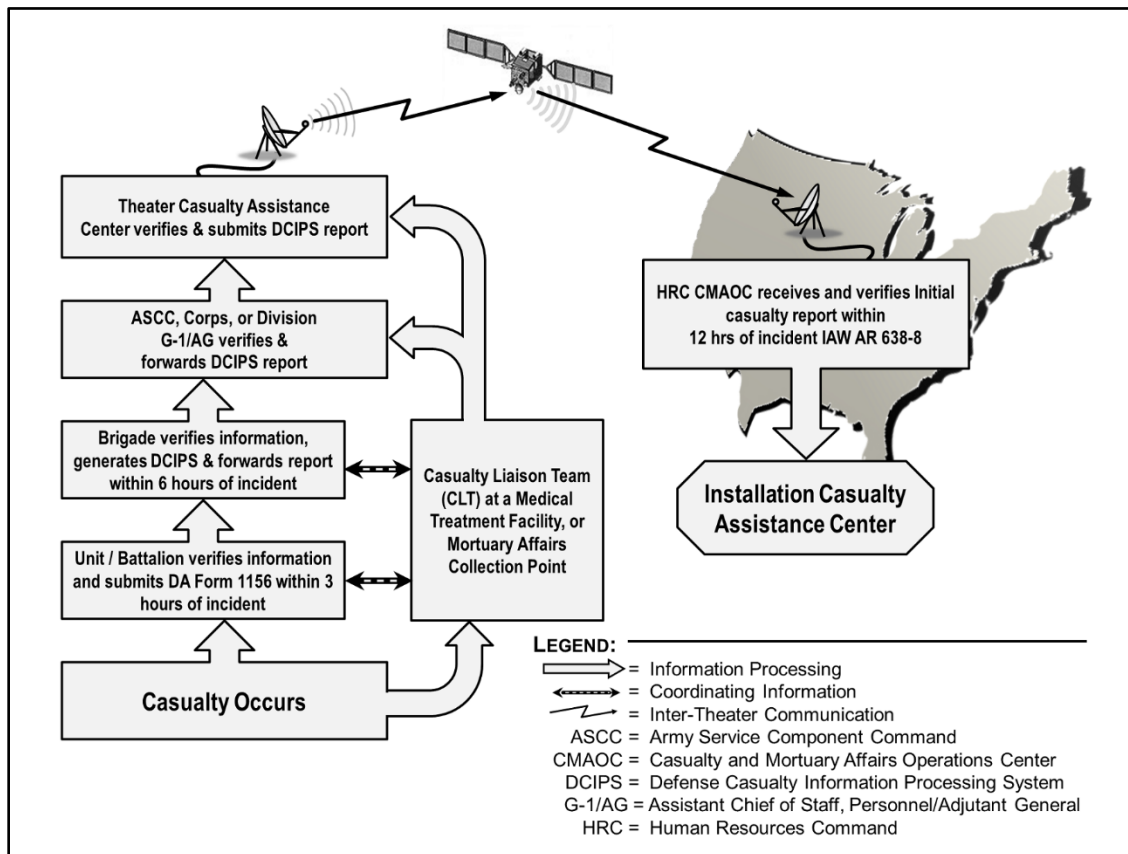

Figure 2-1. The casualty reporting flow

2-11. The DA Form 1156 (Casualty Feeder Card), is used to submit an initial report when a casualty incident is observed. The DA Form 1156 is used to document critical information which is forwarded to the battalion S-1 section for submission to the brigade S-1 section. The brigade S-1 section prepares the initial casualty report using Defense Casualty Information Processing System-Casualty Forward (DCIPS-CF) and forwards the report through the chain of command IAW Figure 2-1 for further submission to CMAOC. (Note: Based on guidance from the JTF, joint forces land component command, or coalition forces land component command, the Army/ASCC G-1/AG may delegate authority for corps-level commanders to release casualty reports directly to CMAOC with a copy provided to the theater casualty assistance center). Due to the personal nature of information within casualty reports, the theater casualty assistance center reports casualty information to the CMAOC using DCIPS as the official means of casualty reporting.

2-12. Soldiers may immediately medically evacuate to an MTF where the CLT, in coordination with the Soldiers' unit, may generate the DCIPS report for submission to the theater casualty assistance center. Information includes date and time of the casualty, circumstances, and location. CLTs work directly for the COD of the HRSC operating the theater casualty assistance center and provide support to hospitals, G-1/AGs, and S-1s unless otherwise determined by the OPORD.

2-13. For injured and ill Soldiers, CMAOC contacts the supporting casualty assistance center who contacts the Soldier's rear detachment. The rear detachment makes telephonic notification for injured and ill Soldiers and then reports back to the installation casualty assistance center when notification is complete. Once notification is complete, CMAOC contacts the NOK and prepares Invitational Travel Orders to travel to the Soldier's bedside if the Soldier's doctor requests their presence.

2-14. The CMAOC contacts the supporting CONUS and/or overseas continental United States casualty assistance center to coordinate for notification of NOK (as per the DD Form 93 [Record of Emergency Data]) for deceased Soldiers.

2-15. The DA Form 1156 data fields align with DCIPS. Data fields marked by an asterisk (*) indicate minimum requirements needed to send a casualty report forward. Validate casualty information for accuracy and completeness prior to submission. A supplemental report can follow to further document and complete the report without holding up the initial report. Too many details included in the initial report can possibly lead to inaccurate information relayed to Families rather than accurate information provided later in supplemental reports. Figure 2-2 illustrates the casualty reporting and tracking flow.

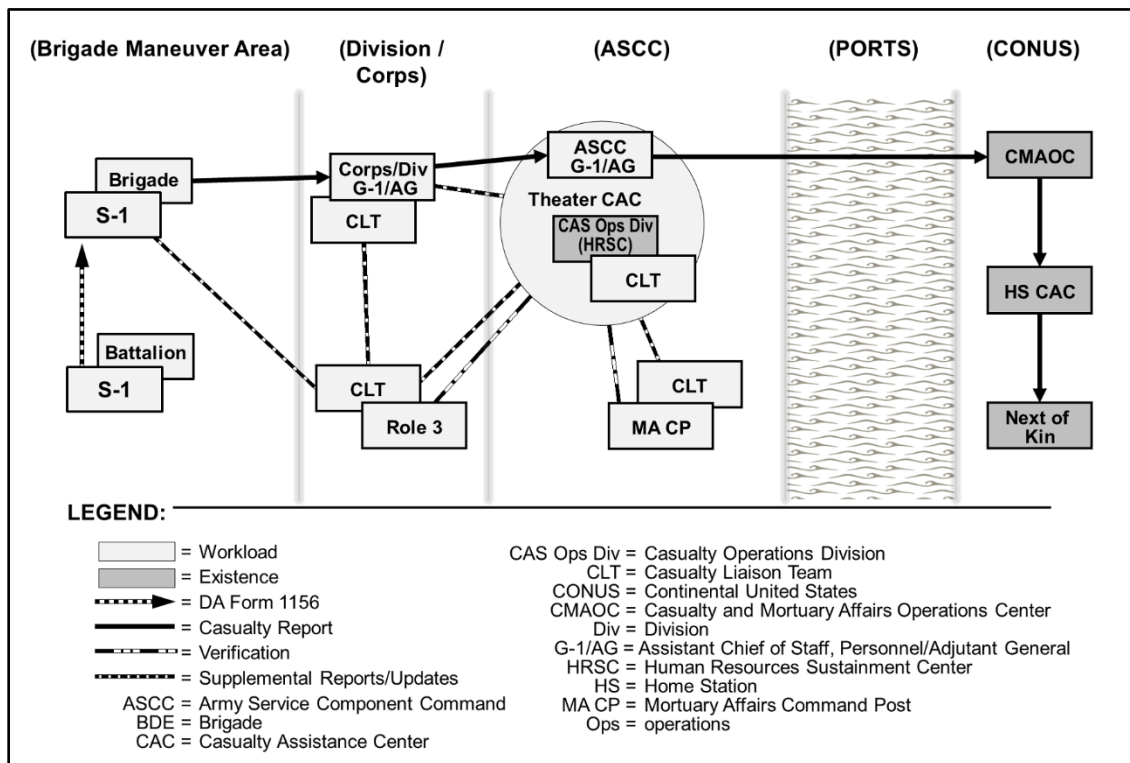

Figure 2-2. Casualty reporting and tracking flow (reporting process)

CASUALTY NOTIFICATION

2-16. Army regulation requires, when practical, all commanders contact surviving Family members within one week of a Soldier's death, telephonically, to offer condolences and relay the full circumstances surrounding the death of the Soldier. In addition, within seven days of the incident, a letter of sympathy, condolence, or concern is required to be prepared and dispatched upon confirmation of primary NOK notification.

THEATER ARMY CASUALTY RECORDS CENTER (TACREC)

2-17. When the tactical situation dictates, HRSC forms a theater Army casualty records center (TACREC). The TACREC is normally located with the theater casualty assistance center and is the focal point for casualty report processing. It serves as the casualty records repository for all records (digital and paper) within theater. The web-based casualty reporting application to the DCIPS system further enables file recall for casualty assistance centers, G-1/AGs, and S-1s, as all reports applying to a social security number can be recalled.

CASUALTY ASSISTANCE CENTERS

2-18. Casualty assistance centers operate based upon a geographic AO and are responsible for training Soldiers from all components as casualty notification officers and CAOs. During deployment, the theater casualty assistance center is primarily involved with the casualty reporting process and, if applicable, notification of the NOK in theater.

SEARCH AND RECOVERY

2-19. Commanders take appropriate action to search for and recover remains of their Soldiers and DOD and DA Civilian personnel. Process identification of remains under policies and procedures in AR 638-2, *Army Mortuary Affairs Program*, and DA Pam 638-2, *Procedures for the Army Mortuary Affairs Program*.

MISSING PERSONNEL AND PRISONERS OF WAR

2-20. Missing personnel include: beleaguered, besieged, captured, detained, interned, missing, and missing in action. For detailed guidance on handling missing Soldiers and for definitions of these terms, refer to AR 638-8 or DODI 2310.05, *Accounting for Missing Persons – Boards of Inquiry*.

Duty Status Whereabouts Unknown (DUSTWUN)/Excused Absence Whereabouts Unknown (EAWUN)

2-21. The status of DUSTWUN/EAWUN is temporary and not a missing category. Use this status when an individual is accounted or unaccounted for and when the Soldier's or Civilian's whereabouts are unknown. Pending an official determination, unaccounted for casualties are normally in a DUSTWUN/EAWUN status for a maximum of 10 days. A formal board is held to determine the duty status of a person in either status. This temporary status is also used while the command investigates the Soldier's or Civilian's disappearance. If an involuntary absence cannot be determined from the facts, the individual is reported as absent without leave as required by AR 630-10, *Absence Without Leave, Desertion, and Administration of Personnel Involved in Civilian Court Proceedings*. The theater casualty assistance center submits a supplemental report immediately as additional or corrected information becomes available.

Personnel Actions

2-22. The DOD policy states military personnel isolated from United States control is considered for promotion, pay adjustments, and other appropriate administrative actions under the purview of their Service without prejudice and on an equal footing with contemporaries IAW existing laws.

Status Changes

2-23. Upon the conclusion of a Status Determination Board, a Soldier is placed in a missing status. Only then can the Secretary of the Army or his designee, the Adjutant General, pursuant to authority delegated by the Secretary of the Army, change the status. Conduct a subsequent Status Determination Board on or about the first anniversary date of the disappearance to determine the status of the individual or when the discovery of sufficient evidence may significantly change the individual's status.

Reintegration/Repatriation

2-24. The goal of reintegration is two-fold: attend to the medical needs of the recovered personnel and gather information about the event that has an immediate impact on current and future operations. The overriding concern during reintegration is the health and welfare of the recovered personnel. These factors take precedence over all others during the reintegration process. Reintegration team personnel must often balance these factors with the need to gather pertinent information from the recovered personnel. The phases of reintegration and the activities typically occurring during each phase are detailed in FM 3-50, *Army Personnel Recovery*.

2-25. The reintegration and repatriation process consists of medical assessments and treatment (including rest and replenishment), intelligence and survival, evasion, resistance, escape debriefings, Family visitation, return to unit control, evacuation, personnel actions (a Service responsibility), and media management. Combatant commanders have the initial responsibility for the care of returnee(s), pending their delivery to appropriate Service control. Depending upon the situation, the combatant commander designates an appropriate number of centralized processing centers in close proximity to an MTF to meet the needs of the returnee(s).

2-26. Upon recovery, immediately transport returnee(s) to a secure location as quickly as possible and meet appropriate command authorities if permissible. The preferred location for the initial assessment and

debriefing is a Role 3 hospital, but may have to occur at a forward location initially. Once transported to a secure location, reintegration can begin. A leader should be present, whenever possible, for the purpose of providing moral support. These Soldiers should accompany the returnee(s) from the safe area to the transition location and/or processing center where the initial processing takes place.

Processing of Returnee(s)

2-27. Because of intelligence time sensitivity, a debriefing is essential and normally initiates at the transition location. When necessary, medical personnel coordinates optimum debriefing arrangements, consistent with appropriate medical treatment and evacuation. Afford returnee(s) all the legal rights and privileges to which they are entitled as military personnel at every stage of processing. In view of the combat and operational stress to which they may have been subjected, special care must be taken to ensure reintegration protocols are followed. See FM 3-50 for additional requirements and guidance for administrative processing of returnee(s).

ORGANIZATIONAL RESPONSIBILITIES

2-28. Commanders must ensure procedures are followed IAW established timelines for collateral investigations and presentation to the NOK. G-1/AGs, manpower and personnel directorate of a joint staff (J-1s), and Staff Judge Advocates have the primary responsibility to update CMAOC on the status of investigations and provide an unedited copy of the approved investigation.

2-29. Multiple agencies, units, and echelons of command have critical roles in establishing and operating the casualty operations system. Figure 2-3, depicts the levels of commands and their supporting agencies' responsibilities for casualty functions and tasks.

FUNCTION/TASK	S-1/G-1	S-4/G-4	Mortuary Affairs	Theater CAC	Installation CAC	HR Platoon (CLT)	Postal Platoon	CMAOC
Report Casualty	X			X		X		
Manage Casualty File	X			X	X			X
Appoint Summary Court Officer	X				X			
Disposition of Remains		X	X		X			X
Disposition of Personal Effects		X			X			X
Line of Duty Investigation	X			X	X			
Survivor Assistance					X			X
Casualty Mail	X						X	
Burial Honors					X			X
Posthumous Awards & Decorations	X							X
Letter of Sympathy/Condolence	X				X			
Fatal Training/Operational Accident Brief	X							X
Establish Casualty Working Group					X			X
Issue Next of Kin Travel Orders					X			X

Legend: HR – Human Resources; CAC – Casualty Assistance Center; CLT – Casualty Liaison Team; CMAOC – Casualty and Mortuary Affairs Operations Center

Figure 2-3. Casualty operations responsibilities

HRC, CMAOC

2-30. The CMAOC has the following responsibilities for casualty operations:

- Publishes regulatory and procedural guidance governing casualty operations, assistance and insurance management, care and disposition of remains, disposition of personal effects, and LOD programs.
- Provides direction and assistance to casualty assistance centers relating to casualty operations management, disposition of remains, and disposition of personal effects.
- Assists the HRSC in establishing connectivity for casualty reporting.
- Provides direction to mortuary liaison team(s) at the Dignified Transfer location.
- Provides coordination and transportation for Families attending the Dignified Transfer location.
- Coordinates collection of Soldier ID media.
- Synchronizes casualty operations with casualty assistance centers.
- Processes travel and transportation orders for up to three Family members of a very seriously injured/ill, seriously injured/ill, and at times, for not seriously injured/ill Soldiers.
- Receives AR 15-6 investigations for all deaths.
- Acts as final determination authority for all death-related LOD determinations.
- Establishes and operates the Joint Personal Effects Depot to support the expeditious return of personal effects during contingency operations.
- Conducts boards IAW DODI 2310.05.
- Coordinates Army Fatal Incident Family Brief to the primary NOK.
- Serves as a voting member on the Central Joint Mortuary Affairs Board.
- Serves as the DOD proponent for DCIPS.
- Provides a training package to casualty assistance centers for all casualty notification officers and CAOs.

THEATER (ASCC) G-1/AG

2-31. The Army/ASCC G-1/AG has the following responsibilities for casualty operations:

- Develops a casualty OPLAN and policies for theater.
- Provides oversight for theater casualty operations.
- Establishes and administers casualty reporting authorities for submission of casualty reports (based on guidance and agreements from the JTF, joint forces land component command, and coalition forces land component command). The authority to approve and release casualty reports directly to CMAOC may be granted to corps-level commanders. In these cases, provide a copy of the casualty report to the theater casualty assistance center.
- Establishes policy for the location of CLTs.
- Coordinates with the TSC to ensure the HRSC establishes the theater casualty assistance center as part of theater opening operations.
- Advises the commander on the status of casualty operations.

HRSC, CASUALTY OPERATIONS DIVISION (COD) OVERALL RESPONSIBILITIES

2-32. The HRSC, COD establishes the theater casualty assistance center and manages casualty reporting within theater of operations IAW policies established by the ASCC G-1/AG. The division has the following overall responsibilities:

- Oversees all casualty reporting in theater.
- Executes casualty OPLAN and policies developed by the Army ASCC G-1/AG.
- Serves as the point of contact for all CMAOC actions by establishing a direct link to CMAOC.
- Reports all casualties from DOD Civilians, CAAF, multi-national forces, and personnel from other Services (if the sponsoring Service is not in the immediate area), and coordinates all joint casualty requirements.

- Collects casualty reports from Brigade S-1s (through the chain of command IAW Figure 2-1 on page 2-3) and HR (Casualty) platoons and submits to HRC.
- Maintains and provides casualty data and briefings for the ASCC G-1/AG.
- Assists CMAOC through monitoring formal LOD investigations on deceased Soldiers.
- Coordinates with the assistant chief of staff, logistics (G-4) on all MA issues, including research needed to identify remains for determining the disposition of remains.
- Ensures initial casualty reports flow through the theater casualty assistance center to the HQs, Department of the Army, no later than 12 hours from incident.
- Establishes the TACREC.
- Coordinates with the HROB to ensure the CLT is established within the HR company.
- Provides technical guidance to the TG PAT and HROB.
- Assists with validating casualty mail information.
- Maintains casualty information of all theater personnel.
- Submits initial, supplemental, and status change casualty reports.
- Synchronizes casualty operations between the TSC, Army/ASCC G-1/AG, subordinate G-1/AGs, S-1s, and MA activities.
- Updates the TSC commander on the status of casualties.

COD PERSONNEL RESPONSIBILITIES

2-33. Roles and responsibilities of personnel assigned to the COD include, but are not limited to the following:

- Personnel Actions Officer:
 - Responsible for casualty operations at theater-level.
 - Establishes liaison(s) with other agencies (for example; Division G-1/AG, MA, and Provost Marshal).
 - Establishes casualty operations SOP.
 - Advises and briefs the HRSC Director, ASCC G-1/AG, and commander on casualty information.
 - Establishes the theater casualty assistance center and TACREC.
 - Monitors LOD investigations.
 - Maintains communications with the ESC and SUST BDE HROBs to assist in planning and resourcing CLTs to perform casualty operations.
 - Reviews, monitors, and recommends casualty assets distribution within the AO to the director, HROBs, and ASCC G-1/AG (current and future).
 - Assists G-1/AGs, S-1s, and CLTs in meeting training and readiness requirements for casualty reporting and operating procedures.
 - Coordinates with CMAOC and subordinate organizations on policy matters.
- HR Technician:
 - Establishes HR systems access for COD personnel.
 - Supports and provides technical guidance to the section and HR elements as required.
 - Assists G-1/AGs, S-1s, and CLTs in meeting training and readiness requirements for casualty reporting and operating procedures.
 - Monitors LOD investigations and maintains tracker.
 - Interprets regulations, military personnel messages, and all Army activity messages for individuals, subordinates, and commanders.
 - Maintains situation awareness and briefs the Personnel Actions Officer, director, and commander as required.
 - Oversees SAVs to HR elements.
 - Develops (IAW the commanding general, HRSC Director, and/or G-1/AG guidance), processes, and publishes reports as required to higher and lower echelons.

- Monitors and makes recommendations on the placement of casualty assets distribution within the AO to the Personnel Actions Officer and director (current and future).
 - Advises the Personnel Actions Officer and director on all casualty matters.
- Senior HR Sergeant:
 - Senior enlisted advisor to the Personnel Actions Officer.
 - Assists the Personnel Actions Officer in establishing casualty operations.
 - Establishes liaison(s) with other agencies (for example; Division G-1/AG, MA, and Provost Marshal).
 - Assists the Personnel Actions Officer in establishing the casualty operations SOP.
 - Advises and briefs the HRSC Director, ASCC G-1/AG, and commander on casualty information.
 - Assists in establishing the theater casualty assistance center and TACREC.
 - Monitors LOD investigations.
 - Maintains communications with the ESC and SUST BDE HROBs to assist in planning and resourcing CLTs to perform casualty operations.
 - Reviews, monitors, and recommends casualty assets distribution within the AO to the director, HROBs, and ASCC G-1/AG (current and future).
 - Assists G-1/AGs, S-1s, and CLTs in meeting training and readiness requirements for casualty reporting and operating procedures.
 - Coordinates with CMAOC and subordinate organizations on policy matters.
 - Monitors all morale, welfare and quality of life issues for the division.
- HR Technician, Team A and B:
 - Manages CLT mission support requirements and provides technical guidance and instruction to CLTs.
 - Approves every casualty report prior to forwarding to CMAOC.
 - Performs quality control review of DCIPS-CF reports using source documents.
 - Produces a consolidated daily rollup report for AO casualties.
 - Maintains the TACREC.
 - Tracks AR 15-6 and LOD investigations.
 - Ensures G-1/AGs, S-1s, and CLTs process accurate and timely casualty reports in DCIPS IAW minimum requirements of AR 638-8.
 - Reiterates and clarifies to G-1/AGs, S-1s, and CLTs maximum time requirements for casualty reporting to the theater casualty assistance center.
 - Provides updates and guidance received from CMAOC to G-1/AGs, S-1s, and CLTs via email, phone, and SAVs.
 - Organizes team(s) for continuous operations.
 - Monitors email traffic for casualty reports on NIPRNET and SIPRNET.
 - Supervises shift change briefings.
 - Ensures teams establish liaison with reporting HR elements.
 - Ensures team members update the casualty tracker.
 - Updates and briefs reports to higher as required.
- HR Sergeant, Team A and B:
 - Assists with managing the CLTs.
 - Assists with performing quality control review of DCIPS-CFs report using source documents.
 - Assists with producing a consolidated daily rollup report for AO casualties.
 - Assists with tracking AR 15-6 and LOD investigations.
 - Assists with ensuring G-1/AGs, S-1s, and CLTs process accurate and timely casualty reports in DCIPS IAW minimum requirements of AR 638-8.
 - Provides G-1/AGs, S-1s, and CLTs primary NOK notification processes and procedures.

- Identifies and provides G-1/AGs, S-1s, and CLTs with the proper procedures of DUSTWUN and EAWUN casualty reports.
- Assists with providing updates and guidance received from CMAOC to G-1/AGs, S-1s, and CLTs via email, phone, and SAVs.
- Obtains, verifies, updates, and disseminates casual information to the appropriate section.
- Assists with monitoring email traffic for casualty reports on NIPRNET and SIPRNET.
- Conducts shift change briefings.
- Establishes liaison with reporting HR elements.
- Maintains casualty tracker.
- Updates and briefs reports to higher as required.
- HR Specialist, Team A and B:
 - Operates DCIPS with the theater casualty assistance center.
 - Receives and reviews DCIPS-CF reports from CLTs and units for accuracy.
 - Creates DCIPS-Casualty Report file using DCIP-CF reports.
 - Conducts patient tracking using the Transportation Command Regulating and Command and Control Evacuation System and Transition Minimized Differential Signaling.
 - Assists with performing quality control review of DCIPS reports using source documents.
 - Assists with monitoring email traffic for casualty reports on NIPRNET and SIPRNET.
 - Updates the casualty tracker.

HUMAN RESOURCES OPERATIONS BRANCH (HROB)

2-34. The HROB monitors casualty operations within their AO, including manning and tracking the placement of CLTs, and has the following responsibilities:

- Ensures resourcing and distributing casualty elements (HR platoons and teams) are in compliance with theater policy ensuring timely and accurate reporting.
- Provides or coordinates augmentation in the event of mass casualty.
- Ensures casualty personnel are trained and capable to execute the mission.
- Maintains battle book and concept of support material.
- Maintains CLT weekly rollup excel spreadsheet.
- Maintains CLT unit tracker.
- Accesses SIPRNET to verify CLT information.
- Creates casualty operations lay down maps.
- Prepares historical summaries.
- Utilizes minimum mission essential HR enabling systems.

HR COMPANY

2-35. The HR company HQs provides mission command, planning, and technical support to all assigned or attached CLTs. It is both an existence and workload-based modular HQs. The HR company delivers HR area support for casualty operations in the deployed AO. The HR company has both long and short term capability for:

- Casualty operations.
- Current and future operations management.
- Database integration.
- Establishing CLTs.
- Leadership and oversight of two-six platoons.
- Transportation coordination.

2-36. The HR company deploys and provides mission command for HR platoons responsible for casualty operations. Requires capability to communicate by both secure and nonsecure voice and data to supported platoons, STB, CSSB, SUST BDE and ESC HROBs, supported G-1/AG and S-1 sections, HRSC, and other sustainment and joint elements.

2-37. The HR company HQs and HR platoon provide mission command as well as administrative and operational support to the CLTs. For specific organization of the HR company and platoon, refer back to Figures 1-10 and 1-11 found on page 1-22.

HR PLATOON

2-38. The HR platoon is a multifunctional platoon which consists of three HR squads. Each squad has the capability to perform either a CLT or PAT mission. This aligns mission command with the technical element and enables accurate and timely casualty information collection.

2-39. The HR platoon provides leadership, training assistance, and administrative support to CLTs. The HR platoon receives all administrative guidance through the HR company HQs and functions as part of the theater casualty assistance center or corps and division G-1/AG in a deployed environment. The HQs ensures proper resourcing for all CLTs to perform casualty reporting tasks.

CASUALTY LIAISON TEAM (CLT)

2-40. The mission of the CLT is to provide accurate and timely casualty reporting and tracking information at MTFs, MA collection points, and other locations. CLTs must deploy as members of all early entry elements to facilitate the casualty information flow of accurate and timely reporting.

2-41. The CLTs primary function is to ensure timely reporting of casualty information to the theater casualty assistance center and the unit S-1. The theater casualty assistance center verifies the information and sends it to CMAOC to coordinate notification actions through the appropriate CONUS and/or overseas CONUS casualty assistance center. CLTs supporting G-1/AGs assist commanders in maintaining accurate casualty information throughout the duration of an operation. CLTs should be cross-trained to allow for rotations in duty assignments between G-1/AGs, MTFs, and MA collection points to provide a break from the emotional nature of this duty.

2-42. CLTs serve as a liaison for each affected commander and unit. They provide updated status reports to the affected unit and inform the unit if the affected Soldier leaves theater. The CLTs assist with coordinating a Soldier's return to duty with the unit. CLTs located at an MTF review each patient's status, document newly arrived patients, and collect casualty related information for entry into DCIPS. The Joint Patient Tracking Application assists G-1/AGs and S-1s with casualty tracking and Soldier location information. The CMAOC notification section contacts the COD's CLTs to receive patient updates. The CMAOC notification section passes these updates to Family members until they and their Soldier are united. The CLT assists injured Soldiers in obtaining access to necessary services such as military pay and MWR.

This page intentionally left blank.

Chapter 3

Personnel Accountability (PA) Operations

Personnel accountability is by-name management of the location and duty status of all personnel assigned or attached to a unit. It includes tracking the movement of Soldiers, military members of other Services, DOD and DA Civilians, and CAAF as they arrive at and depart from a unit for duty.

PERSONNEL ACCOUNTABILITY

3-1. Personnel accountability is a key function of the HR core competency of man the force. The PA process is crucial to the Army's entire personnel information management system and impacts most of the HR key functions. PA is not only maintained by units, but is also maintained as personnel enter, transit, and depart theater.

3-2. The Army's PA system is designed to account for:

- Soldiers.
- Reportable DOD and DA Civilians.
- Contractors authorized to accompany the force (CAAF).
- Joint, interagency, intergovernmental, and multi-national personnel when directed (including Army Air Force Exchange Service and American Red Cross personnel).
- Eligible Family members (during noncombatant evacuation operations).

3-3. Personnel accountability includes by-name recording of specific data on arrivals and departures from units (for example, unit of assignment and location), duty status changes, or grade changes. The HRSC, TG PAT and the HR company are the center of gravity for executing PA at theater-level. The theater ASCC G-1/AG and the HROB, within the ESC and SUST BDEs, also play a key role in management of PA. Personnel within these organizations need to understand PA policies and procedures, as well as be aware of how PA affects manning the force and personnel readiness implications.

3-4. The Deployed Theater Accountability System (DTAS) is the official database of record for PA in a deployed environment for all military services assigned or attached. DTAS provides HR professionals at all levels and commanders with a tool to accurately account for and report military, DOD, DA Civilian, and CAAF personnel. While DTAS is the official database of record for PA, there are additional PA issues to consider. These include:

- Active duty personnel use eMILPO as the PA system of record.
- Army National Guard personnel use the Standard Installation/Division Personnel System as the PA system of record.
- United States Army Reserve personnel use the Regional Level Application System as the PA system of record.
- DOD and DA Civilians are accounted for on Civilian personnel management systems.
- CAAF personnel are accounted for using the Synchronized Pre-deployment and Operational Tracker (SPOT) and are included in personnel status (PERSTAT) reports.

3-5. The Army Disaster Personnel Accountability and Assessment System is the Army's official tool for reporting the status of PA subsequent to a natural or man-made catastrophic event. It is a web-based, user friendly system used to determine the status and whereabouts of Soldiers, DOD Civilians, Nonappropriated Fund employees, CAAF, and Family members. It meets the policy requirements outlined in DODI 3001.02, *Personnel Accountability in Conjunction with Natural or Manmade Disasters*, and CJCSM 3150.13C, *Joint*

Reporting Structure – Personnel Manual, which requires each Service component to provide the most expeditious accountability of designated personnel categories following a disaster.

3-6. As there are multiple systems of record, there can often be imbalances between the systems. The HR challenge lies with reconciling the numbers from all systems of record. Not an easy task, but one which must be accomplished to ensure 100% PA is maintained.

SUPPORT OF PA OPERATIONS

3-7. Supporting PA is critical to the success of PA operations. Support at the APOE/APOD and SPOD/sea port of embarkation (SPOE) provides life support to the TG PAT, HR company, HR platoons, PATs, and provides support to personnel and units who enter, transit, or depart theater. This support ranges from meeting arriving and departing flights to all phases of RSOI. The responsibility for this support is the theater opening SUST BDE or the SUST BDE providing a distribution or area support mission. This support is provided by one or more of its CSSBs and consists of the following responsibilities in support of the HR PA mission:

- Meets all incoming and departing flights or ships.
- Loads and unloads baggage.
- Transports personnel to and from aircraft or ships, to include transport to and from the Personnel Processing Center and to RSOI staging areas.
- Provides MCT to coordinate movement of personnel.
- Provides billeting and feeding of transient personnel.
- Provides storage of equipment and arms for transient personnel. (Note: Personnel departing on R&R usually arrive with weapons and equipment and need to store them while they are on R&R).
- Prepares and tracks manifests for in and outbound personnel.
- Provides or coordinates for customs support.
- Coordinates logistic support requirements with the arrival and departure airfield control group.
- Provides briefings as required.
- Provides training and equipment as directed.

CONTRACTOR ACCOUNTABILITY

3-8. One of the most challenging issues is establishing and maintaining PA for contractors. The DOD designated the SPOT as the Joint Enterprise contractor management and accountability system. The Deputy Chief of Staff for Personnel, G-1 serves as the Army staff element for the reporting of Army CAAF accounting and tracking data. Contractor personnel normally fall into two primary categories: CAAF and non-CAAF. For more information, see JP 4-10, *Operational Contract Support*; AR 715-9, *Operational Contract Support Planning and Management*; and ATP 4-10/MCRP 4-11H/NTTP 4-09.1/AFMAN 10-409-O, *Multi-service Tactics, Techniques, and Procedures for Operational Contract Support*.

3-9. The CAAF are contractor employees who are specifically authorized through their contract to accompany the force and have protected legal status IAW international conventions to include prisoner of war status if detained. The CAAF employees receive a Geneva Convention ID card or CAC, are accounted for in SPOT or its successor, and are included in PERSTAT reports. The CAAF accountability information is not entered into DTAS.

3-10. Non-CAAF personnel are employees of commercial entities not authorized CAAF status, but who are under contract with the DOD to provide a supply or service in the operational area. Non-CAAF includes day laborers, delivery personnel, and supply contract workers. Non-CAAF employees are not afforded special legal status IAW international conventions or agreements; they may not receive a Geneva Conventions ID card and are not entitled to prisoner of war treatment if captured by enemy forces. Non-CAAF employees are normally not included in PA reports.

3-11. As contractors by-name information is not maintained by HR units or within DTAS, there often is an imbalance in reporting contractor numbers submitted as part of the PERSTAT report. This imbalance not only affects accountability numbers but also impacts all sustainment support.

ORGANIZATIONAL RESPONSIBILITIES

3-12. All organizations within the HR footprint have different roles and responsibilities based on level of responsibility. HR professionals and commanders have an understanding of how HR support contributes to current and future operations and how HR professionals, organizations, and systems play an increasingly critical role in support of the total force.

ARMY G-1

3-13. The Army G-1 has the following PA responsibilities:

- Participates and ensures PA is included in the planning, deployment, sustainment, and redeployment process for current and future operations.
- Provides management oversight for PA. (Note: Execution of PA is the responsibility of SRC 12 HR units and elements).
- Deploys individuals as part of the early entry element to manage and monitor PA.
- Establishes PA policies, procedures, and reporting timelines (policy and timelines should be consistent with the JTF and combatant command). This includes all categories of personnel to include CAAF.
- Monitors DTAS and eMILPO to obtain PA information.
- Establishes connectivity with HRC, reserve component personnel offices, TSC, ESC, rear detachments (as required), appropriate joint HQs, other Services and federal agencies, and the CONUS replacement center.
- Collects, reconciles, correlates, analyzes, and presents critical PA information to the ASCC commander and personnel readiness managers.
- Conducts reassignments to meet operational requirements (coordinates with subordinate G-1/AGs, S-1s, and HRC).

HRSC, HR SYSTEMS DIVISION

3-14. The HR Systems Division is responsible for establishing and maintaining systems within theater. The division has the following responsibilities:

- Participates and ensures all systems are included in the planning, deployment, sustainment, and redeployment process for current and future HR operations.
- Continues to assess and analyze the effectiveness of systems throughout current operations.
- Coordinates with the TSC and ESC to ensure systems are established and resourced to effectively perform missions.
- Deploys adequate personnel as part of the early entry element in order to establish initial theater systems.
- Provides data support, information, and reports to the TSC and Army/ASCC G-1/AG as necessary.

HR SYSTEMS DIVISION PERSONNEL RESPONSIBILITIES

3-15. Roles and responsibilities of personnel assigned to the division include, but are not limited to the following:

- Information Services Technician:
 - Oversees the execution of all systems in theater.
 - Advises and briefs the HRSC Director, ASCC G-1/AG, and commander on systems.
 - Oversees policy and management of theater databases.
 - Determines and organizes internal support requirements for the division.
 - Provides technical guidance and support on systems management.
 - Maintains and manages the division organizational budget.
 - Prepares and attends all staff briefs for higher HQs to include coordination and tasking from higher.

- Manages security accesses to HR systems.
- Interfaces with the ASCC G-6 for information management system issues.
- Monitors NIPRNET and SIPRNET connectivity.
- Acts as the network administrator for the division.
- HR Sergeant:
 - Enlisted advisor to the Information Services Technician.
 - Assists the Information Services Technician in establishing connectivity to HR systems.
 - Assists the Information Services Technician in establishing the division operating SOP.
 - Assists with maintaining communications with the HRSC and ESC and SUST BDE HROBs to assist in planning HR systems connectivity.
- Information Technology Specialist:
 - Installs, operates, and maintains computer systems and local area networks.
 - Performs system administration and maintains computers and servers within the computing and networking environments.
 - Performs network administration; installs, configures, and maintains network equipment within the local area network.
 - Installs, operates, and maintains commercial off the shelf equipment (for example; routers, switches, and desktop and laptop computers).
 - Installs, tests, maintains, and upgrades operating systems software and hardware to comply with information assurance requirements.
- HR Sergeant, Team A and B:
 - Manages each division team.
 - Establishes communication with HR elements.
 - Updates systems reports.
- Information Technology Specialist, Team A:
 - Installs, operates, and maintains computer systems and local area networks.
 - Performs system administration and maintains computers and servers within the computing and networking environments.
 - Performs network administration; installs, configures, and maintains network equipment within the local area network.
 - Installs, operates, and maintains commercial off the shelf equipment (for example; routers, switches, and desktop and laptop computers).
 - Installs, tests, maintains, and upgrades operating systems software and hardware to comply with information assurance requirements.
- HR Specialist, Team A and B:
 - Provides updates and information on division team(s).
 - Assists with establishing communication with HR elements.
 - Maintains and updates database trackers.

HRSC, PERSONNEL ACCOUNTABILITY (PA) DIVISION

3-16. The PA Division is responsible for planning and providing technical guidance, and maintaining visibility of personnel transiting inter and intra-theater APOD/APOE. The division produces data, reports, and other information required for the analysis of strength reporting, casualty, postal, and PAT operations. Specific roles and responsibilities of the division include:

- Provides planning and coordinates support for theater-level reception and redeployment operations.
- Executes PA IAW the policies and priorities established by the theater G-1/AG.
- Uploads DTAS software to manage PA information from HR elements and supported S-1s.

- Ensures the DTAS database remains active and properly synchronized to receive data from the supporting PAT elements, G-1/AGs, and S-1 sections operating in the AO.
- Initiates and manages the DTAS hierarchy; making adjustments as the ASCC G-1/AG and G-3 updates and modifies task organization.
- Performs DTAS data quality control checks.
- Uses DTAS, eMILPO, and other HR systems to prepare, collect, and analyze required reports to maintain situational awareness of theater PA status and operations.
- Reconciles data between other HR systems.
- Provides technical guidance and training support to HR elements (TG PAT, HROB, and PATs) and supported units (G-1/AGs and S-1s) as necessary or on request.
- Ensures HR elements and supporting organizations have the appropriate access level for PA, to include NIPRNET and SIPRNET connectivity.
- Advises the theater G-1/AG of any unit who has a strength imbalance between DTAS and the unit PERSTAT. (Note: The theater ASCC G-1/AG directs units to conduct personnel asset inventories).
- Ensures all deviations from original assignments are coordinated with the HRC, TG PAT, and appropriate G-1/AGs and S-1s.
- Monitors, analyzes, and predicts projected passenger flow rates for various transit categories for deployers and redeployers in order to adequately resource and effectively position theater PA assets.
- Ensures sufficient TG PAT structures are established and resourced to effectively perform PA and data integration during the RSOI process.
- Assists the theater ASCC G-1/AG and HRC in the development of replacement plans as required and IAW Army manning guidance (part of the deliberate planning process).
- Ensures transit categories include replacement, R&R, return to duty, leave, and unit movements to and from theater.
- Assists and supports the ASCC G-1/AG in developing and executing the R&R program.
- Monitors and recommends distribution and emplacement of PATs.
- Assists the TSC commander, SPO section, and the ASCC G-1/AG with planning and operational oversight of PAT operations in the deployed AO.
- Coordinates with the HRSC, Plans and Operations Division and the TSC SPO (Mobility Branch) for deployment and redeployment plans and personnel flows and capabilities.
- Coordinates with the TSC and MCT for execution of systemic and surge transportation requirements for transiting Soldier and reportable Civilian support, both tactical and strategic lift.

3-17. Roles and responsibilities of personnel assigned to the division include, but are not limited to the following:

- Division Chief:
 - Oversees the policy, management, and execution of all PA operations in theater.
 - Coordinates with the HRSC Director on all matters as appropriate.
 - Ensures the division has the necessary strength reports to implement appropriate replacement priorities based on guidance from the theater ASCC G-1/AG and TSC.
 - Determines and organizes internal support requirements for the division.
 - Provides guidance and support to HR organizations as required.
- Personnel Officer:
 - Maintains and manages the division organizational budget.
 - Prepares and attends all staff briefs for higher HQs to include coordination and taskings from higher.
 - Consolidates divisional information updates for the Division Chief.
 - Assists the Division Chief with determining and organizing internal support requirements for the division.

- Senior HR Sergeant:
 - Senior enlisted advisor to the Division Chief.
 - Assists the Division Chief in establishing PA operations.
 - Assists the Division Chief in establishing the PA operations SOP.
 - Advises and briefs the HRSC Director, ASCC G-1/AG, and commander on PA operations.
 - Maintains communications with the HRSC and ESC and SUST BDE HROBs to assist in planning and resourcing of PA operations.
 - Assists HR organizations in meeting training and readiness requirements and operating procedures.
 - Monitors all morale, welfare, and quality of life issues for the division.
- Personnel Officer, Team A and B:
 - Prepares and attends all staff briefs for higher HQs to include coordination and taskings from higher.
 - Consolidates team information for the Division Chief and Personnel Officer.
 - Maintains and manages the team organizational budget.
 - Provides guidance and support to HR organizations as required.
- HR Technician, Team A and B:
 - Assists with overseeing the policy, management, and execution of all PA operations in theater.
 - Oversees the execution of all HR systems in theater.
 - Acts as the HR systems administrator for the division.
 - Advises and briefs the HRSC Director, ASCC G-1/AG, and commander on HR systems.
 - Determines and organizes internal support requirements for the division.
 - Provides technical guidance and support on HR systems management.
 - Establishes communication with HR elements.
- HR Sergeant, Team A and B:
 - Acts as team liaison for the division on strength reports to implement appropriate replacement priorities.
 - Assists with developing theater database policies.
 - Updates HR systems reports.
 - Provides analysis of data and reports.
 - Performs quality control review of source documents.
 - Organizes team for continuous operations.
 - Obtains, verifies, updates and disseminates database information.
 - Monitors email traffic for PA reports on the NIPRNET and SIPRNET.
 - Maintains and updates database trackers.
 - Updates and briefs reports to higher as required.
- HR Specialist, Team A and B:
 - Provides updates and information on PA team(s).
 - Assists with establishing communication with HR elements.
 - Updates PA reports.
 - Monitors email traffic for PA reports on the NIPRNET and SIPRNET.

THEATER GATEWAY PERSONNEL ACCOUNTABILITY TEAM (TG PAT)

3-18. The TG PAT is the HR organization responsible for coordinating and establishing a Personnel Processing Center at the RSOI point as units and personnel enter, transit, or depart theater of operations. The mission of the TG PAT is to conduct the PA portion of the RSOI process, load and unload personnel data from DTAS, and conduct limited essential personnel services (EPS) for transient personnel. These services

are limited to issuance of lost or stolen CACs and ID tags, changes to DD Form 93s, and updating SGLV 8286 (Servicemember's Group Life Insurance Election and Certificate) and SGLV 8286A (Family Coverage Election and Certificate), to include spousal notification letters and uploading documents into the Interactive Personnel Electronic Records Management System (iPERMS).

3-19. The TG PAT deploys as part of the theater early entry element and is augmented by elements of an HR company (operations section and HR platoons). Augmentation is dependent on the daily flow rate of personnel entering, transiting, or departing theater. At a minimum, two HR platoons and a data entry element of the HR company operations section are required to augment the TG PAT. One PAT can process up to 600 personnel per day.

3-20. The TG PAT operates under the theater opening SUST BDE. When the brigade transits to a distribution mission, the mission command of the TG PAT does not change. The TG PAT receives its operational mission via the ESC HROB and the HRSC. The HR platoon augmenting the TG PAT receives operational guidance from the HR company and HROB for which the unit is attached. At no time does the TG PAT provide mission command over the HR company and its platoons. The HROB and HR company resolve any issues which may arise.

3-21. The TG PAT responsibilities include:

- Participates in the planning, deployment, sustainment, and redeployment process for current and future HR operations.
- Coordinates site location and support with the SUST BDE HROB. This support includes a location near the APOD/SPOD with adequate facilities to conduct PA and data integration, and for the execution of non-HR related tasks such as transportation to and from aircraft, transporting personnel to the PA processing center, transportation for transiting personnel, billeting, feeding, and storage of equipment or weapons.
- Establishes a Personnel Processing Center at the APOE and SPOE. (Note: Establishment of more than one APOE and SPOE requires an additional TG PAT. The TG PAT is operational throughout the military operation).
- Establishes PA and data integration for all personnel entering, transiting, or departing a theater.
- Assists the HROB and HRSC by providing PA data information.
- Provides selected EPS (CACs, DD Form 93s, SGLV 8286 and SGLV 8286A, spousal notification, and iPERMS upload) to transiting personnel. (Note: Provides CACs to CAAF, if workload permits).
- Obtains database information from S-1s for units who transit the Personnel Processing Center.
- Provides historical data on personnel flow rates through the TG PAT.
- Obtains assignment instructions from HRSC for personnel who do not have pinpoint assignments. (Note: This should only be the exception and not the norm. Make diversions from pinpoint assignments only after coordinating with HRC, the gaining and losing unit, and the Corps or ASCC G-1/AG).
- Ensures HR company augmentation through coordination with the HROB.
- Coordinates with the HROB for customs support.
- Conducts HR operations briefing as necessary.
- Ensures military pay data is collected to initiate applicable pay entitlements.

3-22. While there is no set configuration on how to organize a Personnel Processing Center, there should be ample facilities and space to conduct PA, HR data integration, and contain a holding area, briefing area, and space for customs and the MCT. Figures 3-1 and 3-2, found on page 3-8, provide a conceptual sketch which describes the inbound and outbound flow of personnel at an APOD and APOE. Similar facilities are required as the SPOD and SPOE. The APOD and APOE normally receive Civilian wide-body contracted aircraft and larger military strategic airlift with large concentration of Soldiers and Civilians. However, tactical aircraft containing smaller concentrations of personnel arrive and depart the APOD and APOE also. Account for and enter and delete these personnel from the theater database as well. The TG-PATs need to closely coordinate with the arrival and departure airfield control group or the MCT.

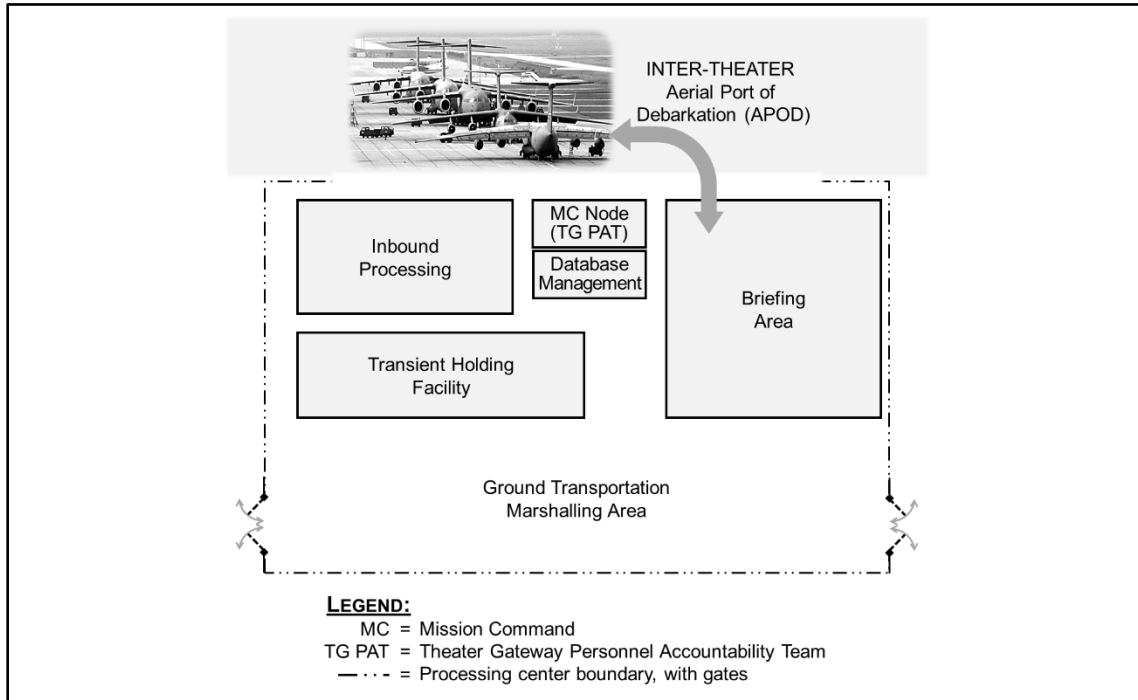

Figure 3-1. Personnel processing center conceptual sketch – inbound

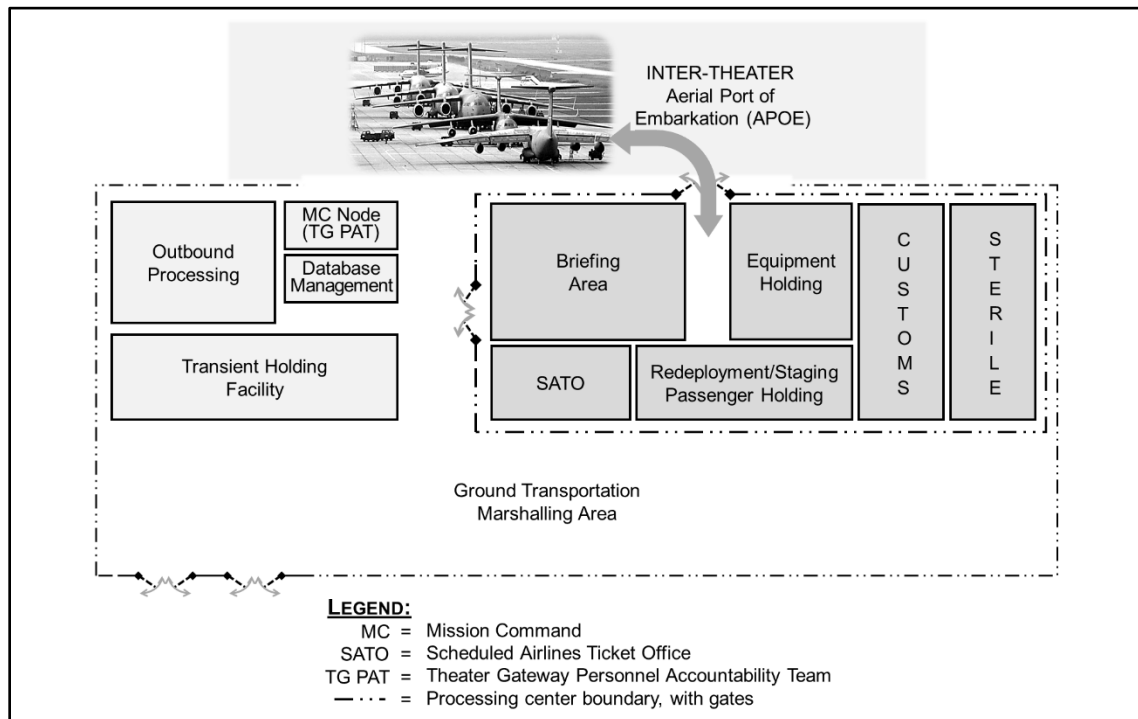

Figure 3-2. Personnel processing center conceptual sketch – outbound

3-23. It is the responsibility of the SUST BDE and its CSSB to provide logistics support at the APOD and at the RSOI site. These responsibilities include meeting aircraft, loading and unloading baggage, and the transportation, feeding, and billeting of transient personnel. It also includes storing arms and equipment when

Soldiers depart on R&R or other leaves. The TG PAT must work closely with the HROB and the CSSB to ensure the PA and logistics support efforts are properly coordinated and meet the HR and logistics missions and tasks.

3-24. The HR company operations section provides data integration and limited coordination capability with the HROB and APOD logistics personnel. The TG PAT has the organic capability to provide limited CACs to transients. Based on the ROA, each PAT can process 600 personnel per day. This is critical since, during theater opening, a large number of personnel arrive within a short period of time.

3-25. Roles and responsibilities of personnel assigned to the TG PAT include, but are not limited to the following:

- Chief:
 - Oversees the execution of all TG PAT operations.
 - Coordinates with the HRSC Director on all matters as appropriate.
 - Reviews and approves recommended internal support requirements.
 - Provides technical guidance and support to HR organizations as required.
- Deputy Chief:
 - Prepares all staff briefs for the Chief.
 - Conducts initial coordination and tasking responses for the Chief.
 - Consolidates operational information updates for the Chief.
 - Makes recommendations for future TG operations and planning considerations.
 - Maintains and manages TG PAT organizational budget.
 - Recommends and organizes internal support requirements for the TG PAT.
 - Provides technical guidance and support to HR organizations as required.
 - Responsible for day-to-day supervision of all TG PAT operations.
- HR Technician:
 - Advises the Chief on all TG PAT matters.
 - Establishes HR systems access for personnel.
 - Supports and provides technical guidance to the TG PAT and HR organizations as required.
 - Maintains situation awareness and briefs the Chief and commander as required.
 - Develops and publishes reports as required to higher and lower echelons.
 - Trains and monitors appropriate HR system utilization.
- Senior HR Sergeant:
 - Serves as the senior enlisted advisor.
 - Assists the Chief in establishing TG PAT operations.
 - Assists the Chief in establishing the TG PAT operations SOP.
 - Advises and briefs HRSC Director, ESC, SUST BDE, ASCC G-1/AG on TG PAT operations.
 - Maintains communications with the HRSC and ESC and SUST BDE HROBs to assist in planning and resourcing of operations.
 - Assists HR organizations in meeting training and readiness requirements and operating procedures.
 - Coordinates with all organizations on policy matters.
 - Monitors all morale, welfare and quality of life issues for TG PAT operations.
 - Monitors unit and enlisted personnel training.
 - Receives and orients newly assigned enlisted personnel.
 - Assists with inspecting command activities and facilities.
- HR Sergeant:
 - Assists, determines, and organizes internal support requirements for the TG PAT.
 - Provides guidance and support to HR organizations as required.
 - Assists the HR Technician in the development of TG PAT operations.

- Assists with organizing TG PAT continuous operations in theater.
- Obtains, verifies, updates, and disseminates TG PAT information.
- Assists TG PAT in establishing liaisons with all HR elements.
- Transportation Management NCO:
 - Coordinates, monitors, and provides updates on inbound and outbound movement of personnel and units using transportation systems and networks such as the Global Air Transportation Execution System, Single Mobility System, and Transportation Coordinators Automated Information for Movements System II.
 - Coordinates and monitors transportation requirements for reception and staging of inbound personnel and units.
 - Monitors transportation requirements for outbound personnel and units.
- HR Specialist:
 - Performs quality control review of source documents.
 - Obtains, verifies, and updates TG PAT database information to include DEERS RAPIDS.
 - Monitors email traffic for TG PAT database reports on the NIPRNET and SIPRNET.
 - Maintains TG PAT database trackers.
 - Maintains reports briefed to higher as required.
- Transportation Management Coordinator:
 - Assists with coordinating, monitoring, and providing updates on inbound and outbound movement of personnel and units using transportation systems and networks such as the Global Air Transportation Execution System, Single Mobility System, and Transportation Coordinators Automated Information for Movements System II.
 - Assists with coordinating and monitoring transportation requirements for reception and staging of inbound personnel and units.
 - Assists with monitoring transportation requirements for outbound personnel and units.

HROB

3-26. The HROB is an organization element within the SPO section of the ESC and SUST BDE responsible for coordination and organization integration of PA. The HROB provides technical guidance to the TG PAT and the HR company and HR platoons providing PA augmentation to the TG PAT and PATs located at intra-theater aerial ports. The ESC HROB receives its technical guidance from the HRSC, and the SUST BDE HROB receives its technical guidance from the ESC HROB. Specific PA tasks include:

- Participates in the planning, deployment, sustainment, and redeployment process for current and future PA operations.
- Ensures TG PAT personnel are included as part of the early entry element for theater opening.
- Monitors PA activities to ensure they meet the policy, guidance, and timelines from the theater G-1/AG and HRSC.
- Assists the TG PAT in obtaining adequate facilities needed to conduct PA.
- Assists in the coordination of logistics and services to support TG PAT operations. (Note: This includes support of non-HR related tasks such as transportation to and from aircraft, transporting personnel to the PA processing center, transportation for transiting personnel, billeting, feeding, and storage of equipment or arms).
- Ensures HR company and/or HR platoon augmentation to the TG PAT is adequate.
- Monitors the establishment and operations of PATs at forward locations.
- Monitors the number of personnel processing through the TG PAT and at PAT locations.
- Provides and coordinates PA training for PA activities.
- Receives, resolves, and forwards PA issues received from supported units (G-1/AGs and S-1s).
- Coordinates customs support for TG PAT.
- Provides PA advice and guidance as needed.
- Maintains voice and data communications with the HRSC, HROB, and supporting HR company.

HR COMPANY

3-27. The HR company HQs provides mission command as well as administrative and operational support to the TG PAT and forward operating PATs. At the APOD, the operations section provides data integration support and the HR platoons form PATs from their squads. The TG PAT does not have mission command of HR organizations providing augmentation support. Mission command remains with the appropriate STB or CSSB within the SUST BDE. For specific organization of the HR company, refer back to Figure 1-10 found on pages 1-22. Specific responsibilities include:

- Maintains mission command of assigned HR platoons and teams.
- Provides data integration support for all personnel transiting the TG PAT or at intra-theater processing point where a PAT is located.
- Manages and plans PA support for current and future PA operations.
- Provides vital EPS (CACs, DD Form 93s, SGLV 8286 and SGLV 8286A, spousal notification, and iPERMS upload) to transient personnel.
- Conducts passenger tracking and accountability.
- Coordinates with the HROB for the execution of non-HR tasks (for example; billeting, feeding, onward movement, and transportation).
- Coordinates with the HROB for PA support issues.
- Provides PA support as directed by the HROB for theater opening and theater distribution.
- Maintains voice and data communications with HROB and subordinate platoons and teams.
- Forms PATs as required to support PA at required locations.
- Maintains and manages TG PAT organizational budget.

HR PLATOON

3-28. The HR platoon is a multifunctional platoon with the capability to form PA teams or CLTs, depending on mission requirements. This capability increases the mission flexibility and its ability to support theater PA or casualty operations mission, as depicted in Figure 1-11, found on page 1-22,. The HR platoon has a three-person leadership team and three squads. Each squad can perform either a PA or casualty mission (one squad equals one PAT or one CLT). The platoon provides the mission command, leadership, technical guidance, and other support required for each squad. Depending on its mission, squads can be co-located or located at multiple FOBs. For example, if supporting the TG PAT, the entire platoon is located at the Personnel Processing Center. If needed, one squad may be located at an intra-theater transportation point and at FOBs where the daily flow rate is greater than 600 per day. Each platoon requires the capability to communicate (voice and data) with each squad, the HR company, the HROB, TG PAT, supported G-1/AGs and S-1s, HRSC, and other supporting elements (for example, the MCT).

PERSONNEL ACCOUNTABILITY TEAM (PAT)

3-29. Personnel accountability teams form from squads of an HR platoon. One squad equates to one PAT, and each PAT has the capability to capture PA data on personnel entering, transiting, or departing the APOD or from an intra-theater APOD. Each PAT has the capability to process up to 600 personnel per day. An example is an APOD processing 1,300 per day, which requires three PATs. Figure 3-3, found on page 3-12, depicts a conceptual sketch of a PAT located at an intra-theater APOE and APOD.

3-30. Each PAT relies on the HR company/platoon or supporting organization for daily life support. Additionally, each PAT requires database access and the capability to transmit data on a daily basis. Specific responsibilities for a PAT include:

- Maintains 100% PA of all personnel arriving, transiting, or departing the theater or intra-theater APOD/SPOD and APOE/SPOE. Information should be consistent with the flight manifest and with information provided by the MCT.
- Enters PA information into the theater database.
- Updates (by exception) DD Form 93s, SGLV 8286 and SGLV 8286A, spousal notification, and completes iPERMS upload.

- Assists in the issuances of CACs (if co-located with TG PAT).
- Provides briefings to incoming or outgoing personnel.
- Collects deployment entitlement start data and provides to financial management personnel.
- Coordinates with the MCT and CSSB for the execution of non-HR tasks.
- Coordinates PA or support issues with the HR platoon and/or HR company.
- Coordinates with supporting G-1/AGs and S-1s as appropriate.

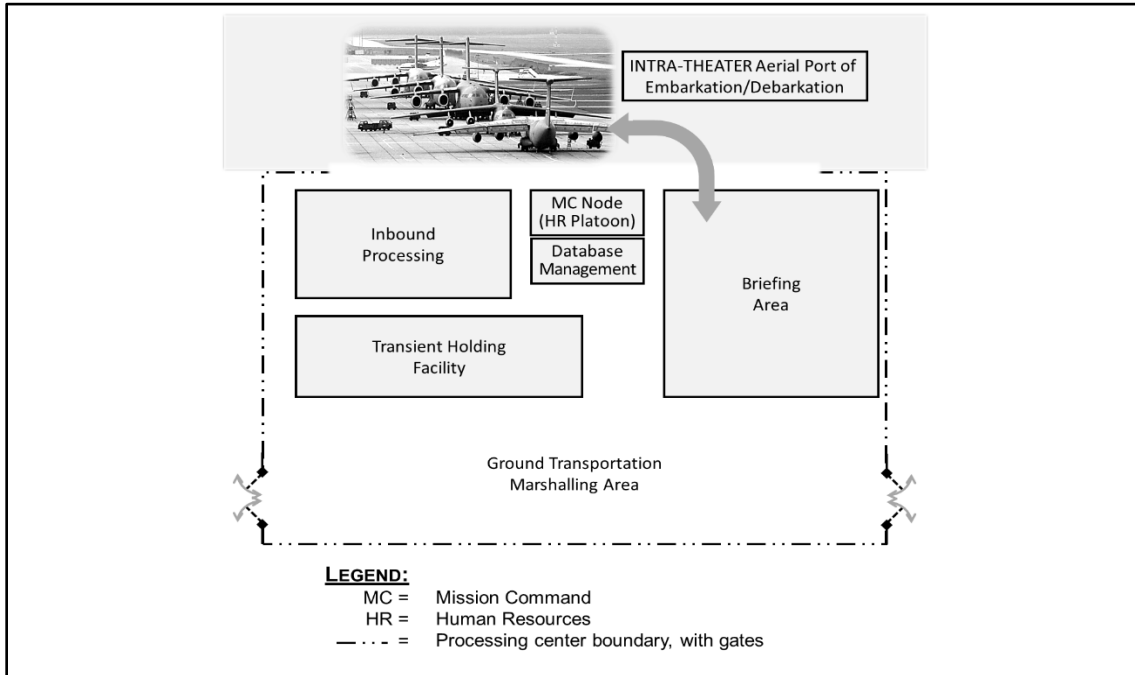

Figure 3-3. Conceptual sketch of a PAT processing point

Chapter 4

Postal Operations

Postal operations and services have a significant effect on Soldier and Family morale. It requires significant logistics and sustainment planning for issues such as dedicated air and/or ground transportation, contracted support, early deployment of postal forces, robust palletization crews, facilities and specialized postal and container equipment. The military postal service (MPS) provides postal services to the active duty and Civilian components of the Armed Forces deployed or stationed overseas and are regulated by both law and DOD directives.

MILITARY POSTAL SERVICE MISSION

4-1. The mission of the MPS is to operate as an extension of the United States postal service (USPS). Postal services are provided to Soldiers, personnel from other military Services, DOD and DA Civilians, and some CAAF when USPS access is not available. Postal operations consist of a network of military organizations from the HR provider level down to the unit mail clerk. Efficient and effective postal operations require dedicated postal organizations with trained postal clerks and HR leaders who are knowledgeable of postal operations laws, regulations, and procedures needed in the execution of providing mail and postal services to deployed units and personnel. There are two categories of postal operations: processing mail and providing postal services.

4-2. Processing mail involves the following functions and tasks:

- Receiving, separating, sorting, dispatching, and redirecting ordinary and accountable mail.
- Completing international mail exchange.
- Handling casualty and EPW mail.
- Visually screening for contaminated or suspicious mail.
- Providing directory services.

4-3. Postal services involve the functions and tasks of:

- Selling postage.
- Cashing and selling money orders.
- Providing registered (including classified up to secret), insured, and certified mail services.
- Assisting with processing postal claims and inquiries.

4-4. As there are limited military and Civilian airlift available during theater opening, postal operations for units and Soldiers do not usually start to flow or be available within the first 30 days of military operations. However, planning and coordinating for postal operations needs to be accomplished early as part of the OPLAN and OPORD process.

4-5. Postal operations should be included in all OPORDs. Information contained in the OPORD should describe all information to support efficient postal operations or require significant logistics and planning for issues such as air and ground transportation; specialized equipment; secured facilities; palletization crews; mail handlers; pickup and drop off times; hours of operations; special requirements for selling stamps; cashing and selling money orders; providing registered (including classified up to secret), insured, and certified mail services; processing postal claims and inquiries; and other issues which impact mail operations (for example, holidays and voting). For planning purposes, use a planning factor of 2.0 pounds of mail (per day, per Soldier) to calculate transportation requirements and is the driver for personnel resources. Additionally, anticipate and prepare for adverse weather conditions affecting postal operations (for example; delayed transportation, increased backlog, and possible weather damage).

4-6. Establish a plan during the late summer months to manage the increased volume of holiday mail from approximately mid-November through mid-January. The plan should include increased mail storage locations, increased mail handlers, and increased transportation during this timeframe.

MAIL FLOW

4-7. Mail addressed to Soldiers transports via USPS to the nearest United States gateway where it enters the MPS. The MMT, augmented by the HR company and postal platoons, receives the mail and sorts it by APO number for transportation to the local servicing APO. The planning, coordination, and availability of transportation assets is critical in this effort.

4-8. The APO processes the mail and validates the Soldier's location by using the Theater Unit Locator List to further sort by unit or task organization for pickup by the battalion S-1 mail clerks. Analysis of operational and mission variables, theater constraints, and resources determine mail distribution, and may require centralization for distribution. To determine the unit's physical location within theater, close coordination with the HRSC, servicing APO, and HROB is required for providing updated geographic unit locations. Properly maintain the Soldier's status within accountability systems for correct mail delivery. Mail for Soldiers who are not serviced by that unit mail room or APO are directorized. Figure 4-1 depicts the postal flow from CONUS to unit.

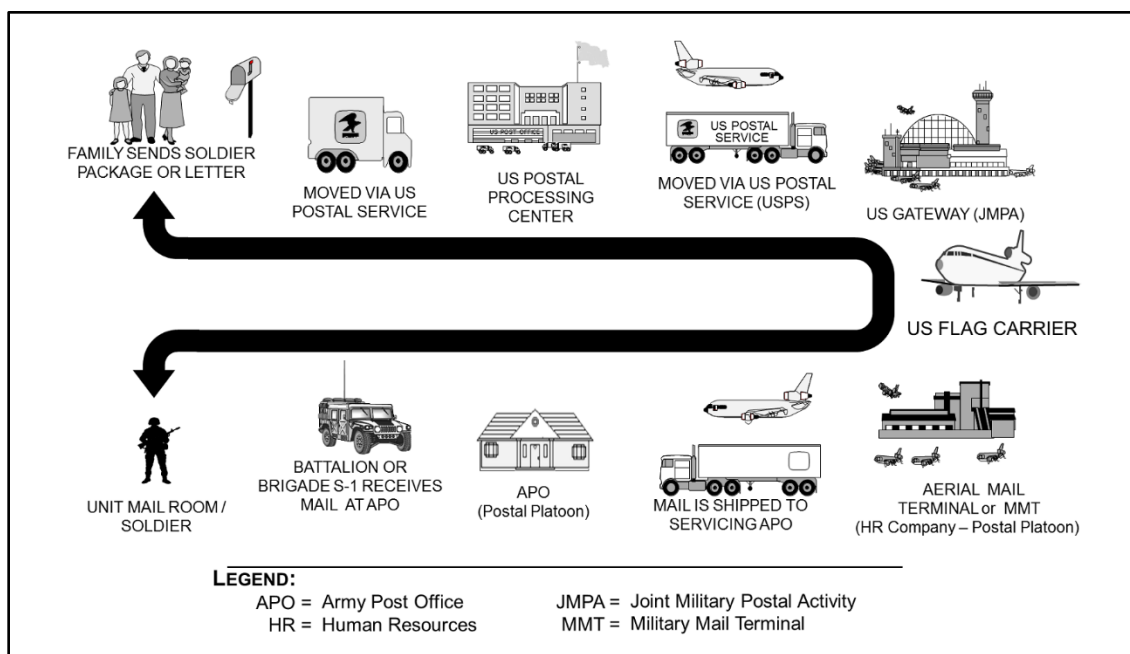

Figure 4-1. Mail flow

4-9. Postal operations require detailed planning and extensive coordinating prior to the actual arrival of mail. Some coordination can be accomplished prior to deployment, but often extensive coordination is required during theater opening. To support the establishment of postal operations, it is critical selected members of the MMT, HROB, and HRSC deploy as part of the theater opening element. Functions of the MMT theater opening element include:

- Assessing adequacy of postal facilities in order to establish an MMT. Facilities must have sufficient space to sort and stage mail, as well as meet the basic facility design requirements identified in the DOD 4525.6-M, *Department of Defense Postal Manual* and AR 600-8-3, *Postal Operations*.
- Establishing, verifying, and coordinating mail routing schemes.
- Coordinating the activation of contingency MPOs.
- Identifying, appointing, and properly placing postal inspectors.

- Coordinating with task organization points of contact for mail movement with commercial carriers and Air Mobility Command.
- Establishing initial postal directory and casualty mail operations.
- Assisting the ASCC G-1/AG and HRSC in establishing theater postal policies adhering to joint postal policies. (Note: The ASCC G-1/AG establish policies, and the HRSC and MMT execute them).
- Coordinating MPSA, JMPA, and DA postal requirements with the HRSC.
- Assisting the ASCC G-1/AG, HRSC, HROB, and ESC in ensuring postal operations are included as part of all OPORDs.

4-10. Postal communication requirements are voice and data connectivity. Postal elements must be capable of communicating and interfacing with USPS equipment (analog and commercial) and must be able to transmit and scan daily to AMPS. The AMPS facilitates work within the MPS and centralizes data into a single database which is universally accessed through the Internet. Determined by a user role and corresponding set of privileges, military mail transportation, finance, and MPO records and forms are immediately available to AMPS users regardless of location. Essential mail transportation forms and financial documents (for example, Postal Service (PS) Form 1412 (Daily Financial Report)) are automated so data is easily entered, edited, stored, and then transferred automatically to the USPS on a periodic basis. Ordering postal supplies, tracking postal offenses, and maintaining equipment inventories using PS Form 1590 (Supplies and Equipment Receipt) are also available through AMPS.

4-11. Communication is also required with the HR company, HROB, HRSC, MMT, and the supporting SUST BDE. Additionally, database access to HR systems is required in order to establish and operate the postal directory, identify casualties for casualty mail operations, and to receive postal updates and alerts.

POSTAL RESTRICTIONS

4-12. Commanders have high expectations for unrestricted postal services to enhance morale and communication. Operational constraints, such as rapidly moving units or an overburdened logistics system, may require temporary postal restrictions. Mail restrictions are stricter at newly established sites than during mature sustainment operations and need reevaluation as the mail infrastructure develops. Commanders may restrict mail at the beginning of combat operations in order to avoid hampering the flow of mission essential supplies and equipment into the operational area. Postal restriction considerations include:

- Dissemination of contingency area APO addresses and ZIP Codes.
- Restrict all mail for the first 30 days.
- Allow letter class mail at the 30-day point if theater postal operations are established and the request for an APO address is submitted to MPSA and approved.
- Allow parcels at the 60-day point.
- Remove all restrictions after 90 days (dependent upon the situation).
- May or may not offer full postal services such as postal money orders, express mail, and registered mail in the initial or immediate sustainment phases of the operation due to infrastructure or security requirements.

4-13. Early establishment of postal infrastructure during theater opening or early entry operations limits the requirements for postal restrictions and allows the flow of mail to commence earlier. The ASCC G-1/AG makes recommendations on policy and guidance to the ASCC commander concerning the required postal restrictions and duration.

POSTAL APPOINTMENTS

4-14. Appointment of personnel performing postal duties in a designated position is required. To satisfy this requirement, appoint all personnel working in a postal activity as a military postal clerk, finance postal clerk (military), custodian of postal effects (COPE), or postal finance officer. Additionally, military personnel supervise each MPO.

4-15. Responsible commanders with Uniform Code of Military Justice authority must designate military postal clerks, COPEs, and postal finance officers. Commanders may delegate authority to postal officers to sign DD Form 285 (Appointment of Military Postal Clerk, Unit Mail Clerk, or Mail Orderly) and DD Form 2257 (Designation/Termination MPC-FPC-COPE-PFO). Once appointed, inform each individual of their responsibilities, obligations, and liabilities in handling postal funds and mail by reviewing PS Form 8139 (Your Role in Protecting the Security of the United States Mail). All appointments must meet the requirements of DOD 4525.6-M.

4-16. During military operations it is not necessary to have more than one COPE; however, recommend at a minimum, one be appointed for each MPO as postal platoons may operate more than one MPO. Postal activity personnel (for example; military postal clerks, COPEs, and postal finance officer) duties and responsibilities include:

- Requisitions and stocks adequate quantities of stamps, money orders, and equipment and supplies to satisfy the requirements of all COPE and/or postal clerks supported.
- Receives and accounts for stock from postmasters at New York and/or San Francisco.
- Maintains accountability records.
- Secures and protects accountable stock items, and be accountable for fixed and/or flexible credits.
- Monitors requisitions and transmittal of postage sales, money order, and meter business from postmasters.
- Develops, implements, and fields new accounting procedures and local SOPs for contingency operations.
- Monitors monthly audits from postmasters and PS Form 1908 (Financial Adjustment Memorandum) to ensure they have been resolved and submitted in a timely and accurate manner.
- Prepares and conducts training for postal officers, postmasters, and technical inspectors on all aspects of postal finance, supply, and equipment procedures.
- Maintains automated postal finance and supply related forms.
- Performs administrative duties, such as maintaining files IAW Army regulations, publications, and internal and external correspondence.
- Maintains an AMPS account.

POSTAL AUDITS

4-17. The USPS requires periodic audits of all postal accounts advanced by the USPS to ensure protection of these accounts at all times. Personnel authorized to conduct audits include:

- Postal finance officers.
- COPEs and finance supervisors.
- MPO supervisors.
- Responsible commanders.
- Postal officers.
- USPS representatives of the Postmaster General.
- Military department or Army Command Inspector General teams.
- DOD and military department audit agencies, including Monies Audit Board members.
- Persons whose duties are of an investigative nature, when authorized by the responsible commander or the USPS for a specific purpose.
- A disinterested officer or NCO appointed by the responsible commander.
- MPSA personnel.
- Postal assistance advisors or audit and inspection personnel designated by Army commands.

4-18. Audit of the postal finance officer and COPE - Audit all working accounts at least once monthly. Normally, responsible commanders or their designated representatives, postal officers, and MPO supervisors shall conduct these audits. The following is recommended:

- Audits of newly assigned finance clerk accounts must occur weekly for the first 30 days.
- Conduct audits at unscheduled and unannounced times.

- The person audited shall be present during the audit. In case of absence (for example; absent without leave, unauthorized absence, or illness), another person shall act as a witness in that person's behalf.
- Do not exchange funds or stocks between accounts during the audit.
- When money order, postage stamp stock, and postage meter accounts are in the possession of one person, audit and balance each account separately; however, audit all the accounts at the same time.
- Where commingling of money order, meter, and stamp funds is authorized, audit the accounts in this order: Money order funds first, meter second, and stamp stock third. Account for all overages or shortages in the stamp stock account. For MPOs utilizing the Unisys III and its transmission capabilities, audit the account as an entity.
- During an audit, clerks may not use the account to transact business of any sort.
- Prior to the audit, personnel conducting the audit shall not have unescorted access to the account.
- Persons responsible for postal effects shall show full accountability at the time of the audit.
- Responsible commanders or their designated representative, postal officers, or MPO supervisors shall audit the COPE and finance supervisor quarterly. When changing COPEs and finance supervisors, conduct the audit jointly with the incoming and outgoing COPEs and include the number and identity of USPS accountable items, money orders, stamp stock accounts, and postage meter accounts. If an assistant custodian maintains a portion of the stock, they shall participate in the audit.
- At one-person MPOs or units, audit all accounts in possession of the clerk at least once monthly. If needed, request the host activity or another MPO supervisor or postal officer to perform the audit.

ORGANIZATIONAL RESPONSIBILITIES

4-19. All organizations within the Army postal footprint have different roles and responsibilities based on level of responsibility. Postal professionals and commanders have an understanding of how postal support contributes to current and future operations and how postal operations play an increasingly critical role in support of the total force.

JOINT MILITARY POSTAL ACTIVITY (JMPA)

4-20. The responsibilities of the JMPA are as follows:

- Acts as the single DOD point of contact with USPS at the postal gateways.
- Coordinates transportation of mail with the host nation.
- Coordinates mail movement transportation needs with commercial carriers and the military Air Mobility Command.
- Coordinates mail routing scheme changes with postal gateways and maintains the military ZIP Code database for the automated dispatch of mail.
- Coordinates postal supply equipment requests.
- Provides Army commands and military department postal representatives with information on mail processing and irregularities.
- Assists the United States postal inspection service when requested in matters relating to the processing, distribution, dispatch, and transportation of military mail.

MILITARY POSTAL SERVICE AGENCY (MPSA)

4-21. The responsibilities of the MPSA are as follows:

- Acts as the single DOD point of contact with the USPS and other government agencies on military postal service operations and on all policy and operational matters.

- Coordinates with other federal agencies on military postal services, to include the Federal Aviation Administration and Department of Homeland Security on any restrictions which may require the screening of mail.
- Coordinates with the theater/combatant command to ensure the appointment of a service postal manager (SPM). The SPM is the point of contact to ensure optimum postal support is provided to theater prior to execution of postal service. The SPM is involved in all planning for military operations.
- Advises USPS of any mail embargos or restrictions to theater.
- Initiates action to obtain or terminate free mail (if requested by the combatant commander).
- Coordinates air and surface movement of military mail from the USPS to the postal gateways. The SPM determines commercial and military APODs and the required level of frequency, pouching, sacking, or labeling requirements.
- Requests personnel augmentation to support APOEs and SPOEs, if required.
- Approves or disapprove all requests for exception to policy from the combatant commander.
- Activates and deactivates contingency MPOs in coordination with Service representatives, direct reporting units, combatant commands, and Service component commands.
- Coordinates initial mail routing schemes with the JMPA(s).
- Coordinates an integrated network of major military mail distribution and transportation facilities in overseas areas.
- Provides MPS expertise as needed to support DOD staff and combatant commanders, to include participation in the OPORD process.

DEPARTMENT OF THE ARMY (DA) POSTAL

4-22. The DA postal provides oversight to the MPS to ensure it provides efficient postal services to authorized personnel and activities in CONUS and overseas during normal and contingency operations. Responsibilities of DA postal are as follows:

- Develops Army postal policy.
- Acts as the functional proponent for AR 600-8-3.
- Acts as the subject matter expert for technical and functional postal operations (peacetime and contingency).
- Informs DA leadership of initiatives and challenges regarding postal operations.
- Acts as a liaison with the ASCC, MPSA, and other Services.
- Assists Army postal units with deployment, planning, preparation, execution, and transition.
- Reviews the Interservice Postal Training Activity curriculum and Soldier Support Institute doctrine to meet the needs of the Army.
- Investigates and responds to congressional inquiries concerning DA postal operations.
- Provides customer service for Army inquiries regarding mail, and monitors customer comments to identify systemic issues and/or areas which require regulatory guidance.

SERVICE POSTAL MANAGER (SPM)

4-23. The SPM implements and coordinates postal operations throughout the JOA under the authority of the combatant commander or joint force postal staff. The SPM serves as the liaison between the operational area and MPSA. The SPM responsibilities include:

- Adjusts planning factors and execution to allow operational control, administrative control, or tactical control of all theater postal resources until theater sustainment or stability is established.
- Establishes joint MPS procedures in the operational area and assigns responsibilities to JTF forces in coordination with the combatant commander and communications system directorate of a joint staff (J-6) postal.
- Identifies postal augmentation requirements and coordinates logistics sourcing as soon as possible during the planning phase in coordination with the combatant commander and J-6 postal.

- Ensures postal personnel, assets, and infrastructure requirements integrate into the Time Phased and Force Deployment Data list to support the early flow of mail into the operational area. Mail should flow no later than 30 days after RSOI.
- Requests MPSA to activate and deactivate contingency ZIP Codes.
- Plans and integrates all contracted postal efforts by Service components in coordination with the combatant commander and J-6 postal.
- Coordinates reports for all MPOs and MPS activities.
- Processes requests for restrictions, such as mail embargoes or other restrictions in coordination with the JOA. (Note: The JTF submits free mail requests through the SPM).

ASCC G-1/AG

4-24. The ASCC G-1/AG is responsible for postal operations. While the G-1/AG does not execute postal operations, it is the agency responsible for developing postal policies, priorities, guidelines, and monitoring postal operations within theater. The ASCC G-1/AG accomplish this in coordination with the TSC/ESC and the HRSC. All policies developed adheres to joint policy guidelines. Responsibilities of ASCC G-1/AGs include:

- Plans, coordinates, integrates, and assesses postal operations within the theater G-1/AG AO.
- Ensures postal operations are included as part of Tab A, to Appendix 2, to Annex F of the OPOD or contingency plan. If Army postal organizations provide postal support to joint and multi-national forces, they must be addressed in the OPOD.
- Maintains liaison with the SPM, TSC/ESC, HRSC, and host nation for postal functions.
- Processes requests to the SPM for APO activations and deactivations.
- Assists the TSC/ESC, HRSC, and MMT in obtaining postal resources to support the theater postal mission.
- Monitors postal irregularities and postal offenses reported by the HRSC.
- Ensures the TSC/ESC, HRSC, and MMT have systems in place to identify deficiencies in the postal operating system and takes appropriate corrective actions to correct deficiencies.
- Develops, in coordination with the TSC/ESC, HRSC and MMT, procedures for addressing customer complaints, inquiries, suggestions, and for the expeditious return of casualty mail.
- Addresses or forwards to the SPM all theater postal issues not resolved by the TSC/ESC, HRSC or MMT.
- Monitors force management issues within theater.

HRSC, POSTAL OPERATIONS DIVISION (POD) RESPONSIBILITIES

4-25. The HRSC is the TSC/ESC staff element responsible for ensuring all postal policies, regulations, and guidance from USPS, MPSA, and ASCC are implemented and executed by all Army postal assets within theater. The POD provides postal assistance and technical guidance to HROBs and HR companies and ensures they are in compliance with postal operations policies and regulations. The POD directly supports the execution of the theater postal policy and EPW mail mission and identifies appropriate resources to support the theater postal mission. Specific responsibilities of the division include, but are not limited to the following:

- Plans and coordinates with the combatant command and SPM to request and ensure appropriate MPS resources (for example; host nation support, transportation, facilities, and equipment) are assigned for the execution of postal responsibilities in the AO.
- Participates with the TSC/ESC, HROB, and theater G-1/AG in planning, executing, and assessing postal operations for theater.
- Coordinates with the ASCC G-1/AG for policy guidance and resourcing by the TSC (for example; postal elements, facilities, transportation, and equipment).
- Appoints a theater and assistant postal finance officer to ensure establishment and functionality of postal finance accounting and claims policies and procedures. This includes providing daily postal finance support to finance clerks within MPOs.

- Provides technical guidance to the MMT and HROB.
- Provides technical guidance and postal compliance support to all subordinate HROBs.
- Assists the ESC HROB in the establishment of theater opening postal operations.
- Establishes the deployed AO postal inspection plan to ensure compliance with USPS and DOD regulatory guidance.
- Establishes direct coordination with both the MPSA and the servicing JMPA, and conducts detailed postal planning and coordination with the MPSA.
- Ensures DOD Civilian, CAAF, and multi-national support requirements are determined and disseminated.
- Monitors and determines appropriate mail flow rates and ensures current data integrates into all TSC and ESC SPO planning.
- Ensures postal operations are included in OPLANs and OPORDs.
- Appoints the theater Postal Supply Officer to coordinate all theater-level postal supplies, equipment accountability, and ordering.
- Maintains a list of all theater postal delivery points and immediately posts and distributes changes to postal organizations.
- Coordinates with the TSC/ESC for augmentation support for postal elements. (Note: This may be necessary during peak holidays periods).
- Coordinates theater-level training for MPO representatives to ensure compliance with DOD and USPS policies and procedures.
- Develops procedures for postal support of the Service component command's voting program.
- Plans and coordinates with the SPM, TSC/ESC, and HROB for MPO openings, closings, and relocations when standing-up a theater of operations.
- Ensures the manning and operation of MMTs and mail control activities in coordination with the theater SPM and/or theater Air Force postal representative.
- Consults with SPM and JMPA to develop mail routing instructions and procedures for optimum mail delivery in theater.
- Plans and provides unit mail routing information to the servicing JMPA in coordination with the MMT.
- Ensures theater postal locator and procedures for casualty mail and redirect services has been established.
- Responsible for the local theater unit locator service.
- Assists the HROB as necessary in the coordination of theater-level mail transportation support for mail movement to and from all necessary locations.
- Manage the theater EPW mail plan and monitor the execution of EPW mail.
- Coordinates requests for coalition mail support.
- Employs, establishes, and develops suspicious mail procedures. Ensures MPO personnel at all levels are knowledgeable of policies, procedures, and guidance related to suspicious mail incidents.
- Collects from the HROB postal statistical and historical workload information from postal units to identify trends, inefficiencies, and improve postal network services.
- Postal Assessment and Assistance team conducts inspections/audits and assists locations with on-site training as needed.
- Implements procedures for responding to congressional inquiries, customer complaints, inquiries, and suggestions.
- Reviews statements of work in coordination with the supporting contracting office to ensure level of support remains consistent within theater.
- Considers host nation postal limitations and restrictions and works with MPSA to implement for prograde and retrograde mail.

4-26. The duties and responsibilities of personnel assigned to the POD include, but are not limited to the following:

- Personnel Officer:
 - Oversees the execution of all POD operations in theater.
 - Coordinates with the combatant command, DA postal, and HRSC Director on all matters as appropriate.
 - Establishes and implements the deployed AO postal inspection plan for postal facilities.
 - Determines and organizes internal support requirements for the division.
 - Provides technical guidance and support to HR organizations as required.
- HR Technician:
 - Provides division with technical oversight and guidance.
 - Oversees policy and management of AMPS and EPW and casualty mail.
 - Liaises with theater ASCC G-1/AG and TSC.
 - Acts as Team Leader of the Postal Inspection team established to conduct required postal inspections and audits throughout the postal operational area.
 - Assists with organizing team(s) for continuous operations.
 - Assists in obtaining, verifying, updating, and disseminating postal information.
 - Assists division in establishing liaisons with all HR elements.
 - Provides and assists in postal briefings to higher echelons.
- Senior HR Sergeant:
 - Serves as the senior enlisted advisor to the Personnel Officer.
 - Assists the Personnel Officer in establishing POD operations.
 - Assists the Personnel Officer in establishing the postal operations SOP.
 - Serves as noncommissioned officer in charge of the Postal Inspection team established to conduct required postal inspections and audits throughout the postal operational area.
 - Advises and briefs the HRSC Director, ASCC G-1/AG, and commander on POD operations.
 - Maintains communications with the HRSC and ESC and SUST BDE HROBs to assist in planning and resourcing of postal operations.
 - Assists HR organizations in meeting postal training and readiness requirements and operating procedures.
 - Coordinates with all organizations on postal policy matters.
- Postal Specialist:
 - Serves as Team Member of the Postal Inspection team established to conduct required postal inspections and audits throughout the postal operational area.
 - Assists with SAVs.
 - Performs administrative duties as assigned.
 - Responsible for mail incident reports.
- HR Technician, Team A and B:
 - Serves as officer in charge of the postal inspection team or opening/closing team.
 - Assists with fielding policies and operational questions submitted to the POD from postal entities in the AO.
 - Plans, coordinates, and conducts SAVs of APOs in the AO.
 - Serves as liaison between the POD and postal entities in the field.
 - Provides APO support.
 - Assists in the integration of postal related contract support.
 - Facilitates logistical support for APOs activating and deactivating.
 - Oversees and manages postal logistical support in theater (supplies and equipment).
 - Serves as ASCC approval authority for processing requisitions for all postal equipment and supplies in theater.
 - Serves as the ASCC approval authority for quarterly PS Form 1590 reviews.
 - Provides replacement postal equipment to APOs in theater.

- Processes requisitions for quarterly mail transportation equipment and empty equipment.
- Serves as the postal logistics liaison for JMPA-Atlantic and MPSA.
- Receives and processes damaged equipment for repair.
- Establishes COPE procedures and manages postal meters.
- Serves as ZIP Code manager for MPOs and mail addresses only.
- Trains assistant Postal Finance Officer on duties and responsibilities.
- Postal Sergeant, Team A and B:
 - Reviews postal incident reports for accuracy.
 - Provides sustainment training as needed for postal operations.
 - Maintains mail transient timeline tracker.
 - Coordinates and maintains postal supplies and equipment for theater organizations.
 - Monitors, tracks, and records overall theater mail flow.
 - Serves as technical inspector for theater cash and stamp stock; individual COPE cash and stamp stock; registered mail inspections; postal offenses and alerts; and timeliness and irregularity reports.
- Postal Clerk, Team A and B:
 - Establishes AMPS accounts.
 - Updates applicable web-based systems for postal guidance.
 - Serves as a technical inspector on the inspection team as required.

MILITARY MAIL TERMINAL (MMT) TEAM

4-27. The MMT team provides specialized equipment and expertise to establish the Army element of a JMMT with the augmentation of an HR company (Postal) in the port area which coordinates, receives, and processes incoming theater mail and dispatches retrograde mail to CONUS. The MMT team deploys initially with the SUST BDE with the theater opening mission and then transition to a theater distribution role.

4-28. The MMT is the mail control activity for theater. The MMT team establishes a mail terminal to support postal operations at the theater entry point (APOD and SPOD) for receiving and processing incoming mail as well as dispatching mail to CONUS. The MMT operates IAW DOD 4525.6-M. It operates as a coordinating staff under the mission command of the supporting SUST BDE during peacetime rear operations and the wartime theater opening mission. Additionally, the MMT is under the administrative control of the STB or CSSB for religious, legal, health services, military pay, HR and administrative services, quarters and rations, logistics, unit maintenance of organic equipment, and supplementary transportation support. Once the theater matures, the MMT serves as the Army component of a JMMT, and is assigned as an element of the theater Land Component Command (see JP 1-0, *Joint Personnel Support*). During this time, the JMMT is under administrative control (-) to the theater SUST BDE for life support functions.

4-29. The MMT receives its technical guidance through the HRSC POD, SPM, and MPSA, and technical assistance from the HROBs. If establishing more than one APOD and SPOD, a second MMT must deploy. In addition, the MMT or JMMT has oversight of mail operations at air stops, Air Mail Terminals, and Ground Mail Terminals within the APOD and SPOD for the purpose of mail synchronization throughout theater. Figure 4-2, found on page 4-11, depicts an example of an MMT layout.

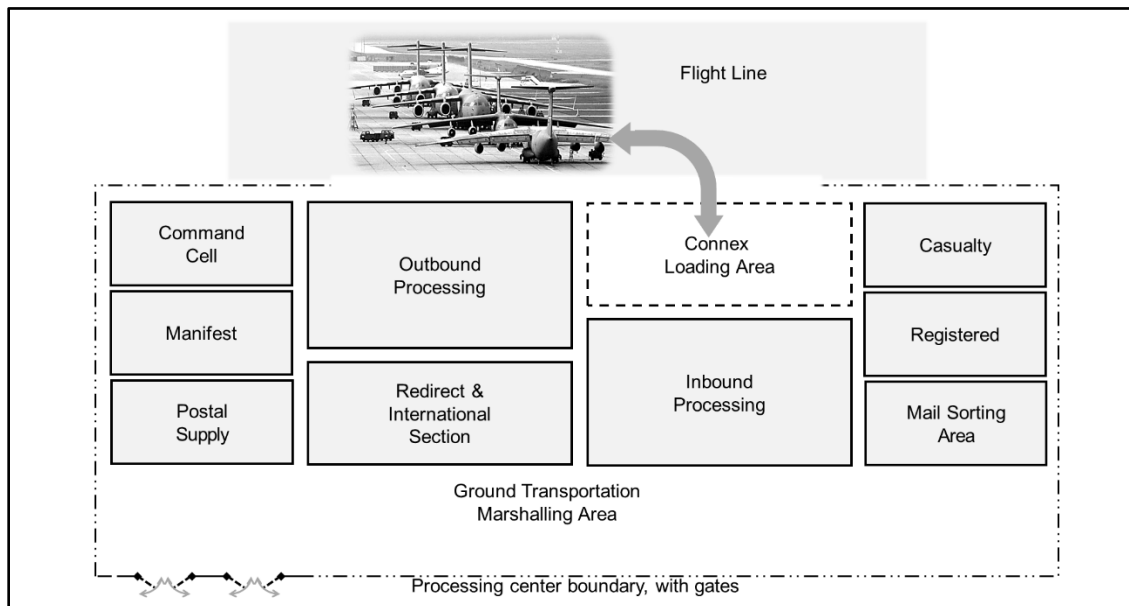

Figure 4-2. Example MMT layout

4-30. The MMT is the primary gateway(s) for postal operations in and out of the deployed AO and utilizes existing or SUST BDE-provided airfield support to conduct operations. These facilities operate full-time with a capability of up to 250K+ pounds of mail per day and have surge capabilities to handle variances, such as holiday mail increases. The MMT must be scalable to handle the operational requirements of theater. Coordination with the supporting APOD and APOE MCT is required for visibility and provision of sufficient transportation assets for the movement of mail into the deployed AO as organic transportation assets are not assigned to the MMT. As the gateway point for deployed AO mail entry and exit, the MMT often employs a host nation representative to ensure compliance with host nation requirements.

4-31. The MMT is minimally staffed to provide the theater with specialized postal expertise and experience to support postal operations within theater. An HR company with postal platoons augments the MMT in order for it to be fully capable of moving and sorting mail at all designated air stop(s) locations. In addition, specialized equipment is required to move bulk mail and perform such functions as mail inspections, x-ray of packages, and other equipment to meet regulatory and security requirements. Equipment includes a rough terrain container handler and large forklifts. The USPS provides some specialized equipment. (Note: Refer to DOD 4525.6-M for equipment specifics and how to obtain the equipment).

4-32. The basic working space for an MMT is one square foot per two supported members. For instance, if the MMT provides full support for five bases, with a total combined population for 100,000, the facility is calculated at an estimated 50,000 square feet. (Note: Refer to JP 1-0 for further information).

4-33. A full-service MMT which provides service via ground and air, and which is a primary regional or country APOD, operates within the confines of the servicing active aircraft runway with full unrestricted access to arriving and departing aircraft for on and off loading purposes.

4-34. The MMT operations section is the element responsible for conducting logistics planning, developing operating guidance, and coordination of all other postal staff support. The section links all theater postal operations and the MPSA. Additionally, it serves as the operational interface between the MMT and HROBs for coordinating the distribution of mail and related postal transportation requirements.

4-35. The MMT postal squads are responsible for managing the routing of all inbound and outbound mail and ensuring its timely and accurate processing. Additionally, they establish a casualty mail section, and distribute the mail to the HR company's postal platoons operating at an APO or unit mail clerks when the MMT or JMMT acts as a mail local sort facility rather than a bulk transfer hub. The MMT Chief and Senior HR Sergeant organize the postal assets as dictated by the mail flow and operational and mission variables. The MMT postal squads also provide all required heavy equipment operators for the large forklifts.

4-36. An HR company and/or postal platoons provide the MMT augmentation. A key planning factor in determining augmentation requirements are the number of pounds processed daily, and the number of tons of mail received and transported to CONUS. All augmentation personnel must be capable of operating all postal equipment. The HRSC POD provides specialized training and compliance for the MMT and supporting HR company.

4-37. The MMT operates IAW USPS, MPSA, DOD, and combatant command guidance and instructions. The MMT, similar to the TG PAT operates under the operational control of the SUST BDE during a theater opening mission and the operational control of the Land Component Command G-1/AG in a mature theater. (Note: Refer to JP 1-0 for further information). The MPSA and HRSC POD provide technical guidance. The SPO sections and HROBs provide support to mission operations. HR companies or platoons operate under the guidance and direction of the SUST BDE HROB. While the MMT does not provide operational guidance to their HR company augmentation, it does provide technical guidance to ensure all functions of the MMT are within regulatory standards. Submit issues which cannot be resolved to the HRSC POD for resolution.

4-38. The MMT is not assigned transportation assets. It must closely coordinate transportation support through the SPO HROB, which coordinates with the CSSB MCT to transport mail to the forward operating area(s). Close coordination with planners assists with forecasting future actions as the theater matures and to determine feasibility and viability of mail routes. Mail is normally included in convoys or travel via air and move with other sustainment items for transportation from the MMT (located in a support area) to the supported APOs. In mature theaters, mail handlers and transportation assets supporting the JMMT mission may be contracted out for additional support.

4-39. Responsibilities of the MMT team include, but are not limited to the following:

- Establishes the Army component of a JMMT in conjunction with other Services when operating in a joint or multi-service environment. (Note: The team is capable of operating the MTT in a single-service environment).
- Develops and coordinates mail routing schemes, mail distribution points, and schedules in coordination with the combatant command, SPM, supported MPOs, and direct reporting units.
- Obtains sufficient vaults, safes, and other adequate storage facilities to safeguard registered mail, postal effects, and other appropriate support to ensure compliance with DOD 4525.6-M and directives.
- Ensures adequate funding for the postal activities to maintain acceptable service levels.
- Provides specialized postal expertise, experience, and limited augmentation manpower.
- Provides all technical direction to the HR postal company commander operating at the MMT.
- Provides integrated, accurate, and timely processing and distribution of all mail arriving in the AO.
- Establishes a casualty mail section to provide casualty mail services to the AO.
- Distributes mail to HR (Postal) companies providing area support, or as the tactical situation directs, direct to postal platoons depending on the size of the supported force.
- Serves as a collection point and routing agency for all retrograde mail coming from within the AO.
- X-rays all retrograde packages for potential non-mailables.

4-40. The duties and responsibilities of personnel assigned to the MMT team include, but are not limited to the following:

- Chief:
 - Oversees the execution of all MMT operations in theater.
 - Coordinates with the HRSC Director on all matters as appropriate.
 - Determines and organizes internal support requirements for the MMT.
 - Provides technical guidance and support to HR organizations as required.
- Deputy Chief:
 - Maintains and manages MMT organizational budget.

- Prepares and attends all staff briefs for higher HQs to include coordination and tasking from higher.
- Consolidates MMT information updates for the Chief.
- Organizes internal support requirements for the MMT.
- Provides technical guidance and support to HR organizations as required.
- Senior HR Sergeant:
 - Serves as the senior enlisted advisor.
 - Assists the Chief in establishing the MMT.
 - Assists the Chief in establishing the MMT SOP.
 - Advises and briefs HRSC Director, ASCC G-1/AG, and commander on MMT operations.
 - Maintains communications with the HRSC and ESC and SUST BDE HROBs.
 - Assists HR organizations in meeting training and readiness requirements and operating procedures.
 - Coordinates with all organizations on policy matters.
 - Monitors all morale, welfare, and quality of life issues for the organization.
 - Monitors unit and enlisted personnel training.
 - Receives and orients newly assigned enlisted personnel.
 - Assists with inspecting command activities and facilities.
- Wheeled Vehicle Mechanic:
 - Maintains unit wheeled vehicles and generators.
 - Provides vehicle status reports to the Senior HR Sergeant.
- HR Technician:
 - Provides technical guidance and oversight of the execution of all MMT operations in theater.
 - Provides technical guidance and support to HR organizations as required.
 - Implements theater policies and procedures for directory services.
 - Develops work schedules.
 - Monitors all changes of postal publications to ensure they are posted and available to postal clerks.
 - Spot-checks directory mail for proper processing and endorsements.
 - Coordinates transportation for all inbound and outbound mail movement.
- HR Sergeant:
 - Coordinates with the Senior HR Sergeant on all matters as appropriate.
 - Provides internal support requirements for the MMT.
 - Provides support guidance and support to HR organizations as required.
 - Coordinates inbound and outbound movement contracts.
 - Conducts long and short term postal planning.
 - Obtains mail processing procedures from the MMT.
 - Manages mail operations of the postal platoon.
- HR Specialist:
 - Assists in receiving inbound mail.
 - Assists in sorting the mail.
 - Responsible for re-routing mail.
 - Assists with mail guard duties.
- Postal Supervisor, Postal Squad A and B:
 - Responsible for ground and air operations movement setup.
 - Ensures internal audits and inspections are conducted.
 - Coordinates with the Provost Marshal office for inspection of suspected non-mailable items.
 - Oversees receipt of prograde and retrograde mail, sorting, and re-routing of mail.

- Responsible for reporting postal net alerts, postal offenses, mail volume, and non-mailable quantities.
- Postal Sergeant, Postal Squad A and B:
 - Serves as the quality control officer.
 - Maintains the mail transient timeline tracker.
- Postal Specialist, Postal Squad A and B:
 - Assists in receiving inbound mail.
 - Assists in sorting the mail.
 - Responsible for re-routing mail.
 - Assists with mail guard duties.
 - Responsible for transportation to include ground and air operations.
- Postal Clerk, Postal Squad A and B:
 - Assists in receiving inbound mail.
 - Assists in sorting the mail.
 - Responsible for re-routing mail.
 - Assists with mail guard duties.
 - Responsible for transportation to include ground and air operations.

HROB

4-41. The HROB plans, coordinates, integrates, and synchronizes the activities of subordinate HR elements in the deployed theater (attached to SUST BDEs) to ensure they are resourced, positioned, and properly allocated to provide postal support. Postal responsibilities include, but are not limited to the following:

- Serves as integrator between the HRSC and assigned or attached HR organizations (for example, HR company and MMT team).
- Ensures the emplacement and displacement of HR support organizations are in synchronization with the concept of support plans for postal operations.
- Deploys as part of the ESC or SUST BDE early entry element to assist in establishing initial theater postal operations.
- Conducts SAVs with the MMT and MPOs.
- Coordinates with the MMT for postal issues or HRSC, POD support.
- Coordinates with other SPO section branches to establish and execute recurring logistic requirements for postal operations.
- Coordinates all mobile postal missions within the AO.
- Reviews, monitors, and recommends postal asset distribution within the AO and reviews OPORDs and FRAGORDs for HROB mission impact.
- Requests AMPS accounts for all supported postal platoons.
- Monitors and tracks mail movement throughout the AO.

HR COMPANY

4-42. The HR company provides mission command of its HQs and subordinate postal platoons or a combination postal and HR platoon. The HR company and postal platoons provide augmentation to the MMT. The HR company operates under the mission command of the supporting SUST BDE and receives technical guidance from the MMT and HROB. Responsibilities of the HR company HQs include, but are not limited to the following:

- Participates in the planning, implementation, and assessment of postal operations.
- Provides data integration support for the MMT and dispersed platoons.
- Coordinates with base or FOB Mayor for support at all outward locations.
- Manages and plans postal operations support for current and future operations.
- Coordinates with the HROB for transportation and equipment needed for postal operations.

- Provides augmentation support to the MMT during early entry operations.
- Assists in establishing and operating the theater directory and redirect mail services.
- Maintains voice and data communications with the MMT, HROB, HRSC, and subordinate platoons.
- Establishes MPOs as directed.
- Coordinates with the brigade STB for facilities and site assignment.
- Coordinates HR company requirements for base cluster support and defense.
- Establishes company support activities for postal platoons.
- Provides the COR when postal services are contracted.

POSTAL PLATOON

4-43. The mission of the postal platoon is to provide postal support to all individuals and units in an assigned AO or to serve as an element of an MMT. Postal platoons operate in conjunction with the Plans and Operations teams within the HR companies. Responsibilities include, but are not limited to the following:

- Provides postal augmentation to the MMT as directed by the HR company.
- Conducts daily postal operations.
- Plans for mobile postal missions.
- Plans and executes all mobile mail missions.
- Establishes MPOs as directed.
- Supervises and controls the platoon.
- Coordinates with the HR company HQs on postal matters.
- Receives and distributes intra-theater mail.
- Designates registered mail clerks.
- Prepares mail for unit mail clerks.
- Receives, processes, and dispatches incoming and outgoing mail.
- Receives, processes, and maintains a chain of custody for all mail with special services.
- Updates postal routing schemes.
- Conducts casualty and EPW mail operations.
- Conducts postal financial and supply support and management.
- Conducts unit mail room and consolidated mail room inspections.
- Executes MPO openings, closings, and relocations.
- Responds to all customer complaints and inquiries.
- Assists COR in contract oversight IAW the Performance Work Statement and DOD 4525.6-M.

4-44. The postal platoon is a multifunctional organization providing postal support for up to 6,000 personnel. It also serves an augmentation role in support of an MMT. The platoon is capable of performing the complete spectrum of postal functions from postal service and postal finance to postal operations. The postal platoon receives all technical guidance through the HR company HQs and the HROB or MMT. The HR company provides mission command of postal platoons which may or may not deploy with the unit's main body. Once on the ground, a fully manned and equipped postal platoon can be operational within 48 hours. Postal units must have adequate facilities, transportation, personnel, and equipment prior to the movement of mail in or out of the AO.

4-45. Postal platoons provide customer service for postal finance support consistent with theater mail policies and priorities. These services include money orders, postage stamp sales, special services, and package mailing. Provide services at consolidated locations as the tactical situation and manning level allows. Services provided at FOBs can be increased or decreased based on command directives, along with operational and mission variables. Postal finance support for outlying tactical areas is coordinated through the HROB of the SUST BDE and HR company. It is the responsibility of the HROB to coordinate with the S-1 located at the FOBs to ensure postal operations meet the needs and support of the FOB.

4-46. Typically, postal platoons are located at the APOs either in SUST BDE-level or above support areas. Postal platoons should be prepared to support mobile mail missions based on mission requirements. The postal platoon, when located at a FOB, remains under the mission command of the HR company and does not work directly for the S-1. Again, it is critical for the HROB to coordinate with the S-1 at the FOB to ensure mail operations are responsive to the needs of postal support at the FOB.

4-47. Conduct mail room inspections to ensure compliance with both United States and international requirements. The cultural customs of the deployed AO, Uniform Code of Military Justice prohibitions, and United States Customs Service requirements must be met for all incoming and outgoing mail to prevent illegal or prohibited items from being shipped through military channels.

OTHER POSTAL INFORMATION

4-48. Postal operations have a significant effect on the moral of Soldiers and their families. There are several elements to consider as it pertains to postal operations. The following paragraphs discuss other elements of postal operations.

CASUALTY MAIL

4-49. Casualty mail processed within the mail distribution system requires special attention to prevent premature casualty information disclosure and mail returned home before NOK notification. When processing casualty mail, unit mail clerks validate the Soldier's location, hold the mail for the Soldier's return, forward the mail to the MTF, or return to the servicing postal platoon. All undelivered casualty mail will not contain any endorsements or marks made or posted on the mail by the unit, and is returned to the APO. The APO forwards casualty mail to the casualty mail section for processing. The postal platoon verifies casualty information; makes appropriate endorsements, then forwards casualty mail to the theater casualty section at the MMT for final processing. This only applies to unopened mail as any mail that has been previously opened by the Soldier is considered personal effects and is shipped with the rest of the Soldier's belongings.

FREE MAIL

4-50. Free mail is authorized as determined by the Secretary of Defense. Free mail is a privilege specifically granted by law and intended solely to expedite transmission of military members' personal letter and mail correspondence to the United States in times of operational contingency in arduous circumstances or armed conflict.

4-51. Free mail privileges apply to military Service Members in a declared "Free Mail" operational area as well as those hospitalized in a facility under military jurisdiction as a result of service in the designated area. Free mail also applies to Civilians who are designated by the combatant commander as essential to and directly supporting military operations, and is generally limited to DOD employees and authorized subsidiaries of United States owned and operated companies in direct support of the contingency stationed in the operational area. See DOD 4525.6-M for more information on DOD postal policy.

4-52. Free mail guidance is provided by MPSA, and addresses weight allowance and type of mail authorized. Free mail privileges are not normally allowed when mail is processed, handled, or delivered by a foreign postal administration. The Army/ASCC requests free mail through the combatant commander for the specific theater and is considered authorized when the combatant commander has received official approval from the Secretary of Defense. Upon completion of the joint operation, the combatant commander requests termination of free mail via MPSA. Currently, review and revalidation for free mail areas is required every 180 days to ensure the conditions that authorized free mail are still applicable.

CONTAMINATED AND SUSPICIOUS MAIL

4-53. The postal network must make special provisions for handling and processing contaminated and suspicious mail. The suspected mail item may consist of chemical, biological, radiological, or nuclear material to include contraband. Once a mail item is identified as a threat, postal operations are halted and postal personnel and customers are evacuated immediately from the danger area. The postal unit notifies the military police to secure the area, an explosive ordnance disposal team to clear the area and render safe any

explosives, and a chemical, biological, radiological, and nuclear element to conduct contamination mitigation (contamination control and decontamination) of the area.

CONTRACTING OFFICER REPRESENTATIVE (COR)

4-54. The CORs are qualified individuals nominated by the requiring activity and appointed by the contracting officer to assist in the technical monitoring or administration of a contract. Although CORs can be employed on all types of service contracts, they are critically important in the more complex services, for example in the MMT. Not everyone can be a COR. The CORs must be a government employee (either military or Civilian) and they must possess the necessary qualifications (training) and experience commensurate with the responsibilities delegated to them. It is the requiring activities responsibility to ensure nominated CORs meet current Army training and technical qualification standards. The supporting contracting office can provide up-to-date COR qualification requirements.

This page intentionally left blank.

Chapter 5

Conduct HR Planning and Operations

The core competency Conduct HR Planning and Operations requires standardized formatting to better express tasks and missions for subordinate HR organizations. A natural tension exists between how far ahead commanders can plan effectively without preparation and coordination becoming irrelevant. Planning too far in advance may commit assets that may not be available when requested. However, not planning for future events may result in not identifying requirements ahead of time to begin the sourcing process. Understanding this tension is essential to ensuring the command focuses on the right planning horizon.

PLANS AND OPERATIONS

5-1. Theater HR professionals provide input on how HR operations are conducted in current and future military operations. The OPLAN and OPORD is the means by which theater HR operations envision and execute a desired end state in support of the commander. The MDMP is an iterative planning methodology that integrates the activities of the commander, staff, subordinate headquarters, and other partners to understand the situation and mission, develop a COA, and produce an OPLAN or OPORD for execution.

5-2. The HRSC Plans and Operations Division is the lead in ensuring HR support is included in all OPLANs and OPORDs. When participating in the process, the division must ensure the higher-level OPLAN and OPORD is considered to ensure any priorities, milestones, or special processes are an integral part of the OPORD. Figure 5-1, found on page 5-3, provides a template of the type of information which should be considered or included in OPLANs and OPORDs and is discussed later in this chapter.

5-3. Effective HR planning and operations requires HR providers to have a firm understanding of the full capabilities of HR units and organizations. This understanding allows the HR provider to better anticipate requirements and inform the commander. HR providers must understand how to employ doctrine in any operational area and be technically competent in the current HR systems, processes, policies, and procedures required to support Soldiers and commanders engaged in support of range of military operations.

5-4. HR staff at every command level performs HR planning and operations. HR planning and operations are conducted by the HROB within the ESC and the SUST BDE, the HR company, and by all divisions within the HRSC. HR planning and operations is a continual process supporting a commander's ability to exercise mission command. HR planning and operations requires an understanding of how HR support is delivered in the operational environment. The need for collaboration with other staff elements, HR planners, and HR providers is necessary in order to maximize HR support across operational lines. Activities of the operations process include:

- **Plan:** Making plans which support the operational mission and providing commanders with options on how best to use HR assets within their organizations. The HR planner focuses on translating the commander's visualization into a specific COA.
- **Prepare:** Preparing and setting the conditions for success requires an understanding of the operational area. HR providers anticipate requirements and set into motion activities which allow the force to transition to execution.
- **Execute:** Making execution and adjustment decisions to exploit opportunities or un-forecasted requirements providing commanders with the flexibility required to be proactive.
- **Assess:** Continual assessment in the AO allows the HR provider to learn and adapt as new information becomes available which provides a clearer picture of the operational area.

5-5. The Plans and Operations Division provides the HRSC Director with management capabilities for operational requirements and planning for both long and short range HR operations. The division develops and maintains internal HR plans and policies for training HR organizations. It also manages internal deployment plans and contingency operations, as well internal mission support, plans, and execution of HR operations. Throughout the planning process, HR planners must consider the relief in place (RIP) and transfer of authority (TOA) process along with the ROA in determining the required resources and capabilities to execute HR operations. See Appendix A for additional information on the HR RIP and TOA process and checklist. Appendix B provides ROA information for SRC 12 HR organizations.

PLANNING HORIZONS

5-6. In general, planning horizons are points in time the commander uses to focus the organization's planning efforts to shape future events. Planning horizons measure from weeks or months to hours or days. Organizations often plan within several different planning horizons simultaneously. As depicted in Figure 5-1, found on page 5-3, commanders use three planning horizons to guide their planning efforts—short-range, mid-range, and long-range.

5-7. The variable commanders utilize to focus subordinate planning efforts is certainty. A high degree of relative certainty provides the means for commanders and staffs to develop a conceptual basis for action, assign resources, and commit to a particular plan. Typically, the further away in time the event is, the lower the degree of certainty. In situations involving lower degrees of certainty, commanders focus on planning for several different COA possibilities. Resources are programmed, but not committed to a particular COA or plan. See ADRP 5-0, *The Operations Process*, for more information on planning horizons.

SHORT-RANGE PLANNING AND EXECUTION

5-8. Short-range planning and execution focuses on conditions of relative certainty and on the immediate future - this may be hours or days. Short-range planning occurs when commanders believe they can reasonably forecast events, assign resources, and commit to a particular plan. Short-range planning directs the physical preparations necessary for action such as staging supplies, task organizing, and positioning of logistics resources for execution. It may involve representatives from all warfighting functions or include only selected staff members and the commander. Who participates depends on the problem's complexity and available time. Short-range planning results in an OPORD or FRAGORD.

MID-RANGE PLANNING

5-9. Mid-range planning focuses on conditions of moderate certainty and occurs when commanders plan for several different COA possibilities without committing to any one. Units and resources are programmed—but not physically committed—for several projected circumstances under conditions of moderate certainty. Developing branches and sequels is normally the focus of mid-range planning.

Note: Distinguishing between short-range and long-range planning horizons and assigning staff responsibilities for them is relatively straightforward. The planning horizon between them poses a greater challenge. Mid-range planning addresses contingencies within the current phase. Its time horizon may reach out days, weeks, or months, depending on the type of operation. Mid-range planning includes branch planning and refinement of orientation planning products, such as branches in concept form.

LONG-RANGE PLANNING

5-10. Beyond the mid-range planning horizon, the situation is too uncertain to plan for specific contingencies. Commanders develop broad concepts addressing a number of different circumstances over a longer time period. This orientation planning allows them to respond quickly and flexibly to a broad variety of circumstances. Developing OPLANs in concept form for several scenarios in the distant future is an example of orientation planning.

5-11. The commander assigns responsibility for planning based upon the degree of certainty or uncertainty. Figure 5-1 captures the essence of plans and operations synchronization.

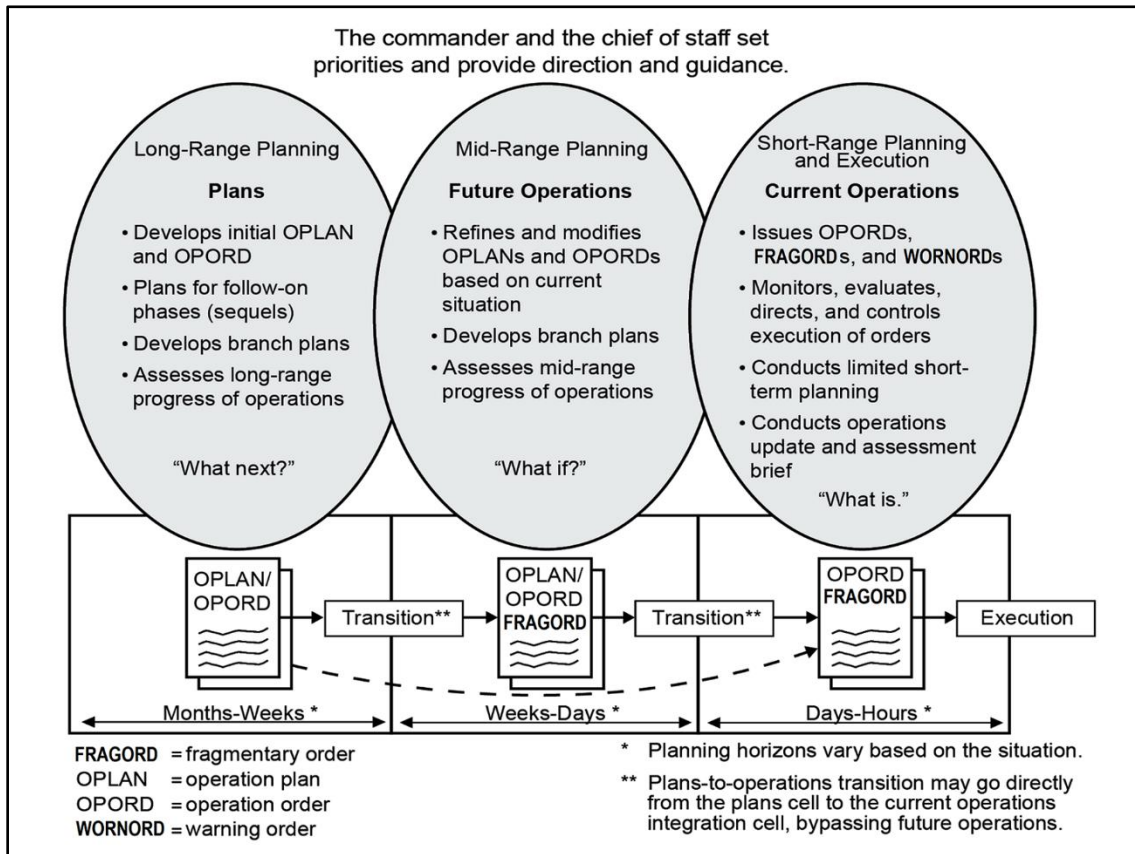

Figure 5-1. Plans and operations synchronization

ESC PARALLEL AND COLLABORATIVE PLANNING

5-12. Essential to the seamless flow of supplies, materiel, and personnel throughout the theater is the parallel and collaborative planning occurring between the TSC and ESC. Parallel and collaborative planning promotes situational understanding, enables unity of effort, and is essential for the successful execution of mission command. TSC plans officers work within several different planning horizons simultaneously – from a theater-wide perspective; anticipating requirements before they occur rather than responding to events as they unfold. Mission orders provide the “what” and “why”; however, leave the “how” for subordinate commanders to develop and provide the basis for planning efforts.

5-13. The ESC may also engage in parallel planning with its supported Army forces in its specified AO or JOA. This planning is then coordinated with the TSC HQs planners in order to ensure synchronized support to the maneuver commander.

5-14. This parallel and collaborative planning effort provides ESC plans officers enough time to adequately develop regionally-focused supporting and/or contingency plans for their AO or JOA and permits the TSC commander to focus decision making on broader theater-wide issues.

HRSC, PLANS AND OPERATIONS DIVISION RESPONSIBILITIES

5-15. The Plans and Operations Division provides the HRSC Director the capability to manage current operational requirements and planning for long and short range HR operations across the theater. Specific responsibilities of the division include, but are not limited to the following:

- Provides long and short range planning for the execution of HR tasks supported by HR organizations (for example; casualty operations, PA, and postal operations).
- Develops and maintains internal plans and policies for training.
- Analyzes personnel strength data to determine current capabilities and assists in projecting future requirements.
- Tracks force flow and monitors down-trace HR organizations deployment plans, deployment preparations, and support of contingency operations in the allocated AO.
- Manages internal deployment plans, physical security, and contingency operations.

5-16. The duties and responsibilities for personnel assigned to the division include, but are not limited to the following:

- Division Chief:
 - Synchronizes and coordinates all HR operational missions with the ASCC, TSC, and ESCs.
 - Oversees the execution of all HR plans and operations in theater.
 - Synchronizes and coordinates with the HRSC, Headquarters Section and divisions and on all required missions.
 - Organizes internal and external support requirements for the HRSC, Headquarters Section and divisions.
 - Provides technical guidance and support to HR organizations as required.
- HR Technician:
 - Serves as technical advisor to the Plans and Operations Division Chief and all HR operational matters.
 - Oversees the execution of all plans and operations in theater.
 - Provides technical guidance, training, and oversight to HR organizations (internal and external) as required.
- Chief HR Sergeant:
 - Senior enlisted advisor to the Division Chief.
 - Assists the Division Chief in establishing plans and operations.
 - Assists the Division Chief in establishing the plans and operations SOP.
 - Advises and briefs the HRSC Director, ASCC G-1/AG, and commander on plans and operations information.
 - Maintains communications with all divisions of the HRSC and ESC and SUST BDE HROBs to assist in planning and resourcing HR operations.
 - Assists HR organizations in meeting training and readiness requirements and operating procedures.
 - Monitors all morale, welfare, and quality of life issues for the division.
 - Monitors unit and enlisted personnel training.
 - Administers and monitors the unit NCO development program and low-density functional training.
 - Receives and orients newly assigned enlisted personnel within the division.
- Wheeled Vehicle Mechanic:
 - Maintains unit wheeled vehicles and generators.
 - Provides vehicle status reports to the Chief, HR Sergeant.
- Plans Officer, Team A and B:
 - Oversees the execution of all plans and operations in theater.
 - Coordinates with the HRSC, Headquarters Section and divisions on all matters as appropriate.
 - Organizes internal support requirements for the division.
 - Provides guidance and support to HR organizations as required.
- Operations Sergeant, Team A and B:
 - Executes plans and operations to HR organizations.

- Organizes HR internal support requirements within the division.
- Assists with maintaining communications with all divisions of the HRSC and ESC and SUST BDE HROBs to assist in planning and resourcing HR operations.
- Assists HR organizations in meeting training and readiness requirements and operating procedures.
- HR Sergeant, Team A and B:
 - Assists with the execution of plans and operations to HR organizations.
 - Provides internal HR support requirements within the division.
 - Assists with maintaining communications with all divisions of the HRSC and ESC and SUST BDE HROBs to assist in planning and resourcing HR operations.
 - Assists HR organizations in meeting training and readiness requirements and operating procedures.
- HR Specialist, Team A and B:
 - Assists with the execution of plans and operations with HR organizations.
 - Provides internal support to the division.
 - Assists the HR Sergeant in the execution of HR operations.
 - Performs administrative duties in relation to internal operations.

ELEMENTS OF HR PLANNING

5-17. *Planning* is the art and science of understanding a situation, envisioning a desired future, and laying out effective ways of bringing that future about (ADP 5-0).

MISSION ORDERS

5-18. Mission orders follow the five-paragraph format (situation, execution, sustainment, and command and signal) and are as brief and simple as possible. Mission orders clearly convey the unit's mission and commander's intent. They enable subordinate commanders to understand the situation, their commander's mission, concept of operations, intent, and their own mission, and begins the mission command process which is the Army's preferred method. The commander's intent and concept of operations establishes guidelines to provide unity of effort while allowing subordinate commanders to exercise initiative in planning, preparing, and executing deployment and sustainment operations. Mission orders emphasize the tasks required by subordinate commands as well as the context and purpose of the tasking.

RUNNING ESTIMATE AND PLANNING CONSIDERATIONS

5-19. The *running estimate* is the continuous assessment of the current situation used to determine if the current operation is proceeding according to the commander's intent and if planned future operations are supportable (FM 1-0). The commander and each staff section maintain a running estimate. In their running estimates, the commander and each staff section continuously consider the effects of new information and update accordingly.

5-20. Effective plans and successful execution hinge on current running estimates. Running estimates always include a recommendation for anticipated decisions. During planning, commanders use these recommendations to select feasible COAs for further analysis. During preparation and execution, commanders use recommendations from running estimates in decision making. Failure to maintain running estimates may lead to errors or omissions resulting in flawed plans or bad decisions.

5-21. Building and maintaining running estimates is a primary task of HR planners. HR planning considerations are essential in determining what an HR planner tracks as part of a running estimate and what input is required in order to support sustainment operations. Running estimates are developed, revised, updated, and maintained continuously. In their running estimates, HR planners continuously consider the effects of new information and update the following:

- Facts.
- Assumptions.

- Enemy activities.
- Civil considerations.
- Conclusions and recommendations.

HR PLANNING USING THE MILITARY DECISIONMAKING PROCESS (MDMP)

5-22. The MDMP facilitates collaborative planning which is vital in the collection and processing of key HR information and may be adapted by HR planners for their own organization or purposes. HR planning is a continuous process evaluating current and future operations from the functional perspective of the HR provider. Refer to ADRP 5-0 for detailed guidance on the MDMP.

5-23. Each staff officer responsible for HR planning has an obligation to be thoroughly familiar with the MDMP and risk management process. The MDMP consists of seven steps, and the risk management process consists of five steps. Each step of the MDMP has various inputs, a method for conducting each step, and outputs which lead to increased understanding of the situation facilitating continued planning. The detail of each step is dependent on time, resources, experience, and the situation. The MDMP is a time consuming process conducted in a detailed and deliberate process when time allows. See ATP 5-19, *Risk Management*, for a more detailed illustration of MDMP and the risk management process alignment.

5-24. Throughout the MDMP, the HR staff planner should consider how information impacts HR support in each phase of a military operation. While HR support is conducted in all range of military operations, HR planners must consider the frequency of occurrence for HR tasks in support of the range of military operations (for example; offense, defense, stability, or defense support of civil authorities). During offensive operations, units focus on casualty reporting and PA, while other tasks are accomplished as the situation permits.

5-25. To be effective in the planning process, it is important for HR staff planners to track the current operation and influence the operation with additional HR support. By remaining engaged with the operation and maintaining situational awareness, HR staff planners can better support the execution of their HR mission. HROBs must remain engaged and integrated with the ESC and SUST BDE staffs in order to influence HR support to supported organizations (G-1/AGs) and to provide direction and guidance to the HR assets in their organization.

5-26. Generally, the ability to accomplish the full range of casualty operations, PA (by-name), and postal operations are not embedded within division and above organizations. However, division and above organizations still have the ability to influence these activities within their commands. As such, division and above organizations have a responsibility to coordinate or synchronize external casualty operations, PA, and postal operations support with the supporting ESC or SUST BDE HROBs. If the SUST BDE HROBs are not able to support requirements with assigned HR units, forward requests to the ESC HROB or the HRSC for resolution. This enables HROBs at each echelon to assist supported units and enables them to adequately plan, track the location, resourcing, and capabilities of supporting HR companies, HR platoons, and teams. Figure 5-2, found on page 5-7, depicts the steps of the MDMP.

Key inputs	Steps	Key outputs
<ul style="list-style-type: none"> Higher headquarters' plan or order or a new mission anticipated by the commander 	<p>Step 1: Receipt of Mission</p>	<ul style="list-style-type: none"> Commander's initial guidance Initial allocation of time
Warning order		
<ul style="list-style-type: none"> Higher headquarters' plan or order Higher headquarters' knowledge and intelligence products Knowledge products from other organizations Army design methodology products 	<p>Step 2: Mission Analysis</p>	<ul style="list-style-type: none"> Problem statement Mission statement Initial commander's intent Initial planning guidance Initial CCIRs and EEFI Updated IPB and running estimates Assumptions
Warning order		
<ul style="list-style-type: none"> Mission statement Initial commander's intent, planning guidance, CCIRs, and EEFI Updated IPB and running estimates Assumptions 	<p>Step 3: Course of Action (COA) Development</p>	<ul style="list-style-type: none"> COA statements and sketches <ul style="list-style-type: none"> Tentative task organization Broad concept of operations Revised planning guidance Updated assumptions
<ul style="list-style-type: none"> Updated running estimates Revised planning guidance COA statements and sketches Updated assumptions 	<p>Step 4: COA Analysis (War Game)</p>	<ul style="list-style-type: none"> Refined COAs Potential decision points War-game results Initial assessment measures Updated assumptions
<ul style="list-style-type: none"> Updated running estimates Refined COAs Evaluation criteria War-game results Updated assumptions 	<p>Step 5: COA Comparison</p>	<ul style="list-style-type: none"> Evaluated COAs Recommended COAs Updated running estimates Updated assumptions
<ul style="list-style-type: none"> Updated running estimates Evaluated COAs Recommended COA Updated assumptions 	<p>Step 6: COA Approval</p>	<ul style="list-style-type: none"> Commander-selected COA and any modifications Refined commander's intent, CCIRs, and EEFI Updated assumptions
Warning order		
<ul style="list-style-type: none"> Commander-selected COA with any modifications Refined commander's intent, CCIRs, and EEFI Updated assumptions 	<p>Step 7: Orders Production, Dissemination, and Transition</p>	<ul style="list-style-type: none"> Approved operation plan or order Subordinates understand the plan or order
CCIR commander's critical information requirement COA course of action		EEFI essential element of friendly information IPB intelligence preparation of the battlefield

Figure 5-2. The military decisionmaking process (MDMP)

RAPID DECISIONMAKING AND SYNCHRONIZATION PROCESS

5-27. The rapid decisionmaking and synchronization process is a decision making and synchronization technique commanders and staffs commonly use during execution. While identified here with a specific name and method, the approach is not new; its use in the Army is well established.

5-28. Commanders and staffs develop this capability through training and practice. When using this technique, the following considerations apply:

- Rapid is often more important than process.
- Much of it may be mental rather than written.
- It should become a battle drill for the current operations integration cells, future operations cells, or both.
- How much of the technique is explicitly performed varies by echelon and the time available.

5-29. The rapid decisionmaking and synchronization process focuses on synchronizing actions and understanding relationships within staffs as well as among commanders. Leaders can use it with or without a staff and interagency and multi-national environments.

5-30. It is based on an existing order and commander's priorities as expressed in the order. The most important of these control measures are the commander's intent, concept of operations, and CCIRs. The rapid decisionmaking and synchronization process includes five steps:

- Compare the current situation to the order.
- Determine a decision, and what type, is required.
- Develop a COA.
- Refine and validate the COA.
- Implement.

(Note: The first two steps may be performed in any order, including concurrently. The last three steps are performed interactively until commanders identify an acceptable COA).

5-31. The rapid decisionmaking and synchronization process seeks a timely and effective solution within the commander's intent, mission, and concept of operation. This process lets leaders avoid the time-consuming requirements of developing decision criteria and comparing COAs. It is a continuous process and does not tie to the battle rhythm.

HR INPUT TO OPERATIONS ORDERS

5-32. FM 6-0, *Commander and Staff Organization and Operations*, provides the format for an OPLAN and OPORD. As depicted in Figure 5-3, found on pages 5-10 thru 5-12, the sample OPLAN and OPORD format has been modified to integrate the warfighting functions. HR staff planners must understand that Tab A (HR Support) to Appendix 2 (Personnel Support) of Annex F (Sustainment) describes the concept of HR support and communicates directives to subordinate commanders and staffs. HR planners use their running estimate, HR planning considerations, and HR synchronization matrix to support the development of the OPORD.

5-33. List unit, location, and functional area support provided by supporting unit. All may not apply:

- HRSC.
- TG PAT.
- MMT team.
- HROB, ESC, or SUST BDE.
- HR company HQs.
- Postal platoon.
- HR platoon (include PATs and CLTs).

5-34. HR planners, when developing their portion of the OPLAN and OPORD, need to address the following core competencies that apply during the operations process:

- Man The Force:
 - Personnel Readiness Management (personnel augmentation and manning requirements-stop move; priority of fill; individual Soldier readiness; replacement operations; cross-leveling guidance; and key leader and crew replacements).

- Personnel Accountability (system of record; initial manifesting and processing; support provided by PATs; guidelines for reporting; accountability of CAAF and other Civilians; location of PAT processing sites; processing tasks and roles; and data integration).
- Strength Reporting (timeline; reporting format; and PERSTAT or Joint PERSTAT instructions).
- Casualty Operations (initial casualty reporting; location of CLTs; reporting system and format; reporting timelines; and release authority for reports).
- Personnel Information Management (data integration; database hierarchy; and software requirements).
- Provide HR Services:
 - Essential Personnel Services (CACs and ID tags; awards authority and processing; promotion processing; military pay and entitlements; personnel action requests; leaves and passes; R&R guidance and allocation by subordinate unit; close-out evaluation reports; LODs; and other EPS functions as necessary).
 - Postal Operations (Initial restrictions; addresses; supporting postal organization; scheduled delivery and retrograde; APO location and supporting units; retrograde mail; redirect mail; casualty mail; and postal contracting).
 - Casualty Operations (Describe all actions relating to the production, dissemination, coordination, validation, and synchronization of casualty reporting. Information includes submission of casualty reports, notification and assistance to the NOK, LOD determinations, 15-6 investigations, disposition of remains and personal effects, military burial honors, casualty mail coordination, locations of supporting CLTs, casualty estimates (division and above), and timelines).
- Coordinate Personnel Support:
 - Morale, Welfare, and Recreation Operations (initial deployment instructions; American Red Cross support, procedures, and processing; in-country MWR support; and Army Air Force Exchange Service support).
 - Command Interest Programs.
 - Army Music.
- Conduct HR Planning and Operations:
 - Conduct HR Planning and Mission Preparation (HR planning considerations; casualty estimates; track current and future HR operations; redeployment planning; and preparation of OPLANs and OPORDs).
 - Establish HR Mission Command Nodes (communication access, equipment, and NIPRNET and SIPRNET access).

5-35. HR planners continue to evaluate current and future operations from a functional perspective forecasting HR requirements based on the progress of the operation. Figure 5-3, found on pages 5-10 – 5-12, illustrates a sample of the OPLAN and OPORD format utilized within the planning process.

(CLASSIFICATION)	Copy ## of ## copies Issuing headquarters Place of issue Date-time group of signature Message reference number
Include heading if attachment is distributed separately from the base order or higher-level attachment.	
Tab A (Human Resources Support to Appendix 2 (Personnel Services Support) to Annex F (Sustainment) to OPERATION PLAN/OPERATION ORDER [number] [(code name)] [(classification of title)]	
References: ADRP 4-0, ADRP 5-0, FM 1-0, FM 6-0	
Time Zone Used Throughout the Order:	
1. (U) Situation. Include information affecting HR operations that paragraph 1 of the Operation Plan/Operation Order does not cover or that needs to be expanded. <ul style="list-style-type: none"> a. (U) Area of Interest. Refer to Annex B (Intelligence), as required. b. (U) Area of Operations. Refer to Appendix 2 (Operation Overlay) to Annex C (Operations). <ul style="list-style-type: none"> (1) (U) Terrain. List all critical terrain aspects impacting HR operations. Refer to Tab A (Terrain) to Appendix 1 (Intelligence Estimate) to Annex B (Intelligence), as required. (2) (U) Weather. List all critical weather aspects impacting HR operations. Refer to Tab B (Weather) to Appendix 1 (Intelligence Estimate) to Annex B (Intelligence), as required. c. (U) Enemy Forces. List known and template locations and activities of enemy functional area units for one echelon up and two echelons down. List enemy maneuver and other area capabilities impacting friendly operations. State expected enemy COA and employment of enemy functional area assets. d. (U) Friendly Forces. List organizations, their location, and type of HR support provided which supports or impacts the HR operations. List the component HR organization and the specific task each is assigned to support the HR portion of the plan. Summarize their capabilities. Include non-United States military forces, and United States Civilian agencies, such as Red Cross or Army Air Force Exchange Service personnel, which may help friendly forces provide HR support (or they may require support). e. (U) Interagency, Intergovernmental, and Nongovernmental Organizations. Identify and describe organizations in the AO who may be entitled to or receive some level of HR support. List should include the role and responsibilities of each organization which impact HR support during the conduct of the operation. f. (U) Civil Considerations. Refer to Annex K (Civil Affairs Operations), as required. g. (U) Attachments and Detachments. List units attached or detached only as necessary to clarify task organization. h. (U) Assumptions. List any HR specific assumptions which support the annex development. State realistic assumptions and consider the effect of current operations on HR operations. These could be similar assumptions used by the components when developing personnel estimates. 	
2. (U) Mission. State the mission of the HR functional area in support of the base plan or order.	
(CLASSIFICATION)	

Figure 5-3. Sample operation plan/operation order

(CLASSIFICATION)

3. (U) Execution.

a. (U) Scheme of Sustainment Support. Describe how HR operations support the commander's intent and concept of operations. Establish the priorities of support to units for each phase of the operation. Refer to Annex C (Operations), as required.

(1) (U) Man the Force. List any new personnel requirements resulting from the operation (for example, language skills and additional skill identifiers), replacement requisition and forecast, key leader or crews replacements, and other manning guidance affecting the operation.

(a) (U) Personnel Accountability. Describe how by-name management of the location and duty status is affected during each phase of the operation. Information should include the tracking the movement of personnel as they arrive at, and depart from, home station, APOE/APOD, JOA, timelines for reporting changes to duty, and location of supporting PATs.

(b) (U) Strength Reporting. List any information affecting the strength reporting of the unit. Strength reporting is the process of comparing by-name data (faces) against specified authorizations (spaces or in some cases requirements) to determine a percentage of fill. Information should include manning levels, critical military occupational specialty shortage, reporting requirements, timelines, and other information impacting on the operations.

(c) (U) Personnel Readiness Management. Describe personnel readiness issues which impact on current capabilities, future requirements, retention, and current readiness status (deployable and non-deployable) of assigned personnel.

(d) (U) Personnel Information Management. Describe all information affecting the personnel information available to commander to assist them in the decision-making process for HR functions and actions. Information should include the ID of systems, priorities, NIPRNET/SIPRNET connectivity requirements, and system access and system availability.

(2) (U) Provide HR Services. List all HR services which directly impact a Soldier's status, assignment, qualifications, financial status, career progression, and quality of life. Information includes the functions of EPS, postal, and casualty operations.

(a) (U) Casualty Operations. Describe all actions relating to the production, dissemination, coordination, validation, and synchronization of casualty reporting. Information includes submission of casualty reports, notification and assistance to the NOK, LOD determinations, 15-6 investigations, disposition of remains and personal effects, military burial honors, casualty mail coordination, locations of supporting CLTs, casualty estimates (division and above), and timelines.

(b) (U) EPS. List each function supporting individual career advancement and development, proper ID documents, benefits entitlements, recognition of achievements, and service performance. Information should include awards and decorations, promotions, reductions, evaluations, military pay, leaves and passes, separations, LOD investigations, and other HR personnel action requests.

(c) (U) Postal Operations. Describe all information to support efficient postal operations or require significant logistics and planning for issues such as air and ground transportation, specialized equipment, secured facilities, palletization crews, mail handlers, and others. Include postal pickup and drop off times; hours of Operations; special requirements for selling stamps, cashing, and selling money orders; providing registered (including classified up to secret); insured and certified mail services; processing postal claims and inquiries; and other issues which impact mail operations (for example, holiday periods and voting).

(CLASSIFICATION)

Figure 5-3. Sample operation plan/operation order (continued)

(CLASSIFICATION)

(3) (U) Coordinate Personnel Support.

(a) (U) Morale, Welfare, and Recreation. Describe functions affecting MWR recreational and fitness activities, goods, and services. Include information on MWR augmentation, unit recreation, library books, sports programs, rest areas for brigade-sized and larger units and community support programs such as support for American Red Cross, Army Air Force Exchange Service, and the Family support program.

(b) (U) Command Interest Programs. Describe how command interest programs impacts on the operations. Information should include voting, equal opportunity, substance abuse, and Family readiness.

(c) (U) Army Band Operations. Describe how to integrate Band support for troop morale, support for MWR and command interest programs. Information should include support of chaplain services, troop ceremonies, events for community and Family support, and command interest programs.

(4) (U) Conduct HR Planning and Operations. Describe how HR planning and staff operations support the operational mission and the effective ways of achieving success. Include expected requirements and outcomes identified in the MDMP process and in establishing and operating HR nodes.

(a) (U) Tasks to Subordinate Units. List functional area tasks assigned to specific subordinate units not contained in the base order.

(b) (U) Coordinating Instructions. List only instructions applicable to two or more subordinate units not covered in the base order. Identify and highlight any functional area-specific timings, information themes and messages, risk reduction control measures, and environmental considerations.

4. (U) Sustainment. Identify priorities of sustainment for HR key tasks and specify additional instructions, as required. Refer to Annex F (Sustainment), as required.

5. (U) Command and Signal.

a. (U) Command. State the location of HR functional leaders and command relationships.

b. (U) Liaison Requirements. State HR liaison requirements not covered in the base order.

c. (U) Signal. Address any HR-specific communications requirements such as connectivity (NIPRNET/SIPRNET), bandwidth, port accessibility, and hardware setup and systems vulnerabilities. Refer Annex H (Signal), as required.

ACKNOWLEDGE: Include only if attachment is distributed separately from the base order.

[Commander's last name]
[Commander's rank]

The commander or authorized representative signs the original copy of the attachment. If the representative signs the original, add the phrase "For the Commander". The signed copy is the historical copy and remains in the HQs files.

OFFICIAL:

[Authenticator's name]
[Authenticator's position]

ATTACHMENTS: List lower level attachments (for example; appendices, tabs, and exhibits).

DISTRIBUTION: Show only if distributed separately from the base order or higher-level attachments.

(CLASSIFICATION)

Figure 5-3. Sample operation plan/order (continued)

Chapter 6

HR Automation Support

HR systems are essential in accomplishing Army-wide personnel information management and require a team of HR professionals who are competent with automated HR databases and understand how HR functions and tasks are processed or conducted. It is critical to ensure HR personnel are cross-trained on all automated HR databases and systems. Specific automated HR databases and automation systems used by HR professionals, and other automation systems and equipment needed to perform HR missions at theater-level, are discussed in the following paragraphs. In order for HR professionals to conduct required HR functions and tasks, immediate NIPRNET and SIPRNET connectivity should be at the top of a unit's priority list when arriving in theater. Refer to FM 1-0 for more detailed information on HR automation support

HR DATABASES

6-1. The following paragraphs discuss various HR databases used by HR professionals to perform HR missions.

AUTOMATED MILITARY POSTAL SYSTEM (AMPS)

6-2. Connects MPOs and other military postal activities around the world directly to the MPSA via the world-wide web. Instead of relying on telephone messages, e-mails, or other secondhand communication methods, AMPS users can view the information about their MPOs on their own desktops and make changes or corrections to the information themselves. With AMPS, the process of opening a new MPO is easier and takes a considerably smaller amount of time than in the past. The AMPS provides the deployed MPO with the capability to process PS Form 2942 (Military Mail AV7), finance business, postal net alerts, product tracking services, and monitors voting information.

DEFENSE CASUALTY INFORMATION PROCESSING SYSTEM – CASUALTY FORWARD (DCIPS-CF) AND DCIPS – CASUALTY REPORT

6-3. An automated system used to record and report casualty data. The system is employed by HR units; typically CLTs, brigade and brigade-level (STB) S-1 sections, and G-1/AGs performing casualty reporting missions. It is capable of producing automated casualty reports. While not required, battalion S-1s may utilize DCIPS-CF to submit their casualty reports to higher headquarters. When adequate NIPRNET access is available, the web-based component of DCIPS should be used for casualty reporting. Gaining access and configuring the web-based component of DCIPS requires prior coordination with CMAOC and the casualty reporting chain of command. The web-based component of DCIPS is available only on NIPRNET.

6-4. When adequate NIPRNET access is not available, the DCIPS-CF component of DCIPS must be used. It provides a stand-alone capability for units to record and report casualties. Since DCIPS-CF is a stand-alone application, it may be used on the SIPRNET. However, casualty reports created on SIPRNET eventually must be declassified and reentered into DCIPS on the NIPRNET. Brigade, brigade-level (STB) S-1s, and G-1/AGs are required to coordinate with HRC and HRSC before deploying to ensure they have the most current version of DCIPS. Additionally, HR units serving as deployed casualty assistance centers must coordinate with CMAOC to ensure they have access to all required components of DCIPS.

DEFENSE ENROLLMENT ELIGIBILITY REPORTING SYSTEM (DEERS)

6-5. A database maintaining personnel and benefits information for active, retired, and reserve component uniformed Servicemembers; eligible Family members of active, retired, and reserve component uniformed Servicemembers; DOD personnel; and DOD contractors requiring logical access. It verifies eligibility when producing CACs and supports benefit delivery including medical, dental, educational, and life insurance. In addition, DEERS enables DOD e-business, including identity management, reduces fraud and abuse of government benefits, and supports medical readiness. Key information to remember:

- HR personnel can contact the DEERS Help Desk or consult the DEERS frequently asked questions published on the TRICARE website.
- All DEERS content that comes from AKO is encrypted and secure. (Note: Information is not stored on AKO. It is retrieved and displayed when accessing the DEERS service).
- The TG PAT must ensure the RAPIDS deployable workstation accompanies troop deployment and not shipped by boat to keep operations active and systems updated for the first 30 days.

DEPLOYABLE REAL-TIME AUTOMATED PERSONNEL IDENTIFICATION SYSTEM (RAPIDS)

6-6. The deployable RAPIDS workstation is a laptop version of a fixed RAPIDS workstation designed for use in both tactical and non-tactical environments. It provides DEERS updates and issues CACs to Soldiers at home station or in a deployed environment. The deployable workstation also provides the user with a CAC personal ID number reset capability. This system works only when connected to DEERS and has the same operational capability as the standard desktop version of the RAPIDS workstation.

TACTICAL PERSONNEL SYSTEM (TPS)

6-7. A stand-alone database providing an ad hoc ability to create a temporary system to account for unit personnel. It has limited ability to perform robust PA or strength reporting. HR professionals use TPS primarily to create manifests for transportation by air. TPS is capable of producing automated manifests that can be loaded in Air Force manifesting systems and DTAS. Key information to remember:

- Generates deployment, redeployment, and aircraft manifests.
- Automatically builds a deployed personnel database.
- Provides queries on deployed personnel.
- Interfaces with the RAPIDS, Air Mobility Command, and Global Transportation Network.
- Generates transfer files which are up-loadable to populate DTAS.

THEATER FORCE TRACKER

6-8. Provides a database of all units who are or have been deployed to theater and is available on SIPRNET. It is a web-based application supporting United States Army Central, the Army's component of United States Central Command. It is a developed application providing a picture of units and detachments supporting the United States Central Command theater of operations. The Theater Force Tracker leverages data from authoritative Army databases to provide a comprehensive inventory of the units supporting the mission. This information allows the command to monitor force assignments and plan for unit rotations to ensure the command has the right forces in theater to perform the United States Army Central's mission.

HR AUTOMATION SYSTEMS

6-9. The following paragraphs discuss various HR automation systems for HR support. All HR systems, with the exception of DTAS, operate in NIPRNET.

ARMY DISASTER PERSONNEL ACCOUNTABILITY AND ASSESSMENT SYSTEM

6-10. A web-based, user friendly application designed to augment the disaster accountability process by aiding in the determination of the statuses and whereabouts of all Army affiliated personnel (military, DA Civilians, Nonappropriated Fund employees, and CAAF) and their Family members when directed by the Secretary of Defense. It is the official tool for personnel accountability in conjunction with natural or

manmade disasters. The information in the system provides DOD and Army leadership a means of determining the status of Army personnel and Family members in an affected area and facilitates the decisions on allocating resources for recovery and reconstitution. The Army Disaster Personnel Accountability and Assessment System meets the policy requirements outlined in DODI 3001.02 and CJCSM 3150.13C which requires each Service component to provide the most expeditious accountability of designated personnel categories following a disaster.

DEPLOYED THEATER ACCOUNTABILITY SYSTEM (DTAS)

6-11. Establishes and maintains PA in a JOA. It is a classified system fielded to all HR commanders, personnel, and organizations and is separated into three distinct levels: Mobile, Major Command, and Enterprise. It provides reliable, timely, and efficient accountability for Soldiers, DOD Civilians, CAAF, and foreign nationals. DTAS provides this by enabling commanders at all echelons the ability to track their personnel by name, unit, location, and date. It also allows commanders to track their personnel while in-transit, populating duty status changes by synchronizing to the major command system. The major command system transfers historical records to the Enterprise server daily. This capability is critical for immediate and future operations. Key information to remember:

- Key reports include gains and losses, in-transit, PERSTAT, and unit rosters.
- Prior to deployment, provide a copy of the HR authorization report to the supporting HRSC.
- Reconciliation is required between DTAS and eMILPO.

ELECTRONIC MILITARY PERSONNEL OFFICE (eMILPO)

6-12. A web-based application designed to provide the Army with a reliable, timely, and efficient method for performing personnel actions, PA, and strength reporting. eMILPO is utilized by S-1s at all levels and is the mechanism for updating active duty Soldier information at the top of the system. eMILPO transactions establish or update the Total Army Personnel Database (TAPDB) and ultimately (daily) the Integrated TAPDB at HRC. eMILPO modules allow users, HR managers, and commanders visibility of the location, status, and skills of their Soldiers from HQs, Department of the Army-level down to unit-level.

6-13. The Enterprise Datastore (commonly referred to as Datastore) provides snapshots of personnel data across the eMILPO database to support logical and decision-making needs for users within the total Army hierarchy. Daily updates ensure the data is accurate, reliable, and available in a timely manner.

ENLISTED DISTRIBUTION AND ASSIGNMENT SYSTEM (EDAS)

6-14. EDAS is a real-time, interactive, automated system which support the management of the enlisted force. Assignment and distribution managers at HRC use EDAS to create requisitions and process assignments, to create and validate requisitions, and to add or modify requisitions. EDAS also provides enlisted strength management information.

6-15. WebEDAS provides access to the same source information provided to the Army personnel community in EDAS. The information is static and updated on a daily basis. The system provides access to summary reports, requisition reports, personnel information, assignment information, and a data dictionary lookup function.

HUMAN RESOURCES COMMAND IDENTITY MANAGEMENT SYSTEM

6-16. A web-based application used by unit administrators to request access to HRC controlled databases and automated systems (does not support requests for eMILPO access).

INTERACTIVE PERSONNEL ELECTRONIC RECORDS MANAGEMENT SYSTEM (iPERMS)

6-17. The repository of the Army military HR record legal artifacts for all components. The Army military HR record contains a copy of all permanent documents. Documentation must be placed into the Soldier's Army military HR record IAW AR 600-8-104, *Army Military Human Resource Records Management*. For Family members, accuracy of information is critical for NOK notification.

REGIONAL LEVEL APPLICATION SOFTWARE

6-18. The Regional Level Application Software is used by the USAR and is a client-server web-enabled application for the management of personnel and resources. It is used to show overall readiness posture of the unit by Soldier and generates TAPDB-Reserves transactions and electronically transmits the data to HRC.

STANDARD INSTALLATION/DIVISION PERSONNEL SYSTEM

6-19. The Standard Installation/Division Personnel System performs functions similar to those performed in eMILPO for the active component. It is the Army National Guard's database of record for personnel, in which, each of the 54 States and Territories maintains its own database. Each State transmits their updates to the National Guard Bureau who loads these State-level changes into TAPDB-Guard.

TOTAL OFFICER PERSONNEL MANAGEMENT INFORMATION SYSTEM (TOPMIS)

6-20. TOPMIS is used for officer and warrant officer information retrieval and data query functionality. TOPMIS has two subsystems: TOPMIS-II and Electronic TOPMIS.

6-21. TOPMIS-II is a Microsoft Windows-based program, intended to provide users with friendly point and click screens, and easy access to data. TOPMIS-II, with its web-based interface, allows users' real-time access via the Internet from any location world-wide. TOPMIS-II also updates all officer and warrant officer records for selected data points. Deploying units must ensure Soldiers request access from HRC and have receive the prerequisite training on TOPMIS-II. The web application called CITRIX is required before TOPMIS-II can be accessed. HR Soldiers can request passwords simultaneously for both CITRIX and TOPMIS-II. Assignment and distribution managers at HRC use this system to create and validate requisitions and process assignments for officers. It is also used by the HQs, Department of the Army, Army commands, and Installations to manage officer strength and distribution and to maintain officer record data on TAPDB – Active Army Officer. Key uses include pulling many different personnel queries, officer strength reports to assist in the production and analysis of unit status reporting and mission essential requirements, viewing officer record briefs, and requests for orders.

6-22. Electronic TOPMIS is a read-only system and also requires access clearance. It allows users the opportunity to pull officer and warrant officer information, such as promotion orders and request for orders. Additionally, users are able to retrieve senior enlisted promotion orders from this system.

OTHER AUTOMATION SYSTEMS AND EQUIPMENT

6-23. The following paragraphs discuss other automation systems and equipment needed to support HR missions.

ARMY BATTLE COMMAND SYSTEM (ABCS)

6-24. Integrates the mission command system found at each echelon, from ground force component commanders at theater or joint-level to the individual Soldier or weapons platform. ABCS supports the mission by integrating the automation systems and communicates with the functional link at strategic and tactical HQs.

6-25. The Force XXI Battle Command, Brigade and Below is a major component of ABCS and supports lower-echelon battle command tactical mission requirements such as:

- Real-time situational awareness for commanders, staff, and Soldiers.
- Integrated logistics support.
- Graphical displays with friendly and enemy unit locations.
- Common operational picture of the operations area.

BATTLE COMMAND COMMON SERVICES

6-26. A suite of servers forming the hub for the network of ABCS systems. It provides the tactical mission command and enterprise servers, services, and large-volume data storage for commanders and staffs at

battalion through ASCC levels, and attaches to the tactical local-area network via Ethernet and joint network node topologies. Essential enterprise services include e-mail, asynchronous collaboration and file storage, and data-basing. Data residing on the tactical local-area network is stored in a fabric attached storage device which is part of the server suite.

BATTLE COMMAND SUSTAINMENT SUPPORT SYSTEM

6-27. The Army's logistics mission command automation system which aligns sustainment, in-transit, and force data to aid commanders in making critical decisions. This system capability provides operators the COP in the form of total asset visibility to quickly and efficiently see the status of selected critical items. It provides a visual of the operational area through a map centric display. The system's software is capable of running on classified or unclassified networks. It provides the ability to plan, rehearse, train, and execute on the same system. The system provides sustainment and movement information for command decisions by displaying current status and the tools to determine future projections of fuel, ammunition, critical weapons systems, and personnel. It integrates actionable data from numerous available ABCS and the Standard Army Management Information System to support mission command. The Battle Command Sustainment Support System is fielded at every echelon from theater through the brigade and supports predictive sustainment based on the impact of dues-in and the status of combat essential items such as fuel, ammunition, weapons systems, and personnel. It has four main functional features which, together with medical and movement information, encompass the overall logistics COP.

COALITION-LOCAL AREA NETWORK AND COALITION-WIDE AREA NETWORK

6-28. Coalition networks establish support coordination and collaboration among United States and non-United States forces in an operational environment. These services support planning and execution of operations involving coalition forces. They operate at both unclassified and classified levels. They may operate as local or limited regional entities, or they may connect to and extend the services of the combined enterprise regional information exchange system which is a standing classified-capable coalition network.

COMMAND POST OF THE FUTURE

6-29. First introduced as a transformational technology in support of Operation Iraqi Freedom, Command Post of the Future is a software capability hosted on a computer system that currently provides collaboration and visualization for Army division and brigade commanders and staff. This software provides a collaborative operating environment, voice over internet protocol, a highly intuitive, graphical user interface and enhanced briefing capabilities. It allows commanders from battalion-level and higher to feed real-time situational awareness into the system and have information available in text and graphic representation immediately by fellow commanders and staffs at all levels. Inside the system network operators can visualize the commander's intent and COP as well as manipulate tactical data in a collaborative manner alone or with other operators. Command Post of the Future is a valuable planning and management tool allowing commanders to access real-time situational awareness. It eliminates the need for a physical tactical operations center by providing a virtual one through collaboration in a distributed operating environment.

6-30. Command Post of the Future provides new capabilities for improving decision making to operational commanders by providing dynamic tailored visualization and collaboration tools for improved situational awareness and COA development and dissemination. It also enables a new concept for future command environments, namely, the elimination of the fixed command post to be replaced by mission command on the move.

COMBAT SERVICE SUPPORT AUTOMATED INFORMATION SYSTEMS INTERFACE

6-31. A high data rate, sensitive but unclassified wireless local area network. Accepts information from automation devices interfacing over military communication networks (for example; satellite communications, Defense Data Network, Defense Switching Network, Very Small Aperture Terminal, United States public switched networks, and commercial communications systems of nations with which the United States has defense agreements). It provides connectivity for network capable to the Standard Army

Management Information System through a 12 port 10Base2 multi-port wireless device module. The three components are: Bridge module, Client module, and a System Support Representative.

DEFENSE CONNECT ONLINE

6-32. A web conferencing and instant messaging capability. Major components are the Defense Connect Online Portal, Adobe's Acrobat Connect web conferencing tool, and Jabber Instant Messaging with presence and awareness. Connect meetings with screen-sharing, white boarding, integrated voice over internet protocol, and multi-person video help with information dissemination and shared situational awareness. Participants can collaborate in an informal, highly interactive manner with shared screens, applications, images, and documents.

FORCE XXI BATTLE COMMAND, BRIGADE AND BELOW

6-33. A suite of digitally interoperable applications and platform hardware. Its design provides on-the-move, real-time, and near-real-time situational awareness as well as mission command information to sustainment leaders from brigade to the platform and Soldier-level. The Force XXI Battle Command, Brigade and Below is a mission essential sub-element and a key component of the ABCS. It feeds the ABCS common database with automated positional friendly information and current tactical battlefield geometry for friendly and known or suspected enemy forces. Common hardware and software design facilitates training and SOPs.

FORCE MANAGEMENT SYSTEM WEBSITE

6-34. The official repository for Army (NIPRNET/CAC access) decisions on mission, organizational structure, personnel and equipment requirements, and authorizations for Army units and Army elements of joint organizations for the current year through the first program year. The website maintains the HQs, Department of the Army approved authorization documents (for example; modified Table of Organization and Equipment, Table of Distribution and Allowances, and Common Tables of Allowance) and staffing documents for review and coordination with commands, installations, and units.

FORCE REQUIREMENTS ENHANCED DATABASE

6-35. The Force Requirements Enhanced Database is a historical database for mobilized units. It is the system by which all United States Central Command Units Request for Forces are submitted, reviewed, approved, disapproved, deleted, and sourced. It provides the sourced unit's mission statement, capabilities, latest arrival date, boots on ground, unit identification code, passengers, and location.

GATEWAY TRACKING SYSTEM

6-36. The theater gateway in the United States Central Command's AO utilizes a stand-alone, local Oracle Software Database, known as the Gateway Tracking System, to maintain visibility of passengers transiting theater.

GLOBAL AIR TRANSPORTATION EXECUTION SYSTEM

6-37. An Air Mobility Command aerial port operations and management information system designed to support automated cargo and passenger processing, the reporting of in-transit visibility data to the Global Transportation Network, and provides the billing to Air Mobility Command's financial management directorate. It is a peripheral system to United States Army PA systems and one of several systems managed under the Gates Enterprise Management System. It does not allow read-only rights, thus the reason the United States Air Force limits access.

GLOBAL COMBAT SUPPORT SYSTEM-ARMY

6-38. The replacement for several of the Army's current Standard Army Management Information Systems. The system tracks supply chain, maintenance, equipment, and financial transactions related to logistics for all Army units. It operates in conjunction with other key systems such as the Battle Command Sustainment

Support System, and provides support personnel detailed information required by the Soldier and the current availability of needed materiel, to include items in the distribution system. The system addresses the Army's current automation dilemma of having stove-piped systems, that is, systems which do not share information horizontally among different functional areas. It employs state-of-the-art technology to include client-server technology designed to take full advantage of modern communications protocols and procedures. This design allows for maximum amount of communications capability and flexibility to take advantage of any available communication systems to include commercial or military, terrestrial, or space-based. The system complies with the defense information infrastructure, common operating environment, and technical and data element standards. The system is also the first Army logistics system which maintains a daily interface with an Army HR system (for example, eMILPO).

GLOBAL COMMAND AND CONTROL SYSTEM-ARMY

6-39. The Army link for ABCS to the Global Command and Control System. It provides a suite of modular applications and information and decision support to Army strategic and operational theater-level planning for theater operations and sustainment. The system supports the apportionment, allocation, logistics support, and deployment of Army forces to combatant commands. Functionality includes: force tracking; host nation and civil military operations support; theater air defense; targeting; military information support operations; mission command; logistics; medical; provost marshal; counter-drug; and personnel status. The system is primarily deployed from corps to division.

JOINT ASSET MOVEMENT MANAGEMENT SYSTEM

6-40. A stand-alone automation system designed to capture movement and location information about deployed forces, United States government employees, and CAAF (including other designated contractor personnel) in specified theaters of operation at transit locations. It has no direct connectivity to local area networks or servers. The system consists of a laptop computer, bar code (CAC) scanner, and ancillary equipment.

JOINT CAPABILITIES REQUIREMENT MANAGER

6-41. The principal DOD tool used by Global Force Managers to capture force capabilities, develop force requirements, and coordinate Global Force Provider Activities.

JOINT PERSONNEL ACCOUNTABILITY RECONCILIATION AND REPORTING

6-42. Develops a process for obtaining personnel visibility of all United States forces in a geographic combatant commander's AO using automation. It leverages existing Defense Manpower Data Center systems and HR expertise of personnel tracking systems, and provides reconciliation and reporting of personnel from multiple DOD sources.

MANEUVER CONTROL SYSTEM

6-43. The primary mission command information source, providing the COP, decision aids, and overlays capabilities to support the tactical commander and staff. This is done via interface with the force level information database populated from the other battlefield automated systems. The system satisfies information requirements for a specific operation, tracks resources, displays situational awareness, effects timely control of current combat operations, and effectively develops and distributes plans, orders, and estimates in support of future operations. It also supports the MDMP.

NONSECURE INTERNET PROTOCOL ROUTER NETWORK (NIPRNET)

6-44. A network of government-owned internet protocol routers used to exchange sensitive unclassified information. It provides access to specific DOD network services and supports a wide variety of applications such as e-mail, web-based collaboration, information dissemination, and connectivity to the world-wide internet. Access to the NIPRNET is obtained through a standardized tactical entry point site or teleport and

is then distributed through an unclassified theater network. The NIPRNET enables a myriad of other reach functions from deployed forces to the sustaining base and lateral collaboration among deployed elements.

SECRET INTERNET PROTOCOL ROUTER NETWORK (SIPRNET)

6-45. Supports critical mission command applications and intelligence functions. It operates in a manner similar to the NIPRNET, but as a secure network. As with the NIPRNET, the SIPRNET provides access to many web-based applications, as well as the ability to send and receive classified information up to SECRET. These applications and capabilities enable the effective planning and execution of plans in a secure environment. The SIPRNET also enables a myriad of reach logistics functions from deployed forces to the sustaining base and lateral collaboration among deployed elements.

SECURE AND NONSECURE VOICE

6-46. Secure and nonsecure voice remains a significant user requirement in all networks. Switched voice service allows connections between and among home station and theater locations. The service includes long haul switched voice, facsimile, and conference calling. Secure voice connections may also be used for facsimile traffic. More networks are now incorporating and employing secure voice over internet protocol instead of the traditional switched circuit requirements. Nonsecure voice provides the essential day-to-day connections used in common, routine business, but also includes requirements to provide connectivity to Civilian telephone networks in the sustaining base and host nation. Additionally, the nonsecure voice network and defense switched network can be extended to joint and multi-national subscribers.

SHAREPOINT

6-47. A web platform developed by Microsoft for small to large organizations. The design is a centralized replacement for multiple web applications, and supports various combinations of enterprise website requirements. SharePoint is highly scalable and is capable of supporting multiple organizations on a single server farm. SharePoint's multi-purpose platform allows managing and provisioning for:

- Intranet portals.
- Extranets and websites.
- Document and file management.
- Collaboration spaces.
- Social networking tools.
- Business intelligence tooling.
- Process and information integration solutions.
- Web application development platform.

SINGLE MOBILITY SYSTEM

6-48. A web-based computer system providing visibility of air, sea, and land transportation assets and provides aggregated reporting of cargo and passenger movements. It does this by collecting plane, ship, and truck movement data from other computer systems such as the Global Transportation Network, Consolidated Air Mobility Planning System, Global Defense Support System, Joint Air Logistics Information System, Air National Guard Management Utility, and the Defense Transportation Tracking System.

SYNCHRONIZED PRE-DEPLOYMENT AND OPERATIONAL TRACKER (SPOT)

6-49. Is the Joint Enterprise Contractor Management and Accountability System and provides SPOT generated CAAF accountability data to the HRSC and ASCC G-1/AG per local command policy. The ASCC G-1/AG is responsible for developing mission specific CAAF accountability and reporting policies. The HRSC, G-1/AGs, and S-1s execute these policies. G-1/AGs monitor the accountability process to ensure subordinate units are properly executing the accountability process. For additional information on SPOT, see JP 4-10, AR 715-9, and ATP 4-10.

TRANSPORTATION COORDINATOR'S AUTOMATED INFORMATION MOVEMENT SYSTEM II

6-50. A joint automated information system for unit moves, installation transportation office, and transportation management office functionality. It provides an integrated traffic management capability and supports deployment, redeployment, and sustainment of United States forces. The system ultimately integrates with unit, installation, and depot-level supply systems to manage inbound and outbound movement, shipment, documentation, and requisition information. The system provides the TSC with an automated capability to forecast the arrival of personnel and inter-theater cargo and containerized shipments, and to maintain visibility of command interest cargo en route to theater. Thereby enhancing TSC capabilities to maintain the intra-theater segment of the distribution system in balance and operating efficiently.

6-51. The Transportation Coordinator's Automated Information for Movement System II provides TSC distribution managers the capability to coordinate and provide transportation services to shippers, carriers, and receiving activities located throughout theater. Automated functions include documenting transportation movement requests, tasking mode operators, forecasting, and reporting container and cargo movements throughout the distribution system. Other capabilities include scheduling and de-conflicting convoy movements, maintaining unit personnel location manifesting data, and maintaining in-transit cargo and asset movement visibility. The system provides mode operators an automated capability to receive commitments, conduct mission planning, task available assets, and maintain fleet asset status data.

TRANSPORTATION COMMAND REGULATING AND COMMAND AND CONTROL EVACUATION SYSTEM

6-52. Provides for inpatient visibility and captures those casualties not reported through normal channels. The system combines transportation, logistics, and clinical decision elements into a seamless patient movement automated information system. It is capable of visualizing, assessing, and prioritizing patient movement requirements, assigning proper resources, and distributing relevant data to deliver patients efficiently. The system automates the processes of medical regulations (assignment of patients to suitable MTFs) and aeromedical evacuation during peace, war, and contingency operations.

TRUSTED ASSOCIATE SPONSORSHIP PROGRAM

6-53. A web-based tool used to gather information to verify eligibility for issuing CACs to CAAF. Contractors who must complete the CAC application can access the data from any computer providing the Trusted Agent or Trusted Agent Security Manager has issued them a system generated user name and password. This provides increased control in who may apply for a CAC, eliminate data re-entry, and provide real-time information about CAAF. (Note: There is a distinction between contractors eligible for a CAC and others needing physical access when issuing local contractor ID cards).

VERY SMALL APERTURE TERMINAL

6-54. A software-driven, small-dish, transportable, satellite terminal used for reliable connectivity. Used in conjunction with the Combat Service Support Automated Information Systems Interface, it permits the receipt and transmission of data and voice over internet protocol via the NIPRNET/SIPRNET from anywhere in the world to anyplace in the world. Together with the Combat Service Support Automated Information Systems Interface, it gives the TSC the communication asset it needs to manage and maintain mission command support across theater. The Very Small Aperture Terminal provides forward deployed sustainment units a communication capability for logistics systems or Standard Army Management Information Systems which are substantially the same as in the garrison environment.

VIDEO TELECONFERENCING

6-55. A mainstay collaboration tool in deployed environments. It offers the best available technical alternative to face-to-face meetings providing users with human-factor feedback and interaction when they must collaborate from separate locations. Video teleconferencing also better facilitates online collaboration and coordination with various automation tools and applications.

This page intentionally left blank.

Appendix A

Relief in Place (RIP) and Transfer of Authority (TOA)

This appendix provides essential core activities during the RIP and TOA process and is crucial to effectively complete requirements necessary for a commander to achieve impending missions while achieving situational understanding. Remind HR planners, when planning RIP and TOA procedures, to read and adhere to the SOPs of higher HQs and to remain open to ideas presented by the outgoing organization.

HR RIP AND TOA PROCESS

A-1. During RIP and TOA operations, all or part of a unit is replaced in an area by the incoming unit at the direction of higher authority. Responsibilities of replaced elements for the mission and the assigned zone of operations transfer to the incoming unit. The incoming unit continues the operation as ordered.

A-2. Completion of the RIP and TOA functions, missions, and actions must occur to effectively complete a RIP and TOA operation. Essential activities include information exchange and data requirements, training requirements, and the coordination necessary for a commander to prepare his or her unit for an impending mission while achieving situational understanding. During the pre-deployment site survey, obtain a copy of the outgoing organization's RIP and TOA after action review, which should suggest areas to be included in the operation.

A-3. Development of an effective RIP and TOA timeline and task list assists in the incoming organization's readiness to take charge of the mission after the RIP and TOA is completed. During the first half, the outgoing organization provides the operational area overview and the incoming organization observes. Midway through the process, the outgoing organization reverses roles with the incoming organization, and the incoming organization assumes responsibility for the operational area (for example, organizations reverse operational roles). RIP and TOA operations primarily enable incoming units and organizations in conducting their analysis of operational and mission variables.

A-4. At a minimum, the following essential core activities should be integrated into the RIP and TOA timeline and completed between the incoming and outgoing units include:

- Outgoing organization conducts operational overview brief to incoming staff.
- Outgoing organization highlights types of missions and roles performed with incoming staff.
- Outgoing organization highlights locations, activities, and contact numbers (if known) for other United States, multi-national, and non-military agencies operating within the area.
- Incoming organization receives copies of all briefings, OPORDs, and FRAGORDs from the last 60 days.
- Incoming unit and organization receive SOPs, continuity books, policies, routine reports and reporting requirements, and recurring events.
- Incoming organization understands location and boundaries of adjacent United States and multi-national forces operating within its AO.
- Incoming organization completes question and answer periods with outgoing staff following all briefings.
- The end state of the RIP and TOA is the incoming organization is oriented on all aspects of current operations within its AO.

RIP AND TOA ACTIVITIES

A-5. This appendix provides a list of RIP and TOA activities to assist the following theater-level HR organizations in assessing the effectiveness of their operation. This list is not all inclusive and should only be used as a guide.

- HRSC, Headquarters Section:
 - Become familiar with publications and organizational SOPs.
 - Establish relationship with reporting liaison elements.
 - Understand and conduct left seat/right seat operations.
 - Maintain and manage the organizational budget.
 - Identify internal support requirements for the HRSC.
 - Hand-receipt all organizations property.
 - Transition all requirements for unit automation equipment and support.
- COD:
 - Become familiar with publications and organizational SOPs.
 - Understand HR casualty operations database functions and purpose of using DCIPS, eMILPO, DTAS, Transportation Command Regulating and Command and Control Evacuation System, EDAS, and TOPMIS-II.
 - Monitor casualty reporting flow on the NIPRNET and SIPRNET.
 - Establish relationship with reporting liaison elements.
 - Review the Combined Information Data Network Exchange daily.
 - Mortuary Affairs - cross reference theater mortuary evacuation point reports.
 - Send report for notifications to CMAOC on incoming very seriously injured, seriously injured, or deceased casualties.
 - Understand and conduct left seat/right seat operations.
 - Review verification casualty resources - DTAS, Enlisted and Officer Record Briefs, Defense Manpower Data Center, SPOT, and the Integrated TAPDB.
 - Import/Upload - enter casualty data into DCIPS.
 - Pull progress reports from MCTs and email to appropriate distribution lists (casualty contacts distribution).
 - Enter casualty data into the main casualty tracker database.
 - Process DCIPS NOK notifications.
 - Update and maintain NOK pending reports.
 - Send NOK reports to reporting agencies and the JMMT.
 - Digitize and arrange all casualty documents in chronological order.
 - Maintain and review reports.
 - Forward NOK casualty reports to the TSC and ASCC.
 - Maintain process for LOD investigation tracker.
 - Understand and utilize the Force Requirements Enhanced Database.
- HR Systems Division:
 - Facilitate network access to staff and establish domain accounts.
 - Manage, operate, and maintain computers; voice over internet protocol phones; printers; Video Teleconference stations; Army Battle Command Systems; and servers.
 - Close trouble tickets over the duration of the deployment.
 - Plan and facilitate the turn over of automation equipment in order to facilitate retrograde.
 - Manage network access to various SharePoint portal sites on SIPRNET, NIPRNET, and the Combined Enterprise Regional Information Exchange that enhances the command's ability to mission command.
 - Evaluate the communications plan for missions.
 - Coordinate a frequency management plan that provides persistent command and control.

- Deliver audiovisual network capability.
- Supervise Video Teleconferences and Battle Update Assessments that provide the command team with an accurate COP.
- Understand and conduct left seat/right seat operations.
- PA Division:
 - Become familiar with publications and organizational SOPs.
 - Establish DTAS accounts.
 - Conduct DTAS training and transition.
 - Conduct Joint PERSTAT training and transition.
 - Receive personnel and equipment at the APOD and/or SPOD.
 - Monitor and assist with employment of DEERS RAPIDS throughout theater.
 - Provide equipment, supplies, services, and life support necessary to achieve readiness for onward movement.
 - Understand and conduct left seat/right seat operations.
 - Establish accountability.
 - Identify host nation support requirements.
- POD:
 - Become familiar with publications and organizational SOPs.
 - Develop annual compliance inspection schedule.
 - Manage AMPS access.
 - Conduct change of COPE/theater postal finance officer.
 - Monitor mail flow for accuracy and timeliness.
 - Establish relationship with reporting liaison elements.
 - Understand and conduct left seat/right seat operations.
 - Maintain and review reports.
- Plans and Operations Division:
 - Determine initial and forecasted support requirements.
 - Understand and conduct left seat/right seat operations.
 - Determine resource requirements (for example, equipment and personnel).
 - Identify and verify supporting elements (for example, units and staff).
 - Determine current status of personnel and equipment.
 - Determine specific PA requirements.
 - Identify external support requirements.
 - Obtain input for developing plans.
- TG PAT:
 - Deploy individuals as part of the early entry element to manage and monitor PA as part of the early entry module.
 - Establish personnel reporting plans, policies, and timelines reflecting detailed reporting procedures and responsibilities (who reports to whom), in coordination with the J-1 combatant command.
 - Maintain connectivity with HRC, reserve component personnel offices, rear detachments (as required), appropriate joint HQs, other Services and federal agencies, and the CONUS replacement center.
 - Understand and conduct left seat/right seat operations.
- MMT Team:
 - Become familiar with publications and organizational SOPs.
 - Monitor mail flow for accuracy and timeliness.
 - Establish relationship with reporting liaison elements.
 - Understand and conduct left seat/right seat operations.

- Maintain and review reports.
- ESC and SUST BDE HROB:
 - Identify supported units (G-1/AG), MMT team, and TG PAT liaisons.
 - Determine HR support required for casualty operations, PA, and postal operations with other sustainment elements.
 - Coordinate and conduct HR unit force tracking and identify excessive overlaps.
 - Deploy early entry element to assist with coordination and monitoring during establishment of the TG PAT and MMT.
 - Understand and conduct left seat/right seat operations.
 - Identify and provide training requirements for supported and supporting units.

HROB SUPPORTING TASKS

A-6. The following supporting tasks are performed by the HROB:

- Plans and Operations:
 - Conduct mission analysis (part of MDMP).
 - Provide planning guidance to HROB personnel.
 - Oversee and provide additional direction, as needed, to staff planning.
 - Determine initial and forecasted support requirements.
 - Determine resource requirements (for example, equipment and personnel).
 - Identify and verify supporting elements (for example, units and staff).
 - Determine needs for additional APOE/APOD.
 - Determine current status of personnel and equipment.
 - Determine specific PA requirements.
 - Identify external support requirements.
 - Obtain input for developing plans.
 - Develop a request for information list and track status of completion.
 - Identify problems areas requiring higher HQs assistance.
 - Update running estimates and HR planning factors.
 - Develop request for additional forces (for example, HR Asset Force Management).
 - Brief HROB concept of support to the SPO section.
 - Establish relationships between supporting and supported organizations within theater.
 - Coordinate with the HRSC for support and technical guidance.
 - Determine theater casualty, PA, and postal requirements.
 - Verify system and database requirements and procedures.
 - Submit requests for additional forces required by mission.
 - Coordinate postal support activities and inspections.
 - Coordinate PAT requirements and PAT SAVs.
 - Track location of PAT assets and operational status.
 - Determine if PATs are required at APODs/SPODs based on daily personnel flow.
 - Track arrival and departure of projected personnel within a 24-hour period.
 - Coordinate status and capabilities with the TG PAT, MMT team, and HR company.
 - Coordinate with appropriate SPO branches and/or sustainment elements for non-HR life support (for example; billeting, food, and transportation).
 - Coordinate with higher and lower HROBs, G-1/AGs, S-1s, and HRSC.
 - Coordinate plans with supporting units and staff elements.
 - Plan and provide support for R&R processing.
 - Coordinate with the Provost Marshal for customs support.
- TG PAT and MMT activities:

- Provide theater PA and postal policies to the TG PAT and MMT.
- Alert TG PAT to changes in theater personnel flow.
- Provide TG PAT with reporting requirements and changes.
- Verify TPS use and linkage to the deployed theater database.
- Receive PERSTAT reports from the TG PAT, MMT, and HR company.
- Provide CCIR requirements, reports frequency, and format.
- Review personnel processing reports.
- Assist in coordination of non-HR support (for example; transportation, billeting, food, and life support).
- Assist in resolving any HR support issues.
- Provide SUST BDE SPO section with current assessment of operations and provide status update to the commander, SUST BDE SPO, and HRSC as required.
- Postal support requirements within the AO:
 - Track location of postal assets and missions.
 - Track the number of days mail is static or undelivered.
 - Track transportation flow from APO to unit.
 - Track number of tons of mail received versus dispatched.
 - Ensure 100% compliance on theater APO inspections.
 - Monitor and/or help establish HR contracting efforts within AO.
 - Receive planning guidance.
 - Verify current support requirements.
 - Monitor future planning options.
 - Coordinate with HR company for platoon assignments and locations.
 - Coordinate with HR company to identify and determine future requirements.
 - Recommend additions or reductions in personnel requirements.
 - Brief commander, SUST BDE SPO, and higher HQs of postal operations status.
- HR company coordination tasks:
 - Determine personnel status of each postal platoon.
 - Gather pro-grade and retro-grade work load data (MMT).
 - Provide requirements and frequency for all postal reports.
 - Manage logistics support for postal platoons.
 - Coordinate with SUST BDE SPO transportation section or unit for moving mail in and out of APOs (when not contracted).
 - Coordinate with SUST BDE SPO logistics section for life support at individual APO sites (when not contracted).
 - Coordinate for augmentation or replacement of postal equipment.
- HRSC POD coordination tasks:
 - Review guidance for distribution and implementation.
 - Add additional instructions as required for ease of use.
 - Distribute technical guidance for all postal elements within the AO.
 - Monitor changes in postal procedures, support, or locations.
 - Establish or change designated mail distribution points.
 - Gather unit G-1/AG and S-1 assessment of postal support received.
 - Identify special postal services for isolated sites.
 - Plan for current and forecasted postal support capabilities.
- Postal reports review:
 - Establish reporting requirements with the HR company Plans and Operations team for the CCIR.

- Provide report elements and format.
- Set reporting channels.
- Set reporting period and submission windows.
- Determine volume of workload.
- Verify personnel and equipment availability.
- Identify trends, problem areas, and shortfalls.
- Develop COAs to offset shortfall or problem areas.
- Assist the postal element in implementing COAs.
- Postal inspections and SAVs of unit mail rooms and APOs:
 - Coordinate with higher HQs HROB or HRSC POD as appropriate, for any policy changes or specific focus areas.
 - Establish inspections plan.
 - Plan for announced and unannounced inspections.
 - Announce inspection plan and schedule.
 - Coordinate with higher HQs, HROB, or HRSC POD for augmentation.
 - Provide inspection results to HR company, HRSC POD, and commander.
 - Assist postal element in correcting or improving deficiencies.
 - Conduct follow up inspections and SAVs as required.
- Assess Postal capabilities:
 - Ensure 100% compliance on theater APO inspections.
 - Monitor and/or help establish HR contracting efforts within AO.
 - Coordinate manning assessment with HR company Plans and Operations section.
 - Coordinate personnel augmentation or force requirement requests.
 - Track personnel requests with higher HROB or HRSC.
 - Coordinate additional support requirements.
- CLT support requirements within the AO:
 - Verify current support requirements.
 - Monitor future planning options.
 - Provide staff with planning guidance.
 - Recommend additions or reductions in personnel requirements.
 - Brief commander and higher HQs of CLT operations status.
- CLT Operations:
 - Receive planning guidance.
 - Track location of CLTs.
 - Track number of casualties reported within a 24-hour period.
 - Proper utilization of the CLT in the Role 3 hospital.
 - Coordinate with HR company for CLT assignments and locations.
 - Coordinate with higher HROB or HRSC for future requirements.
- HR company HQs coordination:
 - Determine CLT personnel status.
 - Determine status of communications equipment and connectivity.
 - Determine CLT workload and future requirements.
- Support for CLTs:
 - Coordinate with the MTF Patient Administration Division for work area and life support.
 - Coordinate with MTF S-6/G-6 for connectivity and maintenance support.
- Receive technical guidance:
 - Receive guidance from the HRSC COD and higher HROB.
 - Review guidance for distribution and implementation.

- Add additional instructions for local requirements or ease of use.
- Distribute technical guidance to appropriate units and elements (HR company for all CLTs, unit G-1/AGs, and S-1s within the AO).
- Assess CLT capabilities and casualty reporting operations:
 - Establish reporting requirement with supporting HR company.
 - Specify data elements and format.
 - Track number and type of reports processed.
 - Establish reporting channels.
 - Specify reporting periods and submission times.
 - Coordinate manning and equipment with higher HQs.
 - Coordinate personnel augmentation or force requirement requests based upon operational and mission variables or MDMP (future operations).
 - Prepare requests for additional personnel and equipment as required.

This page intentionally left blank.

Appendix B

Rules of Allocation (ROA) and Equipment Requirements

This appendix provides ROA information for SRC 12 HR organizations, allowing HR planners to determine required resources to execute the HR concept of support and also determine positioning and command and support relationships. This appendix highlights the basis of issue plan and equipment requirements for SRC 12 HR organizations.

B-1. Figure B-1 and Figure B-2, found on page B-2, depict ROA and equipment requirements for SRC 12 HR organizations.

Title	Allocation Rule	Type
HR Sustainment Center (HRSC)	•1 per Senior Sustainment Command HQs (TSC or ESC)	Existence
Theater Gateway Personnel Accountability Team (TG PAT)	•1 per inter-theater Aerial Port of Debarkation (APOD)	Existence
Military Mail Terminal (MMT) Team	•1 per inter-theater APOD	Existence
Human Resources (HR) Company	•1 per Sustainment Brigade •1 per TG PAT •1 per 3-7 Platoons (HR, Postal, or any combination)	Existence Workload
HR Platoon	•2 per TG PAT	Existence Workload
HR Squad	•.333 per DIV Area (APOD) with transients •.333 per ROLE 3 Hospital •.333 per HRSC Casualty Operations Division •.333 per Corps and Divisions •.333 per Mortuary Affairs Company •1 per 1,800 personnel transiting through an APOD offset by 2 per Theater Gateway PA teams	Workload Existence
Postal Platoon	•4 per MMT •1 per 6,000 supported	Existence Workload
Postal Planning Factors	•2.0 lbs per Servicemember per day (mail volume) •20 foot container = 8,000 lbs •40 foot container = 16,000 lbs	
<input type="checkbox"/> HR rules of allocation enable HR planners to determine the number of HR units required to accomplish the HR mission. <input type="checkbox"/> Rules of allocation are also used in the Total Army Analysis (TAA) system to model operational requirements of units.		

Figure B-1. HR (SRC 12 HR) rules of allocation

HR EQUIPMENT REQUIREMENTS				
LEVEL	VSAT	CAISI	DEERS RAPIDS	ID Tag Maker
Battalion S-1				
Special Troops Battalion S-1		Y		Y
Brigade S-1	Y	Y	Y	Y
HROB (Sustainment Brigade)		Y		
Division G-1/AG	Y	Y		
Corps G-1/AG	Y	Y		
HROC (Corps/Division)		Y		
TSC G-1/AG				
G1 Operations Section		Y		
G1 PASR/PIM Section		Y		
ASCC				
Headquarters		Y		
Postal Division		Y		
Programs & Policy Division		Y		
Manpower Division		Y		
Plans & Operations Division	Y	Y		
Operational Command Post	Y	Y		
HRSC				
Headquarters Section		Y		
Plans & Operations Division	Y	Y		
PA Division		Y		
Casualty Operations Division		Y		
HR Systems Division	Y	Y		
Postal Operations Division		Y		
Military Mail Terminal (MMT)				
Headquarters		Y		
Operations Section				
Postal Squad A				
Postal Squad B				
Theater Gateway PAT				
Personnel Accountability		Y		
Operations Section			Y	Y
HR Company				
Command Section				
Plans & Operations	Y	Y		
HQS Support		Y		
HR Platoon				
Headquarters Section		Y		
HR Squad		Y		
HR Squad		Y		
HR Squad		Y		
Postal Platoon				
Headquarters		Y		
Postal Finance Section				
Postal Squad A				
Postal Squad B				

Figure B-2. HR equipment requirements

Glossary

The glossary lists acronyms and terms with Army or joint definitions. Where Army and joint definitions differ, (Army) precedes the definition. The proponent publication for other terms is listed in parentheses after the definition.

ABCS	Army Battle Command System
AG	adjutant general
AKO	Army Knowledge Online
AMPS	Automated Military Postal System
AO	area of operations
APO	Army post office
APOD	aerial port of debarkation
APOE	aerial port of embarkation
ASCC	Army Service component command
CAAF	contractors authorized to accompany the force
CAC	common access card
CAO	casualty assistance officer
CCIR	commander's critical information requirement
CLT	casualty liaison team
CMAOC	casualty and mortuary affairs operations center
COA	course of action
COD	casualty operations division
CONUS	continental United States
COP	common operational picture
COPE	custodian of postal effects
COR	contracting officer representative
CSSB	combat sustainment support battalion
DA	Department of the Army
DCIPS	Defense Casualty Information Processing System
DCIPS-CF	Defense Casualty Information Processing System-Casualty Forward
DEERS	Defense Enrollment Eligibility Reporting System
DOD	Department of Defense
DTAS	Deployed Theater Accountability System
DUSTWUN	duty status whereabouts unknown
EAWUN	excused absence whereabouts unknown
EDAS	Enlisted Distribution and Assignment System
eMILPO	electronic Military Personnel Office
EPS	essential personnel services
EPW	enemy prisoner of war
ESC	expeditionary sustainment command
FOB	forward operating base
FRAGORD	fragmentary order

G-1	assistant chief of staff, personnel
G-3	assistant chief of staff, operations
G-4	assistant chief of staff, logistics
G-6	assistant chief of staff, signal
HQ	headquarters
HR	human resources
HRC	human resources command
HROB	human resources operations branch
HRSC	human resources sustainment center
IAW	in accordance with
ID	identification
iPERMS	Interactive Personnel Electronic Records Management System
J-1	manpower and personnel directorate of a joint staff, manpower and personnel staff section
J-6	communications system directorate of a joint staff
JMMT	joint military mail terminal
JMPA	joint military postal activity
JOA	joint operations area
JTF	joint task force
LOD	line of duty
MA	mortuary affairs
MCT	movement control team
MDMP	military decisionmaking process
MMT	military mail terminal
MPO	military post office
MPS	military postal service
MPSA	military postal service agency
MTF	medical treatment facility
NCO	noncommissioned officer
NIPRNET	Nonsecure Internet Protocol Router Network
NOK	next of kin
OPLAN	operation plan
OPORD	operation order
PA	personnel accountability
PAT	personnel accountability team
PERSTAT	personnel status
POD	postal operations division
PS	postal service
R&R	rest and recuperation
RAPIDS	Real-Time Automated Personnel Identification System
RIP	relief in place
ROA	rules of allocation

RSOI	reception, staging, onward movement, and integration
S-1	battalion or brigade personnel staff officer
S-2	battalion or brigade intelligence staff officer
S-3	battalion or brigade operations staff officer
S-4	battalion or brigade logistics staff officer
S-6	battalion or brigade signal staff officer
SAV	staff assistance visit
SUST BDE	sustainment brigade
SIPRNET	SECRET Internet Protocol Router Network
SOP	standard operating procedure
SPM	service postal manager
SPO	support operations
SPOD	sea port of debarkation
SPOE	sea port of embarkation
SPOT	Synchronized Pre-deployment Operational Tracker
SRC	standard requirements code
STB	special troops battalion
TACREC	theater Army casualty records center
TAPDB	Total Army Personnel Database
TG PAT	theater gateway personnel accountability team
TOA	transfer of authority
TOPMIS	Total Officer Personnel Management Information System
TSC	theater sustainment command
USPS	United States postal service

This page intentionally left blank.

References

All URLs for websites were accessed on 30 September 2016.

REQUIRED PUBLICATIONS

These documents must be available to intended users of this publication.

ADRP 1-02. *Terms and Military Symbols*. 16 November 2016.

Department of Defense Dictionary of Military and Associated Terms. 15 October 2016.

RELATED PUBLICATIONS

These documents contain relevant supplemental information.

DEPARTMENT OF DEFENSE PUBLICATIONS

Most CJCS Directives are available online: <http://www.dtic.mil/doctrine/doctrine/cjcs.htm>.

CJCSM 3150.13C. *Joint Reporting Structure – Personnel Manual*. 10 March 2010.

Most DOD Issuances are available online: <http://www.dtic.mil/whs/directives/index.html>.

DOD 4525.6-M. *Department of Defense Postal Manual*. 15 August 2002.

DODI 2310.05. *Accounting for Missing Persons – Board of Inquiry*. 31 January 2000.

DODI 3001.02. *Personnel Accountability in Conjunction with Natural or Manmade Disasters*. 03 May 2010.

Uniform Code of Military Justice web site: <http://www.ucmj.us>.

JOINT PUBLICATIONS

Most joint publications are available online: http://www.dtic.mil/doctrine/new_pubs/jointpub.htm.

JP 1-0. *Joint Personnel Support*. 31 May 2016.

JP 4-10. *Operational Contract Support*. 16 July 2014.

MULTI-SERVICE PUBLICATIONS

ATP 4-10/MCRP 4-11H/NTTP 4-09.1/AFMAN 10-409-O. *Multi-Service Tactics, Techniques, and Procedures for Operational Contract Support*. 18 February 2016.

ARMY PUBLICATIONS

Most Army doctrinal publications are available online: <http://armypubs.army.mil>.

ADP 5-0. *The Operations Process*. 17 May 2012.

ADRP 3-0. *Operations*. 11 November 2016.

ADRP 5-0. *The Operations Process*. 17 May 2012.

AR 15-6. *Procedures for Administrative Investigations and Boards of Officers*. 01 April 2016.

AR 600-8-3. *Postal Operations*. 16 February 2016.

AR 600-8-104. *Army Military Human Resource Records Management*. 07 April 2014.

AR 630-10. *Absence Without Leave, Desertion, and Administration of Personnel Involved in Civilian Court Proceedings*. 13 January 2006.

AR 638-2. *Army Mortuary Affairs Program*. 28 November 2016.

AR 638-8. *Army Casualty Program*. 23 June 2015.

- AR 638-34. *Army Fatal Incident Family Brief Program*. 19 February 2015.
- AR 715-9. *Operational Contract Support Planning and Management*. 20 June 2011.
- ATP 1-0.1. *G-1/AG and S-1 Operations*. 23 March 2015.
- ATP 4-93. *Sustainment Brigade*. 11 April 2016.
- ATP 4-94. *Theater Sustainment Command*. 28 June 2013.
- ATP 5-19. *Risk Management*. 14 April 2014.
- DA PAM 638-2. *Procedures for the Army Mortuary Affairs Program*. 23 June 2015.
- FM 1-0. *Human Resources Support*. 01 April 2014.
- FM 3-50. *Army Personnel Recovery*. 02 September 2014.
- FM 6-0. *Commander and Staff Organization and Operations*. 05 May 2014.
- FM 27-10. *The Law of Land Warfare*. 18 July 1956.

RECOMMENDED READINGS

These sources contain relevant supplemental information.

- ADRP 4-0. *Sustainment*. 31 July 2012.
- AR 600-8. *Military Human Resources Management*. 11 April 2014.
- AR 600-8-4. *Line of Duty Policy, Procedures, and Investigations*. 04 September 2008.
- AR 600-8-6. *Personnel Accounting and Strength Reporting*. 01 April 2015.
- AR 600-8-14. *Identification Cards for Members of the Uniformed Services, Their Eligible Family Members, and Other Eligible Personnel*. 17 June 2009.
- AR 600-8-101. *Personnel Processing (In-, Out-, Soldier Readiness, and Deployment Cycle)*. 19 February 2015.
- AR 600-8-111. *Wartime Replacement Operations*. 13 August 1993.
- AR 690-11. *Use and Management of Civilian Personnel In Support of Military Contingency Operations*. 26 May 2004.
- ATP 3-35. *Army Deployment and Redeployment*. 23 March 2015.
- ATP 4-0.1. *Army Theater Distribution*. 29 October 2014.
- DA PAM 600-8. *Military Human Resources Management Administrative Procedures*. 06 April 2016.
- DA PAM 600-8-101. *Personnel Processing (In-, Out-, Soldier Readiness, and Deployment Cycle Support)*. 19 February 2015.
- DA PAM 600-8-104. *Army Military Human Resource Record Management*. 12 February 2015.
- DA PAM 600-81. *Information Handbook for Operating Continental United States (CONUS) Replacement Centers and Individual Deployment Sites*. 15 July 2001.
- DA PAM 638-8. *Procedures for the Army Casualty Program*. 23 June 2015.
- DA PAM 690-47. *DA Civilian Personnel Handbook, DA Civilian Employee Deployment Guide New Information Pamphlet*. 01 November 1995.
- DODI 1000.01. *Identification (ID) Cards Required by the Geneva Conventions*. 16 April 2012.
- DODI 1400.32. *DOD Civilian Work Force Contingency and Emergency Planning Guidelines and Procedures*. 24 April 1995.
- DODI 3020.41. *Operational Contract Support (OCS)*. 20 December 2011.
- JP 3-35. *Deployment and Redeployment Operations*. 31 January 2013.

WEB SITES

- APD web site: <http://armypubs.army.mil>.
- CJCS Directives web site: <http://www.dtic.mil/doctrine/doctrine/cjcs.htm>.
- DOD Forms web site: <http://www.dtic.mil/whs/directives/forms/index.htm>.

DOD Issuances web site: <http://www.dtic.mil/whs/directives/index.html>.

Joint Electronic Library web site: http://www.dtic.mil/doctrine/new_pubs/jointpub.htm.

PRESCRIBED FORMS

None.

REFERENCED FORMS

Unless otherwise indicated, DA Forms are available on the Army Publishing Directorate (APD) web site:

<http://armypubs.army.mil>

DA Form 1156, *Casualty Feeder Card*.

DA Form 2028, *Recommended Changes to Publications and Blank Forms*.

DD Forms are available on the Office of the Secretary of Defense (OSD) web site:

www.dtic.mil/whs/directives/forms/index.htm.

DD Form 93, *Record of Emergency Data*.

DD Form 285, *Appointment of Military Postal Clerk, Unit Mail Clerk or Mail Orderly*.

DD Form 2257, *Designation/Termination MPC-FPC-COPE-PFO.*

Postal Service Forms are available online for authorized users of the Automated Military Postal System at military post offices: <https://amps.usps.gov/ph/myIndex.htm/>

PS Form 1412, *Daily Financial Report*.

PS Form 1590, *Supplies and Equipment Receipt*.

PS Form 1908, *Financial Adjustment Memorandum*.

PS Form 2942, *Military Mail AV7*.

PS Form 8139, *Your Role in Protecting the Security of the United States Mail*.

Veterans Affairs Forms are available online: <http://www.benefits.va.gov/INSURANCE/resources-forms.asp>.

SGLV 8286, *Servicemember's Group Life Insurance Election and Certificate*.

SGLV 8286A, *Family Coverage Election and Certificate (SGLI)*.

This page intentionally left blank.

Index

Entries are listed by paragraph number unless indicated otherwise.

A

AMPS, 1-52, 4-10, 6-2
APOD, 1-9, 1-43, 1-69, 3-7,
3-16, 3-29
ASCC G-1, 2-31

C

casualty mail, 4-49
casualty operations, 1-74,
2-1, 2-32
CLT, 2-40
CMAOC, 2-30
combat sustainment
support battalion, 1-32

D

DCIPS, 6-3D
DEERS, 6-5
DTAS, 3-4, 6-11

E

elements of HR planning, 5-
1

H

HR automation support, 6-1

HR Company, 1-72, 2-35, 3-
27

HR Platoon, 1-73, 2-38, 3-
28

HR tasks and functions, 1-6

HROB, 1-45, 1-56, 1-63, 2-
34, 3-26, 4-41

HRSC, 1-35

M

mail flow, 4-7

MDMP, 5-22

military mail terminal, 1-71,
4-7

P

Plans and Operations, 5-1

POD, 1-44

postal operations, 4-1,

postal platoon, 1-78
4-43

R

rapid decision making, 5-27

RAPIDS, 6-6

rules of allocation, B-1

running estimate and
planning consideration,
5-19

S

supporting relationships, 1-
3

sustainment srigade, 1-28

sustainment organizations,
1-18

T

TG PAT, 1-69, 3-18, A-5

TPS, 6-7

TSC, 1-18,

V

Very Small Aperture
Terminal, 6-52

This page intentionally left blank.

ATP 1-0.2
24 January 2017

By Order of the Secretary of the Army:

MARK A. MILLEY
General, United States Army
Chief of Staff

Official:

A handwritten signature in black ink, appearing to read "Gerald B. O'Keefe". The signature is written in a cursive style with a large initial "G" and a stylized "O'Keefe".

GERALD B. O'KEEFE
Administrative Assistant to the
Secretary of the Army
1701902

DISTRIBUTION:

Active Army, Army National Guard, and United States Army Reserve: Distributed in electronic media only (EMO).

