

# Thermo Scientific Orion AquaMate User Manual

## AQ7100 Vis and AQ8100 UV-Vis Spectrophotometers

AQX1MAN • Revision E • December 2020

© 2019 Thermo Fisher Scientific Inc. All rights reserved.

All other trademarks are the property of Thermo Fisher Scientific Inc. and its subsidiaries.

For technical support, please contact: [www.thermofisher.com](http://www.thermofisher.com)

Thermo Fisher Scientific Inc. provides this document to its customers with a product purchase to use in the product operation. This document is copyright protected and any reproduction of the whole or any part of this document is strictly prohibited, except with the written authorization of Thermo Fisher Scientific Inc.

The contents of this document are subject to change without notice. All technical information in this document is for reference purposes only. System configurations and specifications in this document supersede all previous information received by the purchaser.

Thermo Fisher Scientific Inc. makes no representations that this document is complete, accurate or error free and assumes no responsibility and will not be liable for any errors, omissions, damage or loss that might result from any use of this document, even if the information in the document is followed properly.

This document is not part of any sales contract between Thermo Fisher Scientific Inc. and a purchaser. This document shall in no way govern or modify any Terms and Conditions of Sale, which Terms and Conditions of Sale shall govern all conflicting information between the two documents.

**For Research Use Only. This instrument or accessory is not a medical device and is not intended to be used for the prevention, diagnosis, treatment or cure of disease.**

# Table of Contents

<b>Chapter 1</b> .....	<b>7</b>
<b>Spectrophotometer Introduction</b> .....	<b>7</b>
Spectrophotometer Overview .....	7
Orion AquaMate 7100 Vis Spectrophotometer .....	8
Orion AquaMate 8100 UV-Vis Spectrophotometer .....	8
Packing Lists .....	8
Orion AquaMate 7100 Vis Spectrophotometer Packing List .....	8
Orion AquaMate 8100 UV-Vis Spectrophotometer Packing List .....	9
Orion AquaMate User Documentation on USB .....	10
Intended Use .....	10
Operating Precautions .....	10
Safety and Special Notices .....	11
<b>Chapter 2</b> .....	<b>12</b>
<b>Spectrophotometer Basics</b> .....	<b>12</b>
Spectrophotometer Components .....	12
Instrument Touchscreen .....	13
Instrument Connections .....	14
Optional Accessories .....	14
Sample Compartment .....	15
Sample Compartment for AQ7100 and AQ8100 .....	15
Single Cell Holder .....	16
Tray Features .....	16
Removal – grasp cell holder and lift up and forward .....	16
Optional Sample Holders .....	17
Cell Holder Replacement .....	18
Optional Printer .....	19
Selecting and Positioning Vials and Cuvettes .....	22
Z-dimension .....	22
<b>Chapter 3</b> .....	<b>23</b>
<b>Orion AquaMate Instrument Setup and Touchscreen and Features</b> .....	<b>23</b>
Instrument Screen Navigation .....	23
User Interface Familiarity .....	25
User Interface Content .....	27
Screen 1 Startup Screen .....	27
Screen 2 – Method Development, Diagnostics, and Data .....	34
Screen 3 – Multi-wavelength and OD600 .....	44
Instrument Settings .....	45
Settings .....	45
SmartStart .....	46
Ending and Exporting Experiments .....	54
Exporting Data .....	55
<b>Chapter 4</b> .....	<b>57</b>
<b>Water Analysis Test Menu</b> .....	<b>57</b>
Preprogrammed Methods .....	57
Method Selection and Experiment .....	58

Droplet Folder Methods .....	58
Method Options .....	60
Method Sample Increments .....	61
Loading Test Methods from the AquaMate Instrument.....	62
Running Water Analysis Test Methods .....	63
Single Point Method Adjustment.....	65
Using the Reverse Color Feature .....	66
<b>Chapter 5.....</b>	<b>67</b>
<b>Orion AQUAfast Reagent Chemistry Instructions for Orion AquaMate.....</b>	<b>67</b>
Orion AQUAfast Colorimetric Reagents Compatible with Orion AquaMate Instruments .....	67
Orion AQUAfast Reagent Instructions.....	69
Recommendations for Avoiding Measurement Errors .....	69
AC2002 Alkalinity-M (Alkalinity to pH 4.3) Tablet Test.....	70
AC3002P Alkalinity-P (Alkalinity to pH 8.2) Tablet Test.....	71
AC2027 Aluminum Tablet Test.....	72
AC4P27 Aluminum Powder Pack & Liquid Test.....	73
AC2012 Ammonia Tablet Test.....	74
AC4P12 Ammonia Powder Pack Test.....	75
ACR012 Ammonia Low Range Reaction Tube Test.....	76
ACR011 Ammonia High Range Reaction Tube Test.....	77
AC2035 Bromine Tablet Test.....	78
AC2017 Chloride Tablet Test.....	80
AC2070 Chlorine (Free & Total) Tablet Test .....	81
AC2071 Chlorine (Free) Tablet Test .....	83
AC2072 Chlorine (Total) Tablet Test.....	85
AC4P71 Chlorine (Free) Powder Pack Test.....	87
AC4P72 Chlorine (Total) Powder Pack Test.....	88
AC3072 Chlorine (Total) High Range Tablet Test.....	89
AC2099 Chlorine Dioxide Tablet Test.....	90
CODL00 COD Low Range Digestion Tube Test .....	92
CODH00 COD Mid-Range Digestion Tube Test .....	94
CODHP0 COD High Range Digestion Tube Test .....	95
AC2029 Copper (Free & Total) Tablet Test.....	96
AC4P29 Copper (Free) Powder Pack Test.....	97
AC2098 Cyanuric Acid Tablet Test .....	98
AC2009 Fluoride SPADNS Liquid Test.....	99
AC3032T Hardness (Total) Tablet Test .....	101
AC2030 Hydrazine Powder Test.....	102
AC2078 Iron (II & III) Tablet Test.....	103
AC4P78 Iron (Ferro) Powder Pack Test .....	104
AC4P79 Iron (Total) Powder Pack Test.....	105
AC2055 Manganese Tablet Test.....	106
AC4P54 Manganese Low Range Powder Pack & Liquid Test.....	107
AC4P55 Manganese High Range Powder Pack Test.....	108
AC4P42 Molybdate Powder Pack Test.....	109
ACR007 Nitrate Reaction Tube Test.....	110
AC2046 Nitrite Tablet Test.....	111
AC4P46 Nitrite Powder Pack Test.....	112
ACD004 Nitrogen (Total) Low Range Digestion Tube Test .....	113
ACD007 Nitrogen (Total) High Range Digestion Tube Test.....	115

AC3048 Ozone Tablet Test .....	117
AC2001 pH Tablet Test.....	119
AC3001 pH Liquid Test.....	120
AC2095-WA Phosphate (Ortho) Low Range Tablet Test .....	121
AC2096 Phosphate (Ortho) High Range Tablet Test.....	122
AC4P95 Phosphate (Ortho) Powder Pack Test .....	123
ACR095 Phosphate (Ortho) Reaction Tube Test.....	124
ACD095 Phosphate (Total) Digestion Tube Test .....	125
ACD095AH Phosphate (Acid Hydrolysable) Digestion Tube Test .....	127
AC2060 Silica Tablet Test.....	129
AC2061 Silica with Phosphate Removal Tablet Test.....	130
AC4P60 Silica Powder Pack Test .....	131
AC4P82 Sulfate Powder Pack Test.....	132
AC2016 Sulfide Tablet Test.....	133
AC2065 Zinc Tablet Test .....	134
Color Measurement from Application Log #131 .....	135
UVA and UV254 Measurements from Application Log #137 .....	139
<b>Chapter 6 .....</b>	<b>143</b>
<b>Standard Curve Test Menu .....</b>	<b>143</b>
Concentration Measurements using the Quant Standard Curve Application (Custom Method)	
.....	143
Accessing Quant.....	144
Quant Standard Curve Options .....	145
Setting the Parameters for a Standard Curve.....	145
Creating a Standard Curve in Quant.....	146
Measuring Standards for a Standard Curve .....	146
Measurement Samples via Quant .....	147
Ending An Experiment.....	148
Exporting Data .....	149
Editing a Standard Curve .....	150
<b>Chapter 7 .....</b>	<b>153</b>
<b>Wavelength Scanning Test Menu .....</b>	<b>153</b>
Setting the Parameters for a Scan .....	154
Collecting a Baseline Scan and Scanning a Sample .....	156
Performing Calculations on the Scan Data .....	157
3Pt Net Function .....	159
Area Function.....	160
Recalling an Existing Scanning Method.....	161
<b>Chapter 8 .....</b>	<b>162</b>
<b>AquaMate On-board Software .....</b>	<b>162</b>
<b>Chapter 9 .....</b>	<b>171</b>
<b>Absorbance, % Transmittance and Concentration Measurements .....</b>	<b>171</b>
Absorbance & % Transmittance Measurements .....	171
Using the Fixed Application for Basic A-%T-C TestMethod .....	171
Available Fixed Equations .....	173
Using the C-Mode to Measure Concentration .....	174
Multi-wavelength.....	175
3-Point Net .....	176

Kinetics .....	177
<b>Chapter 10.....</b>	<b>178</b>
<b>Maintenance.....</b>	<b>178</b>
Routine Care .....	179
Cleaning and Maintaining Vials and Cuvettes .....	179
Cleaning the Windows of the Sample Compartment.....	181
Replacing the Tungsten-Halogen Lamp.....	182
Xenon Lamp Life.....	183
Replacing the Xenon Flash Lamp .....	184
<b>Chapter 11.....</b>	<b>187</b>
<b>Customer Services.....</b>	<b>187</b>
Technical Support.....	187
Instrument Specifications .....	188
Ordering Information.....	190
<b>Appendix A .....</b>	<b>193</b>
<b>General Instrument Information.....</b>	<b>193</b>
Parameters.....	193
Calculations for Software .....	198

# 1

## CHAPTER 1 Spectrophotometer Introduction

### Spectrophotometer Overview

Thermo Scientific™ Orion™ AquaMate™ Vis and UV-Vis spectrophotometers offer the following features and benefits:

- Easy operation using the 260+ preprogrammed methods for common colorimetric reagents
- Easy access to approved regulatory methods for wastewater and drinking water.
- Secured Smart Method selection for frequently used methods
- Glove-friendly touchscreen user interface.
- Flexibility to create new methods for additional reagents or samples – create new methods using calibration standards or update methods using published wavelengths and equations
- Use a variety of circular and rectangular vial sizes with a variety of vial holder options.
- Performance verification tests ensure wavelength accuracy and instrument functionality, plus built-in filters allow for wavelength verification with no additional equipment required
- Additional functions include standard curve concentration measurements, wavelength scanning, multiple fixed-wavelength measurements, absorbance ratio and difference
- One year instrument warranty

## Orion AquaMate 7100 Vis Spectrophotometer

The Orion AquaMate 7100 Vis spectrophotometer measures in the 325 to 1100 nm wavelength range using a Tungsten-Halogen lamp, designed for easy replacement using the factory pre-aligned lamp and base. The Tungsten-Halogen lamp has an average expected lifespan > 1,000 hour.

## Orion AquaMate 8100 UV-Vis Spectrophotometer

The Orion AquaMate 8100 UV-Vis spectrophotometer measures in the 190 nm to 1100 nm wavelength range using a Xenon Flash lamp that requires no warm-up time and is designed for an average 3-5 year lifespan.

## Packing Lists

### Orion AquaMate 7100 Vis Spectrophotometer Packing List

- Vis Spectrophotometer with 7-inch color touchscreen and Tungsten-Halogen Lamp
- 12-25 mm Round Vial Holder (P/N: AQX1LWLVH)
- 24 mm Round vials, 12-pack quantity (P/N: AC2V24)
- External AC to DC Universal Power Supply, 100–240 volts, 50–60 Hz (AQX1PWRSUP)
- Standard power cord bundle (North American, EU, and UK) w/AQ7100
  - NA Cord (P/N: AQX1NACBL)
  - EU Cord (P/N: AQX1EUCBL)
  - UK Cord (P/N: AQX1UKCBL)
- Optional APAC power cord bundle (China, Australia, and India) w/AQ7100APAC
  - China Cord (P/N: AQX1CNCBL)
  - Australia Cord (P/N: AQX1AUCBL)
  - India Cord (P/N: AQX1INCBL)
- AquaMate User Guide, Methods List, and Reagent Instructions on USB (P/N: AQX1MAN)
- AquaMate Getting Started Guide
- Read Me First Warning Guide (Multilanguage)
- AquaMate Site and Safety Guide
- CE Declaration of Conformity
- Printed instrument test verification report
- Dust cover
- USB cable



## Orion AquaMate 8100 UV-Vis Spectrophotometer Packing List

- UV-Vis Spectrophotometer with 7-inch color touchscreen and Xenon Flash Lamp
- 12-25 mm Round Vial Holder (P/N: AQX1LWLVH)
- 24 mm Round vials, 12-pack quantity (P/N: AC2V24)
- External AC to DC Universal Power Supply, 100–240 volts, 50–60 Hz (AQX1PWRSUP)
- Standard power cord bundle (North American, EU, and UK) w/AQ7100
  - NA Cord (P/N: AQX1NACBL)
  - EU Cord (P/N: AQX1EUCBL)
  - UK Cord (P/N: AQX1UKCBL)
- Optional APAC power cord bundle (China, Australia, and India) w/AQ7100APAC
  - China Cord (P/N: AQX1CNCBL)
  - Australia Cord (P/N: AQX1AUCBL)
  - India Cord (P/N: AQX1INCBL)
- AquaMate User Guide, Methods List, and Reagent Instructions on USB (P/N: AQX1MAN)
- AquaMate Getting Started Guide
- Read Me First Warning Guide (Multilanguage)
- AquaMate Site and Safety Guide
- CE Declaration of Conformity
- Printed instrument test verification report
- Dust cover
- USB cable

**Note:** The APAC (China, Australia, and India) power cord bundle must be specified by either AQ7100APAC or AQ8100APAC upon ordering.

# Orion AquaMate User Documentation on USB

The Orion AquaMate user documentation USB includes the following:

- AquaMate User Guide, Methods List, and Reagent Instructions on USB (P/N: AQX1MAN)
  - AquaMate Site and Safety Guide
  - Read Me First Warning Guide (Multilanguage)
  - AquaMate User Guide, Methods List and Reagent Instructions on USB (AQX1MSN)
  - AquaMate Getting Started Guide
  - Warranty Information
  - WEEE / RoHS Compliance Information
  - Production Test Report
  - Released Firmware and Water Method libraries

## Intended Use

Please read this user manual thoroughly. Any use outside of these instructions may invalidate the instrument warranty and cause permanent damage to the instrument.

## Operating Precautions

**Warning:** Do not operate this system without following the safety precautions described in this manual and the documentation that came with your system.

The spectrophotometer contains precise optical components. Handle it carefully and follow these precautions.

- Allow instrument to come to room temperature after unboxing before power on.
  - Do not allow moisture to leak into the instrument interior
- Wipe off spilled chemicals immediately
- Do not drop the instrument
- Protect the instrument from mechanical shock
- Protect the instrument from dust

## Safety and Special Notices

Make sure you follow the precautionary statements presented in this user manual. The safety and other special notices appear in boxes.

Safety and special notices include the following:

**Note:** Contains helpful supplementary information

**Important:** Instructions that must be followed to avoid damaging system hardware or data loss

**Caution:** Statements that indicate a hazardous situation that, if not avoided, could result in minor or moderate injury

**Warning:** A hazardous situation that, if not avoided, could result in death or serious injury

Thermo Fisher Scientific provides this document to its customers with a product purchase to use in the product operation. The contents of this document are subject to change without notice. All technical information in this document is for reference purposes only. System configurations and specifications in this document supersede all previous information received by the purchaser.

Thermo Fisher Scientific makes no representations that this document is complete, accurate or error free and assumes no responsibility and will not be liable for any errors, omissions, damage or loss that might result from any use of this document, even if the information in the document is followed properly.

This document is not part of any sales contract between Thermo Fisher Scientific Inc. and a purchaser. This document shall in no way govern or modify any terms and conditions of sale, which terms and conditions of sale shall govern all conflicting information between the two documents.

For Research Use Only. This instrument is not a medical device and is not intended for the prevention, diagnosis, treatment or cure of disease.



**Warning:** Avoid an explosion or fire hazard. This instrument is not designed for use in an explosive atmosphere.

# 2

## CHAPTER 2 Spectrophotometer Basics

### Spectrophotometer Components

The following are some of the major components visible on the outside of the instrument



## Instrument Touchscreen

The instrument Touchscreen has 3-screen to navigate and can be swiped from left-to-right. Below are the three user interface screens to navigate through by swiping left or right. Within each screen there appear a series of application icons that are briefly described below. When any application is selected, the user is directed to an “Application Home” screen. Methods can be selected and adjusted. New methods can be created. Diagnostics and experiment data can be reviewed. By tapping on the gear in the upper right corner, the Settings menu can be accessed from any screen.

SCREEN 1

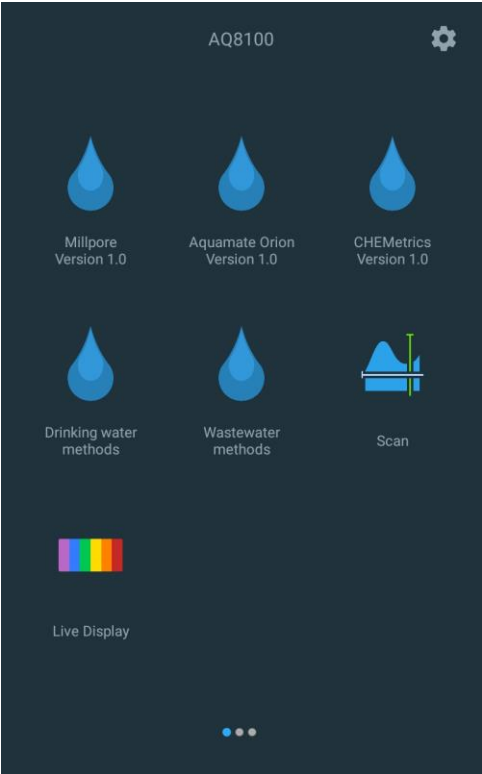

SCREEN 2

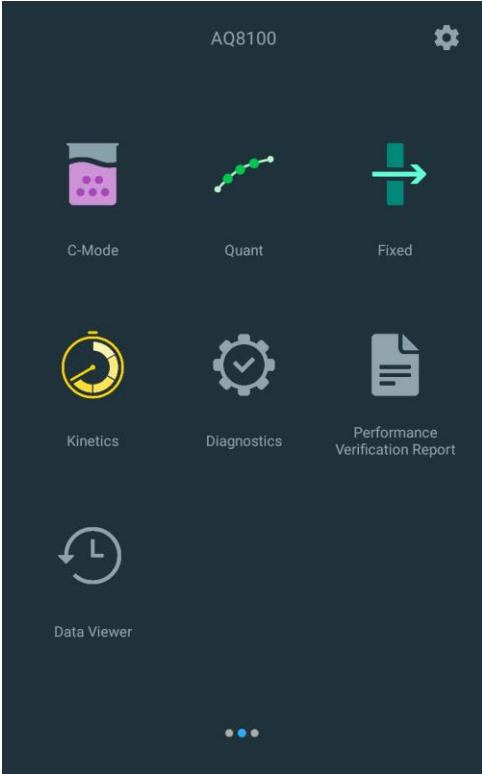

SCREEN 3

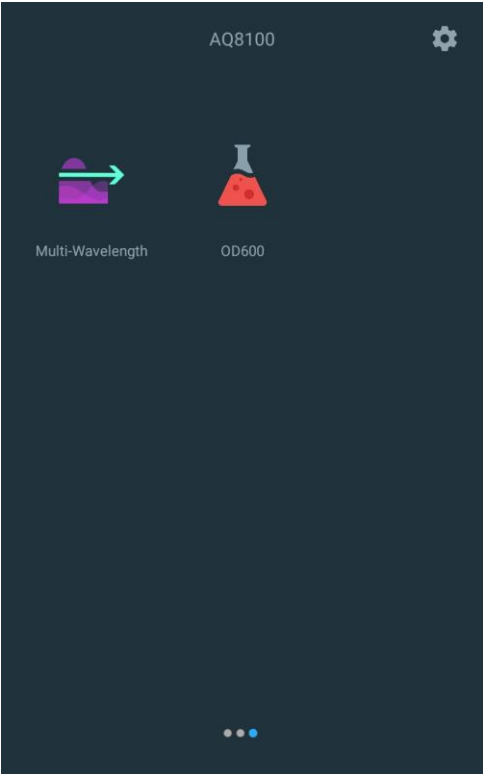

<ul style="list-style-type: none"> <li> METHODS: AquaMate water method libraries</li> <li> SCAN: ABS or %T, min, max, interval, and speed.</li> <li> LIVE DISPLAY: ABS or %T at specified wavelength.</li> </ul>	<ul style="list-style-type: none"> <li> C-MODE: 1-point cal. @ select <math>\lambda</math> and units.</li> <li> QUANT: Multi-point cal. curve development.</li> <li> FIXED: Dual - <math>\lambda</math> and factor measurements.</li> <li> KINETICS - time based experiments</li> <li> DIAGNOSTICS: review verification test reports.</li> <li> PERFORMANCE VERIFICATION REPORTS</li> <li> DATA VIEWER: Logged experimental data.</li> </ul>	<ul style="list-style-type: none"> <li> MULTI-WAVELENGTH: multi-<math>\lambda</math> scanning</li> <li> OD600: reserved</li> </ul>
--	--	--

## Instrument Connections

### Electrical Connections

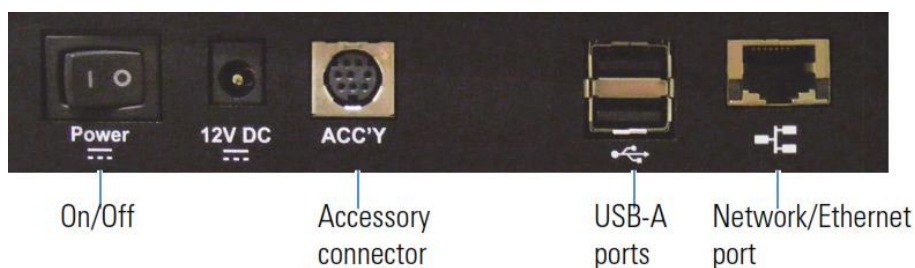

- On/Off Power toggle switch
- 12V DC - connect the cable from the power supply here
- Accessory connector – reserved for future optional accessories
- USB-A ports—see Optional Accessories below
- Network/Ethernet port—connect a standard Ethernet (RJ45-RJ45) cable between this port and a network port to communicate with the building network
- Single USB-A supports flash memory devices for method and data storage
- Duplex USB-A supports connection to a Windows computer running optional remote-control software, keyboard, mouse.
- Export data to network or PC via Ethernet or Wi-Fi USB adaptor (not shown)
- Print via USB, Ethernet or Wi-Fi USB adaptor (now shown)

**Warning:** Avoid shock hazard. Always turn off the instrument and unplug it from the wall outlet or power strip before you unplug the power cord from the instrument connector.

### Optional Accessories

The USB ports support the following peripheral devices:

- Printer

# Sample Compartment

Remove all tape from the exterior of the instrument and inside the sample compartment

## Sample Compartment for AQ7100 and AQ8100



High durability constant torque hinges hold the lid at any angle



Magnet at front holds lid closed to exclude light when door is lowered

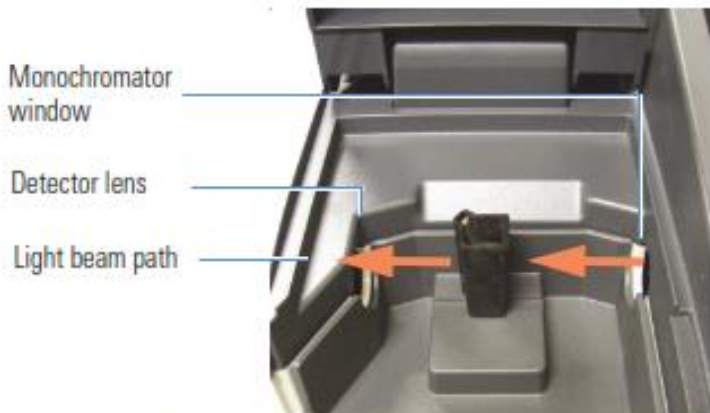

Window and lens protect interior optics from spills and vapors.



Sample holder tray aligns to posts on baseplate.  
Excess spills drain to benchtop.

## Single Cell Holder



Standard 10 mm cuvette holder

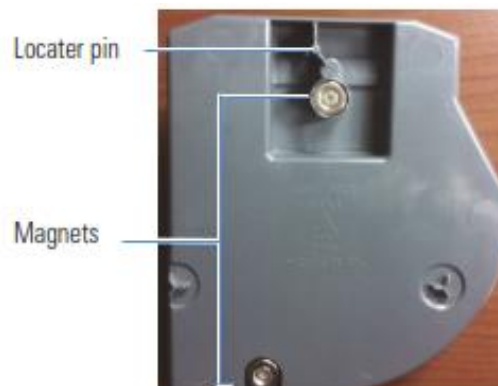

Underside of a single cell holder

### Tray Features

- Able to contain spills up to 150 mL
- Can be removed by pulling up on the cell holder
- Can be washed in the sink or a dishwasher - dry promptly!

**NOTICE** Clean the tray with water and mild detergent. Ethanol and iso-propyl alcohol can be used if necessary but do not soak the tray in alcohols. Do not allow acetone, chlorocarbons or other aggressive organic solvents to contact the tray. The PC-ABS plastic will soften and discolor.

### Removal – grasp cell holder and lift up and forward



Insertion – allow front magnet to engage. Lower cell holder into place, allowing back magnet to guide and engage



## Optional Sample Holders

Cell holder trays equipped to position other kinds of cells and samples are available. They insert and remove in the same way as the standard cell holder.

Test tube holder



Tall test tube adapter



Long path rectangular cell holder



Filter holder

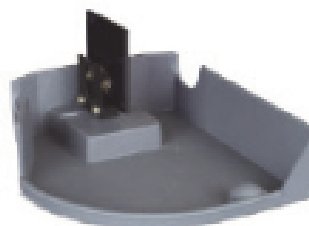

## Cell Holder Replacement

Cell holder and Adjustable filter holder accessories are supplied without a tray.



Loosen the captive screw and the base of the cell holder to remove it. Attach a new sample holder in the same way.

## Optional Printer

If the unit comes with the optional printer, follow the following steps and then reference Chapter 11 for Printer Setup through the touch screen.

1. Remove the printer housing cover.
  - a. Use the finger hold
  - b. Pull towards you and lift

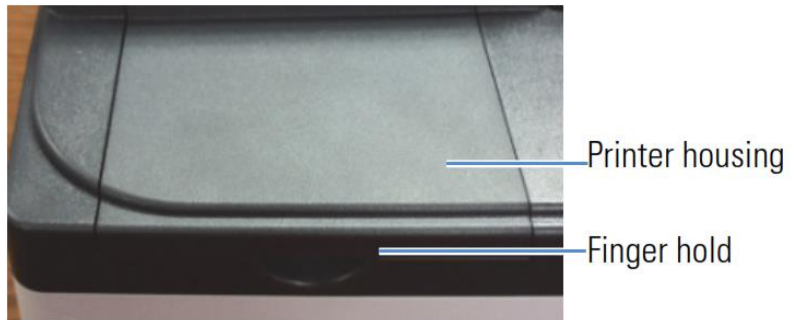

2. Load paper into optional printer.

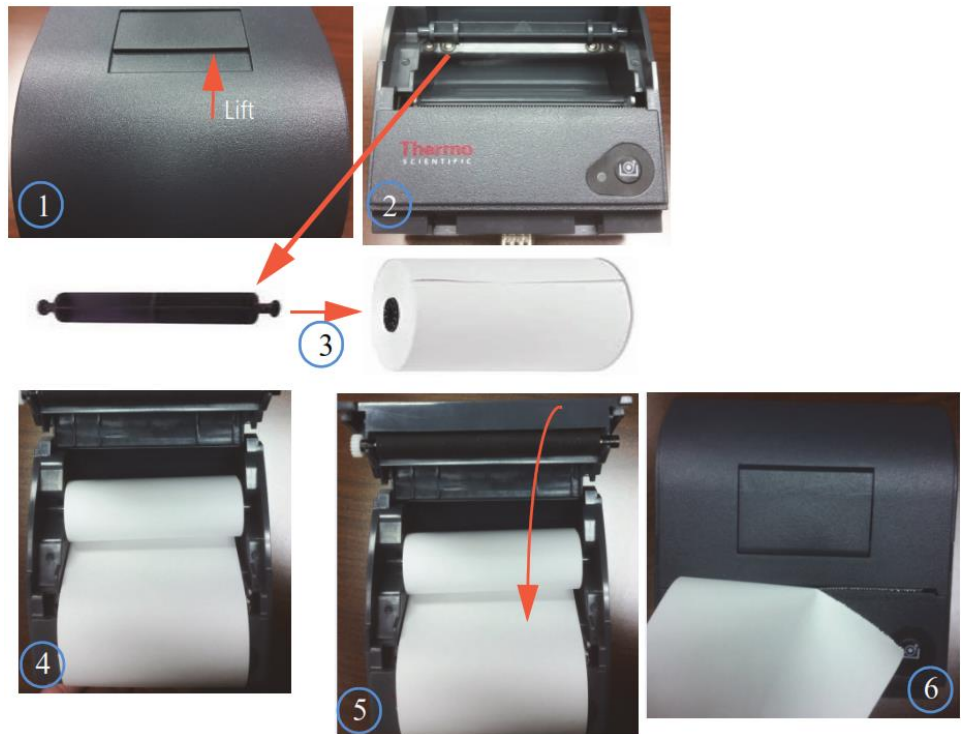

3. Insert printer into AquaMate Spectrophotometer from the rear of instrument

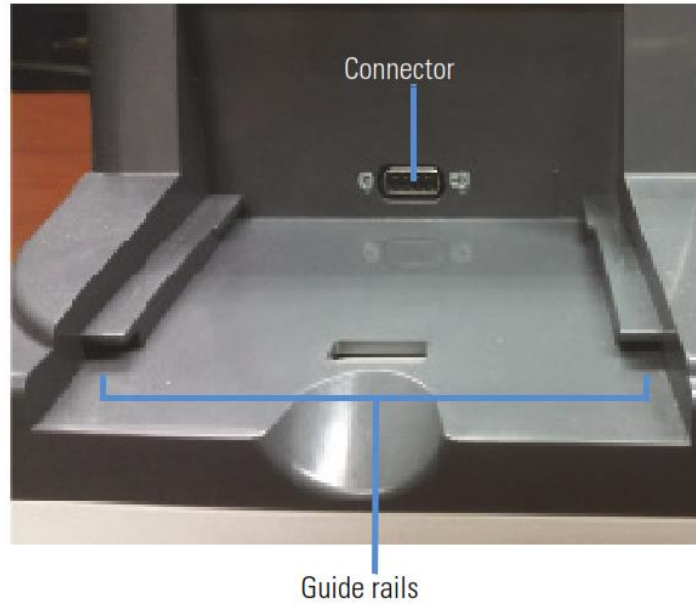

4. Observing the bottom of the printer, align the guide rail on the printer with the guide rail on the AquaMate Spectrophotometer



5. Push the printer forward until the connectors are fully connected. You will hear a snap when the connectors have engaged properly.



Slide forward



Printer fully engaged

## Selecting and Positioning Vials and Cuvettes

The compatible wavelength range for different types of vials and cuvettes depends on the material used. The path length of test tubes is not as well defined as that of square cuvettes.

Vial / Cuvette Type	Wavelength Range
Optical Glass	360 nm to > 1100 nm
Borosilicate Glass	330 nm to > 1100 nm
Quartz	190 nm to > 1100 nm
<b>Disposable:</b>	
Polystyrene	> 340 nm
Methacrylate	> 300 nm
Acrylic	> 280 nm
UV-transparent	> 220 nm

**Note:** See the manufacturer's specifications and work within the recommended range.

Position vials and cuvettes so that the clear sides face the light beam, one clear side facing the front of the instrument and the other facing the back.

**Note:** Always place vials in the instrument in the same orientation in the light beam. An alignment mark on the vial helps orient the vial consistently and correctly.

When using small aperture (small volume) cuvettes:

- Always use cuvettes with black masking
- Use the same cuvette for your blank and your samples

### Z-dimension

The figure below illustrates the position of the light beam in the instrument. Beam size specifications are shown below.

- Distance from bottom of the vial/cuvette to center of beam (Z-dimension): 8.5 mm
- Beam dimensions: 2 mm (wide) by 7 mm (tall)

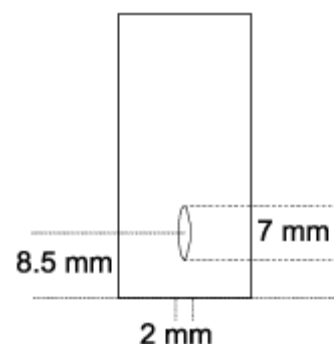

# 3

## CHAPTER 3 **Orion AquaMate Instrument Setup and Touchscreen and Features**

### Instrument Screen Navigation

Below are the three user interface screens to navigate through Screen 1, Screen 2, and Screen 3 by swiping left or right. Within each screen there appears a series of application icons that are included in a legend to briefly describe each application.

When any application is selected, the user is directed to an “Application Home” screen. Methods can be selected and adjusted. New methods can be created. Diagnostics and experiment data can be reviewed and performance verification reports can be viewed, generated and exported.

SWIPE left or right between screens



SCREEN 1

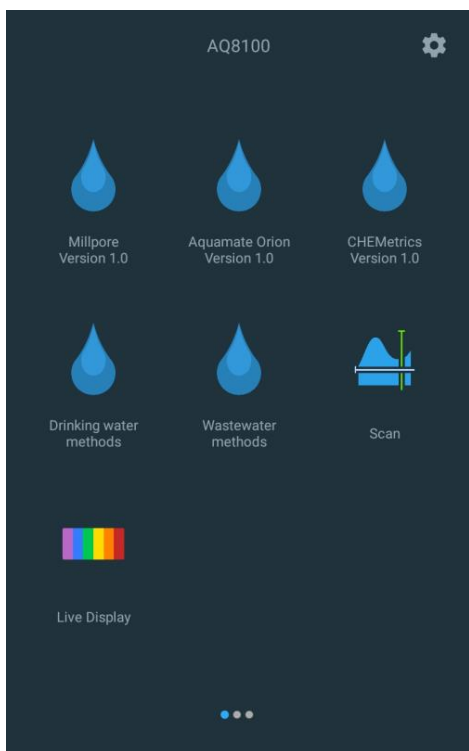



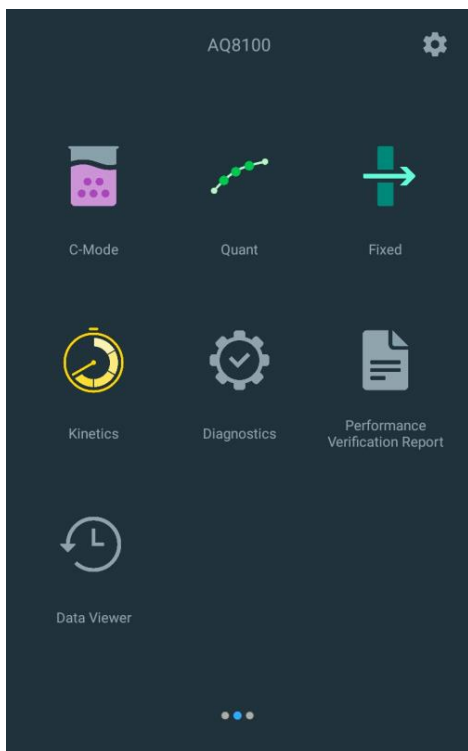



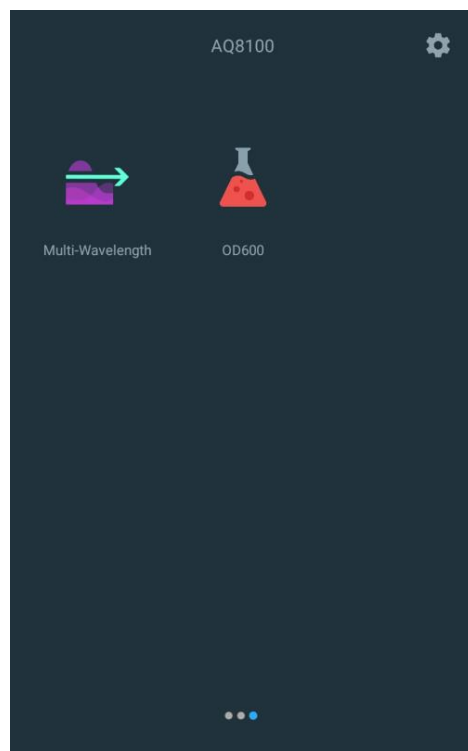





SCREEN 2



SCREEN 3



-  METHODS: AquaMate water method libraries
-  SCAN: ABS or %T, min, max, interval, and speed.
-  LIVE DISPLAY: ABS or %T at specified wavelength.
-  C-MODE: 1-point cal. @ select  $\lambda$  and units.
-  QUANT: Multi-point cal. curve development.
-  FIXED: Dual -  $\lambda$  and factor measurements.
-  KINETICS - time based experiments
-  DIAGNOSTICS: review verification test reports.
-  PERFORMANCE VERIFICATION REPORTS
-  DATA VIEWER: Logged experimental data.
-  MULTI-WAVELENGTH: multi- $\lambda$  scanning
-  OD600: reserved



## User Interface Familiarity

The user interface is a touchscreen device and very similar to any smart tablet features. Active **blue touchpoints** are areas where selections and edits can be made.

For example, in the image below when using a SCAN application, when tapping the method name the keyboard will appear to edit. When tapping the min or max wavelength, a wavelength keypad appears. When tapping the interval or the speed fields, respective pop keypads will appear to edit the method/experiment. Finally, a diskette icon is available to be used to save the method with the edited fields and name. Other areas to look for are the ellipsis icons that will expand access to editing features and more.

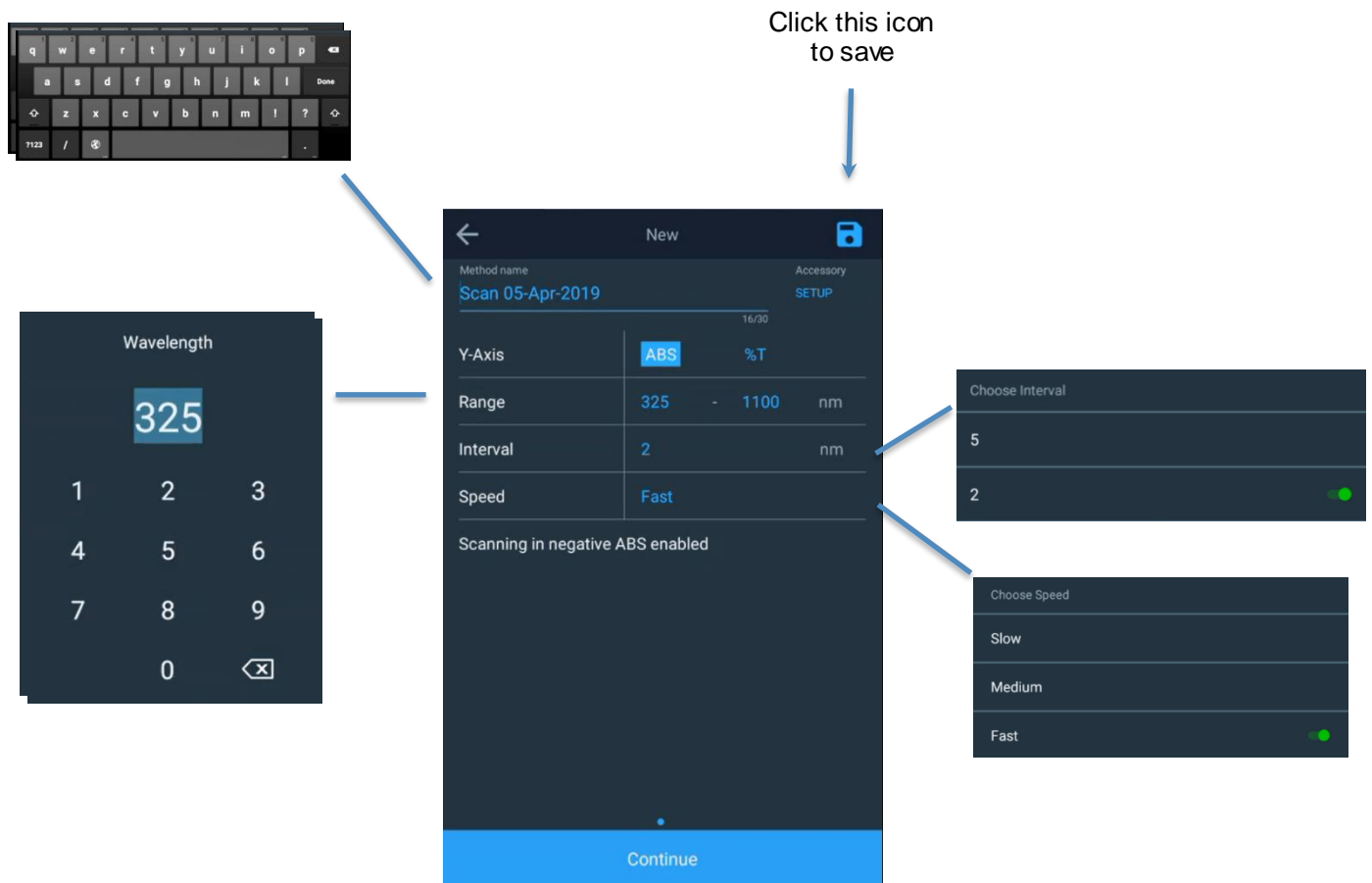

This section uses the Scan application as an example. As shown, using the ellipsis will open additional fields for the saved method allowing the following:

- Method revisions
- SmartMethod selection for SmartMethod mode.
- Method export
- Method duplication (possibly to keep the original method intact)
- Method deletion (for non-droplet library methods only)

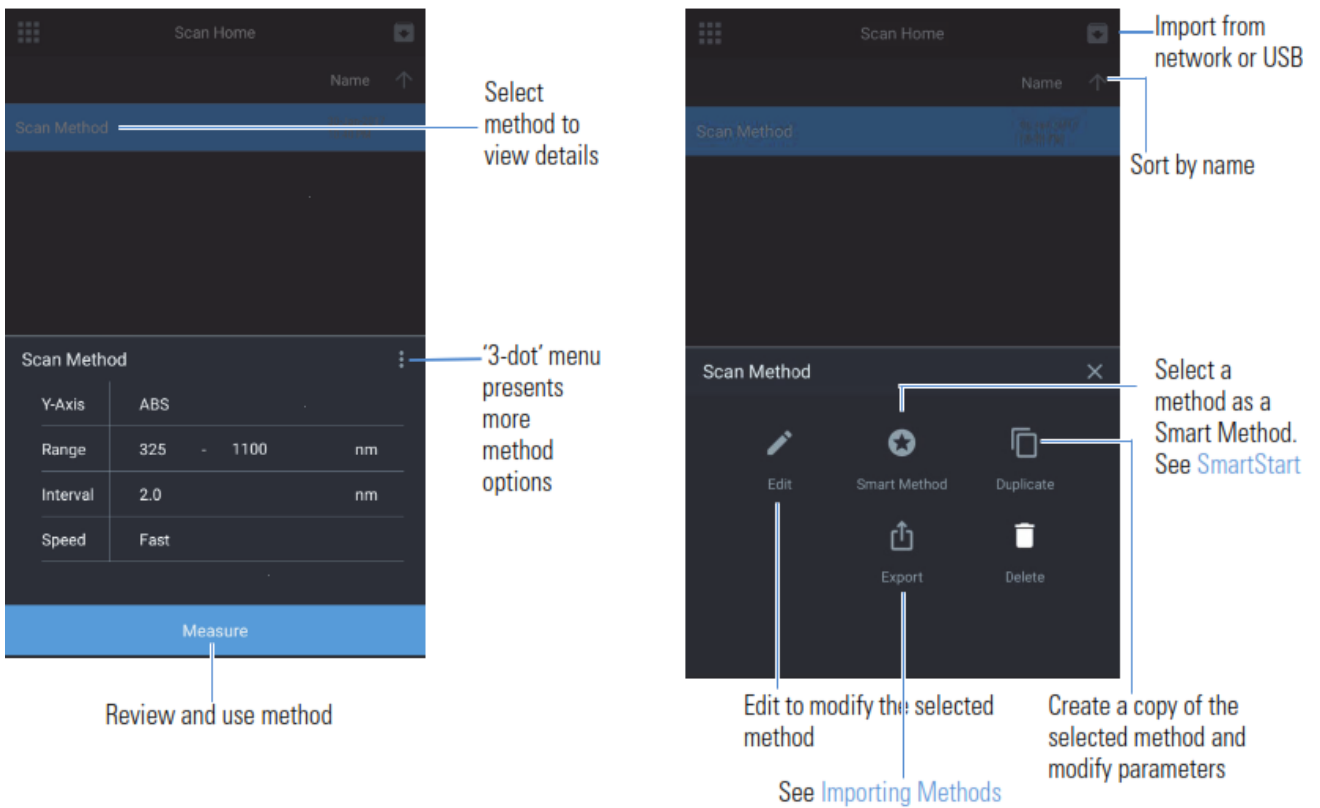

# User Interface Content

## Screen 1 Startup Screen

Screen 1 appears after the Thermo Scientific splash screen disappears upon start-up. The touchscreen user interface is based on smart device technology. An application is selected by tapping the respective icon. The following applications are in Screen 1:

- DROPLETS - Five (5) droplet folders with respective water methods. Any method identified as having a regulatory approval is duplicated in the Drinking water or Wastewater droplet folders. Droplet folder version numbers are provided.
- SCAN – is a multiwavelength scan, selecting absorption (ABS) or percent transmission (%T), across a selectable wavelength range and selectable speed and interval resolution.
- Live Display – is a real-time continuous scanning application that is interactive; no real data is saved. ABS or %T are shown in real-time.

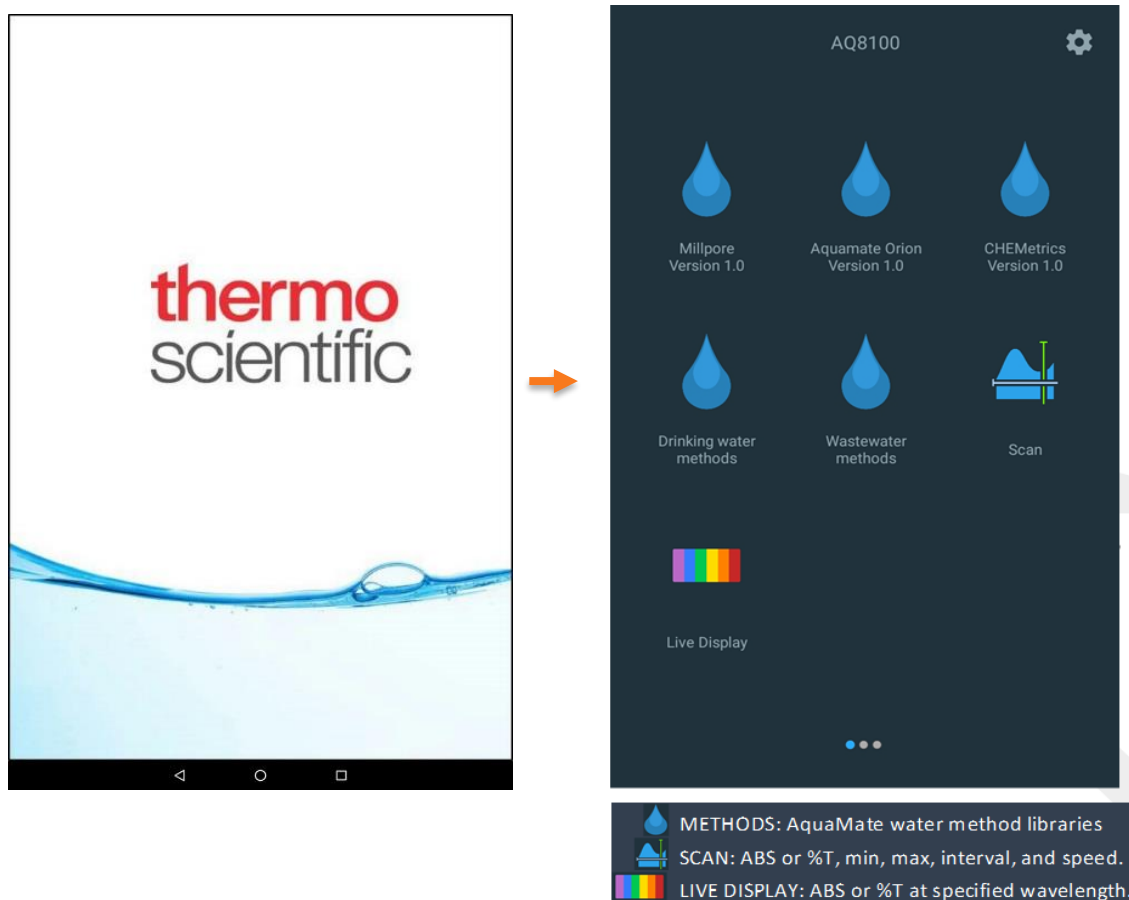

## Droplet Folders

There are three main water method Droplet Folders and two Regulatory folders:

1. AquaMate Orion
2. Merck/Millipore
3. Chemetrics
4. Wastewater (regulatory)
5. Drinking Water (regulatory)

Any AquaMate water method that qualifies as a regulatory Wastewater (WW) or Drinking Water (DW) method is duplicated within the respective WW or DW folders. Within each folder you can search either by the numerical method name or by the parameter. For example, you can search by either AC2002 or by Alkalinity-M. You can also sort by method name, date of creation, date last updated or date last used.

**NOTE: Each method description provides the wavelength, appropriate vial size, and measurement range. If the incorrect vial size is used, the results will not be accurate.**

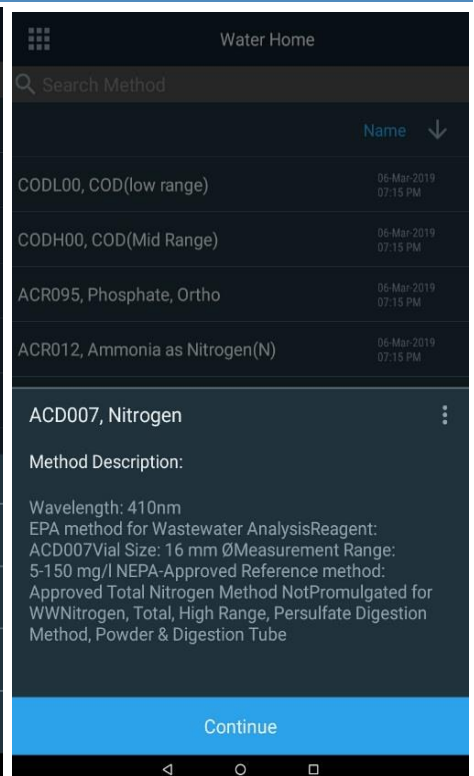
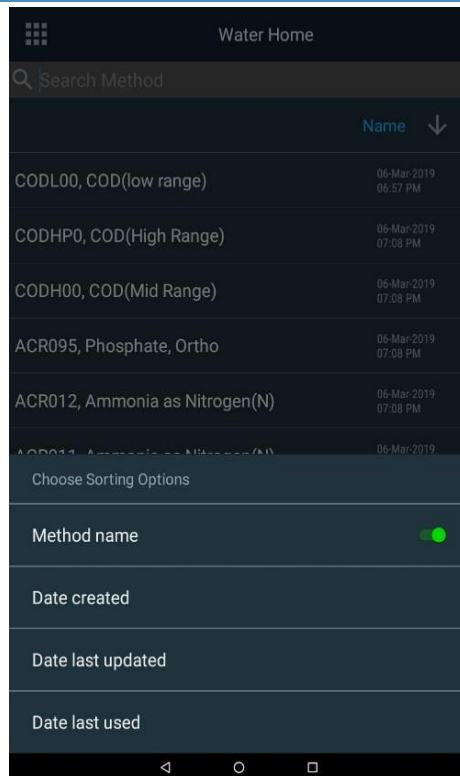
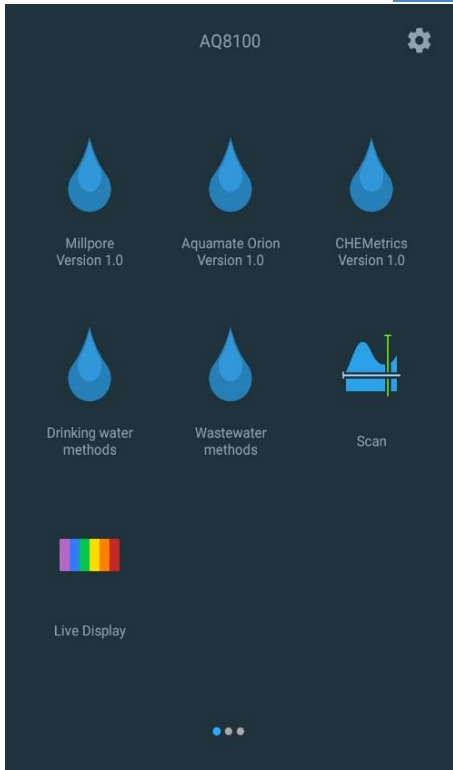

**Note:** Please refer to the method description for measurement capabilities for each method. This instrument will report values outside of the stated range capabilities that may not be acceptable for the user's specific purpose or for regulatory reporting requirements.

## Water Droplet Methods - Single Point Adjustment

Water test methods can be adjusted using a single point calibrations adjustment. In the example below, select a method and prior to Blank and Measure, select the Re-Calibrate option to perform a single point adjustment based on the standard concentration value entered by the user. This will update the Calibration Factor field. This procedure is recommended each time a new batch of reagents are used to account for variations in batch-to-batch reagent composition and other factors that affect the accuracy of a method with a fixed calibration curve.

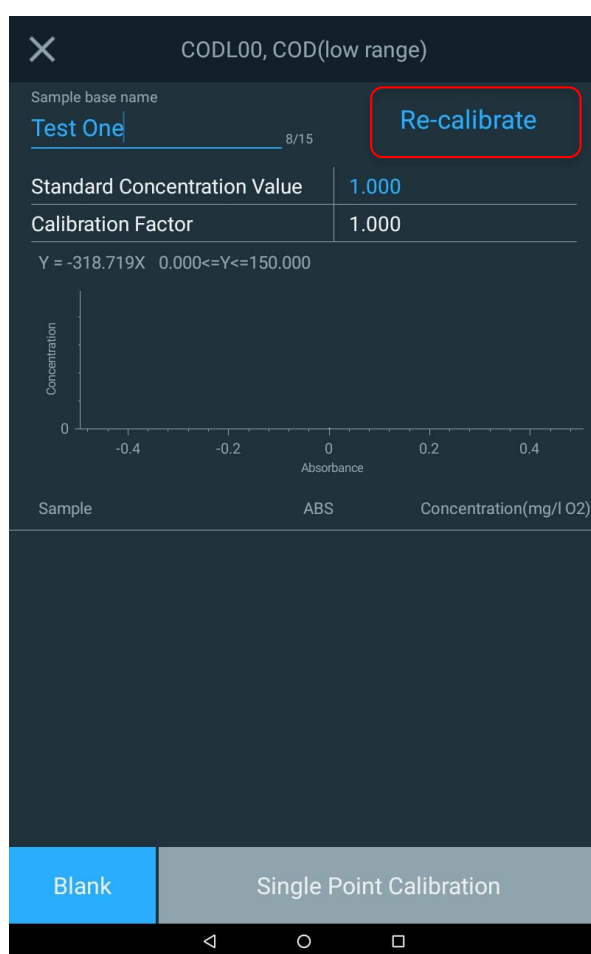
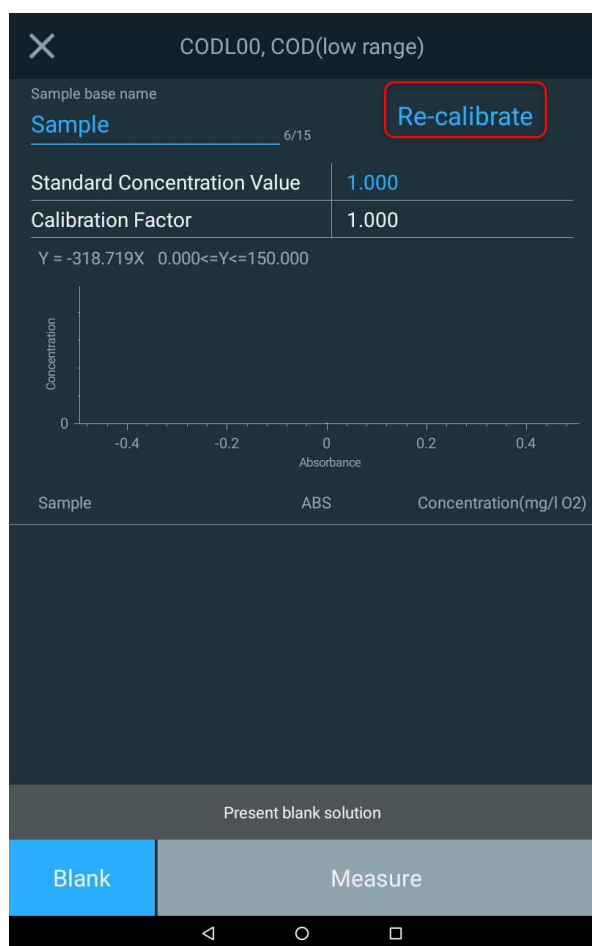

## Multi-Unit Water Methods

There are several water methods that can report out in multiple units of measure simultaneously. In the example below, you can see how three units of measure can be provided.



## Regulatory Water Methods

Within the Drinking Water and Wastewater method libraries, when selecting a method, the user can read within the method description. Included will be a regulatory method description.

**NOTE: The regulatory method range may be limited to a different range of the AquaMate method itself.**

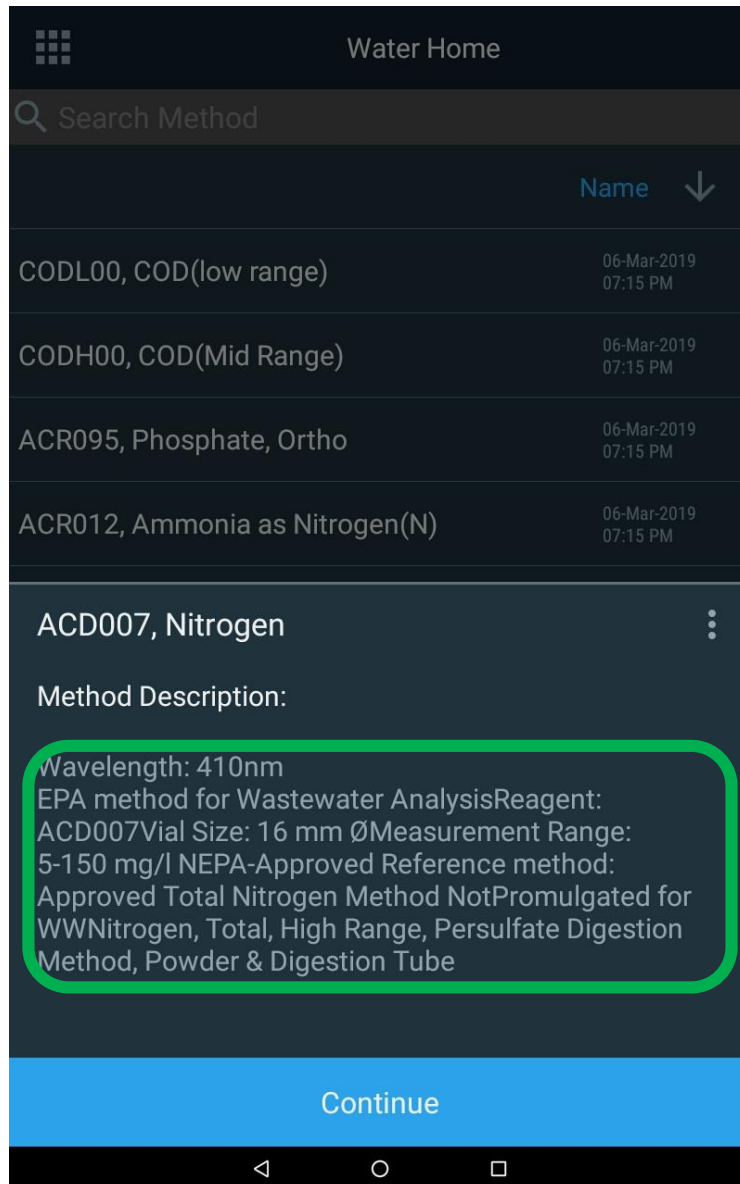

## SCAN Application

SCAN is a multiwavelength scan, selecting absorption (ABS) or percent transmission (%T), across a selectable wavelength range and selectable speed and interval resolution. The value of SCAN is to evaluate the absorption or transmission characteristics of a sample or a sample with reagent. This is valuable when determining what the best wavelength is to establish a new method.

Custom sample scanning methods can be created for sample characterization, yet no concentration measurements are made here.

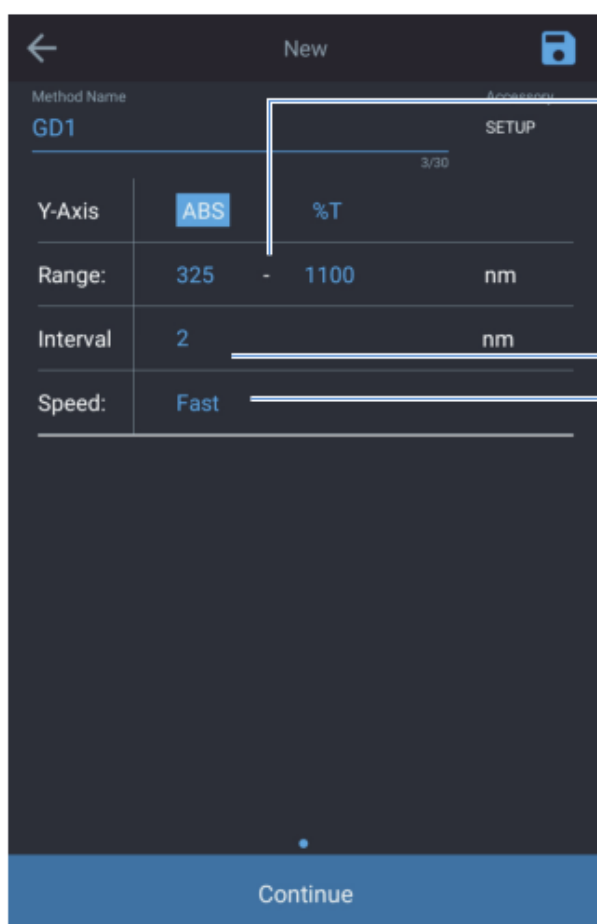

Scan range:

Between 190 nm and 1100 nm for UV-Vis

Between 325 nm and 1100 nm for Vis instruments

Interval:

Specifies how frequently the instrument will acquire a measurement.

In this illustration, data will be captured every 2 nm.

Fast, Medium, Slow scan speeds limit the number of data interval options offered

Speed	Interval Options
Fast	5 nm, 2 nm
Medium	5 nm, 2 nm, 1 nm
Slow	5 nm, 2 nm, 1 nm, 0.5 nm, 0.2 nm,



## Live Display Application

In the live display mode, the instrument performs continuous absorbance (ABS) or transmission (%T) measurements in real-time at the single wavelength selected.

The wavelength can be edited by using the sliding scale adjustment bar or by tapping the blue wavelength to edit the value directly. Either ABS or %T can be selected. Each time a change is made, the system should be re-blanked before allowing the Live Display readings to continue.

Once the instrument is blanked, the system will provide automatically real-time and continuous measurements until the X in the upper left corner is tapped.

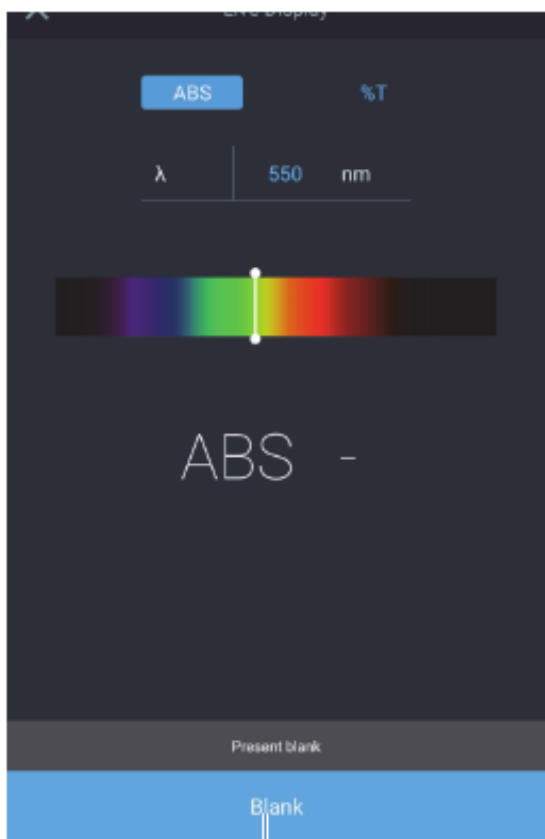

The instrument must be blanked first

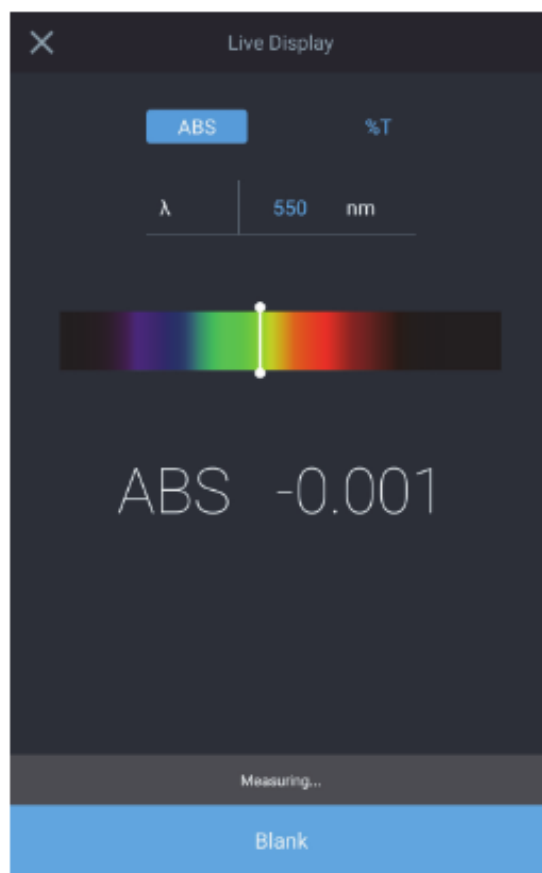







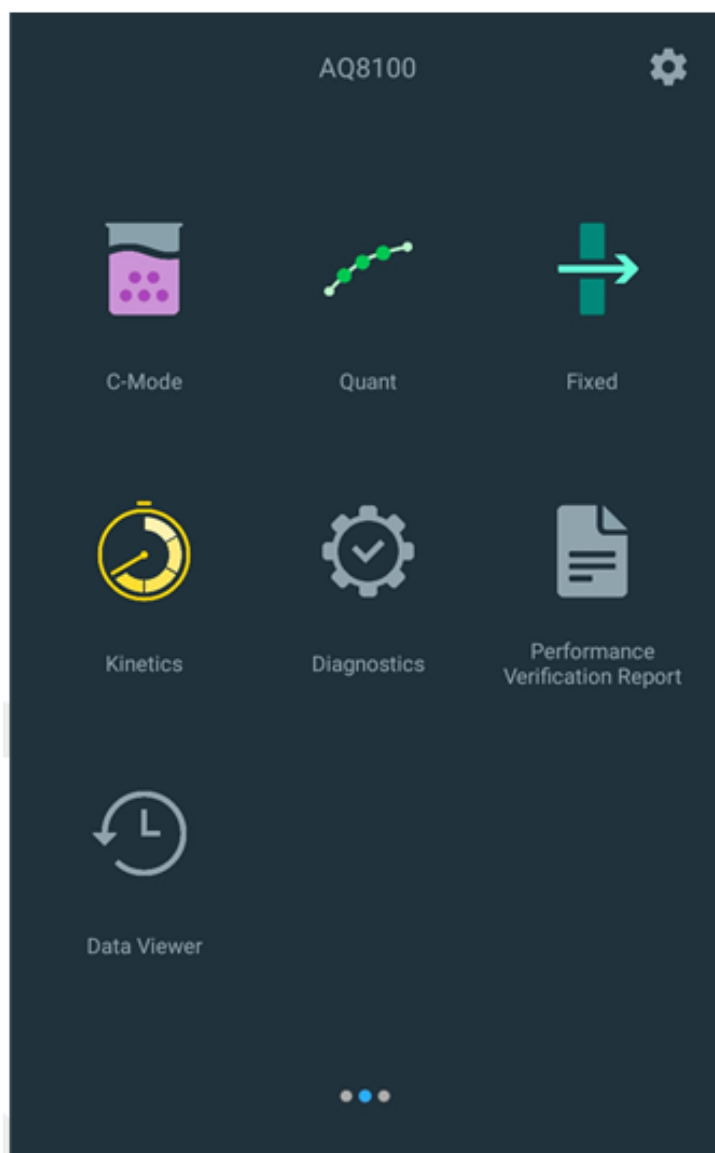

## Screen 2 – Method Development, Diagnostics, and Data

From Screen 1, swipe the to the left to have Screen 2 appear. Any application is selected by tapping the respective icon. The following applications are in Screen 2:

- **C-Mode** – select a wavelength, enter a known standard concentration, and select the units of measure. By blanking and measuring of the standard - a single point calibration report of ABS and calculated Cal Factor are calculated and reported.
- **Quant** – is a calibration curve development application. The user can select the expiration date, wavelength, reference wavelength, equation, units of concentration, and enter the known standards that will be used to develop the curve. **Methods can be saved by name and used to measure subsequent sample concentration.**
- **Fixed** – permits the user to enter a single or multiwavelength method base on 3<sup>rd</sup> party documented data; such as ABS or %T, wavelength\_1, wavelength\_2, units of measure, and the respective wavelength factors, and either a direct, additive, differential, or ratiometric equation. **Methods can be saved by name and used to measure subsequent samples concentration.**
- **Kinetics** – is an active scan at a selected fixed wavelength and optional reference wavelength, over a fixed period of time with data being streamed at a selected intervals and integration period. When the experiment time is reached the experiment has ended. **Methods can be saved by name and used to repeat a kinetics scan.**
- **Diagnostics** – activates a list of performance verifications that can be completed on the instrument. If a scheduled interval is overdue, a red clock icon will appear. These verification intervals are dependent on lab protocol. By selecting one of the available tests and performance verification can be run.
- **Performance Verification Report** – lists the date and number of performance verification experiments ran on that day. By selecting that day, the reports are unfolded and a report can be selected, viewed, and printed and/or exported.
- **Data Viewer** – lists the date and number of experiments conducted on that date. By selecting that day, the reports are unfolded and a report can be selected, viewed, and printed and/or exported.

Below is an image of Screen 2 that can be associated with the descriptions above. A summary legend is provided at the bottom.



-  C-MODE: 1-point cal. @ select  $\lambda$  and units.
-  QUANT: Multi-point cal. curve development.
-  FIXED: Dual -  $\lambda$  and factor measurements.
-  KINETICS - time based experiments
-  DIAGNOSTICS: review verification test reports.
-  PERFORMANCE VERIFICATION REPORTS
-  DATA VIEWER: Logged experimental data.

## C-Mode

C-Mode permits the user to select a wavelength, introduce a known standard concentration, select from the units of measure. By blanking and measuring, the user will have developed a single point calibration and report what the absorbance is and the factor necessary to correlate to the known concentration value that was entered.



# Quant

Quant is a calibration curve development application. The user can select the expiration date, wavelength, reference wavelength, equation, units of concentration, and enter the known standards that will be used to develop the curve. Methods can be saved by name and used to measure subsequent sample concentration

The equation type used to fit the standard measurement data is determined by this equation

Select if 1 or 2 replicates are needed

Save method

Add standards and select curve type

Selects units in which the sample measurements are displayed and printed

Once sufficient unique standard concentration values are provided, the calibrate button is enabled.

The number of unique standard concentration values are determined from the equation of the curve type.

Equation and r-square calculated

Measure is enabled after all standards are measured

Change curve type to find new fit. R-squared value is re-calculated

after sample measurement is complete

New sample

Add standards and select curve type

Standard	Conc [C]	ABS
Blank		
Green Dye Std# 1	1.000	0.257
Green Dye Std# 2	2.000	0.497
Green Dye Std# 3	4.000	0.880

Sample	ABS(629)	Conc [C]
Unknown# 1	0.529	2.255
Unknown# 2	0.513	2.177
Unknown# 3	0.480	1.629

## Quant Options

By tapping on the equation that is listed to the right of the wavelength, a selection of equations will appear. As the complexity of the equation increases, so does the number of points required. Choose the equation that you feel is best suitable. When the multi-point calibration is completed, the resulting equation and the correlation results ( $r^2$ ) will appear. These results are based on the quality of your blank and the accuracy of the standards prepared and entered.

Be sure to save your results by tapping the blue diskette icon in the upper right-hand corner.

The image displays two screenshots from the Orion AquaMate Spectrophotometer app. The left screenshot, titled "New", shows the method configuration screen for "Quant 06-Mar-2019". It includes fields for Method name, Accessory (SETUP), Calibration expiration (Never), Wavelength ( $\lambda$ : 500), Reference  $\lambda$  (None), and a table for Standard 1 with Concentration [mg/mL] of 0.000. Below this is a "Choose Equation" section with options:  $Y = AX$  (Linear through zero),  $Y = AX + B$  (Linear),  $Y = AX^2 + BX$  (Quadratic through zero),  $Y = AX^2 + BX + C$  (Quadratic),  $Y = AX^3 + BX^2 + CX$  (Third order through zero), and  $Y = AX^3 + BX^2 + CX + D$  (Third order). The "Linear" option is selected. The right screenshot, titled "Quant Standards", shows the calibration curve for "Quant 06-Mar-2019\_C". It displays the equation  $Y = -0.004X^2 + 0.057X + 0.000$  and  $r^2 = 1.000$ . A graph plots Absorbance (0 to 0.5) against Concentration (0 to 10). Below the graph is a table of standards:

Standard	Concentration [mg/mL]	Absorbance
Standard 2	2.000	0.098
Standard 3	10.000	0.190

At the bottom, there is an "Add standard" button, a green "Calibration complete" bar, and three buttons: "Blank", "Measure", and "Sample". A blue arrow points to the "Never" calibration expiration field with the text "Tap to expand field".

## Fixed Method Development

Fixed permits the user to enter a single or multiwavelength method base on 3<sup>rd</sup> party documented data; such as ABS or %T, wavelength\_1, wavelength\_2, units of measure, and the respective wavelength factors, and either a direct, additive, differential, or ratiometric equation. Methods can be saved by name and used to measure subsequent samples concentration

Measure absorbance      Measure transmittance

Equation	$ABS(\lambda_1) \times F_1 - ABS(\lambda_2) \times F_2$
Units	-
$\lambda_1$	550 nm
$F_1$	1.000
$\lambda_2$	650 nm
$F_2$	1.000

Result =  $ABS(550) \times 1 - ABS(650) \times 1$

Continue

Select equation template

Method Name: Fixed 16-Feb-2018

Accessory: SETUP

Buttons: ABS, %T

Equation	$ABS(\lambda_1) \times F_1$
Units	-
$\lambda_1$	550 nm
$F_1$	1.000

Result =  $ABS(550) \times 1$

Choose equation

- $ABS(\lambda_1) \times F_1$  (Selected)
- $ABS(\lambda_1) \times F_1 + ABS(\lambda_2) \times F_2$
- $ABS(\lambda_1) \times F_1 - ABS(\lambda_2) \times F_2$
- $(ABS(\lambda_1) \times F_1) / (ABS(\lambda_2) \times F_2)$

## Kinetics Method Testing

Kinetics is an active scan at a selected fixed wavelength and optional reference wavelength, over a fixed period of time with data being streamed at a selected intervals and integration period. When the experiment time is reached the experiment has ended. Methods can be saved by name and used to repeat a kinetics scan. This application is meant to see the reaction or decay of a sample over time.

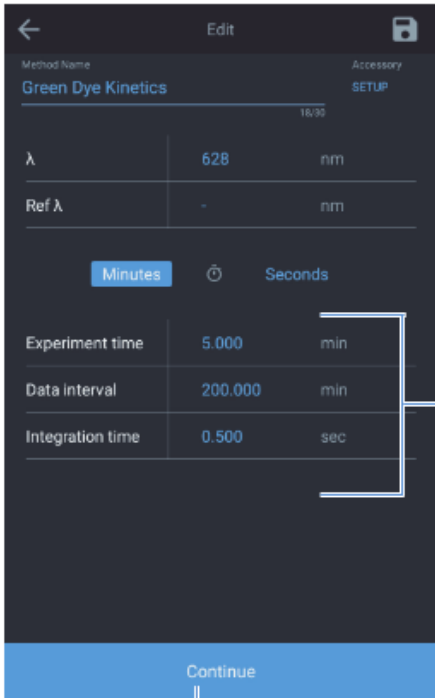

Create new method with settings as shown

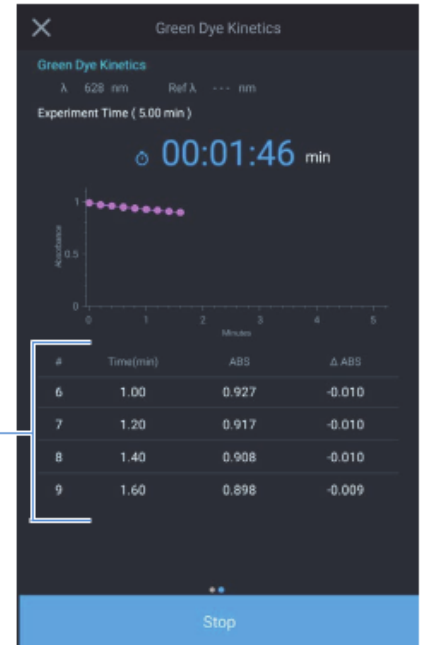
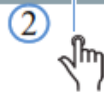
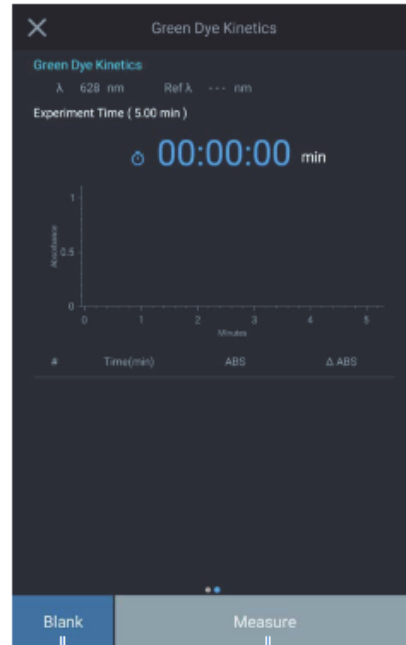

Notice measurements are measured every "interval" time



## Diagnostics Menu

Diagnostic opens a stored list of performance verifications that can be completed on the instrument. If a scheduled interval is overdue, a red clock icon will appear. These verification intervals are dependent on lab protocol. By selecting one of the available tests and performance verification can be run. Tests that require no additional accessories are:

- Wavelength Accuracy
- Drift at 500 nm
- Noise 0.0A at 500 nm
- Baseline Flatness



## Performance Verification Report

Selecting the Performance Verification Reports lists the date and number of performance verification experiments ran on that day. By selecting that day and highlighting a specific experiment, the report will be displayed. These reports are unfolded and a report can be selected, viewed, and printed and/or exported

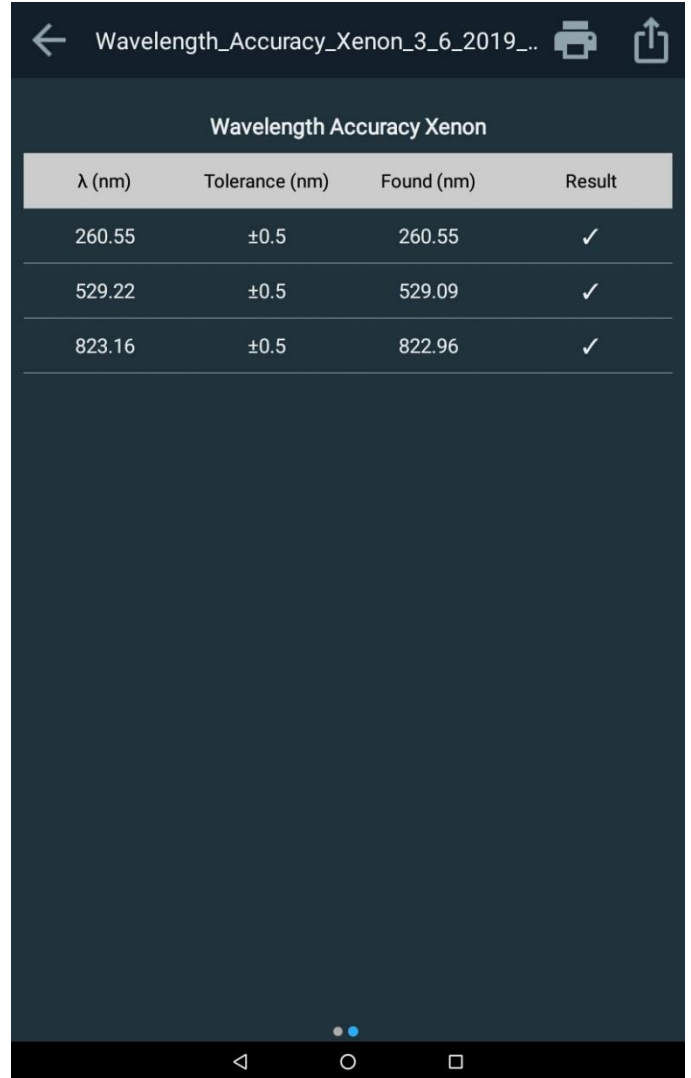
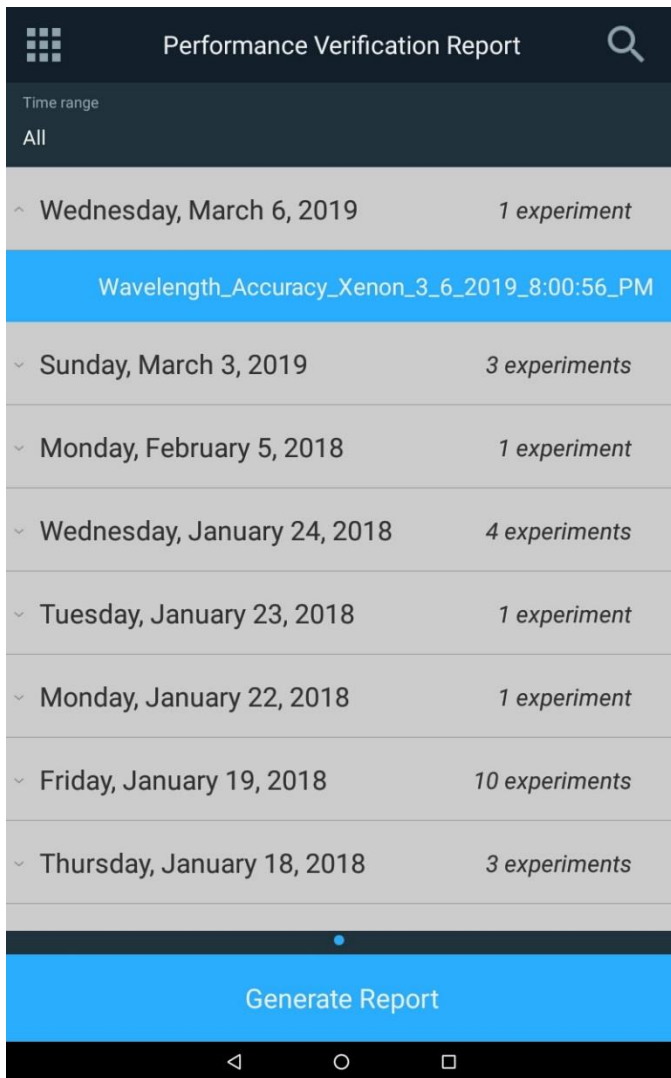

## Data Viewer

When selected, Data Viewer will list the date and number of experiments conducted on that date. By selecting that day, the reports are unfolded and a report can be selected, viewed, and printed and/or exported. You can see the experiment and any graphical data as it appeared on the day of the experiment.

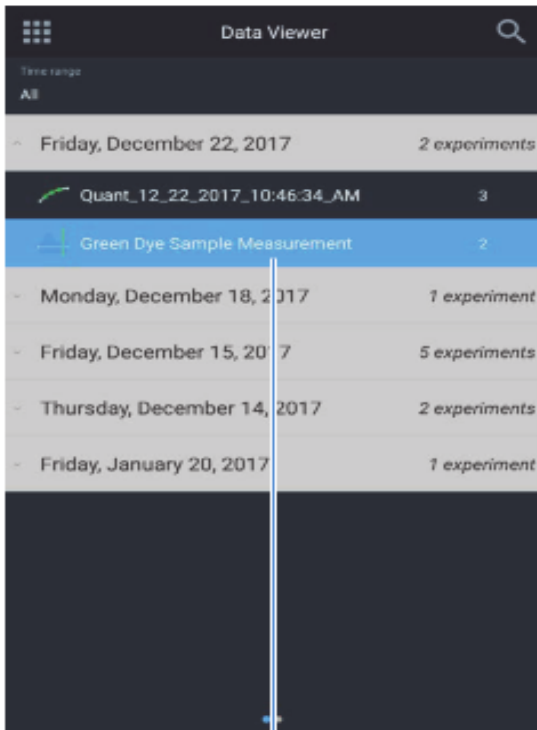

Select experiment data by name



Equation and r-square calculated

## Screen 3 – Multi-wavelength and OD600

From Screen 2, swipe the to the left to have Screen 3 appear. Any application is selected by tapping the respective icon. The following applications are in Screen 3:

- **Multi-wavelength** – The Multiwavelength application obtains multiple fixed-wavelength measurements. It is a fast alternative to scanning if the wavelengths of interest are well known.
- **OD600** – reserved

# Instrument Settings

## Settings

The instrument settings are accessible by tapping the gear in the upper right corner from any main screen. From the settings window the user can:

- SmartStart – activation will only show Smart Methods on the Home Screen.
- Language will permit the user to select English, Deutsch, Italiano, Espanol, Francais, Portuguese, and multiple Asian languages
- Display and Sound will adjust respective intensities
- Network will permit Wi-Fi and Ethernet settings
- Printer will enable network or optional thermal printer settings
- Date and time
- Disk space
- Lamp Status – addressed in maintenance

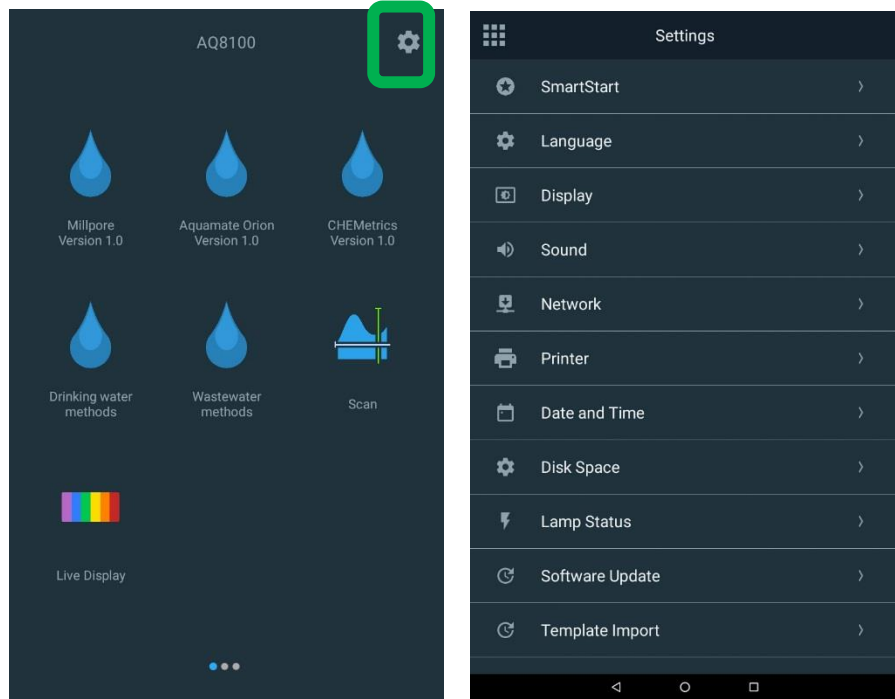

- Software Update

## SmartStart

The following are SmartStart features:

- Shows only methods tagged as a SmartStart
- Displays or hides Data Viewer
- Locks SmartStart mode with optional password protection; thus limiting the user to only the methods made available
- Has an abbreviated Settings menu to limit setting adjustments.

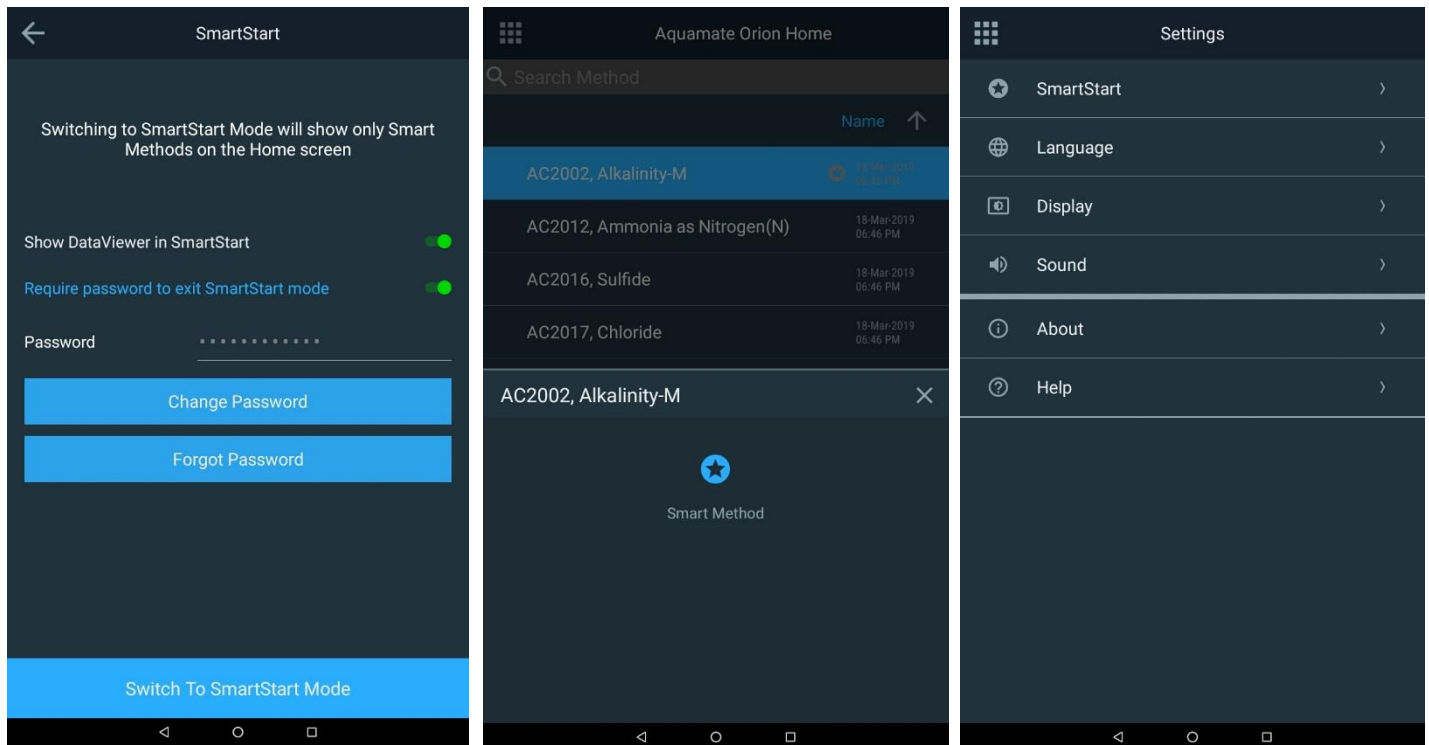

### Unlocking SmartStart

The user must have the password of a USB Password Reset Key to unlock the instruments. If the password cannot be remembered, you will have to contact your technical support team to request a key be sent to you.

## Language

Several languages are available for selection. Please select the language that is suitable to meet your needs. If there are any issues with the language accuracy, please contact technical support at [wlp.techsupport@thermo.com](mailto:wlp.techsupport@thermo.com).

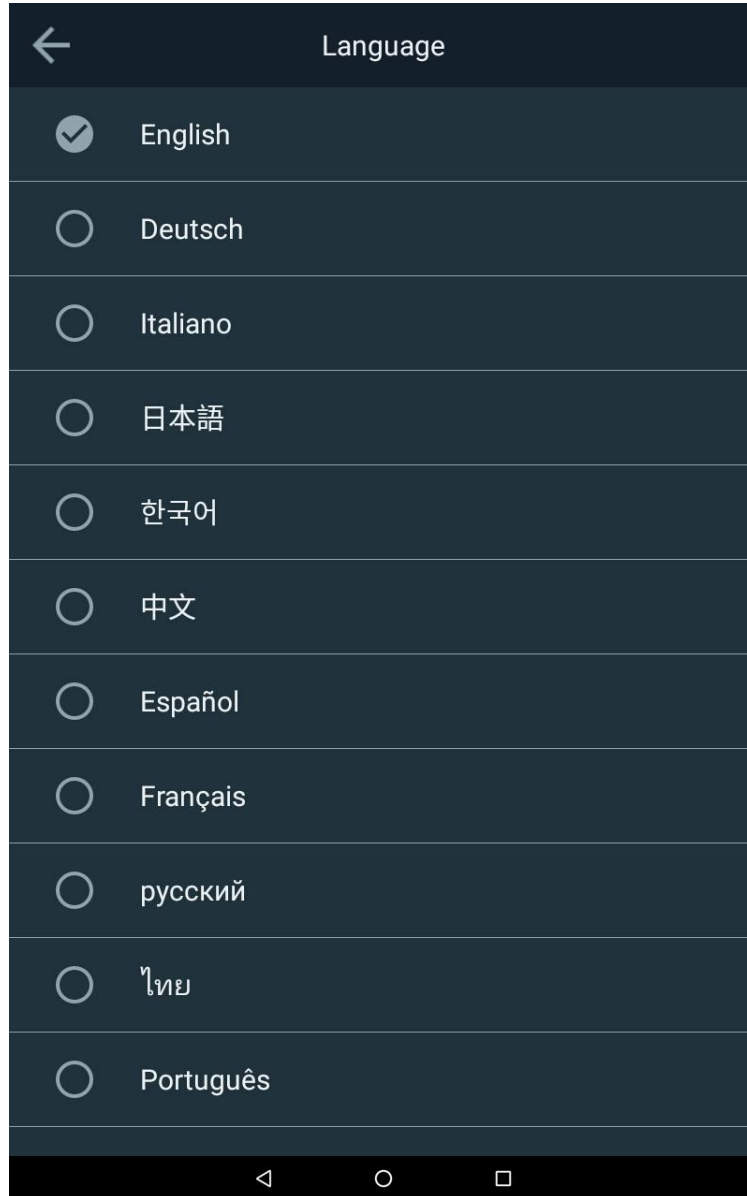

## Display, Sound and Network

Below are the screen images for the display adjustment, sound adjustment, and the network settings.

If a network path cannot be established, please contact your system administrator.

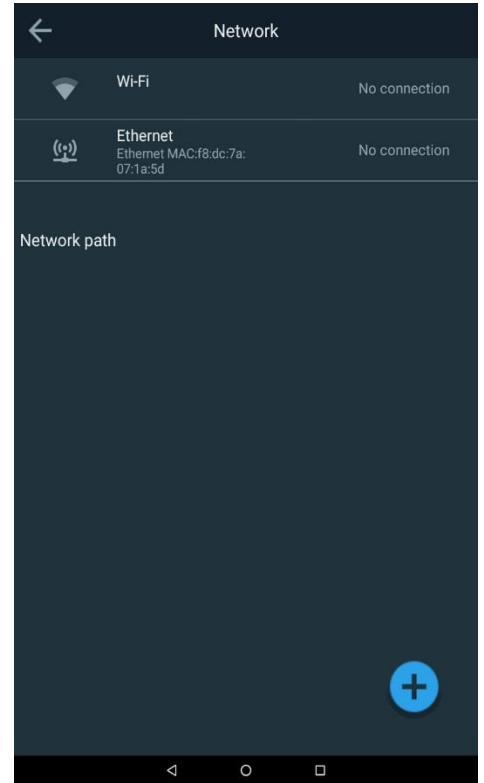
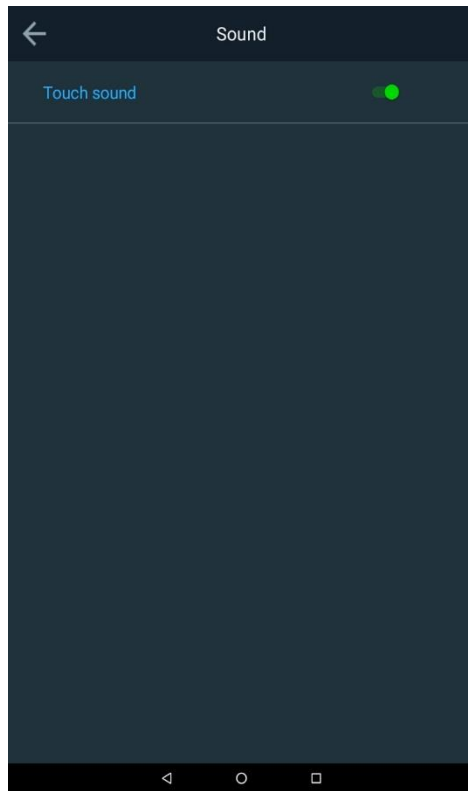
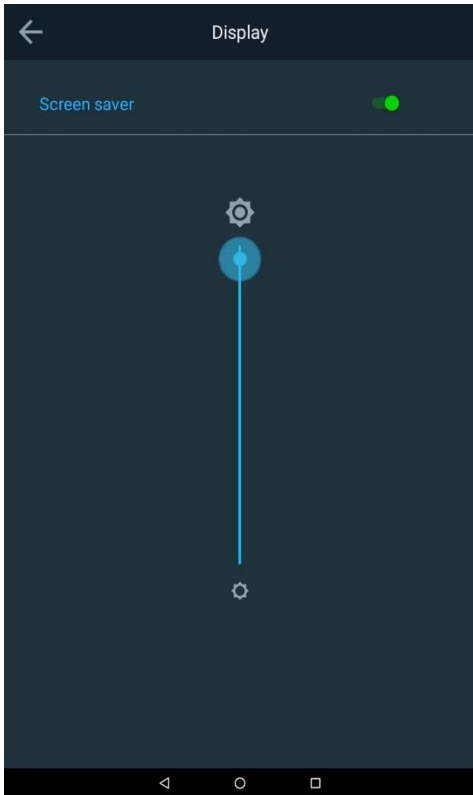



## Printer Settings

Below are the printer settings window. If you have a thermal printer option, please reference Section 2 of this manual.

The user can select either a Thermal printer or a USB/Network printer for configuration. The report header can be configured to reflect the use case for the spectrophotometer.

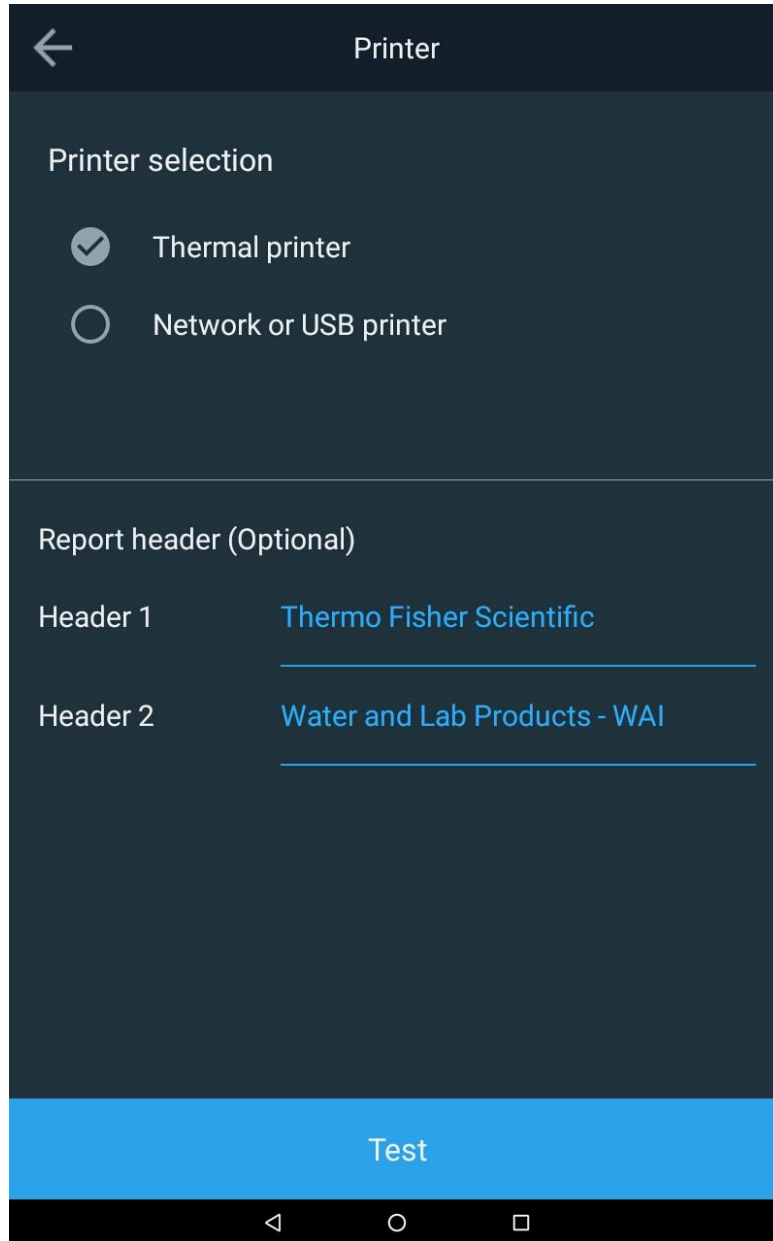

## Date and Time

In this Settings menu you can adjust the date, Time and time format.

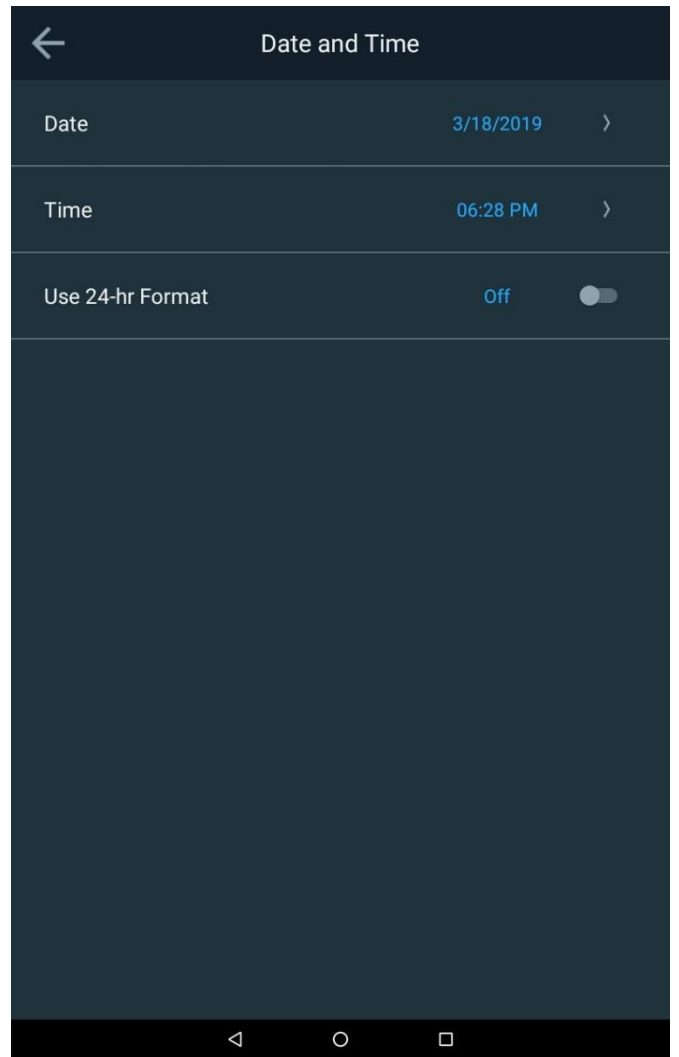
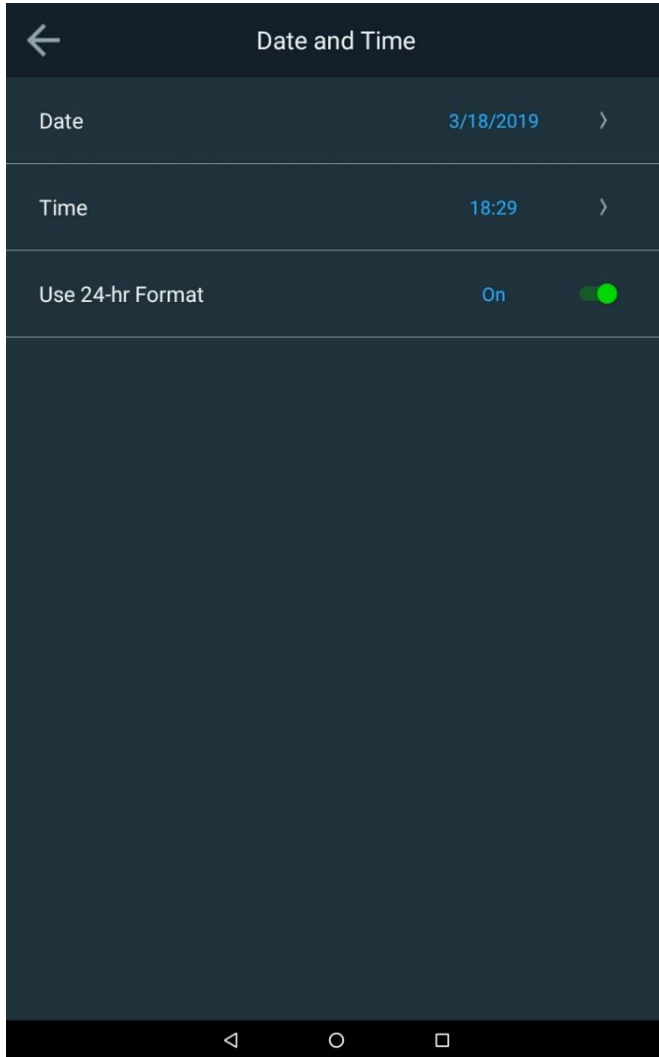

## Disk Space and Lamp Status

IN the following screens, both the available memory and lamp life are available for reference. If the lamp is changed, the lamp life should be reset.

**NOTE:** For the 7100 AquaMate, the tungsten lamp should be placed in a lamp saver mode and will shut off after 15-minutes of non-use. Please remember that the Tungsten lamp will need to be warmed-up to get accurate results.

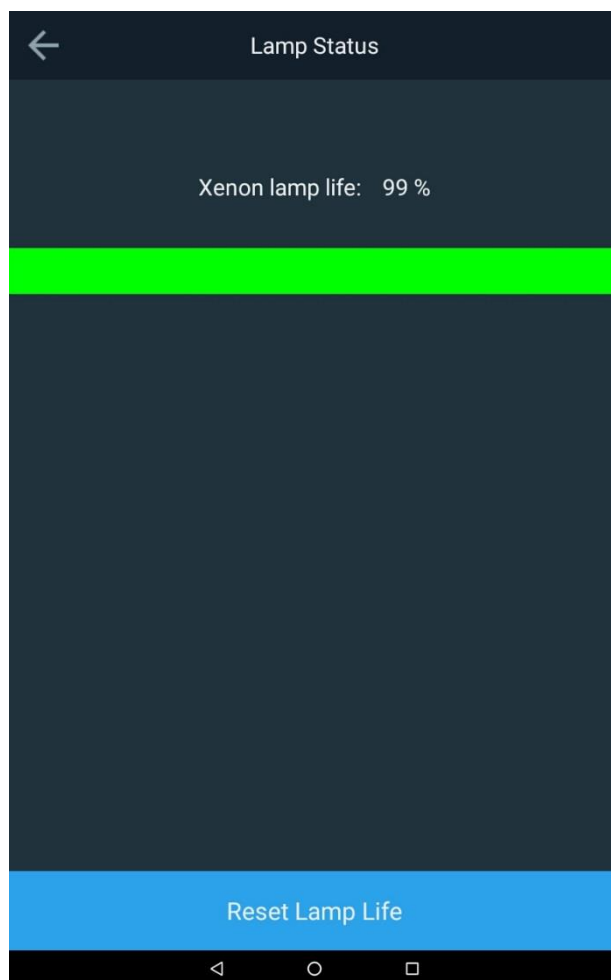
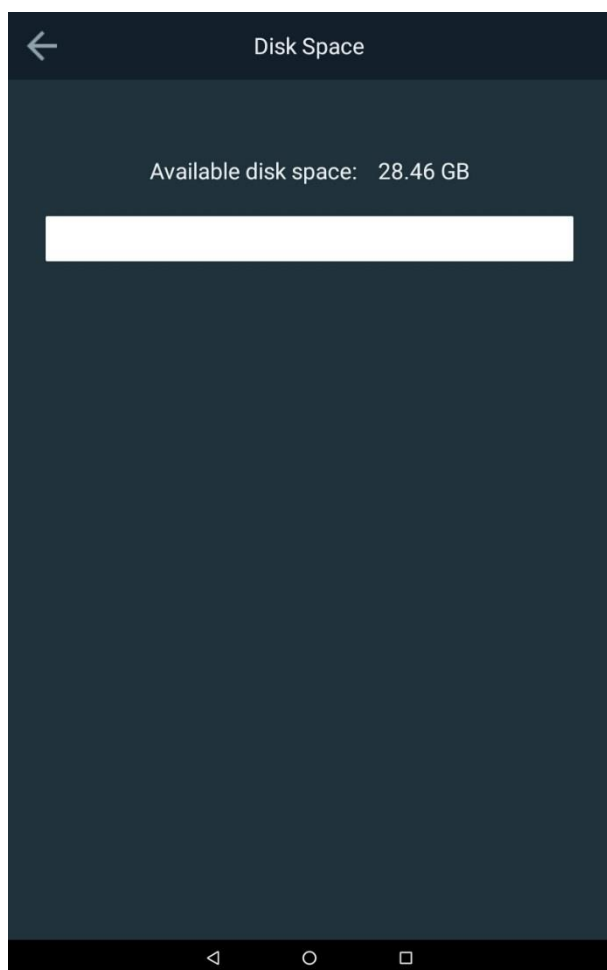

## Software Update

The Software Updates allow two updates to be made. The first is the firmware update and the second is specific to updating the water method library. Water Methods are only specific to AquaMate Spectrophotometers and are typical of any aqueous method that utilizes reagent chemistry for results. If for any reason you are unable to update your library methods, please contact technical support with your specific model and serial number.

## Software Update

For a software update, contact [wp.techsupport@thermofisher.com](mailto:wp.techsupport@thermofisher.com) for the latest firmware and library methods and place these on your USB stick. Insert the stick into the front USB port. Tap on Update Software. Tap on the most recent release date version and tap on Update. The instrument will self-guide you through the process and will automatically reboot itself.

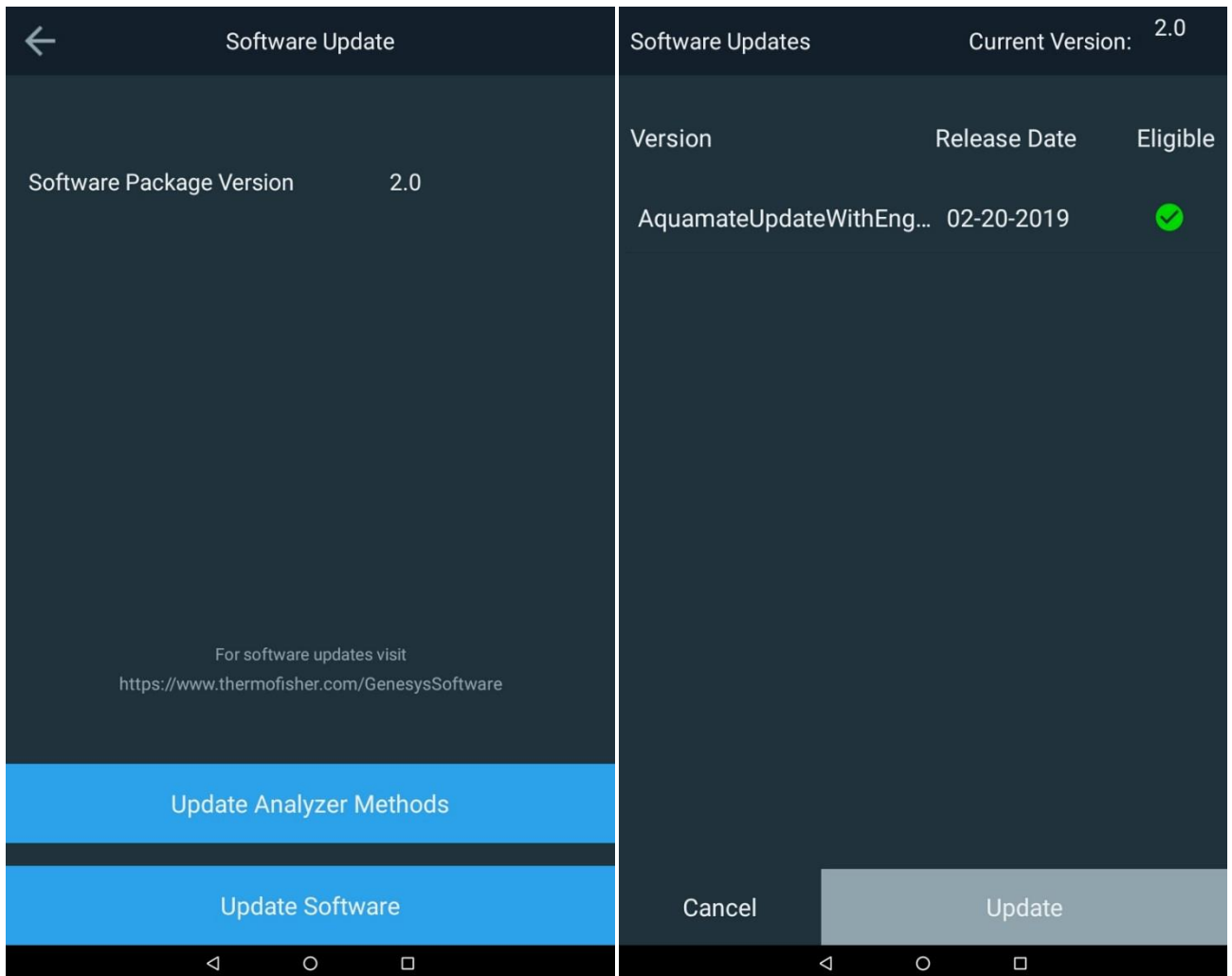

## Water Methods Library Package Update

For a library update, contact [wlp.techsupport@thermofisher.com](mailto:wlp.techsupport@thermofisher.com) for the latest water methods package and place these on your USB stick. Insert the stick into the front USB port. Tap on Update to Update Analyzer Methods. Tap on the most recent AquaMate package (e.g., aquamate 1.X) and tap on Activate. The instrument will automatically activate and replace the method libraries. No reboot is required. The red X will turn to a green check mark.

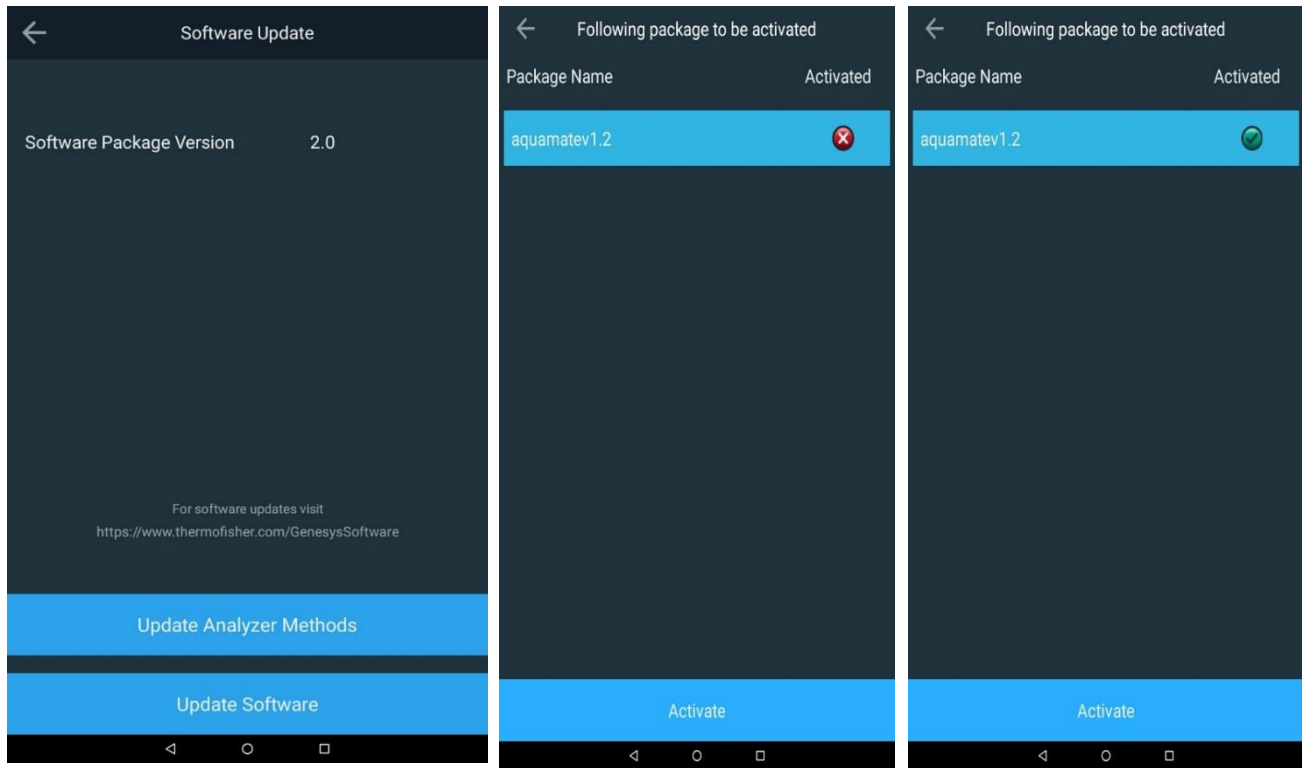

## Ending and Exporting Experiments

When your measurements are completed, tap the End Experiment and the experiment will be saved with the Name that appears in blue.

In the fields below, you can:

- Go Back
- Edit experiment name before ending
- Send results to a printer as a report
- Export results to a file (USB or network link)

Go Back to experiment →

Edit experiment name →

Send to printer →  
Export to file →

Confirm experiment is ended. →

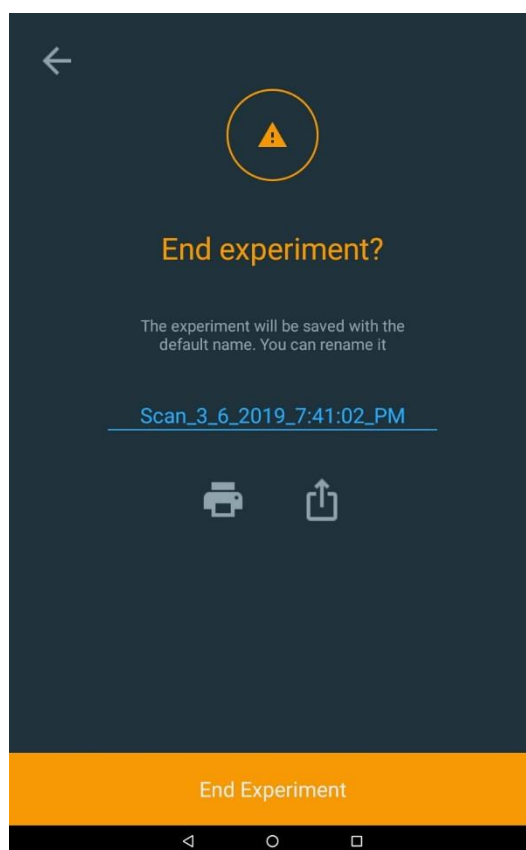

## Exporting Data

If you choose to export your data, be sure to have setup a network path via Ethernet or via WiFi. A typical method is to save the data directly to a USB drive. The report can be saved as both a CSV file and/or a JPEG file.

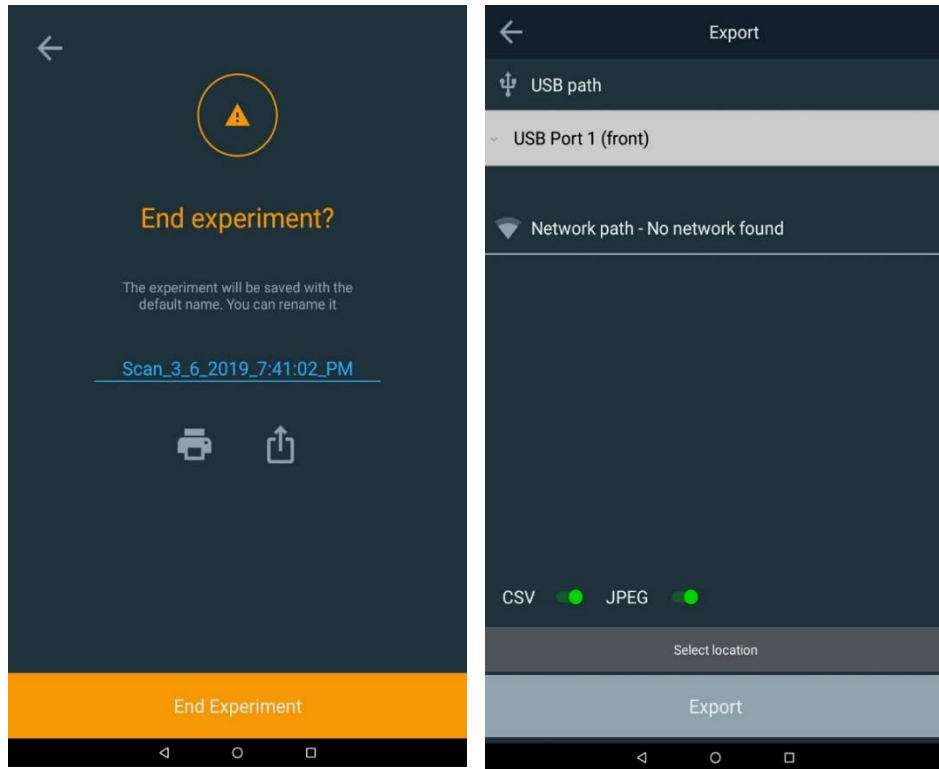

Below is an example of the USB file directory and a JPEG file image of the experiment.

Name	Date modified	
2.1.zip	4/2/2019 12:26 PM	
aquamatev1.5.pkg	3/27/2019 1:46 PM	
Aquamate Experiment Data	4/11/2019 1:48 PM	
Aquamate Log	3/28/2019 6:16 PM	

Scan_3_6_2019_7_41_02_PM.csv	3/28/2019 6:17 PM	Microsoft Excel Co...
Aquamate_4_9_2019_4_35_06_PM.csv	4/11/2019 1:48 PM	Microsoft Excel Co...
Scan_3_6_2019_7_41_02_PM.jpeg	3/28/2019 6:17 PM	JPEG image
Aquamate_4_9_2019_9_23_32_AM-2.jpeg	4/11/2019 1:48 PM	JPEG image
Aquamate_4_9_2019_9_23_32_AM-1.jpeg	4/11/2019 1:48 PM	JPEG image
Aquamate_4_9_2019_4_35_06_PM.jpeg	4/11/2019 1:48 PM	JPEG image

An orange arrow points from the "Aquamate Experiment Data" folder in the top table to the "Scan\_3\_6\_2019\_7\_41\_02\_PM.jpeg" file in the bottom table.

Scan\_3\_6\_2019\_7:41:02\_PM

1 / 1

28-Mar-2019 06:16 PM

Instrument Serial #: 9A3V205001

Method name: Quick scan

Instrument model: AQ8100

Method created: 26-Mar-2018 08:14 AM

Software Package Version: 2.0

Signature:

Method updated: 26-Mar-2018 08:15 AM

Scan: method parameters

Range **500 - 700 nm**

Interval **2.0 nm**

Speed **Fast**

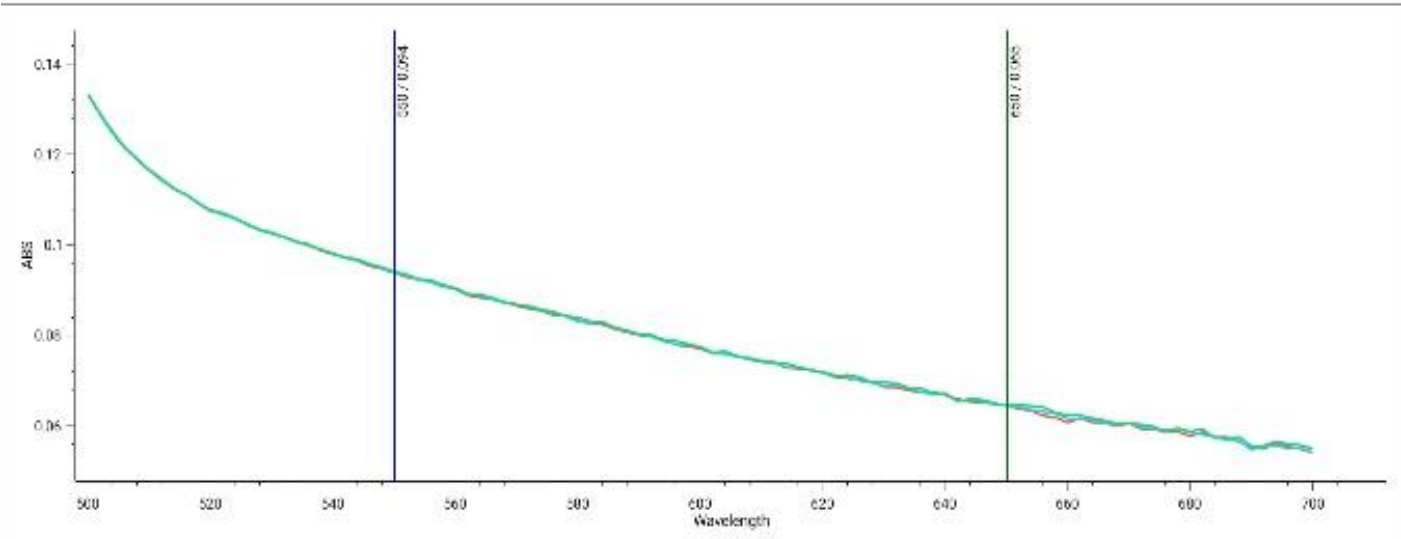

Sample	ABS(550)	ABS(650)
Mt. Dew 1	0.094	0.065
Mt. Dew 2	0.094	0.064
Mt. Dew 3	0.094	0.065



# 4

## CHAPTER 4 **Water Analysis Test Menu**

### Preprogrammed Methods

Thermo Scientific Orion AquaMate 8100 UV-Vis and AquaMate 7100 Vis spectrophotometers include over 260 preprogrammed methods for use with Thermo Scientific™ Orion™ AQUAfast™, Merck, and CHEMetrics reagent chemistries. Preprogrammed methods provide values for the test parameters required to run specific reagent chemistries on the instrument, including wavelength, vial path length, concentration factors/curves and measurement units. Any methods that have a regulatory approved for wastewater or drinking water have are conveniently duplicated within their respective droplet folders.

All preprogrammed methods and documentation are stored on the instrument as a methods library package and is also available via USB memory stick. The pre-programmed methods are specific to AquaMate Spectrophotometers only. Operators can modify preprogrammed methods or create their own custom methods, so additional parameters and test methods can be added at any time.

AquaMate instruments allow a one-point adjustment on any preprogrammed method using a known standard to correct for variations in batch-to-batch reagent chemistries.

The following instructions are for using Orion AQUAfast reagent, Merck or CHEMetrics chemistries with the AquaMate spectrophotometer. Preprogrammed methods use a specific vial size (path length) in the formula and the vial size specified in these instructions must be used for accurate analysis. The majority of AQUAfast reagent methods use a 24mm round vial, Cat No. AC2V24 or 16mm round vial, Cat. No. AC2V16. Other vial sizes are noted in the individual reagent chemistry instructions.

# Method Selection and Experiment

## Droplet Folder Methods

Choose any Droplet icon folder to list the methods within that folder. To jump to familiar regulatory methods for drinking water or wastewater, select that folder. Once in the folder, methods can be sorted by a name, date of creation, date last updated, or date last used. You may also search for a method within each respective folder either by typing the method number or by typing the method parameter.

Method descriptions provided detail the method number, parameter, wavelength, vial type and size, as well as detailed information about the method itself. Follow the method directions per reagent instructions in Chapter 5 or per vendor instructions.

**NOTE:** By tapping the ellipsis of a selected method description screen, a SmartStart option will appear if you would like to select this method for SmartStart.

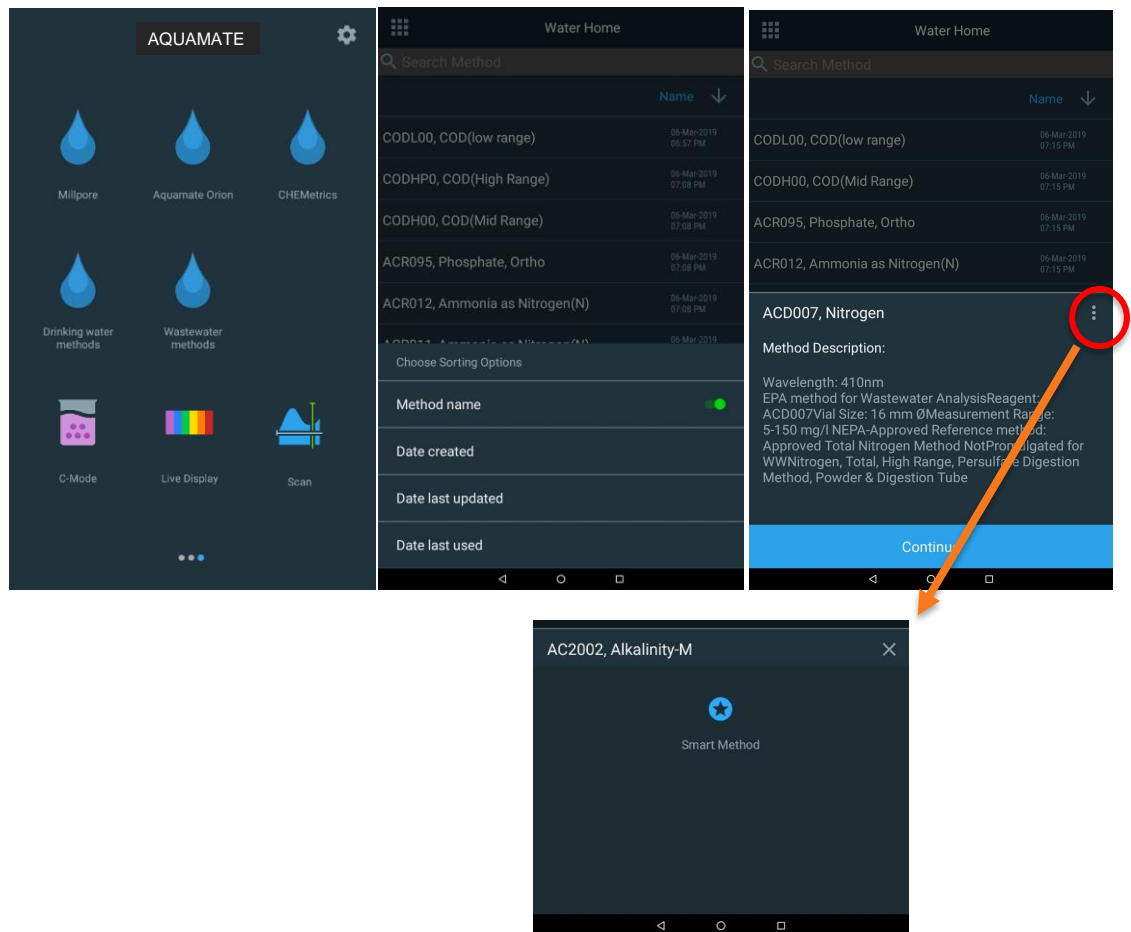

**Note:** Please refer to the method description for measurement capabilities for each method. This instrument will report values outside of the stated range capabilities that may not be acceptable for the user's specific purpose or for regulatory reporting requirements.



## Method Options

Within the method selected, the fields that appear in blue are normally editable fields. In the example below, the Sample Base Name (Sample), can be customized by using the alphanumeric touchscreen field that appears when tapped. When the field being edited is complete, press the Done key on the touchscreen keypad.

- Prepare the blank solution, insert and blank
- If you are working with a new batch or reagents, you have the option of preparing a known and traceable standard, edit the Standard Concentration Value, and tap Re-calibrate. This will update the Calibration Factor. Otherwise, move onto Measuring.
- Insert the prepared sample and tap Measure to get the results.

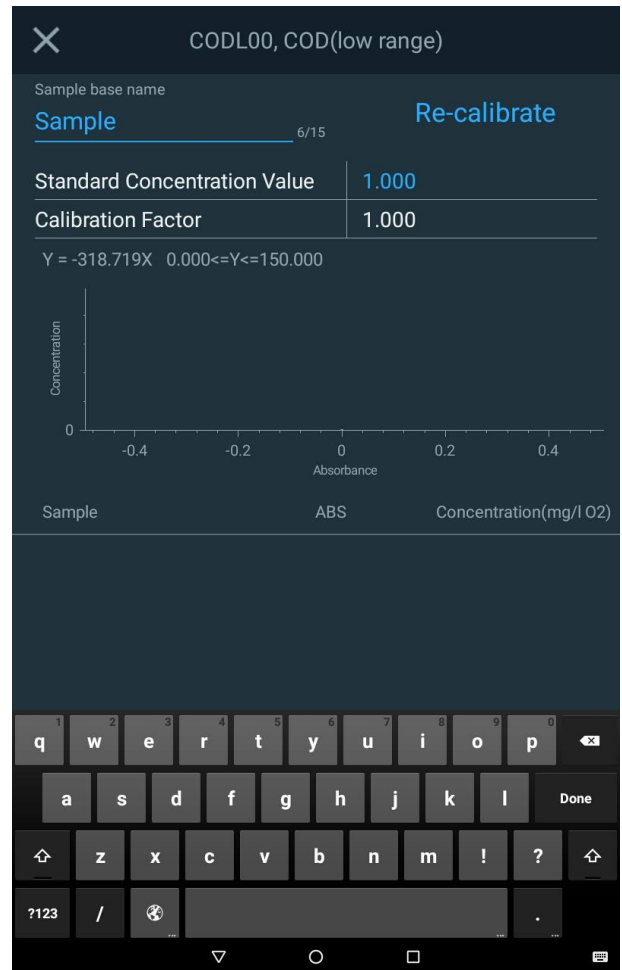
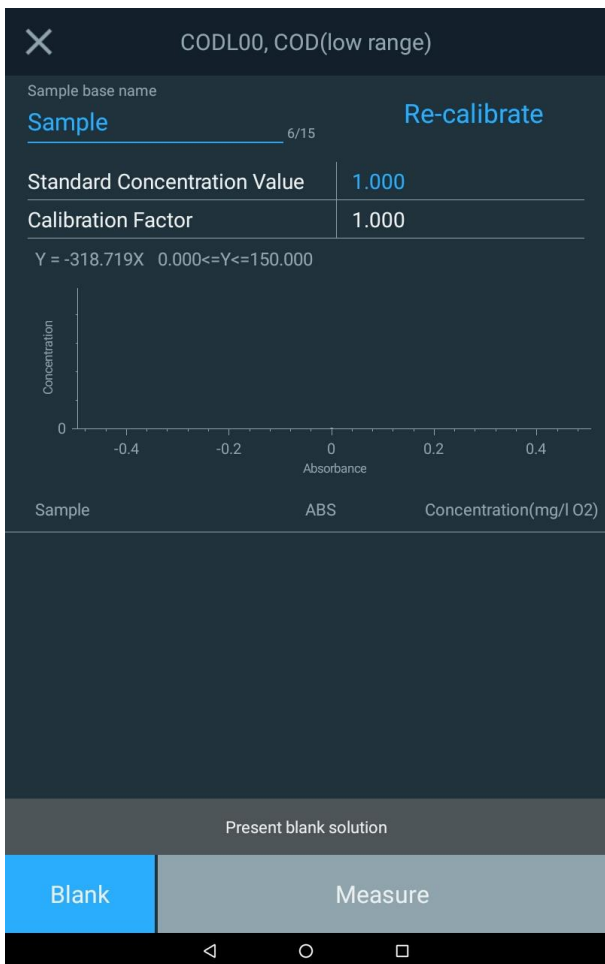

## Method Sample Increments

When measuring the concentration of any sample via any method or application, using the Sample Base Name the Sample name will increment by 1 each time you press Measure, as you can see below within the red circles.

End experiment

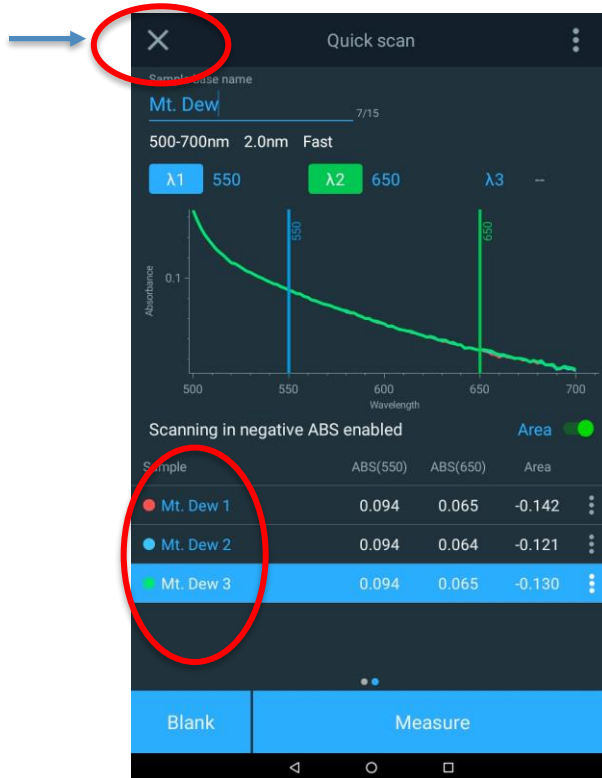

## Loading Test Methods from the AquaMate Instrument

1. Select a Droplet Folder
2. Search by either method number or by parameter
3. Select the method
4. Review the description and be sure to use the vial size specified.

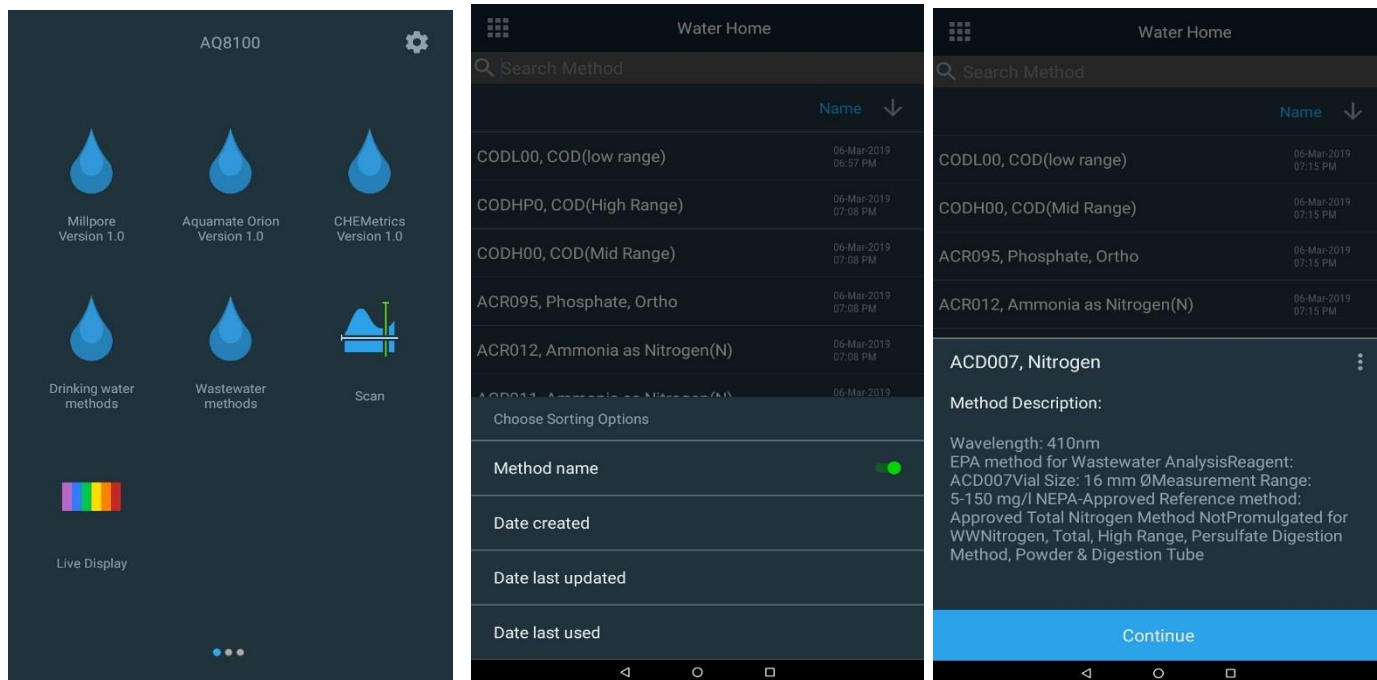

## Running Water Analysis Test Methods

1. When a preprogrammed test method has been loaded, an experiment window will appear.
2. Tap the Sample Base Name for editing (e.g., COD Site A) using the pop-up keyboard
3. Open the sample compartment door.
4. Insert a vial containing the blank or zero solution into the sample holder.

**Note:** Ideally, the same vial should be used or one that has been matched to the sample vial.

5. Close the lid and tap the **Blank** function key.
6. Open the lid and remove the vial containing the blank or zero solution.
7. ***If Single-Point calibration is warranted, follow the procedure detailed in the following section.***
8. Place the vial containing the sample into the sample holder and close the lid.
9. Tap the **Measure** function key. The results will be displayed. Sequential measurements can typically be made for multiple samples.
10. To save, tap the X in the upper left corner, end and save the experiment
11. The data will be automatically saved with name, date and time stamp per the name selected (e.g., Scan\_3\_6\_2019\_7\_41\_02\_PM)

**Note:** The blank measurement is stored and used while working in the sample test method. The blank measurement will be cleared automatically if any test method settings are changed, if the test method is saved, or if a new test method is loaded.

**Note:** When running a reverse color test method, a reagent blank measurement is required after the standard blank. Insert the vial containing the reagent blank and press the **Blank** function key. Open the lid and remove the reagent blank. See the [Using the Reverse Color Feature](#) section for detailed instructions.

**Note:** If the Statistics option is set to Off, statistics will not be displayed.

Below appears an example screen for a COD method and the typical fields highlighted in blue that may require attention. Furthermore, the final screen that addresses ending and experiment, naming the experiment, printing and exporting experiment results.

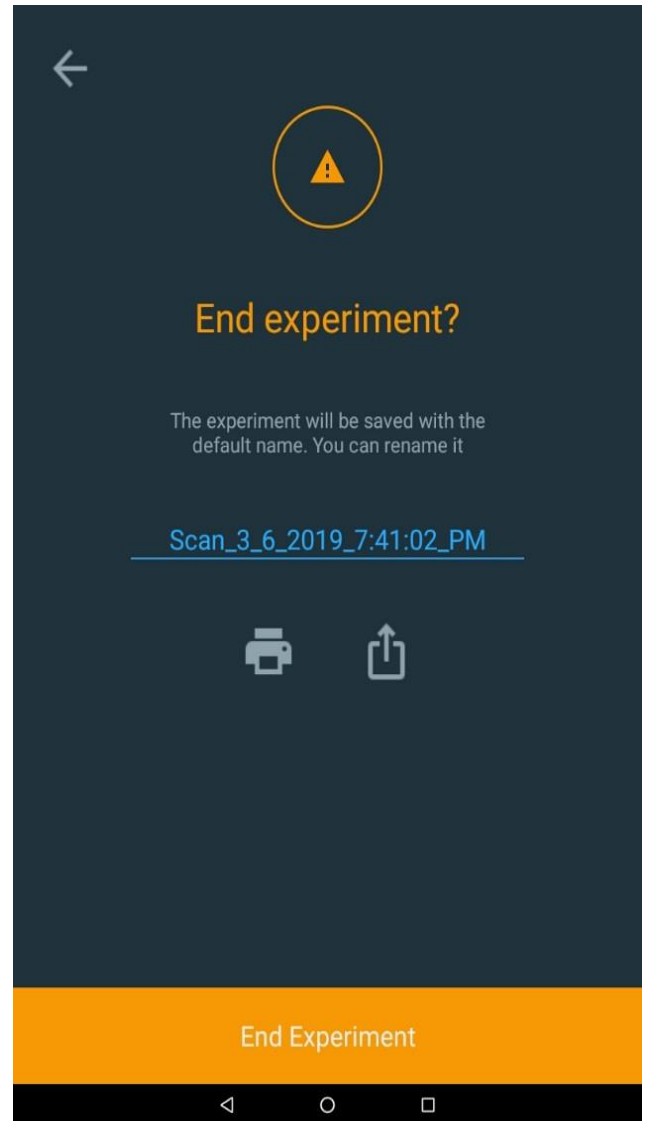
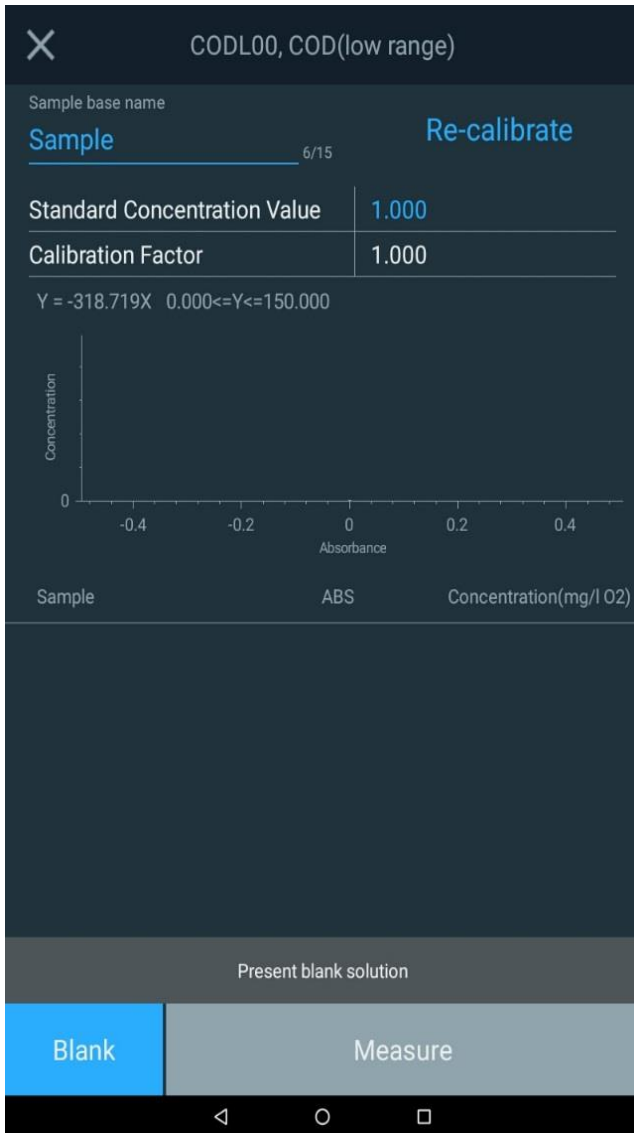



## Single Point Method Adjustment

Any method can be adjusted by a single point calibration.

- First edit the Standard Concentration Value from 1.000 by tapping the value and enter the value of the standard concentration prepared for this purpose.
- After blanking the system, insert the prepared Standard into the sample holder.
- Tap the Re-Calibrate field
- Typically, a Calibration Factor of 0.7 to 1.3 (within  $\pm 30\%$ ) is acceptable.
- The sample vial can now be placed into the sample holder and Measure can be conducted.

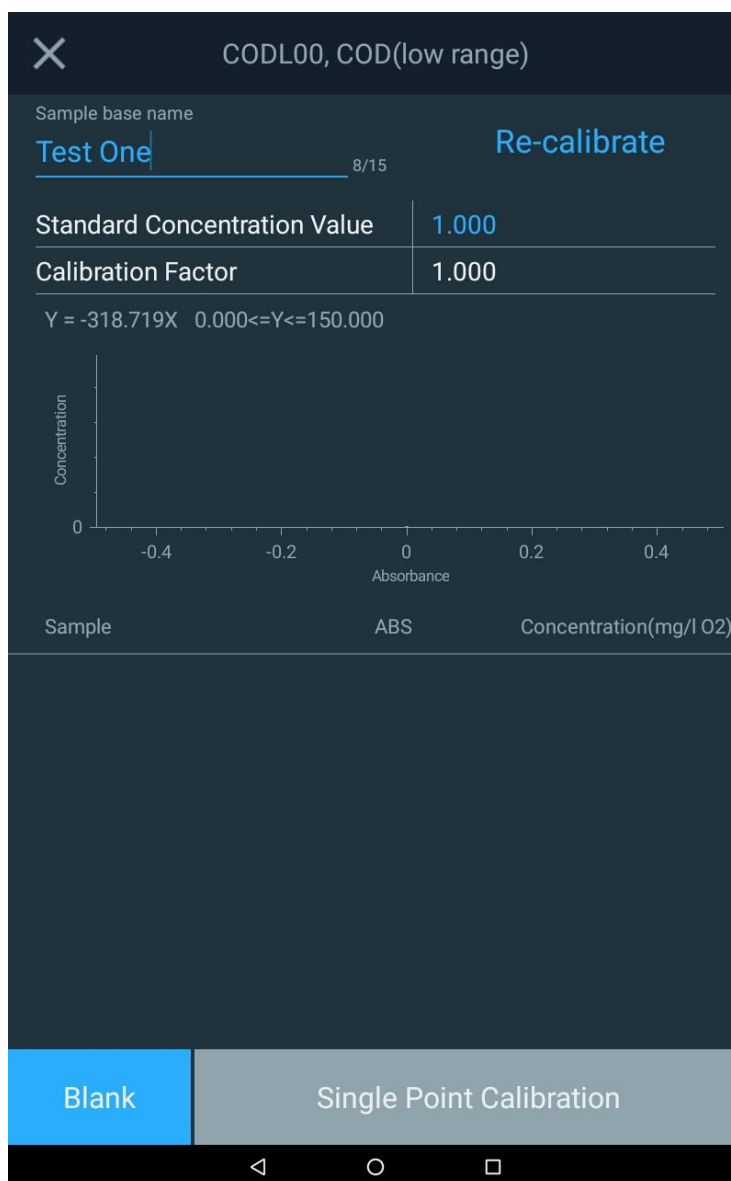

## Using the Reverse Color Feature

Reverse color methods use a reagent that, when prepared with samples, decreases in color as the concentration of the species being measured in the samples increases. Reverse color methods require the use of a reagent blank. The reagent blank is a mixture of the initial reagent and sample (e.g., zinc by zincon method) and provides a zero concentration point with the darkest color (highest absorbance). The color of samples prepared with the reagent will decrease as the concentration increases. The image below shows the results of a typical reverse color method and the following provides an overview how to perform a reverse color method.

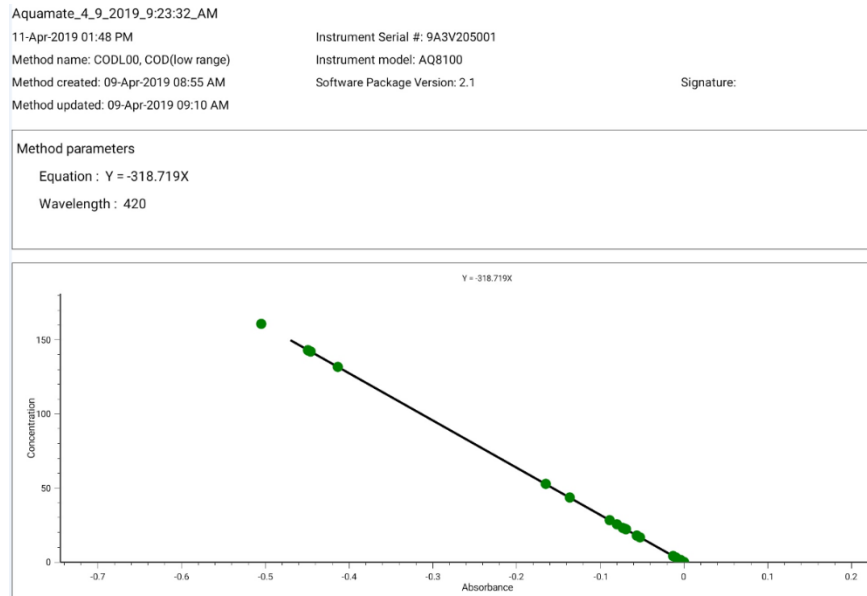

1. Load the test method in the Water Analysis test menu. The Reverse Color (Negative ABS) option should be set to **ON** for the method.
2. Prepare the sample reagent blank into the vial defined by the method.
3. Place the vial into the holder in the sample chamber and close the chamber door.
4. Press the **Blank** function key to measure the reagent blank.
5. Open the sample chamber door and remove the vial from the holder.
6. Follow the method directions and prepare the sample to be measured.
7. Place the vial into the holder in the sample chamber and close the chamber door.
8. Press the **Measure** function key to display the results.
9. Continue to run additional samples as needed.
10. When complete, end the experiment and export or print the data.

# 5

## CHAPTER 5 Orion AQUAfast Reagent Chemistry Instructions for Orion AquaMate

### Orion AQUAfast Colorimetric Reagents Compatible with Orion AquaMate Instruments

Use the information in the following table to identify the Orion AQUAfast reagent method file name on AQ7100 or AQ8100 and the test parameters associated with each method. This information is also included on the Orion AquaMate user documentation CD or on our website at [www.thermoscientific.com/water](http://www.thermoscientific.com/water).

Parameter	Part #	Method	Description
Alkalinity	AC2002	AC2002	Alkalinity-M Tablet Reagent
Alkalinity	AC3002P	AC3002P	Alkalinity-P Tablet Reagent
Aluminum	AC2027	AC2027	Aluminum Tablet Reagent
Aluminum	AC4P27	AC4P27	Aluminum Powder Pack & Liquid Reagent
Ammonia	AC2012	AC2012	Ammonia Tablet Reagent
Ammonia	AC4P12	AC4P12	Ammonia Powder Pack Reagent
Ammonia	ACR012	ACR012	Ammonia Low Range Reaction Tube Reagent
Ammonia	ACR011	ACR011	Ammonia High Range Reaction Tube Reagent
Bromine	AC2035	AC203524	Bromine Tablet Reagent
Chloride	AC2017	AC2017	Chloride Tablet Reagent
Chlorine	AC2070	AC207024	Chlorine (Free & Total) Tablet Reagent
Chlorine	AC2071	AC207124	Chlorine (Free) Tablet Reagent
Chlorine	AC2072	AC207224	Chlorine (Total) Tablet Reagent
Chlorine	AC4P71	AC4P71	Chlorine (Free) Powder Pack Reagent

Parameter	Part #	Method	Description
Chlorine	AC4P72	AC4P72	Chlorine (Total) Powder Pack Reagent
Chlorine	AC3072	AC3072	Chlorine (Total) High Range Tablet Reagent
Chlorine Dioxide	AC2099	AC209924	Chlorine Dioxide Tablet Reagent
COD	CODL00	CODL00	COD Low Range Digestion Tube Reagent
COD	CODH00	CODH00	COD Mid-Range Digestion Tube Reagent
COD	CODHP0	CODHP0	COD High Range Digestion Tube Reagent
Copper	AC2029	AC202924	Copper (Free & Total) Tablet Reagent
Copper	AC4P29	AC4P29	Copper (Free) Powder Pack Reagent
Cyanuric Acid	AC2098	AC2098	Cyanuric Acid Tablet Reagent
Fluoride	AC2009	AC2009	Fluoride SPADNS Liquid Reagent
Hardness	AC3032T	AC3032TL	Hardness (Total) Low Range Tablet Reagent
Hardness	AC3032T	AC3032TH	Hardness (Total) High Range Tablet Reagent
Hydrazine	AC2030	AC2030	Hydrazine Powder Reagent
Iron	AC2078	AC207824	Iron (II & III) Tablet Reagent
Iron	AC4P78	AC4P78	Iron (Ferro) Powder Pack Reagent
Iron	AC4P79	AC4P79	Iron (Total) Powder Pack Reagent
Manganese	AC2055	AC2055	Manganese Tablet Reagent
Manganese	AC4P54	AC4P54	Manganese Low Range Powder Pack & Liquid Reagent
Manganese	AC4P55	AC4P55	Manganese High Range Powder Pack Reagent
Molybdate	AC4P42	AC4P42	Molybdate/Molybdenum Powder Pack Reagent
Nitrate	ACR007	ACR007	Nitrate Reaction Tube Reagent
Nitrite	AC2046	AC2046	Nitrite Tablet Reagent
Nitrite	AC4P46	AC4P46	Nitrite Powder Pack Reagent
Nitrogen, Total	ACD004	ACD004	Nitrogen (Total) Low Range Digestion Tube Reagent
Nitrogen, Total	ACD007	ACD007	Nitrogen (Total) High Range Digestion Tube Reagent
Ozone	AC3048	AC3048	Ozone Tablet Reagent
pH	AC2001	AC2001	pH Tablet Reagent
pH	AC3001	AC3001	pH Liquid Reagent
Phosphate	AC2095-WA	AC2095	Phosphate (Ortho) Low Range Tablet Reagent
Phosphate	AC2096	AC2096	Phosphate (Ortho) High Range Tablet Reagent
Phosphate	AC4P95	AC4P95	Phosphate (Ortho) Powder Pack Reagent
Phosphate	ACR095	ACR095	Phosphate (Ortho) Reaction Tube Reagent
Phosphate	ACD095	ACD095	Phosphate (Total) Digestion Tube Reagent
Phosphate	ACD095AH	ACD095AH	Phosphate (Acid Hydrolysable) Digestion Tube Reagent
Silica	AC2060	AC2060	Silica Tablet Reagent
Silica	AC2061	AC2061	Silica with Phosphate Removal Tablet Reagent
Silica	AC4P60	AC4P60	Silica Powder Pack Reagent
Sulfate	AC4P82	AC4P82	Sulfate Powder Pack Reagent
Sulfide	AC2016	AC2016	Sulfide Tablet Reagent
Zinc	AC2065	AC2065	Zinc Tablet Reagent

# Orion AQUAfast Reagent Instructions

The measurement ranges specified in the following test procedures are based on standard solutions measured under ideal conditions. These ranges may vary due to the type of sample being measured, since various interferences can have a major influence on the accuracy of the method. Because each sample is different, the only way to check the tolerance (precision) is the Standard Additions Method. According to this method, first the original sample is tested. Then further samples (2 to 4) are taken and small amounts of a standard solution are added and further results are obtained. The amounts added range from approximately half, up to double the amount present in the sample itself. These supplementary results make it possible to estimate the actual concentration of the original sample by comparison.

Test methods and ranges are subject to change without notice. For a list of the most up-to-date test methods, visit [www.thermoscientific.com/water](http://www.thermoscientific.com/water).

## Recommendations for Avoiding Measurement Errors

- Thoroughly clean vials, caps and stir rods after each analysis to prevent carry-over errors. Even minute reagent residues lead to incorrect measurements.
- Ensure that the outer walls of the vials are dry and clean before performing the analysis. Fingerprints or water droplets on the light entry surfaces of the vials lead to incorrect measurements.
- **Blank** and measurement procedures should be performed using the same vial whenever possible, since different vials can possess slightly different tolerances.
- Always take all readings with capped vials.
- Bubbles on the inside walls of the vial can lead to incorrect measurements. To prevent this, cap the vial and remove the bubbles by swirling the vial before performing the test.
- Always add the reagent to the sample straight from the foil. The reagent should never touch fingers or hands.
- Major temperature differentials between the instrument and environment can lead to incorrect measurements - i.e. due to the formation of condensate in the area of the lens or on the vial. Specified tolerances at T = 20 °C.
- For the best results, use a pipette to measure and add samples to vials or beakers.

## AC2002 Alkalinity-M (Alkalinity to pH 4.3) Tablet Test

### Acid/Indicator Method

5 – 200 mg/l CaCO<sub>3</sub>

1. Load and run the AC2002 method.
2. Fill a clean AQUAfast 24mm round vial, Cat. No. AC2V24, with 10 ml of sample. Close the vial tightly with the cap. Wipe the exterior of the vial.
3. Place the vial into the holder in the sample chamber and close the chamber door.
4. Tap the **Blank** function key to measure the blank.
5. Open the sample chamber door and remove the vial from the holder.
6. Add one Alka-M Tablet straight from the foil into the vial. Crush the tablet with a clean stir rod.
7. Close the vial tightly with the cap and swirl or invert several times until the tablet is dissolved. Wipe the exterior of the vial.
8. Place the vial into the holder in the sample chamber and close the chamber door.
9. Tap the **Sample** function key to display the result in mg/l total alkalinity.

### Notes:

- The terms total alkalinity, alkalinity-m, m-value and alkalinity to pH 4.3 are identical.
- For accurate results, exactly 10 ml of water sample must be taken for the test.

## AC3002P Alkalinity-P (Alkalinity to pH 8.2) Tablet Test

### Acid/Indicator Method

5 – 300 mg/l CaCO<sub>3</sub>

1. Load and run the AC3002P method.
2. Fill a clean AQUAfast 24mm round vial, Cat. No. AC2V24, with 10 ml of sample. Close the vial tightly with the cap. Wipe the exterior of the vial.
3. Place the vial into the holder in the sample chamber and close the chamber door.
4. Tap the **Blank** function key to measure the blank.
5. Open the sample chamber door and remove the vial from the holder.
6. Add one Alka-P Tablet straight from the foil into the vial. Crush the tablet with a clean stir rod.
7. Close the vial tightly with the cap and swirl or invert several times until the tablet is dissolved. Wipe the exterior of the vial.
8. Place the vial into the holder in the sample chamber and close the chamber door.
9. Tap the **Sample** function key to display the result in mg/l total alkalinity.

### Notes

- The terms alkalinity-p, p-value and alkalinity to pH 8.2 are identical.
- For accurate test results, exactly 10 ml of water sample must be taken for the test.
- This method was developed from a volumetric procedure for the determination of alkalinity-p. Due to undefined conditions, the deviations from the standardized method may be greater.

## AC2027 Aluminum Tablet Test

### Eriochrome Cyanine R Method

0.01 – 0.3 mg/l Al

1. Load and run the AC2027 method.
2. Fill a clean AQUAfast 24mm round vial, Cat. No. AC2V24, with 10 ml of sample. Close the vial tightly with the cap. Wipe the exterior of the vial.
3. Place the vial into the holder in the sample chamber and close the chamber door.
4. Tap the **Blank** function key to measure the blank.
5. Open the sample chamber door and remove the vial from the holder.
6. Add one Aluminum No. 1 Tablet straight from the foil into the vial. Crush the tablet with a clean stir rod and mix well to dissolve the tablet completely.
7. Add one Aluminum No. 2 Tablet straight from the foil into the same vial. Crush the tablet with a clean stir rod and mix well to dissolve the tablet completely.
8. Close the vial tightly with the cap and swirl or invert several times to mix the contents. Wipe the exterior of the vial.
9. Wait for a reaction period of 5 minutes.
10. Place the vial into the holder in the sample chamber and close the chamber door.
11. Tap the **Sample** function key to display the result in mg/l aluminum.

#### Notes:

- Before use, clean the vials and the measuring beaker with hydrochloric acid (approximately 20%). Rinse them thoroughly with deionized water.
- To get accurate results the sample temperature must be between 20 °C and 25 °C.
- A low test result may be given in the presence of fluorides and polyphosphates. The effect of this is generally insignificant unless the water has fluoride added artificially.



## AC4P27 Aluminum Powder Pack & Liquid Test

### Eriochrome Cyanine R Method

0.01 – 0.25 mg/l Al

1. Load and run the AC4P27 method.
2. Use two clean AQUAfast 24mm round vials, Cat. No. AC2V24 and mark one as the blank.
3. Pour 20 ml of sample into a 100 ml beaker.
4. Add the contents of one Aluminum ECR F20 Powder Pack straight from the foil into the sample in the beaker. Dissolve the powder using a clean stirring rod.
5. Wait for a reaction period of 30 seconds.
6. Add the contents of one Hexamine F20 Powder Pack straight from the foil into the same sample in the beaker. Dissolve the powder using a clean stirring rod.
7. Add 1 drop of Aluminum ECR Masking Reagent into the vial marked as blank. Add 10 ml of the prepared sample to the same vial (this is the blank vial).
8. Add the remaining 10 ml of the prepared sample to the second vial (this is the sample vial).
9. Close the vials tightly with the caps and swirl or invert several times to mix the contents. Wipe the exteriors of the vials.
10. Wait for a reaction period of 5 minutes.
11. Place the blank vial into the holder in the sample chamber and close the chamber door.
12. Tap the **Blank** function key to measure the blank.
13. Open the sample chamber door. Remove the blank vial from the holder.
14. Place the sample vial into the holder in the sample chamber and close the chamber door.
15. Tap the **Sample** function key to display the result in mg/l aluminum.

#### Notes:

- Before use, clean the vials and the measuring beaker with hydrochloric acid (approximately 20%). Rinse them thoroughly with deionized water.
- To get accurate results the sample temperature must be between 20 °C and 25 °C.
- A low test result may be given in the presence of fluorides and polyphosphates. The effect of this is generally insignificant unless the water has fluoride added artificially.

## AC2012 Ammonia Tablet Test

### Indophenole Blue Method

0.02 – 1 mg/l N (Ammonia as Nitrogen)

1. Load and run the AC2012 method.
2. Fill a clean AQUAfast 24mm round vial, Cat. No. AC2V24, with 10 ml of sample. Close the vial tightly with the cap. Wipe the exterior of the vial.
3. Place the vial into the holder in the sample chamber and close the chamber door.
4. Tap the **Blank** function key to measure the blank.
5. Open the sample chamber door and remove the vial from the holder.
6. Add one Ammonia No. 1 Tablet straight from the foil into the vial. Crush the tablet with a clean stir rod.
7. Add one Ammonia No. 2 Tablet straight from the foil into the same sample in the vial. Crush the tablet with a clean stir rod.
8. Close the vial tightly with the cap and swirl or invert several times until the tablets are dissolved. Wipe the exterior of the vial.
9. Wait for a reaction period of 10 minutes.
10. Place the vial into the holder in the sample chamber and close the chamber door.
11. Tap the **Sample** function key to display the result in mg/l ammonia as N.

#### Notes:

- The tablets must be added in the correct sequence.
- The Ammonia No. 1 tablet will only dissolve completely after the Ammonia No. 2 tablet has been added.
- The temperature of the sample is important for full color development. At a temperature below 20 °C, the reaction period is 15 minutes.
- Conversion:  $\text{mg/l NH}_4 = \text{mg/l N} \times 1.29$   
 $\text{mg/l NH}_3 = \text{mg/l N} \times 1.22$

## AC4P12 Ammonia Powder Pack Test

### Salicylate Method

0.01 – 0.8 mg/l N (Ammonia as Nitrogen)

1. Load and run the AC4P12 method.
2. Use two clean AQUAfast 24mm round vials, Cat. No. AC2V24.
3. Pour 10 ml of deionized water into the first vial (this is the blank vial).
4. Pour 10 ml of sample into the second vial (this is the sample vial).
5. Add contents of one Ammonia Salicylate F10 Powder Pack straight from the foil into each vial. Close the vials tightly with the caps and swirl or invert several times to mix.
6. Wait for a reaction period of 3 minutes.
7. Add contents of one Ammonia Cyanurate F10 Powder Pack straight from the foil into each vial. Close the vials tightly with the caps and swirl or invert several times to mix. Wipe the exteriors of the vials.
8. Wait for a reaction period of 15 minutes.
9. Place the blank vial into the holder in the sample chamber and close the chamber door.
10. Tap the **Blank** function key to measure the blank.
11. Open the sample chamber door. Remove the blank vial from the holder.
12. Place the sample vial into the holder in the sample chamber and close the chamber door.
13. Tap the **Sample** function key to display the result in mg/l ammonia as N.

### Notes:

- Extremely basic or acidic water samples should be adjusted to pH 7 with a 0.5 mol/l (1 N) sulfuric acid solution or 1 mol/l (1 N) sodium hydroxide solution.

Interference	Interference Levels and Treatments
Calcium	Greater than 1000 mg/l CaCO <sub>3</sub>
Iron	Interferes at all levels. To correct, determine the concentration of iron in the sample by performing a total iron test. Add the same iron concentration to the deionized water (step 3). Iron will be blanked out successfully.
Magnesium	Greater than 6000 mg/l CaCO <sub>3</sub>
Nitrate	Greater than 100 mg/l NO <sub>3</sub> -N
Nitrite	Greater than 12 mg/l NO <sub>2</sub> -N
Phosphate	Greater than 100 mg/l PO <sub>4</sub> -P
Sulfate	Greater than 300 mg/l SO <sub>4</sub>
Sulfide	Intensifies the color
Glycine, Hydrazine, Color, Turbidity	Less common interferences such as hydrazine and glycine will cause intensified colors in the prepared sample. Turbidity and color will give erroneous high values. <b>Samples</b> with severe interferences require distillation.

## ACR012 Ammonia Low Range Reaction Tube Test

### Salicylate Method

0.02 – 2.5 mg/l N (Ammonia as Nitrogen)

1. Load and run the ACR012 method.
2. Open one 16 mm reaction vial and add 2 ml of deionized water (this is the blank vial).
3. Open a second 16 mm reaction vial and add 2 ml of sample (this is the sample vial).
4. Add the contents of one Ammonia Salicylate F5 Powder Pack straight from the foil into each vial.
5. Add contents of one Ammonia Cyanurate F5 Powder Pack straight from the foil into each vial.
6. Close the vials tightly with the caps and swirl or invert several times to mix the contents. Wipe the exteriors of the vials.
7. Wait for a reaction period of 20 minutes.
8. Place the blank vial into the holder in the sample chamber and close the chamber door.
9. Tap the **Blank** function key to measure the blank.
10. Open the sample chamber door. Remove the blank vial from the holder.
11. Place the sample vial into the holder in the sample chamber and close the chamber door.
12. Tap the **Sample** function key to display the result in mg/l ammonia as N.

### Notes:

- Strong alkaline or acidic water samples must be adjusted to approximately pH 7 before analysis (use 1 mol/l hydrochloric acid or 1 mol/l sodium hydroxide).
- If chlorine is known to be present, add one drop of 0.1 mol/l sodium thiosulfate for each 0.3 mg/l Cl<sub>2</sub> in a one liter water sample.
- Iron interferes with the test. The interferences can be eliminated as follows: Determine the amount of total iron present in the water sample. To produce the blank add an iron standard solution with the same iron concentration to the vial instead of deionized water.
- Conversion:  $\text{mg/l NH}_4 = \text{mg/l N} \times 1.29$   
 $\text{mg/l NH}_3 = \text{mg/l N} \times 1.22$

## ACR011 Ammonia High Range Reaction Tube Test

### Salicylate Method

1 – 50 mg/l N (Ammonia as Nitrogen)

1. Load and run the ACR011 method.
2. Open one 16 mm reaction vial and add 0.1 ml of deionized water (this is the blank vial).
3. Open a second 16 mm reaction vial and add 0.1 ml of sample (this is the sample vial).
4. Add the contents of one Ammonia Salicylate F5 Powder Pack straight from the foil into each vial.
5. Add the contents of one Ammonia Cyanurate F5 Powder Pack straight from the foil into each vial.
6. Close the vials tightly with the caps and swirl or invert several times to mix the contents. Wipe the exteriors of the vials.
7. Wait for a reaction period of 20 minutes.
8. Place the blank vial into the holder in the sample chamber and close the chamber door.
9. Tap the **Blank** function key to measure the blank.
10. Open the sample chamber door. Remove the blank vial from the holder.
11. Place the sample vial into the holder in the sample chamber and close the chamber door.
12. Tap the **Sample** function key to display the result in mg/l ammonia as N.

### Notes:

- Strong alkaline or acidic water samples must be adjusted to approximately pH 7 before analysis (use 1 mol/l hydrochloric acid or 1 mol/l sodium hydroxide).
- If chlorine is known to be present, add one drop of 0.1 mol/l sodium thiosulfate for each 0.3 mg/l Cl<sub>2</sub> in a one liter water sample.
- Iron interferes with the test. The interferences can be eliminated as follows: Determine the amount of total iron present in the water sample. To produce the blank, add an iron standard solution with the same iron concentration to the vial instead of deionized water.
- Conversion:  $\text{mg/l NH}_4 = \text{mg/l N} \times 1.29$   
 $\text{mg/l NH}_3 = \text{mg/l N} \times 1.22$

## AC2035 Bromine Tablet Test

### DPD Method

0.05 – 13 mg/l Br<sub>2</sub>

1. Load and run the AC203524 method.
2. Fill a clean AQUAfast 24mm round vial, Cat. No. AC2V24, with 10 ml of sample. Close the vial tightly with the cap. Wipe the exterior of the vial.
3. Place the vial into the holder in the sample chamber and close the chamber door.
4. Tap the **Blank** function key to measure the blank.
5. Open the sample chamber door and remove the vial from the holder.
6. Empty the vial, leaving a few drops of sample remaining in the vial.
7. Add one DPD No. 1 Tablet straight from the foil into the vial. Crush the tablet with a clean stir rod.
8. Add sample to the 10 ml mark on the vial.
9. Close the vial tightly with the cap and swirl or invert several times until the tablet is dissolved. Wipe the exterior of the vial.
10. Place the vial into the holder in the sample chamber and close the chamber door.
11. Tap the **Sample** function key to display the result in mg/l bromine.

### Notes:

- Alternatively, the AC203510 method can be used with 10mm square vials and the AC203550 method can be used with 50mm rectangular vials. All blank and sample volumes must remain the same as those specified in these instructions, so samples may need to be prepared in separate containers and then transferred into the selected vial.
- Vial cleaning: As many household cleaners (i.e. dishwasher detergent) contain reducing substances, the subsequent determination of bromine may show lower results. To avoid any measurement errors, only use glassware free of chlorine demand.  
Preparation: Put all applicable glassware into sodium hypochlorite solution (0.1 g/l) for one hour and then rinse all glassware thoroughly with deionized water.
- Preparing the sample: When preparing the sample, the escape of bromine gases, i.e. by pipetting or shaking, must be avoided. The analysis must take place immediately after taking the sample.
- The DPD color development is carried out at a pH value of 6.2 to 6.5. The reagent tablet therefore contains a buffer for the pH adjustment. Strong alkaline or acidic water samples must be adjusted between pH 6 and pH 7 before the reagent is added (use 0.5 mol/l sulfuric acid or 1 mol/l sodium hydroxide).

- Exceeding the measuring range: Concentrations above 22 mg/l bromine can lead to results showing 0 mg/l. In this event, the water sample must be diluted with water free of bromine. 10 ml of the diluted sample should be mixed with the reagent and the measurement repeated.
- Oxidizing agents such as chlorine or ozone interfere as they react in the same way as bromine.

## AC2017 Chloride Tablet Test

### Silver Nitrate/Turbidity Method

0.5 – 25 mg/l Cl

1. Load and run the AC2017 method.
2. Fill a clean AQUAfast 24mm round vial, Cat. No. AC2V24, with 10 ml of sample. Close the vial tightly with the cap. Wipe the exterior of the vial.
3. Place the vial into the holder in the sample chamber and close the chamber door.
4. Tap the **Blank** function key to measure the blank.
5. Open the sample chamber door and remove the vial from the holder.
6. Add one Chloride T1 Tablet straight from the foil into the vial. Crush the tablet with a clean stir rod.
7. Add one Chloride T2 Tablet straight from the foil into the same vial. Crush the tablet with a clean stir rod.
8. Close the vial tightly with the cap and swirl gently until the tablet is dissolved. Wipe the exterior of the vial.
9. Wait for a reaction period of 2 minutes.
10. Place the vial into the holder in the sample chamber and close the chamber door.
11. Tap the **Sample** function key to display the result in mg/l chloride.

#### Notes:

- Ensure that all particles of the tablet are dissolved – chloride causes an extremely fine distributed turbidity with a milky appearance. Heavy shaking leads to bigger sized particles that can cause false readings.
- High concentrations of electrolytes and organic compounds have different effects on the precipitation reaction.
- Ions that also form deposits with silver nitrate in acidic media, such as bromides, iodides and thiocyanates, interfere with the analysis.
- Highly alkaline water should, if necessary, be neutralized using nitric acid before analysis.



## AC2070 Chlorine (Free & Total) Tablet Test

### DPD Method

0.01 – 6 mg/l Cl<sub>2</sub>

1. Load and run the AC207024 method.
2. Fill a clean AQUAfast 24mm round vial, Cat. No. AC2V24, with 10 ml of sample. Close the vial tightly with the cap. Wipe the exterior of the vial.
3. Place the vial into the holder in the sample chamber and close the chamber door.
4. Tap the **Blank** function key to measure the blank.
5. Open the sample chamber door and remove the vial from the holder.
6. Empty the vial, leaving a few drops of sample remaining in the vial.
7. Add one DPD No. 1 Tablet straight from the foil into the vial. Crush the tablet with a clean stir rod.
8. Add sample to the 10 ml mark on the vial.
9. Close the vial tightly with the cap and swirl or invert several times until the tablet is dissolved. Wipe the exterior of the vial.
10. Place the vial into the holder in the sample chamber and close the chamber door.
11. Tap the **Sample** function key to display the result in mg/l free chlorine.
12. Open the sample chamber door and remove the vial from the holder.
13. Add one DPD No. 3 Tablet straight from the foil into the vial. Crush the tablet with a clean stir rod.
14. Close the vial tightly with the cap and swirl or invert several times until the tablet is dissolved. Wipe the exterior of the vial.
15. Wait for a reaction period of 2 minutes.
16. Place the vial into the holder in the sample chamber and close the chamber door.
17. Tap the **Sample** function key to display the result in mg/l total chlorine.

### Notes:

- Alternatively, the AC207010 method can be used with 10mm square vials and the AC207050 method can be used with 50mm rectangular vials. All blank and sample volumes must remain the same as those specified in these instructions, so samples may need to be prepared in separate containers and then transferred into the selected vial.
- Vial cleaning: As many household cleaners (i.e. dishwasher detergent) contain reducing substances, the subsequent determination of chlorine may show lower results. To avoid any measurement errors, only use glassware free of chlorine demand.

Preparation: Put all applicable glassware into sodium hypochlorite solution (0.1 g/l) for one hour and then rinse all glassware thoroughly with deionized water.

- For individual testing of free and total chlorine, the use of different sets of glassware is recommended (EN ISO 7393-2, 5.3).
- Preparing the sample: When preparing the sample, the escape of chlorine gases, i.e. by pipetting or shaking, must be avoided. The analysis must take place immediately after taking the sample.
- The DPD color development is carried out at a pH value of 6.2 to 6.5. The reagents therefore contain a buffer for the pH adjustment. Strong alkaline or acidic water samples must be adjusted between pH 6 and pH 7 before the reagent is added (use 0.5 mol/l sulfuric acid or 1 mol/l sodium hydroxide).
- Exceeding the measuring range: Concentrations above 10 mg/l chlorine using tablets can lead to results showing 0 mg/l. In this event, the water sample must be diluted with water free of chlorine. 10 ml of the diluted sample should be mixed with the reagent and the measurement repeated.
- Turbidity can lead to errors. The use of the DPD No. 1 tablet in samples with high calcium ion contents and/or high conductivity can lead to turbidity of the sample and therefore incorrect measurements.
- Oxidizing agents such as bromine or ozone interfere as they react in the same way as chlorine.

## AC2071 Chlorine (Free) Tablet Test

### DPD Method

0.01 – 6 mg/l Cl<sub>2</sub>

1. Load and run the AC207124 method.
2. Fill a clean AQUAfast 24mm round vial, Cat. No. AC2V24, with 10 ml of sample. Close the vial tightly with the cap. Wipe the exterior of the vial.
3. Place the vial into the holder in the sample chamber and close the chamber door.
4. Tap the **Blank** function key to measure the blank.
5. Open the sample chamber door and remove the vial from the holder.
6. Empty the vial, leaving a few drops of sample remaining in the vial.
7. Add one DPD No. 1 Tablet straight from the foil into the vial. Crush the tablet with a clean stir rod.
8. Add sample to the 10 ml mark on the vial.
9. Close the vial tightly with the cap and swirl or invert several times until the tablet is dissolved. Wipe the exterior of the vial.
10. Place the vial into the holder in the sample chamber and close the chamber door.
11. Tap the **Sample** function key to display the result in mg/l free chlorine.

### Notes:

- Alternatively, the AC207110 method can be used with 10mm square vials and the AC207150 method can be used with 50mm rectangular vials. All blank and sample volumes must remain the same as those specified in these instructions, so samples may need to be prepared in separate containers and then transferred into the selected vial.
- Vial cleaning: As many household cleaners (i.e. dishwasher detergent) contain reducing substances, the subsequent determination of chlorine may show lower results. To avoid any measurement errors, only use glassware free of chlorine demand.  
Preparation: Put all applicable glassware into sodium hypochlorite solution (0.1 g/l) for one hour and then rinse all glassware thoroughly with deionized water.
- For individual testing of free and total chlorine, the use of different sets of glassware is recommended (EN ISO 7393-2, 5.3).
- Preparing the sample: When preparing the sample, the escape of chlorine gases, i.e. by pipetting or shaking, must be avoided. The analysis must take place immediately after taking the sample.
- The DPD color development is carried out at a pH value of 6.2 to 6.5. The reagents therefore contain a buffer for the pH adjustment. Strong alkaline or acidic water samples

must be adjusted between pH 6 and pH 7 before the reagent is added (use 0.5 mol/l sulfuric acid or 1 mol/l sodium hydroxide).

- Exceeding the measuring range: Concentrations above 10 mg/l chlorine using tablets can lead to results showing 0 mg/l. In this event, the water sample must be diluted with water free of chlorine. 10 ml of the diluted sample should be mixed with the reagent and the measurement repeated.
- Turbidity can lead to errors. The use of the DPD No. 1 tablet in samples with high calcium ion contents and/or high conductivity can lead to turbidity of the sample and therefore incorrect measurements.
- Oxidizing agents such as bromine or ozone interfere as they react in the same way as chlorine.

## AC2072 Chlorine (Total) Tablet Test

### DPD Method

0.01 – 6 mg/l Cl<sub>2</sub>

1. Load and run the AC207224 method.
2. Fill a clean AQUAfast 24mm round vial, Cat. No. AC2V24, with 10 ml of sample. Close the vial tightly with the cap. Wipe the exterior of the vial.
3. Place the vial into the holder in the sample chamber and close the chamber door.
4. Tap the **Blank** function key to measure the blank.
5. Open the sample chamber door and remove the vial from the holder.
6. Empty the vial, leaving a few drops of sample remaining in the vial.
7. Add one DPD No. 4 Tablet (or one DPD No. 1 Tablet and one DPD No. 3 Tablet) straight from the foil into the vial. Crush the tablet with a clean stir rod.
8. Add sample to the 10 ml mark on the vial.
9. Close the vial tightly with the cap and swirl or invert several times until the tablet is dissolved. Wipe the exterior of the vial.
10. Wait for a reaction period of 2 minutes.
11. Place the vial into the holder in the sample chamber and close the chamber door.
12. Tap the **Sample** function key to display the result in mg/l total chlorine.

### Notes:

- Alternatively, the AC207210 method can be used with 10mm square vials and the AC207250 method can be used with 50mm rectangular vials. All blank and sample volumes must remain the same as those specified in these instructions, so samples may need to be prepared in separate containers and then transferred into the selected vial.
- Vial cleaning: As many household cleaners (i.e. dishwasher detergent) contain reducing substances, the subsequent determination of chlorine may show lower results. To avoid any measurement errors, only use glassware free of chlorine demand.  
Preparation: Put all applicable glassware into sodium hypochlorite solution (0.1 g/l) for one hour and then rinse all glassware thoroughly with deionized water.
- For individual testing of free and total chlorine, the use of different sets of glassware is recommended (EN ISO 7393-2, 5.3).
- Preparing the sample: When preparing the sample, the escape of chlorine gases, i.e. by pipetting or shaking, must be avoided. The analysis must take place immediately after taking the sample.

- The DPD color development is carried out at a pH value of 6.2 to 6.5. The reagents therefore contain a buffer for the pH adjustment. Strong alkaline or acidic water samples must be adjusted between pH 6 and pH 7 before the reagent is added (use 0.5 mol/l sulfuric acid or 1 mol/l sodium hydroxide).
- Exceeding the measuring range: Concentrations above 10 mg/l chlorine using tablets can lead to results showing 0 mg/l. In this event, the water sample must be diluted with water free of chlorine. 10 ml of the diluted sample should be mixed with the reagent and the measurement repeated.
- Turbidity can lead to errors. The use of the DPD No. 1 tablet in samples with high calcium ion contents and/or high conductivity can lead to turbidity of the sample and therefore incorrect measurements.
- Oxidizing agents such as bromine or ozone interfere as they react in the same way as chlorine.

## AC4P71 Chlorine (Free) Powder Pack Test

### DPD Method

0.02 – 2 mg/l Cl<sub>2</sub>

1. Load and run the AC4P71 method.
2. Fill a clean AQUAfast 24mm round vial, Cat. No. AC2V24, with 10 ml of sample. Close the vial tightly with the cap. Wipe the exterior of the vial.
3. Place the vial into the holder in the sample chamber and close the chamber door.
4. Tap the **Blank** function key to measure the blank.
5. Open the sample chamber door and remove the vial from the holder.
6. Add the contents of one Chlorine Free-DPD / F10 Powder Pack straight from the foil into the vial.
7. Close the vial tightly with the cap and swirl or invert several times to mix the contents (approximately 20 seconds). Wipe the exterior of the vial.
8. Place the vial into the holder in the sample chamber and close the chamber door.
9. Tap the **Sample** function key to display the result in mg/l free chlorine.

### Notes:

- Vial cleaning: As many household cleaners (i.e. dishwasher detergent) contain reducing substances, the subsequent determination of chlorine may show lower results. To avoid any measurement errors, only use glassware free of chlorine demand.  
Preparation: Put all applicable glassware into sodium hypochlorite solution (0.1 g/l) for one hour and then rinse all glassware thoroughly with deionized water.
- For individual testing of free and total chlorine, the use of different sets of glassware is recommended (EN ISO 7393-2, 5.3).
- Preparing the sample: When preparing the sample, the escape of chlorine gases, i.e. by pipetting or shaking, must be avoided. The analysis must take place immediately after taking the sample.
- The DPD color development is carried out at a pH value of 6.2 to 6.5. The reagents therefore contain a buffer for the pH adjustment. Strong alkaline or acidic water samples must be adjusted between pH 6 and pH 7 before the reagent is added (use 0.5 mol/l sulfuric acid or 1 mol/l sodium hydroxide).
- Exceeding the measuring range: Concentrations above 2 mg/l chlorine using powder packs can lead to results showing 0 mg/l. In this event, the water sample must be diluted with water free of chlorine. 10 ml of the diluted sample should be mixed with the reagent and the measurement repeated.
- Oxidizing agents such as bromine or ozone interfere as they react in the same way as chlorine.

## AC4P72 Chlorine (Total) Powder Pack Test

### DPD Method

0.02 – 2 mg/l Cl<sub>2</sub>

1. Load and run the AC4P72 method.
2. Fill a clean AQUAfast 24mm round vial, Cat. No. AC2V24, with 10 ml of sample. Close the vial tightly with the cap. Wipe the exterior of the vial.
3. Place the vial into the holder in the sample chamber and close the chamber door.
4. Tap the **Blank** function key to measure the blank.
5. Open the sample chamber door and remove the vial from the holder.
6. Add the contents of one Chlorine Total-DPD / F10 Powder Pack straight from the foil into the vial.
7. Close the vial tightly with the cap and swirl or invert several times to mix the contents (approximately 20 seconds). Wipe the exterior of the vial.
8. Wait for a reaction period of 3 minutes.
9. Place the vial into the holder in the sample chamber and close the chamber door.
10. Tap the **Sample** function key to display the result in mg/l total chlorine.

### Notes:

- Vial cleaning: As many household cleaners (i.e. dishwasher detergent) contain reducing substances, the subsequent determination of chlorine may show lower results. To avoid any measurement errors, only use glassware free of chlorine demand.  
Preparation: Put all applicable glassware into sodium hypochlorite solution (0.1 g/l) for one hour and then rinse all glassware thoroughly with deionized water.
- For individual testing of free and total chlorine, the use of different sets of glassware is recommended (EN ISO 7393-2, 5.3).
- Preparing the sample: When preparing the sample, the escape of chlorine gases, i.e. by pipetting or shaking, must be avoided. The analysis must take place immediately after taking the sample.
- The DPD color development is carried out at a pH value of 6.2 to 6.5. The reagents therefore contain a buffer for the pH adjustment. Strong alkaline or acidic water samples must be adjusted between pH 6 and pH 7 before the reagent is added (use 0.5 mol/l sulfuric acid or 1 mol/l sodium hydroxide).
- Exceeding the measuring range: Concentrations above 2 mg/l chlorine using powder packs can lead to results showing 0 mg/l. In this event, the water sample must be diluted with water free of chlorine. 10 ml of the diluted sample should be mixed with the reagent and the measurement repeated.
- Oxidizing agents such as bromine or ozone interfere as they react in the same way as chlorine.



## AC3072 Chlorine (Total) High Range Tablet Test

### KI / Acid Method

5 – 200 mg/l Cl<sub>2</sub>

1. Load and run the AC3072 method.
2. Fill a clean AQUAfast 16 mm round vial, Cat. No. AC2V16, with 10 ml of sample. Close the vial tightly with the cap. Wipe the exterior of the vial.
3. Place the vial into the holder in the sample chamber and close the chamber door.
4. Tap the **Blank** function key to measure the blank.
5. Open the sample chamber door and remove the vial from the holder.
6. Add one Chlorine HR (KI) Tablet straight from the foil into the vial. Crush the tablet with a clean stir rod.
7. Add one Acidifying GP Tablet straight from the foil into the same vial. Crush the tablet with a clean stir rod.
8. Close the vial tightly with the cap and swirl or invert several times until the tablets are dissolved. Wipe the exterior of the vial.
9. Place the vial into the holder in the sample chamber and close the chamber door.
10. Tap the **Sample** function key to display the result in mg/l chlorine.

### Notes:

- Oxidizing agents interfere as they react in the same way as chlorine.

## AC2099 Chlorine Dioxide Tablet Test

### DPD Method

0.02 – 11 mg/l ClO<sub>2</sub>

#### Chlorine Dioxide Measurement in Absence of Chlorine

1. Load and run the AC209924 method.
2. Fill a clean AQUAfast 24mm round vial, Cat. No. AC2V24, with 10 ml of sample. Close the vial tightly with the cap. Wipe the exterior of the vial.
3. Place the vial into the holder in the sample chamber and close the chamber door.
4. Tap the **Blank** function key to measure the blank.
5. Open the sample chamber door and remove the vial from the holder.
6. Empty the vial, leaving a few drops of sample remaining in the vial.
7. Add one DPD No. 1 Tablet straight from the foil into the vial. Crush the tablet with a clean stir rod.
8. Add sample to the 10 ml mark on the vial.
9. Close the vial tightly with the cap and swirl or invert several times until the tablet is dissolved. Wipe the exterior of the vial.
10. Place the vial into the holder in the sample chamber and close the chamber door.
11. Tap the **Sample** function key to display the result in mg/l chlorine dioxide.

#### Chlorine Dioxide Measurement in Presence of Chlorine

1. Load and run the AC209924 method.
2. Fill a clean AQUAfast 24mm round vial, Cat. No. AC2V24, with 10 ml of sample. Close the vial tightly with the cap. Wipe the exterior of the vial.
3. Place the vial into the holder in the sample chamber and close the chamber door.
4. Tap the **Blank** function key to measure the blank.
5. Open the sample chamber door and remove the vial from the holder.
6. Empty the vial, leaving a few drops of sample remaining in the vial.
7. Add one DPD No. 1 Tablet straight from the foil into the vial. Crush the tablet with a clean stir rod.
8. Fill a second clean AQUAfast 24mm round vial with 10 ml of sample. Add one Glycine Tablet straight from the foil into the vial. Crush the tablet with a clean stir rod. Close the vial tightly with the cap and swirl or invert several times until the tablet is dissolved.
9. Transfer the contents of the second vial into the first vial.

10. Close the vial tightly with the cap and swirl or invert several times until the tablets are dissolved. Wipe the exterior of the vial.
11. Place the vial into the holder in the sample chamber and close the chamber door.
12. Tap the **Sample** function key to display the result in mg/l chlorine dioxide.

**Notes:**

- Alternatively, the AC209950 method can be used with 50mm rectangular vials. All blank and sample volumes must remain the same as those specified in these instructions, so samples may need to be prepared in separate containers and then transferred into the selected vial.
- Vial cleaning: As many household cleaners (i.e. dishwasher detergent) contain reducing substances, the subsequent determination of chlorine dioxide may show lower results. To avoid any measurement errors, only use glassware free of chlorine demand.  
Preparation: Put all applicable glassware into sodium hypochlorite solution (0.1 g/l) for one hour and then rinse all glassware thoroughly with deionized water.
- Preparing the sample: When preparing the sample, the escape of chlorine dioxide gases, i.e. by pipetting or shaking, must be avoided. The analysis must take place immediately after taking the sample.
- The DPD color development is carried out at a pH value of 6.2 to 6.5. The reagent tablet therefore contains a buffer for the pH adjustment. Strong alkaline or acidic water samples must be adjusted between pH 6 and pH 7 before the tablet is added (use 0.5 mol/l sulfuric acid or 1 mol/l sodium hydroxide).
- Exceeding the measuring range: Concentrations above 19 mg/l chlorine dioxide can lead to results showing 0 mg/l. In this event, the water sample must be diluted with water free of chlorine dioxide. 10 ml of the diluted sample should be mixed with the reagent and the measurement repeated.
- Oxidizing agents such as chlorine or ozone interfere as they react in the same way as chlorine dioxide.

## CODL00 COD Low Range Digestion Tube Test

### Dichromate Digestion Method

0 – 150 mg/l O<sub>2</sub>

1. Open one 16 mm COD reaction vial and add 2 ml of deionized water (this is the reagent blank vial).
2. Open a second 16 mm reaction vial and add 2 ml of sample (this is the sample vial).
3. Close the vials tightly with the caps and gently invert the vials several times to mix the contents. **CAUTION:** *The vials will become hot during mixing.*
4. Heat the vials for 120 minutes in the preheated reactor at a temperature of 150 °C.
5. **CAUTION:** *The vials will be hot.*  
Remove the vials from the reactor and allow them to cool to 60 °C or less. Gently invert the vials several times to mix the contents while still warm. Allow the vials to cool to room temperature before measuring. Wipe the exteriors of the vials.
6. Load and run the CODL00 method.
7. Fill a clean AQUAfast 16mm round vial, Cat. No. AC2V16, with deionized water (this is the blank vial). Close the vial tightly with the cap. Wipe the exterior of the vial.
8. Place the blank vial into the holder in the sample chamber and close the chamber door.
9. Tap the **Blank** function key to measure the blank.
10. Open the sample chamber door. Remove the blank vial from the holder.
11. Place the reagent blank vial into the holder in the sample chamber and close the chamber door.
12. Press the **Measure Rgnt Blank** function key to measure the reagent blank.
13. Open the sample chamber door. Remove the reagent blank vial from the holder.
14. Place the sample vial into the holder in the sample chamber and close the chamber door.
15. Tap the **Sample** function key to display the result in mg/l oxygen.

### Notes:

- Reverse color methods use a reagent that, when prepared with samples, decreases in color as the concentration of the species being measured in the samples increases. Reverse color methods require the use of both a blank and a reagent blank. The blank is a clear solution (deionized water) with zero absorbance. The reagent blank is a mixture of the reagent and deionized water and provides a zero concentration point with the darkest color (highest absorbance). The color of samples prepared with the reagent will decrease as the concentration increases for this method.

- Run samples and blanks with the same batch of vials. The blank is stable when stored in the dark and can be used for further measurements with vials of the same batch.
- Do not place the hot vials in the sample chamber. Cool the vials to room temperature for final measurements.
- Suspended solids in the vial lead to incorrect measurements. For this reason, it is important to place the vials carefully in the sample chamber. The precipitate at the bottom of the sample should be not suspended.
- Clean the outside of the vials with a towel. Fingerprints or other marks must be removed.
- **Samples** can be measured when the chloride content does not exceed 1000 mg/l.
- In exceptional cases, compounds contained in the water cannot be oxidized adequately, so results may be lower than reference methods.

## CODH00 COD Mid-Range Digestion Tube Test

### Dichromate Digestion Method

0 – 1500 mg/l O<sub>2</sub>

1. Open one 16 mm COD reaction vial and add 2 ml of deionized water (this is the blank vial).
2. Open a second 16 mm COD reaction vial and add 2 ml of sample (this is the sample vial).
3. Close the vials tightly with the caps and gently invert the vials several times to mix the contents. **CAUTION:** *The vials will become hot during mixing.*
4. Heat the vials for 120 minutes in the preheated reactor at a temperature of 150 °C.
5. **CAUTION:** *The vials will be hot.*  
Remove the vials from the reactor and allow them to cool to 60 °C or less. Gently invert the vials several times to mix the contents while still warm. Allow the vials to cool to room temperature before measuring. Wipe the exteriors of the vials.
6. Load and run the CODH00 method.
7. Place the blank vial into the holder in the sample chamber and close the chamber door.
8. Tap the **Blank** function key to measure the blank.
9. Open the sample chamber door. Remove the blank vial from the holder.
10. Place the sample vial into the holder in the sample chamber and close the chamber door.
11. Tap the **Sample** function key to display the result in mg/l oxygen.

### Notes:

- Run samples and blanks with the same batch of vials. The blank is stable when stored in the dark and can be used for further measurements with vials of the same batch.
- Do not place the hot vials in the sample chamber. Cool the vials to room temperature for final measurements.
- Suspended solids in the vial lead to incorrect measurements. For this reason, it is important to place the vials carefully in the sample chamber. The precipitate at the bottom of the sample should be not suspended.
- Clean the outside of the vials with a towel. Fingerprints or other marks must be removed.
- **Sample**s can be measured when the chloride content does not exceed 1000 mg/l.
- In exceptional cases, compounds contained in the water cannot be oxidized adequately, so results may be lower than reference methods.
- For samples under 100 mg/l it is recommended to repeat the test using the COD low range test (CODL00).

## CODHP0 COD High Range Digestion Tube Test

### Dichromate Digestion Method

0 – 15000 mg/l O<sub>2</sub> (High Range)

1. Open one 16 mm COD reaction vial and add 0.2 ml of deionized water (this is the blank vial).
2. Open a second 16 mm COD reaction vial and add 0.2 ml of sample (this is the sample vial).
3. Close the vials tightly with the caps and gently invert the vials several times to mix the contents. **CAUTION:** *The vials will become hot during mixing.*
4. Heat the vials for 120 minutes in the preheated reactor at a temperature of 150 °C.
5. **CAUTION:** *The vials will be hot.*  
Remove the vials from the reactor and allow them to cool to 60 °C or less. Gently invert the vials several times to mix the contents while still warm. Allow the vials to cool to room temperature before measuring. Wipe the exteriors of the vials.
6. Load and run the CODHP0 method.
7. Place the blank vial into the holder in the sample chamber and close the chamber door.
8. Tap the **Blank** function key to measure the blank.
9. Open the sample chamber door. Remove the blank vial from the holder.
10. Place the sample vial into the holder in the sample chamber and close the chamber door.
11. Tap the **Sample** function key to display the result in mg/l oxygen.

### Notes:

- Run samples and blanks with the same batch of vials. The blank is stable when stored in the dark and can be used for further measurements with vials of the same batch.
- Do not place the hot vials in the sample chamber. Cool the vials to room temperature for final measurements.
- Suspended solids in the vial lead to incorrect measurements. For this reason, it is important to place the vials carefully in the sample chamber. The precipitate at the bottom of the sample should be not suspended.
- Clean the outside of the vials with a towel. Finger prints or other marks must be removed.
- **Samples** can be measured when the chloride content does not exceed 1000 mg/l.
- In exceptional cases, compounds contained in the water cannot be oxidized adequately, so results may be lower than reference methods.
- For samples under 1000 mg/l it is recommended to repeat the test using the COD mid range test (CODH00) or for samples under 100 mg/l it is recommended to repeat the test using the COD low range test (CODL00).

## AC2029 Copper (Free & Total) Tablet Test

### Biquinoline Method

0.05 – 5 mg/l Cu

1. Load and run the AC202924 method.
2. Fill a clean AQUAfast 24mm round vial, Cat. No. AC2V24, with 10 ml of sample. Close the vial tightly with the cap. Wipe the exterior of the vial.
3. Place the vial into the holder in the sample chamber and close the chamber door.
4. Tap the **Blank** function key to measure the blank.
5. Open the sample chamber door and remove the vial from the holder.
6. Add one Copper No. 1 Tablet straight from the foil into the vial. Crush the tablet with a clean stir rod.
7. Close the vial tightly with the cap and swirl or invert several times until the tablet is dissolved. Wipe the exterior of the vial.
8. Place the vial into the holder in the sample chamber and close the chamber door.
9. Tap the **Sample** function key to display the result in mg/l free copper.
10. Open the sample chamber door and remove the vial from the holder.
11. Add one Copper No.2 Tablet straight from the foil into the same vial. Crush the tablet with a clean stir rod.
12. Close the vial tightly with the cap and swirl or invert several times until the tablet is dissolved. Wipe the exterior of the vial.
13. Place the vial into the holder in the sample chamber and close the chamber door.
14. Tap the **Sample** function key to display the result in mg/l total copper.

### Notes:

- Alternatively, the AC202950 method can be used with 50mm rectangular vials. All blank and sample volumes must remain the same as those specified in these instructions, so samples may need to be prepared in separate containers and then transferred into the selected vial.



## AC4P29 Copper (Free) Powder Pack Test

### Bicinchoninate Method

0.05 – 5 mg/l Cu

1. Load and run the AC4P29 method.
2. Fill a clean AQUAfast 24mm round vial, Cat. No. AC2V24, with 10 ml of sample. Close the vial tightly with the cap. Wipe the exterior of the vial.
3. Place the vial into the holder in the sample chamber and close the chamber door.
4. Tap the **Blank** function key to measure the blank.
5. Open the sample chamber door and remove the vial from the holder.
6. Add the contents of one Cu 1 F10 Powder Pack straight from the foil into the vial.
7. Close the vial tightly with the cap and swirl or invert several times to mix the contents. Wipe the exterior of the vial.
8. Wait for a reaction period of 2 minutes.
9. Place the vial into the holder in the sample chamber and close the chamber door.
10. Tap the **Sample** function key to display the result in mg/l free copper.

### Notes:

- For determination of total copper, a digestion is required.
- Extremely acid water samples (pH 2 or less) must be adjusted between pH 4 and pH 6 before the reagent is added (with 8 mol/l potassium hydroxide solution, KOH).
- Accuracy is not affected by undissolved powder.
- Interferences:

Cyanide (CN <sup>-</sup> )	Cyanide prevents full color development. Add 0.2 ml formaldehyde to 10 ml water sample and wait for a reaction time of 4 minutes (cyanide is masked). After this perform test as described. Multiply the result by 1.02 to correct the sample dilution by formaldehyde.
Silver (Ag <sup>+</sup> )	If turbidity remains and turns black, silver interference is likely. Add 10 drops of saturated potassium chloride solution to 75 ml of water sample. Filtrate through a fine filter. Use 10 ml of the filtered water sample to perform test.

## AC2098 Cyanuric Acid Tablet Test

### Melamine Method

0 – 160 mg/l CyA

1. Load and run the AC2098 method.
2. Fill a clean AQUAfast 24mm round vial, Cat. No. AC2V24, with 10 ml of sample. Close the vial tightly with the cap. Wipe the exterior of the vial.
3. Place the vial into the holder in the sample chamber and close the chamber door.
4. Tap the **Blank** function key to measure the blank.
5. Open the sample chamber door and remove the vial from the holder.
6. Add one Cyanuric Acid Tablet straight from the foil into the vial. Crush the tablet with a clean stir rod.
7. Close the vial tightly with the cap and swirl or invert several times until the tablet is dissolved (see notes below). Wipe the exterior of the vial.
8. Place the vial into the holder in the sample chamber and close the chamber door.
9. Tap the **Sample** function key to display the result in mg/l cyanuric acid.

### Notes:

- If cyanuric acid is present, a cloudy solution will occur. Small single particles are not necessarily caused by cyanuric acid.
- Dissolve the tablet completely (swirl the vial for approximately 1 minute). Undissolved particles of the tablet can cause results that are too high.
- Exceeding the measurement range: samples with concentration above 90 mg/l must be diluted with water free of cyanuric acid. 10 ml of the diluted sample should be tested as described above and the displayed results calculated using the dilution factor.

## AC2009 Fluoride SPADNS Liquid Test

### SPADNS Method

0.05 – 2 mg/l F

1. Load and run the AC2009 method.
2. Fill a clean AQUAfast 24mm round vial, Cat. No. AC2V24, with exactly 10 ml of deionized water. Close the vial tightly with the cap. Wipe the exterior of the vial.
3. Place the vial into the holder in the sample chamber and close the chamber door.
4. Tap the **Blank** function key to measure the blank.
5. Open the sample chamber door and remove the vial from the holder.
6. Add exactly 2 ml SPADNS Solution to the vial. **CAUTION:** *The vial will be filled to the top.*
7. Close the vial tightly with the cap and swirl or invert several times to mix the contents. Wipe the exterior of the vial.
8. Place the vial into the holder in the sample chamber and close the chamber door.
9. Press the **Measure Rgnt Blank** function key to measure the reagent blank.
10. Open the sample chamber door and remove the vial from the holder.
11. Empty the vial, thoroughly rinse the vial and cap several times and then fill the vial with exactly 10 ml of sample.
12. Add exactly 2 ml SPADNS Solution to the vial. **CAUTION:** *The vial will be filled to the top.*
13. Close the vial tightly with the cap and swirl or invert several times to mix the contents. Wipe the exterior of the vial.
14. Place the vial into the holder in the sample chamber and close the chamber door.
15. Tap the **Sample** function key to display the result in mg/l fluoride.

### Notes:

- Reverse color methods use a reagent that, when prepared with samples, decreases in color as the concentration of the species being measured in the samples increases. Reverse color methods require the use of both a blank and a reagent blank. The blank is a clear solution (deionized water) with zero absorbance. The reagent blank is a mixture of the reagent and deionized water and provides a zero concentration point with the darkest color (highest absorbance). The color of samples prepared with the reagent will decrease as the concentration increases for this method.
- The same batch of SPADNS reagent solution must be used for testing (reagent blank and sample measurement) and one point calibration procedures. The one point calibration process needs to be performed for each new batch of SPADNS reagent solution (see Standard Methods 20<sup>th</sup> ed., 1998, APHA, AWWA, WEF 4500 F- D, 4.a).

- During testing (blank, reagent blank and sample measurement) and one point calibration procedures the same vial should be used, as different vials may exhibit minor tolerances.
- The calibration solution and water samples should have the same temperature ( $\pm 1$  °C).
- As the test result is highly dependent on exact sample and reagent volumes, the sample and reagent volumes should always be measured using a 10 ml or 2 ml volumetric pipette (class A).
- The accuracy of the test methods decreases above a level of 1.2 mg/l fluoride. Although the results are sufficiently accurate for most applications, more exact results can be achieved using a 1:1 dilution of the sample prior to use and subsequent multiplication of the result by 2.
- SPADNS reagent solution contains arsenite. Chlorine concentrations up to 5 mg/l do not interfere.
- Seawater and wastewater samples must be distilled.

## AC3032T Hardness (Total) Tablet Test

### Metallphthalein Method

2 – 50 mg/l CaCO<sub>3</sub> (Low Range) or 20 – 500 mg/l CaCO<sub>3</sub> (High Range)

#### For Low Range Total Hardness Measurements:

1. Load and run the AC3032TL method.
2. Fill a clean AQUAfast 24mm round vial, Cat. No. AC2V24, with 10 ml of sample. Close the vial tightly with the cap. Wipe the exterior of the vial.
3. Place the vial into the holder in the sample chamber and close the chamber door.
4. Tap the **Blank** function key to measure the blank.
5. Open the sample chamber door and remove the vial from the holder.
6. Add one Hardcheck P Tablet straight from the foil into the vial. Crush the tablet with a clean stir rod.
7. Close the vial tightly with the cap and swirl or invert several times until the tablet is dissolved. Wipe the exterior of the vial.
8. Wait for a reaction period of 5 minutes.
9. Place the vial into the holder in the sample chamber and close the chamber door.
10. Tap the **Sample** function key to display the result in mg/l total hardness.

#### For High Range Total Hardness Measurements:

1. Load and run the AC3032TH method.
2. Fill a clean AQUAfast 24mm round vial, Cat. No. AC2V24, with 1 ml of sample and 9 ml of deionized water. Close the vial tightly with the cap. Wipe the exterior of the vial.
3. Place the vial into the holder in the sample chamber and close the chamber door.
4. Tap the **Blank** function key to measure the blank.
5. Open the sample chamber door and remove the vial from the holder.
6. Add one Hardcheck P Tablet straight from the foil into the vial. Crush the tablet with a clean stir rod.
7. Close the vial tightly with the cap and swirl or invert several times until the tablet is dissolved. Wipe the exterior of the vial.
8. Wait for a reaction period of 5 minutes.
9. Place the vial into the holder in the sample chamber and close the chamber door.
10. Tap the **Sample** function key to display the result in mg/l total hardness.

#### Notes:

- Strong alkaline or acidic water samples must be adjusted between pH 4 and pH 10 before the tablet is added (use 1 mol/l hydrochloric acid or 1 mol/l sodium hydroxide).

## AC2030 Hydrazine Powder Test

### Dimethylamino-benzaldehyde Method

0.05 – 0.5 mg/l N<sub>2</sub>H<sub>4</sub>

1. Load and run the AC2030 method.
2. Fill a clean AQUAfast 24mm round vial, Cat. No. AC2V24, with 10 ml of sample. Close the vial tightly with the cap. Wipe the exterior of the vial.
3. Place the vial into the holder in the sample chamber and close the chamber door.
4. Tap the **Blank** function key to measure the blank.
5. Open the sample chamber door and remove the vial from the holder.
6. Add one gram (1 g) Hydrazine Powder to the vial.
7. Close the vial tightly with the cap and swirl or invert several times to mix the contents. Wipe the exterior of the vial.
8. Wait for a reaction period of 10 minutes.
9. The slight turbidity that occurs when the reagent is added must be removed by filtration
10. Place the vial into the holder in the sample chamber and close the chamber door.
11. Tap the **Sample** function key to display the result in mg/l hydrazine.

#### Notes:

- If the water sample is cloudy, you must filter it before performing the blank measurement
- The temperature of the water sample should not exceed 21 °C.
- Using the hydrazine spoon: 1 g is equivalent to one level spoon.
- Qualitative folded filter papers for medium precipitates are recommended.
- To check whether the reagent has aged (if it has been stored for a lengthy period), perform the test as described above using tap water. If the result is above the detection limit of 0.05 mg/l, you should only use the reagent with reservations, as there may be a major deviation in results.

## AC2078 Iron (II & III) Tablet Test

### PPST Method

0.02 – 1 mg/l Fe

1. Load and run the AC207824 method.
2. Fill a clean AQUAfast 24mm round vial, Cat. No. AC2V24, with 10 ml of sample. Close the vial tightly with the cap. Wipe the exterior of the vial.
3. Place the vial into the holder in the sample chamber and close the chamber door.
4. Tap the **Blank** function key to measure the blank.
5. Open the sample chamber door and remove the vial from the holder.
6. Add one Iron LR Tablet straight from the foil into the vial. Crush the tablet with a clean stir rod.
7. Close the vial tightly with the cap and swirl or invert several times until the tablet is dissolved. Wipe the exterior of the vial.
8. Wait for a reaction period of 5 minutes.
9. Place the vial into the holder in the sample chamber and close the chamber door.
10. Tap the **Sample** function key to display the result in mg/l iron.

### Notes:

- Alternatively, the AC207850 method can be used with 50mm rectangular vials. All blank and sample volumes must remain the same as those specified in these instructions, so samples may need to be prepared in separate containers and then transferred into the selected vial.
- This method determines the total dissolved iron as Fe<sup>2+</sup> and Fe<sup>3+</sup>.
- For the determination of total dissolved and undissolved iron (soluble and insoluble iron), digestion is required. An example is described here:
  - i. Add 1 ml of concentrated sulfuric acid to 100 ml water sample. Heat and boil for 10 minutes or until all particles are dissolved. After cooling down, the sample is set to a pH value of 3 to 6 by using ammonia solution. Refill with deionized water to the previous volume of 100 ml and mix well. 10 ml of this pre-treated solution is used for analysis (perform as described by the selected test method).
  - ii. Water that has been treated with organic compounds like corrosion inhibitors must be oxidized as necessary to break down the iron. Therefore add 1 ml concentrated sulfuric acid and 1 ml concentrated nitric acid to 100 ml water sample and boil to approximately half volume. After cooling down, proceed as described above.

## AC4P78 Iron (Ferro) Powder Pack Test

### 1,10-Phenanthroline Method

0.02 – 3 mg/l Fe

1. Load and run the AC4P78 method.
2. Fill a clean AQUAfast 24mm round vial, Cat. No. AC2V24, with 10 ml of sample. Close the vial tightly with the cap. Wipe the exterior of the vial.
3. Place the vial into the holder in the sample chamber and close the chamber door.
4. Tap the **Blank** function key to measure the blank.
5. Open the sample chamber door and remove the vial from the holder.
6. Add the contents of one Ferro F10 Powder Pack straight from the foil into the vial.
7. Close the vial tightly with the cap and swirl or invert several times to mix the contents. Wipe the exterior of the vial.
8. Wait for a reaction period of 3 minutes.
9. Place the vial into the holder in the sample chamber and close the chamber door.
10. Tap the **Sample** function key to display the result in mg/l iron.

### Notes:

- The reagent reacts with all soluble iron and most insoluble forms of iron in the water sample.
- Iron oxide requires prior digestion: use mild, vigorous or Digesdahl digestion. An example of digestion with acid is described here:
  - i. Add 1 ml of concentrated sulfuric acid to 100 ml water sample. Heat and boil for 10 minutes or until all particles are dissolved. After cooling down, the sample is set to a pH value of 3 to 6 by using ammonia solution. Refill with deionized water to the previous volume of 100 ml and mix well. 10 ml of this pre-treated solution is used for analysis (perform as described by the selected test method).
  - ii. Water that has been treated with organic compounds like corrosion inhibitors must be oxidized as necessary to break down the iron. Therefore add 1 ml concentrated sulfuric acid and 1 ml concentrated nitric acid to 100 ml water sample and boil to approximately half volume. After cooling down, proceed as described above.
- Very strong alkaline or acidic samples must be adjusted to a pH value between 3 and 5 before analysis.
- Accuracy is not affected by undissolved powder.
- Water samples containing visible rust should be allowed to react for at least 5 minutes.



## AC4P79 Iron (Total) Powder Pack Test

### TPTZ Method

0.02 – 1.8 mg/l Fe

1. Load and run the AC4P79 method.
2. Use two clean AQUAfast 24mm round vials, Cat. No. AC2V24.
3. Pour 10 ml of deionized water into the first vial (this is the blank vial).
4. Pour 10 ml of sample into the second vial (this is the sample vial).
5. Add the contents of one Iron TPTZF10 Powder Pack straight from the foil into each vial. Close the vials tightly with the caps and swirl or invert several times to mix the contents. Wipe the exteriors of the vials.
6. Wait for a reaction period of 3 minutes.
7. Place the blank vial into the holder in the sample chamber and close the chamber door.
8. Tap the **Blank** function key to measure the blank.
9. Open the sample chamber door. Remove the blank vial from the holder.
10. Place the sample vial into the holder in the sample chamber and close the chamber door.
11. Tap the **Sample** function key to display the result in mg/l iron.

### Notes:

- For determination of total iron, digestion is required. TPTZ reagent recovers most insoluble iron oxides without digestion.
- Rinse all glassware with 1:1 hydrochloric acid solution first and then rinse with deionized water to remove iron deposits that can cause slightly high results.
- Strong alkaline or acidic water samples must be adjusted between pH 3 and pH 8 before the reagent is added (use 0.5 mol/l sulfuric acid or 1 mol/l sodium hydroxide).
- Interferences: When interferences occur, color development is inhibited or a precipitate is formed. The values below refer to a standard with an iron concentration of 0.5 mg/l. The following substances do not interfere when present up to the levels given:

Substance	No Interference To
Cadmium	4.0 mg/l
Chromium <sup>(3+)</sup>	0.25 mg/l
Chromium <sup>(6+)</sup>	1.2 mg/l
Cobalt	0.05 mg/l
Copper	0.6 mg/l
Cyanide	2.8 mg/l

Substance	No Interference To
Manganese	50 mg/l
Mercury	0.4 mg/l
Molybdenum	4.0 mg/l
Nickel	1.0 mg/l
Nitrite Ion	0.8 mg/l

## AC2055 Manganese Tablet Test

### Formaldehyde Method

0.2 – 4 mg/l Mn

1. Load and run the AC2055 method.
2. Fill a clean AQUAfast 24mm round vial, Cat. No. AC2V24, with 10 ml of sample. Close the vial tightly with the cap. Wipe the exterior of the vial.
3. Place the vial into the holder in the sample chamber and close the chamber door.
4. Tap the **Blank** function key to measure the blank.
5. Open the sample chamber door and remove the vial from the holder.
6. Add one Manganese LR 1 Tablet straight from the foil into the vial. Crush the tablet with a clean stir rod.
7. Add one Manganese LR 2 Tablet straight from the foil into the vial. Crush the tablet with a clean stir rod.
8. Close the vial tightly with the cap and swirl or invert several times until the tablets are dissolved. Wipe the exterior of the vial.
9. Wait for a reaction period of 5 minutes.
10. Place the vial into the holder in the sample chamber and close the chamber door.
11. Tap the **Sample** function key to display the result in mg/l manganese.

## AC4P54 Manganese Low Range Powder Pack & Liquid Test

### PAN Method

0.01 – 0.7 mg/l Mn

1. Load and run the AC4P54 method.
2. Use two clean AQUAfast 24mm round vials, Cat. No. AC2V24.
3. Pour 10 ml of deionized water into the first vial (this is the blank vial).
4. Pour 10 ml of sample into the second vial (this is the sample vial).
5. Add the contents of one Ascorbic Acid Powder Pack straight from the foil into each vial. Close the vials tightly with the caps and swirl or invert several times to mix the contents.
6. Add 15 drops of Alkaline Cyanide Reagent Solution to each vial. Add drops of the same size by holding the bottle vertically and squeezing slowly. Close the vials tightly with the caps and swirl or invert several times to mix the contents.
7. Add 21 drops of PAN Indicator Solution to each vial. Add drops of the same size by holding the bottle vertically and squeezing slowly. Close the vials tightly with the caps and swirl or invert several times to mix the contents. Wipe the exteriors of the vials.
8. Wait for a reaction period of 2 minutes.
9. Place the blank vial into the holder in the sample chamber and close the chamber door.
10. Tap the **Blank** function key to measure the blank.
11. Open the sample chamber door. Remove the blank vial from the holder.
12. Place the sample vial into the holder in the sample chamber and close the chamber door.
13. Tap the **Sample** function key to display the result in mg/l manganese.

### Notes:

- Rinse all glassware with 1:1 nitric acid solution first and then rinse with deionized water.
- Water samples that contain more than 300 mg/l CaCO<sub>3</sub> hardness: after adding the ascorbic acid powder pack, add 10 drops of Rochelle salt solution.
- After addition of the alkaline cyanide reagent solution, a cloudy or turbid solution may form in some water samples. The turbidity should disappear after the PAN indicator solution is added.
- Water samples containing more than 5 mg/l iron should be allowed to react for at least 10 minutes.

## AC4P55 Manganese High Range Powder Pack Test

### Periodate Oxidation Method

0.1 – 18 mg/l Mn (High Range)

1. Load and run the AC4P55 method.
2. Fill a clean AQUAfast 24mm round vial, Cat. No. AC2V24, with 10 ml of sample. Close the vial tightly with the cap. Wipe the exterior of the vial.
3. Place the vial into the holder in the sample chamber and close the chamber door.
4. Tap the **Blank** function key to measure the blank.
5. Open the sample chamber door and remove the vial from the holder.
6. Add the contents of one Manganese Citrate Buffer Powder Pack straight from the foil into the vial.
7. Close the vial tightly with the cap and swirl or invert several times to mix the contents.
8. Add the contents of one Sodium Periodate Powder Pack straight from the foil into the vial.
9. Close the vial tightly with the cap and swirl or invert several times to mix the contents. Wipe the exterior of the vial.
10. Wait for a reaction period of 2 minutes.
11. Place the vial into the holder in the sample chamber and close the chamber door.
12. Tap the **Sample** function key to display the result in mg/l manganese.

### Notes:

- This test is applicable for the determination of soluble manganese in water and wastewater.
- Highly buffered water samples or extreme pH values may exceed the buffering capacity of the reagents and requires sample pre-treatment. If samples were acidified for storing, adjust the pH between 4 and 5 with 5 mol/l (5 N) sodium hydroxide before test. Do not exceed pH 5, as manganese may precipitate.
- Interferences:

Interfering Substance	Interference Level
Calcium	Greater than 700 mg/l
Chloride	Greater than 70,000 mg/l
Iron	Greater than 5 mg/l
Magnesium	Greater than 100,000 mg/l

## AC4P42 Molybdate Powder Pack Test

### Mercaptoacetic Acid Method

0.5 – 66 mg/l MoO<sub>4</sub> (Equivalent to 0.3 – 40 mg/l Mo)

1. Load and run the AC4P42 method.
2. Fill a clean AQUAfast 24mm round vial, Cat. No. AC2V24, with 10 ml of sample. Close the vial tightly with the cap. Wipe the exterior of the vial.
3. Place the vial into the holder in the sample chamber and close the chamber door.
4. Tap the **Blank** function key to measure the blank.
5. Open the sample chamber door and remove the vial from the holder.
6. Add the contents of one Molybdenum HR 1 F10 Powder Pack straight from the foil into the vial. Close the vial tightly with the cap and swirl or invert several times to mix the contents.
7. Add the contents of one Molybdenum HR 2 F10 Powder Pack straight from the foil into the same vial. Close the vial tightly with the cap and swirl or invert several times to mix the contents.
8. Add the contents of one Molybdenum HR 3 F10 Powder Pack straight from the foil into the same vial. Close the vial tightly with the cap and swirl or invert several times to mix the contents. Wipe the exterior of the vial.
9. Wait for a reaction period of 5 minutes.
10. Place the vial into the holder in the sample chamber and close the chamber door.
11. Tap the **Sample** function key to display the result in mg/l molybdate.

### Notes:

- Filter turbid water samples using filter paper and funnel before analysis.
- Highly buffered water samples or extreme pH values should be adjusted to a pH of nearly 7 with 1 mol/l nitric acid or 1 mol/l sodium hydroxide.
- Concentrations above 10 mg/l Cu causes too high test values if the reaction time of 5 minutes is increased – so it is very important to perform the test procedure as described.
- Substances which may interfere when present in concentrations at

Aluminum	50 mg/l
Chromium	1000 mg/l
Iron	50 mg/l
Nickel	50 mg/l
Nitrite	All Levels

## ACR007 Nitrate Reaction Tube Test

### Chromotropic Acid Method

1 – 30 mg/l N (Nitrate as Nitrogen)

1. Load and run the ACR007 method.
2. Open one 16 mm reaction vial (Reagent A) and add 1 ml of deionized water (this is the blank vial).
3. Open a second 16 mm reaction vial (Reagent A) and add 1 ml of sample (this is the sample vial).
4. Add the contents of one Nitrate Chromotropic Powder Pack straight from the foil into each vial.
5. Close the vials tightly with the caps and invert gently about 10 times to mix contents. Some solids may not dissolve. Wipe the exteriors of the vials.
6. Wait for a reaction period of 5 minutes.
7. Place the blank vial into the holder in the sample chamber and close the chamber door.
8. Tap the **Blank** function key to measure the blank.
9. Open the sample chamber door. Remove the blank vial from the holder.
10. Place the sample vial into the holder in the sample chamber and close the chamber door.
11. Tap the **Sample** function key to display the result in mg/l nitrate as N.

### Notes:

- Some solids may not dissolve.
- Conversion:  $\text{mg/l NO}_3 = \text{mg/l N} \times 4.43$

## AC2046 Nitrite Tablet Test

### N-(1-Naphthyl)-ethylenediamine Method

0.01 – 0.5 mg/l N (Nitrite as Nitrogen)

1. Load and run the AC2046 method.
2. Fill a clean AQUAfast 24mm round vial, Cat. No. AC2V24, with 10 ml of sample. Close the vial tightly with the cap. Wipe the exterior of the vial.
3. Place the vial into the holder in the sample chamber and close the chamber door.
4. Tap the **Blank** function key to measure the blank.
5. Open the sample chamber door and remove the vial from the holder.
6. Add one Nitrite LR Tablet straight from the foil into the vial. Crush the tablet with a clean stir rod.
7. Close the vial tightly with the cap and swirl or invert several times until the tablet is dissolved. Wipe the exterior of the vial.
8. Wait for a reaction period of 10 minutes.
9. Place the vial into the holder in the sample chamber and close the chamber door.
10. Tap the **Sample** function key to display the result in mg/l nitrite as N.

#### Notes:

- The following ions can produce interferences since under the reaction conditions they cause precipitation: antimony (III), iron (III), lead, mercury (I), silver, chloroplatinate, metavanadate and bismuth. Copper (II) ions may cause lower test results as they accelerate the decomposition of the diazonium salt. It is unlikely in practice that these interfering ions will occur in such high concentrations that they cause significant reading errors.
- Conversion:  $\text{mg/l NO}_2 = \text{mg/l N} \times 3.29$

## AC4P46 Nitrite Powder Pack Test

### Diazotization (Azo) Method

0.01 – 0.3 mg/l N (Nitrite as Nitrogen)

1. Load and run the AC4P46 method.
2. Fill a clean AQUAfast 24mm round vial, Cat. No. AC2V24, with 10 ml of sample. Close the vial tightly with the cap. Wipe the exterior of the vial.
3. Place the vial into the holder in the sample chamber and close the chamber door.
4. Tap the **Blank** function key to measure the blank.
5. Open the sample chamber door and remove the vial from the holder.
6. Add the contents of one Nitri 3 Powder Pack straight from the foil into the vial.
7. Close the vial tightly with the cap and swirl or invert several times to mix the contents. Wipe the exterior of the vial.
8. Wait for a reaction period of 20 minutes.
9. Place the vial into the holder in the sample chamber and close the chamber door.
10. Tap the **Sample** function key to display the result in mg/l nitrite as N.

### Notes:

- Interferences:
  - Strong oxidizing and reducing substances interfere.
  - Cupric and ferrous ions cause low results.
  - Antimonous, auric, bismuth, chloroplatinate, ferric, lead, mercurous, metavanadate and silver ions interfere by causing precipitation.
  - In samples with very high concentrations of nitrate (> 100 mg/l N) a small amount of nitrite will be found. Such high levels of nitrate appear to undergo a slight amount of reduction to nitrite, either spontaneously or during the reaction time of the test.



## ACD004 Nitrogen (Total) Low Range Digestion Tube Test

### Persulfate Digestion Method

0.5 – 25 mg/l N (Nitrite as Nitrogen)

1. Open two TN Hydroxide LR Digestion Vials and add the contents of one TN Persulfate Reagent Power Pack straight from the foil into each vial. Use a funnel to add the reagent. Wipe off any persulfate reagent that may get on the lid or tube threads.
2. Add 2 ml of deionized water to the first digestion vial (this is the blank vial).
3. Add 2 ml of sample to the second digestion vial (this is the sample vial).
4. Close the vials tightly with the caps and shake the vials for at least 30 seconds to mix the contents. The reagent may not dissolve completely.
5. Heat the digestion vials for 30 minutes in the preheated reactor at a temperature of 100 °C.
6. **CAUTION:** *The vials will be hot.* Remove the digestion vials from the reactor and allow them to cool to room temperature.
7. Open the cooled digestion vials and add the contents of one TN Reagent A Power Pack straight from the foil into each vial. Use a funnel to add the reagent.
8. Close the vials tightly with the caps and shake the vials for at least 15 seconds to mix contents.
9. Wait for a reaction period of 3 minutes.
10. Open the digestion vials and add the contents of one TN Reagent B Power Pack straight from the foil into each vial. Use a funnel to add the reagent.
11. Close the vials tightly with the caps and shake the vials for at least 15 seconds to mix contents. The reagent will not completely dissolve.
12. Wait for a reaction period of 2 minutes.
13. Open two TN Acid LR/HR (Reagent C) Vials and add 2 ml of the digested, treated blank to the first vial (this is the blank vial).
14. Add 2 ml of the digested, treated sample to the second vial (this is the sample vial).
15. Close the vials tightly with the caps and gently invert the vials at least 10 times to mix contents. Hold the vial in a vertical position with the cap pointing up. Turn the vial upside-down. Wait for all of the solution to flow down to the cap. Return the vial to the upright position. Wait for all the solution to flow to the bottom of the vial. This process is one inversion; 10 inversions equal about 30 seconds. Wipe the exteriors of the vials.  
**CAUTION:** *The vials will become warm during mixing.*
16. Wait for a reaction period of 5 minutes.
17. Load and run the ACD004 method.
18. Place the blank vial into the holder in the sample chamber and close the chamber door.

19. Tap the **Blank** function key to measure the blank.
20. Open the sample chamber door. Remove the blank vial from the holder.
21. Place the sample vial into the holder in the sample chamber and close the chamber door.
22. Tap the **Sample** function key to display the result in mg/l nitrogen.

**Notes:**

- Appropriate safety precautions and a good lab technique should be used during the whole procedure.
- Volumes for samples and blank should always be measured using 2 ml volumetric pipettes (class A).
- One blank is sufficient for each set of samples. After taking the blank measurement, it is possible to measure several samples.
- It is very important to remove the vials from the reactor after exactly 30 minutes.
- Large quantities of nitrogen free, organic compounds that are included in some water samples may reduce the effectiveness of the digestion by reacting with the persulfate reagent. **Sample**s that are well known to contain large quantities of organic compounds must be diluted and digestion and measurement must be repeated for checking the effectiveness of the digestion.
- Application: for water, wastewater and seawater.
- Interfering substances that resulted in a concentration change of 10%: Bromide more than 60 mg/l and chloride more than 1000 mg/l produce positive interferences.

## ACD007 Nitrogen (Total) High Range Digestion Tube Test

### Persulfate Digestion Method

5 – 150 mg/l N (Nitrite as Nitrogen)

1. Open two TN Hydroxide HR Digestion Vials and add the contents of one TN Persulfate Reagent Power Pack straight from the foil into each vial. Use a funnel to add the reagent. Wipe off any persulfate reagent that may get on the lid or tube threads.
2. Add 0.5 ml of deionized water to the first digestion vial (this is the blank vial).
3. Add 0.5 ml of sample to the second digestion vial (this is the sample vial).
4. Close the vials tightly with the caps and shake the vials for at least 30 seconds to mix contents. The reagent may not dissolve completely.
5. Heat the digestion vials for 30 minutes in the preheated reactor at a temperature of 100 °C.
6. **CAUTION:** *The vials will be hot.* Remove the digestion vials from the reactor and allow them to cool to room temperature.
7. Open the cooled digestion vials and add the contents of one TN Reagent A Power Pack straight from the foil into each vial. Use a funnel to add the reagent.
8. Close the vials tightly with the caps and shake the vials for at least 15 seconds to mix contents.
9. Wait for a reaction period of 3 minutes.
10. Open the digestion vials and add the contents of one TN Reagent B Power Pack straight from the foil into each vial. Use a funnel to add the reagent.
11. Close the vials tightly with the caps and shake the vials for at least 15 seconds to mix contents. The reagent will not completely dissolve.
12. Wait for a reaction period of 2 minutes.
13. Open two TN Acid LR/HR (Reagent C) Vials and add 2 ml of the digested, treated blank to the first vial (this is the blank vial).
14. Add 2 ml of the digested, treated sample to the second vial (this is the sample vial).
15. Close the vials tightly with the caps and gently invert the vials at least 10 times to mix contents. Hold the vial in a vertical position with the cap pointing up. Turn the vial upside-down. Wait for all of the solution to flow down to the cap. Return the vial to the upright position. Wait for all the solution to flow to the bottom of the vial. This process is one inversion; 10 inversions equal about 30 seconds. Wipe the exteriors of the vials.  
**CAUTION:** *The vials will become warm during mixing.*
16. Wait for a reaction period of 5 minutes.
17. Load and run the ACD007 method.
18. Place the blank vial into the holder in the sample chamber and close the chamber door.

19. Tap the **Blank** function key to measure the blank.
20. Open the sample chamber door. Remove the blank vial from the holder.
21. Place the sample vial into the holder in the sample chamber and close the chamber door.
22. Tap the **Sample** function key to display the result in mg/l nitrogen.

**Notes:**

- Appropriate safety precautions and a good lab technique should be used during the whole procedure.
- Volumes for samples and blank should always be measured using 2 ml volumetric pipettes (class A).
- One blank is sufficient for each set of samples. After taking the blank measurement, it is possible to measure several samples.
- It is very important to remove the vials from the reactor after exactly 30 minutes.
- Large quantities of nitrogen free, organic compounds that are included in some water samples may reduce the effectiveness of the digestion by reacting with the persulfate reagent. **Sample**s that are well known to contain large quantities of organic compounds must be diluted and digestion and measurement must be repeated for checking the effectiveness of the digestion.
- Application: for water, wastewater and seawater.
- Interfering substances that resulted in a concentration change of 10%: Bromide more than 60 mg/l and chloride more than 1000 mg/l produce positive interferences.

## AC3048 Ozone Tablet Test

### DPD Method

0.02 – 2 mg/l O<sub>3</sub>

#### Ozone Measurement in Absence of Chlorine

1. Load and run the AC3048 method.
2. Fill a clean AQUAfast 24mm round vial, Cat. No. AC2V24, with 10 ml of sample. Close the vial tightly with the cap. Wipe the exterior of the vial.
3. Place the vial into the holder in the sample chamber. Close the sample chamber door.
4. Tap the **Blank** function key to measure the blank.
5. Open the sample chamber door and remove the vial from the holder.
6. Empty the vial, leaving a few drops of sample remaining in the vial.
7. Add one DPD No. 1 Tablet and one DPD No. 3 Tablet straight from the foil to the vial. Crush the tablets with a clean stir rod.
8. Add sample to the 10 ml mark on the vial.
9. Close the vial tightly with the cap and swirl or invert several times until the tablets are dissolved. Wipe the exterior of the vial.
10. Place the vial into the holder in the sample chamber. Close the sample chamber door.
11. Wait for a reaction period of 2 minutes.
12. Tap the **Sample** function key to display the result in mg/L ozone.

#### Ozone Measurement in Presence of Chlorine

1. Load and run the AC3048 method.
2. Fill a clean AQUAfast 24mm round vial, Cat. No. AC2V24, with 10 ml of sample. Close the vial tightly with the cap. Wipe the exterior of the vial.
3. Place the vial into the holder in the sample chamber. Close the sample chamber door.
4. Tap the **Blank** function key to measure the blank.
5. Open the sample chamber door and remove the vial from the holder.
6. Empty the vial, leaving a few drops of sample remaining in the vial.
7. Add one DPD No. 1 Tablet and one DPD No. 3 Tablet straight from the foil to the vial. Crush the tablets with a clean stir rod.
8. Fill a second clean AQUAfast 24mm round vial with 10 ml of sample. Add one Glycine Tablet straight from the foil to the vial. Crush the tablet with a clean stir rod. Close the vial tightly with the cap and swirl several times until the tablet is dissolved.

9. Transfer the contents of the vial with glycine solution into the vial containing the DPD No. 1 and DPD No. 3 tablets.
10. Close the vial tightly with the cap and swirl or invert several times until the tablets are dissolved. Wipe the exterior of the vial.
11. Place the vial into the holder in the sample chamber. Close the sample chamber door.
12. Wait for a reaction period of 2 minutes.
13. Tap the **Sample** function key to display the result in mg/L ozone.

### Notes:

- Vial cleaning: As many household cleaners (i.e. dishwasher detergent) contain reducing substances, the subsequent determination of ozone may show lower results. To avoid any measurement errors, only use glassware free of chlorine demand.  
Preparation: Put all applicable glassware into a sodium hypochlorite solution (0.1 g/l) for one hour and then rinse all glassware thoroughly with deionized water.
- Preparing the sample: When preparing the sample, the loss of ozone, i.e. by pipetting or shaking, must be avoided. The analysis must take place immediately after taking the sample.
- The DPD color development is carried out at a pH value of 6.2 to 6.5. The reagent tablet therefore contains a buffer for the pH adjustment. Strong alkaline or acidic water samples must be adjusted between pH 6 and pH 7 before the tablet is added (use 0.5 mol/l sulfuric acid or 1 mol/l sodium hydroxide).
- Exceeding the measuring range: Concentrations above 6 mg/l ozone can lead to results showing 0 mg/l. In this case, the water sample must be diluted with water free of ozone. 10 ml of the diluted sample should be mixed with the reagent and the measurement repeated.
- Oxidizing agents such as bromine and chlorine interfere as they react in the same way as ozone.

## AC2001 pH Tablet Test

### Phenol Red Method

6.5 – 8.4 pH

1. Load and run the AC2001 method.
2. Fill a clean AQUAfast 24mm round vial, Cat. No. AC2V24, with 10 ml of sample. Close the vial tightly with the cap. Wipe the exterior of the vial.
3. Place the vial into the holder in the sample chamber and close the chamber door.
4. Tap the **Blank** function key to measure the blank.
5. Open the sample chamber door and remove the vial from the holder.
6. Add one Phenol Red Tablet straight from the foil into the vial. Crush the tablet with a clean stir rod.
7. Close the vial tightly with the cap and swirl or invert several times until the tablet is dissolved. Wipe the exterior of the vial.
8. Place the vial into the holder in the sample chamber and close the chamber door.
9. Tap the **Sample** function key to display the result in pH units.

#### Notes:

- Water samples with low values of alkalinity-m (below 35 mg/l CaCO<sub>3</sub>) may give wrong pH readings.
- pH values below 6.5 and above 8.4 can produce results inside the measuring range. A plausibility test (pH meter) is recommended.
- The accuracy of the colorimetric determination of pH values depends on various boundary conditions (buffer capacity of the sample, salt contents, etc.).
- Salt error: Correction of test results (average values) for samples with salt contents of:

Indicator	Salt Content		
Phenol Red	1 molar – 0.21	2 molar – 0.26	3 molar – 0.29

- The values of Parson and Douglas (1926) are based on the use of Clark and Lubs buffers.  
1 Mol NaCl = 58.4 g/l = 5.8 %

## AC3001 pH Liquid Test

### Phenol Red Method

6.5 – 8.4 pH

1. Load and run the AC3001 method.
2. Fill a clean AQUAfast 24mm round vial, Cat. No. AC2V24, with 10 ml of sample. Close the vial tightly with the cap. Wipe the exterior of the vial.
3. Place the vial into the holder in the sample chamber and close the chamber door.
4. Tap the **Blank** function key to measure the blank.
5. Open the sample chamber door and remove the vial from the holder.
6. Add six drops of Phenol Red Solution to the vial. Add drops of the same size by holding the bottle vertically and squeezing slowly.
7. Close the vial tightly with the cap and swirl or invert several times to mix the contents. Wipe the exterior of the vial.
8. Place the vial into the holder in the sample chamber and close the chamber door.
9. Tap the **Sample** function key to display the result in pH units.

#### Notes:

- When testing chlorinated water, the residual chlorine contents can influence the color reaction of the liquid reagent. This can be avoided (without interfering with the pH measurement) by adding a small crystal of sodium thiosulfate ( $\text{Na}_2\text{S}_2\text{O}_3 \cdot 5 \text{H}_2\text{O}$ ) to the sample before adding the phenol red solution. Phenol red tablets already contain thiosulfate.
- Due to differing drop sizes results can show a discrepancy in accuracy by comparison with tablets. This can be minimized by using a pipette (0.18 ml phenol red solution is equivalent to 6 drops).
- After use, replace the bottle cap securely.
- Store the phenol red solution in a cool, dry place ideally at between 6 °C and 10 °C.



## AC2095-WA Phosphate (Ortho) Low Range Tablet Test

### Phosphomolybdic Acid/Ascorbic Acid

0.05 – 4 mg/l PO<sub>4</sub>

1. Load and run the AC2095 method.
2. Fill a clean AQUAfast 24mm round vial, Cat. No. AC2V24, with 10 ml of sample. Close the vial tightly with the cap. Wipe the exterior of the vial.
3. Place the vial into the holder in the sample chamber and close the chamber door.
4. Tap the **Blank** function key to measure the blank.
5. Open the sample chamber door and remove the vial from the holder.
6. Add one Phosphate No. 1 LR Tablet straight from the foil into the vial. Crush the tablet with a clean stir rod.
7. Add one Phosphate No. 2 LR Tablet straight from the foil into the vial. Crush the tablet with a clean stir rod.
8. Close the vial tightly with the cap and swirl or invert several times until the tablets are dissolved. Wipe the exterior of the vial.
9. Wait for a reaction period of 10 minutes.
10. Place the vial into the holder in the sample chamber and close the chamber door.
11. Tap the **Sample** function key to display the result in mg/l ortho-phosphate.

#### Notes:

- Only ortho-phosphate ions react.
- The tablets must be added in the correct sequence.
- The test sample should have a pH value between 6 and 7.
- Interferences: Higher concentrations of Cu, Ni, Cr (III), V (V) and W (VI) interfere due to their color. Silicates do not interfere (masked by citric acid in the tablets).
- Ortho-phosphate ions react with the reagent to form an intense blue color.
- Phosphate in organic and condensed inorganic forms (meta-, pyro- and polyphosphates) must be converted to ortho-phosphate ions before analysis. Pretreatment of the sample with acid and heat provides the conditions for hydrolysis of the condensed inorganic forms. Organically combined phosphates are converted to ortho-phosphate ions by heating with acid and persulfate. The amount of organically combined phosphates can be calculated:  
mg/l phosphate (organic) = mg/l phosphate (total) - mg/l phosphate (acid hydrolysable)
- Phosphate, ortho = Phosphorus, reactive

## AC2096 Phosphate (Ortho) High Range Tablet Test

### Vanado-Molybdate Method

1 – 80 mg/l PO<sub>4</sub>

1. Load and run the AC2096 method.
2. Fill a clean AQUAfast 24mm round vial, Cat. No. AC2V24, with 10 ml of sample. Close the vial tightly with the cap. Wipe the exterior of the vial.
3. Place the vial into the holder in the sample chamber and close the chamber door.
4. Tap the **Blank** function key to measure the blank.
5. Open the sample chamber door and remove the vial from the holder.
6. Add one Phosphate HR P1 Tablet straight from the foil into the vial. Crush the tablet with a clean stir rod.
7. Add one Phosphate HR P2 Tablet straight from the foil into the vial. Crush the tablet with a clean stir rod.
8. Close the vial tightly with the cap and swirl or invert several times until the tablets are dissolved. Wipe the exterior of the vial.
9. Wait for a reaction period of 10 minutes.
10. Place the vial into the holder in the sample chamber and close the chamber door.
11. Tap the **Sample** function key to display the result in mg/l ortho-phosphate.

### Notes:

- For samples under 5 mg/l PO<sub>4</sub>, it is recommended to analyze the sample using the AC2095 phosphate (ortho) low range tablet test method.
- Only ortho-phosphate ions react.
- Phosphate in organic and condensed inorganic forms (meta-, pyro- and polyphosphates) must be converted to ortho-phosphate ions before analysis. Pretreatment of the sample with acid and heat provides the conditions for hydrolysis of the condensed inorganic forms. Organically combined phosphates are converted to ortho-phosphate ions by heating with acid and persulfate. The amount of organically combined phosphates can be calculated:  
$$\text{mg/l phosphate (organic)} = \text{mg/l phosphate (total)} - \text{mg/l phosphate (acid hydrolysable)}$$
- The ortho-phosphate ions react with the vanadate-molybdate reagent under acid conditions to form a yellow colored product.
- Phosphate, ortho = Phosphorus, reactive

## AC4P95 Phosphate (Ortho) Powder Pack Test

### Phosphomolybdenum/Ascorbic Acid

0.06 – 2.5 mg/l PO<sub>4</sub>

1. Load and run the AC4P95 method.
2. Fill a clean AQUAfast 24mm round vial, Cat. No. AC2V24, with 10 ml of sample. Close the vial tightly with the cap. Wipe the exterior of the vial.
3. Place the vial into the holder in the sample chamber and close the chamber door.
4. Tap the **Blank** function key to measure the blank.
5. Open the sample chamber door and remove the vial from the holder.
6. Add the contents of one Phosphate Rgt. F10 Powder Pack straight from the foil into the vial.
7. Close the vial tightly with the cap and swirl or invert several times for 10-15 seconds to mix contents. The powder will not dissolve completely. Wipe the exterior of the vial.
8. Wait for a reaction period of 2 minutes.
9. Place the vial into the holder in the sample chamber and close the chamber door.
10. Tap the **Sample** function key to display the result in mg/l ortho-phosphate.

#### Notes:

- Ortho-phosphate ions react with the reagent to form an intense blue color.
- Phosphate in organic and condensed inorganic forms (meta-, pyro- and polyphosphates) must be converted to ortho-phosphate ions before analysis. Pretreatment of the sample with acid and heat provides the conditions for hydrolysis of the condensed inorganic forms. Organically combined phosphates are converted to ortho-phosphate ions by heating with acid and persulfate. The amount of organically combined phosphates can be calculated:  
mg/l phosphate (organic) = mg/l phosphate (total) - mg/l phosphate (acid hydrolysable)
- Application: for water, wastewater and seawater.
- Highly buffered samples or samples with extreme pH values should be adjusted between pH 2 and pH 10 before analysis with 1 mol/l hydrochloric acid or 1 mol/l sodium hydroxide.
- Phosphate, ortho = Phosphorus, reactive
- Interferences: Large amounts of turbidity may cause inconsistent results.

Interference	Interference Level
Aluminum	greater than 200 mg/l
Arsenate	at any level
Chromium	greater than 100 mg/l
Copper	greater than 10 mg/l
Iron	greater than 100 mg/l

Interference	Interference Level
Nickel	greater than 300 mg/l
Silica (Silicium dioxide)	greater than 50 mg/l
Silicate	greater than 10 mg/l
Sulfide	at any level
Zinc	greater than 80 mg/l

## ACR095 Phosphate (Ortho) Reaction Tube Test

### Phosphomolybdenum/Ascorbic Acid Method

0.06 – 5 mg/l PO<sub>4</sub>

1. Load and run the ACR095 method.
2. Open one 16 mm PO4-P Dilution Tube and add 5 ml of sample. Wipe the exterior of the vial.
3. Place the vial into the holder in the sample chamber and close the chamber door.
4. Tap the **Blank** function key to measure the blank.
5. Open the sample chamber door. Remove the vial from the holder.
6. Add the contents of one Phosphate Rgt. F10 Power Pack straight from the foil into the vial. Use a funnel to add the reagent.
7. Close the vial tightly with the cap and swirl the vial for 10-15 seconds to mix contents. The reagent will not completely dissolve. Wipe the exterior of the vial.
8. Wait for a reaction period of 2 minutes.
9. Place the vial into the holder in the sample chamber and close the chamber door.
10. Tap the **Sample** function key to display the result in mg/l ortho-phosphate.

#### Notes:

- Ortho-phosphate ions react with the reagent to form an intense blue color.
- Phosphate in organic and condensed inorganic forms (meta-, pyro- and polyphosphates) must be converted to ortho-phosphate ions before analysis. Pretreatment of the sample with acid and heat provides the conditions for hydrolysis of the condensed inorganic forms. Organically combined phosphates are converted to ortho-phosphate ions by heating with acid and persulfate. The amount of organically combined phosphates can be calculated:  
mg/l phosphate (organic) = mg/l phosphate (total) - mg/l phosphate (acid hydrolysable)
- Application: for water, wastewater and seawater.
- Highly buffered samples or samples with extreme pH values should be adjusted between pH 2 and pH 10 before analysis with 1 mol/l hydrochloric acid or 1 mol/l sodium hydroxide.
- Phosphate, ortho = Phosphorus, reactive
- Interferences: Large amounts of turbidity may cause inconsistent results.

Interference	Interference Level
Aluminum	greater than 200 mg/l
Arsenate	at any level
Chromium	greater than 100 mg/l
Copper	greater than 10 mg/l
Iron	greater than 100 mg/l

Interference	Interference Level
Nickel	greater than 300 mg/l
Silica (Silicium dioxide)	greater than 50 mg/l
Silicate	greater than 10 mg/l
Sulfide	at any level
Zinc	greater than 80 mg/l

## ACD095 Phosphate (Total) Digestion Tube Test

### Persulfate Digestion/Ascorbic Acid Method

0.02 – 1.1 mg/l P (Phosphate as Phosphorous)

1. Open one 16 mm PO<sub>4</sub>-P Acid Reagent Digestion Tube and add 5 ml of sample.
2. Add the contents of one Potassium Persulfate F10 Power Pack straight from the foil into the vial. Use a funnel to add the reagent.
3. Close the vial tightly with the cap and invert the vial several times to mix the contents.
4. Heat the vial for 30 minutes in the preheated reactor at a temperature of 100 °C.
5. **CAUTION:** *The vial will be hot.* Remove the vial from the reactor and allow it to cool to room temperature.
6. Open the cooled digestion vial and add 2 ml of 1.54 N Sodium Hydroxide Solution to the vial.
7. Close the vial tightly with the cap and gently invert the vial several times to mix the contents. Wipe the exterior of the vial.
8. Load and run the ACD095 method.
9. Place the vial into the holder in the sample chamber and close the chamber door.
10. Tap the **Blank** function key to measure the blank.
11. Open the sample chamber door. Remove the vial from the holder.
12. Add the contents of one Phosphate Rgt. F10 Power Pack straight from the foil into the vial. Use a funnel to add the reagent.
13. Close the vial tightly with the cap and swirl the vial for 10-15 seconds to mix the contents. The reagent will not completely dissolve. Wipe the exterior of the vial.
14. Wait for a reaction period of 2 minutes.
15. Place the vial into the holder in the sample chamber and close the chamber door.
16. Tap the **Sample** function key to display the result in mg/l total phosphate as phosphorus (P).

#### Notes:

- Appropriate safety precautions and good lab technique should be used during the whole procedure.
- Ortho-phosphate ions react with the reagent to form an intense blue color.
- Phosphate in organic and condensed inorganic forms (meta-, pyro- and polyphosphates) must be converted to ortho-phosphate ions before analysis. Pretreatment of the sample with acid and heat provides the conditions for hydrolysis of the condensed inorganic forms. Organically combined phosphates are converted to ortho-phosphate ions by heating with

acid and persulfate. The amount of organically combined phosphates can be calculated:  
 $\text{mg/l phosphate (organic)} = \text{mg/l phosphate (total)} - \text{mg/l phosphate (acid hydrolysable)}$

- Application: for water, wastewater and seawater.
- Highly buffered samples or samples with extreme pH values should be adjusted between pH 2 and pH 10 before analysis with 1 mol/l hydrochloric acid or 1 mol/l sodium hydroxide.
- Phosphate, ortho = Phosphorus, reactive
- Interferences: Large amounts of turbidity may cause inconsistent results.

Interfering Substance	Interference Level
Aluminum	greater than 200 mg/l
Arsenate	at any level
Chromium	greater than 100 mg/l
Copper	greater than 10 mg/l
Iron	greater than 100 mg/l
Nickel	greater than 300 mg/l
Silica (Silicium dioxide)	greater than 50 mg/l
Silicate	greater than 10 mg/l
Sulfide	at any level
Zinc	greater than 80 mg/l

- Conversions:  $\text{mg/l PO}_4 = \text{mg/l P} \times 3.07$   
 $\text{mg/l P}_2\text{O}_5 = \text{mg/l P} \times 2.29$

## ACD095AH Phosphate (Acid Hydrolysable) Digestion Tube Test

### Acid Digestion/Ascorbic Acid Method

0.02 – 1.6 mg/l P (Phosphate as Phosphorous)

1. Open one 16 mm PO<sub>4</sub>-P Acid Reagent Digestion Tube and add 5 ml of sample.
2. Close the vial tightly with the cap and gently invert the vial several times to mix the contents.
3. Heat the vial for 30 minutes in the preheated reactor at a temperature of 100 °C.
4. **CAUTION:** *The vial will be hot.* Remove the vial from the reactor and allow it to cool to room temperature.
5. Open the cooled digestion vial and add 2 ml of 1.00 N Sodium Hydroxide Solution to the vial.
6. Close the vial tightly with the cap and gently invert the vial several times to mix the contents. Wipe the exterior of the vial.
7. Load and run the ACD095AH method.
8. Place the vial into the holder in the sample chamber and close the chamber door.
9. Tap the **Blank** function key to measure the blank.
10. Open the sample chamber door. Remove the vial from the holder.
11. Add the contents of one Phosphate Rgt. F10 Power Pack straight from the foil into the vial. Use a funnel to add the reagent.
12. Close the vial tightly with the cap and swirl the vial for 10-15 seconds to mix contents. The reagent will not completely dissolve. Wipe the exterior of the vial.
13. Wait for a reaction period of 2 minutes.
14. Place the vial into the holder in the sample chamber and close the chamber door.
15. Tap the **Sample** function key to display the result in mg/l acid hydrolysable phosphate as phosphorus (P).

#### Notes:

- Appropriate safety precautions and good lab technique should be used during the whole procedure.
- Ortho-phosphate ions react with the reagent to form an intense blue color.
- Phosphate in organic and condensed inorganic forms (meta-, pyro- and polyphosphates) must be converted to ortho-phosphate ions before analysis. Pretreatment of the sample with acid and heat provides the conditions for hydrolysis of the condensed inorganic forms. Organically combined phosphates are converted to ortho-phosphate ions by heating with

acid and persulfate. The amount of organically combined phosphates can be calculated:  
 $\text{mg/l phosphate (organic)} = \text{mg/l phosphate (total)} - \text{mg/l phosphate (acid hydrolysable)}$

- Application: for water, wastewater and seawater.
- Highly buffered samples or samples with extreme pH values should be adjusted between pH 2 and pH 10 before analysis with 1 mol/l hydrochloric acid or 1 mol/l sodium hydroxide.
- Phosphate, ortho = Phosphorus, reactive
- Interferences: Large amounts of turbidity may cause inconsistent results.

Interfering Substance	Interference Level
Aluminum	greater than 200 mg/l
Arsenate	at any level
Chromium	greater than 100 mg/l
Copper	greater than 10 mg/l
Iron	greater than 100 mg/l
Nickel	greater than 300 mg/l
Silica (Silicium dioxide)	greater than 50 mg/l
Silicate	greater than 10 mg/l
Sulfide	at any level
Zinc	greater than 80 mg/l

- Conversions:  $\text{mg/l PO}_4 = \text{mg/l P} \times 3.07$   
 $\text{mg/l P}_2\text{O}_5 = \text{mg/l P} \times 2.29$



## AC2060 Silica Tablet Test

### Silicomolybdate Method

0.05 – 4 mg/l SiO<sub>2</sub>

1. Load and run the AC2060 method.
2. Fill a clean AQUAfast 24mm round vial, Cat. No. AC2V24, with 10 ml of sample. Close the vial tightly with the cap. Wipe the exterior of the vial.
3. Place the vial into the holder in the sample chamber and close the chamber door.
4. Tap the **Blank** function key to measure the blank.
5. Open the sample chamber door and remove the vial from the holder.
6. Add one Silica No. 1 Tablet straight from the foil into the vial. Crush the tablet with a clean stir rod.
7. Close the vial tightly with the cap and swirl or invert several times until the tablet is dissolved.
8. Wait for a reaction period of 5 minutes.
9. Add one Silica No. 2 Tablet straight from the foil into the vial. Crush the tablet with a clean stir rod.
10. Close the vial tightly with the cap and swirl or invert several times until the tablet is dissolved. Wipe the exterior of the vial.
11. Wait for a reaction period of 1 minute.
12. Place the vial into the holder in the sample chamber and close the chamber door.
13. Tap the **Sample** function key to display the result in mg/l silica.

#### Notes:

- The tablets must be added in the correct sequence.

## AC2061 Silica with Phosphate Removal Tablet Test

### Silicomolybdate Method with Phosphate Removal

0.05 – 4 mg/l SiO<sub>2</sub>

1. Load and run the AC2061 method.
2. Fill a clean AQUAfast 24mm round vial, Cat. No. AC2V24, with 10 ml of sample. Close the vial tightly with the cap. Wipe the exterior of the vial.
3. Place the vial into the holder in the sample chamber and close the chamber door.
4. Tap the **Blank** function key to measure the blank.
5. Open the sample chamber door and remove the vial from the holder.
6. Add one Silica No. 1 Tablet straight from the foil into the vial. Crush the tablet with a clean stir rod.
7. Close the vial tightly with the cap and swirl or invert several times until the tablet is dissolved.
8. Wait for a reaction period of 5 minutes.
9. Add one Silica PR Tablet straight from the foil into the vial. Crush the tablet with a clean stir rod.
10. Add one Silica No. 2 Tablet straight from the foil into the same vial. Crush the tablet with a clean stir rod.
11. Close the vial tightly with the cap and swirl or invert several times until the tablets are dissolved. Wipe the exterior of the vial.
12. Wait for a reaction period of 1 minute.
13. Place the vial into the holder in the sample chamber and close the chamber door.
14. Tap the **Sample** function key to display the result in mg/l silica.

#### Notes:

- The tablets must be added in the correct sequence.
- Phosphate ions do not interfere under the given reaction conditions.
- If phosphate is known to be absent, the addition of the Silica PR Tablet may be omitted.

## AC4P60 Silica Powder Pack Test

### Silicomolybdate Method

1 – 90 mg/l SiO<sub>2</sub>

1. Load and run the AC4P60 method.
2. Fill a clean AQUAfast 24mm round vial, Cat. No. AC2V24, with 10 ml of sample. Temperature of the sample should be 15 °C to 25 °C. Close the vial tightly with the cap. Wipe the exterior of the vial.
3. Place the vial into the holder in the sample chamber and close the chamber door.
4. Tap the **Blank** function key to measure the blank.
5. Open the sample chamber door and remove the vial from the holder.
6. Add the contents of one Silica HR Molybdate F10 Powder Pack straight from the foil into the vial.
7. Close the vial tightly with the cap and swirl or invert several times to mix the contents.
8. Add the contents of one Silica HR Acid Rgt. F10 Powder Pack straight from the foil into the same vial. If silica or phosphate is present, a yellow color will develop.
9. Close the vial tightly with the cap and swirl or invert several times to mix the contents.
10. Wait for a reaction period of 10 minutes.
11. Add the contents of one Silica Citric Acid F10 Powder Pack straight from the foil into the same vial. In this step, any yellow color due to phosphate is removed.
12. Close the vial tightly with the cap and swirl or invert several times to mix the contents. Wipe the exterior of the vial.
13. Wait for a reaction period of 2 minutes.
14. Place the vial into the holder in the sample chamber and close the chamber door.
15. Tap the **Sample** function key to display the result in mg/l silica.

#### Notes:

- Occasionally water samples contain forms of silica which reacts very slowly with molybdate. The nature of these forms is not known.
- A pre-treatment with sodium hydrogen carbonate and then with sulfuric acid will make these forms reactive to molybdate (pre-treatment is given in “Standard Methods for the Examination of Water and Wastewater” under “Silica Digestion with Sodium Bicarbonate”).

Substance	Interference
Iron	Large amounts interfere
Phosphate	Does not interfere at concentrations less than 50 mg/l PO <sub>4</sub> At 60 mg/l PO <sub>4</sub> the interference is approximately 2% At 75 mg/l PO <sub>4</sub> the interference is approximately 11 %
Sulfide	Interferes at all levels

## AC4P82 Sulfate Powder Pack Test

### Barium Sulfate/Turbidity Method

5 – 100 mg/l SO<sub>4</sub>

1. Load and run the AC4P82 method.
2. Fill a clean AQUAfast 24mm round vial, Cat. No. AC2V24, with 10 ml of sample. Close the vial tightly with the cap. Wipe the exterior of the vial.
3. Place the vial into the holder in the sample chamber and close the chamber door.
4. Tap the **Blank** function key to measure the blank.
5. Open the sample chamber door and remove the vial from the holder.
6. Add the contents of one Sulpha 4/F10 Powder Pack straight from the foil into the vial.
7. Close the vial tightly with the cap and swirl or invert several times to mix the contents. Wipe the exterior of the vial.
8. Wait for a reaction period of 5 minutes.
9. Place the vial into the holder in the sample chamber and close the chamber door.
10. Tap the **Sample** function key to display the result in mg/l sulfate.

#### Notes:

- If sulfate ions are present a cloudy solution will appear.

## AC2016 Sulfide Tablet Test

### DPD/Catalyst Method

0.04 – 0.5 mg/l S

1. Load and run the AC2016 method.
2. Fill a clean AQUAfast 24mm round vial, Cat. No. AC2V24, with 10 ml of sample. Close the vial tightly with the cap. Wipe the exterior of the vial.
3. Place the vial into the holder in the sample chamber and close the chamber door.
4. Tap the **Blank** function key to measure the blank.
5. Open the sample chamber door and remove the vial from the holder.
6. Add one Sulfide No. 1 Tablet straight from the foil into the vial. Crush the tablet with a clean stir rod.
7. Add one Sulfide No. 2 Tablet straight from the foil into the same vial. Crush the tablet with a clean stir rod.
8. Close the vial tightly with the cap and swirl or invert several times until the tablets are dissolved. Wipe the exterior of the vial.
9. Wait for a reaction period of 10 minutes.
10. Place the vial into the holder in the sample chamber and close the chamber door.
11. Tap the **Sample** function key to display the result in mg/l sulfide.

### Notes:

- The tablets must be added in the correct sequence.
- Chlorine and other oxidizing agents that react with DPD do not interfere with the test.
- To avoid loss of sulfide, collect the sample carefully with a minimum of aeration. It is essential to test the sample immediately after collection.
- The sample temperature should be 20 °C. A different temperature can lead to higher or lower results.

## AC2065 Zinc Tablet Test

### Zincon Method

0.02 – 1 mg/l Zn

1. Load and run the AC2065 method.
2. Fill a clean AQUAfast 24mm round vial, Cat. No. AC2V24, with 10 ml of deionized water. Close the vial tightly with the cap. Wipe the exterior of the vial.
3. Place the vial into the holder in the sample chamber and close the chamber door.
4. Tap the **Blank** function key to measure the blank.
5. Empty and dry the vial and then fill the vial with 10 ml of sample.
6. Add one Copper / Zinc LR Tablet straight from the foil into the vial. Crush the tablet with a clean stir rod.
7. Close the vial tightly with the cap and swirl or invert several times until the tablet is dissolved. Wipe the exterior of the vial.
8. Wait for a reaction period of 5 minutes.
9. Place the vial into the holder in the sample chamber and close the chamber door.
10. Press the **Measure Rgnt Blank** function key to measure the reagent blank.
11. Open the sample chamber door and remove the vial from the holder.
12. Add one EDTA Tablet straight from the foil into the vial. Crush the tablet with a clean stir rod.
13. Close the vial tightly with the cap and swirl or invert several times until the tablet is dissolved. Wipe the exterior of the vial.
14. Place the vial into the holder in the sample chamber and close the chamber door.
15. Tap the **Sample** function key to display the result in mg/l zinc.

### Notes:

- Reverse color methods use a reagent that, when prepared with samples, decreases in color as the concentration of the species being measured in the samples increases. Reverse color methods require the use of both a blank and a reagent blank. The blank is a clear solution (deionized water) with zero absorbance. The reagent blank is a mixture of the reagent and sample (with no EDTA reagent) and provides a zero concentration point with the darkest color (highest absorbance). The color of samples prepared with the EDTA reagent will decrease as the concentration increases for this method.
- Measuring the reagent blank needs to be done with each sample analysis.
- The tablets must be added in the correct sequence.
- In the case of high levels of residual chlorine, perform the analysis with a dechlorinated water sample.

## Color Measurement from Application Log #131

### Color Measurement – Water Color

The color of our water is important not only for drinking purposes, but also for aquatic environments, and for home and industrial uses. Color in water can be caused by dissolved and suspended materials. In water and wastewater color measurement, there is a distinction between apparent color and true color<sup>1</sup>. Apparent color is the color of the sample as received and includes color due to both the dissolved and suspended materials in the water. True color is the color in the sample after it has been filtered to remove suspended materials, such as algae and particulates which cause turbidity. True color is the result of only dissolved species in water – natural organic matter, minerals, or chemicals.

### Techniques to Measure Color in Water

There are two main approaches to measuring water color:

- Visual methods – a water sample is visually compared to a series of colored standards.
- Spectrophotometric methods – the color is determined by measuring how much light is absorbed or transmitted through a sample at a single wavelength or at a number of certain wavelengths. The results are then compared with a known color standard or used in various algorithms, which are defined by the test method.

Many groups publish methods for measuring color. Examples of spectrophotometric methods are Platinum-Cobalt Color, Tristimulus Values, and ADMI methods<sup>2</sup>. Specific method references for color in water include: APHA Standard Methods 2120; EPA 110.1; DIN ISO 7887 and SAC 436 nm; China MEP GB 11903; NCASI Technical Bulletin 253 or 803; and others.

### Color Standards and Color Units

#### Platinum Cobalt Color Standard and Units

The most common color measurement of water and wastewater is Platinum-Cobalt (Pt-Co) color, also known as APHA color or Hazen color. These names are commonly used in different applications, but they are based on identical procedures. Measurement with the Pt-Co/PHA/Hazen standard is based on the Hazen color scale that was introduced in 1892 by chemist Allen Hazen. The color is a light yellow to brown color. The range is 0 to 500 Platinum Color Units (PCU). Intermediate standards are prepared from a platinum cobalt 500 ppm stock solution that is available commercially<sup>3</sup> or can be prepared by user<sup>1</sup>. A unit of color is the color produced by 1 mg/L platinum in the form of chloroplatinum ion. The color values measured by comparison with the platinum-cobalt standards can be expressed as PCU, Pt-Co, APHA, or Hazen units depending on the specific procedures. In the United States, the National Secondary Drinking Water Regulation for color is a maximum of 15 color units. The World Health Organization recommends that drinking water color does not to exceed 15 true color units.

## Other Color Standards and Color Units

For samples where the color is different from Pt-Co standards, several different standards and color scales are used such as: ADMI Color (American Dye Manufacturer's Institute), Gardner Color, Saybolt, Rosin, EBC (European Brewery Convention), CIE System, etc.

## Platinum Cobalt Color Methods

Two single-wavelength methods are commonly used in the United States to measure water and wastewater color with color characteristics similar to that of the Pt-Co standards:

- **Water/Wastewater at 455 nm:** This method utilizes a spectrophotometer to measure the absorbance of light as it passes through a sample at the 455 nm wavelength. This procedure is recommended for water from naturally occurring materials, i.e., vegetable residues such as leaves, barks, roots, humus and peat materials. If samples are turbid, they should be filtered prior to the analysis through 0.45  $\mu\text{m}$  filter to determine the true color. To determine the apparent color, non-filtered samples are measured. **Samples** with a high color (>500 PCU) should be diluted until the color is within the range of the standard curve. **Sample pH** should not be adjusted if it is between 4 and 10.
- **Pulp Mill Wastewater at 465 nm:** This method utilizes a spectrophotometer to measure the absorbance of light as it passes through a sample at the 465 nm wavelength. This method is adapted from the NCASI Technical Bulletin 803 for pulp and paper effluent<sup>4</sup> (which supersedes NCASI Technical Bulletin 253). The true color is determined in a sample with the pH adjusted to 7.6 +/- 0.05 pH and then passed through a 0.8  $\mu\text{m}$  filter. The apparent color is determined in the original sample. **Samples** with high color should be diluted to fall within the range of the standard curve.

There are also multiple-wavelength methods, which are recommended for color measurement in waters and wastewaters having color characteristics different from, but not excluding, platinum-cobalt standards. Such a method is SM 2120D-2001, which is used to calculate Tristimulus Values and ultimately values for the dominant wavelength, hue, luminance, and purity of a sample<sup>2</sup>. According to this method, the spectrophotometer examines a number of points (e.g. 10 or 30 points) in the range from 400 to 700 nm to determine the transmittance at each wavelength and uses the obtained values to calculate color by the published computation method. A modification of the Tristimulus Method that is used in water and waste water industry is based on the measurement of percent transmittance at three wavelengths (590, 540 and 438nm)<sup>5</sup>.

## Range, Detection Limit, and Sample Cell Size

Accuracy, precision, and detection limits that can be obtained by a specific color measurement procedure depend on the quality of the instrument optics and the sample cell path length.

- Spectrophotometers allow for more accurate and precise results than colorimeters, but are more expensive. Lowest detection limits and better accuracy at low levels can be achieved on a spectrophotometer by choosing a sample cell with a longer cell path length.



- Colorimeters are useful for testing outside the laboratory and indicate relative color intensity. Color values determined on a colorimeter may differ from color values determined on a spectrophotometer, especially when the colorimeter wavelength does not match the wavelength used on the spectrophotometer.
- **Sample** cells for color testing are made of glass. Glass is suitable for testing in the visible wavelength range. A round glass 24 mm or 25 mm cell gives satisfactory results. For best accuracy and precision at color levels that are lower than 15 color units, a rectangular glass 50 mm cell is recommended. The 10 mm sample cell size is not recommended for color testing.

### Turbidity Effect on Color Measurement

When measuring “true” color, turbidity must be removed, since it can cause light scattering and increase the color value. Turbidity may also affect the precision of the measurement. Chart 1 demonstrates that filtering reduces the color reading – the more turbid the sample, the more significant the effect. Chart 2 shows that the filtered sample generally shows better precision, especially for turbid samples.

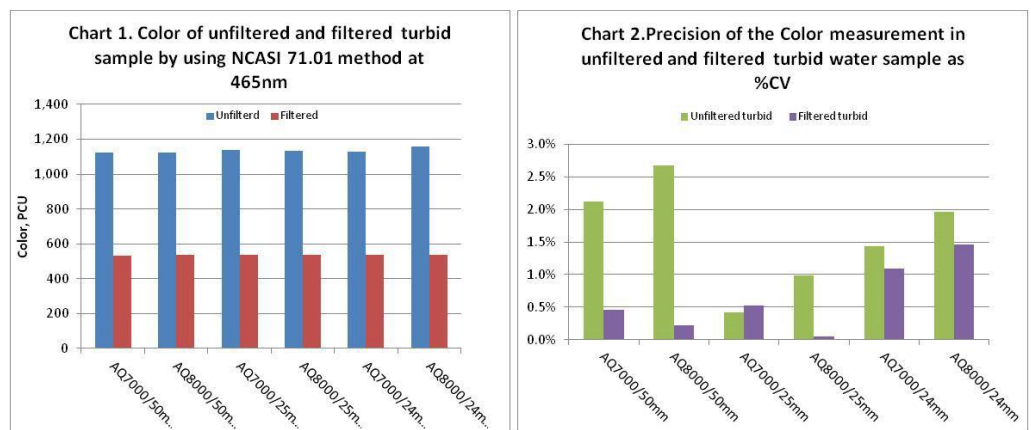

### Thermo Scientific Orion AquaMate Spectrophotometers for Color Measurement

The Thermo Scientific Orion AquaMate AQ8000 UV-Vis and AQ7000 Vis spectrophotometers have the required wavelengths to analyze for any color measurement – by preprogrammed methods, by a user-generated standard curve, or by multiple wavelengths, if desired. The following table describes some of the color methods which may be tested on the Orion AQ7000 and AQ8000 spectrophotometers.

Color Method	Preprogrammed name or user defined	Sample Cell Size	Wavelength(s)	Scope of the method
Platinum–Cobalt Color Method: absorbance measured at one wavelength. Range: 0 -500 PCU	CLRPT50 CLRPT25 CLRPT24 User Method	50 mm 25 mm 24 mm 10-50 mm	455 nm	Water and wastewater samples of color similar to Pt-Co color standards
Adaptation of NCASI 253/803: absorbance measured at one wavelength. Range: 0 -500 PCU	CLRPTP50 CLRPTP25 CLRPTP24 User Method	50 mm 25 mm 24 mm 10-50 mm	465 nm	Color in pulp mill wastewaters
ISO 7887; GB 11903: Water Quality - Examination and Determination of Color	User Method	50 mm	436 nm 525 nm 620 nm	Raw and potable water, industrial water of low color
Tristimulus Values Method: transmittance is measured at multiple wavelength in the 400 – 700 nm range	User Method	10 mm or 50 mm	Multiple wavelengths 400 to 700nm range	Water and wastewater samples of color different from, but not excluding, Pt-Co standards

## Application Notes

Application notes for color testing are available through your local technical sales representative, our technical support service, our website and other Thermo Scientific web locations. These notes give detailed information on how to test for color on our Thermo Scientific Orion AquaMate spectrophotometers: AQ7000 visible range and AQ8000 UV/Vis range. Application Notes available include:

- Log 133, Color of water and wastewater by Pt-Co method at 455 nm
- Log 134, Color of pulp mill wastewater by Pt-Co method at 465 nm (NCASI method)

## References

1. Standard Methods for the Examination of Water and Wastewater, Method 2120B. [www.standardmethods.org](http://www.standardmethods.org)
2. Standard Methods for the Examination of Water and Wastewater, Method 2120. [www.standardmethods.org](http://www.standardmethods.org)
3. Available through Fisher Scientific at [www.fishersci.com](http://www.fishersci.com)
4. NCASI, Technical Bulletin No. 253, Dec. 1971. See 40CFR Part 136, Table IB, footnote 18. [www.ecf.gov](http://www.ecf.gov)
5. EPA Color Method 110.1. <http://www.umass.edu/tei/mwwp/acrobat/epa110.1colorspec.pdf>

## UVA and UV254 Measurements from Application Log #137

### UVA and UV254 Measurement of Water

This method utilizes a spectrophotometer to measure the absorbance of waters, such as drinking water and source water, at 254nm wavelength. These results may be correlated to organic carbon, color, and/or disinfection byproduct precursors. Results can also indicate the efficacy of treatment processes that remove organic carbon or results may be used with a corresponding total organic carbon (TOC) result to calculate the Specific UV Absorbance (SUVA) value for a water sample. See Reference 1 for details.

### References

1. EPA Method 415.3 Rev 1.1. UV254 for SUVA. <http://www.epa.gov/microbes/ordmeth.htm>
2. Standard Methods 5910B, UV-Absorbing Organic Constituents. [www.standardmethods.org](http://www.standardmethods.org)
3. Orion AquaMate 8100 UV-Vis Instrument User Guide

### Recommended Equipment

- Thermo Scientific Orion AquaMate AQ8000 spectrophotometer
- Filtration apparatus (e.g., Fisher XX1004707); 0.45- $\mu$ m filters, 47 mm (e.g., Fisher HNWP04700)
- Vacuum source-aspirator, air flow or water flow, hand-operated or low pressure electric vacuum pump
- UV disposable cuvettes 1 cm (Fisher 14-377-009) or quartz sample cells
- Carousel for 10 cm cell, if needed (Orion AQ100C)
- Orion pH meter and electrode

### Solutions

1. Organic-free deionized water (DI).
2. Reagents for pH adjustment. Sodium hydroxide, 0.1N; Hydrochloric acid, 0.1N; Orion pH 4.01 and 7.00 Buffers (Orion 910104, Orion 910107).
3. Spectrophotometer Check Solution (SCS), optional: Organic Carbon, KHP in pH 7 phosphate buffer, see Reference 2 for preparation; or, Commercial SCS, PN 222-234700 ([www.unitylabservices.com](http://www.unitylabservices.com)).

### Sample Cell Storage and Cleaning

To obtain reproducible results, clean and store sample cells per instructions in the Orion AquaMate Instrument User Guide.

## Instrument Setup

Turn on the spectrophotometer. Choose a suitable cell size and method for the organic carbon content expected in your samples. Refer to the following chart. Select the desired cell holder position (1 or 5 cm) by pressing the cell position key. For 10 cm, install the carousel with 10 cm holder. Access the USB memory stick using a computer. Copy the desired preprogrammed method from the Orion folder to the Thermo folder (see Note 1). Remove the USB memory stick from the computer and insert it into the USB port on the front of the AquaMate. Select the method and load it. Press the **Run Test** function to start the analysis. Refer to the following chart for choosing the method.

Sample Concentration	Organic Carbon > 0.5 mg/L	Organic Carbon >0.1 mg/L	Organic Carbon >0.05 mg/L
Quartz Cell Size (see Note 2)	1 cm (10 mm)	5 cm (50 mm)	10 cm (100 mm)
Method Name	UV254_1	UV254_5	UV254_10

## Zero the Instrument: Spectrophotometer Check

1. Touching only the frosted sides of the cell, rinse a clean cell three times with DI water. Then fill with DI water. Use a lint-free wiper to remove water on the outside.
2. Open the sample compartment and insert the sample cell containing DI water (the blank) into the sample holder, with the clear sides facing front and back. If sample cell is not in the light path, press the correct sample position key. Close the lid, then Tap the **Blank** function key.
3. If required, test an SCS: Using the same cell, empty and fill with the prepared SCS, wipe dry, and insert into the sample holder. Close the lid, and Tap the **Sample** key. Record the displayed result.
4. The reading for the SCS should be within the desired criteria, per your QA plan. See Results section for examples.

## Sample Storage

Samples are not preserved. Analyze as soon as possible after collection. Samples may be stored for up to 48 hours at <6°C prior to analysis. See EPA Method 415.3 for SUVA storage.

## Sample Preparation: pH adjust and/or sample filtration

For non-SUVA: If the pH is not between 4 and 10, adjust pH per steps in "pH Adjustment of Sample" (p.2). Note: Do not adjust pH for a SUVA determination.

For UVA, UV254: Set up the filtration apparatus with a 0.45 um filter. Wash the filter with 50 mL DI and discard the rinse water. Filter 50 mL of the sample. Test the filtrate.

## Sample Measurement

Ensure the instrument has been zeroed properly. Touching only the frosted sides of the cell, rinse the clean cell with a portion of the filtered sample, then fill with the filtered sample. Wipe dry. Insert the sample cell into the holder, close the lid, and Tap the **Sample** key. Record the displayed result. The results can be saved to the USB stick, if desired. If the reading is >0.900 absorbance, dilute and retest. Multiply the reading by the dilution factor. If the results are <0.010 absorbance, consider using a larger cell. Load the appropriate method, and re-zero the instrument.

## Quality Control (QC)

Run an SCS and duplicate samples with each batch, or run QC samples per your QA plan. For SUVA testing, follow requirements of EPA Method 415.3. See Reference 1.

## pH Adjustment of Sample

1. Note: Do not adjust the pH of a sample which will be used for a SUVA calculation. Proceed to the filtration step.
2. Calibrate the pH probe in pH 4.01 and 7.00 buffers.
3. Warm the sample up to room temperature.
4. Shake the sample to insure homogeneity.
5. Measure 50 mL of the sample to a 100-mL beaker using a graduated cylinder.
6. Immerse the pH probe in the sample and record the initial pH.
7. Adjust the sample into the range of pH 4 to 10, by adding drop-wise 0.1N sodium hydroxide to raise the pH or by adding drop-wise 0.1N hydrochloric acid to lower the pH. Different strength acid or base can be used, if needed.
8. Note that the overall volume change should not be greater than 1% (0.5 mL). Discard and re-prepare with stronger acid or base if the volume changes more than 1%.
9. Record the adjusted pH. Proceed to the filtration step (p. 1).

## Results of SCS Testing on the Orion AQ8000 Spectrophotometer

### 25.0 mg/L organic carbon (KHP)

Bias Method UV254_1	Expected (per SM 5910B)	Result (AQ8000)	Difference	Evaluation
Absorbance	0.358 cm <sup>-1</sup>	0.360 cm <sup>-1</sup>	0.002 cm <sup>-1</sup> (0.6%)	Good
Organic Carbon Concentration	25.0 mg/L	24.9 mg/L	0.01 mg/L (0.4%)	Good

**Bias:** readings of a KHP organic carbon standard at 25.0 mg/L in phosphate buffer (prepared per SM 5910B) tested in a 1 cm cell demonstrate good accuracy:

- The average AQ8000 absorbance result is within 0.002 absorbance units of the average reading expected per SM 5910B; 0.6% difference from the expected absorbance.
- The average AQ8000 organic carbon concentration result (calculated per SM 5910B) is within 0.1 mg/L of the expected value; 0.4% difference (99.6% recovery) from the expected value of 25.0 mg/L organic carbon.

Precision Method UV254_1	# of Samples Tested	Maximum %RSD (per SM 5910B)	Result (AQ8000)	Evaluation
Absorbance	14	< 10.7% RSD	0.3% RSD	Good

**Precision:** readings of a KHP organic carbon standard at 25.0 mg/L in phosphate buffer (prepared per SM 5910B) tested in a 1 cm cell demonstrate good precision:

- The relative standard deviation (RSD) of 14 test results on the AQ8000 is 0.3% RSD, well within the maximum 10.7% limit expected per SM 5910B.

### Notes

1. If the preprogrammed method is not on the memory stick, download the method file from the Online Library at [www.thermoscientific.com/waterlibrary](http://www.thermoscientific.com/waterlibrary), or call Technical Support
2. Alternately, use disposable cuvettes formulated for UV measurements, available in the 1 cm (10 mm) cell path.

# 6

## CHAPTER 6 Standard Curve Test Menu

### Concentration Measurements using the Quant Standard Curve Application (Custom Method)

The Standard Curve test technique is used to perform a quantitative analysis experiment using a multipoint calibration curve via the Quant application. A calibration curve is composed of standards of well-known concentration. A fit of this standard curve is used to measure the concentration of samples.

This test technique is ideal when using colorimetric reagents for which the test kit manufacturer does not specify a factor or equation for obtaining the concentration of the test kit. Always follow the reagent instructions provided by the test kit manufacturer when creating a custom method.

**Note:** If the manufacturer does not specify the wavelength for the test kit, the [Scan](#) application should be used with a prepared standard as a technique to determine the wavelength parameter for the reagent before creating a standard curve.

#### Use Standard Curve Test Technique:

- To create a standard curve by setting parameters and measuring standards for the curve
- To view calibration curve data
- To edit a standard curve, including changing the number of standards, selecting a different curve fit or deleting points from the curve
- To measure samples using the standard curve and to view and save measurement data
- To recall existing standard curve methods

## Accessing Quant

From Screen 1, swipe the to the left to have Screen 2 appear. The Quant application is selected by tapping the respective icon. Quant is a calibration curve development application. The user can select the expiration date, wavelength, reference wavelength, equation, units of concentration, and enter the known standards that will be used to develop the curve. Methods can be saved by name and used to measure subsequent sample concentration

The equation type used to fit the standard measurement data is determined by this equation

Select if 1 or 2 replicates are needed

Save method

Calibrate

Calibrate

Add standards and select curve type

Selects units in which the sample measurements are displayed and printed

Once sufficient unique standard concentration values are provided, the calibrate button is enabled.

The number of unique standard concentration values are determined from the equation of the curve type.

after sample measurement is complete

Equation and r-square calculated

Measure is enabled after all standards are measured

Change curve type to find new fit. R-squared value is re-calculated

New sample

Add standards and select curve type

Standard	Conc. [C]	ABS
Blank		
Green Dye Std# 1	1.000	0.257
Green Dye Std# 2	2.000	0.497
Green Dye Std# 3	4.000	0.880

Sample	ABS(629)	Conc. [C]
Unknown# 1	0.529	2.255
Unknown# 2	0.513	2.177
Unknown# 3	0.400	1.629



# Quant Standard Curve Options

## Setting the Parameters for a Standard Curve

Highlight and change the displayed test parameters, including Test Name, Wavelength, Curve Fit, Number of Standards, and Units. By tapping on the blue highlighted features, values can be changed. For example, by selecting the equation that is listed to the right of the wavelength, a selection of equations appears. Choose the equation that you feel is best suitable. When the multi-point calibration is completed, the resulting equation and the correlation results ( $r^2$ ) will appear. These results are based on the quality of your blank and the accuracy of the standards prepared and entered. Be sure to save your results by tapping the blue diskette icon in the upper right corner.

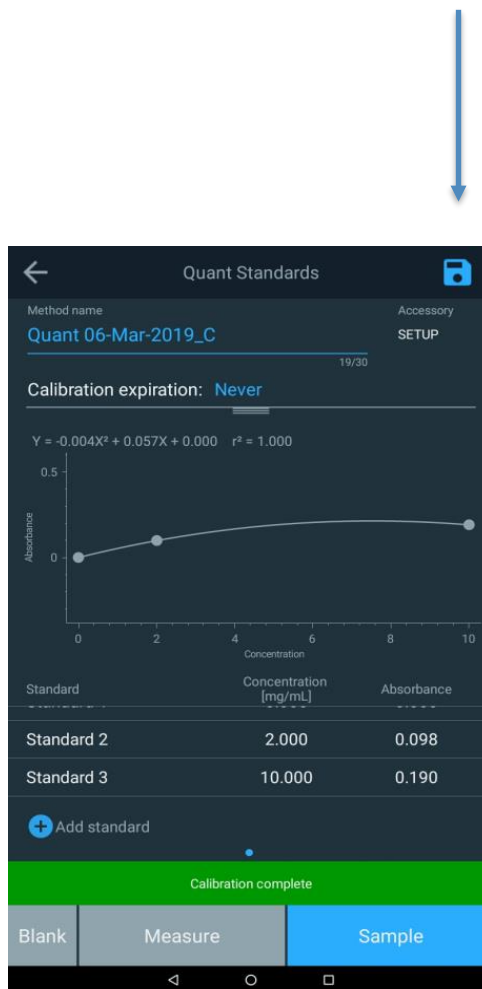
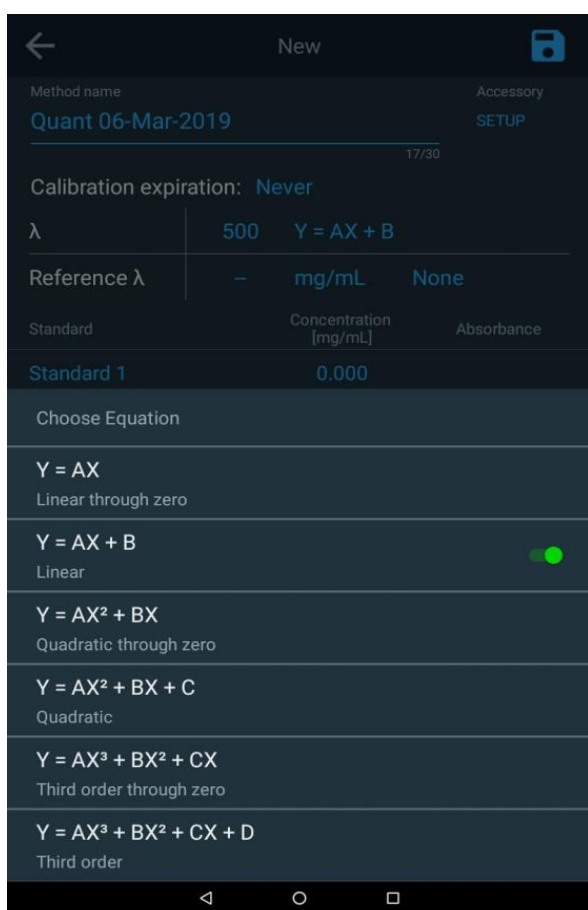

# Creating a Standard Curve in Quant

## Measuring Standards for a Standard Curve

Once the parameters have been set for the standard curve:

1. Prepare the blank and standards that will be used to create the standard curve.
2. Place the blank in sample chamber, close the cover and tap the **Blank** function key. Once the blank has been measured, remove it from the carousel.
3. For each standard, tap the **+** to add a standard value and enter the concentration of the standard.
4. Place the standard in the sample chamber, close the cover, and tap **Measure**.
5. Repeat for each standard.
6. When all the standards have been measured, the absorbance of each standard will be displayed with the slope, intercept, correlation coefficient, and a graph of the standard curve will be displayed.
7. Enter an expiration date into the curve if applicable.
8. To save the test with the standard curve, tap the **Save** icon at the top right of the screen.
9. Any blue fields may be selected and revised as needed.
10. Tap **Sample** function to start measuring subsequent samples.

## Measurement Samples via Quant

When measuring the concentration of any sample via any method or application, the sample name will increment by 1 each time you press Measure, as you can see below.

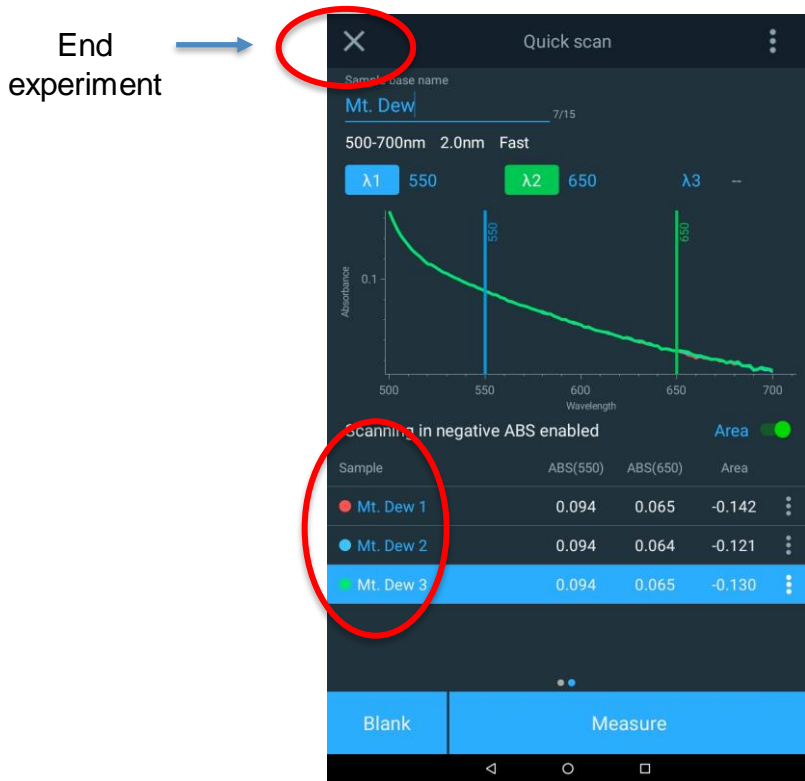

## Ending An Experiment

When your measurements are completed, select the “X” in the upper left hand corner and it will terminate. You will need to confirm that the experiments will end and the file will be saved.

The data may be also be printed as a report (if network printer or tape printer are installed) or the date may be exported to a network folder or to a USB drive.

Go Back to experiment →

Edit experiment name →

Send to printer →  
Export to file →

Confirm experiment is ended →

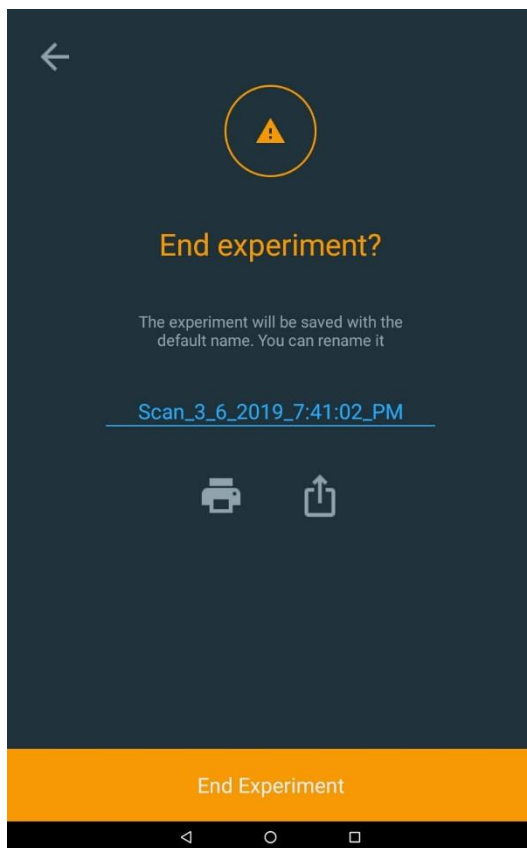

## Exporting Data

If you choose to export your data, be sure to have setup a network path via Ethernet or via WiFi. A typical method is to save the data directly to a USB drive. The report can be saved as both a CSV file and/or a JPEG file. Below is an example of the JPEG file image.

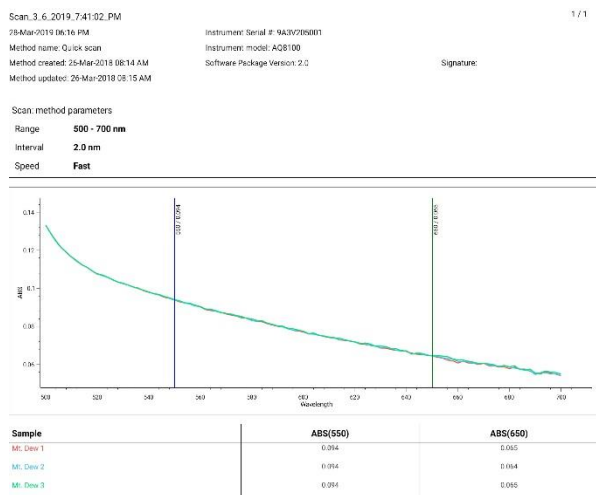
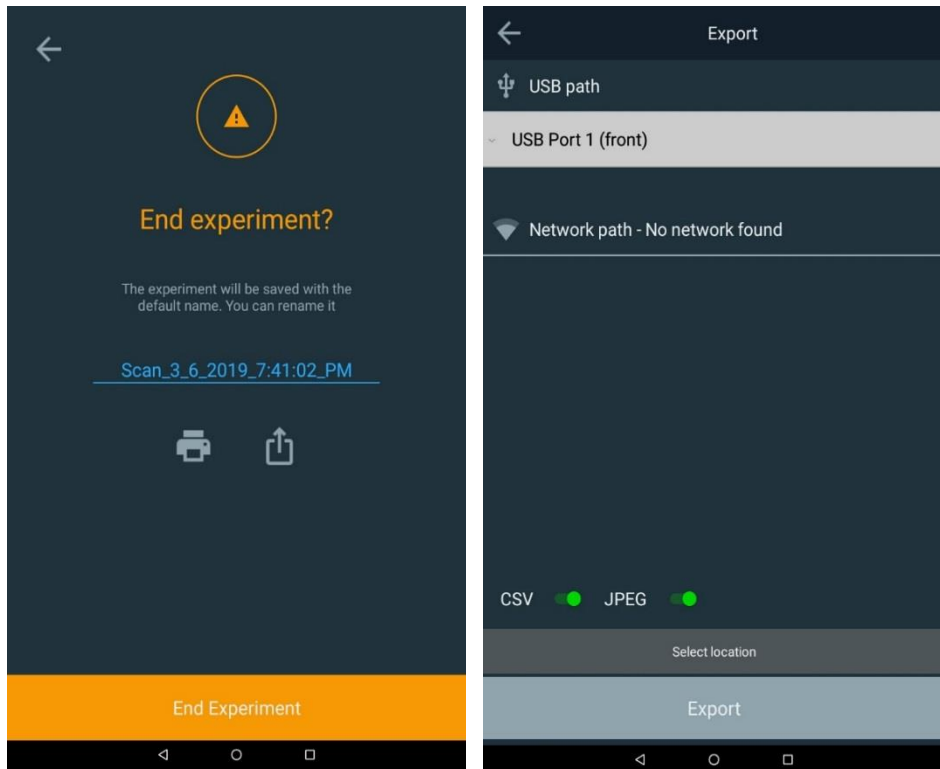

## Editing a Standard Curve

From the Quant home page, select the listed method curve that you would like to review and edit. In the example below, the Chlorine Curve\_C is selected. Once selected, tap the ellipsis to bring up the curve options to Edit, select Smart Method, Duplicate, Export, or Delete.

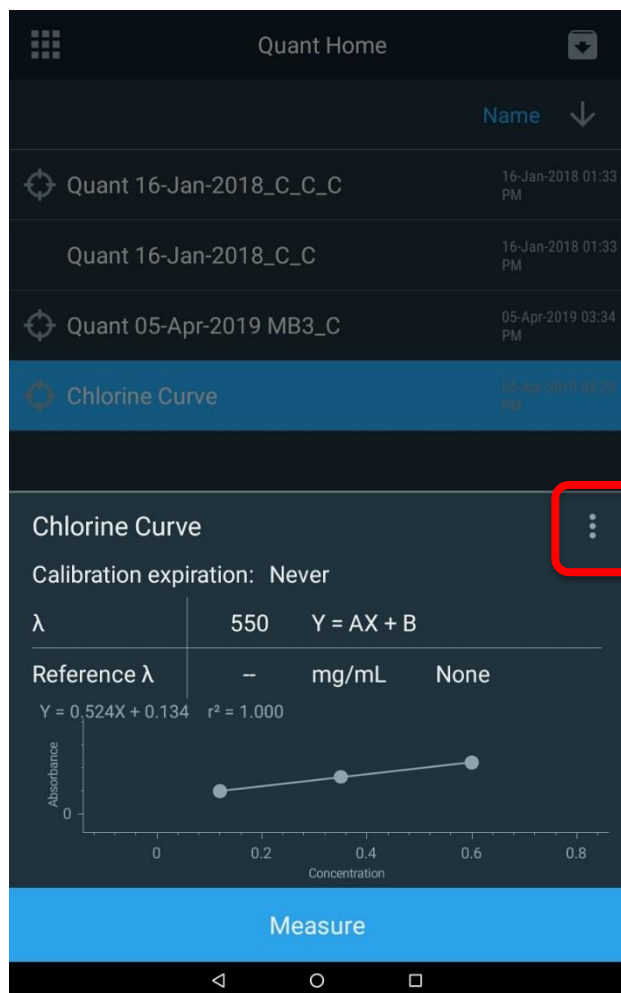
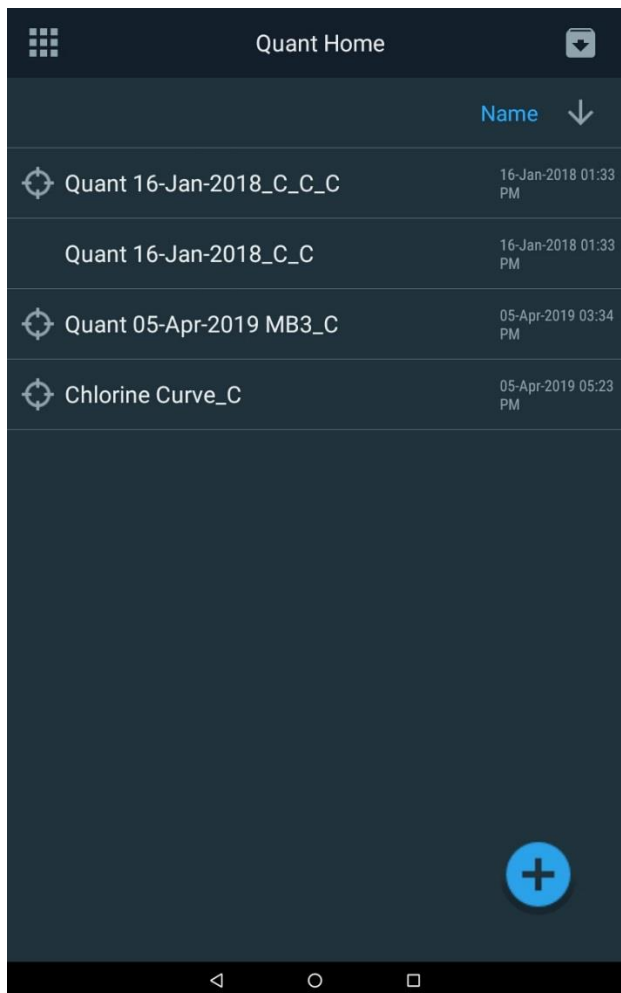

Once the curve options window appears, select the Edit option. In the edit mode, you can rename the method, change the expiration date of the method, or choose a different equation to represent the calibration curve. Tap on the following more common parameters highlighted in blue to revise and update:

- Method name
- Calibration expiration
- Calibration equation

If any changes are made, please be sure to save the changes with the new name. Standard points can be deleted or added, however the curve will have to be re-ran.

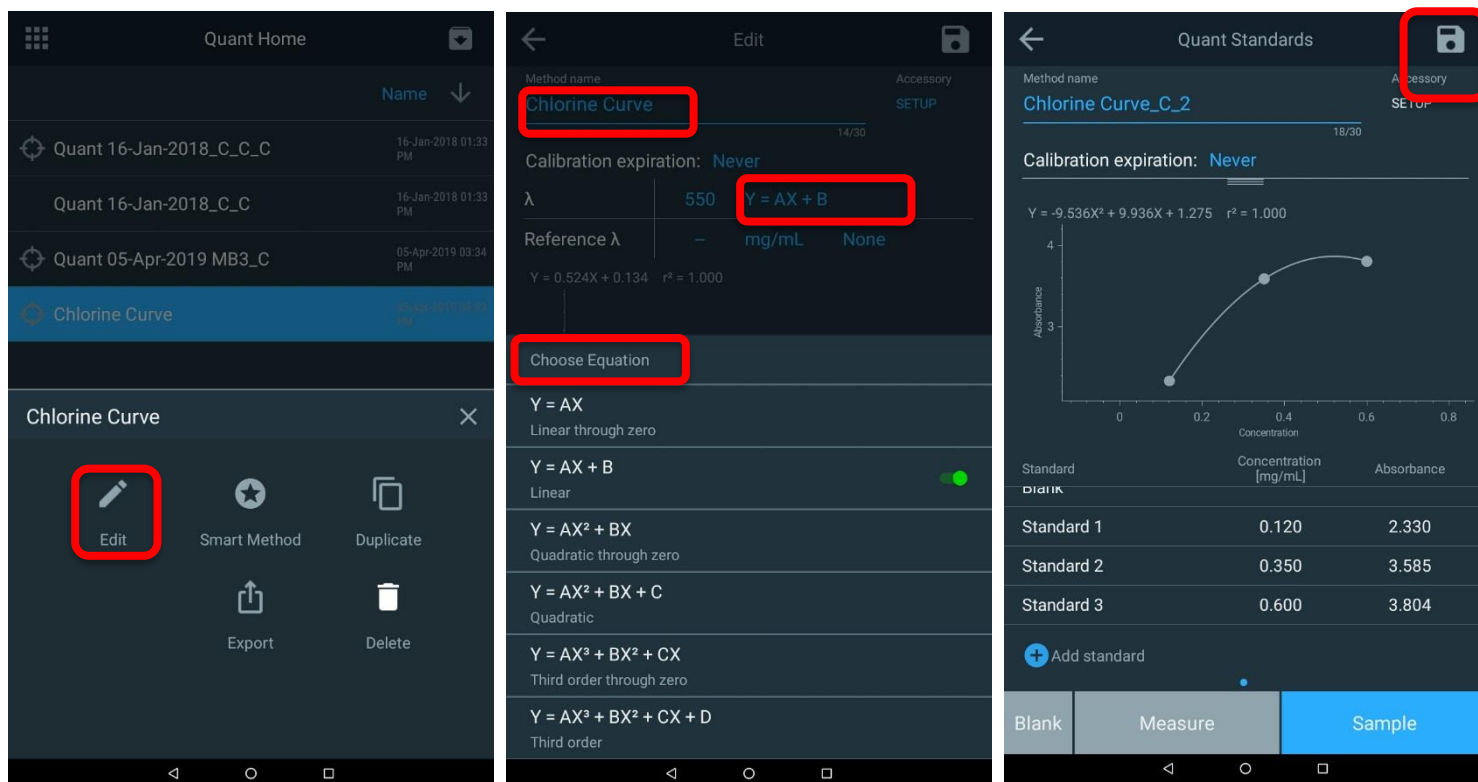

Once the method has been revised, sample measurements can continue.

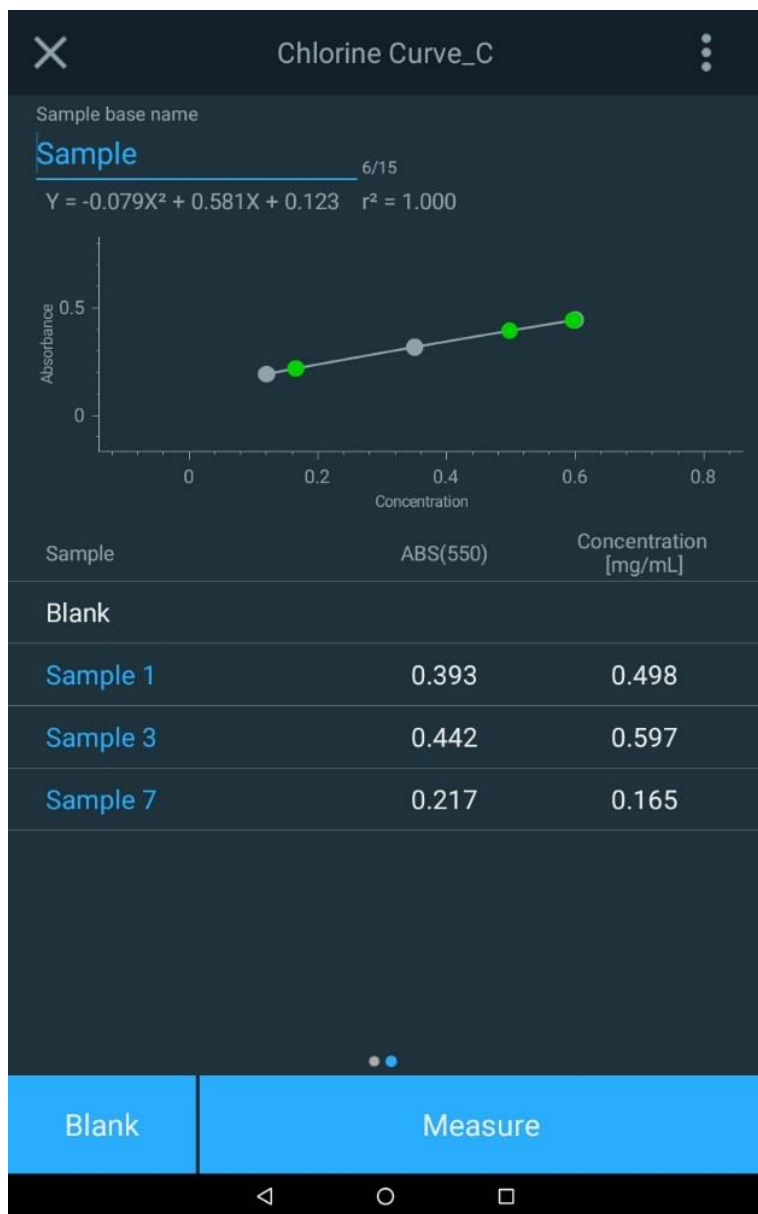



# 7

## CHAPTER 7 Wavelength Scanning Test Menu

The Wavelength Scanning test technique lets you measure the absorption or percent transmission spectrum of a sample. You can use scans to determine peak wavelengths or to evaluate the quality of a material.

This test technique is useful when using colorimetric reagents for which the test kit manufacturer does not specify a wavelength parameter for the test kit. Always follow the reagent instructions provided by the test kit manufacturer when creating a custom method.

**Note:** If the manufacturer does not specify the factor or equation for obtaining the concentration of the test kit, the [Standard Curve](#) test technique should be used with prepared standards to determine the factor or equation for the reagent.

### Use Scanning Test Technique:

- To scan samples by setting parameters, collecting a baseline scan and scanning a sample
- To view and manipulate scanning data, including graphical data, determining peak height using a 3-point net equation, calculating the area under a curve and labeling peaks and valleys
- To recall existing scanning methods

## Setting the Parameters for a Scan

SCAN is a multiwavelength scan, selecting absorption (ABS) or percent transmission (%T), across a selectable wavelength range and selectable speed and interval resolution. The value of SCAN is to evaluate the absorption or transmission characteristics of a sample or a sample with reagent. This is valuable when determining what the best wavelength is to establish a new method.

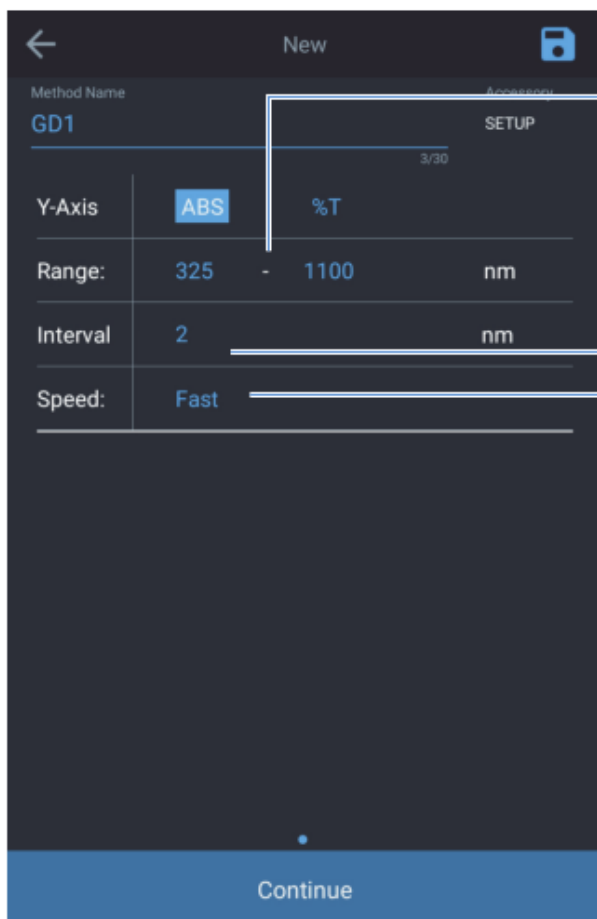

Scan range:

Between 190 nm and 1100 nm for UV-Vis

Between 325 nm and 1100 nm for Vis instruments

Interval:

Specifies how frequently the instrument will acquire a measurement.

In this illustration, data will be captured every 2 nm.

Fast, Medium, Slow scan speeds limit the number of data interval options offered

Speed	Interval Options
Fast	5 nm, 2 nm
Medium	5 nm, 2 nm, 1 nm
Slow	5 nm, 2 nm, 1 nm, 0.5 nm, 0.2 nm,

Tap and revise the highlighted fields:

- Revise the method name for this scan,
- Select between ABS or %T for the y-axis
- Adjust the wavelength range that will be used to scan and appear on the x-axis
- Specify the Interval and the Speed of the scan; noting that slower scans will have a higher resolution of scanning intervals available.
- Tap the highlighted **Save** icon to save the Scan Method.

## Collecting a Baseline Scan and Scanning a Sample

**Note:** Please be sure to use the same sample vial holder and vial size.

Once the parameters have been set for the scan you can continue.

1. Press Continue to run a scan test
2. Install a blank sample and **Blank** the system.
3. Install the sample of interest and tap **Measure**. This can be repeated for multiple samples.
4. Once the Scan is completed, up to three (3) reference wavelengths can be selected to display results specifically at those wavelengths. In the example below, 622, 663, and 700 nm have been selected.
5. Either tap the wavelength number to enter a new specific reference wavelength or drag the vertical wavelength line to a new reference value.
6. If additional features for a sample scan are of interest, tap the ellipsis to the right of the sample to open other options

Once the scan is completed, follow the save and export steps. The graphical data can be manipulated through a two-finger stretch or compress touchscreen method.

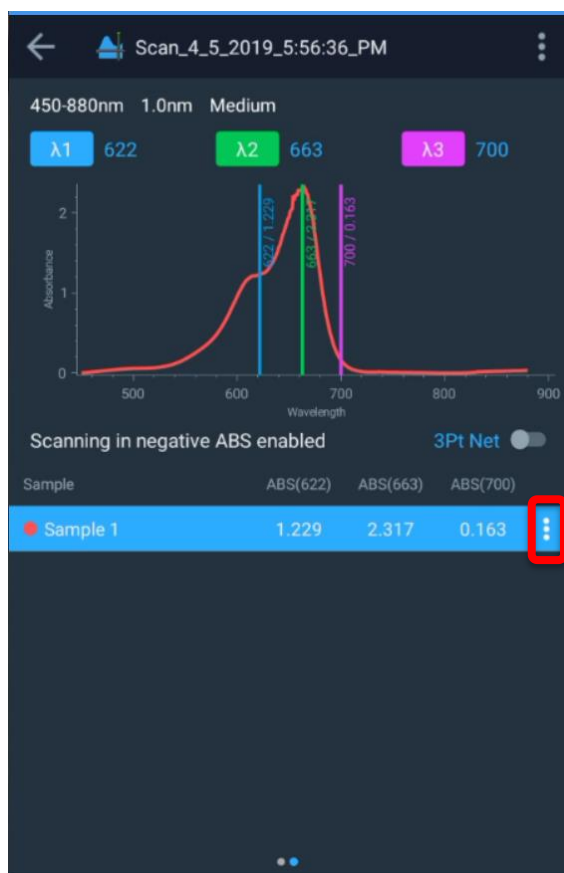

## Performing Calculations on the Scan Data

After a scan is completed, tap on the ellipsis to open options to either:

- Delete the scanned sample
- Pick a peak
- Export the data

In the screen image below, the Peak Pick has been selected and automatically two values, 654.233 and 663.910 nm have been provided.

By using the stretch and zoom feature of the touchscreen, a closer look at the peak can be reviewed and upon final selection, it would appear that Peak 2 at 663.910 (~664 nm) would be selected. Please note that smoothing can either be toggled On/Off.

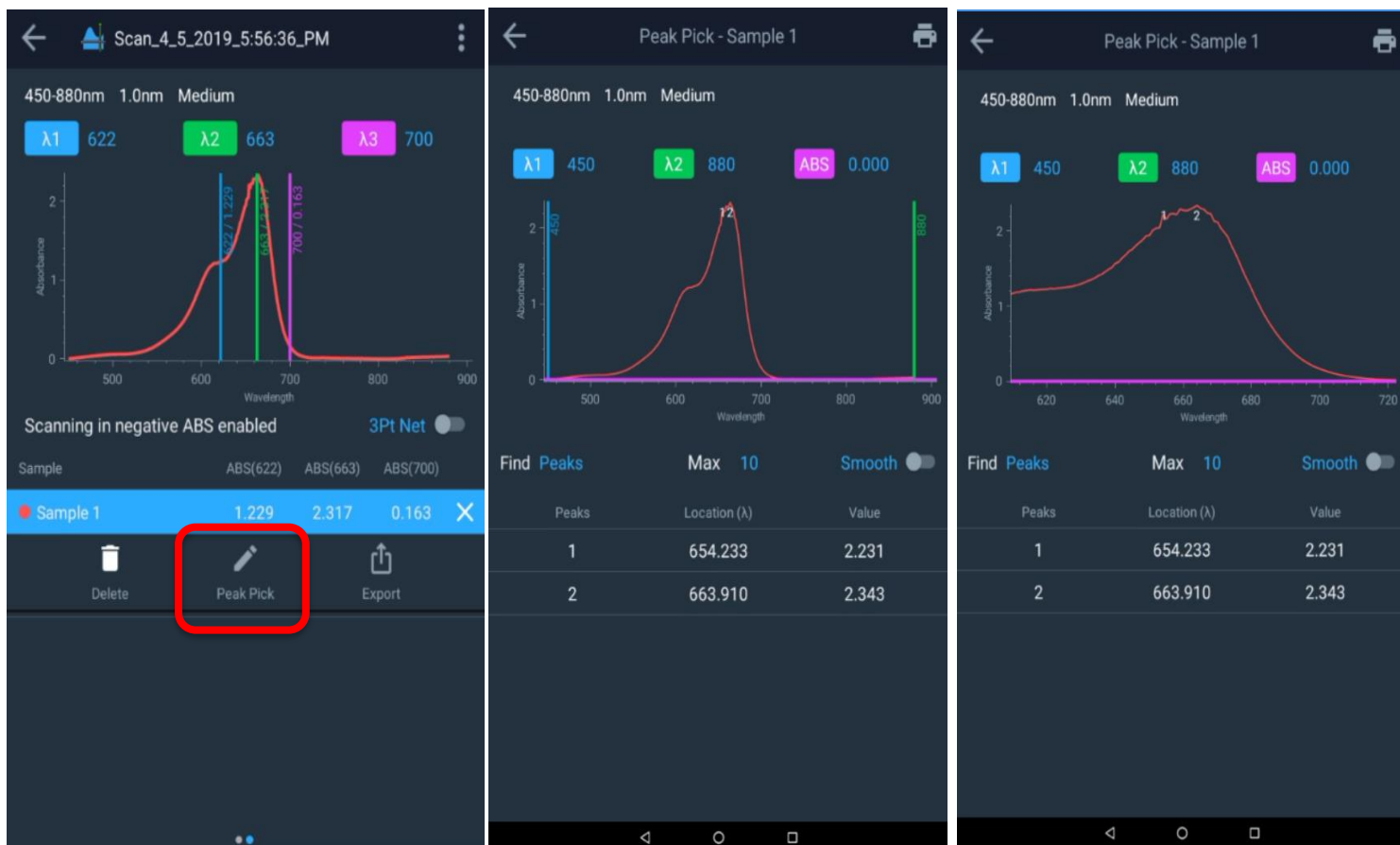

Other features that are available are:

- Selecting peaks using
  - Peaks only
  - Valleys only
  - Peaks and Valleys
- Selecting the maximum number of peaks (1-20 are the allowable)
- Choosing a smoothing feature which will reduce the number of peaks.



Choosing

### 3Pt Net Function

By toggling the **3Pt Net** function key, the peak height using a 3-point net equation will be engaged and the 3Pt Net value will now appear next to the 3 wavelengths. The instrument will calculate the value for the 3-point net absorbance for the selected wavelengths multiplied by a factor of 1.000.

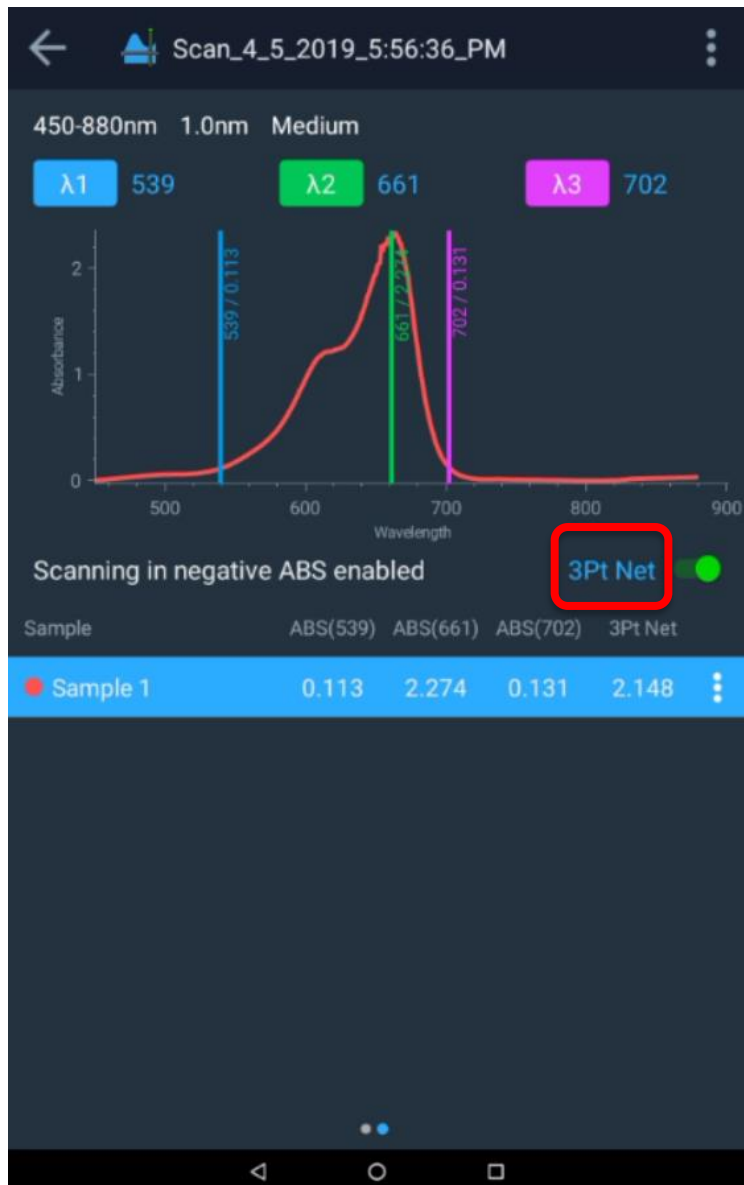

## Area Function

To have the area under the curve calculated, only two wavelengths are to be referenced. By toggling the 3Pt Net off, automatically the wavelengths 1 and 2 are selected and the area under the curve can be calculated by toggling that feature on.





## Recalling an Existing Scanning Method

To recall an existing Scan method, proceed to Screen 1, tap the Scan icon and a list of scanning methods created will appear. Select from the list, tap and run your scan.

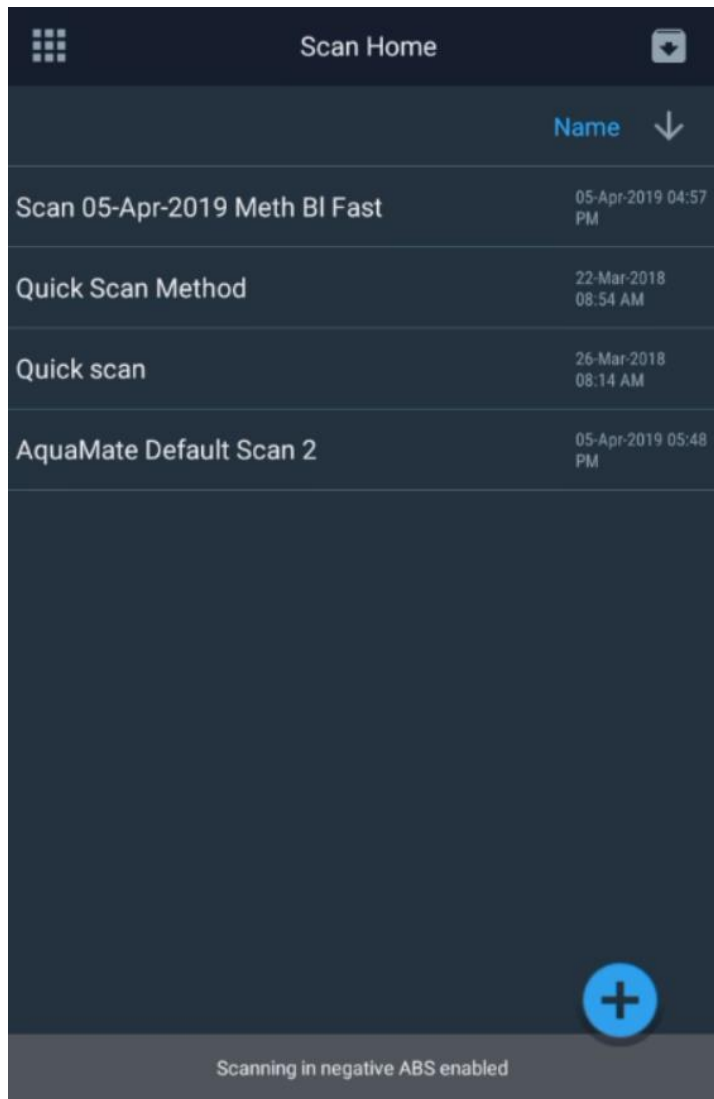

# 8

## CHAPTER 8 **AquaMate On-board Software**

### **Performance Verification Tests and Reports**

AquaMate instruments are preconfigured with default Performance Verification Tests. These tests cannot be deleted or edited.

### **Running Performance Verification Tests**

Running a performance verification test is similar to running any other experiment method. Follow the on-screen instructions.

### **Customized Performance Verification Tests**

Some Performance Verification Tests can be customized to meet specific verification requirements of users. To customize a test, it must first be duplicated.

Often, standard operating procedures require performance verification of instruments periodically. Test such as Stray Light, Wavelength Accuracy and Photometric Accuracy require specific sets of filters and standards. The default performance verification tests are designed to work with specific standards and filters. See Table 1. However, these tests can be duplicated and customized to work with standards of choice.

**Table 1.** Description of each test and if it may be duplicated

Performance Verification Test	Description	Can Duplicate?
Wavelength Accuracy Xenon	<p>This test verifies the wavelength axis performance of the spectrophotometer.</p> <p>Scans and locates known xenon emission peaks and verifies that they are found accurately to within the specification for the instrument.</p>	No
Drift at 500 nm	<p>Measures absorbance at 500 nm at 1 minute intervals for an hour. Measured at 0A (open beam). Blanks and reports maximum deviation from zero. Compares result to specification for the instrument.</p> <p>Result should be less than the specification.</p>	No
Noise 0A at 500nm	<p>Records 60 ABS measurements at 1 second intervals. Returns RMS (rootmean square) of data set as noise value and compares specification for the instrument.</p> <p>Insert 1A or 2A nominal absorbance neutral density glass filter for those measurements.</p> <p>Result should be less than the specification.</p> <p>Note: Noise in the AquaMate instruments is so low that the result is reported with more than the usual 3 decimal digits.</p>	No
Noise 1.0A at 500 nm		
Noise 2.0A at 500 nm		

Performance Verification Test	Description	Can Duplicate?
Baseline Flatness 1000 to 200 nm	<p>Measures any systematic deviation from perfect zero when scanning across the common wavelength range. Data is smoothed to remove the impact of noise (noise can be measured separately). Result is the maximum deviation from zero and is compared to the specification for the instrument.</p> <p>Result should be less than the specification.</p>	No
Stray Light SRE 220 filter (UV-Vis models)	Measures stray light at the specified wavelength.	Yes
Stray Light SRE 400 Filter (Vis models)	<p>The filter is a long pass filter that cuts on slightly above the test wavelength. At the test wavelength it should be entirely dark – i.e. 0%T. Longer wavelengths pass through the filter, therefore any transmittance measured at 220 nm is actually photons of longer wavelength that are “stray light”. Sources of stray light include second order effects imperfections in the grating, and imperfections or dirt on mirrors.</p> <p>The measured transmittance is compared to the specification for the instrument.</p> <p>Test measures transmittance at the specified wavelength.</p> <p>Result should be less than the specification.</p>	
Wavelength Accuracy	<p>This test verifies the wavelength axis performance of the spectrophotometer.</p> <p>Use this test with a calibrated wavelength filter such as a holmium or didymium glass filter.</p> <p>User enters the peak wavelengths and calibration uncertainty from the calibration certificate.</p> <p>The instrument scans across the relevant wavelength range and locates the center of the peak.</p> <p>Reported wavelength should agree with certificate wavelength to within the sum of the instrument specification and the calibration uncertainty.</p>	Yes

Performance Verification Test	Description	Can Duplicate?
Photometric Accuracy	<p>This test verifies the photometric (absorbance) performance of the spectrophotometer.</p> <p>Use this test with one or more calibrated absorbance filter(s) such as those found in the SPECTRONIC Standards 2 Kit to test accuracy in the visible region. Use calibrated potassium dichromate solution cells, metal on quartz filters, or other recognized calibrated standard materials for the UV region.<sup>a</sup> Multiple filters calibrated at the same wavelengths but different absorbance values can be configured in a single test.</p> <p>User enters</p> <ul style="list-style-type: none"> <li>• calibration wavelengths</li> <li>• certificate absorbance values</li> <li>• calibration uncertainty value</li> </ul> <p>from the calibration certificate. User also enters the performance specification for the absorbance value being tested from the specification sheet for the instrument.<sup>b</sup></p> <p>The instrument measures and reports the absorbance at each specified wavelength. A 1s integration time is used.</p> <p>Reported absorbance should agree with certificate absorbance to within the sum of the instrument specification for that absorbance level and the calibration uncertainty.</p>	Yes

<sup>a</sup> We recommend against use of didymium glass “dual standard” filters calibrated for both wavelength peaks and photometric accuracy. Customers have reported difficulty in reproducing calibration values for this type of standard although their instruments do reproduce the calibration values for other, more widely accepted and recognized standards. Customers who call for support because an instrument fails a photometric accuracy test with a didymium photometric standard may be required to verify photometric accuracy with a different standard before return shipment for warranty service is authorized.

<sup>b</sup> Future releases of software may include a look-up table that populates the instrument specification based on the user-entered certificate absorbance value.

## Customizing Stray Light Test

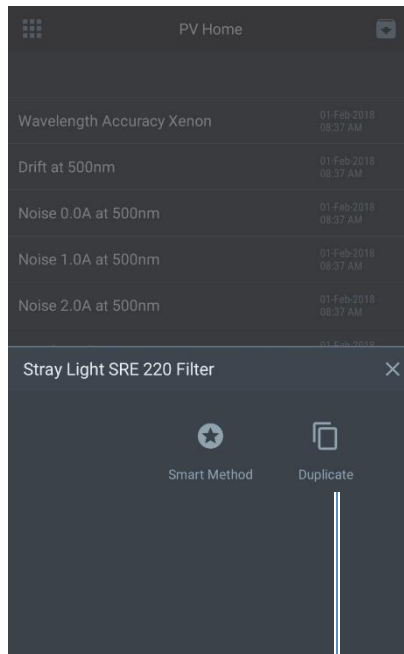
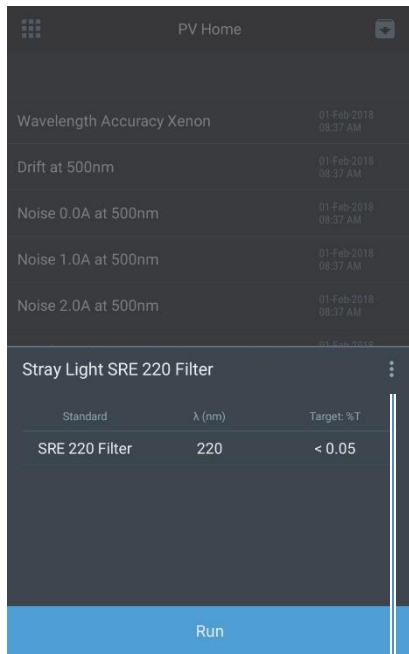

# Customizing Wavelength Accuracy Test

Toggle to perform wavelength repeatability test

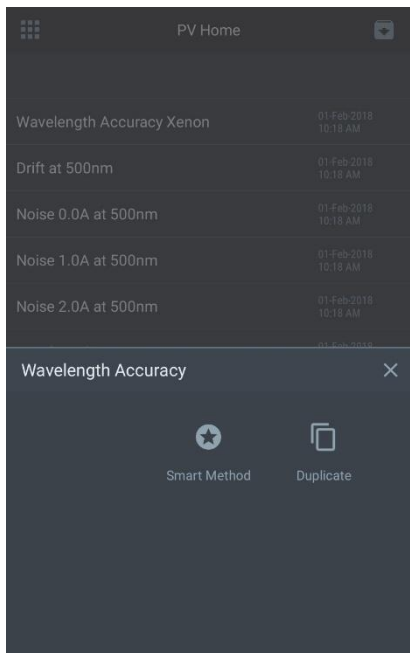

Toggle to measure in transmittance mode



# Customizing Photometric Accuracy Test

A typical standards kit for photometric accuracy comes with a Certificate of Calibration. This section illustrates how to configure a photometric accuracy test for custom standard kits.

## ThermoFisher SCIENTIFIC

5225 Verona Road, Bldg.1  
Madison, WI 53711 USA

www.thermo.com

### Certificate of Calibration SPECTRONIC Standards 2 Kit 840-253100

**Submitted to:**  
THERMO FISHER SCIENTIFIC  
5225 VERONA ROAD  
MADISON, WI 53711  
USA

**Serial Number:** SA1234  
**Certificate Number:** CC001234  
**Date of Calibration:** 20 Apr 2015  
**Performed by:** John Doe  
**Test Method:** 397-018500 Rev A  
**Bench Used:** MSN000 123456  
**Sample Temperature:** 23 ± 1 °C

Certified Percent Transmittance Values and Uncertainties

Standard ID	SA0706 -1	SA0706 -2	SA0706 -3	SA0706 -4
<b>Nominal %T</b>	<b>50 %T</b>	<b>30 %T</b>	<b>10 %T</b>	<b>3 %T</b>
<b>Uncertainty</b>	<b>± 0.30 %T</b>	<b>± 0.18 %T</b>	<b>± .071 %T</b>	<b>± 0.048 %T</b>
440.0 nm	44.51 %T	26.73 %T	7.78 %T	2.14 %T
465.0 nm	50.83 %T	33.09 %T	9.71 %T	2.99 %T
546.1 nm	51.57 %T	34.06 %T	9.43 %T	2.87 %T
590.0 nm	49.57 %T	31.26 %T	8.44 %T	2.42 %T
635.0 nm	49.78 %T	30.83 %T	10.02 %T	3.14 %T

Certified Absorbance Values and Uncertainties

Standard ID	SA0706 -1	SA0706 -2	SA0706 -3	SA0706 -4
<b>Nominal Abs</b>	<b>0.3 A</b>	<b>0.5 A</b>	<b>1.0 A</b>	<b>1.5 A</b>
<b>Uncertainty</b>	<b>± 0.0026 A</b>	<b>± 0.0026 A</b>	<b>± 0.0031 A</b>	<b>± 0.0070 A</b>
440.0 nm	0.3516 A	0.5730 A	1.1089 A	1.6704 A
465.0 nm	0.2939 A	0.4803 A	1.0127 A	1.5237 A
546.1 nm	0.2876 A	0.4677 A	1.0254 A	1.5419 A
590.0 nm	0.3048 A	0.5051 A	1.0736 A	1.6165 A
635.0 nm	0.3029 A	0.5110 A	0.9992 A	1.5030 A



**Certificate of Calibration**  
SPECTRONIC Standards 2 Kit 840-253100

Submitted to:  
THERMO FISHER SCIENTIFIC  
5225 VERONA ROAD  
MADISON, WI 53711  
USA

Serial Number: SA1234  
Certificate Number: CC001234  
Date of Calibration: 20 Apr 2015  
Performed by: John Doe  
Test Method: 397-018500 Rev A  
Sample Temperature: 20.0 °C

Certified Percent Transmittance Values and Uncertainties

Standard ID	SA0706 -1	SA0706 -2	SA0706 -3	SA0706 -4
Nominal %T	50 %T	30 %T	10 %T	3 %T
Uncertainty	± 0.30 %T	± 0.18 %T	± 0.71 %T	± 0.048 %T
440.0 nm	44.51 %T	26.73 %T	7.78 %T	2.14 %T
465.0 nm	50.83 %T	33.09 %T	9.71 %T	2.99 %T
546.1 nm	51.57 %T	34.06 %T	9.43 %T	2.87 %T
590.0 nm	49.67 %T	31.26 %T	8.44 %T	2.42 %T
635.0 nm	49.78 %T	30.83 %T	10.02 %T	3.14 %T

Certified Absorbance Values and Uncertainties

Standard ID	SA0706 -1	SA0706 -2	SA0706 -3	SA0706 -4
Nominal Abs	0.3 A	0.5 A	1.0 A	1.5 A
Uncertainty	± 0.0026 A	± 0.0026 A	± 0.0031 A	± 0.0070 A
440.0 nm	0.3516 A	0.5730 A	1.1089 A	1.6704 A
465.0 nm	0.2939 A	0.4803 A	1.0127 A	1.5237 A
546.1 nm	0.2876 A	0.4677 A	1.0254 A	1.5419 A
590.0 nm	0.3048 A	0.5051 A	1.0736 A	1.6165 A
635.0 nm	0.3029 A	0.5110 A	0.9992 A	1.5030 A

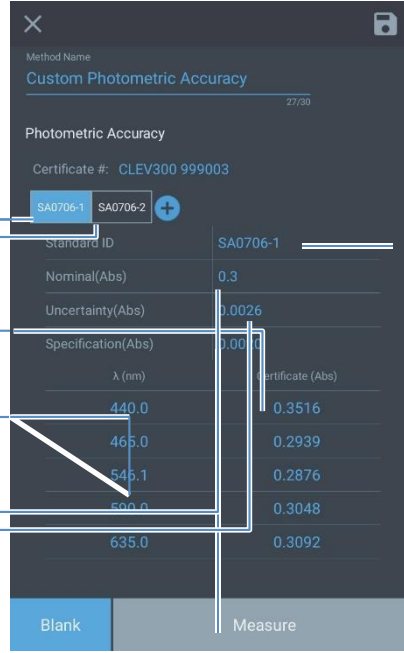

Standard ID may be used to identify the corresponding filter in a filter set

Standard ID may be used to identify the corresponding filter in a filter set

## Performance Verification Schedule

Standard operating procedures (SOPs) often require that performance of analytical instruments be verified at regular intervals of time. The Performance Verification Schedule setting allows configuration of such an interval. This option can be accessed under the settings menu

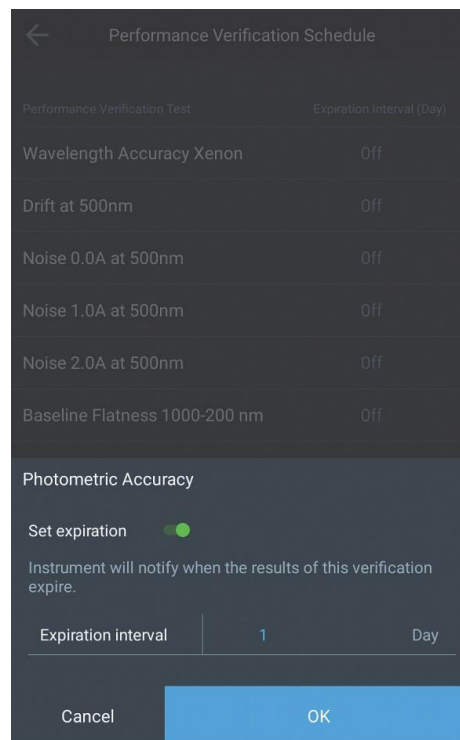
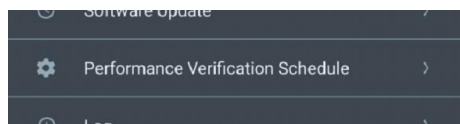

Expiration interval can be set in number of days. When set, the instrument will display a notification indicating the results of the corresponding verification test have expired. The time interval is relative to the currently configured instrument date. The instrument checks for the expiration date once each day – either at 12:00 AM or at the time the instrument is first powered up on a certain day. Changing the system time after a verification schedule is configured, may cause the instrument to display the expiration notification. It is therefore suggested that the all expiration dates be verified when the system time is changed.

# 9

## CHAPTER 9 **Absorbance, % Transmittance and Concentration Measurements**

### Absorbance & % Transmittance Measurements

#### Using the Fixed Application for Basic A-%T-C Test Method

The Fixed Application from Screen 2 puts the instrument into an “instant measurement” mode. The user simply walks up to the instrument, inserts a sample and measures it. Depending on whether the mode is set to Absorbance (A), % Transmittance (%T), or Concentration, the measurement results appear, along with the type of measurement, date and time, wavelength and vial position.

Select a new Fixed scan window and through touchscreen tapping and window editing:

1. Edit the method name
2. Select ABS or %T
3. Select the equation
4. Select the Units
5. Select the wavelength(s)
6. Enter the known Factor(s)

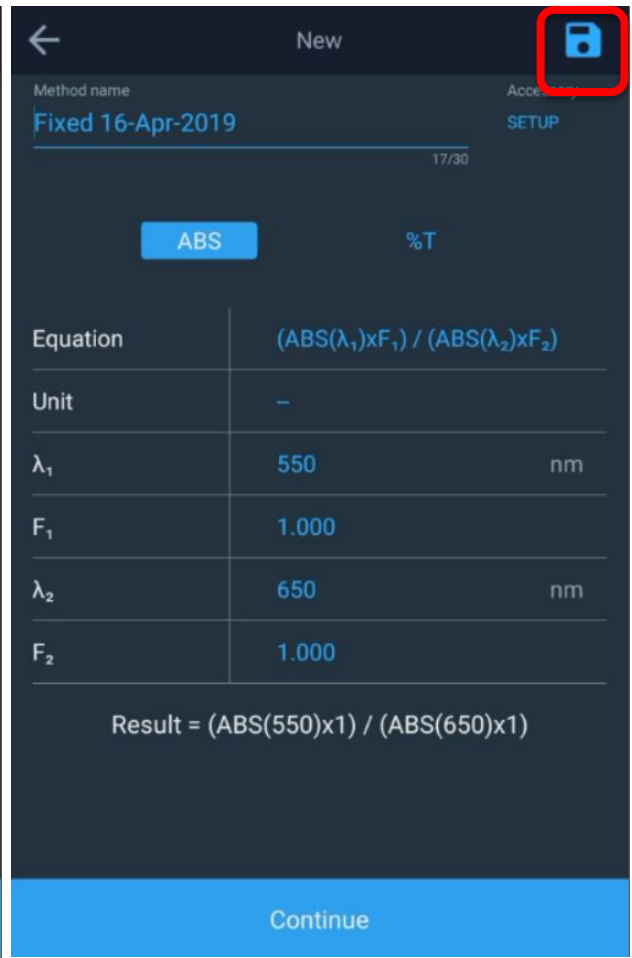
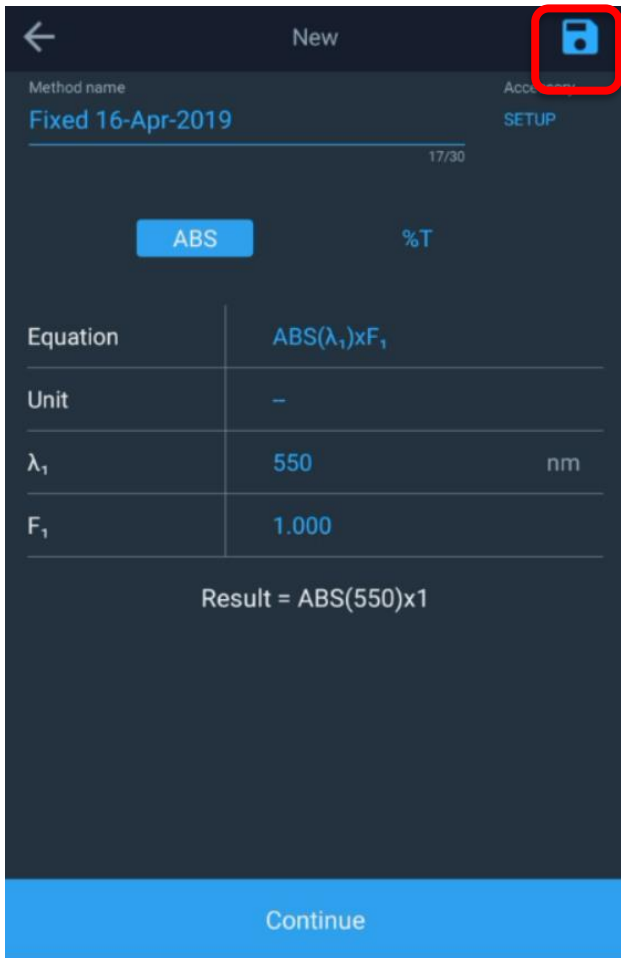

Depending upon the complexity of the equation, either one or two wavelengths and Factors will appear.

Once the method is set, follow the blanking and measuring steps. The instrument will automatically blank and measure at both respective wavelengths and calculate the results.

## Available Fixed Equations

When tapping the equation listed, a pop-up window will appear that permits the user to select the equation of interest. Based on the equation, the available parameters to edit will change.

The following equations, using ABS only, are shown. Substitute %T as needed:

- Direct Factor  $ABS(\lambda_1) \times F_1$
- Additive Absorbance  $[ABS(\lambda_1) \times F_1] + [ABS(\lambda_2) \times F_2]$
- Differential Absorbance  $[ABS(\lambda_1) \times F_1] - [ABS(\lambda_2) \times F_2]$
- Ratiometric Absorbance  $[ABS(\lambda_1) \times F_1] / [ABS(\lambda_2) \times F_2]$

In the example below, the Ratiometric Absorbance equation was selected and the results are calculated after blank and measure.

The left screenshot shows the 'New' method setup screen for 'Fixed 16-Apr-2019'. The 'Equation' field is set to  $(ABS(\lambda_1) \times F_1) / (ABS(\lambda_2) \times F_2)$ . The 'Unit' is '-',  $\lambda_1$  is 550 nm, and  $F_1$  is 1.000. A list of equations is shown at the bottom, with the selected equation highlighted.

The right screenshot shows the 'Fixed 16-Apr-2019' results screen. The 'Result' is 0.129. The 'Sample' table shows 'Sample 1' with values 0.267 for ABS(550) and 2.078 for ABS(650). The 'Blank' row is empty. The 'Measure' button is highlighted.

**Note:** The variety of equations (additive, difference, and ratio) measures the absorption at two different wavelengths. Reference wavelength correction is available to eliminate the effects of a sample matrix. Typically used in quality control applications, these methods provide a convenient and quick diagnostic test for sample quality.

## Using the C-Mode to Measure Concentration

The C-Mode Application from Screen 2 puts the instrument into a mode that requires a standard sample of well-known concentration to be used to determine the concentration of subsequent samples. When the standard concentration is precisely known, the ABS of the standard and the ABS of the unknown sample are measured and the sample concentration is calculated. The measurement can be expressed mathematically as:

$$\frac{\text{Standard Concentration}}{\text{ABS of Standard}} = \frac{\text{Sample Concentration}}{\text{ABS of Unknown Sample}}$$

By tapping the C-Mode, the screen below will appear. By tapping on the editable fields, the user can change the wavelength, standard concentration value, and units.

After running the standard, a Standard Absorbance of 2.361 is measured and a factor of 0.424 is calculated. Any subsequent samples can be entered periodically to get a direct read. In the example below, 1.545 mg/L is measured.

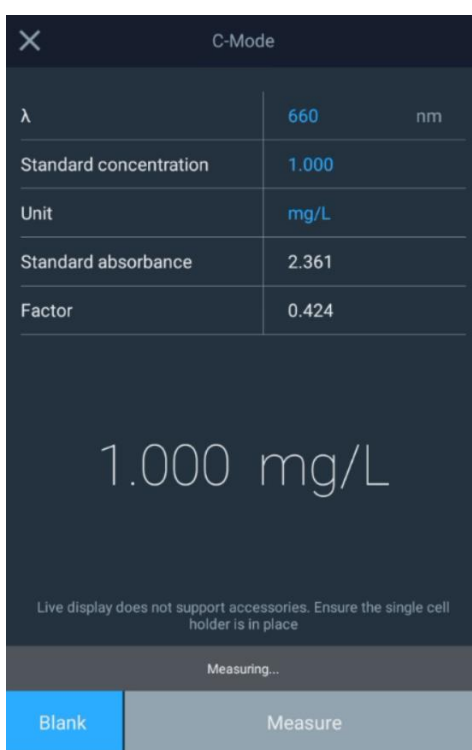

# Multi-wavelength

The Multi-Wavelength Application is selected from Screen 3. This places the instrument into a mode that requires a blank and subsequent samples for measurement. The Multiwavelength application obtains multiple fixed-wavelength measurements. It is a fast alternative to scanning if the wavelengths of interest are well known. By tapping the icon, the screen(s) below will appear. Tap the + symbol to add a measurement

Up to twenty (20) discrete wavelengths can be entered into the wavelength table for a measurement in either ABS or %T mode. In the example below, only five (5) have been selected for ABS measurement. Tap the Save icon to save the scanning method. Tap continue to blank and measure.

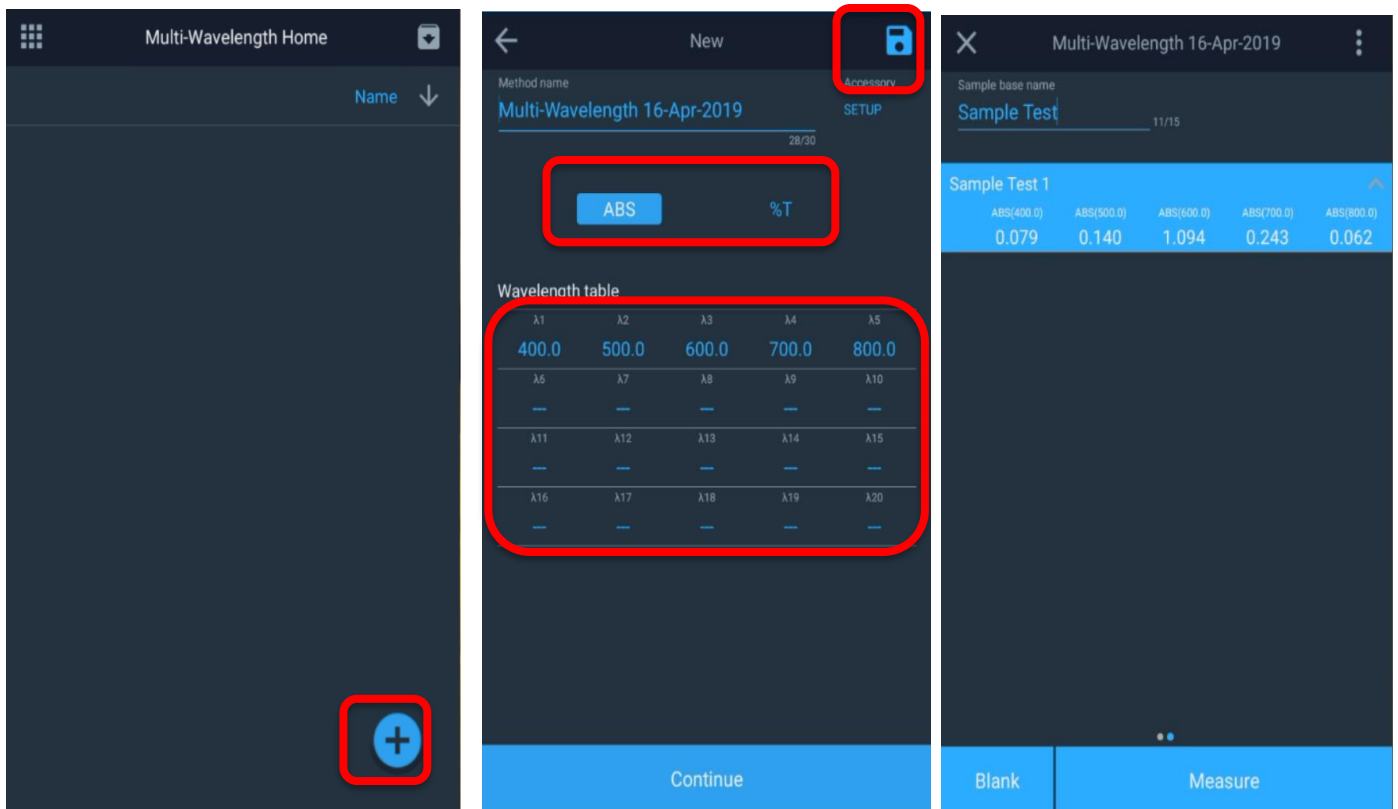

## Recalling an Existing Multiwavelength Method

Multi-wavelength methods can be recalled when going to the Multi-wavelength application page and selecting a saved method. If the method was not saved, it will not appear here.

## 3-Point Net

The 3-Point Net application determines the height of a peak based on a sloping baseline drawn between two wavelengths on either side of the peak. This type of analysis is beneficial when the precise peak height is needed for an assay. A factor can be multiplied by the measured peak height to give the concentration of the measured analyte in the appropriate concentration units. This section covers:

- Setting Up Test Parameters
- Taking Measurements
- Recalling a Test

### **Setting the Parameters for 3-Point Net Method**

### **Taking Measurements with 3-Point Net Method**

### **Recalling an Existing 3-Point Net Method**



# Kinetics

Kinetics is an active scan at a selected fixed wavelength and optional reference wavelength, over a fixed period of time with data being streamed at a selected intervals and integration period. When the experiment time is reached the experiment has ended. Methods can be saved by name and used to repeat a kinetics scan. This application is meant to see the reaction or decay of a sample over time.

The figure consists of three screenshots of the Kinetics application interface, illustrating the workflow from method setup to data collection.

**Screenshot 1: Method Setup**  
The 'Edit' screen for the 'Green Dye Kinetics' method. The 'Method Name' is 'Green Dye Kinetics'. The 'Accessory' is 'SETUP'. The 'Experiment Time' is set to 5.000 min. The 'Data Interval' is 200.000 min. The 'Integration time' is 0.500 sec. A 'Continue' button is at the bottom. A hand icon points to the 'Continue' button with the text: 'Create new method with settings as shown'.

**Screenshot 2: Measurement Start**  
The 'Green Dye Kinetics' screen showing the start of the experiment. The 'Experiment Time ( 5.00 min )' is displayed as '00:00:00 min'. A graph shows 'Absorbance' vs 'Minutes'. The 'Blank' and 'Measure' buttons are at the bottom. A hand icon points to the 'Measure' button with the number '2'.

**Screenshot 3: Data Collection**  
The 'Green Dye Kinetics' screen showing the progress of the experiment. The 'Experiment Time ( 5.00 min )' is displayed as '00:01:46 min'. The graph shows 'Absorbance' vs 'Minutes' with data points. The 'Stop' button is at the bottom. A hand icon points to the 'Stop' button with the text: 'Notice measurements are measured every "interval" time'.

#	Time(min)	ABS	Δ ABS
6	1.00	0.927	-0.010
7	1.20	0.917	-0.010
8	1.40	0.908	-0.010
9	1.60	0.898	-0.009

The Kinetics application measures the change in the sample absorbance as a function of time. The local control software allows the determination of a linear rate over a region, which can be defined after the data acquisition. Frequently used in enzymatic kinetics, a factor can be multiplied by the slope of the linear rate fit to determine activity. Recalling and Recalculating Graphical Kinetics Results

- Rescaling and Recalculating Tabular Kinetics Results
- Modifying the scale of the plot

You can work with graphical or tabular data and perform the same functions with either. However, the location of the function keys depends on the display type.

**Note:** The Kinetics application can measure only one sample at a time.

# 10

## CHAPTER 10 Maintenance

The spectrophotometer is durable and reliable, so routine maintenance is minimal. This section explains:

- Routine Care
- Changing the Fuse
- Replacing the Tungsten Lamp (Orion AquaMate 7100 Vis instruments only)



**Warning:** Operating the instrument with the cover off exposes the operator to potentially dangerous voltages and ultraviolet (UV) radiation. Therefore, we recommend that only authorized service representatives perform procedures requiring removal of the instrument cover and replacement of electrical components. To protect both yourself and the instrument, be sure to contact an authorized service representative to perform any service procedure you do not feel comfortable performing.

# Routine Care

Routine care for the spectrophotometer does not require a lot of time. To help minimize maintenance time and increase the life and performance of the instrument, please follow these guidelines:

- Always replace the dust cover when the instrument is not turned on to prevent dust from accumulating in and on the instrument.
- Do not use or store the instrument in a corrosive environment.
- Gently wipe the outside of the instrument, including the touchscreen, with a soft cloth to remove any dust or spills. Water, isopropyl alcohol and other common laboratory cleaning agents may be used if necessary.
- Always clean up spills as soon as they occur to prevent or minimize damage to the instrument. If concentrated acids or bases, or any hydrocarbon materials, are spilled on the instrument, clean up the affected area immediately.

## Cleaning and Maintaining Vials and Cuvettes

Carefully check the condition of the vials, cuvettes and other cells used to measure samples. If they are chipped, cracked or scratched, it is important to discard the damaged vials and replace them with new ones.

Ensuring your vials are clean both inside and out is important to the quality of your results for two reasons: 1) contaminating material may absorb light resulting in falsely high absorbance readings; and 2) contaminants in the vial may react chemically with subsequent reagents or standards introduced into the vial.

Cleaning methods depend to some extent on the nature of the contaminating material. It is important to identify the residual material in the vial that needs to be removed. Refer to the following table for suggestions on cleaning methods, solvents and material.

Solvent	Examples	Suggested Cleaning Methods
Aqueous	Protein, Biologics, DNA	Warm water with detergent Dilute nitric acid (<10%) rinse Copious water rinse
Aqueous	Salt solutions	Dilute nitric acid (<10%) rinse Copious water rinse
Aqueous	Basic solutions	Warm water with detergent Dilute nitric acid (<10%) rinse Copious water rinse

Solvent	Examples	Suggested Cleaning Methods
Organic	Hydrocarbons, small molecules, oils	Rinse with organic solvent Warm water with detergent Dilute nitric acid (<10%) rinse Copious water rinse
Organic	Alcohol solutions	Rinse with similar alcohol, acetone, or other solvent Copious water rinse
Organic	Acidic solutions	Rinse with organic solvent Warm water with detergent Dilute nitric acid (<10%) rinse Copious water rinse
Organic	Hydrocarbons, small molecules, oils	Rinse with organic solvent Warm water with detergent Dilute nitric acid (<10%) rinse Copious water rinse

**Important:** Keeping the vial clean is very important for long vial life.

- Never store vials or cuvettes long term in a water or solvent bath between uses. If the solvent you are using dries, impurities in the water or solvent may be deposited on the inside of the vial or cuvette, causing permanent damage.
- Use only lens cleaning tissue/paper or fine soft cloth to wipe optical surfaces. Most paper products (such as facial tissues, paper towels, etc.) contain wood fibers that can damage the vial or cuvette material.
- At the end of the day, ensure that all vials or cuvettes are well cleaned and stored in a suitable container after drying.

Term	Definition
Dilute acid	Dilute nitric acid (<10%)
Acid	Hydrochloric (5M) acid or nitric acid (5M) (see the Note below)
Solventrinse	Rinse with the solvent that was originally used to solvate your analyte
Copious water rinse	Use a pure water (deionized, distilled, RO) and rinse at least 10 times
Detergent	Use a neutral pH detergent (Triton X-100), if available, to dilute acid wash; water rinse to remove residue

**Note:** Do not use 5M nitric acid on an anti-reflection mirror coated vials or cuvettes.

**Important:** Using an ultrasonic cleaning bath for your vials or cuvettes is not recommended. Each bath generates a different frequency; therefore, if your bath operates at the resonant frequency of a vial or cuvette, the vial or cuvette will break. If a vial or cuvette was cleaned in an ultrasonic bath, the warranty may be void by the manufacturer.

**Important:** Do not dry cells in an oven.

Micro flow-cells can be kept clean by:

- Flushing well with a solvent after use.
- Aspirating dilute acid, base, non-filming detergent or bleach through the cell in short bursts.
- Storing with distilled water in the cell.

## Cleaning the Windows of the Sample Compartment

Do not use acetone or abrasive materials to clean the windows of the sample compartment. Instead, use a non-abrasive laboratory cleaning solution (such as a commercial cell cleaning solution), distilled water or alcohol.

Use the liquid and a soft, lint-free cloth to clean the windows. Do not apply too much pressure or the surface of the windows may be damaged. Be sure to remove all fingerprints.

# Replacing the Tungsten-Halogen Lamp

This procedure is for the Orion AquaMate 7100 Vis spectrophotometer. The lamp source lifetime is approximately 1,000 hours

**Warning:** This lamp gets very hot during operation. Before removing the lamp, turn off the instrument and allow the lamp to cool for 10 minutes.

To replace the tungsten lamp:

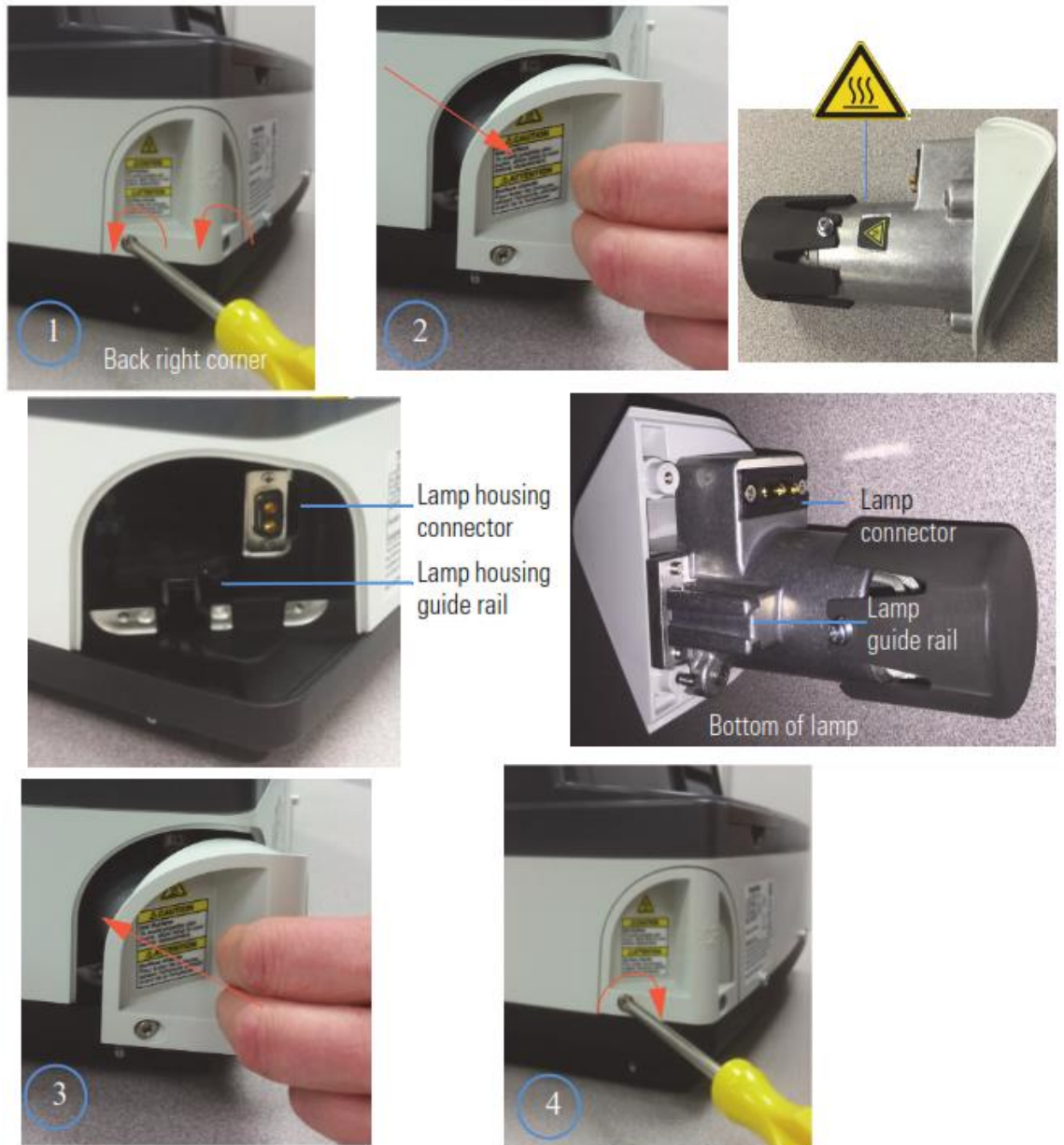

# Xenon Lamp Life

The Xenon lamp life status is displayed in the Settings menu. If the lamp is serviced and replaced, the lamp life can be reset.

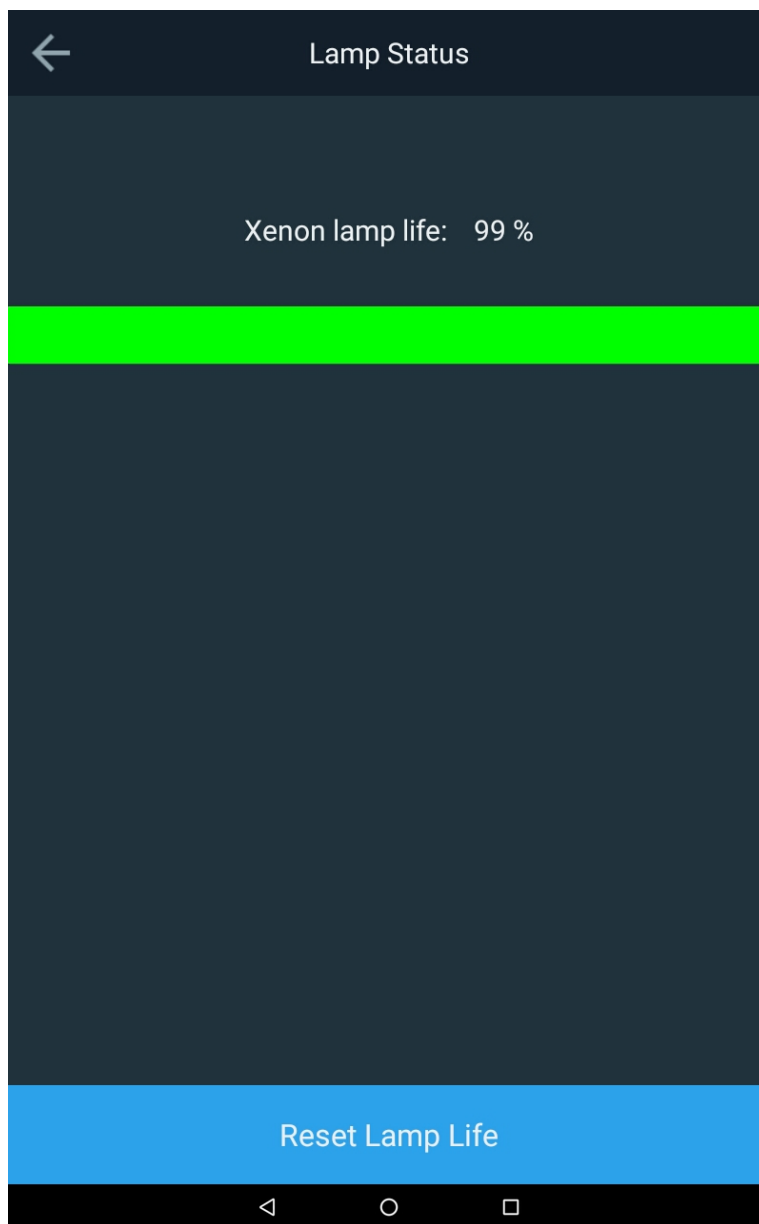

# Replacing the Xenon Flash Lamp

This procedure is for the Orion AquaMate 8100 Vis spectrophotometer. The typical lamp source lifetime is approximately 3 – 5 years

**Warning:** This lamp gets very hot during operation. Before removing the lamp, turn off the instrument and allow the lamp to cool for 10 minutes.

## To replace the xenon flash lamp:

1. Power down the device
2. Remove top cover.
  - a. Using a #1 Phillips screwdriver, loosen the two screws on the back of the instrument. Note: Do not unscrew the two screws completely. Remove wireless dongle if present



- b. Pull two tabs underneath towards the front of the instrument.







3. Reinstall the new lamp and the cover in the reverse order.
  - a. DO NOT TOUCH the window on the new lamp.
  - b. Take care when handling the new lamp and its attached bracket.
    - The lamp is precision aligned to the bracket.
    - Do not adjust the screws holding the lamp to the bracket.
    - Ensure that the pins and holes that align the black bracket to the base are properly engaged before tightening the screws that hold the new lamp to the base.
    - Do not overtighten screws.

# 11

## CHAPTER 11 **Customer Services**

### Technical Support

For any questions or if you require assistance, contact our Technical Support Specialists:

- Email [wai.techservbev@thermofisher.com](mailto:wai.techservbev@thermofisher.com)
- Within the United States, call 1-800-225-1480
- Outside the United States, call +1-978-232-6000 or fax +1-978-232-6031

For additional product information, contact your local authorized dealer, Thermo Scientific Orion technical sales representative or contact us using the Water and Laboratory Products (WLP) information on the page back of this user manual.

Visit [www.thermoscientific.com/water](http://www.thermoscientific.com/water) to view Thermo Scientific Orion products and download product literature, user manuals and manuals, software updates and additional application and technical resources.

For the most current warranty information, refer to the Thermo Scientific Orion warranty card included on the Thermo Scientific Orion AquaMate literature CD and available online at [www.thermoscientific.com/water](http://www.thermoscientific.com/water).

# Instrument Specifications

Orion AquaMate 8100 UV-Vis Spectrophotometer Specifications	
<b>Optical Design</b>	Dual beam
<b>Spectral Bandwidth</b>	2 nm
<b>Light Source (Typical Lifetime)</b>	Xenon flash lamp (5 years)
<b>Detector</b>	Dual silicon photodiodes
<b>Wavelength Range</b>	190 to 1100 nm
<b>Wavelength Accuracy</b>	±0.5 nm
<b>Wavelength Repeatability</b>	±0.2 nm
<b>Wavelength Scanning Speed</b>	Slow, medium and fast (up to 1600 nm/min)
<b>Wavelength Data Resolution</b>	0.2, 0.5, 1.0, 2.0, 3.0, 5.0 nm
<b>Photometric Measurement Modes</b>	Absorbance, % transmittance, concentration
<b>Photometric Range</b>	-2A to +3.5A
<b>Photometric Accuracy</b>	±0.002A at 0.5A, ±0.004A at 1.0A, ±0.008A at 2.0A
<b>Photometric Repeatability<sup>1</sup></b>	±0.001A at 1A
<b>Photometric Noise<sup>2</sup></b>	≤0.00020A at 0A at 260 and 500 nm ≤0.00030A at 1A at 260 and 500 nm ≤0.00040A at 2A at 260 and 500 nm
<b>Photometric Drift<sup>3</sup></b>	<0.0005A/Hr (At 500 nm after warm-up)
<b>Photometric Stray Light</b>	< 1.0% T 198 nm (KCl), <0.05% T at 220 nm (NaI), <0.03% T at 340 nm (NaNO <sub>2</sub> )
<b>Display</b>	7-inch color touchscreen, high definition, 800 × 1280 pixels
<b>Touchscreen</b>	Glove friendly touch screen
<b>Connectivity</b>	USB type A port for USB stick (front panel), USB type B port for computer (rear panel), USB type A port for printer (rear panel)
<b>Dimensions</b>	35.5 × 38.5 × 19.5 cm (L × W × H)
<b>Weight</b>	7.5 kg
<b>Power Requirements</b>	100 to 240 V ; 50 to 60 Hz

<sup>1</sup>Measured at 1.0A at 546 nm <sup>2</sup>RMS at 500 nm. 60 consecutive Measurements. <sup>3</sup>At 500 nm after 1 hr warmup

Orion AquaMate 7100 Vis Spectrophotometer Specifications	
Optical Design	Dual beam
Spectral Bandwidth	5.0 nm
Light Source (Typical Lifetime)	Tungsten-halogen lamp (1000 hours)
Detector	Dual Silicon photodiode
Wavelength Range	-3A to +3.5A
Wavelength Accuracy	±0.5 nm
Wavelength Repeatability	<±0.2 nm
Wavelength Scanning Speed	Automatic up to 1,800 nm/min
Wavelength Data Resolution	0.2 nm, 0.5 nm, 1 nm, 2 nm, 5 nm
Photometric Measurement Modes	Absorbance, % transmittance, concentration
Photometric Range	-3A to +3.5A
Photometric Accuracy	±0.002A at 0.5A, ±0.004A at 1.0A, ±0.008A at 2.0A
Photometric Repeatability <sup>1</sup>	±0.001A at 1A
Photometric Noise <sup>2</sup>	≤0.00020A at 0A at 260 and 500 nm ≤0.00030A at 1A at 260 and 500 nm ≤0.00040A at 2A at 260 and 500 nm
Photometric Drift <sup>3</sup>	<0.0010A/Hr (At 500 nm after warm-up)
Photometric Stray Light	<0.05% T at 340 nm and 400 nm
Display	7-inch color touchscreen, high definition, 800 × 1280 pixels
Touchscreen	Glove friendly touch screen
Connectivity	USB type A port for USB stick (front panel), USB type B port for computer (rear panel), USB type A port for printer (rear panel)
Dimensions	35.5 × 38.5 × 19.5 cm (L × W × H)
Weight	7.5 kg (19 lb.)
Power Requirements	100 to 240 V; 50 to 60 Hz

<sup>1</sup>Measured at 1.0A at 546 nm <sup>2</sup>RMS at 500 nm. 60 consecutive Measurements. <sup>3</sup>At 500 nm after 1 hr warmup

**Note:** We reserve the right to make product improvements and updates. Specifications are subject to change without notice.

## Ordering Information

Cat. No.	Description
AQ8100	AquaMate 8100 UV-Vis spectrophotometer with pre-loaded methods, holder for vials and test tube from 12 to 25 mm OD, 10 mm square vial holder, printer, North America, European and UK Power cords and dust cover
AQ8100 APAC	AquaMate 8100 UV-Vis spectrophotometer with pre-loaded methods, holder for vials and test tube from 12 to 25 mm OD, 10 mm square vial holder, printer, China, Indian and Australia / NZ Power cords and dust cover
AQ7100	AquaMate 7100 Vis Spectrophotometer with pre-loaded methods, holder for vials and test tube from 12 to 25 mm OD, North America, European and UK Power cords and dust cover
AQ7100 APAC	AquaMate 7100 Vis Spectrophotometer with pre-loaded methods, holder for vials and test tube from 12 to 25 mm OD, China, Indian and Australia / NZ Power cords and dust cover
AQX1RNDVH	Vial / Test Tube Holder for vials and test tube from 12 to 25 mm OD for Orion™ AquaMate 7100 & 8100 Spectrophotometers
AQX1SQVH	10 mm square single-cell holder for Orion™ AquaMate 7100 & 8100 Spectrophotometers
AQX1LWL VH	Long path rectangular cell holder for 20-100 mm pathlength cuvettes for Orion™ AquaMate 7100 & 8100 Spectrophotometers
AQX1FLTRHDR	Film/Filter holder for filters/lenses up to 50 mm long x 80 mm tall x 10 mm thick for Orion™ AquaMate 7100 & 8100 Spectrophotometers
840-253100	AquaMate Calibration Standards Set (Requires AQX1FLTRHDR Film/Filter holder)
AQ71LMPTGST	Replacement Tungsten-Halogen Lamp, Pre-aligned for Orion™ AquaMate 7100
AQ81LMPXEN	Replacement Xenon Lamp Assy, Pre-aligned for Orion™ AquaMate 8100
AQX1PWRSUP	Power Supply for Orion™ AquaMate 7100 & 8100 Spectrophotometers +12V 5A
AQX1AUCBL	Australia power cable (AS/NZS 3112) for Orion™ AquaMate 7100 & 8100 Spectrophotometers
AQX1CNCBL	China power cable (PRC/3) for Orion™ AquaMate 7100 & 8100 Spectrophotometers
AQX1EUCBL	European power cable (CEE 7/7) for Orion™ AquaMate 7100 & 8100 Spectrophotometers
AQX1INCBL	India power cable (SABS 164) for Orion™ AquaMate 7100 & 8100 Spectrophotometers
AQX1NACBL	North America power cable (NEMA 5-15) for Orion™ AquaMate 7100 & 8100 Spectrophotometers
AQX1UKCBL	UK Power cable (BS 1362) for Orion™ AquaMate 7100 & 8100 Spectrophotometers
AQX1PRNTR	Snap-on Printer for Orion™ AquaMate 7100 & 8100 Spectrophotometers
AQX1PPRPSA	Self-Stick Printer Paper for AquaMate Printer Accessory
AQX1PPRSTD	Standard Printer Paper for AquaMate Printer Accessory
AC2V24	24 mm round vials, 12 pack
AC2V16	16 mm round vials, 10 pack
COD165	Thermoreactor for digestion methods, 100 / 120 / 150 / 160 / 165°C temperature control

Cat. No.	Description
CODS01	1000 ppm COD standard, 475 mL
CODS10	10000 ppm COD standard, 475 mL
AC2002	Alkalinity-M, acid / indicator method, tablet reagent, 100 tests
AC3002P	Alkalinity-P, acid / indicator method, tablet reagent, 100 tests
AC2027	Aluminum, eriochrome cyanine R method, tablet reagent, 50 tests
AC4P27	Aluminum, eriochrome cyanine R method, powder reagent, 100 tests
AC2012	Ammonia as nitrogen, indophenol blue method, tablet reagent, 50 tests
AC4P12	Ammonia as nitrogen, salicylate method, powder reagent, 100 tests
ACR011	Ammonia as nitrogen, high range, salicylate method, 50 reaction tubes
ACR012	Ammonia as nitrogen, low range, salicylate method, 50 reaction tubes
AC2035	Bromine, DPD method, tablet reagent, 100 tests
AC2017	Chloride, silver nitrate / turbidity method, tablet reagent, 50 tests
AC2070	Chlorine, free & total, DPD method, tablet reagent, 50 tests each
AC2071	Chlorine, free, DPD method, tablet reagent, 100 tests
AC2072	Chlorine, total, DPD method, tablet reagent, 100 tests
AC3072	Chlorine, total, high range, KI / acid method, tablet reagent, 100 tests
AC4P71	Chlorine, free, DPD method, powder reagent, 100 tests
AC4P72	Chlorine, total, DPD method, powder reagent, 100 tests
AC2099	Chlorine dioxide, DPD method, tablet reagent, 100 tests
CODL00	COD, low range, dichromate reactor digestion method, 25 digestion tubes
CODH00	COD, mid range, dichromate reactor digestion method, 25 digestion tubes
CODHP0	COD, high range, dichromate reactor digestion method, 25 digestion tubes
AC2029	Copper, free & total, butinoline method, tablet reagent, 50 tests
AC4P29	Copper, free, bicinchoninate method, powder reagent, 100 tests
AC2098	Cyanuric acid, melamine method, tablet reagent, 100 tests
AC2009	Fluoride, SPADNS method, liquid reagent, 50 tests
AC3032T	Hardness, total, metallphthalein method, tablet reagent, 100 tests
AC2030	Hydrazine, 4-(dimethyl-amino)-benzaldehyde method, powder reagent, 30 tests
AC2078	Iron, II & III, PPST method, tablet reagent, 100 tests
AC4P78	Iron, ferro, 1,10-phenanthroline method, powder reagent, 100 tests
AC4P79	Iron, total, TPTZ method, powder reagent, 100 tests
AC2055	Manganese, formaldoxime method, tablet reagent, 50 tests
AC4P54	Manganese, low range, PAN method, powder reagent, 100 tests
AC4P55	Manganese, high range, periodate oxidation method, powder reagent, 100 tests
AC4P42	Molybdate / molybdenum, mercaptoacetic acid method, powder reagent, 100 tests

Cat. No.	Description
ACR007	Nitrate as nitrogen, chromotropic acid method, 50 reaction tubes
AC2046	Nitrite as nitrogen, n-(1-naphthyl)-ethylenediamine method, tablet reagent, 100 tests
AC4P46	Nitrite as nitrogen, low range, diazotization (azo) method, powder reagent, 100 tests
ACD004	Nitrogen, total, low range, persulfate digestion method, 50 digestion tubes
ACD007	Nitrogen, total, high range, persulfate digestion method, 50 digestion tubes
AC3048	Ozone, DPD / glycine method, tablet reagent, 100 tests
AC2001	pH, phenol red method, tablet reagent, 100 tests
AC3001	pH, Phenol red method, liquid reagent, 30 tests
AC2095-WA	Phosphate, ortho, low range, phosphomolybdic acid / ascorbic acid, tablet reagent, 50 tests
AC2096	Phosphate, ortho, high range, vanadomolybdate method, tablet reagent, 50 tests
AC4P95	Phosphate, ortho, phosphomolybdenum / ascorbic acid method, powder reagent, 100 tests
ACD095	Phosphate as P, total, persulfate digestion / ascorbic acid method, 50 digestion tubes
ACD095AH	Phosphate as P, hydrolyzable, phosphomolybdenum / ascorbic acid, 50 digestion tubes
ACR095	Phosphate, ortho, phosphomolybdenum / ascorbic acid method, 50 reaction tubes
AC2060	Silica, silicomolybdate method, tablet reagent, 50 tests
AC2061	Silica, phosphate removal reagent, 100 tablets
AC4P60	Silica, high range, silicomolybdate method, powder reagent, 100 tests
AC4P82	Sulfate, barium sulfate-turbidity method, powder reagent, 100 tests
AC2016	Sulfide, DPD / catalyst method, tablet reagent, 50 tests
AC2065	Zinc, zincon method, tablet reagent, 50 tests

Visit [www.thermoscientific.com/water](http://www.thermoscientific.com/water) for a complete listing of all available Thermo Scientific Orion meters, electrodes, solutions and accessories.



# A

## APPENDIX A General Instrument Information

### Parameters

Parameter	Description
+ - x ÷	Enters math operators when in the calculator mode (Utility)
% of Lamp Life Used	Displays the estimated percentage of lamp life used, based on a typical Xenon lamp life of five years (Utility)
3-Pt Net	Calculates peak height from the tangential baseline in the graph (Scanning)
Absorbance	Enters the absorbance value
Accept Name	Accepts the displayed name entry (TestName and Edit [Units])
Add Character	Adds a highlighted character to the name entry (TestName and Edit [Units])
Add nm	Adds a wavelength and factor to the list in multi-wavelength tests and some performance verification tests
Area	Calculates area under the peak in the graph (Scanning)
AutoPrint	Turns the automatic printout on or off
Autoscale	Rescales the graph to the original ranges of X- and Y-axes (Kinetics, Scanning)
Baseline Expiration	Enters time when the baseline for scan tests needs to be collected again (Utility)
Beeper	Turns the audible signal for key presses on and off (Utility)
Calculation Baseline	Selects the zero baseline or the tangential baseline to calculate area under the peak in the graph (Scanning)
Calculator	Enables the calculator mode (Utility)
Cell Position #	Displays the vial or cuvette position placed in the light path (only with Auto 6 or Auto 3 sample positioner settings)

Parameter	Description
Change Mode Change to Abs Change to % T	Switches measurement modes (Basic A-% T-C and some Performance Verification tests)
Collect Baseline	Starts the collection of the baseline (Scanning)
Concentration	Sets the concentration value
Conc. of Standard	Displays the entered concentration value (Adv A-% T-C)
Cursor	Goes to cursor tracking mode to view data points in graph (Kinetics, Scanning)
←Cursor Cursor→	Moves the cursor right or left on the graph and displays the data of each point (Kinetics, Scanning)
Curve Fit	Selects the type of line fit calculation (Standard Curve)
Data File Name	Allows entry of a name for the data file when AutoSave is on
Date Standards Measured	Displays the date when standards were last measured (Standard Curve)
Date/Time Setup	Enters the current date and time settings for the instrument (Utility)
Delay Time	Enters the time from test initiation to first measurement; allows for sample equilibration (Adv A-% T-C and Kinetics)
Delete Character	Deletes the last character of name entry (TestName and Edit [Units])
Delete File	Deletes a test or data file from the Stored Tests Directory (Utility)
Delete Name	Deletes the entire name to allow a new entry (TestName and Edit [Units])
Delete nm	Removes a wavelength and factor from the list (Multiwavelength and Performance Verification)
Diluent Volume	Enters the volume of diluent added before measurement (Dilution Multiplier in some Bio Tests)
Dilution Multiplier	Displays the factor used to correct for sample dilution
Display Activity	Indicates whether results should include protein concentration
DNA $\epsilon$ (260)	Calculates the extinction coefficient
DNA Factor	Enter the factor to calculate DNA concentration (DNA Bio Tests)
Edit	Changes a wavelength or factor in the list (Multiwavelength and Performance Verification)
Edit Curve	Manipulates the graph (Kinetics)
Edit Data	Selects a portion of data in a table for recalculation of result (Kinetics, Scanning)
Edit Graph	Manipulates the graph (Scanning)
Edit Scale	Changes the graph axis scales and view individual data points (Scanning)
Factor	Enters a factor to convert a datum to a result Abs x Factor 1 = Concentration Result Abs/min x Factor 2 = Kinetics Result Can be entered or calculated from concentration and absorbance in Adv A-% T-C
Factor 1	Enters a factor to convert a datum to a result Abs(WL1) x Factor = Result (Abs Ratio, Abs Difference, Multiwavelength)



Parameter	Description																												
Factor 2	Enters a factor to convert a datum to a result Abs(WL2) x Factor = Result (Abs Ratio, Abs Diff, Multiwavelength)																												
Factor 3-31	Enters a factor to convert a datum to a result Abs (WL3-31) x Factor = Result (Multiwavelength)																												
Graph	Displays the graph of collected data (Kinetics, Scanning)																												
ID #	Enters the numeric identifier for measurement; auto increments during the test until turned off (set to 0)																												
Instrument Serial Number	Displays the serial number of the instrument (Utility)																												
Intercept	Enters where the line crosses the Y-axis (Abs where concentration = 0)																												
Interval	Enters the wavelength range between data points (Scanning)																												
Interval Time	Enters the time between repeated readings (Kinetics)																												
Linearity Value	<p>Enters a linearity value (Kinetics)</p> <p>To help determine the linearity of the reaction during the measurement, the instrument offers a linearity parameter. This is the difference between the changes in absorbance of two measurements as shown in the following example:</p> <table border="1"> <thead> <tr> <th>Time</th> <th>Abs</th> <th>?A</th> <th>Linearity</th> </tr> </thead> <tbody> <tr> <td>1</td> <td>.1</td> <td>---</td> <td>---</td> </tr> <tr> <td>2</td> <td>.2</td> <td>.1</td> <td>---</td> </tr> <tr> <td>3</td> <td>.29</td> <td>.09</td> <td>P</td> </tr> <tr> <td>4</td> <td>.38</td> <td>.09</td> <td>P</td> </tr> <tr> <td>5</td> <td>.46</td> <td>.08</td> <td>P</td> </tr> <tr> <td>6</td> <td>.52</td> <td>.06</td> <td>F</td> </tr> </tbody> </table> <p>Linearity is the ?A between ?A calculations; P=Pass and F=Fail</p>	Time	Abs	?A	Linearity	1	.1	---	---	2	.2	.1	---	3	.29	.09	P	4	.38	.09	P	5	.46	.08	P	6	.52	.06	F
Time	Abs	?A	Linearity																										
1	.1	---	---																										
2	.2	.1	---																										
3	.29	.09	P																										
4	.38	.09	P																										
5	.46	.08	P																										
6	.52	.06	F																										
Load Test	Loads the highlighted test from the Stored Tests Directory into active memory and sets the instrument to the test parameters (Utility)																												
Lock/Unlock	Used to protect stored tests from accidental deletion or alteration; asks for a password to allow the user to lock or unlock the file (Utility)																												
Low/High Limits	Enters the lowest and highest acceptable results, outside of which the result is flagged as "Low" or "High" (Adv A-% T-C, Std Curve, Abs Ratio, Abs Diff, Kinetics, 3-PtNet, some Bio Tests)																												
Math	Accesses manipulation functions of the graph (Scanning)																												
Measure <b>Blank</b> (as function key)	Initiates measurement of the blank																												
Measure <b>Blank</b> (as test parameter)	Selects the frequency of zeroing the instrument as Once or Every Reading (Kinetics)																												
MeasurementMode	Selects the type of photometric data reported for a measurement (Abs, % T, Conc) in A-% T-C, Kinetics, Scanning, Multiwavelength																												
Measure <b>Samples</b>	Initiates measurement of samples																												
Max, X	Enters a maximum X-value to manually rescale the graph (Kinetics, Scanning)																												
Max, Y	Enters a maximum Y-value to manually rescale the graph (Kinetics, Scanning)																												
Min, X	Enters a minimum X-value to manually rescale the graph (Kinetics, Scanning)																												
Min, Y	Enters a minimum Y-value to manually rescale the graph (Kinetics, Scanning)																												
NextCursor	Selects a cursor point in functions using more than one cursor setting: Scan-Area and Scan-3-PtNet calculations in the graph (Scanning)																												

Parameter	Description
Number of Matched Cuvettes	Enters the number of vials or cuvettes that will be run in the Correction Program (maximum of 5)
Number of Samples	Enters the number of samples to be measured in the test (Not available in Kinetics or Scanning)
Number of Standards	Enters the number of standards to be measured for the standard curve
Printer	Selects the output mode as RS-232 or Parallel (Utility)
Protein Factor	Enters the factor to calculate protein concentration (DNA Bio tests)
Ref. Wavelength	Enters a reference wavelength value; for each reported measurement, measures the analytical wavelength and reference wavelength Reported measurement = Abs @ Analytical WL – Abs @ Reference WL
Ref. Wavelength Correction	Turns reference wavelength correction on or off
Run Standard	Goes to the standards entry screen
Run Test	Goes to the data collection screen
Sample Positioner	Selects the type of Sample Positioner: <b>1 Cell</b> = no movement; zeros and measures sample in same position <b>Manual 6</b> = vial holder carousel moved by sample positioner touchscreen; always zeros on position B, then returns to set position to start measurement <b>Auto 3</b> = vial holder carousel automatically moved to B, 2, 4 (always zeros on position B, then goes to position 2 to start measurement) <b>Auto 6</b> = vial holder carousel automatically moved to B, 1, 2, 3, 4, 5 (always zeros on position B, then goes to position 1 to start measurement)
Sample Volume	Enters the total volume of sample (under Dilution Multiplier in some Bio Tests)
Save Test	Saves all parameters of the current test in internal memory for later recall
Scan Speed	Selects the speed (nm/min) for a scan as Slow, Medium or Fast (Scanning)
Screen Contrast	Improves visibility of the display by changing the contrast between the background and text (Utility)
Select Test	Tags the highlighted test name with ">" to include the test in the SmartStart menu (Utility Stored Tests Directory)
Set Max. X Set Min. X	Sets the cursor position in the graph as the minimum X and the maximum X values for recalculating rate (Kinetics)
Set nms	Use to enter and edit the wavelength and factor values
Set Options	Selects the factor entry or the baseline to calculate area under the peak in the graph (Scanning)
Setup Correction	Initiates the procedure to collect the data necessary to correct for absorbance differences between vials or cuvettes
Slope	Enters abs/concentration value (Standard Curve)
Smoothing	Turns data smoothing on and off (Scanning)
Software Revision	Displays the version of firmware in the instrument (Utility)
SRE Tolerance	Acceptable minimum stray light
Standard Concentrations	Enters the concentration of standards used to generate the standard curve for the test

Parameter	Description
Standby	Selects the time since the last keystroke or instrument activity; powers down the unit to save lamp life (Utility)
Start Wavelength	Enters the beginning wavelength for a scan (Scanning)
Statistics	Turns statistics on or off, calculates the average and standard deviation of results when set on; statistics registers are cleared when set off, when instrument is turned off, when test parameters are changed and when test is saved or resaved (all test types except Kinetics, Scanning, Multiwavelength)
Std Concentration	Enters the concentration of the analyte in the standard solution
Stop Wavelength	Enters the ending wavelength for a scan (Scanning)
Stored Tests Directory	Displays the list of tests stored in the instrument (Utility)
Tabular	Displays the list of collected data (Kinetics, Scanning)
Test Name	Operator enters an alphanumeric name (maximum of 16 characters) for the test, the name will be included on the data printout and, if the test is saved, will be displayed in the Utility Test Directory screen (available in all tests)
Total Run Time	Enters the time from the run initiation to the end of the test, equals Delay Time + Interval Times + Measurement Times (Kinetics)
Units	Selects or creates units labels for results (all stored tests except Abs Ratio, Scanning, Cell Growth)
Unselect Test	Removes the ">" tag of the highlighted test name to remove the test from the SmartStart menu (Utility Stored Tests Directory)
Wavelength	Enters values for the analytical wavelengths

## Calculations for Software

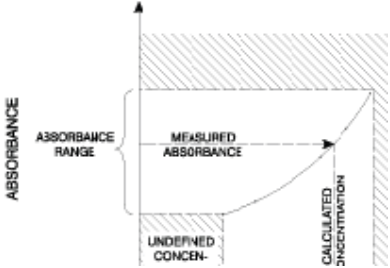
Calculation	Calculation Equation
<b>Standard Curves</b>	
Partial Sums	$SX = \sum x_i$ $SY = \sum y_i$ $SXX = \sum x_i^2$ $SYY = \sum y_i^2$ $SXY = \sum x_i y_i$ $SQX = \sum (x_i - \bar{x})^2 = N * SXX * SX^2$ $SQY = \sum (y_i - \bar{y})^2 = N * SYY * SY^2$ $SSXY = \sum (x_i - \bar{x})^2 (y_i - \bar{y})^2 = N * SXY - SX * SY$ <p>Where:  <math>x_i</math> = Concentration of <math>i^{\text{th}}</math> standard  <math>y_i</math> = Absorbance of <math>i^{\text{th}}</math> standard  <math>N</math> = Number of standards</p>
Linear Regression (general case)	$A = A(c)$ <p>Where:  <math>A</math> = absorbance  <math>c</math> = concentration</p> <p><math>A(c)</math> is defined by an equation of the form:  <math display="block">A(c) = a_4 c^4 + a_3 c^3 + a_2 c^2 + a_1 c + a_0</math></p> <p>Where:  <math>a_0</math> = Y-axis intercept  <math>a_1 \dots a_4</math> = coefficients</p> <p>(Coefficients are computed using the least squares method)</p>
Linear regression through zero	$A = a_1 * (c)$ <p>Where:  <math>A</math> = absorbance  <math>c</math> = concentration  <math>a_1</math> = slope</p> <p>The slope is calculated as: <math>a_1 = SXY/SXX</math></p> <p>This model requires:</p> <ul style="list-style-type: none"> <li>• Slope is not equal to zero or infinity</li> <li>• At least one standard data point with concentration &gt; 0</li> <li>• The absorbance of the 0 concentration blank = 0A</li> </ul>

Calculation	Calculation Equation
Segmented model	<p>The segmented model requires:</p> <ul style="list-style-type: none"> <li>• Data for at least two standard data points with different concentration and absorbance</li> <li>• Slopes of all segments must be ascending (positive) or descending (negative)</li> </ul>
Validity of standard curves	<p><math>A(c_1) &gt; A(c_2)</math> for all <math>c_1 &gt; c_2</math></p> <p>or</p> <p><math>A(c_1) &lt; A(c_2)</math> for all <math>c_1 &gt; c_2</math></p> <p>Where:  A = absorbance  <math>c_1, c_2</math> = concentration</p> <p>Graph of Valid Nonlinear Standard Curve:</p>  <p>The graph shows a coordinate system with 'ABSORBANCE' on the vertical axis and 'CALCULATED CONCENTRATION' on the horizontal axis. A curve starts at the origin and increases monotonically. A horizontal dashed line from the vertical axis is labeled 'MEASURED ABSORBANCE'. A vertical dashed line from the curve to the horizontal axis is labeled 'CALCULATED CONCENTRATION'. A bracket on the vertical axis indicates the 'ABSORBANCE RANGE'. A shaded area above the curve is labeled 'UNDEFINED CONCEN-'. The area under the curve is shaded with diagonal lines.</p>
	<p>If this is not the case, there will be more than one solution within the specified domain and the message "Curve cannot be used to determine sample concentrations – it may produce ambiguous results" will appear when the curve is viewed.</p> <p>Graph of Invalid Nonlinear Standard Curve:</p>  <p>The graph shows a coordinate system with 'ABSORBANCE' on the vertical axis and 'MEASURED ABSORBANCE' on the horizontal axis. A curve starts at the origin, increases to a peak, and then decreases, forming a downward-opening parabola. A horizontal dashed line from the vertical axis intersects the curve at two points, indicating that a single absorbance value corresponds to two different concentrations.</p>

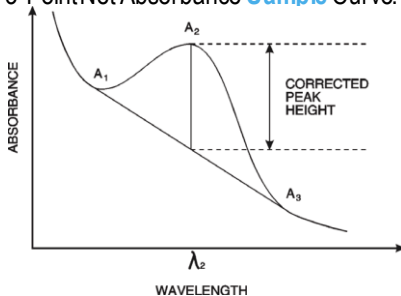
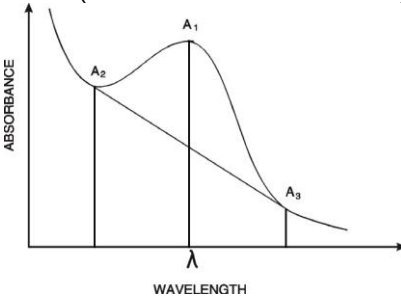
Calculation	Calculation Equation
Statistics (Linear regression general case)	$\sigma = \sqrt{\frac{\sum(y_i - \bar{y})^2}{N - n - 1}}$ <p>Where:  N = Degree of polynomial  <math display="block">r = \frac{ SSXY }{\sqrt{SQX * SQY}}</math></p> <p>The calculation for the correlation coefficient applies only to first order linear regression curves (first degree polynomials)</p>
Linear regression through zero model	$\sigma = \sqrt{\frac{SYY - (a_1 * SXY)}{N - 1}}$
Absorbance Ratio	$\frac{Abs\lambda_1}{Abs\lambda_2} \quad \text{OR} \quad \frac{Abs\lambda_1 - Abs_{ref}}{Abs\lambda_2 - Abs_{ref}}$
Absorbance Difference	Result = $Abs\lambda_1 * factor_1 - Abs\lambda_2 * factor_2$ or Result = $(Abs\lambda_1 - Abs_{ref}) * factor_1 - (Abs\lambda_2 - Abs_{ref}) * factor_2$
3-Point Net	<p>Baseline correction absorbance =</p> $A_2 - \left( A_3 + \left( [A_1 - A_2] * \frac{\lambda_3 - \lambda_2}{\lambda_3 - \lambda_1} \right) \right)$ <p>3-Point Net Absorbance <b>Sample</b> Curve:</p> 
3-Point Net (ASTM E16904)	<p>Baseline correction absorbance =</p> $A_2 - \left( A_3 + \left( [A_2 - A_3] * \frac{\lambda_3 - \lambda_1}{\lambda_3 - \lambda_2} \right) \right)$ 







[thermoscientific.com/water](http://thermoscientific.com/water)

© 2019 Thermo Fisher Scientific Inc. All rights reserved. Microsoft and Windows are registered trademarks of Microsoft Corporation. All other trademarks are the property of Thermo Fisher Scientific Inc. & its subsidiaries.

---

Water and Laboratory Products

**North America**  
Toll Free: 1-800-225-1480  
Tel: 1-978-232-6000  
[Info.water@thermofisher.com](mailto:Info.water@thermofisher.com)

**Germany**  
Tel: (49) 6184-90-6000  
[info.water.uk@thermofisher.com](mailto:info.water.uk@thermofisher.com)

**China**  
Tel: (86) 21-68654588  
[wai.asia@thermofisher.com](mailto:wai.asia@thermofisher.com)

**India**  
Tel: (91) 22-4157-8800  
[wai.asia@thermofisher.com](mailto:wai.asia@thermofisher.com)

**Singapore**  
Tel: (65) 6778-6876  
[wai.asia@thermofisher.com](mailto:wai.asia@thermofisher.com)

**Japan**  
Tel: (81) 045-453-9175  
[wai.asia@thermofisher.com](mailto:wai.asia@thermofisher.com)

**Australia**  
Tel: (613) 9757-4300  
In Australia (1300) 735-295  
[InfoWaterAU@thermofisher.com](mailto:InfoWaterAU@thermofisher.com)

The logo for Thermo Scientific, featuring the word "thermo" in a bold, red, lowercase sans-serif font, and the word "scientific" in a grey, lowercase sans-serif font directly below it.