

THP/PCF Steering Gear Service Manual

THP / PCF 45 AND 60 SERIES

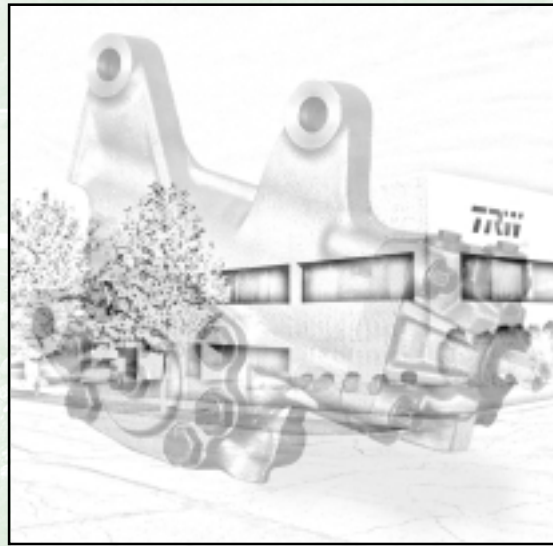

Hazard Warning Definitions

 WARNING	A warning describes hazards or unsafe practices which could result in severe personal injury or death.
--	---

 CAUTION	A caution describes hazards or unsafe practices which could result in personal injury or product or property damage.
--	---

NOTE	A note gives key information to make following a procedure easier or quicker.
-------------	---

Disclaimer

This Service Manual has been prepared by TRW Commercial Steering Systems for reference and use by mechanics who have been trained to repair and service steering components and systems on heavy commercial vehicles. TRW Commercial Steering Systems has exercised reasonable care and diligence to present accurate, clear and complete information and instructions regarding the TRW Commercial Steering THP/PCF Series Integral Power Steering Gears. Since this is a general service manual, the photographs and illustrations may not look exactly like the steering gear being serviced. The procedures, therefore, must be carefully read and understood before servicing.

If inspection or testing reveals evidence of abnormal wear or damage to the THP/PCF steering gear or if you encounter circumstances not covered in the Manual, STOP - Consult the vehicle manufacturer's Service Manual and warranty. Do not try to repair or service a THP/PCF steering gear which has been damaged or includes any part that shows excessive wear unless the damaged and worn parts are replaced with original TRW replacement and service parts and the unit is restored to TRW's specifications for the THP/PCF steering gear.



It is the responsibility of the mechanic performing the maintenance, repairs or service on a particular THP/PCF steering gear to (a) inspect the steering gear for abnormal wear and damage, (b) choose a repair procedure which will not endanger his/her safety, the safety of others, the vehicle, or the safe operation of the vehicle, and (c) fully inspect and test the THP/PCF steering gear and the vehicle steering system to ensure that the repair or service of the steering gear has been properly performed and that the steering gear and system will function properly.

Patents

TRW Commercial Steering Systems THP/PCF power steering gears are covered by several United States and foreign patents, either issued or pending.

Design Features

- 1 Size** - Reduced package size for increased wheelcut
- 2 Weight** - Reduced weight for improved vehicle efficiency.
- 3 Improved Steering Performance**
 - Faster steering ratio for improved handling and lower lock to lock turns
 - Low internal friction for better return to center
- 4 High Pressure Capability** - Provides for the smallest and lightest package
- 5 Positive Center Feel (Optional)**
 - Provides steering precision through improved straight ahead torque feedback (more stiffness) and improved position feedback control (less hysteresis)
 - Allows separation of parking efforts from on-highway efforts
 - Premium performance steering gear designed for line haul vehicles
- 6 Design** - THP/PCF gear is based on the TAS model's proven steering gear technology plus:
 - Improved side cover design that reduces weight, package size, more robust seal, and a roller bearing to reduce friction and wear
 - Material and design changes made to operate at the higher pressure



Contents

Section 1	General Information	
	Introduction	2
	Oil Flow Illustration	3
	General Design	4
	General Operation	5
	Approved Hydraulic Fluids	6
	Approved Grease	6
	Gear Specification Numbers	6
	Torque Chart	7
	Exploded View	8
	Service Parts List	9
Section 2	Initial Installation	
	Installation	13
	Poppet Setting	13
	Maintenance Tips	14
Section 3	On-Vehicle Service	
	Filling and Air Bleeding the System	16
	Input Shaft Seal Replacement	17
	Sector Shaft Adjustment	21
	Poppet Readjustment	
	Single Gears	23
	Dual Gears	26
	Mirror Image	27
	Reverse Image	29
Section 4	Reseal & Repair	
	Disassembly	34
	Inspection	42
	Assembly	44
	Internal Damage Repair (by reference)	
	Poppet Component Replacement	51
	Valve Housing Worm Screw Disassembly	53
	Roller Bearing Replacement	60
	Replace Housing Port Plugs, Screws, and Fittings	61
	Final Adjustments	62
Section 5	Reinstallation	
	Reinstallation	65
	Poppet Resetting	65
	Glossary	66



WARNING

All steering mechanisms are safety critical items. As such, it is imperative that the instructions in this booklet be followed to the letter. Failure to observe the procedures set forth in this pamphlet may result in a loss of steering.

Section 1 General Information

Introduction	2
Oil Flow Illustration	3
General Design	4
General Operation	5
Approved Hydraulic Fluids	6
Approved Grease	6
Gear Specification Numbers	6
Torque Chart	7
Exploded View	8
Service Parts List	9

Introduction

This THP/PCF Service Manual applies to all TRW THP45, PCF45, THP60 and PCF60 steering gears.

This service manual reflects TRW's commitment to provide easily usable material and highly recognizable hazard notices. Some of the updates are:

- Caution and warning definitions
- Torque, force, pressure and flow notations that provide metric equivalents
- Service manual divided into sections for easier reference.
- Uninterrupted resealing instructions. Reference to damage section allows you to repair or replace damaged parts and return to the resealing procedures easily.

The three-column format used in the service manual will also help make it easy for you to service a steering gear. Column 1 illustrates the procedure with photographs, column 2 gives a brief key as well as tools to be used for each procedure, and column 3 explains in detail the procedure you should follow. **Pay special attention to the notes, cautions and warnings.**

Item numbers on the exploded view correspond with item numbers in (), that are used throughout the service manual.

As you gain experience in servicing THP/PCF series steering gears, you may find that some information in this service manual could be clearer and more complete. If so, let us know about it. Don't try to second-guess the service manual; if you do not understand a procedure, or are stuck, contact our Field Service Department at 317.423.5377. Servicing THP/PCF series steering gears should be safe and productive.

Oil Flow Illustration

Left Hand Lead

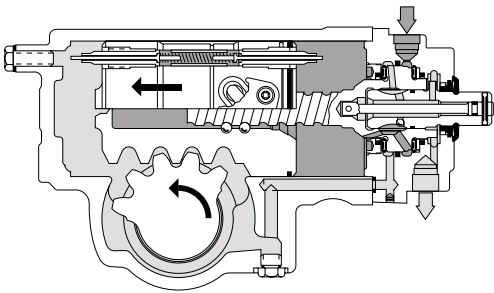

Right Hand Lead

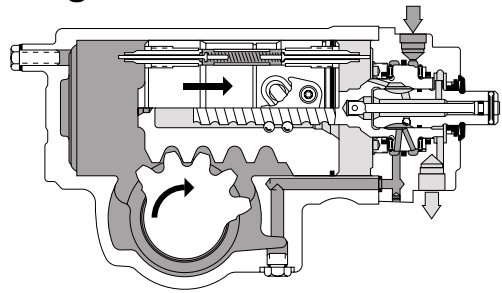

Right Hand Turn

Steering Wheel Input:
Clockwise Rotation

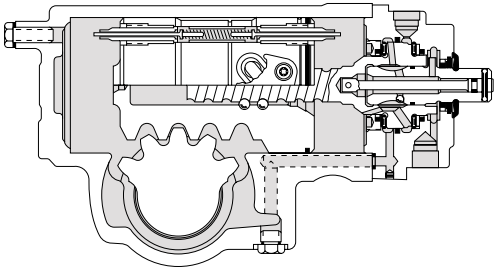
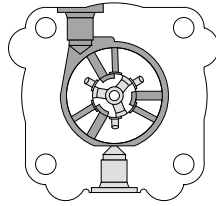

Straightline Running

No Steering Action

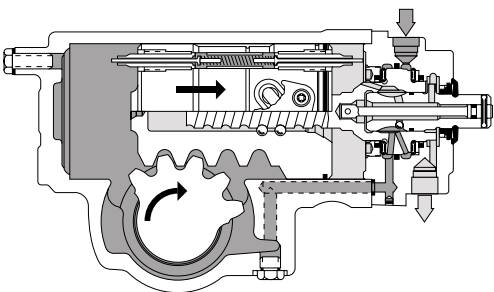
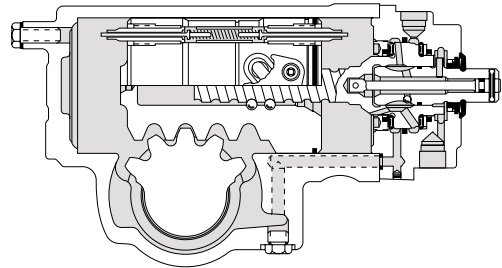
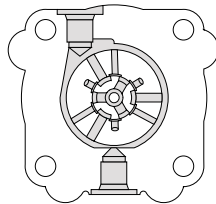

Left Hand Turn

Steering Wheel Input:
Counter-Clockwise Rotation

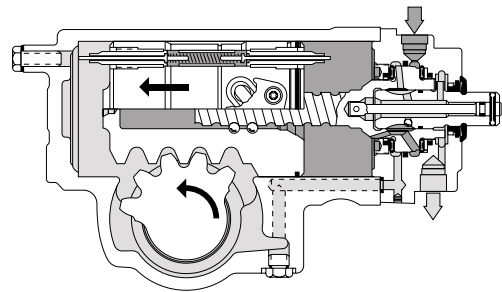
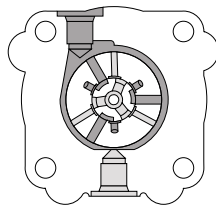

■ Supply Pressure

■ Return Pressure

General Design

Integral Power Steering

THP/PCF power steering gears are the latest design in the TRW Commercial Steering Systems' family of integral hydraulic power steering gears. Integral hydraulic power steering means that the gear contains a manual steering mechanism, a hydraulic control valve, and a hydraulic power cylinder, all in a single, compact package.

The recommended minimum flow at 1½ steering wheel turns per second is as follows:

Gear	Minimum Flow Rate
THP/PCF45	2.2 gal/min (8.3 L/min)
THP/PCF60	2.6 gal/min (9.8 L/min)

Rotary Control Valve

The rotary control valve combines simplicity of construction with desirable performance characteristics. The speed at which the driver can turn the steering wheel with power assist is dependent upon the pump flow (measured in gallons per minute or liters per minute) directed to a cylinder cavity. The control valve controls flow through the steering gear.

If the steering gear valve is controlling an auxiliary cylinder, increased minimum flow is required (generally at least 75%) based on the size of the auxiliary cylinder and the vehicle's steering geometry.

Maximum internal leakage for all THP/PCF gears is 1.2 gpm (4.5 lpm)

The pressure (measured in pounds per square inch, or bar) required for the gear to steer the vehicle is created by the power steering pump to overcome resistance at the steered wheels. The control valve senses these requirements and directs fluid to the appropriate cylinder cavity in the steering gear (and in the auxiliary cylinder if it is a dual steering system) at the proper flow rate and pressure.

Pressure Means Work, Flow Means Speed

The higher pressure a steering gear can withstand, the more work it can perform. The maximum operating pressure for all THP/PCF gears is 2685 psi (185 bar), maximum flow rate for all THP/PCF gears is 6 gpm (22.7 lpm).

The THP/PCF series gears can steer a vehicle within its front-end weight rating through a turn at low speed and engine idle. As the driver turns the steering wheel faster or slower, more or less fluid will be required by the gear. THP/PCF series vehicle front-end weight ratings are as follows:

Gear	Front Axle Rating
THP/PCF45	9,000 lb (4,100 kg)
THP/PCF60	14,300 lb (6,500 kg)

General Operation

What Happens During a Steering Maneuver

When the driver turns the steering wheel, he transmits force from the steering wheel to the steering gear input shaft. A torsion bar, pinned at its one end to the input shaft and at its other end to the worm shaft, turns with the input shaft and exerts a rotational force on the worm shaft. In response to this rotational force, the worm shaft, acting through the recirculating ball mechanism, tries to move the rack piston axially through the gear housing cylinder bore.

The rack piston's axial movement is resisted by its engagement to the sector shaft, which is connected by linkage to the steered wheels. Because of this resistance, the torsion bar is twisted by the input shaft, thereby actuating the control valve. Pressurized fluid, directed by the control valve, assists in moving the rack piston axially through the cylinder bore. The rack piston then turns the sector shaft to steer the vehicle.

Shock Loads to the Gear

If the steered wheels receive a shock load, the shock forces are transmitted through the sector shaft to the rack piston, and on to the worm shaft. The internal geometry of the steering gear causes the control valve to send high-pressure fluid to the correct cylinder cavity to resist the shock forces. By absorbing the shock forces hydraulically, the steering gear prevents objectionable kickback at the steering wheel.

Unloading (Poppet) Valves

Most THP/PCF gears are equipped with two unloading valves, one at each end of the rack piston. One valve or the other, depending on the direction of turn, will trip as the steered wheels approach the axle stops (which must be set according to manufacturer's specification). The tripped valve reduces pressure in the gear and helps to reduce heat generated by the pump. At the same time, the valves also reduce forces on the steering linkage. These valves are automatically set to axle stops after installation in vehicle at first full right and left turn.

Relief Valve

Some THP/PCF gears, (with or without poppets), are supplied with a relief valve. The relief valve limits maximum supply pressure to protect the power steering gear, but it does not reduce pressure as the steered wheels approach the axle stops.

Bleed Systems

Some THP/PCF gears which are mounted with the output shaft above the rack piston bore are equipped with either an automatic bleed system or a manual bleed screw.

The procedure for air bleeding the system is on page 16 of this manual. Replacement of damaged automatic bleed plugs, and manual bleed screws is described on page 61.

Approved Hydraulic Fluids

Automatic Transmission Fluid Dexron II
Automatic Transmission Fluid Type "E" or "F"
Chevron 10W-40
Chevron Custom 10W-40 Motor Oil
Chevron Torque 5 Fluid
Exxon Nuto H32 Hydraulic Fluid
Fleetrite PSF (Can #990625C2)
Ford Spec. M2C138CJ
Mack EO-K2 Engine Oil

Mobil ATF 210
Mobil Super 10W-40 Motor Oil
Premium Blue 2000 - SAE 15W-40
Texaco 10W-40
Texaco TL-1833 Power Steering Fluid
Union 10W-40
Union 15W-40
Unocal Guardol 15W-40 Motor Oil

The steering system should be kept filled with one of the above fluids.

⚠ WARNING Completely flush the steering system with one of the recommended fluids above only. Do not mix oil types. Any mixture or any unapproved oil could lead to seal deterioration and leaks. A leak could ultimately cause the loss of fluid, which could result in a loss of power steering assist.

Approved Grease

Exxon Polyrex* EP2 (P/N 045422)

Gear Specification Numbers

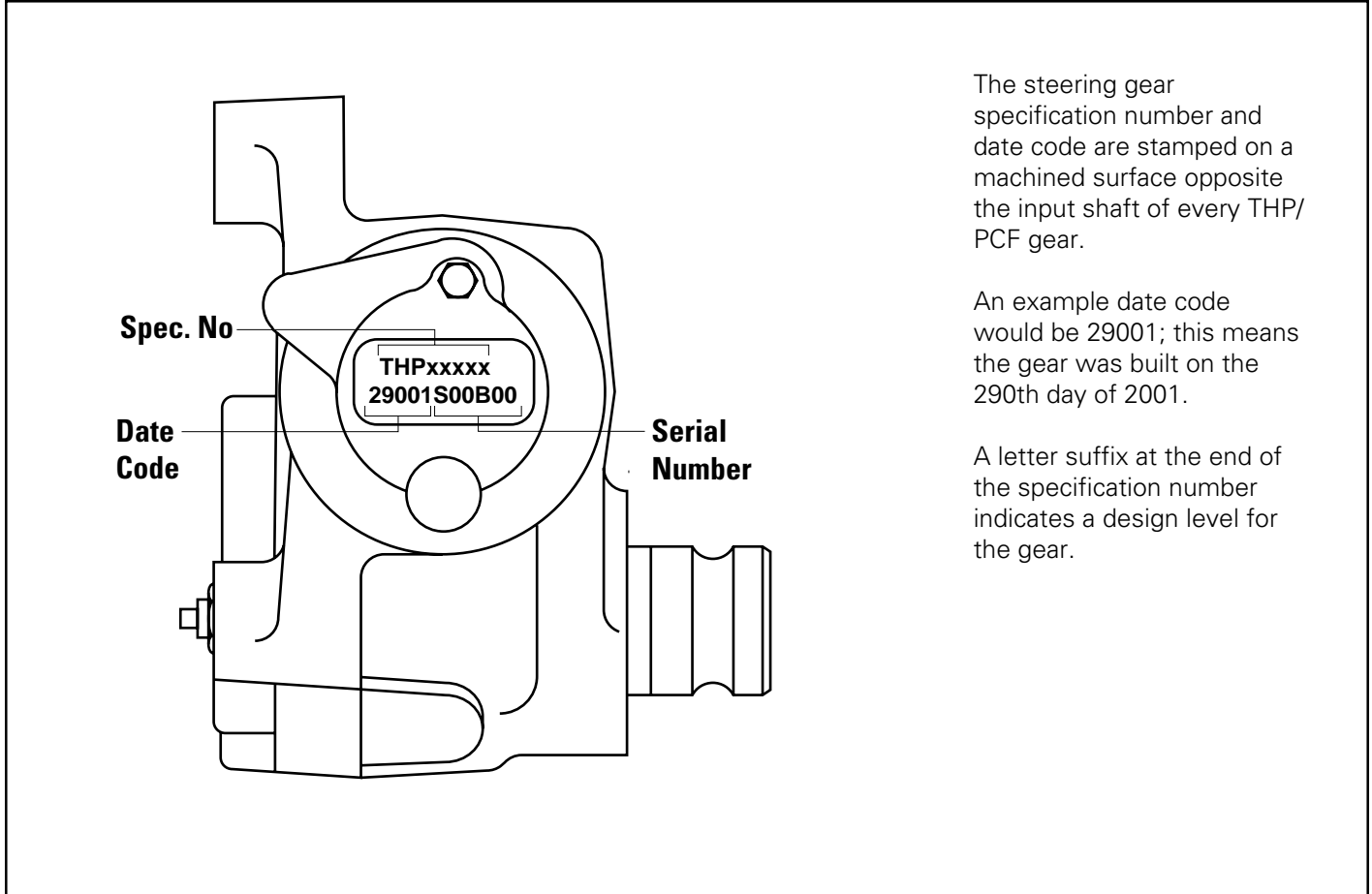

The steering gear specification number and date code are stamped on a machined surface opposite the input shaft of every THP/PCF gear.

An example date code would be 29001; this means the gear was built on the 290th day of 2001.

A letter suffix at the end of the specification number indicates a design level for the gear.

Torque Chart

Part Name	Item #	Torque Range Dry	Torque Range Lubricated
Valve housing bolts	1		118-138 ft•lb (160-187 N•m)
Auxiliary port plug	7	25-35 ft•lb (34-48 N•m)	
Relief valve cap	10	25-35 ft•lb (34-48 N•m)	
Bearing adjuster	20		11-15 ft•lb (15-20 N•m)*
Locknut	21		101-122 ft•lb (137-165 N•m)**
Poppet sleeve assembly	27	16-20 ft•lb (22-27 N•m)	
Torx screw	33	14-22 ft•lb (19-29 N•m)	
Plug, auto bleed	37	38-58 ft•lb (52-79 N•m)	
Poppet fixed stop screw	38	38-42 ft•lb (52-57 N•m)	
Sector shaft adjusting screw jam nut	46	40-45 ft•lb (54-61 N•m)	
Side cover bolts	48		180-220 ft•lb (244-298 N•m)
Poppet sealing nut, service	n/s	33-37 ft•lb (45-50 N•m)	
Manual bleed screw	n/s	40-50 in•lb (3.1-3.7 N•m)	

Item numbers referenced are shown on the exploded view located on page 8.

* After tightening to this torque value, the adjuster must be backed off $\frac{1}{4}$ to $\frac{1}{2}$ of a turn as described in step 20 on page 57.

**Torque value indicated is using recommended tools.

Special tools can be purchased through:

SPX Corporation
 Kent-Moore Tool Group
 28635 Mound Road
 Warren, MI 48092
 1-800-328-6657

THP/PCF Exploded View

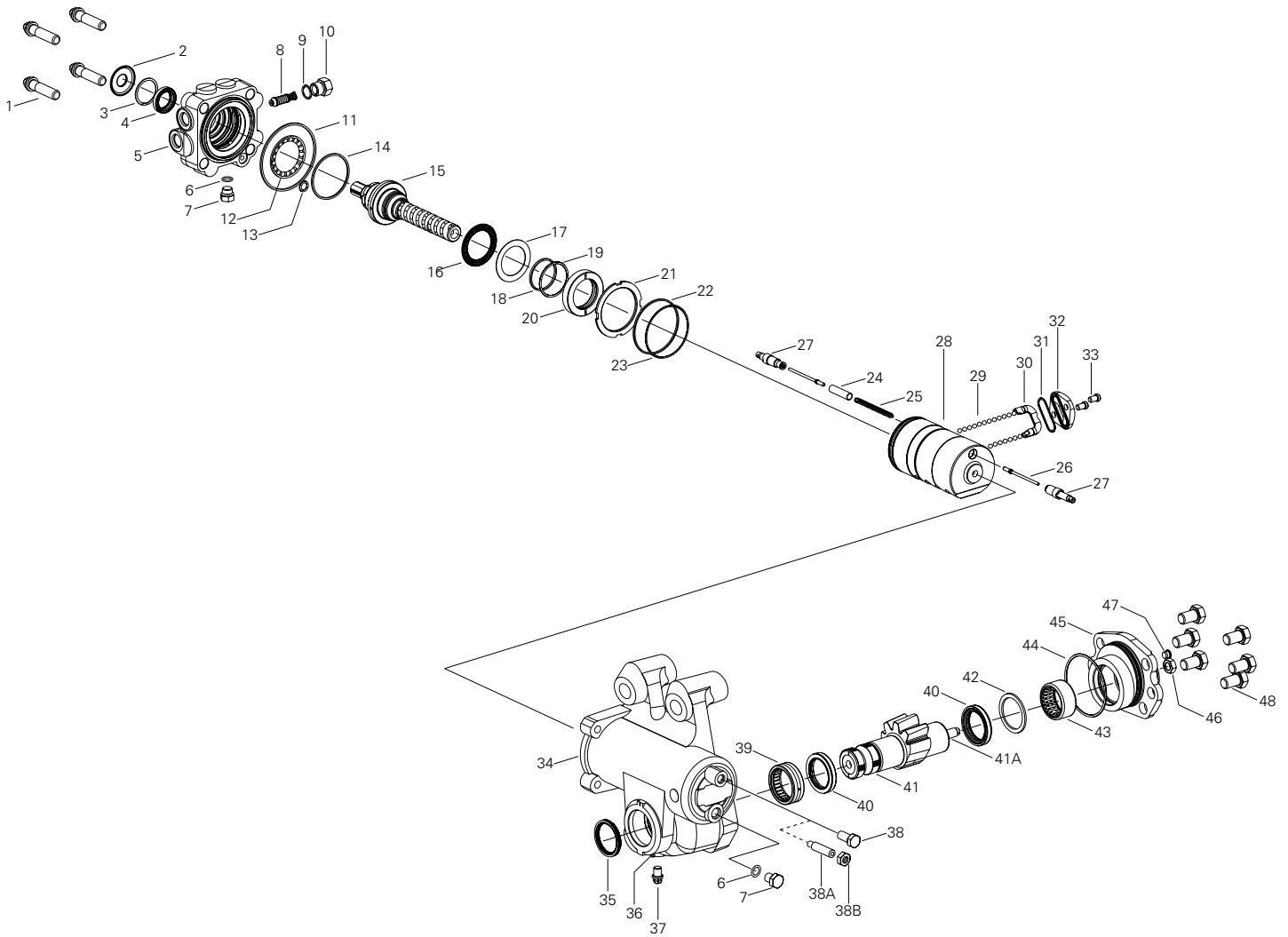

Item Description

1	Valve Housing Bolts (4)	17	Thrust Washer	*35	Dirt and Water Seal (Trunnion)
*2	Dirt and Water Seal 13/16" Serr.	*18	Seal Ring	36	Grease Fitting
*2B	Dirt and Water Seal 7/8" Serr.	*19	O-ring	37	Plug (Auto Bleed)
*2C	Dirt and Water Seal 1" Serr.	20	Bearing Adjuster	38	Fixed Stop Screw (Poppet)
*3	Retaining Ring	*21	Lock Nut	38A	Poppet Adjusting Screw
*4	Seal (Input Shaft)	*22	O-ring	38B	Nut, Poppet Adjusting Screw
5	Valve Housing Assembly	*23	Seal Ring	39	Bearing, Roller
*6	Auxilliary Port O-ring (2)	24	Push Tube	*40	Seal (2-Output)
7	Auxilliary Port Plugs (2)	25	Poppet Spring	41	Sector Shaft Assembly
8	Relief Valve (2 Piece)	26	Poppet (2)	41A	Sector Shaft Adjusting Screw
*9	O-ring	27	Poppet Seat & Sleeve Assy. (2)	42	Washer
10	Relief Valve Cap	28	Rack Piston	43	Bearing, Roller
*11	O-ring (Valve Housing)	29	Balls	*44	Side Cover O-ring
12	Bearing Assembly	30	Ball Return Guide	45	Side Cover Assembly
*13	O-ring	*31	Seal (Cap)	46	Jam Nut
*14	Seal Ring	32	Ball Return Guide Cap	*47	Vent Plug (Side Cover)
15	Worm and Valve Assembly	*33	Torx Screw (2)	48	Bolts, Side Cover (6)
16	Thrust Bearing	34	Housing		

*These items are included in complete seal kits along with 045422 lubricant and a service bulletin.

THP/PCF Service Parts List

Common Parts

Item Description	Part Number
1 Bolts (4-Valve Housing)	023037
2 Dirt and Water Seal 13/16" Serr.	478044
2B Dirt and Water Seal 7/8" Serr.	478060
2C Dirt and Water Seal 1" Ser	478050
3 Retaining Ring	401637
4 Seal (Input Shaft)	478076
6 O-ring (2-Aux. Port Plug)	032229
7 Auxiliary Port Plug (2)	415437-A1
9 O-ring (Relief Valve)	032200-153
10 Cap, Relief Valve	411061
11 Seal Ring	032829
12 Ball Bearing Assy.	400152-A1
13 Seal Ring (Valve Housing)	032823
14 Seal Ring (Valve Housing)	029128
16 Thrust Bearing	070027
17 Thrust Washer	400144
18 Seal Ring	029123
19 O-ring	032200-158
20 Bearing Adjuster	400149
21 Adjuster Locknut	027007
24 Push Tube	080154
25 Poppet Spring	401662
26 Poppet (2)	040248
27 Poppet Seat and Sleeve Assy. (2)	409118-A2
29 Balls	213684-X1
31 Cap, Seal	478042
32 Ball Return Guide Cap	400177
33 Torx Screws (2)	020228
36 Grease Fitting	037032
37 Plug, (Auto Bleed)	021397
37A Screw, Manual Bleed	213705
38 Screw, Fixed Stop	021426
38A Screw, Poppet Adjusting	
38B Nut, Poppet Adjusting Screw	
44 O-ring, Sidecover	032856
46 Nut, Jam	025150
47 Plug, Vent (Side Cover)	036201
48 Bolts, Side Cover	021434

Parts Vary by Specification*

Item Description	Part Number
5 Valve Housing	
8 Relief Valve	
15 Input Shaft, Valve, Worm Assy.	
28 Rack Piston	
34 Housing	
41 Sector Shaft (Includes 41A)	
45 Side Cover Assembly (Includes 40, 42, 43)	

*Contact Service/Sales for part numbers

Kits

Items	Description	Part Number
6 & 7	Port Plug & O-ring	415437-A1
9 & 10	Relief Valve Cap & O-ring	411061-A1
38A & 38B	Adj. Screw & Jam Nut	
	THP/PCF45 Kit	023045-X1
	THP/PCF60 Kit	021407-X1
2, 2B, 2C, 3, 4	Input Shaft Seal Kit	THP000001
	THP/PCF45 Seal Kit	THP450001
	THP/PCF60 Seal Kit	THP600001

Parts Vary by Gear Size

Item Description	THP/PCF45	THP/PCF60
22 Rack Piston Seal Ring	032828	032830
23 Rack Piston O-ring	032827	032831
30 Ball Return Guide Halves (2) R.H.	400158	400172
L.H.	400159	400173
35 Dirt and Water Seal (Trunnion)	478098	478095
39 Roller Bearing (Trunnion)	070030	071033
40 Output Seal (2)	478105	478104
42 Washer	028561	028557
43 Side Cover Roller Bearing	070031	071035
38 Fixed Stop Screw	023044	021426
38A Poppet Adjusting Screw	023045	021407
38B Poppet Adjusting Screw Nut	027018	025119

Section 2 Initial Installation

THP/PCF Installation 13
Initial Poppet Setting 13
Maintenance Tips 14

Initial THP/PCF Installation

- Bolt steering gear to frame, torque bolts to vehicle manufacturer's recommendation.
- Connect return line to THP/PCF gear return port.
- Connect hydraulic line from pump to pressure port on THP/PCF unit.
- Connect steering column to input shaft, torque pinch bolt to vehicle manufacturer's recommendation.
- Install pitman arm on output shaft, torque bolt to vehicle manufacturer's recommendation.

Initial Poppet Setting

For this procedure to work correctly, you must have: A new gear received from TRW or your vehicle manufacturer's aftermarket system, **or** a used gear on which poppet seats have been replaced or reset during gear disassembly procedures. **ALSO:** A fixed stop screw installed in the housing, or a poppet adjusting screw installed so that it duplicates the fixed stop screw length.

CAUTION The axle stops and all steering linkage must be set according to vehicle manufacturer's specifications, and the pitman arm must be correctly aligned on the sector shaft for poppets to be set correctly.

Full turn in one direction

1. With the engine at idle and the vehicle unloaded, turn the steering wheel to full travel in one direction until axle stop contact is made. Maximum input torque to be applied during this procedure is 40 lb rim pull (178 N) on a 20 in. (508mm) diameter steering wheel.

NOTE If you encounter excess rim pull effort, allow the vehicle to roll forward or jack up the vehicle at the front axle.

Full turn in other direction

2. Follow the same procedure while turning the steering wheel in the other direction. The poppets are now positioned to trip and reduce pressure as the steered wheels approach the axle stops in either direction.

Maintenance Tips

Never high-pressure wash or steam clean a power steering gear while on or off the vehicle. Doing so could force contaminants inside the gear and cause it to malfunction.

Make sure vehicle wheel cut or clearances meet manufacturer's specifications, and make sure pitman arm timing marks are aligned properly to **prevent internal bottoming** of the steering gear.

Regularly check the fluid and the fluid level in the power steering reservoir.

Keep tires inflated to correct pressure.

Never use a torch to remove pitman arm.

Investigate and immediately **correct the cause of any play, rattle, or shimmy** in any part of the steering system.

Make sure the steering column is aligned properly.

Encourage drivers to report any malfunctions or accidents that could have damaged steering components.

Do not attempt to weld any broken steering component. Replace the component with original equipment only.

Do not cold straighten, hot straighten, or bend any steering system component.

Always **clean off around the reservoir filler cap** before you remove it. Prevent dirt or other foreign matter from entering the hydraulic system.

Investigate and correct any external leaks, no matter how minor.

Replace reservoir filters according to requirements.

If you feel the vehicle is developing excessively **high hydraulic fluid temperatures**, consult with your vehicle manufacturer for recommendations.

Maintain grease pack behind the output shaft dirt and water seal as a general maintenance procedure at least twice a year, in the Spring and Fall. Grease fitting is provided in housing trunnion. Use Exxon Polyrex EP2 (P/N 045422 or NLGI grade 2 or 3 multipurpose chassis lube, and use only a hand operated grease gun on fitting. Add grease until it begins to extrude past the sector shaft dirt and water seal.

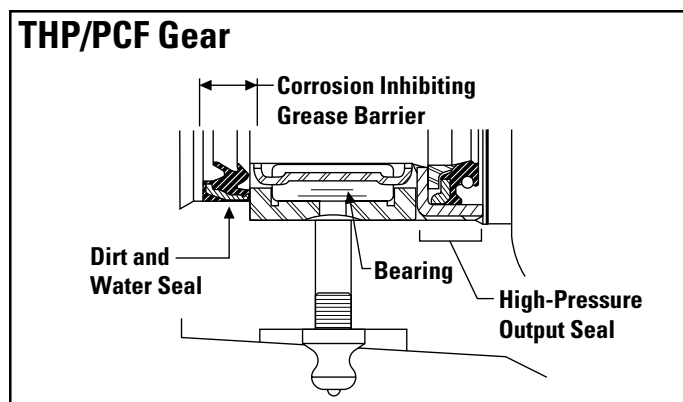

Section 3 **On-Vehicle Service**

Filling and Air Bleeding the System	16
Input Shaft Seal Replacement	17
Sector Shaft Adjustment	21
Poppet Readjustment	
Single Gears	23
Dual Gears	26
Mirror Image	27
Reversed Image	29

Filling and Air Bleeding the System

Tools Required	Materials Required
$\frac{5}{16}$ " Socket in•lb Torque wrench	Hydraulic fluid

CAUTION Make sure poppets are set correctly before beginning this procedure.

Run engine for 10 seconds, turn off and fill reservoir

1. Fill the reservoir nearly full. Do not steer. Start and run the engine for 10 seconds, then shut it off. Check and refill the reservoir. Repeat at least three times, checking the reservoir each time.

Hydraulic fluid

CAUTION Do not allow the fluid level to drop significantly or run out of the reservoir. This may induce air into the system.

Run engine for 2 minutes, turn off and fill reservoir

2. Start the engine and let it idle for 2 minutes. Do not steer. Shut off the engine and check the fluid level in the reservoir. Refill as required.

Hydraulic fluid

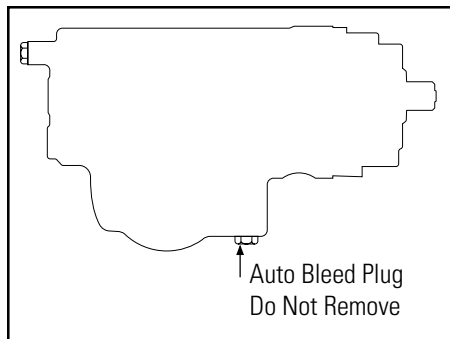

Steer vehicle

3. Start the engine again. Steer the vehicle from full left to full right several times. Add fluid, as necessary, to the full line on the dip stick.

Automatic bleed systems should now be free from trapped air. **Manual bleed systems continue with step 4.**

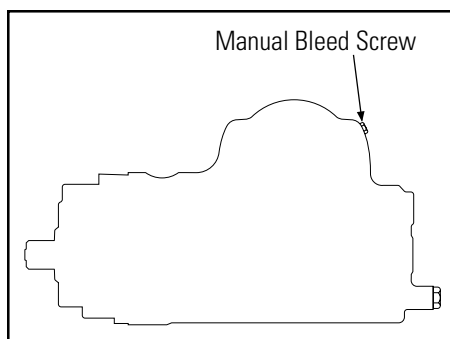

Allow air to bleed out from bleed screw

4. With engine idling, steer from full left turn to full right turn several times. Stop steering and loosen the manual bleed screw about one turn. Allow air and aerated fluid to "bleed out" until only clear fluid is seen. Close the bleed screw, refill the reservoir if required.

in•lb Torque wrench
 $\frac{5}{16}$ " Socket

Repeat step 4 three to four times until all the air is discharged. Torque manual bleed screw to **45 in•lb**.

CAUTION Do not turn steering wheel with bleed screw loosened.

Input Shaft Seal Replacement

Tools Required

Hammer
J37073 Seal Driver
Screwdriver

Materials Required

Clean cloth
Drip pan
High pressure fitting
Hydraulic fluid
Plug
Shop towel

This procedure uses the vehicle's power steering pump to force out the input shaft seal. To use this procedure, the power steering pump should have a minimum of 1,500 psi available.

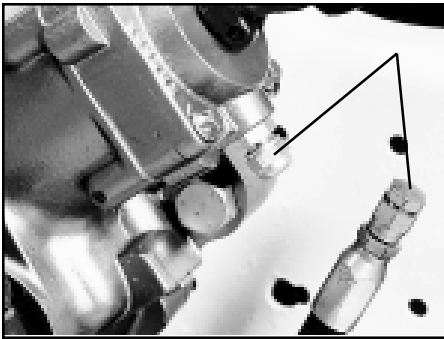

Disconnect return line

High pressure fitting
Plug

1. Disconnect return line from the steering gear and plug the line. Also cap the return port of the gear with a high pressure fitting.



Disconnect column

2. Remove the steering column from the gear input shaft.

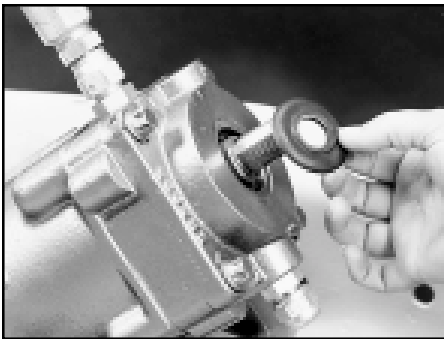

Remove dirt & water seal

3. Remove the dirt and water seal from the steering gear. Save this seal to match the new seal to the correct size.

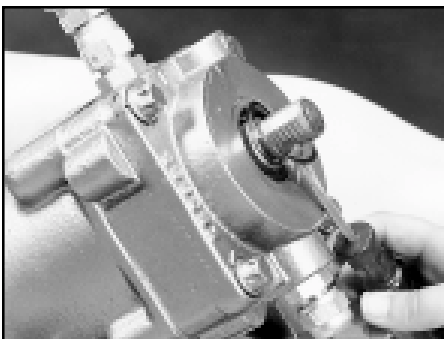

Remove retaining ring

Clean cloth
Screwdriver

4. Wipe out the grease and then remove the spiral retaining ring. Use a screwdriver inserted into the notch formed in the end of the ring. Be careful not to scratch the bore with the screwdriver.

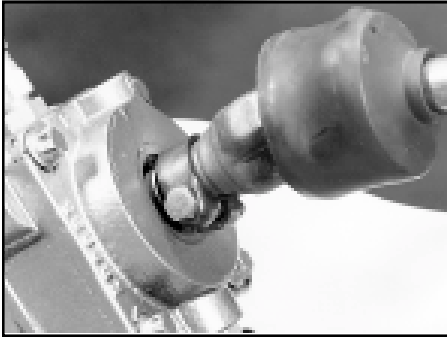

Replace column

- 5. Slip the steering column back onto the input shaft with the pinch bolt installed, but not tightened.

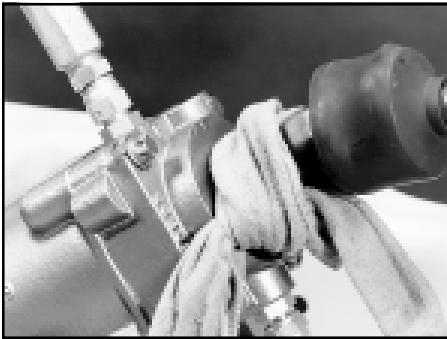

Wrap exposed area

Drip pan
Shop towel

- 6. Tie or wrap a shop towel around the input shaft area and place a drip pan under the vehicle to catch the oil.



Fill reservoir

Hydraulic fluid

- 7. Add fluid as necessary, to the full line on the dipstick. Do not mix fluid types.

⚠ WARNING Any mixture of fluid types, or use of any unapproved fluid could lead to seal deterioration and leaks. A leak could ultimately cause the loss of fluid, which could result in a loss of power steering assist.

Force out the seal

- 8. With the vehicle in neutral, momentarily turn the starter (quickly turn off the engine if it starts).



Remove input shaft seal

- 9. Remove the shop towel. Disconnect the steering column, and remove the input shaft seal.

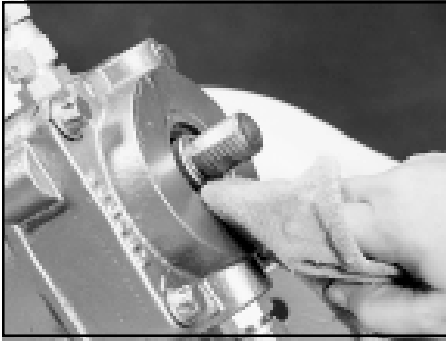

Inspect seal area

- 10. Check the seal area of the valve housing for any seal fragments. Remove any that are found.



Inspect old seal

- 11. Check the seal for heat damage. If the seal is stiff and brittle, and not pliable like the new seal, it is probably heat damaged. Determine and fix the cause of excessive heat in the vehicle.



Install new seal

Hammer
J37073 Seal
Driver

- 12. Put clean grease 045422 on the inside dia. of the new input shaft seal, and place it over the input shaft. With the small dia. of tool J37073 against the seal, tap the tool until the tool shoulder is square against the valve housing. Remove any seal material that may have sheared off in the seal bore or retaining ring groove.

CAUTION Do not use a socket to install this seal because you will not be able to control seal installation depth, possibly causing a leak.



Install retaining ring

- 13. Insert new retaining ring into the groove.



Install dirt & water seal

- 14. Pack the end of the valve housing bore around the input shaft with grease 045422. Choose the correct size dirt & water seal by comparing the choices to the old seal, or by measuring the major diameter of the input shaft serrations (see chart next page). Apply more grease 045422 to the new dirt & water seal and install it over the input shaft. Seat it in the groove behind the serrations and against the valve housing.

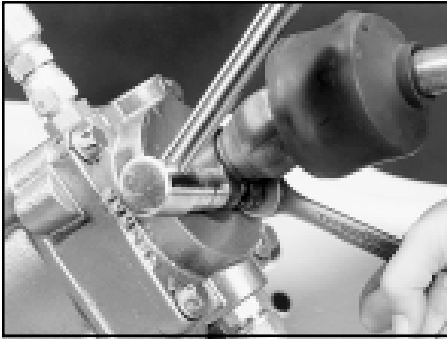

- Reconnect column** 15. Reconnect the steering column to the input shaft and tighten the pinch bolt to torque level specified.

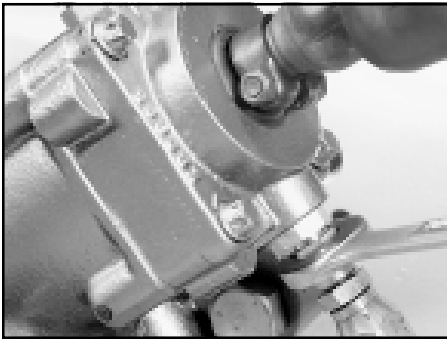

- Reconnect return line** 16. Reconnect the return line to the steering gear return port.

- Air bleed system** 17. Air bleed the system using the procedure on pg. 16.

Seal Part No.	Serration Size	Major Serration Dia.
478044	13/16" x 36	0.807 / 0.799
478060	7/8 x 36	0.866 / 0.857
478050	1" x 36	0.987 / 0.977
478050	1" x 79	1.008 / 1.000

Sector Shaft Adjustment

Tools Required

Screwdriver
3/4" Socket
3/4" Open end wrench

Materials Required

This adjustment can only be completed on the vehicle if the adjusting screw jam nut is accessible. This nut is located on the side cover.

Photos in this section were taken on a mock frame rail for clarity.



Center the sector shaft

1. With the engine on, rotate the steering wheel (input shaft) until the timing mark on the sector shaft lines up with the mark on the housing. The line on the sector shaft should be at a 90° angle from the input shaft. The sector shaft is now on its "center of travel". Turn the vehicle off.

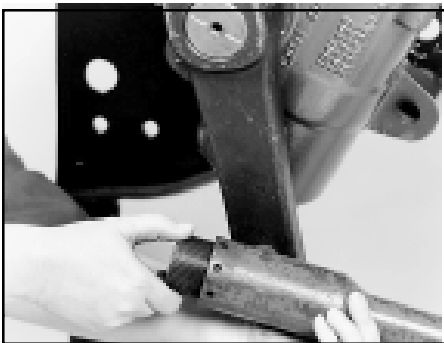

Remove the drag link

2. Remove the drag link from the pitman arm.

CAUTION To avoid resetting the poppets, do not rotate the input shaft more than 1½ turns from the "center of travel" position while the drag link is disconnected.

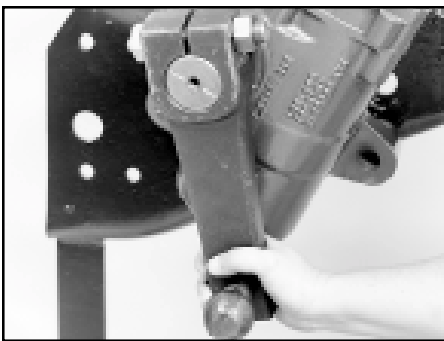

Check for sector shaft lash

3. From the "center of travel" position, grasp the pitman arm and gently try to rotate it back and forth. If looseness or lash is felt at this point, the sector shaft is out of adjustment.



Loosen jam nut

3/4" Socket

4. Loosen the jam nut.

NOTE If the gear is removed from the vehicle to adjust the lash:

- Leave the pitman arm connected to the gear.
- Best option is to follow the Final Adjustment procedure on page 62.
- Alternate option is to continue with step 5 of this procedure.

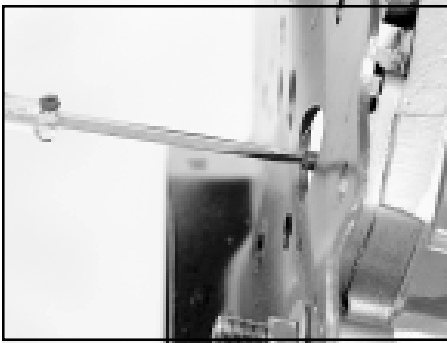

Position adjusting screw

Screwdriver

5. If no lash was detected in step 3, turn the shaft adjusting screw counterclockwise until you feel lash at the output shaft.



Adjust shaft

Screwdriver
3/4" Open end wrench

6. Slowly turn the shaft adjusting screw clockwise until you feel no lash at the output shaft without using more than **10 ft•lb** (14 N•m) of torque. From this position, turn the screw clockwise 1/8 to 3/16 of a turn more. Hold the adjusting screw in place, and tighten the jam nut. Final jam nut torque **43 ft•lb** (58 N•m).

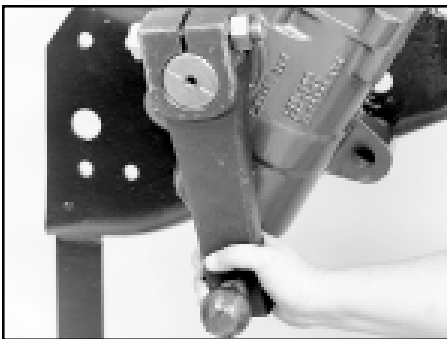

Recheck for lash

7. Turn the steering wheel 1/4 turn each side of center, then back to center and recheck the pitman arm for lash. You should feel no lash; if there is lash, repeat steps 4, 6 and 7.



Connect drag link

8. Reconnect the drag link to the pitman arm according to manufacturer's specifications.

CAUTION Maintain grease in the sector shaft bearing through the grease fitting in the housing using only a hand operated grease gun. Add grease until it begins to extrude past the dirt and water seal. Do not use a power grease gun because it will supply grease too fast; this could adversely affect the high pressure seal and contaminate the hydraulic fluid.

Poppet Readjustment - Single Gears

Tools Required

THP/PCF45	¾" Open end wrench
6mm Allen wrench	¾" Socket
19mm Open end wrench	⅝" Open end wrench
19mm Socket	ft•lb Torque wrench
18mm Open end wrench	Materials Required
THP/PCF60	Hydraulic fluid
⅞" Allen wrench	Jack

This resetting procedure will work in most cases with at least 1¾ hand-wheel-turns from each side of center. If you're making a large reduction in wheelcut and this procedure does not work, you may have to replace or internally reset the poppets using the procedure described in the Poppet Component section of this Service Manual.



Set axle stops, warm-up system

1. Set the axle stops to vehicle manufacturer's wheelcut or clearance specifications.

Start the engine and allow the vehicle to idle for 5-10 minutes to warm the hydraulic fluid. Shut off the engine.

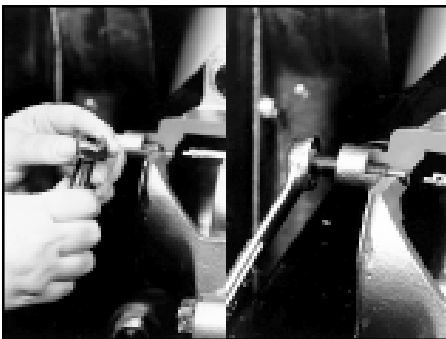

Assemble adjusting screw into nut

2. If a new poppet adjusting screw and nut are being used, turn the screw into the non-sealing end of the jam nut until the drive end of screw is flush with the nut.

Your steering gear will have either a fixed stop bolt or an adjusting screw. If the adjusting screw is already part of the steering gear, back the nut off of the adjusting screw until it is flush with the end of the adjusting screw.

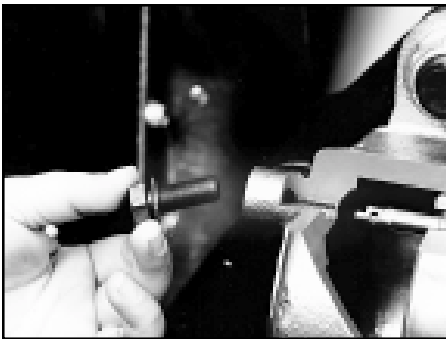

Remove poppet stop bolt

THP/PCF45
18mm Open end wrench
THP/PCF60
⅝" Open end wrench

3. Make sure the engine is off and the road wheels are in straight ahead position. Remove and discard the poppet fixed stop bolt (if equipped) and washer (if equipped) from the lower end of the housing.

If the unit has a poppet adjusting screw and sealing nut that need to be replaced, remove and discard them.

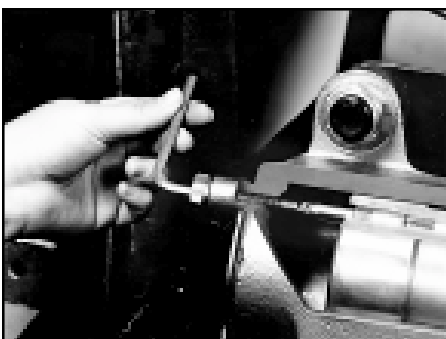

Turn adjusting screw assembly into housing

THP/PCF45
6mm Allen wrench
19mm Wrench
THP/PCF60
⅞" Allen wrench
¾" Wrench

4. Turn the adjusting screw and sealing nut assembly, without rotating the nut on the screw, into the housing until the nut is firmly against the housing using a 6mm (THP/PCF45) or ⅞" (THP/PCF60) Allen wrench. Tighten the sealing nut against the housing.

CAUTION If the drive end of the screw is below the face of the nut, the poppet seat flange will break during step 7d.



Refill reservoir

Hydraulic fluid

5. Refill the system reservoir with approved hydraulic fluid.

CAUTION Do not mix fluid types. Mixing of transmission fluid, motor oil, or other hydraulic fluids will cause seals to deteriorate faster.

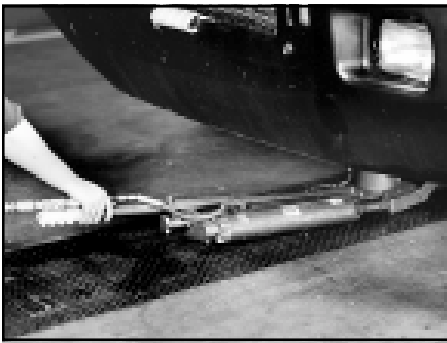

Jack up vehicle

Jack

6. Place a jack under the center of the front axle and jack up the front end of the vehicle so the steer axle tires are off the ground.

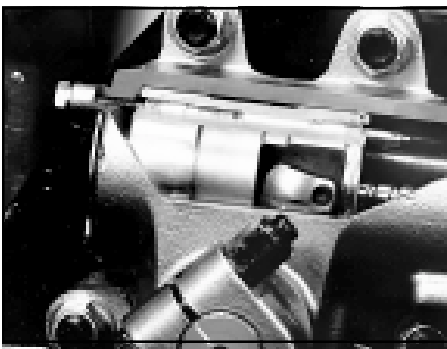

Push upper poppet out to prepare it for setting

7.
 - a) Start the engine and let it run at idle speed.
 - b) Note which output shaft timing mark is nearest the housing piston bore.
 - c) Turn the steering wheel in the direction that makes this timing mark move toward the adjusting screw just installed. Turn in this direction until axle stop contact is made.
 - d) Pull hard on the steering wheel (put up to 40 lb rim pull on a 20" dia. steering wheel) after the axle stop is contacted.

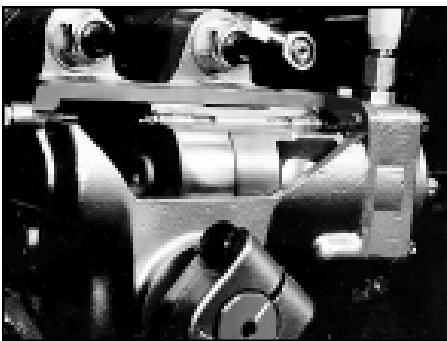

Set upper poppet

8.
 - a) Turn the steering wheel in the opposite direction (end of timing mark away from adjusting screw) until the other axle stop is contacted.
 - b) Pull hard on the steering wheel (put up to 40 lb rim pull on a 20" dia. steering wheel).
 - c) Release the steering wheel and shut off the engine.

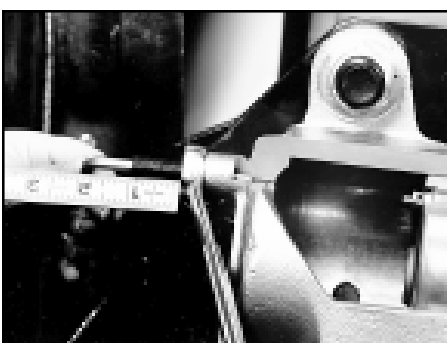

Back out adjusting screw

THP/PCF45
6mm Allen wrench
19mm Wrench
THP/PCF60
7/32" Allen wrench
3/4" Wrench

9. Loosen the sealing nut and back out the adjusting screw until 1" is past the nut. Tighten the sealing nut against the housing.

CAUTION Do not hold the steering wheel at full turn for more than 10 seconds at a time; the heat build-up at pump relief pressure may damage components.



Set lower poppet

10. **a)** Start the engine and let it idle.
- b)** Turn the steering wheel in the original direction (end of timing mark toward adjusting screw), until axle stop contact is made.
- c)** Hold the steering wheel in this position (with up to 40 lb rim pull) for 10 seconds, then release. Repeat this hold and release process as many times as necessary while completing step 11.



Position adjusting screw

THP/PCF45
 6mm Allen wrench
 19mm Wrench
 19mm Socket
 THP/PCF60
 7/32" Allen wrench
 3/4" Wrench
 3/4" Socket
 ft•lb Torque wrench

11. **a)** With steering wheel held tightly at full turn loosen the jam nut and hold it in place with a wrench.
 - b)** Turn the adjusting screw in (clockwise) using **finger-pressure only (don't use a ratchet)**, until the Allen wrench stops. Do not attempt to turn it in further. Pause the turning-in process each time the driver releases the steering wheel; continue turning only while the wheel is held at full turn.
 - c)** Back off the adjusting screw 3/4 turns and tighten the sealing nut. Torque sealing nut to **35 ft•lb.** (48 N•m)
12. The poppets have now been completely reset. Lower the vehicle. Check the reservoir and fill if required.

The procedure is complete

⚠ WARNING The length of the adjusting screw beyond the nut must be no more than 1/16" for proper thread engagement.

NOTE The length of adjusting screw beyond the sealing nut may be different for each vehicle.

Poppet Readjustment - Dual Gears

Mirror Image Systems and Reversed Image Systems

Before setting poppets on a dual gear system, you must determine whether the system has mirror image gears or reversed image gears. The procedures are slightly different for each type of system.

1. Park the vehicle with the wheels turned all the way to the axle stop in either direction. Turn the vehicle off.
2. Look at the output shaft timing mark nearest the housing piston bore on the master gear. Is this mark pointing toward the poppet screw or away from it?
3. Now check the same timing mark on the rotary cylinder. Does it point toward the poppet screw or away from it?

If they point to opposite ends of the gears you have a mirror image system, see pg. 27.

If they both point toward the poppet screws or both point toward the end opposite the poppet screws, you have a reversed image system, see pg 29.

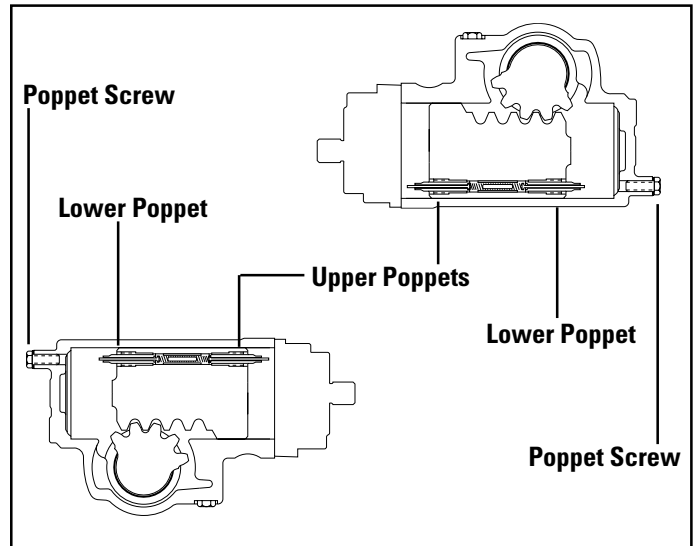

Poppet Readjustment - Dual Gears - Mirror Image

Tools Required

THP/PCF45	¾" Open end wrench
6mm Allen wrench	¾" Socket
19mm Open end wrench	⅝" Open end wrench
19mm Socket	ft•lb Torque wrench
18mm Open end wrench	
THP/PCF60	Hydraulic fluid
⅞" Allen wrench	Jack

Materials Required

This resetting procedure will work in most cases with at least 1¾ hand-wheel-turns from each side of center. If you're making a large reduction in wheelcut and this procedure does not work, you may have to replace or internally reset the poppets using the procedure described in the Poppet Component section of this Service Manual.

1. Set the axle stops to vehicle manufacturer's wheelcut or clearance specifications.

Start the engine, and allow the vehicle to idle for 5-10 minutes to warm the hydraulic fluid. Shut off the engine.

2. If new poppet adjusting screws and nuts will be used, turn each screw into the non-sealing end of the jam nut until the drive end of screw is flush with the nut.

Your steering gear and rotary cylinder will both have either fixed stop bolts or adjusting screws. If the adjusting screw is already part of the gear or cylinder, back the nut off of the adjusting screw until it is flush with the end of the adjusting screw.

3. Make sure the engine is off and the road wheels are in straight ahead position. Remove and discard the poppet fixed stop bolt (if equipped) and washer (if equipped) from the lower end of housing on both the gear and the cylinder.

If either unit has a poppet adjusting screw and sealing nut that need to be replaced, remove and discard them.

4. On both the master gear and the rotary cylinder, turn the adjusting screw and sealing nut assembly, without rotating the nut on the screw, into the housing until the nut is firmly against the housing using a 6mm (THP/PCF45) or ⅞" (THP/PCF60) allen wrench. Tighten the sealing nut against the housing.

5. Refill system reservoir with approved hydraulic fluid.

CAUTION Do not mix fluid types. Mixing of transmission fluid, motor oil, or other hydraulic fluids will cause seals to deteriorate faster.

6. Place a jack under the center of the front axle and jack up the front end of the vehicle so the steer axle tires are off the ground.

7.
 - a) Start the engine and let it run at idle speed.

- b) Turn the steering wheel in the direction that makes the timing mark on the master gear move toward the adjusting screw just installed. Turn in this direction until axle stop contact is made.

- c) Pull hard on the steering wheel (put 40 lbs. rim pull on a 20" dia. steering wheel) after the axle stop is contacted.

8.
 - a) Turn the steering wheel in the opposite direction (end of timing mark on the master gear away from adjusting screw) until the other axle stop is contacted.

- b) Pull hard on the steering wheel (put 40 lbs. rim pull on a 20" dia. steering wheel).

- c) Release the steering wheel and shut off the engine.

9. Loosen the sealing nut and back out the adjusting screw on the master gear until 1" is past the nut. Tighten the sealing nut against the housing.

CAUTION Do not hold the steering wheel at full turn for more than 10 seconds at a time; the heat build-up at pump relief pressure may damage components.

10.
 - a) Start the engine and let it idle.

- b) Turn the steering wheel in the original direction (end of timing mark on the gears toward adjusting screw), until axle stop contact is made.

- c) Hold the steering wheel in this position (with 40 lbs. rim pull) for 10 seconds, then release. Repeat this hold and release process as many times as necessary while completing steps 11 & 12.

11. **a)** With steering wheel held at full turn, loosen the jam nut on the master gear and hold it in place with a wrench.
- b)** Turn the adjusting screw in (clockwise) using **finger- pressure only** (don't use a ratchet), until the Allen wrench comes to a stop. Do not attempt to turn it in farther. Pause the turning-in process each time the driver releases the steering wheel; Continue turning only while the wheel is held at full turn.
- c)** Back off the adjusting screw 3¼ turns and tighten the sealing nut. Torque the sealing nut to **33-37 ft•lb.** (45-50 N•m)
- d)** Release the steering wheel and shut off the engine.
12. Loosen the sealing nut and back out the adjusting screw on the rotary cylinder until 1" is past the nut. Tighten the sealing nut against the housing.
13. **a)** Start the engine and let it idle.
- b)** Turn the steering wheel in the opposite direction (end of timing mark on master gear away from adjusting screw), until axle stop contact is made.
- c)** Hold the steering wheel in this position (put up to 40 lb. rim pull on a 20" dia. steering wheel) for 10 seconds, then release. Repeat this hold and release process as many times as necessary while completing step 14
14. **a)** With steering wheel held at full turn, loosen the jam nut on the rotary cylinder and hold it in place with a wrench.
- b)** Turn the adjusting screw in (clockwise) using **finger- pressure only** (don't use a ratchet), until the Allen wrench comes to a stop. Do not attempt to turn it in farther. Pause the turning-in process each time the driver releases the steering wheel; Continue turning only while the wheel is held at full turn.
- c)** Back off the adjusting screw 3¼ turns and tighten the sealing nut. Torque the sealing nut to **33-37 ft•lb.** (45-50 N•m)
- d)** Release the steering wheel and shut off the engine.
15. The poppets have now been completely reset. Lower the vehicle . Check the reservoir and fill if required.

 WARNING	The length of the adjusting screw beyond the nut must be <u>no more than 1/16"</u> for proper thread engagement.
--	---

NOTE	The length of adjusting screw beyond the sealing nut may be different for each vehicle.
-------------	---

Poppet Readjustment - Dual Gears - Reversed Image

Tools Required

THP/PCF45	¾" Open end wrench
6mm Allen wrench	¾" Socket
19mm Open end wrench	⅝" Open end wrench
19mm Socket	ft•lb Torque wrench
18mm Open end wrench	Materials Required
THP/PCF60	Hydraulic fluid
⅞" Allen wrench	Jack

This resetting procedure will work in most cases with at least 1¾ hand-wheel-turns from each side of center. If you're making a large reduction in wheelcut and this procedure does not work, you may have to replace or internally reset the poppets using the procedure described in the Poppet Component section of this Service Manual.

1. Set the axle stops to vehicle manufacturer's wheelcut or clearance specifications.

Start the engine, and allow the vehicle to idle for 5-10 minutes to warm the hydraulic fluid. Shut off the engine.

2. If new poppet adjusting screws and nuts are being used, turn the screws into the non-sealing end of the jam nuts until the drive end of screw is flush with the nut.

Your steering gear and rotary cylinder will have either fixed stop bolts or adjusting screws. If the adjusting screw is already part of the steering gear or cylinder, back the nut off of the adjusting screw until it is flush with the end of the adjusting screw.

3. Make sure the engine is off and the road wheels are in straight ahead position. Remove and discard the poppet fixed stop bolts (if equipped) and washers (if equipped) from the lower end of housing on both the master gear and the rotary cylinder.

If the unit has poppet adjusting screws and sealing nuts that need to be replaced, remove and discard them.

4. Turn the adjusting screws and sealing nut assemblies, without rotating the nut on the screw, into the housing until the nut is firmly against the housing, on both the master gear and the rotary cylinder, using a6mm (THP/PCF45) or ⅞" (THP/PCF60) allen wrench. Tighten the sealing nut against the housing.

5. Refill system reservoir with approved hydraulic fluid.

CAUTION Do not mix fluid types. Mixing of transmission fluid, motor oil, or other hydraulic fluids will cause seals to deteriorate faster.

6. Place a jack under the center of the front axle and jack up the front end of the vehicle so the steer axle tires are off the ground.

7.
 - a) Start the engine and let it run at idle speed.

- b) Note which output shaft timing mark is nearest the housing piston bore.

- c) Turn the steering wheel in the direction that makes this timing mark move toward the adjusting screws just installed on both the gear and the cylinder. Turn in this direction until axle stop contact is made.

- d) Pull hard on the steering wheel (put 40 lbs. rim pull on a 20" dia. steering wheel) after the axle stop is contacted.

8.
 - a) Turn the steering wheel in the opposite direction (end of timing mark away from adjusting screw) until the other axle stop is contacted.

- b) Pull hard on the steering wheel (put 40 lbs. rim pull on a 20" dia. steering wheel).

- c) Release the steering wheel and shut off the engine.

9. Loosen the sealing nut and back out the adjusting screw until 1" is past the nut on both the master gear and the rotary cylinder. Tighten the sealing nuts against both housings.

CAUTION Do not hold the steering wheel at full turn for more than 10 seconds at a time; the heat build-up at pump relief pressure may damage components.

10.
 - a) Start the engine and let it idle.

- b) Turn the steering wheel in the original direction (end of timing mark toward adjusting screw), until axle stop contact is made.

- c) Hold the steering wheel in this position (with 40 lbs. rim pull) for 10 seconds, then release. Repeat this hold and release process as many times as necessary while completing steps 11 and 12, first on the master gear, then on the rotary cylinder.

11.
 - a) With steering wheel held at full turn, loosen the jam nut on the master gear, and hold it in place with a wrench.
 - b) Turn the adjusting screw in (clockwise) using **finger- pressure only** (don't use a ratchet), until the Allen wrench comes to a stop. Do not attempt to turn it in farther. Pause the turning-in process each time the driver releases the steering wheel; Continue turning only while the wheel is held at full turn.
 - c) Back off the adjusting screw $3\frac{1}{4}$ turns and tighten the sealing nut. Torque nut to **33-37 ft•lb.** (45-50 N•m)

12.
 - a) With steering wheel held at full turn, loosen the jam nut on the rotary cylinder and hold it in place with a wrench.
 - b) Turn the adjusting screw in (clockwise) using **finger- pressure only** (don't use a ratchet), until the Allen wrench comes to a stop. Do not attempt to turn it in farther. Pause the turning-in process each time the driver releases the steering wheel; Continue turning only while the wheel is held at full turn.
 - c) Back off the adjusting screw $3\frac{1}{4}$ turns and tighten the sealing nut. Torque nut to **33-37 ft•lb.** (45-50 N•m)

13. The poppets on both the master gear and rotary cylinder have now been completely reset. Lower the vehicle . Check the reservoir and fill if required.

 WARNING	The length of the adjusting screw beyond the nut must be <u>no more than 1/16"</u> for proper thread engagement.
--	---

NOTE	The length of adjusting screw beyond the sealing nut may be different for each vehicle.
-------------	---

Section 4 Reseal & Repair

Disassembly	34
Inspection	42
Assembly	44
Internal Damage Repair (by reference)	
Poppet Component Replacement	51
Valve Housing Worm Screw Disassembly	53
Roller Bearing or Retaining Ring Replacement	60
Replace Housing Port Plugs, Screws, and Fittings ..	61
Final Adjustments	63

Disassembly Preparation

Stop the vehicle with wheels pointed straight ahead.

Clean off all outside dirt from around fittings and hose connections before you remove the gear.

Remove input and output shaft connections per vehicle manufacturer's instructions.

⚠ WARNING When using a chisel to spread a pinch bolt-type pitman arm boss for assembly or removal from the shaft, maintain a firm grip on the chisel at all times. Failure to do this may result in the chisel flying loose which could cause an injury. Never leave the chisel wedged in the pitman arm boss. If you cannot remove the pitman arm from the shaft with a chisel and your hands, remove the chisel from the arm boss and use a puller only to remove pitman arm.

⚠ CAUTION Do not use a hammer on the pitman arm to remove it from sector shaft as internal damage to steering gear could result. Be sure there is no spreading wedge left in the pitman arm boss before tightening pitman arm clamp bolt after assembly on sector shaft. Do not pound the universal joint or input shaft coupling on or off the input shaft as internal damage to the steering gear can result.

⚠ CAUTION Unless the poppet adjuster seat and sleeve assemblies (27) are to be removed and replaced or reset for automatic poppet adjustment, or a manual adjustment with a service poppet adjuster screw (38A) and nut (38B) is anticipated, do not allow the input shaft on a steering gear with the automatic poppet adjustment feature to rotate more than 1.5 input shaft revolutions from "straight ahead position" when the output shaft is disconnected from the vehicle steering linkage; this could disrupt the poppet setting achieved at initial installation. The steering gear is in the "straight ahead position" when the timing marks on the end of the housing trunnion and sector shaft are aligned.

Remove the supply and return lines from the gear, and immediately plug all port holes and fluid lines.

⚠ WARNING THP/PCF steering gears can weigh up to 70 pounds dry. Exercise caution when you remove, lift, carry, or fix in a bench vise.

Remove the steering gear from the vehicle and take it to a clean work surface.

Clean and dry the gear before you start to disassemble it.

As you disassemble the gear, clean all parts in clean, OSHA approved solvent, and air blow-dry them only.

⚠ WARNING Because they are flammable, be extremely careful when using any solvents. Even a small explosion or fire could cause injury or death.

⚠ WARNING Wear eye protection and be sure to comply with OSHA or other maximum air pressure requirements.

⚠ CAUTION Never steam clean or high-pressure wash hydraulic steering components. Do not force or abuse closely fitted parts. Use care that bearing and sealing surfaces are not damaged by the assembly and disassembly procedures.

Keep each part separate to avoid nicks and burrs.

Discard all seals, o-rings, and gaskets removed from the gear. Replace them with new parts only.

The steering gear should be identified to the vehicle from which it was removed. The poppet adjuster seat and sleeve assemblies are set for that particular vehicle only.

Disassembly

Tools Required		Materials Required
Allen wrenches	Screwdriver	Emery cloth
Pocket knife	Sockets:	Masking tape
Ratchet	•Standard	
Rolling head pry bar	•Torx	
Rubber mallet	Vise	

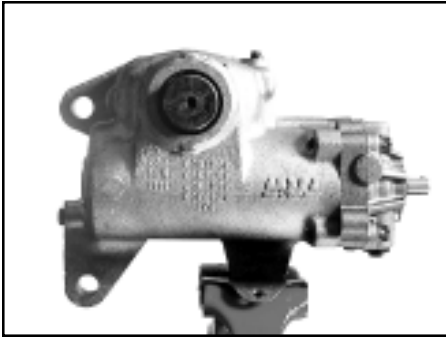

Position gear in vise

1. Put the steering gear in a vise, clamping firmly against the housing mounting flange or boss. Input shaft should be horizontal; side cover and valve housing are accessible for disassembly.

CAUTION Do not clamp against body of housing. If mounting boss or flange is not accessible, fabricate and attach a mounting plate to the housing mounting bosses.

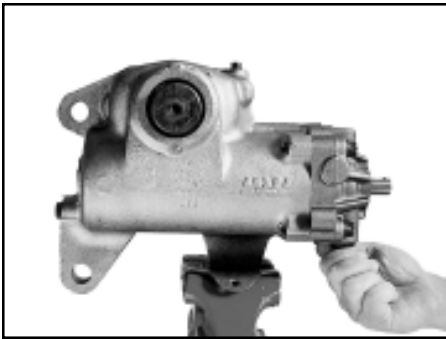

Unplug ports

Appropriate size socket or open-end wrench

2. Prepare for fluid drainage and unplug hydraulic ports.

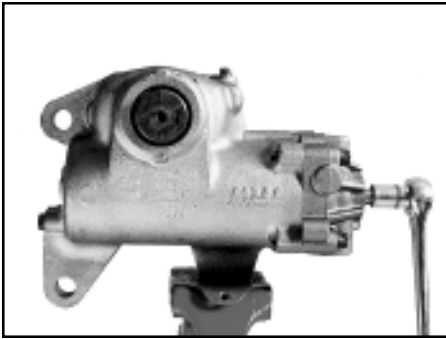

Position sector shaft

3. Rotate the input shaft until the timing mark on the end of the sector shaft is in line with the timing mark on the end of the housing. This will position the sector shaft for removal.



Clean sector shaft

Fine grade emery cloth

4. Remove any paint or corrosion from the exposed area of the sector shaft (41).

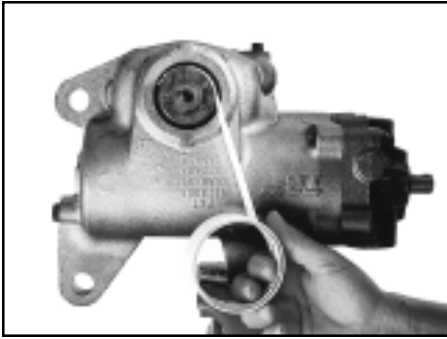

Tape sector shaft

Masking tape

5. Tape the serrations and bolt groove of the sector shaft with one layer of masking tape. The tape should not extend onto the sector shaft bearing diameter.

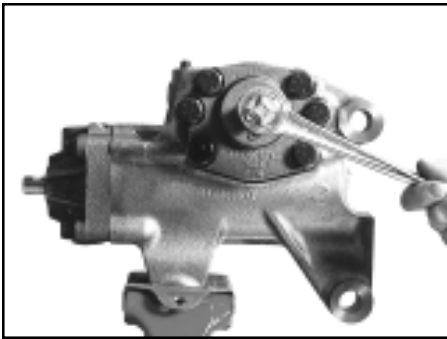

Remove jam nut

3/4" Socket

6. Remove the sector shaft adjusting screw jam nut (46).



Remove side cover bolts

1 5/16" Socket

7. Be prepared for more fluid drainage and remove the six bolts (48) from the side cover (45).



Remove side cover

Soft mallet

8. Be prepared for more fluid drainage and remove the side cover and sector shaft assembly from the gear. You may start the shaft and cover assembly removal by tapping the end of the shaft lightly with a soft mallet or wooden hammer handle.



Discard O-ring

9. Remove and discard the side cover o-ring (44).

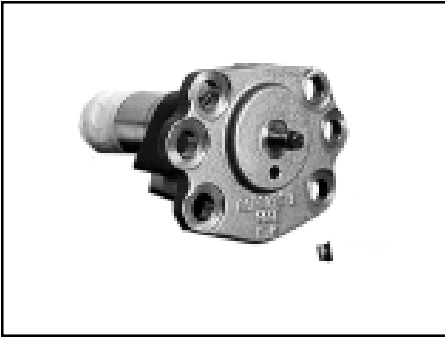

Remove vent plug

10. Remove and discard the vent plug (47).



Remove sector shaft from cover

11. Turn sector shaft adjusting screw (41A) clockwise through the side cover and pull the sector shaft out of the side cover.

Screwdriver

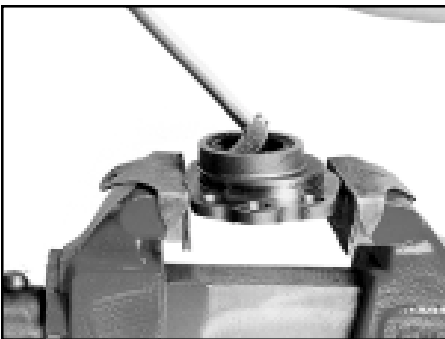

Remove side cover seal and washer

12.

CAUTION Don't damage the bore or bearing when removing the seal.

3/8" Drive socket
Rolling head pry bar

Clamp the side cover in a vise. Place a standard 5/8" or 1 1/16" - 3/8" drive socket in the center of the side cover. Pry the seal (40) out with a rolling head pry bar, using the socket for support. Discard the seal and remove the socket. Remove washer (42).



Inspect adjusting screw and retainer

13. Inspect the sector shaft assembly for damaged adjusting screw threads. The retainer (41B, not shown) must be securely staked in place. The adjusting screw must rotate by hand with no perceptible end play (lash).

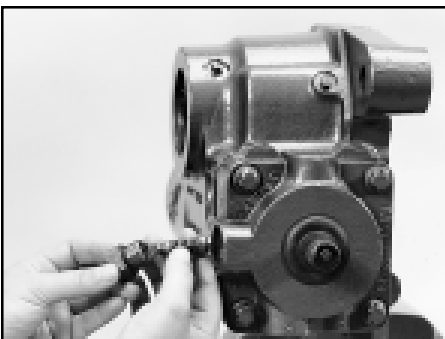

Remove relief valve components

14. If equipped, remove relief valve cap (10), o-ring (9) and two-piece relief valve (8) from the valve housing. Discard the o-ring.

7/8" Socket

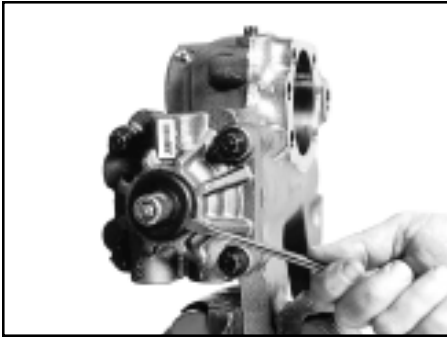

Remove dirt & water seal

- 15. Remove and discard the dirt & water seal (2, 2B or 2C) from the input shaft worm and valve assembly. Save this seal for comparison with the new seal.

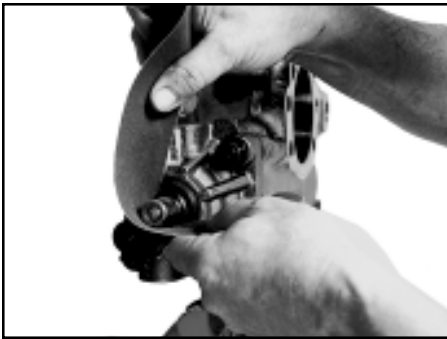

Clean input shaft

Fine grade emery cloth

- 16. Clean any paint or corrosion from the exposed area of the input shaft.



Remove valve housing bolts

E-18 Torx socket

- 17. Remove the four torx head valve housing bolts (1).

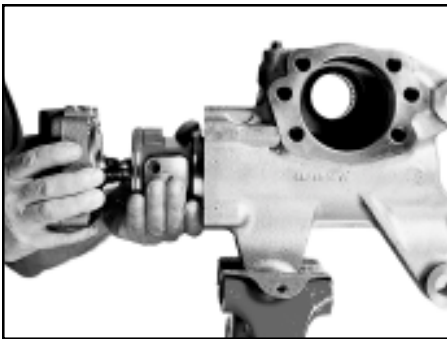

Remove valve housing, worm and rack subassembly

- 18. Be prepared for more fluid drainage and remove the rack piston subassembly. Place the assembly on a clean cloth.

CAUTION The set position of poppet seat and sleeve assemblies (27) must not be disturbed if the poppets are not going to be replaced or reset during disassembly.



Remove seals

- 19. Remove and discard the valve housing seal rings (11 & 13).

CAUTION Do not remove the input shaft, valve worm assembly or balls from the rack piston until the ball return guides are removed as damage to the ball guides will occur.

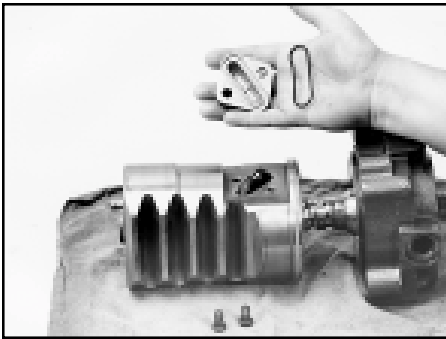

Remove ball return guide cap

T-30 Torx wrench

20. Remove and discard the two special sealing screws (33). Remove the ball return cap (32) and seal (31), discard the seal.



Remove ball return guides

Screwdriver

21. Make sure the rack piston is on a cloth so the steel balls that fall out won't roll very far. Remove ball return guide (30) by carefully inserting a screwdriver between the rack piston and guides.

NOTE Left hand ball return guide halves are plated with copper or zinc chromate for identification. Right hand guides are not plated. **Retain the guides for reassembly.**



Remove steel balls

22. Remove the steel balls (29) from the rack piston (28) by rotating the input shaft, valve worm assembly until the balls fall out. Place the balls and return guides in a cup or other container. Count the balls, and make sure all have been removed.

CAUTION The steel balls are a matched set. If any are lost, the set must be replaced by service balls. Number of factory balls installed: THP/PCF45 - 29 balls, THP/PCF60 - 31 balls.



Separate rack piston from worm subassembly

23. Remove the input, worm, and valve housing subassembly from the rack piston.



Remove seal ring and o-ring

Pocket knife

24. Cut and remove the Teflon seal ring (23) and o-ring (22) from the rack piston.

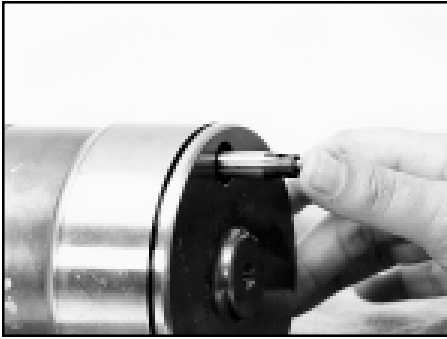

Inspect poppet assemblies

- 25. Push poppet stems, they should spring back. Push poppet seat, it should not move by hand. If components are bent or broken, poppet stems don't spring back, or poppet seat moves by hand, go to **Poppet Component Replacement** section on page 51. Otherwise, proceed to step 26.

NOTE TRW recommends the poppet adjuster seat and sleeve assemblies (27) not be removed unless replacement of poppet components is required.



Inspect valve housing and worm screw

- 26. Inspect valve housing/worm screw subassembly for heat damage or bearing roughness. If these conditions are present, or if there was excessive internal leakage, or if preload adjustment is required, go to **Valve Housing/Worm Screw Disassembly** procedures on page 53. If not, proceed to step 27.

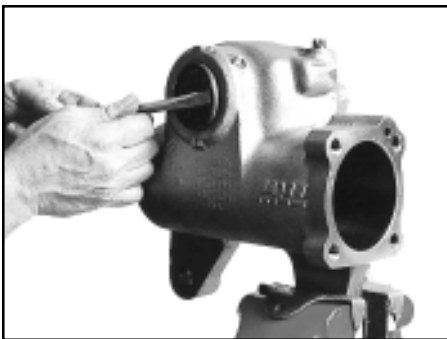

Remove dirt seal

Screwdriver

- 27. Remove and discard the dirt and water seal (40).

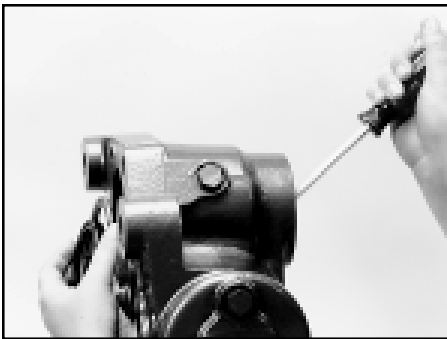

Remove pressure seal

Screwdriver

- 28. Insert a screwdriver through the trunnion opening, and carefully push the seal (40) out **without damaging the sealing area of the bore**. Discard the seal.

NOTE A special hook groove has been machined into the bore to hold the seal in position. Clean out rubber from groove prior to installing new seal.



Inspect roller bearing

- 29. Inspect the roller bearing (39) for brinelling or spalling. If replacement is required, go to **Roller Bearing Replacement** - on page 60. If not, proceed to step 30.



Inspect housing screws, and plugs

30. Inspect the following for damage:

- Poppet fixed stop screw (38)
- Poppet adjusting screw (38A) and sealing nut (38B)
- Auto-bleed plug (37)
- Manual bleed screw (Not shown)
- Auxiliary port plugs (7) and o-rings (6)

If any are damaged, go to **Replace Housing Port Plugs and Screws** on page 61. If not, proceed to the Inspection Section.

Inspection

Make sure all sealing surfaces and seal cavities are free from nicks and corrosion. Any nicked or corroded surface requires part replacement to ensure proper sealing.

Wash all parts in clean, OSHA approved solvent. Air blow them dry only.

⚠ WARNING Because they are flammable, be extremely careful when using any solvents. Even a small explosion or fire could cause injury or death.

⚠ WARNING Wear eye protection and be sure to comply with OSHA or other maximum air pressure requirements.

⚠ WARNING Any of the following conditions present in the steering gear indicates impact damage.

<u>Condition</u>	<u>Area</u>
Brinelling	<ul style="list-style-type: none"> • Ball track grooves of rack piston • Ball track grooves of worm screw • Bearing area of sector shaft • Thrust washer and bearing in valve housing • Ball cup and bearing in valve housing
Cracks or Breaks	<ul style="list-style-type: none"> • Bearing area of sector shaft • Sector shaft teeth • Rack piston teeth • Housing • Thrust washer and bearing in valve housing • Worm screw • Ball cup and bearing in valve housing
Twisted serrations	<ul style="list-style-type: none"> • Output shaft serrations

If one of these conditions is found in one component, be sure to inspect all components carefully for signs of impact damage. Replace components noted in individual inspection steps below if you suspect impact damage. Failure to replace all damaged components could result in a serious vehicle accident.



Inspect rack piston teeth

1. Inspect the rack piston (28) teeth for cracks or obvious damage. If teeth are damaged, replace the rack piston, sector shaft (41) and set of balls (29).



Inspect rack piston and worm ball track grooves

2. Inspect the rack piston (28) ball track grooves for brinelling or spalling. If either condition exists, replace the input shaft valve/worm assembly (15), valve housing (5), rack piston subassembly (28) and balls (29).



Inspect input shaft, valve/worm assembly sealing areas

3. Inspect the sealing area of input shaft and valve (15) for nicks, and damage. Inspect for discoloration from excess heat. Inspect input shaft ball-track grooves for brinelling or spalling. If any of these conditions exist, replace the input shaft, valve worm assembly, valve housing and balls. Also replace rack piston if brinelling or spalling is found.

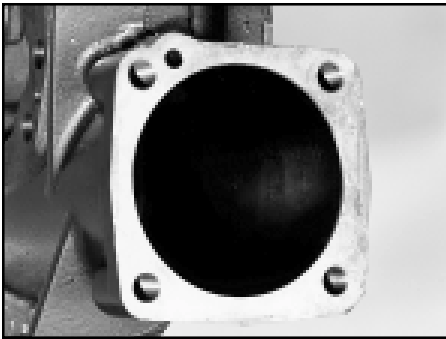

Inspect housing cylinder bore

4. Inspect the housing (34) cylinder bore. Some scoring marks are normal. If there was internal leakage greater than 1.2 gpm (4.5 lpm), make sure there are no damaged seals before replacing the housing.

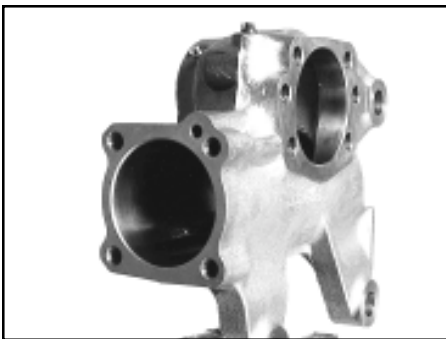

Inspect valve housing surface

5. Inspect the valve housing mating surface for nicks that would prevent proper sealing. Replace the gear housing if these nicks are present and cannot be easily removed with a fine-tooth flat file without changing the dimensional characteristics.



Inspect side cover bearing

6. Inspect roller bearing in side cover assembly (45) for brinelling or spalling. If either condition exists, replace the side cover and bearing assembly.



Inspect sector shaft assembly

7. Inspect the sector shaft (41) bearing and sealing areas and sector teeth contact surfaces for brinelling, spalling or cracks. Run your fingernail edge across these areas to detect steps. Remove masking tape from the shaft and inspect for twisted or otherwise damaged serrations. If any of these conditions exist, replace the sector shaft.

NOTE

A service sector shaft will come assembled with the adjusting screw (41A) and retainer (Not shown).

Assembly Preparation

Wash all parts in clean, OSHA approved solvent. Air blow-dry them only.

WARNING Because they are flammable, be extremely careful when using any solvents. Even a small explosion or fire could cause injury or death.

WARNING Wear eye protection and be sure to comply with OSHA or other maximum air pressure requirements.

Replace all seals, seal rings, and gaskets with new ones each time you disassemble the gear.

TRW Commercial Steering Division makes complete seal kits available. These parts can be purchased through most OEM parts distributors. Contact your local dealer for availability.

Assembly

Tools Required		Materials Required	
Hammer J37705 (THP/PCF45) J37071 (THP/PCF60) Press Punch Ratchet	Screwdriver Sockets Torx sockets Vise Torque wrench	ATF oil Grease (Exxon Polyrex* EP2 Masking tape 14 _{mm} x 2.0 _{mm} All Thread	Seal kit: THP450001 THP600001

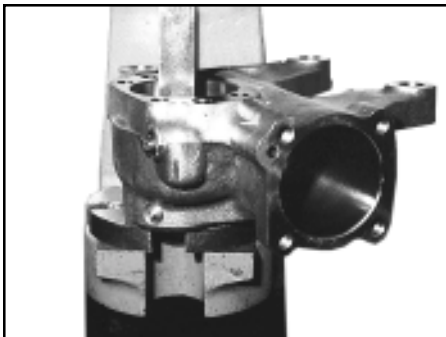

Press seal into housing

J37705
(THP/PCF45)
J37071
(THP/PCF60)

- All gears** - Assemble new seal (40) onto bearing and seal tool (short end) so the lip with the garter spring is toward the shoulder of the tool. Working from the side cover side of the housing, pilot the seal tool into the washer and bearing and press with a force of 100-800 lb (445-3,560 N) until the seal is seated firmly.



Install dirt & water seal

J37071
Press

- Install the dirt & water seal (35) with the bearing and seal tool (long end), making sure it is not cocked. **Press the seal only until it seats against the bearing, don't push it in farther.**

Liberally pack the roller bearing and new seals with clean, high temperature industrial grease, Exxon Polyrex EP (P/N 045422).

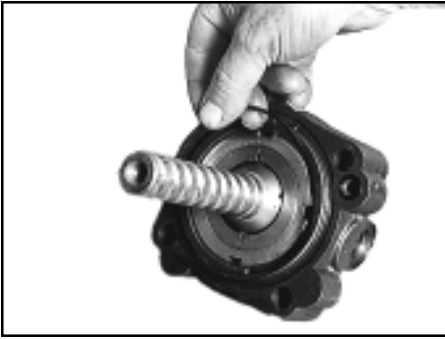

Assemble seal rings

3. Lightly oil new seal ring (11) and assemble in valve housing mounting face groove. Then, oil new seal ring (10) and assemble in valve housing (5) mounting face groove.



Install rack piston o-ring and seal ring

4. Install a new backup o-ring (22) and then a new Teflon seal ring (23) on rack piston (19). Do not over-stretch these rings as you install them. Do not allow the Teflon seal ring to be twisted.



Position rack piston in housing

5. Apply clean oil to housing cylinder bore. Place the rack piston (28) in the housing piston bore with ball return guide holes up.

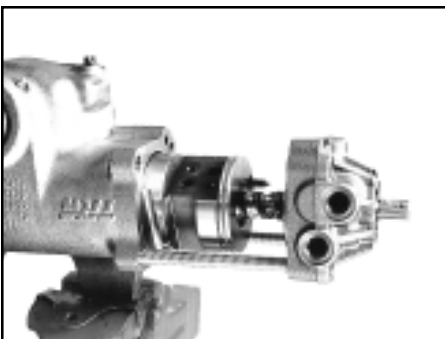

Insert worm and valve assembly into rack piston

14_{mm} x 2.0_{mm}
All Thread

6. Insert the worm screw into the rack piston close to maximum depth, without the valve housing making contact with the poppet stem. Insert two 14 mm x 2.0 mm All Threads through valve housing bolt holes and tighten into housing to support the worm screw. Line up rack piston ball guide holes with the worm ball track grooves by rotating the input shaft.

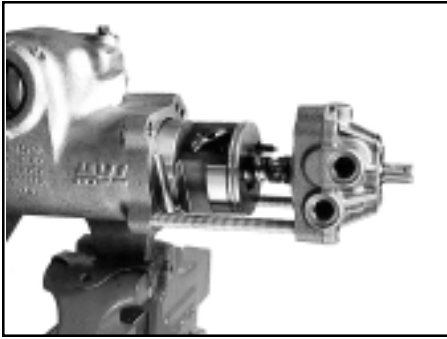

Assemble ball return guide halves

7. Assemble the ball return guide (30) into the rack piston until seated, rotate the input shaft slightly if necessary.

⚠ WARNING Do not seat guides with a hammer. Damage to guides can result in subsequent lockup or loss of steering.

⚠ CAUTION If a new rack piston (28) or a new input shaft, valve, worm subassembly (15) is being assembled, the balls (29) removed from the unit must be discarded and a service ball kit utilized. The balls in a service ball kit are sized to function in the ball track guide path as altered by component replacement.

⚠ CAUTION When using the service ball kit, use the correct quantity of service balls: THP/PCF45 - 29 balls, THP/PCF60 - 31 balls.

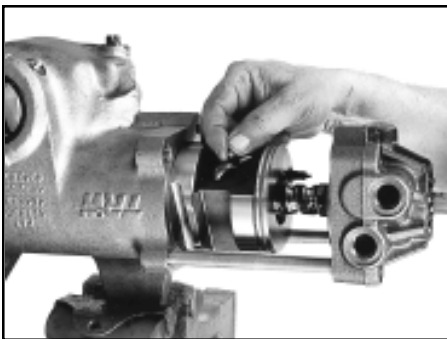

Assemble balls

8. Hold the ball return guide (30) firmly in place during this entire procedure. Insert as many of the steel balls as you can through the hole in the top of the ball return guides. Rotate the input shaft to pull the balls down and around the ball track guide path. Continue until the correct number of balls are in the ball track guide path.

⚠ WARNING Hold down the ball return guides until cap is reinstalled. Failure to hold the guides will result in a trapped ball or balls, which could cause a vehicle accident. If the ball guide becomes unseated (raises) at any time, repeat the procedure starting at step 7.

⚠ WARNING The correct number of balls are required for proper gear operation. Count the balls and insert each carefully as in step 7. Number required: THP/PCF45 - 29 balls, THP/PCF60 - 31 balls.

⚠ CAUTION Do not allow valve housing to contact the poppet stem or move more than 2½ inches (69.1 mm) from upper end of rack piston during these procedures. This could incorrectly reset the poppet, or back out worm beyond closed ball loop, trapping balls.

⚠ CAUTION Remove any fluid present in the two screw holes. Fluid in these holes could cause improper clamp load when torquing the cap.

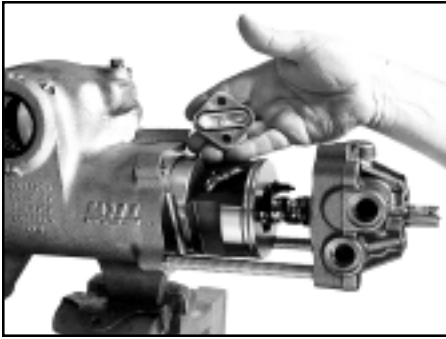

Assemble ball return guide cap

T-30 Torx socket
in•lb Torque wrench
Grease

9. Place a new ball return guide cap seal (31) in the seal groove of the cap (32). Make sure the seal makes full contact with the rack piston surface. Install two new Torx head screws (33) and torque each screw alternately until a final torque of **18 ft•lb** (24.5 N•m) is achieved.

CAUTION Ball cap seal is greased to hold seal in groove while assembling. Be sure not to trap the seal outside of the groove during reassembly.

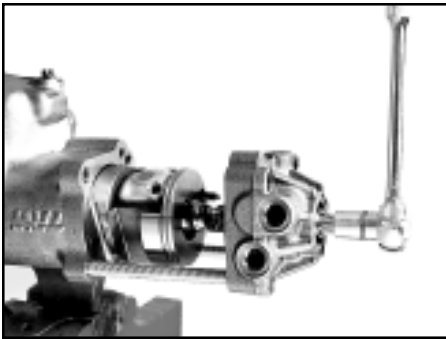

Rotate input shaft to check for proper installation of balls

10. Rotate the input shaft from one end of travel to the other without contacting the poppet stem to the valve housing, and without moving the valve housing face more than 2½" (69.1 mm) from input end (upper end) of rack piston. If you cannot rotate the input shaft, remove the balls and reassemble them.

WARNING If you install a gear on a vehicle with the worm shaft unable to rotate, the gear will not function correctly. Steering and gear failure may result.

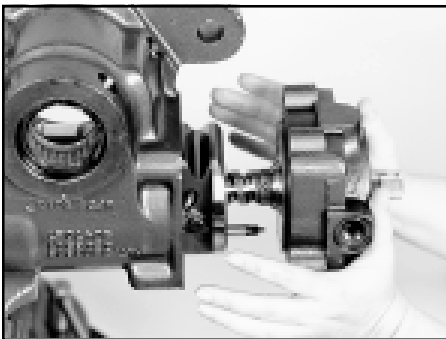

Install rack piston, worm, valve assembly

Oil

11. Apply clean oil to Teflon seal ring (23) on rack piston. Make sure there is a space of ⅜ - ½" (10.0-13.0 mm) between valve housing (5) and poppet stem to prevent poppet contact at either end. Remove the All Threads, and push the rack piston assembly into the housing with the rack piston teeth toward the sector shaft cavity. Line up the valve housing cylinder feed hole with the gear housing feed hole. Make sure both o-rings in the valve housing remain in position.

CAUTION Do not damage the seal ring (23) while installing the rack piston into housing.

CAUTION The poppet seat and sleeve assemblies (27) must not bottom against the internal poppet stops in the steering gear until the gear is installed on the vehicle and the poppet adjustment procedures are performed.



Install valve housing bolts

E-18 Torx socket
ft•lb Torque wrench

12. Lubricate and install the four valve housing bolts (1) into the housing. Torque the bolts to **118-138 ft•lb** (160-187 N•m).

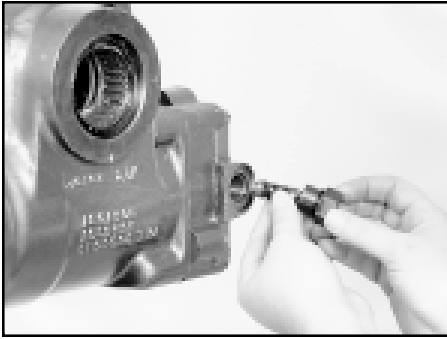

Install relief valve parts

7/8" Socket
ft•lb Torque
wrench

13. If the gear is equipped with a relief valve, assemble a new o-ring (9) on relief valve cap (10). Assemble the small end of tapered spring onto the pin on the relief valve cartridge and insert the assembly (8), (large end of tapered spring end first) into the relief valve cap cavity. Turn the relief valve cap as assembled into the valve housing and torque to **30 ft•lb** (41 N•m).



Lubricate side cover bearing

14. Apply a generous amount of Exxon Polyrex* EP2 (TRW P/N 045422, do not substitute another type of grease) to the caged bearing assembly inside the side cover. Next, install washer (42) on top of bearing before inserting the seal (40).

CAUTION This bearing is sealed and will receive no lubrication from the hydraulic fluid in the gear. Failure to use the proper grease could result in premature bearing wear.

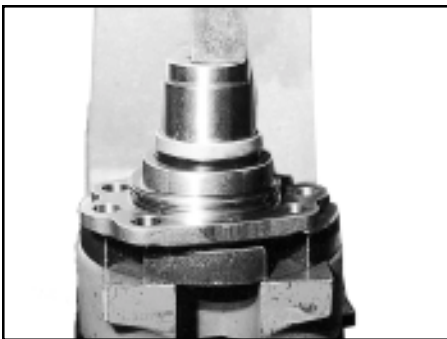

Press seal in side cover

J37705
(THP/PCF45)
J37071
(THP/PCF60)
Press

15. Grease and assemble new seal (40) onto installation tool so the side with the garter spring is against the shoulder of the tool. Pilot the tool into the side cover (45) with a force of 100-800 lb (445-3560 N) until it is seated against the bearing or bushing.

CAUTION Make sure the OD of the seal, and the ID of the bore are free from grease and dust, for proper engagement of the seal.



Lubricate sector shaft

16. Apply a generous amount of Exxon Polyrex EP2 (P/N 045422) to the short bearing area of the sector shaft.



Install sector shaft into side cover

Screwdriver

17. Insert the sector shaft (41) into the side cover subassembly (45), and turn the sector shaft adjusting screw (41A) counterclockwise into the side cover until the screw reaches solid height.

Rotate the adjusting screw clockwise one half turn so the side cover will rotate freely on the sector shaft.

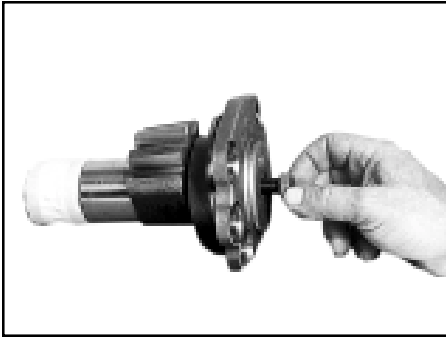

Install jam nut

18. Install the sector shaft adjusting screw jam nut (46) onto the sector shaft adjusting screw (41A) a few threads. Final adjustment will be made later.

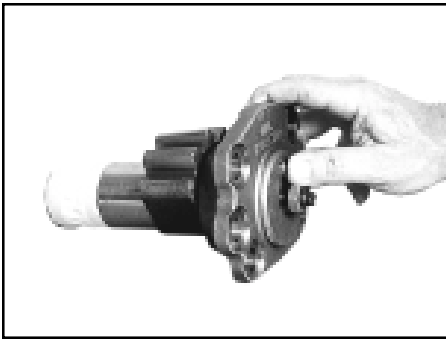

Assemble vent plug

19. Press the new vent plug (47) into the hole provided in the side cover until the plug is bottomed.

WARNING Do not weld or otherwise plug this hole in any permanent manner. This is a safety vent which functions only if the side cover seal fails. If the seal fails and the plug cannot vent, the steering gear may lock-up or otherwise malfunction.



Install side cover o-ring

20. Apply clean oil to the new side cover o-ring (44) and assemble it onto the side cover (45).

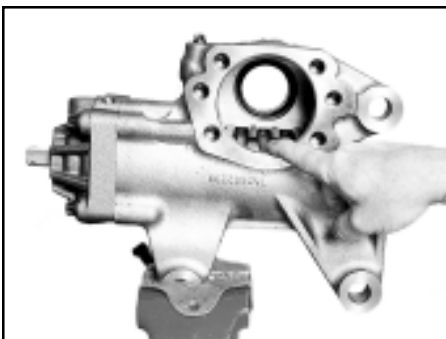

Center rack piston

21. There are four teeth on the rack piston. Rotate input shaft to position the rack piston so the space between the second and third tooth is in the center of the sector shaft opening. This will center the rack piston for assembly of sector shaft.

WARNING If the rack piston is not centered when sector shaft is installed, gear travel will be severely limited in one direction. This could result in an accident.

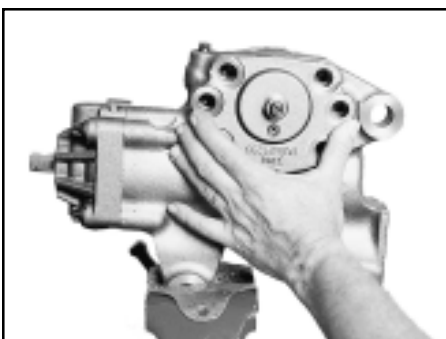

Install sector shaft and side cover into housing

Masking tape

22. Clean off any old tape on the serrations. Reapply one layer of masking tape. Install the sector shaft assembly into the housing. The center tooth of the sector shaft must engage the center space (between the second and third tooth) of the rack piston. Lightly tap on sidecover with a rubber hammer to seat cover against housing face.

CAUTION If the serrations are not properly taped, they will damage the output seal (41) in housing, causing the seal to leak.

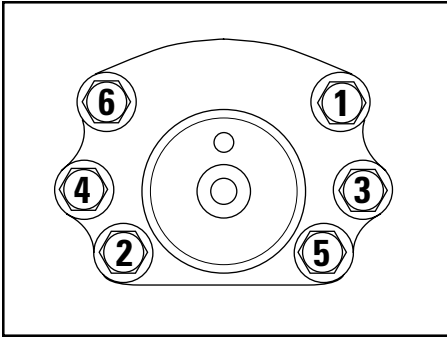

Install side cover bolts

$1\frac{5}{16}$ " Socket Torque wrench

23. Install bolts in positions 3 and 4 first, by hand. Then, install the remaining side cover bolts (48) into the side cover and torque them in the sequence shown. If bolts must be replaced, use bolts of the same design, type and length as those you removed. **Do not use a substitute.**

Lubricate side cover bolts and torque bolts to **180-220 ft•lb** (244-298 N•m).

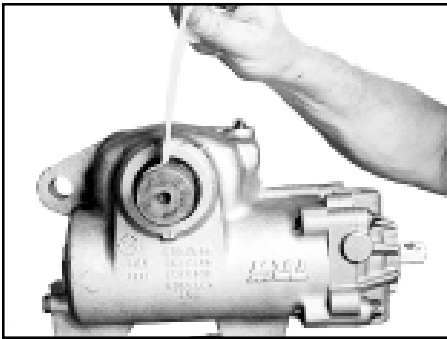

Remove tape

24. Remove tape from the sector shaft (41).

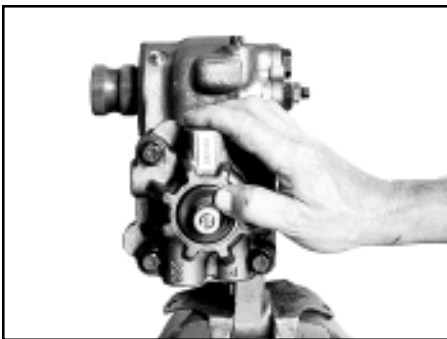

Install dirt & water seal

Grease

25. Pack the end of the valve housing bore around the input shaft with clean, high temperature industrial grease, Exxon Polyrex EP2. (P/N 045422). Apply more of the grease to the inside of a new dirt and water seal (2, 2B or 2C) and install it over the input shaft. Seat the seal in the groove behind the serrations and against the valve housing.

This step may have already been completed if you disassembled the valve housing and worm screw for repair.

Proceed to Final Adjustments on page 62

Poppet Component Replacement

Tools Required

2 lb Sledge
ft•lb Torque
wrench
J36452-A
Press
3/8" x 6" drill rod

Ratchet
Soft-jawed vise

Materials Required

Locquic "T" primer
Loctite RC680

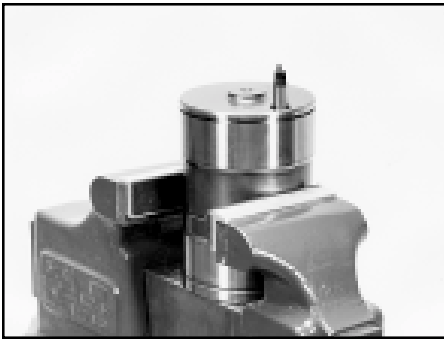

Place rack piston in vise

Soft-jawed vise

1. If the poppet assemblies are to be removed for replacement, place rack piston in a soft-jawed vise.

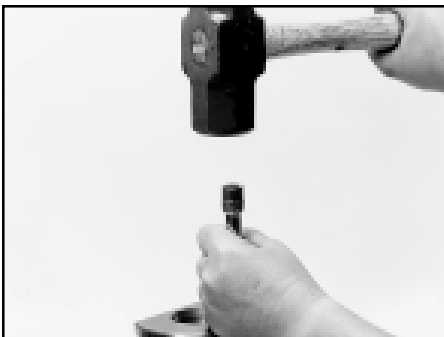

Loosen poppet adjuster seat

J36452-A
2 Lb Sledge

2. Slide special tool #J36452-A over the seat of poppet adjuster seat and sleeve assembly (27) and engage tool in the slots in the threaded sleeve. Hit the end of the tool firmly four or five times with a 2 lb sledge hammer to loosen Loctite.

CAUTION Poppet adjuster seat and sleeve assemblies (27) are retained by Loctite applied to the threads which makes the assemblies difficult to remove.



Remove poppet adjuster seat

J36452-A

3. With a ratchet applied to the tool, turn one adjuster seat and sleeve assembly out of the rack piston. If the ratchet does not turn easily, strike the adjuster removal tool again with a hammer. If the engaging tangs won't stay in place while torquing, it might be necessary to hold in place with an arbor press while applying loosening torque. Discard poppet seat and sleeve assembly.

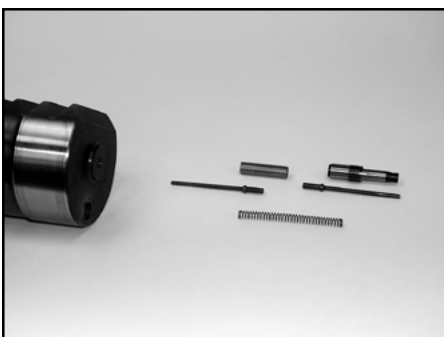

Remove poppet components

4. Remove the two poppets (26), spring (25), and push tube (24).

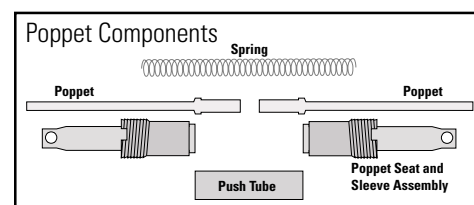



Remove other seat & sleeve if necessary

5. Remove and discard remaining poppet seat and sleeve assembly only if required.

NOTE It is possible to reset one poppet adjuster seat and sleeve assembly for automatic poppet adjustment while it is in the rack piston if one adjuster seat and sleeve assembly and the poppets, spring, spacer rod and push tube are removed.

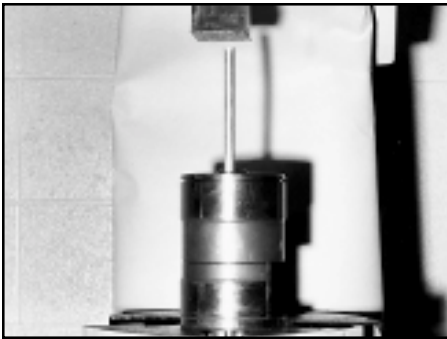

Reset remaining poppet seat and sleeve assembly

Press
3/8" X 6" Drill rod

6. If one poppet seat and sleeve assy. (27) was left in rack piston, it can be reset for automatic poppet adjustment by inserting a 3/8" (9.52 mm) diameter X 6" (152.4 mm) drill rod down through the poppet seat hole at the opposite end of the rack piston and against the adjuster seat to press the seat in until it bottoms against the adjuster sleeve.



Apply Locquic "T" primer and Loctite RC680

Locquic "T"
primer
Loctite RC680

7. Carefully apply Locquic "T" primer to the threads in poppet holes, and threads on the new seat and sleeve assemblies (27). Allow to dry for ten minutes; then carefully apply Loctite® RC680 to same threads.

CAUTION Do not allow Loctite or Locquic to get on the adjuster seat component of the adjuster seat and sleeve assembly. The poppets will not function properly.



Install one poppet seat and sleeve assembly

Soft-jawed vise

8. **WARNING** Wear eye protection while assembling poppets, as spring loaded poppets could eject and cause eye injury.

Place rack piston (28) in a soft-jawed vise and turn one new poppet adjuster seat and sleeve assembly (27), (slotted end out) into the poppet hole in one end of rack piston.



Install remaining poppet components

J36452-A
ft•lb Torque
wrench

9. From the other end of the poppet hole in the rack piston, install: one poppet (26), poppet spring (25), push tube (24), other poppet (26), and the other new poppet adjuster seat and sleeve assembly (27). The new components will stack up as shown below.

Torque both poppet seat and sleeve assemblies to **18 ft•lb** (25 N•m).

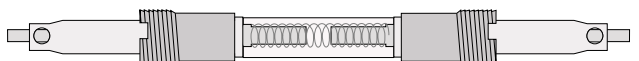

Return to step 25, page 40.

Valve Housing/Worm Screw Disassembly

Tools Required		Materials Required
Hammer	in•lb. Torque wrench	Small probe or pick
ft•lb Torque wrench	J37464	Sockets
Punch, center	J37070	12-point sockets
Punch, roll pin	J37073	
	Screwdriver	

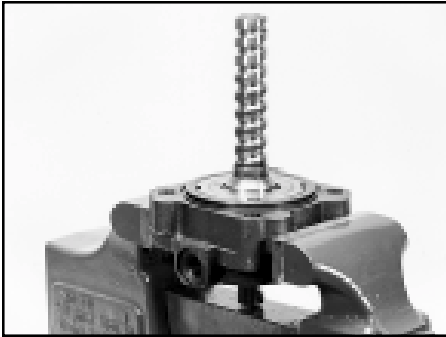

Place valve housing and valve assembly in vise

1. With worm vertical, place the valve housing (5), input shaft valve/worm assembly (15) in a vise.



Unstake adjuster locknut

2. Unstake the valve housing (5) where it was upset into the adjuster locknut (21) slot. Also unstake adjuster nut from adjuster (20).

Roll pin punch
Hammer

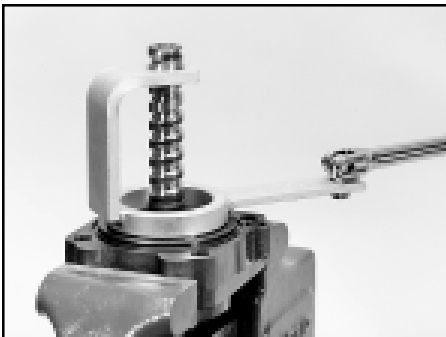

Remove bearing adjuster locknut

3. Turn bearing adjuster locknut (21) out of the valve housing.

J37464



Remove bearing adjuster

4. Turn bearing adjuster (20) out of the valve housing.

J37070



Remove seal ring and o-ring

Small probe or pick

- 5. Remove and discard seal ring (18) and o-ring (19) from bearing adjuster.



Remove input shaft

- 6. Remove the input shaft valve/worm assembly (15) from the valve housing (5).



Remove thin washer and bearing

- 7. Remove thin thrust washer (17) and thrust bearing (16) from input shaft (15).

CAUTION Input shaft, valve worm assembly must not be disassembled further. The components were a select fit at assembly and are available only as part of this subassembly. If disassembled further, the subassembly must be replaced.



Remove ball bearing

- 8. Remove bearing (12) from valve housing.

WARNING Do not remove the ball cup that the bearing (12) rides on. Do not remove the special spacer seal behind the ball cup.



Remove seal ring

Small probe or pick

- 9. Remove and discard seal ring (14) from valve housing (5).

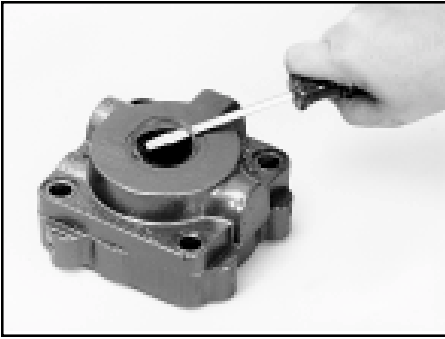

Remove retaining ring

Screwdriver

10. Turn over valve housing and remove retaining ring (3).



Remove seal

1 1/8" Socket Hammer

11. **CAUTION** Exercise special care when removing seal (4) to prevent damaging the valve housing seal bore.

Tap input shaft seal (4) out of valve housing. Discard seal.

NOTE The valve housing also utilizes a ball plug for manufacturing purposes that must not be removed.



Inspect input shaft, valve worm assembly sealing areas

12. Inspect the sealing areas of input shaft and valve (15) for nicks and run your fingernail edge across the sealing surfaces to detect steps. Inspect for discoloration from excess heat. Inspect input shaft ball-track grooves for brinelling or spalling. If any of these conditions exist, you must replace the input shaft valve/worm assembly, valve housing and balls. Also replace rack piston if brinelling or spalling is found.



Inspect thrust washer and bearings

13. Inspect the thrust bearing (16) rollers and ball bearing (12) for any deterioration. Inspect thrust washer (17) and ball bearing race in the valve housing for brinelling, spalling, or cracks. Replace any part with these conditions.



Place valve housing in vise

14. Place valve housing (5) firmly in a vise so the input shaft, valve/worm assembly (15) can be assembled vertically with the worm end up.

CAUTION Do not clamp against threaded port hole or relief valve hole sealing faces when placing valve housing in vise.



Assemble seal ring

15. Lightly oil and assemble new seal ring (14) into the large diameter seal ring groove in valve housing, bending and working it in and smoothing it out as necessary.

NOTE The seal ring must be smoothed out or it may be damaged when the worm is installed.



Install ball bearing into valve housing

16. Install ball bearing (12) into valve housing (5).

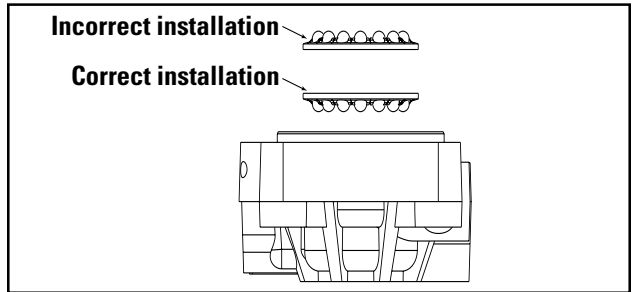

Assemble input shaft, valve worm.

17. Dip the input end of the input shaft, valve, worm assembly (15) into oil up to the worm lead. Assemble the input shaft end of the assembly into the valve housing (5) until it is firmly seated.



Assemble bearing and thrust washer

18. Apply oil and assemble the other thrust bearing (16) then the thin thrust washer (17) over the ball groove end of worm, and seat them against the shoulder of input shaft valve worm assembly (15).



Assemble seals in bearing adjuster

19. Lightly oil a new o-ring (19) and assemble into the seal groove in bearing adjuster (20). Oil and work a new seal ring (18) into the same groove and smooth it out.

NOTE Be sure the valve housing, adjuster locknut and bearing adjuster threads are clean and free of any staking burrs that would impede the locknut from turning freely on adjuster or the adjuster turning freely in valve housing.

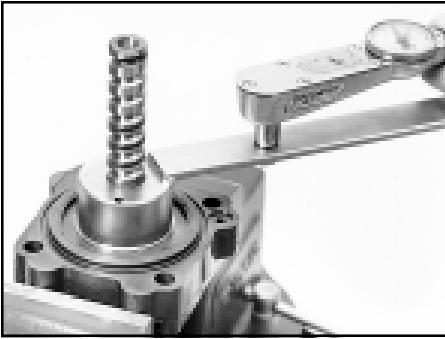

Assemble bearing adjuster

J37070
ft•lb Torque
wrench

20. Lightly oil and assemble bearing adjuster (20) over worm and into valve housing. Torque adjuster to **13 ft•lb** (18 N•m) indicated torque using a torque wrench inserted in adjuster tool #J37070. This will seat the components. Back off adjuster $\frac{1}{4}$ to $\frac{1}{2}$ of a turn.

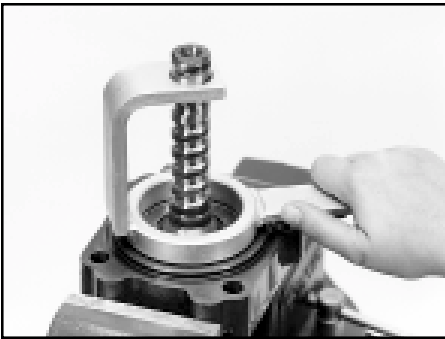

Assemble new locknut

J37464

21. Lightly oil and assemble new locknut (21) onto bearing adjuster (20) with radius (slightly rounded) side down. Tighten slightly to keep the bearing adjuster in place.

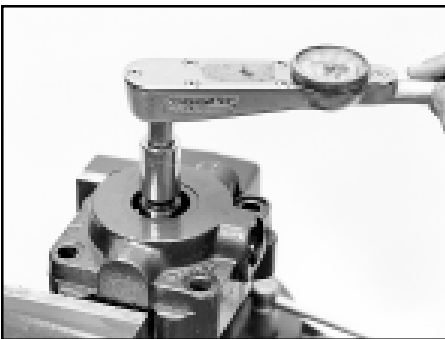

Adjust to required input torque

$\frac{3}{4}$ " or $\frac{11}{16}$ " 12-
point socket
in•lb Torque
wrench

22. Reverse assembly in vise so the worm end is down. With an inch pound torque wrench on the input shaft, note torque required to rotate the input shaft 360° in each direction. Tighten the bearing adjuster to increase the maximum torque at the input shaft **5-10 in•lb** (.5-1.0 N•m) over that which was previously noted.



Torque locknut

J37070
J37464
ft•lb Torque
wrench

23. Again reverse the assembly in vise. Torque locknut while holding bearing adjuster in position established in step 22 with appropriate adjuster tool. When using a torque wrench in locknut tool J37464, the torque wrench reading should be **112 ft•lb** (152 N•m).



Check input shaft torque

24. Recheck input shaft torque. It should match torque measured in step 22. Repeat steps 22 and 23 if necessary.



Stake valve housing and locknut

Center punch
Hammer
13/16" Socket
in•lb Torque
wrench

25. Stake valve housing into the clockwise most corner of two opposing slots in lock nut (21). Stake the locknut into the adjuster (20) in two places (180° apart) at threaded area. Choose areas that have not been previously staked.

After staking, torque required to rotate input shaft must be between **5-10 in•lb** (.5-1.0 N•m) **greater** than the torque noted in step 22. Torque value must **not exceed 22 in•lb** (2.5 N•m). Unstake and readjust if necessary.



Reposition subassembly in vise

26. Reposition worm screw/valve housing subassembly in soft-jawed vise, clamping tightly against valve housing, so the worm screw is pointing down.



Install input shaft seal

J37073
Hammer

27. Apply clean grease (Exxon Polyrex EP2, P/N 045422) to the outside and inside diameters (fill cavity between the lips) of the new input shaft seal (4) and assemble it, garter spring side first over the input shaft. Align seal in the valve housing seal bore.

Place seal installer tool #J37073, small diameter end first, over the input shaft and against the seal. Tap the seal installer tool until the tool shoulder is squarely against the valve housing. This will correctly position the seal in the housing bore just beyond the retaining ring groove.

CAUTION Remove any seal material that may have sheared off and is in seal bore and retaining ring groove.

CAUTION The input shaft seal must be square in the seal bore and installed to the correct depth.



Insert retaining ring

28. Insert new retaining ring (3) into its groove in valve housing (5).

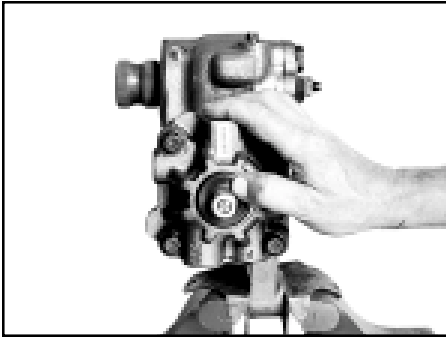

Install dirt & water seal

Grease

29. Pack the end of the valve housing bore around the input shaft with clean, high temperature industrial grease, Exxon Polyrex EP2 (P/N 045422). Apply more of the grease to the inside of a new dirt and water seal (2, 2B or 2C) and install it over the input shaft. Seat the seal in the groove behind the serrations and against the valve housing.

Return to step 26, page 40.

Roller Bearing Replacement

Tools Required

Press
J37705 (THP/PCF45)
J37071-A (THP/PCF60)

Materials Required



Remove roller bearing if required

J37705
THP/PCF45
J37071-A
THP/PCF60
Press

1. If roller bearing (39) in housing needs to be replaced, place the bearing removal end (long end) of the bearing and seal tool against the trunnion end of the bearing and press it out of the side cover end of the bearing bore. Discard bearing.

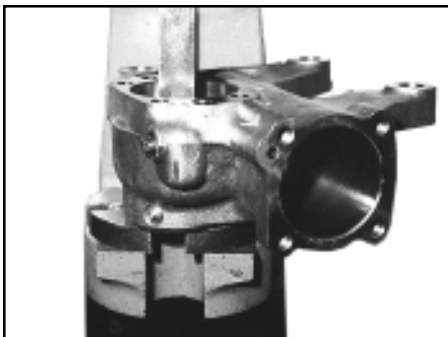

Press in housing roller bearing

J37705
THP/PCF45
J37071-A
THP/PCF60
Press

2. Press the new roller bearing (39) into the housing from the side cover end of the bearing bore until it is seated against the step bore. Be sure the housing is square with the press base and the bearing is not cocked.

CAUTION Use the bearing installation end of the tool (short end). If the bearing removal end of the bearing & seal tool is used to press in bearing, the cage on the new bearing may be damaged.

NOTE If the unmachined trunnion face is not square, use shims to square it before pressing in the bearing.

Return to step 29, page 40.

Replace Housing Port Plugs, Screws, and Fittings

Tools Required

Allen wrench
Torx sockets
SAE/Metric sockets
Open end wrench
in•lb Torque wrench
ft•lb Torque wrench

Materials Required

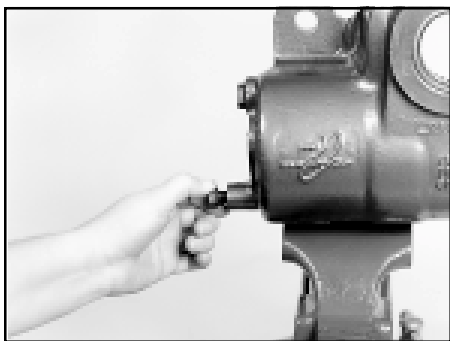

Replace poppet fixed stop screw

THP/PCF45
18mm Socket
THP/PCF60
5/8" Socket
ft•lb Torque wrench

1. If damaged, remove and replace the poppet fixed stop screw (38) and washer (Not shown) if equipped. Replace with poppet fixed stop screw (38), discard the washer. Torque to **48 ft•lb** (65 N•m).



Replace poppet adjusting screw

THP/PCF45
6mm Allen wrench
18mm Socket
19mm Wrench
THP/PCF60
7/32" Allen wrench
5/8" Socket
3/4" Wrench
ft•lb Torque wrench

2. If damaged, remove poppet adjusting screw (38A) and sealing nut (38B) without allowing the nut to change its position on the screw.

Assemble the new nut onto the new adjusting screw, matching its position to the nut and screw removed. Torque sealing nut to **35 ft•lb** (47 N•m).

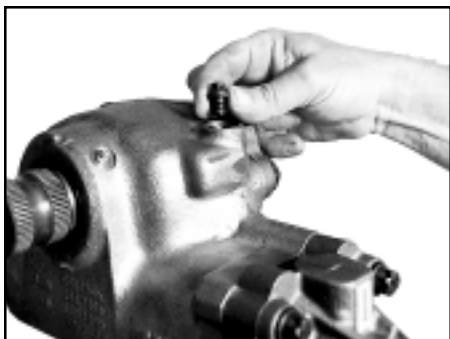

Replace automatic bleed screw, and aux. port plugs

E-14 Torx socket
ft•lb Torque wrench

3. If damaged, remove and replace automatic bleed plug (38). Torque to **48 ft•lb** (65 N•m).

If damaged, remove and replace permanent auxiliary port plugs (7) and o-rings (6). Assemble new o-rings on port plugs and torque to their respective ports in the housing or valve housing to **30 ft•lb** (41 N•m).



Replace manual bleed screw

5/16" Hex socket
in•lb Torque wrench

4. If damaged, remove and replace manual bleed screw (Not shown). Torque to **45 in•lb** (3.4 N•m).

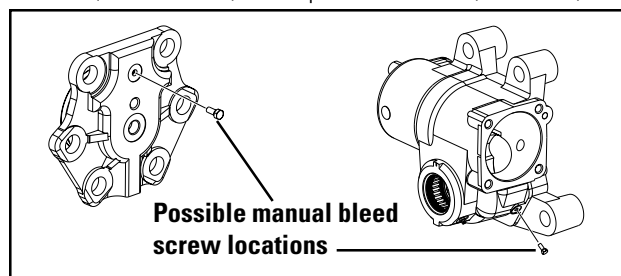

Return to inspection section, page 42.

Final Adjustments

Tools Required

Box-end wrench
ft•lb Torque wrench
in•lb. Torque wrench

Screwdriver
Sockets

Materials Required



Center steering gear

$\frac{3}{4}$ " and $1\frac{1}{16}$ "
Socket or box
end wrench

1. To center the steering gear, rotate input shaft valve worm assembly (15) until the timing mark on the end of the sector shaft (41) is in line with the timing mark on the end of housing trunnion.

CAUTION Do not rotate the input shaft more than 1.5 revolutions from center position until the steering gear is installed, during poppet setting procedure. Doing so could make the automatic poppets inoperative, which would require disassembly of steering gear to reposition poppet seat and sleeve assemblies.

NOTE Initial poppet contact will occur at less than one input shaft rotation in one direction from steering gear center position, if new or reset poppet adjuster seat and sleeve assemblies are assembled in the unit.

NOTE Worm preload adjustment was set when input shaft, valve and worm were assembled into valve housing.

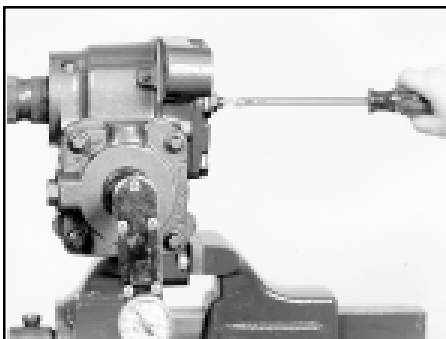

Tighten adjusting screw

in•lb Torque wrench
Screwdriver
 $1\frac{1}{16}$ " or $\frac{3}{4}$ "
Socket

2. With adjusting screw jam nut (46) loose, turn sector shaft adjusting screw (41A) clockwise to provide **45-50 in•lb** (5-5.5 N•m) of torque required to rotate the input shaft valve/worm assembly (15) through one half turn (180°) each side of center.

NOTE This procedure will properly mesh and seat the rack piston and sector shaft teeth for final adjustments.

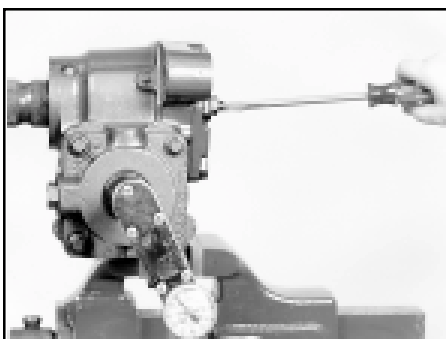

Loosen adjusting screw and note torque

in•lb Torque wrench
Screwdriver
 $1\frac{1}{16}$ " Socket

3. Turn sector shaft adjusting screw (41A) counter-clockwise one half turn and **note maximum torque** required to rotate the input shaft, valve/worm assembly through one half turn (180°) each side of center.

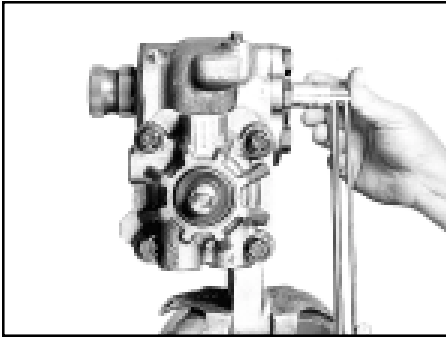

Adjust adjusting screw

$\frac{3}{4}$ " Socket
 $1\frac{1}{16}$ " Socket
ft•lb Torque wrench
in•lb Torque wrench

4. Adjust sector shaft adjusting screw (41A) clockwise **to increase** maximum torque noted in step 3 by **7 in•lb** (.8 N•m). Tighten jam nut (47) firmly against side cover while holding the adjusting screw in position. Finally, torque jam nut to **43 ft•lb** (58 N•m) and check input shaft valve/worm assembly torque again. Readjust if input shaft torque exceeds **40 in•lb** (4.5 N•m).

Section 5 Reinstallation

Reinstallation 65
Poppet Resetting 65

Glossary 66

Reinstallation

- Verify that axle stops are set to manufacturer's wheelcut or clearance specifications.
- Bolt gear to frame, torque to vehicle manufacturer's recommendation.
- Connect return line to reservoir in THP/PCF return port.
- Connect hydraulic line from pump to pressure port in THP/PCF unit.
- Connect steering column to input shaft, torque pinch bolt to vehicle manufacturer's recommendation.
- Install pitman arm on output shaft, with timing marks aligned. Torque bolt to vehicle manufacturer's recommendation.
- Connect drag link to pitman arm.

Poppet Resetting

IF Poppets remain unchanged from when gear was removed from vehicle, and gear is being installed on the same vehicle with no change in axle stops or linkage.



After installation, check to make sure poppets relieve in both turns just before axle stop contact is made. If not, use resetting procedure beginning on page 23.

IF Poppets were replaced with new components or reset during gear disassembly, and are ready for automatic positioning.



Use poppet setting procedure on page 13.

IF Poppets may have been moved during disassembly or reassembly procedures, or gear is being installed on a different vehicle.



Use poppet resetting procedure beginning on page 23.

Glossary

Aerated Fluid

Fluid with air bubbles

Automatic Bleed Systems

Gears are mounted in such a way that trapped air can be forced out of the system "automatically" without loosening bleed screw.

Axial

In-out movement along an axis (imaginary straight line on which an object moves)

Brinelling

Dents

Date Code

Date the steering gear was built (Julian date)

Discoloration

Change in color

External Leakage

Fluid Leaking out of the system or steering gear

Full Turn

Hub contacts axle stop

Integral Power Steering

Steering gear has manual steering mechanism, hydraulic control valve, and hydraulic power cylinder all within gear housing.

Impact

The application of torques and forces to steering gear components during accidents or other similar events which exceed the hydraulic capacity of the steering gear

Internal Leakage

Fluid leaking inside the gear

Lash

Free play

Manual Bleed Systems

Gears are mounted in such a way that an air pocket could form in one end of the steering gear. The bleed screw is positioned so trapped air can be forced out when loosened.

OSHA

Occupational Safety and Health Administration

PCF

Positive Center Feel - option available on THP series steering gears.

Poppets

Unloading valves, reduce pressure in full turns.

Relief Valve

Limits maximum supply pressure

Return Line

Line that connects steering gear to reservoir to recirculate hydraulic fluid

Rotary Control Valve

Controls flow in internal cavities

Scoring

Scratch

Shock Load

Shake or jar

Spalling

Flaking or chipping

Subassembly

An assembled unit that fits into a larger unit

Supply Line

Line that connects pump to steering gear

Twisted Serrations

Output shaft serrations damaged by impact overload. Serrations can be twisted at the area between the large diameter of the shaft and the end of the serrations.

TRW Automotive
Commercial Steering Systems
800 Heath Street
Lafayette, IN 47904
Tel 765.423.5377
Fax 765.429.1868
<http://www.trucksteering.com>
<http://trucksteering.trw.com>

