

Accenture Labs

# Discover Impossible

Explore how our innovation is shaping the future

#LabsInnovationReport

**Throughout history, seemingly impossible tasks have always been overcome by moments of brilliant innovation. It's why at Accenture Labs, we partner with our clients to go beyond the impossible. Together we're combining our technology and expertise to overcome complex challenges and deliver groundbreaking innovation.**

**We're reshaping the future of business, making the impossible, possible.**

# Contents

- 01** **Our mission** 4-7
- 02** **Digital Experiences** 8 - 10
- 03** **Artificial Intelligence** 11 - 13
- 04** **Security** 14 - 16
- 05** **Systems & Platforms** 17 - 18
- 06** **Application Engineering** 19 - 20
- 07** **Industry X.0** 21 - 22
- 08** **Accenture Technology Vision 2020** 23 - 24
- 09** **Tech4Good** 25 - 27
- 10** **How we scale innovation with our clients** 28 - 30
- 11** **What's next?** 31
- 12** **How can I engage with Accenture Labs?** 32

# Welcome to the Accenture Labs Innovation Report

NEW Shenzhen Lab

**This year's Innovation Report showcases Accenture Labs' work at the intersection of cutting-edge technology development and practical business application. We are excited to share some of the very best innovations that we're enabling for our clients and co-research partners.**

Since our last Innovation Report, we have driven numerous innovations forward. Whether it's AmpliGraph, the open source machine learning library for knowledge discovery developed by the Dublin Lab, or the great work our Incubation Group in Silicon Valley has been doing with smart materials, we've ensured our partners, our clients, and our own people are always at the front line of technology innovation.

In the last 12 months alone, we've hosted more than 1,000 events and workshops, and developed over 80 proofs of concept. In addition, our new Shaping the Future program is helping our clients understand and—crucially—shape the long-term future of their businesses and industries through ten-year-plus innovation roadmaps. Working in interdisciplinary teams, the program examines the interplay of the technologies and societal factors that will determine what the future holds through 2030 and beyond.

At the same time, the Accenture Labs footprint continues to grow across the globe. We were delighted to launch our new Shenzhen Lab specializing in artificial intelligence, robotics and

Industry X.O. We also continue to extend our reach through our growing number of Nano Labs, with our most recent launch in Medellin, Colombia and in Hyderabad and Pune, India.

Over the next year our applied research will continue to dive deeper into cutting-edge fields like quantum computing, neuromorphic computing, smart materials and biocomputing. It promises to be another exciting and productive year of innovation and we look forward to partnering with you on your own innovation journeys, whether that's exploring new technologies and trends, rapidly prototyping transformative solutions, or building out more robust R&D capabilities.

**Marc Carrel-Billiard**  
Senior Managing Director,  
Accenture Labs

**Edy Liongosari**  
Chief Research Scientist,  
Accenture Labs



NEW Medellin Nano Lab



NEW Incubation Group adds neuromorphic research

# Our mission

**Accenture Labs shapes the future with breakthrough technologies through applied R&D.**

We incubate and prototype new ideas and concepts that we expect to have a significant strategic near-term impact on our clients' businesses.

Our dedicated team of technologists and researchers work with leaders across the company and with our business partners to invest in, develop and deliver breakthrough ideas and solutions that help organizations create new sources of business advantage.

Accenture Labs are located in seven key research hubs spanning the world, from San Francisco, California to Shenzhen, China. These Labs are complemented by our growing number of Nano Labs which extend our reach to numerous locations in Asia, Europe and the Americas.

Labs also collaborate extensively with Accenture's network of nearly 400 innovation centers, studios and centers of excellence in 92 cities and 35 countries. This collaboration is key in delivering highly scalable cutting-edge research, insights, and solutions for our clients, taking innovation into the heart of where they operate, work and live.

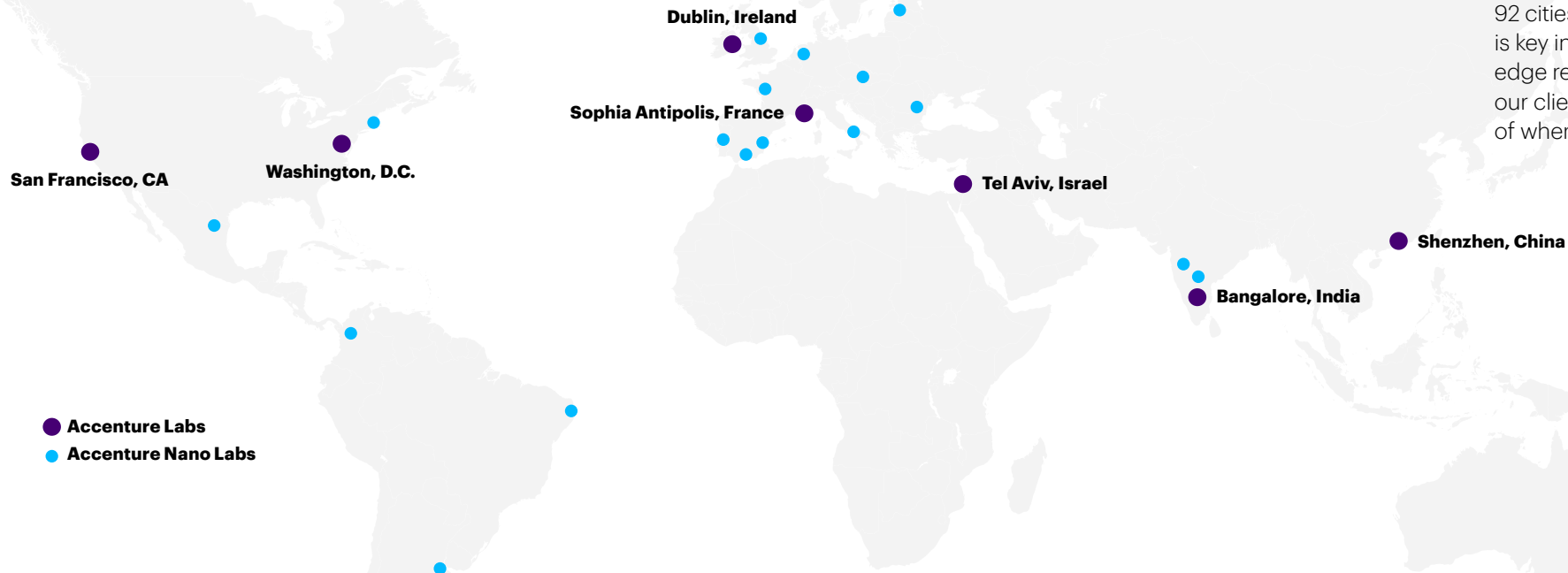

## Accenture Labs R&D groups

### Digital Experiences

This group develops technology concepts to increase engagement with customers and employees by pioneering emerging technologies and engagement strategies, such as adaptive product redesign, human-machine teaming and immersive experiences.

### Systems & Platforms

This group develops frameworks and tools that enhance architectures for the connected data-driven enterprises of the future, ensuring they can orchestrate and adapt to massive amounts of data, devices and systems in real time.

### Artificial Intelligence

This group explores new ways of addressing critical business problems by applying leading-edge AI techniques, including machine learning, natural language processing, explainable AI, knowledge representation and reasoning.

### Application Engineering

This group applies intelligent automation in the software development lifecycle to significantly accelerate the application development process while increasing the quality of overall outcomes.

### Security

This group creates solutions that improve our clients' cyber-defense strategies and capabilities, such as threat-centric management, advanced detection methods, data protection at scale and effective risk management techniques.



## New. Applied. Now.

Accenture Labs is a critical component in the Accenture Innovation Architecture. Specifically designed to scale Accenture’s ability to drive innovation, Labs has a mission to undertake applied research focusing on client challenges and leveraging new technologies available now—both from the market and from our own innovation ecosystem. By embodying the ‘New Applied Now’ principle, Labs helps Accenture and its clients lead with innovation.

For the latest news and thought leadership from Accenture Labs, please visit:

[www.accenture.com/labs](http://www.accenture.com/labs)

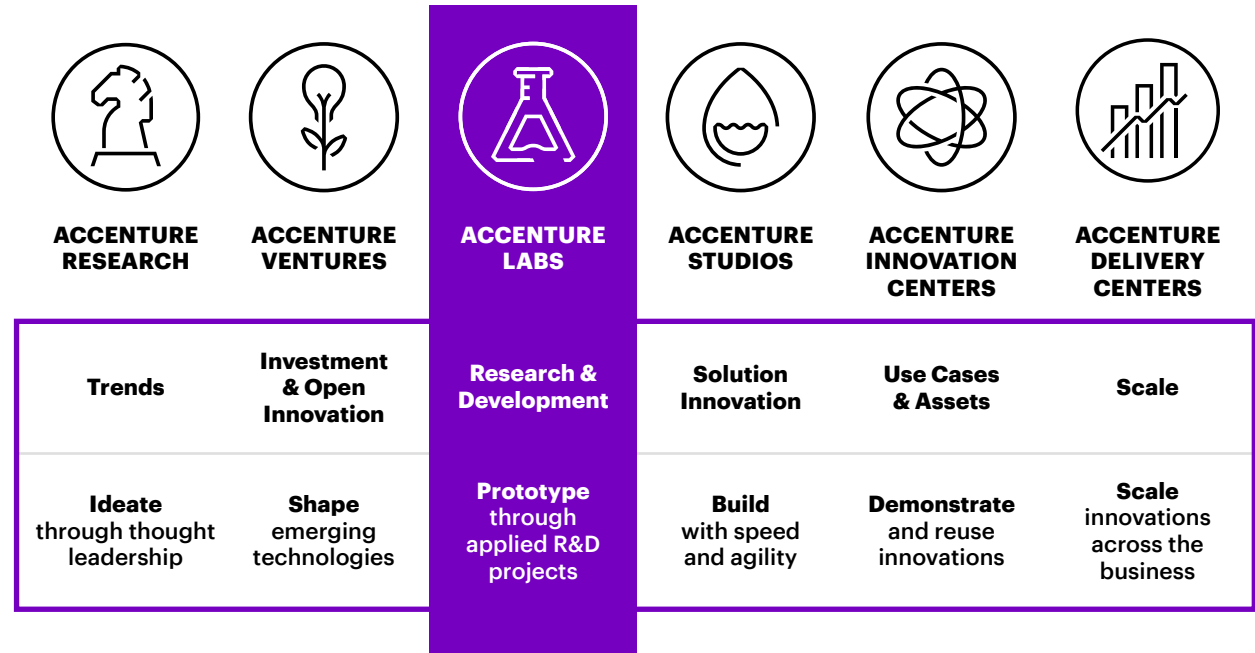

## Accenture Labs by R&D area

	San Francisco Lab	Washington DC Lab	Dublin Lab	Sophia Antipolis Lab	Tel Aviv Lab	Bangalore Lab	Shenzhen Lab
Artificial Intelligence	●		●	●		●	●
Digital Experiences	●			●		●	
Security		●			●		
Systems & Platforms	●			●			●
Application Engineering						●	

## Labs innovation by the numbers

### Achievements over the past 12 months

**250**  
Patents  
Granted

**123**  
Business and Research  
Reports Published

**31**  
Vendor Relationships  
Signed

**29**  
Client Pilots  
Delivered

**23**  
University  
Relationships Formed

**84**  
Proofs of Concept  
Developed

**1,000+**  
Innovation Workshops and Events  
Hosted for Clients and Partners





02

# Experiencing Impossible

Making big dreams a reality

## Digital Experiences

### Envisioning the practical realities of smart materials

Dramatic advances in material science and latest innovation in e-textiles, flexible electronics, 4D printing and other areas are enabling seamless, unobtrusive interfaces to smart environments. In exploring the practical implementations of smart materials, Labs has been at the forefront of researching how smart products and smart environments will become more adaptive to human needs. For example, Accenture Labs continues to join forces with leading automotive supplier Faurecia by co-investing to develop smart interiors and new services for connected and autonomous vehicles. Our co-research engagement means joint teams explore the use of smart materials, AI, advanced analytics, cloud, edge computing, augmented and virtual reality, and blockchain to develop services aimed at enhancing the wellness and comfort of both drivers and passengers.

### Enhancing creative design with AI

AI has the potential to transform the creative design process in radical ways, from analyzing the winning attributes of successful products at scale to predicting the popularity of design choices and much more. Using AI-driven generative design, an aircraft manufacturer was able to cut the weight of a key airplane part by 45%, significantly reducing fuel consumption and CO<sub>2</sub> emissions across its fleet.<sup>1</sup>

Accenture Labs developed a prototype which uses technology to accelerate the product design cycle and produce results that address fast-changing market demands more systematically. It uses neural style transfer and multi-object style transfer to suggest design ideas, initially for the apparel and packaged goods industries. Identifying popular design attributes on the basis of a diverse range of data sources, the prototype can generate new designs for human designers to take forward. This work was recognized with an award at the Accenture Global Technology Innovation Contest 2019.

### Reimagining the future of entertainment with Disney

Accenture continues to collaborate with The Walt Disney Studios StudioLAB as a key Innovation Partner. The StudioLAB is a unique space dedicated to reimagining, designing and prototyping the entertainment experiences and production capabilities of the future using innovative technologies. Early projects have explored the use of IoT and immersive technology to support ground-breaking experiences and how next-generation technologies like artificial intelligence and photogrammetry can accelerate and streamline movie production. The StudioLAB partnership draws on Accenture Labs' extensive experience of running a lab to help The Walt Disney Studios apply emerging technologies in innovative ways.

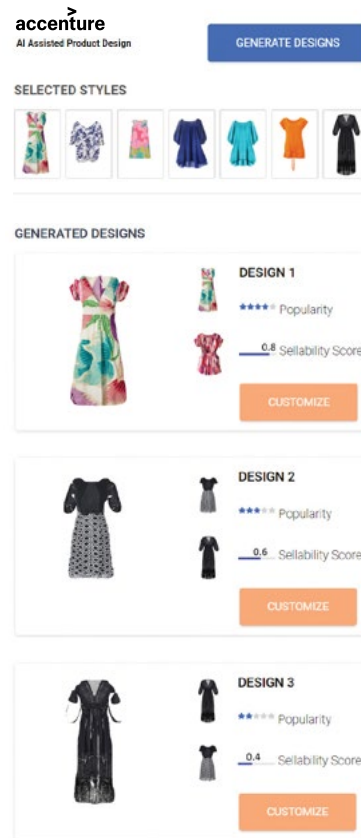

AI-assisted product design



### Redefining employee learning experiences with XR

What if you could train your employees on a system or tool before you finished building it, so that everyone is ready to go the moment it's finished? Or if you had a way to give people a fully realistic, immersive training experience on an expensive piece of equipment without exposing them—or the equipment—to real-world risk?

Extended reality (XR) is redefining the frontiers of immersive training. In aviation alone, the XR market is projected to grow from USD 78 million in 2019 to USD 1,372 million by 2025<sup>2</sup>. Accenture Labs helped a leading global transportation company develop an immersive approach for training their ship operators using XR. It lets employees experience a unique and realistic training environment, allowing them to prepare for the execution of a mooring procedure in a safe and repeatable way. Compared to traditional training, this approach brings multiple benefits: it improves and accelerates learning outcomes, reduces risks and reinforces safety, and provides scalability while reducing costs.

## Transforming disaster relief planning with immersive tech

With natural disasters increasing in severity and frequency, preparedness is key. In the past two years, Western wildfires alone have cost the U.S. more than \$40 billion<sup>3</sup>. Teams must be ready to respond to increasingly complex and dynamic situations at a moment’s notice, where delays—or unreliable information—may mean more lives lost.

Accenture Labs is developing a tool to help disaster relief planners quickly validate their plans before putting them into action. The Intelligent Immersive Planning Tool (IIPT) combines geospatial models with adaptive and learning AI to simulate the behavior of large groups of people with different goals. By modeling crowds, supplies and equipment in a virtual simulation, the IIPT provides a ‘digital twin’ to help planners anticipate how a scenario could unfold, including accounting for unexpected behaviors, so that they can be ready with the best plan possible. The team has completed a demo combining photogrammetry import of plan sites, plan modification, and simulated crowd training, showing how IIPT can help visualize how a disaster relief plan will unfold in an unfamiliar environment. By using VR simulations, planners can significantly increase disaster preparedness.

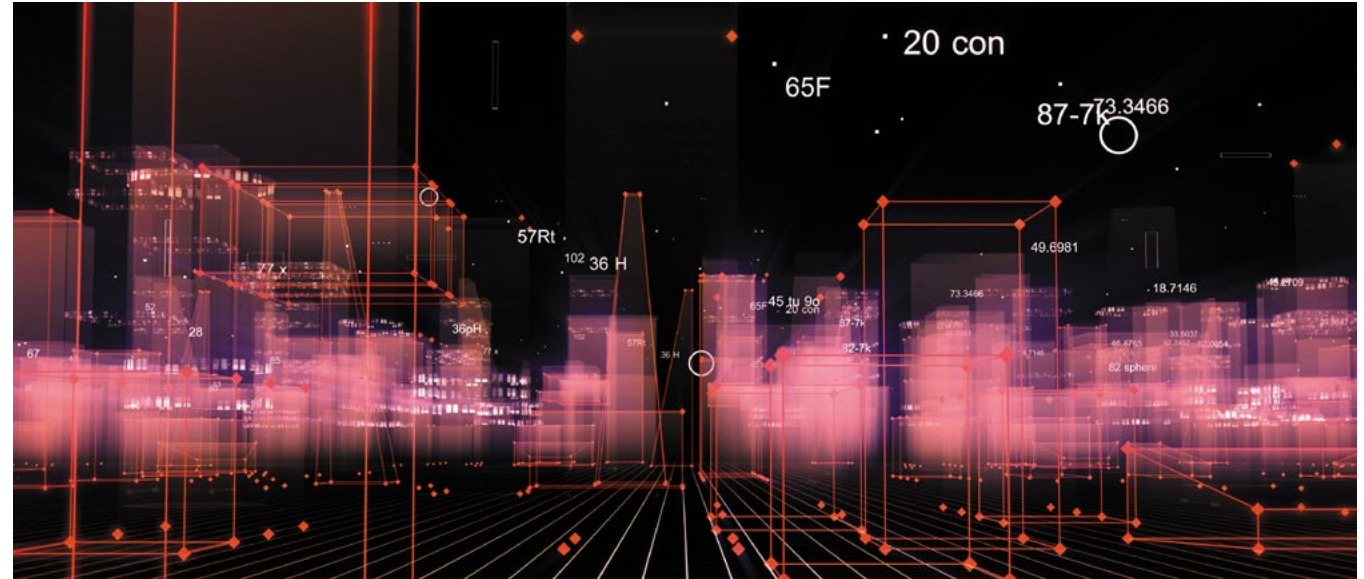

Creating a geospatial model and using it to run a digitally twinned scenario in VR



# Thinking impossible

Helping businesses see eye to eye with AI

## Artificial Intelligence

### Enabling knowledge discovery with AmpliGraph

Knowledge graphs provide a means to represent knowledge by capturing relationships between concepts. Whether it's a social network, a bioinformatics dataset, or retail purchase data, modelling knowledge as a graph—a network of interconnected facts—lets organizations capture patterns that would otherwise be overlooked. The growing emphasis on these graphs reflects a building consensus that machine learning alone can't address all the knowledge problems enterprises face. However, as knowledge graphs grow in size, it becomes increasingly important to automate the way in which new relationships between concepts are identified.

To help, the Dublin Lab created AmpliGraph, the first open source library to democratize graph representation learning, enabling brand-new knowledge discovery from existing graphs. Previously limited to research labs, this capability is now accessible as an open source library designed to lower entry barriers and bring machine learning on graphs to the mainstream. At Accenture Labs, we have used AmpliGraph with clients in areas as diverse as discovering drug side-effects from existing biomedical data, to customizing employee upskilling programs.

## 03 Artificial Intelligence

### Boosting data quality with machine learning

As enterprise becomes more and more data-driven, the need for quality data becomes essential. To this end, the race is on to enrich, remediate, and deduplicate enterprise data. Existing approaches rely either on human judgments about individual data points or on hard-and-fast rules that apply to entire data sets; in developing a new Data Labeling Workbench, Accenture Labs is creating a lightweight tool to significantly enhance and accelerate these data augmentation efforts. The Labeling Workbench uses AI techniques to provide a means for human experts to convey their knowledge in an efficient way and iteratively refine the resulting augmentations. For example, when training a model, rather than making a judgment on whether an individual insurance claim should be approved, the expert confirms or corrects large groups of judgments made by a machine, reducing the cost of labeling by as much as 90%.



*The Labeling Workbench combines subject matter experts and AI into one efficient team*



### Taking computational creativity into the heart of the kitchen

Food companies are under pressure to innovate faster, with individual customer personalization being the key battleground in the race for hyper-relevance. Working with a leading food industry player, the Dublin Lab developed a proof of concept demonstrating how computational creativity—the application of AI to enhance human creativity—can generate new creative combinations of food product ingredients. Taking into account factors like cost, health benefits, market trends, and consumer segmentation, as well as flavor combinations, the tool shows how AI can augment the creative process as food scientists and chefs search for ever more innovative and creative products.

AI acts as a teammate, giving product developers fast, curated inspiration and companies a quicker time to market for new products.

Our proof of concept also addresses a persistent challenge in supply chain disruption: finding substitutions for ingredients quickly. In addition to suggesting new combinations, the tool supports searches for such potential ingredient substitutions.

This ability to identify potential new formulations is critical in many industries, from finding potential new compounds in pharma or chemicals, to spotting emerging product categories in retail. That's why Labs is exploring the use of computational creativity techniques to generate synthetic data for training systems in data-poor environments (such as autonomous driving, where capturing data for all possible driving situations is impossible). The synthesis of viable data for training in such circumstances is a method of addressing these limitations.

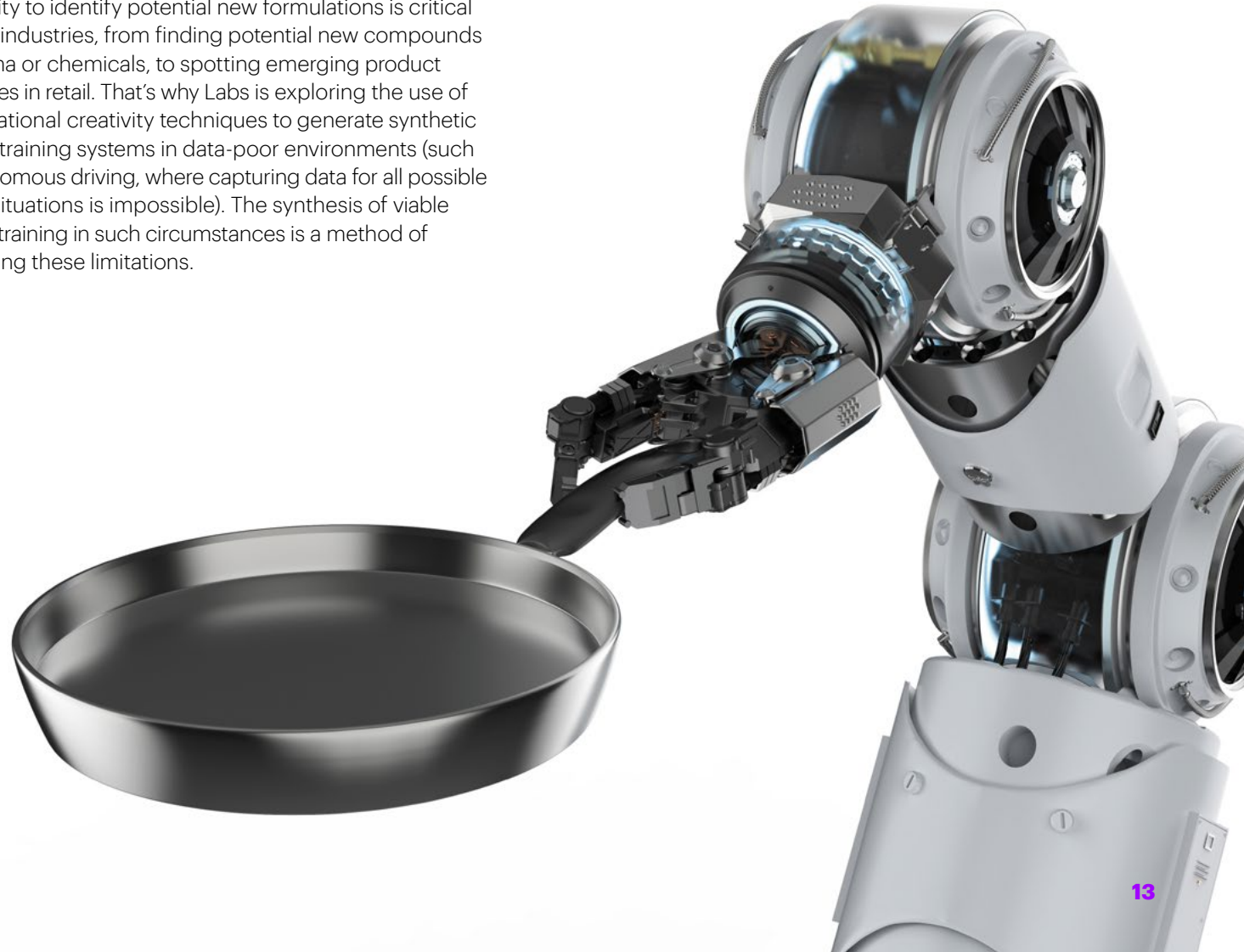



# Securing impossible

**Cyber-defence strategies and solutions that are ahead of the industry—and attackers**

## Security

### **Making security agile through the Cyber Digital Twin**

Security breaches have increased by 11% since 2018 and 67% since 2014, with an average cost of cybercrime for an organization reaching US\$13 million in 2019.<sup>4</sup> With each new service, technology or partner integration, the enterprise cyber-attack surface grows. Staying ahead of adversaries is an ever-increasing challenge. Now, through Agile Security research, Labs has created an industry first: the Cyber Digital Twin. This dynamic model of an enterprise's security posture comprises a knowledge graph platform configurable for any type of data, enabling businesses to analyze risk dynamically.

In our Lateral Movement use case, for example, we combine analysis of real conditions modeled in the CyTwin with Accenture's state-of-the-art knowledge of how adversaries navigate through networks and systems. This provides new understanding at both the macro level (risk to business processes or known business-critical devices) and the micro level (specific vulnerabilities and/or configurations that can be exploited). With these insights, cyber defenders can prioritize their actions to most effectively and efficiently reduce the risk to the business. The CyTwin can also model "what if" conditions or behavior in the enterprise, increasing resilience ahead of attack events.



### Ensuring AI is trustworthy and secure by design

As AI is used to drive more business decisions, it presents a new attack surface to adversaries. Unlike traditional application development, most AI leverages machine learning models that are trained on large amounts of training data before being placed into production. The larger the training set, the more likely the model will operate soundly. However, testing all possible data inputs is usually too costly and time consuming.

AI thus comes with inherent risks and Labs has been exploring how adversaries could potentially exploit them. We demonstrated several attacks on machine learning-enabled business processes, including online check deposits, geospatial image identification, and real-time video object identification, in each case developing and evaluating defensive techniques.

Labs has also been using Generative Adversarial Networks (GANs) to improve the detection of deepfake videos (visual and voice) and developing techniques to make video content unexploitable. Deepfakes have already been used to impersonate executives in phone conversations. In one case in the UK, the fake resulted in an immediate payment to a supplier in Hungary. Mechanisms to preserve trust or prove the veracity of video and audio content are thus quickly becoming essential.

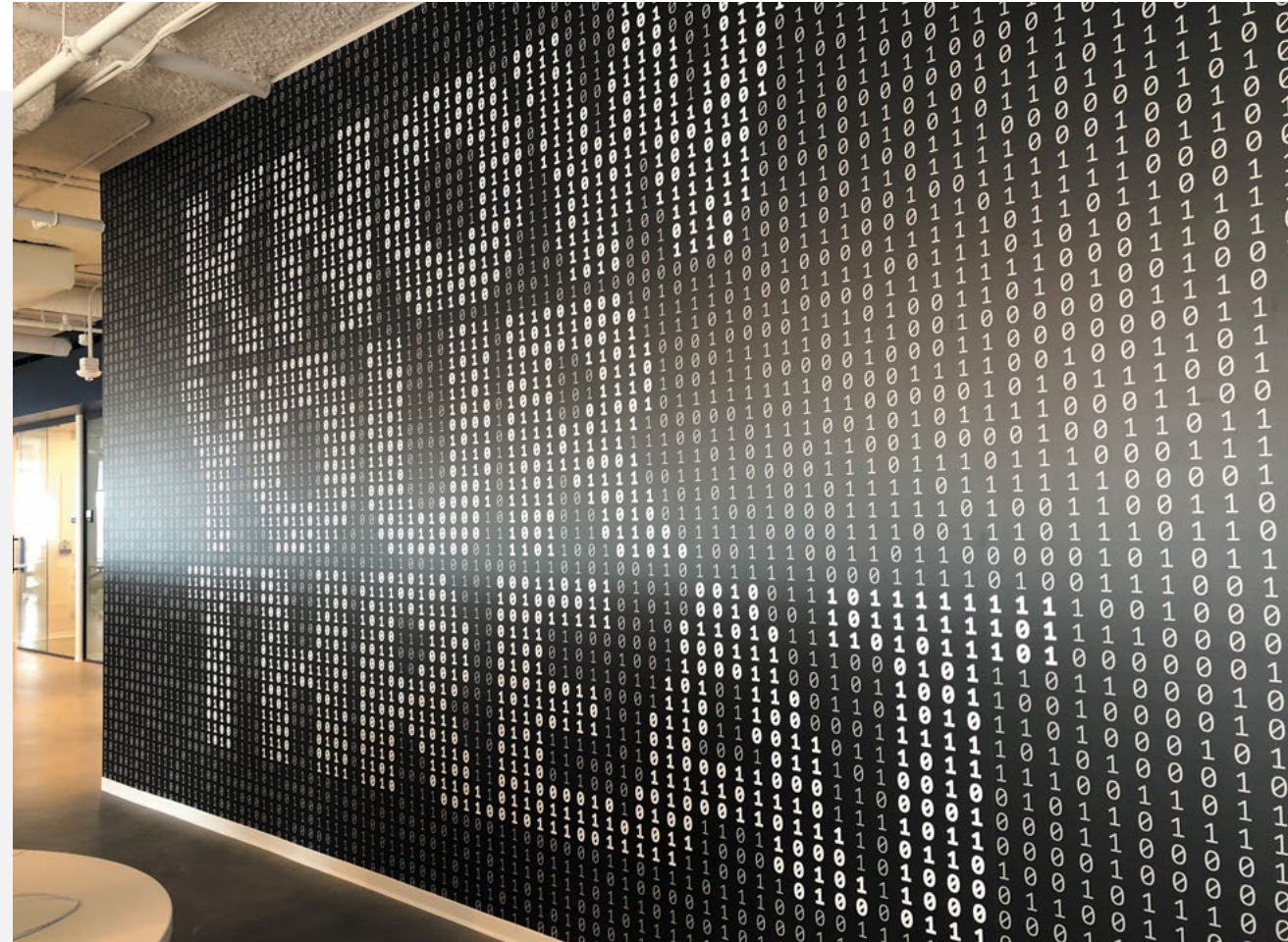

### Data-centric security through automated document classification

To combat ever more sophisticated security threats, many organizations are looking to move away from traditional concepts of “perimeter” security and instead adopt data-centric security approaches that better protect their key assets. One way of doing this is to automate document classification, enabling tailored data protection controls based on a document’s contents. The sensitivity of a document is a key factor in life-cycle controls and costs in managing data. For most companies, their data warehouses pre-date their data labeling programs, leaving much of the data in the “unknown” category which normally mandates a high level of protection. Labs has been working with a leading global life sciences company to pilot a Security Classification through Machine Learning (SCAML) proof of concept. We trained a model to learn what was sensitive, and then ran this against the company’s data stores, classifying its manufacturing documents with 97% accuracy and taking just a few weeks to perform a task that would have taken humans years.



### Minimizing attack surfaces with DeBloat technology

As serverless computing gains an ever-greater foothold in the DevOps community, organizations are using more off-the-shelf containers for their projects and platforms. But these containers are supersized, containing more features and code libraries than the application needs. While this approach serves the container providers, it expands the attack surface of the application. Labs is pioneering a method to “right size” container code for an application, “DeBloating” the container to the essential code needed. Labs piloted this capability with a major telco to show how a DeBloat could reduce the overall size of a container while also significantly reducing the number of vulnerabilities in it (and thus also reducing the lifecycle management costs of the application). For this client, we projected more than 50,000 vulnerabilities would be removed if DeBloat were used across their container enabled applications, resulting in a more secure codebase.



05

# Building impossible

Paving the way for powerful systems and platforms

#LabsInnovationReport

## Systems & Platforms

### Taking robotic surgery to the edge

The rate of robotic surgeries is increasing by 25% annually.<sup>5</sup> Accenture Labs has helped a global medical device manufacturer develop a new Robotic Surgery Platform to securely connect computing and robotics components needed for digitally-assisted surgery. This enables future possibilities like 3D-printed surgical instruments, accelerated surgeon training, patient personalization, and more. The platform has been designed to bring together an ecosystem of healthcare partners in support of better patient outcomes. Labs' role has included developing the edge architecture connecting advanced robotics and medical devices, with supporting IoT infrastructure and clinical data management components.

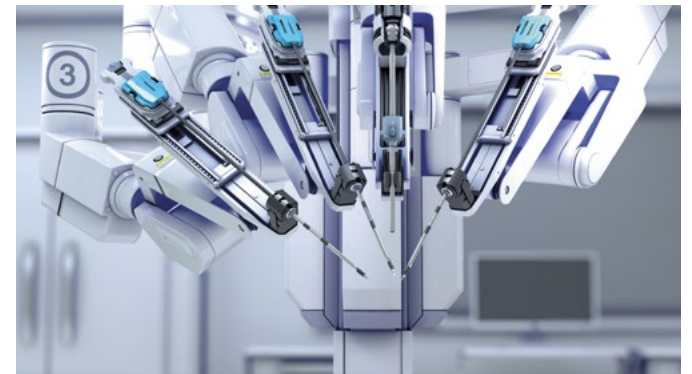

### Bringing harmony to disparate blockchain ecosystems

According to the World Economic Forum, 2020 will be a pivotal year for blockchain and distributed ledger technology. There are numerous production systems underway, across a dozen industries, powered by different blockchain platforms. Important initiatives are being pursued in global trade, as well as digital currencies and economic inclusion. But, as the number of practical use cases grows, there's a need to ensure different blockchain systems can talk to each other and enable secure exchanges of information. This is a critical challenge in enabling the broader adoption of the technology. To this end, the Sophia Antipolis Lab has developed and implemented solutions to enable the integration of two or more blockchain ecosystems, focusing initially on permissioned ledgers and the transfer of non-fungible assets. The team is also open sourcing its code base under the Hyperledger umbrella.

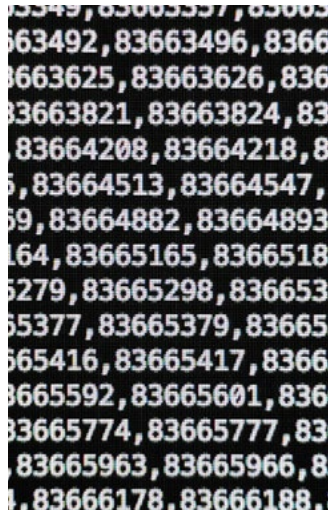

Workshop in action at Sophia Antipolis Lab

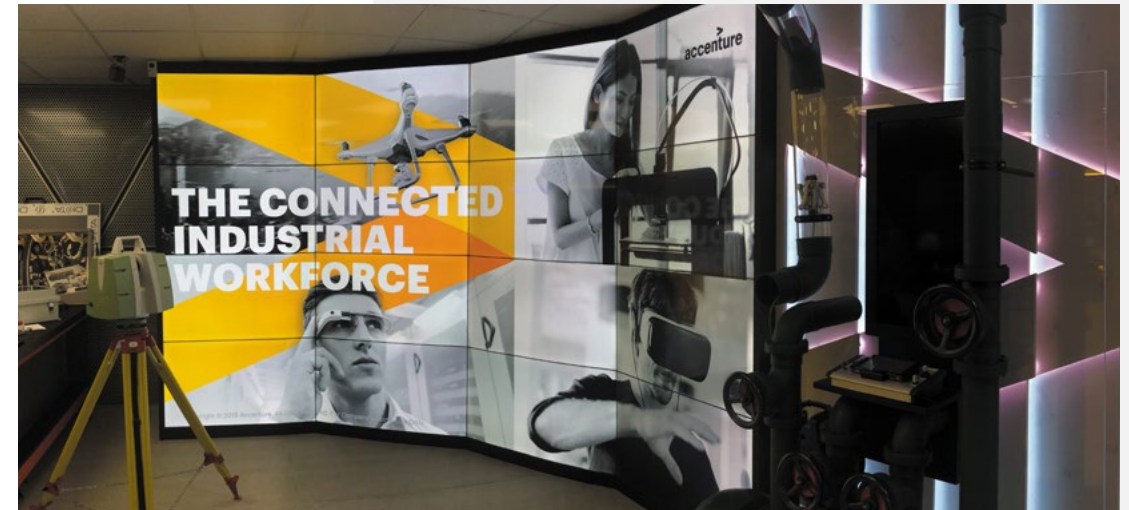

Sophia Antipolis Lab

### Sharing data securely with homomorphic encryption

Homomorphic encryption is opening up new possibilities for sharing sensitive data across multiple organizations. Accenture's research shows that enterprises understand the importance of third-party ecosystems in creating new growth. Over a third said the number of organizations they partner with had doubled or more over the last two years and over two-thirds expect the volume of data exchanged with ecosystems to increase.<sup>6</sup> However, issues of trust, security and fear of losing competitive advantage are still hindering this data sharing and collaboration. Because homomorphic encryption preserves the ability to perform computation and analysis on the data without compromising security, it offers a very promising solution. Accenture Labs has been working with a group of partners to show how a homomorphic encryption solution can be used to access and apply analytics to data on a blockchain. The work has resulted in a proof of concept for improving forecasting in a smart supply chain, which was showcased at the Semicon West Conference 2019.



# Engineering impossible

**Creating more collaborative software development**

## Application Engineering

### **Accelerating the future of application engineering with XRaSE**

The rapid recent progress in application engineering methodologies and paradigms is yet to be truly reflected in the way teams collaborate throughout the software development life cycle. To resolve this disparity, Accenture Labs has been developing XRaSE (eXtended Reality and Software Engineering). Moving beyond textual representations and 2D displays, XRaSE leverages augmented reality to visualize a software application in three dimensions, supporting a richer and more intuitive collaborative experience. Early prototypes have included immersive knowledge transfer experiences and augmenting the software delivery bay with new insights.



*Envisioning the future of software engineering at the Bangalore Lab*



### Testing machine learning models for trust

From autonomous vehicles to applications that help select the right spectacle frames, AI and machine learning are now all-pervasive. But development teams face numerous challenges in building robust models that provide a trustworthy experience to users. Accenture Labs has developed a novel Testing for Trust framework and tool that helps evaluate the robustness, generalizability and interpretability of machine learning models. The framework uses an extensive catalog of techniques like invariant analysis, adversarial input and patching as well as LIME to identify defects in a model. By providing actionable information to testers, it can improve the quality of machine learning models, leading to higher trust in the system.

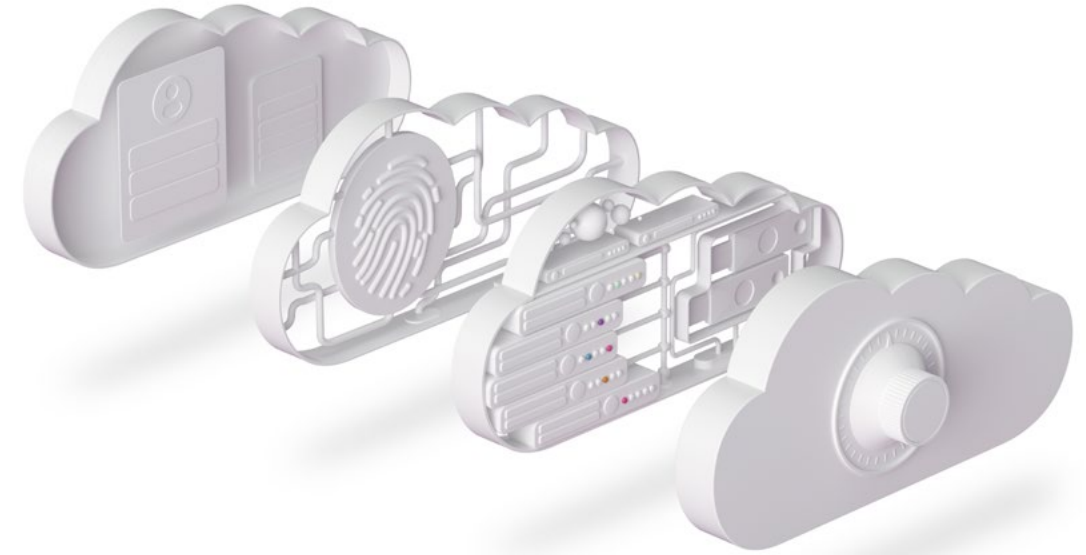

### Optimizing application containerization for cloud interoperability

Application container platforms and container management services are one of the key ways enterprises can ensure cloud interoperability and maximize their cloud investments. However, these platforms can often require complex applications to be partitioned and then deployed and scaled separately. Determining the best partitioning strategy that balances functional coherence with reliability and maintainability can be a real challenge. Accenture Labs has patented

a system that uses static and dynamic code analysis, along with heuristics and multi-objective optimization, to rapidly suggest possible partitions. Using their tacit and domain knowledge, architects are then able to decide the best strategy for containerization and cloud interoperability. This work is part of a range of migration assessment and advisory tools and frameworks Accenture Labs has built to accelerate the adoption of cloud.

07

# Driving impossible

Sparking innovation with cutting-edge ideas

#LabsInnovationReport

## Industry X.0

**Accenture Labs Industry X.0 initiative focuses on driving forward the next wave of digital transformation in manufacturing**



*We're exploring how creative tools and living processes are reshaping the future of experiences*



### Bridging the distance between people with an Immersive Collaboration Platform

The Sophia Antipolis Lab has developed an Immersive Collaboration Platform (ICP) which brings people together, wherever they are in the physical world, in an immersive and collaborative virtual reality environment. Participants on the platform, whether colleagues, partners, or any other invitees, are able to interact with digital objects—and each other—in the virtual environment in an easy, compelling and collaborative way. Through a combination of sensorial and immersive technologies, Labs is shaping the future of immersive collaborative experiences.



Immersive experiences at Sophia Antipolis Lab



360 "Igloo" in the San Francisco Lab

### Pushing the industrial envelope with Intelligent 3D Scanning

Industry X.0 is, in essence, about reimagining how we develop new products and services based on new processes and technologies. But it's also about expanding the realm of the possible. Labs has been developing intelligent 3D scanning technology which captures and analyzes real-world environments. It provides the foundation for new forms of workplace experience that provide total immersion in high-fidelity environments, with numerous potential applications in workforce learning, training, supervision, and more.





## Accenture Technology Vision 2020

**Accenture's annual Technology Vision continues to be our most widely viewed and distributed piece of thought leadership. In 2020, we're once again pinpointing key technology trends that will affect businesses over the next one to three years.**

To continue growing and stay competitive, businesses must revisit their fundamental models of business and technology and better align them with people today. This starts with acknowledging how technology has become an inextricable part of the human experience and identifying where people's expectations for technology have outgrown today's standards. From there, businesses must build a better, human-centered future, emphasizing trust, data, and deeper experiences.

Tech-clash is a challenge waiting to be solved: people still love technology. The enterprises that find a way to deliver it in line with people's expectations will blaze the trail for everyone else.



# Accenture Technology Vision 2020 explores five key trends that are transforming society and creating the foundation for future enterprise growth

## Technology Vision 2020 builds on last year's huge success

Five months after launch, the 2019 Vision had received over 275,000 visits to its microsite and 25,000 online branded mentions (more than twice the number of the previous year). It had also been the subject of over 400 unique media placements as well as a staggering 62.5 million social media impressions.

For more about Accenture's Technology Vision, please visit:

[www.accenture.com/techvision](http://www.accenture.com/techvision)



### The I in Experience

#### Helping people choose their own adventure

Redesign digital experiences with new models that amplify personal agency. Turn passive audiences into active participants by transforming one-way experiences into true collaborations.



### AI and Me

#### Reimagine the business through human and AI collaboration

Take a new approach that uses artificial intelligence to bring out the full power of people. Move beyond deploying AI for automation alone and push into the new frontier of co-creation between people and machines.



### The Dilemma of Smart Things

#### Overcome the "beta burden"

Address the new reality of product ownership in the era of "forever beta." Transform pain points into an opportunity to create an unprecedented level of business customer partnership.



### Robots in the Wild

#### Growing the enterprise's reach—and responsibility

Build new models of interaction and impact as robotics move beyond the walls of the enterprise. Companies in every industry will unlock new opportunities by introducing robots to the next frontier: the open world.



### Innovation DNA

#### Create an engine for continuous innovation

Tap into the unprecedented scale of disruptive technology available today. Build the capabilities and ecosystem partnerships necessary to assemble the organization's unique innovation DNA.

A close-up photograph of a robotic arm in a greenhouse. The arm is white and black, with a blue sensor or camera lens at the end. It is positioned over rows of green leafy plants growing in black plastic mulch. The background shows the structure of the greenhouse with translucent panels.

09

# Sustaining Impossible

**Nurturing clients through  
sustainable innovation initiatives**

## Tech4Good

**Accenture Labs applies cutting-edge technologies in innovative ways to help build a more inclusive and sustainable world. Through our cross-group Tech4Good initiative, we're supporting positive social transformation at scale with clients and Social Innovators from across the company using technologies like AI, IoT, blockchain and augmented reality.**

### **Fighting the scourge of human trafficking with AI**

Law enforcement agencies know that victims of human trafficking are often hidden in plain sight among the thousands of classified advertisements for escort services. But distinguishing them from legal adverts by eye is a frustrating and difficult process. Working with Stanford University and the University of Michigan, Accenture Labs used natural language processing to build a context-aware classifier able to identify high-risk cases with 90% accuracy. Thanks to our work, law enforcement agencies are able to devote their resources to cases most likely to involve trafficking victims.



## Boosting STEM skills and vocations with the XR Future Skills Builder

Building on last year's success with its extended reality 'Future Skills Builder' pilot developed as part of our social impact programs, the Sophia Antipolis' Lab is transforming its skills-developing minigame experience into a global curriculum for exploring computer science, electronics and robotics in primary schools. Composed of nine different sessions and piloted in six local school districts, the curriculum builds the Skills to Succeed for the next generation. The Lab will now extend the pilot to five new schools, and the initiative has been selected by the Femmes@Numerique Foundation for scaling across France. The overarching objective is to increase STEM inclusion and begin building STEM vocations early.

## Navigating the complexities of last-mile healthcare

Accenture Labs in India is working with MAYA Healthcare and India Corporate Citizenship to create a viable technology-supported business model for delivering last-mile preventative healthcare in underserved rural and semi-urban communities. Bringing together healthcare microentrepreneurs ("health navigators") with private clinics and government-run hospitals, our platform supports easy to use health monitoring tools for use in the field. The solution has been piloted with 50,000 people living in Karnataka, India. See more here:

[Watch the video](#)



## Harnessing data science to improve access to clean water

Clean water changes lives. That's why the innovative nonprofit charity: water is on a mission to bring clean and safe drinking water to people in developing countries. Known for its commitment to transparency and accountability, the organization is working to reinvent charity on its way to ending the water crisis.

Using machine learning and advanced probabilistic models, Accenture Labs built a predictive maintenance solution to help charity: water monitor water usage with data from thousands of smart pumps in remote locations. This will allow the organization to better see patterns in the data, detect anomalies, and proactively maintain the pumps. The ultimate goal is to reduce maintenance costs, operate efficiently at scale, and expand the reach of charity: water's work.



## Expanding the Tech4Good reach with global leaders

Accenture Labs hosted an immersive workshop at the Tech Leadership Development Program 2019. With a series of high-profile guest speakers from the global social transformation community, we explored the theme of “empathy to innovation” in a hugely well received session, helping leadership participants gain a clearer understanding of the potential for new technology and human-centered design to solve accessibility challenges and drive innovation for everyone.



## Promoting financial inclusion and education with the Grameen Foundation

Accenture Labs received a series of honorable mentions in the Fast Company’s 2019 World Changing Ideas Awards for its work on EASE and the Grameen Guru. These innovations, created in partnership with the Grameen Foundation India, are designed to help overcome barriers to financial services. EASE (Emotion Analytics for Social Enterprises) is a mobile and web app that uses emotion AI to help microfinance advisers spot undue pressure being placed on potentially vulnerable loan applicants. Grameen Guru is an app that uses augmented reality, image recognition, and a multilingual chatbot to help smartphone users with limited literacy understand financial products and services.



## Accelerating efforts to promote nature conservation

Accenture Labs has been working on several projects to use technology to combat the threats of climate change and species extinction. In one initiative, we used automated image tagging to help scientists scale up their analysis of coral reefs, with a view to developing more resilient “future-proofed” reef systems. In another, we worked with the Bombay Natural History Society in Mumbai to develop an “Internet of Birds” mobile app which uses artificial intelligence to identify bird species. The app, which was launched at the International Conference on Wetland Birds in India, can also provide visualizations of birds’ migratory paths using virtual reality. This year, the app’s capabilities have increased the number of identified birds to 700.



# How we scale innovation for our clients

## Shaping the Future Program

**The Accenture Labs Shaping the Future program helps clients explore, understand, and shape the long-term future of their businesses and industries.**

Our interdisciplinary teams apply new thought leadership to guide clients as they examine the interplay of bold, provocative, speculative technologies and numerous global societal, environmental, economic and political factors. These workshops help companies understand what the future holds through 2030 and beyond—and what they should prioritize to achieve maximum impact.

Early areas of exploration have included the future of products and services, the future of the design process, and the future of entertainment. The team helped host a healthcare technology innovation challenge, in which 50 executives from across the health ecosystem reimaged the state of healthcare in 2030 in an immersive session hosted at the Accenture San Francisco Innovation Hub. Most recently, we collaborated with the leadership team at a large media client to explore the future of entertainment products and services, and help set a vision and innovation roadmap over ten years.



## 10 How we scale innovation for our clients

### Labs Innovation Workshops

The Accenture Labs Innovation Workshops program uses interactive workshops and technology demonstrations to help clients engage with R&D. The program aims to foster thought-provoking discussions about what it means to operate a next-generation digital business in today's global economy. In 2019, we helped scale innovation around the world by sponsoring over 1,000 events across all our Labs locations for both internal audiences and valued clients.

Client teams visit the workshops to learn about and envision cutting-edge technologies, and to define new strategies and solutions in collaboration with Accenture scientists, technologists and business consultants. The location of the events is flexible: they can be held onsite, offsite or virtually. Formats are customized to address the business priorities of each client and can include full or multi-day workshops, full or part-day educational seminars, and Labs overviews and demonstration tours.

### Nano Labs

Spanning the world, from Riga to Buenos Aires and from Bratislava to Monterrey, our Nano Labs have a mission to inspire and guide clients with breakthrough technology innovations. Able to connect with researchers from any Nano Lab location, even via virtual reality, participants can immerse themselves in emerging technologies and understand how new trends will impact their future business operations.

Each Nano Lab is hosted by a dedicated Innovation Lead who gives clients a sense of the R&D we do in our seven global Labs and showcases the Accenture Technology Vision. Participants have the opportunity to see demonstrations illustrating key technology trends and follow-on discussions with Labs experts.

We continue to expand our Nano Labs' footprint around the world, most recently in Medellín, Colombia and in Hyderabad and Pune, India.

*Accenture Nano Lab in Medellín, Colombia*



## 10 How we scale innovation for our clients

### University relationships

**Accenture Labs' university program enables us to collaborate with elite research institutions around the world. These collaborations are critical in accelerating and deepening our R&D agenda, enabling us to tap into the best research and talent in the broader research community and fast-track new ideas into practical applications for our clients.**

Here are some examples of our work with leading universities and research institutions across the globe:

- Our relationship with Stanford has spanned everything from combating human trafficking with AI to accelerating machine learning development.
- We also work with Carnegie Mellon's School of Public Policy on ethical AI and online misinformation initiatives, as well as with Duke University and MIT on detecting new classes of cyberattacks specific to machine learning systems.
- The Dublin Lab has been deeply engaged with the Turing Institute on the issue of explainable AI.
- The Tel Aviv Lab is working with the Technion Israel Institute of Technology, Unibz in Bolzano, Italy, and the Universitat Politècnica de València on a framework for temporal knowledge graphs to allow inference and reasoning about security events over time.
- The Bangalore Lab is collaborating on knowledge graphs and multi-modal interactions with the India Institute of Science, IIT Bangalore and other top research institutions.

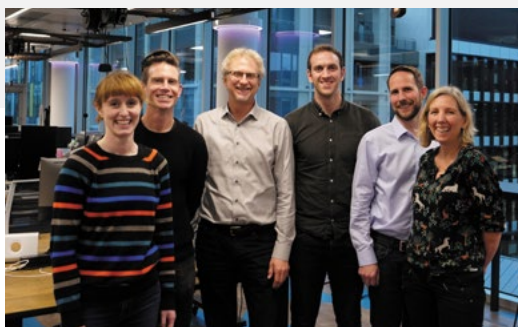

Dublin Lab



Bangalore Lab



### Accenture Ventures

**Accenture Ventures is a key part of Accenture's innovation architecture, offering clients a bridge to the global innovation ecosystem, enabling them to unlock growth opportunities and accelerate transformation by working with best-in-class enterprise startups.**

The Accenture Ventures team co-innovates with clients to match their business opportunities with the emerging and disruptive technology players that are best placed to unlock their transformation potential and catalyze growth. It looks to inspire clients with innovative ideas and solutions for solving today's problems and capitalizing on tomorrow's opportunities, leveraging Accenture's global reach:

- Expanding global network of 40+ countries.
- Open innovation applied across all industries Accenture serves.
- Innovation-based methodology and toolset (including a platform tracking thousands of startups).
- Investment portfolio of 30+ innovative startups.
- Global ecosystem partner network of 50+ accelerators and venture capitalists.

# What's next?

**Over the coming year, we'll be focusing on three priority themes: visionary, grounded and collaborative.**

## Visionary

We're pushing our R&D agenda further out with the Shaping the Future program, as well as a new "Incubation" R&D group which is focusing on research areas that are five or more years out. We've already made a start with smart materials R&D, which sits at the intersection of material science and information technology. This research will place a special focus on materials that can dynamically change their characteristics (such as their color and shape). This new R&D group will also be exploring neuromorphic computing, expanding our heterogenous computing platform which now ranges from GPGPU to FPGA to quantum computing.

## Grounded

We'll be expanding our footprint with our marquee clients on multi-year strategic co-research programs across the globe. Our R&D locations are now grouped into three regions—Americas, Europe and Asia—to ensure alignment with Accenture's recently announced Next Generation Growth Model and how we go to market.

## Collaborative

We'll be striving to drive the combinatorial effect of applied R&D through close collaboration with major university programs, our clients and across all Labs locations. This will encompass everything from Industry X.0 and artificial general intelligence to ethics and fairness to talent management and human-robot teaming.







## How can I engage with Accenture Labs?

01/

### Discover what's next with the Technology Vision.

Every year, Accenture Labs identifies the technology trends that will shape the way business is done over the next 12 months and beyond. For more information please visit: [www.accenture.com/techvision](http://www.accenture.com/techvision)

02/

### Get involved in a Labs Innovation Workshop

Labs offer dedicated workshop programs where you can discover the latest global research, discuss your challenges with our researchers, co-create disruptive use cases and identify opportunities for future collaboration. See page 45 for more.

03/

### Kick-start a co-research program.

Our co-research initiatives are long-term engagements during which our research teams work directly with your business to tackle a strategic challenge in your industry.

04/

### Engage with the Shaping the Future program.

The Accenture Labs Shaping the Future program gets you thinking about how products and services in your industry will evolve and can be shaped over a ten-year-plus horizon. See page 44 for more.

## About Accenture Labs

Accenture Labs incubates and prototypes new concepts through applied R&D projects that are expected to have a significant impact on business and society. Our dedicated team of technologists and researchers work with leaders across the company and external partners to imagine and invent the future.

Accenture Labs is located in seven key research hubs around the world: San Francisco, CA; Sophia Antipolis, France; Washington, D.C.; Shenzhen, China; Bangalore, India; Herzliya, Israel and Dublin, Ireland; and Nano Labs across the globe. The Labs collaborates extensively with Accenture's network of nearly 400 innovation centers, studios and centers of excellence located in 92 cities and 35 countries globally to deliver cutting-edge research, insights and solutions to clients where they operate and live. For more information, please visit [www.accenture.com/labs](http://www.accenture.com/labs)

## Join the conversation @AccentureLabs

Copyright © 2020 Accenture.  
All rights reserved.

Accenture and its logo are  
trademarks of Accenture.

## About Accenture

Accenture is a leading global professional services company, providing a broad range of services in strategy and consulting, interactive, technology and operations, with digital capabilities across all of these services. We combine unmatched experience and specialized capabilities across more than 40 industries—powered by the world's largest network of Advanced Technology and Intelligent Operations centers. With 505,000 people serving clients in more than 120 countries, Accenture brings continuous innovation to help clients improve their performance and create lasting value across their enterprises. Visit us at [www.accenture.com](http://www.accenture.com)

## References

1. <https://www.newequipment.com/research-and-development/article/22059780/what-generative-design-is-and-why-its-the-future-of-manufacturing>
2. <https://www.globenewswire.com/news-release/2019/12/17/1961393/0/en/Globa-AR-and-VR-Market-in-Aviation-2019-2025-Set-to-Register-a-CAGR-of-61-2-with-Massive-Opportunities-in-AI-and-ML-Integration.html>
3. <https://www.climatecentral.org/gallery/graphics/2019-billion-dollar-disasters>
4. <https://www.accenture.com/us-en/insights/security/cost-cybercrime-study>
5. <https://www.beckersasc.com/asc-news/11-things-to-know-about-robotic-surgery.html>
6. <https://www.weforum.org/agenda/2020/01/blockchain-in-2020-epic-changes-and-monumental-challenges>

This document makes descriptive reference to trademarks that may be owned by others. The use of such trademarks herein is not an assertion of ownership of such trademarks by Accenture and is not intended to represent or imply the existence of an association between Accenture and the lawful owners of such trademarks.