



traction elevators
2008 planning guide

ThyssenKrupp Elevator
Americas Business Unit



ThyssenKrupp



Design, Performance, Dependability

At ThyssenKrupp Elevator, we believe in the critical importance of listening to our customers. While technological expertise makes our products and services possible, we know that listening to our customers is what keeps us at the top of our industry. That's because our commitment to listening leads to the innovations that satisfy our customers' needs, driving us continually to set new standards for elevator performance and reliability.

Because we always listen to our customers, they have come to regard ThyssenKrupp Elevator as an integral part of their projects. In addition to their confidence in the quality of our products, they know that each of our standard-sized passenger elevators meets the requirements of the Americans with Disabilities Act (ADA) and that we will modify our elevators to comply with local fire service codes. Perhaps most of all, customers rely on our nationwide network of service locations. And even if your building is remotely located, no point in the U.S. is more than 75 miles from a ThyssenKrupp Elevator service technician.

Geared and Gearless Traction Elevators

In the field of traction systems, ThyssenKrupp Elevator's designers and engineers push their technological creativity to its full potential. Whether geared or gearless, our traction elevators combine the latest digital technology with world-renowned manufacturing expertise to achieve a new level of precision, energy efficiency, safety and reliability.

For buildings of up to twenty-seven floors, ThyssenKrupp Elevator's complete line of SPF geared traction elevators are known for their smooth, quick acceleration, high energy efficiency and competitive pricing. ThyssenKrupp Elevator's gearless systems for high-rise buildings are famous for their versatility, power and, above all, speed.

Geared or gearless, all of our traction systems utilize the advanced vector control technology of our all-digital centralized microprocessor control systems to move a lot of people in amazingly little time.

Table of Contents

Architect Direct Pro	2
SPF Traction Elevators	
Passenger, with Front Openings.	3
Passenger, with Front and Rear Openings	4
SPF Traction Elevators For Patient Care Facilities	5
AC Gearless Traction Elevators For High-Rise Buildings	
Custom-Engineered Passenger, Up To 700 fpm	6
Custom-Engineered Passenger, Up To 1200 fpm	7
Cab Design	8-9
TK Entrances Details.	10
Work Not Included	11

Architect Direct Pro

When you're putting together a proposal, we know you don't have all day to spend on elevator selection. So we've created a solution that enables you to find the right elevator - and get specifications and drawings - as fast as a few clicks of the mouse.

This solution is Architect Direct **Pro** and you'll find it at thyssenkruppelevator.com. All you have to do is answer a few questions about your building, and Architect Direct **Pro** will tell you which of our standard elevators is best suited to your project. It's that easy.

You'll probably want specifications. With a few more clicks, Architect Direct **Pro** will compile a complete specifications document ready for download in Microsoft Word.

For more information, please contact your local ThyssenKrupp Elevator representative or visit www.thyssenkruppelevator.com.

SPF Traction Elevators

Passenger Elevators with Front Entrances

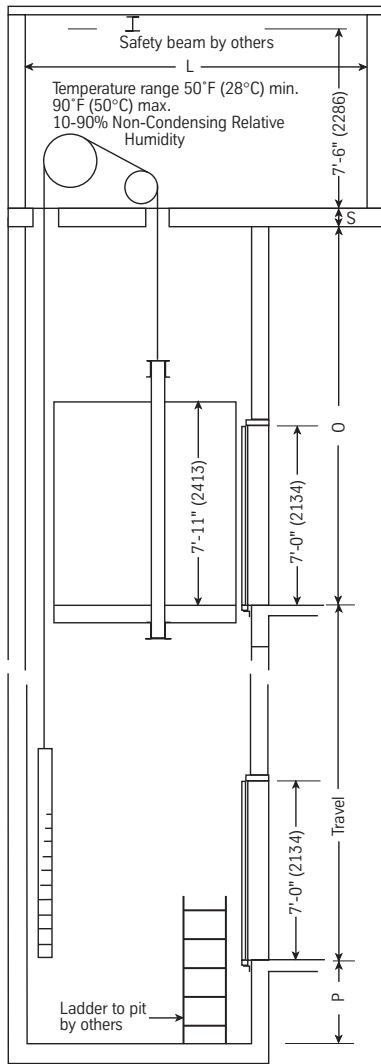
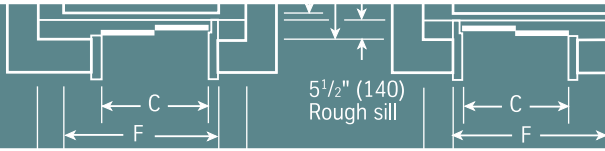

S = Concrete structural support slab by others.
Machine room floor to support all elevator machine loads and floor loads per ASME A17.1.

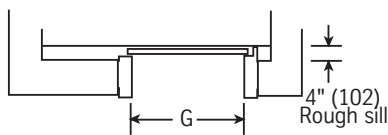

Right hand door shown: left hand available

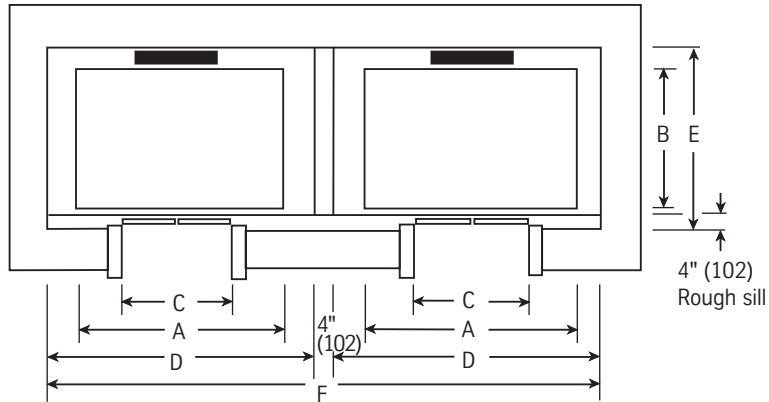

	SPF-21	SPF-25	SPF-30	SPF-35	SPF-40 (IBC)
	Capacity in pounds				
Dimensions	2100 (953 kg)	2500 (1134 kg)	3000 (1361 kg)	3500 (1588 kg)	4000 (1814 kg)
A¹	5'-8" (1727)	6'-8" (2032)	6'-8" (2032)	6'-8" (2032)	7'-8" (2337)
B¹	4'-3" (1295)	4'-3" (1295)	4'-9" (1448)	5'-5" (1651)	5'-5" (1651)
C	N/A ⁵	3'-6" (1067)	3'-6" (1067)	3'-6" (1067)	4'-0" (1219) ⁶
D²	7'-4" (2235)	8'-4" (2540)	8'-4" (2540)	8'-4" (2540)	9'-4" (2845)
E³	6'-8" (2032)	6'-8" (2032)	7'-2" (2184)	7'-10" (2388)	7'-10" (2388)
F⁴	15'-0" (4572)	17'-0" (5182)	17'-0" (5182)	17'-0" (5182)	19'-0" (5791)
G	3'-0" (914)	3'-6" (1067)	3'-6" (1067)	3'-6" (1067)	3'-6" (1067) ⁶

1 Clear inside dimensions. 2 Single car dimensions (Add 4" (102) for seismic).
3 Add 2" (51) for seismic. 4 Two car dimensions (Add 8" (203) for seismic).
5 Center opening not available on this model, see "C" for dimensions.
6 The door sizes shown comply with 2006 IBC code requirements.

Minimum pit, overhead and machine room dimensions

Capacity in lbs.	Dimensions	Speed feet per minute (fpm)		
		200 (1.0m/s)	350 (1.7m/s)	450/500 (2.2/2.5m/s)
2100 (953 kg)	L	16'-0" (4877)	16'-0" (4877)	N/A
	O	15'-0" (4572)	15'-0" (4572)	N/A
	P ⁷	5'-0" (1524)*	5'-0" (1524)*	N/A
2500 (1134 kg)	L	16'-0" (4877)	16'-0" (4877)	16'-0" (4877)
	O	15'-0" (4572)	15'-0" (4572)	16'-0" (4877)
	P ⁷	5'-0" (1524)*	5'-0" (1524)*	6'-6" (1981)
3000 (1361 kg)	L	16'-0" (4877)	16'-0" (4877)	16'-0" (4877)
	O	15'-0" (4572)	15'-8" (4775)	16'-0" (4877)
	P ⁷	5'-0" (1524)*	5'-0" (1524)*	6'-6" (1981)
3500 (1588 kg)	L	16'-0" (4877)	16'-0" (4877)	16'-0" (4877)
	O	15'-0" (4572)	15'-8" (4775)	17'-2" (5232)
	P ⁷	5'-0" (1524)*	5'-0" (1524)*	6'-6" (1981)
4000 (1814 kg)	L	16'-0" (4877)	16'-0" (4877)	N/A
	O	15'-0" (4572)	16'-0" (4877)	N/A
	P ⁷	5'-0" (1524)*	5'-0" (1524)*	N/A

7 Consult ThyssenKrupp Elevator for pit with travel over 250'-0" (76200).
NOTE: Hoistway dimensions are based on 1" (25) out of plumb and no occupied space below hoistway.
If these conditions cannot be met, then consideration must be given for additional required space.
* 5'-9" Pit may be required for 2000 code compliance, if 48" retractable toe guard not used.



SPF Traction Elevators

Passenger Elevators with Front and Rear Entrances

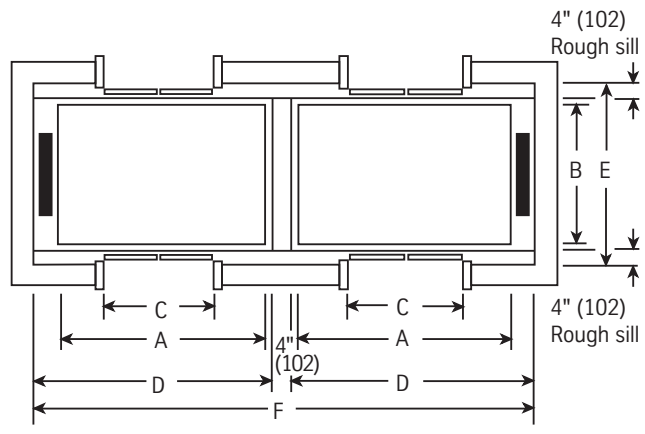

ThyssenKrupp Elevator offers a complete line of SPF geared traction elevators that can serve up to 27 landings. Our SPF line offers superb performance in office buildings, apartment complexes, dormitories, hotels and other structures. These elevators offer you standard design data, quick layout and fast delivery.

	SPF-25	SPF-30	SPF-35
Capacity in lbs.	2500 (1134 kg)	3000 (1361 kg)	3500 (1588 kg)
Dimensions	Plan 2	Plan 2	Plan 2
A¹	6'-8" (2032)	6'-8" (2032)	6'-8" (2032)
B¹	4'-3 1/2" (1308)	4'-9 1/2" (1461)	5'-5 1/2" (1664)
C	3'-6" (1067)	3'-6" (1067)	3'-6" (1067)
D²	9'-2" (2794)	9'-2" (2794)	9'-2" (2794)
E	6'-8 3/4" (2051)	7'-2 1/4" (2203)	7'-10 3/4" (2407)
F³	18'-8" (5690)	18'-8" (5690)	18'-8" (5690)
G	3'-6" (1067)	3'-6" (1067)	3'-6" (1067)

1 Clear inside dimensions.
 2 Single car dimensions (Add 6" (152) for seismic).
 3 Two car dimensions (Add 12" (305) for seismic).
NOTE: Hoistway dimensions are based on 1" (25) out of plumb and no occupied space below hoistway. If these conditions cannot be met, then consideration must be given for additional required space.

Minimum pit, overhead and machine room dimensions

Capacity in lbs.	Dimensions	Speed feet per minute (fpm)		
		200 (1.0m/s)	350 (1.7m/s)	450/500 (2.2/2.5m/s)
2500 (1134 kg)	L	16'-0" (4877)	16'-0" (4877)	16'-0" (4877)
	O	15'-0" (4572)	15'-0" (4572)	16'-0" (4877)
	P⁴	5'-0" (1524)*	5'-0" (1524)*	6'-6" (1981)
3000 (1361 kg)	L	16'-0" (4877)	16'-0" (4877)	16'-0" (4877)
	O	15'-0" (4572)	15'-8" (4775)	16'-0" (4877)
	P⁴	5'-0" (1524)*	5'-0" (1524)*	6'-6" (1981)
3500 (1588 kg)	L	16'-0" (4877)	16'-0" (4877)	16'-0" (4877)
	O	15'-0" (4572)	15'-8" (4775)	17'-2" (5232)
	P⁴	5'-0" (1524)*	5'-0" (1524)*	6'-6" (1981)

4 6'-0" (1829) min. "P" above 110'-0" (33528) travel.
 Consult ThyssenKrupp Elevator for travel over 250'-0" (76200).
 * 5'-9" Pit may be required for 2000 code compliance, if 48" retractable toe guard not used.

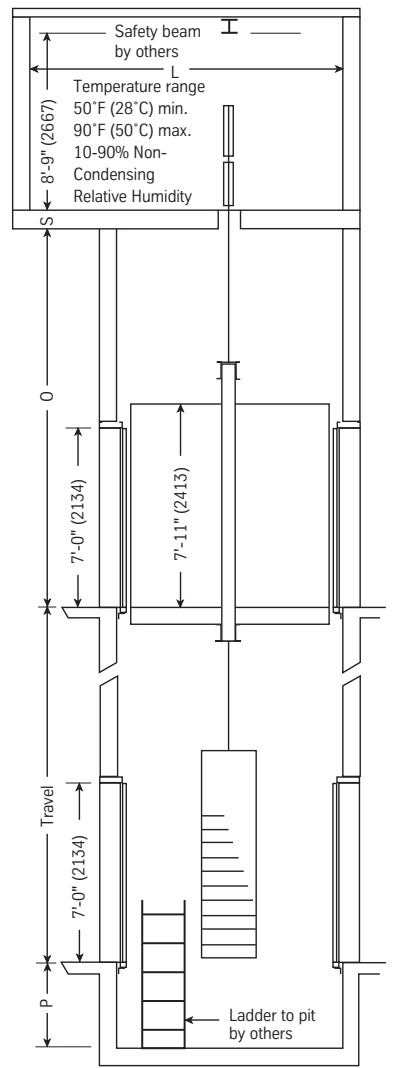

S = Concrete structural support slab by others.
Machine room floor to support all elevator machine loads and floor loads per ASME A17.1.

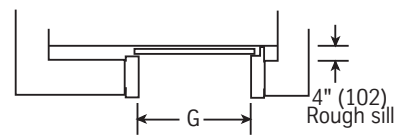

Right hand door shown: left hand available

Note: All dimensions in parentheses are in millimeters unless otherwise indicated. Dimensional data shown here complies with the current ASME A17.1 and CSA B44 Safety Code for Elevators. Local codes may vary from the national codes. Consult your local ThyssenKrupp Elevator representative for details.

SPF Traction Elevators For Patient-Care Facilities

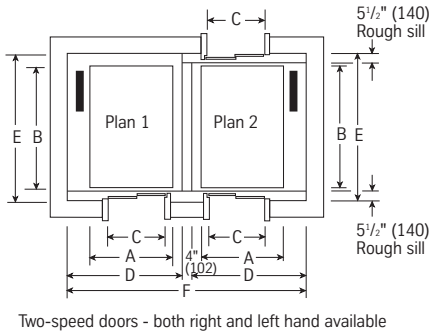
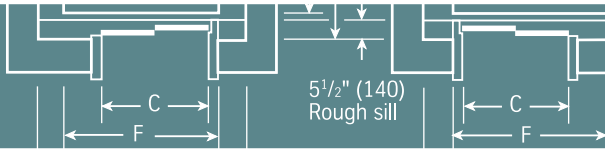

Our SPF-45, SPF-50 and SPF-50H elevators offer economical, dependable service for hospitals, nursing homes and intermediate care facilities. The car shape makes it ideal for use in any building where the elevator performs a dual role for passengers and service. The SPF-50H is now the standard size hospital car set forth to meet AIA requirements.

Capacity in lbs.	SPF-45		SPF-50		SPF-50H			
	4500 (2041 kg)		5000 (2268 kg)		5000 (2268 kg)		6000 (2722 kg)	
	Dimensions		Dimensions		Dimensions		Dimensions	
	Plan 1	Plan 2	Plan 1	Plan 2	Plan 1	Plan 2	Plan 1	Plan 2
A ¹	5'-8" (1727)	5'-8" (1727)	5'-8" (1727)	5'-8" (1727)	5'-8" (1727)	5'-8" (1727)	6'-0" (1829)	6'-0" (1829)
B ¹	7'-9 1/2" (2375)	7'-10" (2388)	8'-5" (2565)	8'-5 1/2" (2578)	9'-0" (2743)	9'-0 1/2" (2756)	9'-5" (2870)	9'-5 1/2" (2883)
C ²	4'-0" (1219)	4'-0" (1219)	4'-0" (1219)	4'-0" (1219)	4'-0" (1219)	4'-0" (1219)	5'-0" (1524)	5'-0" (1524)
C ³	4'-6" (1372)	4'-6" (1372)	4'-6" (1372)	4'-6" (1372)	4'-6" (1372)	4'-6" (1372)	N/A	N/A
D ⁴	8'-1" (2464)▲	8'-1" (2464)▲	8'-1" (2464)▲	8'-1" (2464)▲	8'-3" (2515)▲	8'-3" (2515)▲	8'-11" (2718)▲	8'-11" (2718)▲
D ⁵	8'-3" (2515)▲	8'-3" (2515)▲	8'-3" (2515)▲	8'-3" (2515)▲	8'-3" (2515)▲	8'-3" (2515)▲	N/A	N/A
E	9'-8" (2946)	10'-9 1/4" (3283)	10'-2" (3099)	11'-4 1/4" (3473)	10'-9" (3277)	11'-11 1/4" (3651)	11'-2" (3404)	12'-4 1/4" (3778)
F ⁶	16'-6" (5029)▲	16'-6" (5029)▲	16'-6" (5029)▲	16'-6" (5029)▲	16'-10" (5131)▲	16'-10" (5131)▲	18'-2" (5537)▲	18'-2" (5537)▲
F ⁵	16'-10" (5131)	16'-10" (5131)	16'-10" (5131)	16'-10" (5131)	16'-10" (5131)	16'-10" (5131)	N/A	N/A

Shaded background indicates pre-engineered models.

- 1 Clear inside dimensions.
- 2 Standard door width.
- 3 Optional door width.
- 4 Single car dimensions (Add for seismic ▲ = 4 1/4" (108) • = 3" (76).
- 5 Required with 4'-6" (1372) doors.
- 6 Two car dimensions (Add for seismic ■ = 8 1/2" (216) ◆ = 6" (152).

NOTE: Hoistway dimensions are based on 1" (25) out of plumb and no occupied space below hoistway. If these conditions cannot be met, then consideration must be given for additional required space.

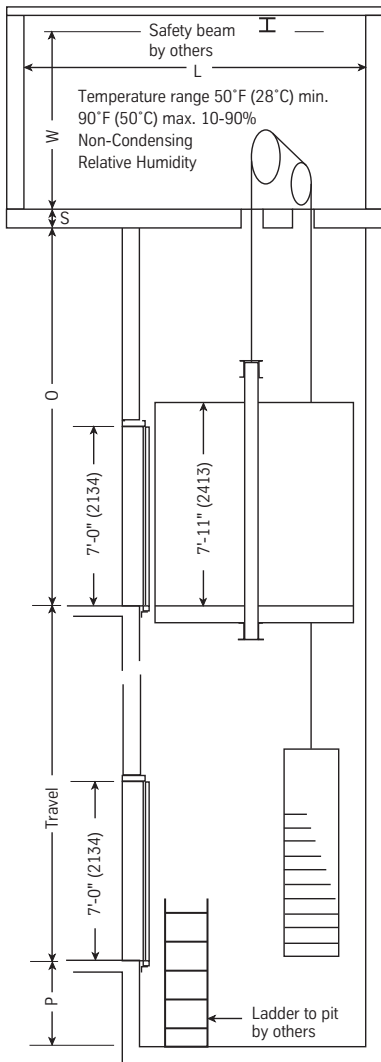

Minimum pit, overhead and machine room dimensions

Capacity in lbs.	Dimensions	Speed feet per minute (fpm)		
		200 (1.0m/s)	350 (1.7m/s)	450 (2.2m/s)
4500 (2041 kg)	L	19'-0" (5791)	19'-0" (5791)	N/A
	O	15'-0" (4572) ⁸	16'-0" (4877)	N/A
	P ⁷	5'-0" (1524)*	5'-0" (1524)*	N/A
5000 (2268 kg)	L	19'-0" (5791)	19'-0" (5791)	19'-0" (5791)
	O	15'-0" (4572) ⁸	16'-0" (4877)	17'-8" (5385)
	P ⁷	5'-0" (1524)*	5'-0" (1524)*	6'-6" (1981)
5000H (2268 kg)	L	19'-0" (5791)	19'-0" (5791)	N/A
	O	15'-0" (4572) ⁸	16'-0" (4877)	N/A
	P ⁷	5'-0" (1524)*	5'-0" (1524)*	N/A
6000 (2722 kg)	L	19'-0" (5791)	19'-0" (5791)	20'-0" (6096)
	O	16'-0" (4877)	17'-0" (5182)	17'-8" (5385)
	P ⁷	5'-0" (1524)*	5'-0" (1524)*	6'-6" (1981)

Shaded background indicates pre-engineered models.

- 7 6'-0" (1829) min. "P" above 110'-0" (33528) travel, 200-350 fpm (1.0-1.7 m/s) Consult ThyssenKrupp Elevator for travel over 250'-0" (76200).
- 8 16'-0" (4976) "O" above 167'-0" (50902) travel.

* 5'-9" Pit may be required for 2000 code compliance, if 48" retractable toe guard not used.

S = Concrete structural support slab by others. Machine room floor to support all elevator machine loads and floor loads per ASME A17.1.
W = 7'-6" (2286) [8'-0" (2438) for 5000 @ 450 and 6000 at all duties].

Note: All dimensions in parentheses are in millimeters unless otherwise indicated. Dimensional data shown here complies with the current ASME A17.1 and CSA B44 Safety Code for Elevators. Local codes may vary from the national codes. Consult your local ThyssenKrupp Elevator representative for details.

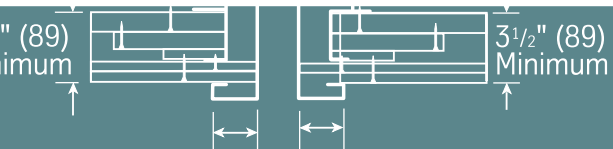

AC Gearless Traction Elevators

for 500FPM (2.5 m/s) and 700 FPM (3.6 m/s)

ThyssenKrupp Elevator's AC Gearless traction elevators are the ultimate in high-speed vertical transportation. With vector control technology, our gearless systems precisely control AC motors at speeds of 500 fpm (2.5 m/s) and 700 fpm (3.6 m/s).

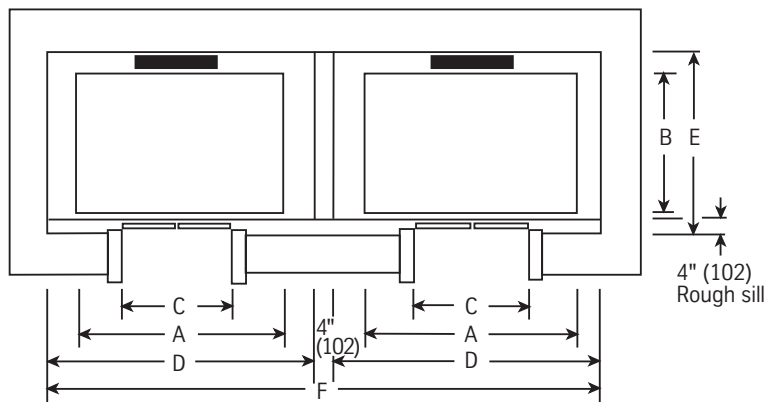

Dimensions	Capacity in pounds			
	2500 (1135 kg)	3000 (1362 kg)	3500 (1598 kg)	4000 (1816 kg)
A ¹	6'-8" (2032)	6'-8" (2032)	6'-8" (2032)	7'-8" (2337)
B ¹	4'-3" (1295)	4'-9" (1448)	5'-5" (1651)	5'-5" (1651)
C	3'-6" (1067)	3'-6" (1067)	3'-6" (1067)	4'-0" (1219)
D ²	8'-4" (2540)	8'-4" (2540)	8'-4" (2540)	9'-4" (2845)
E ³	6'-8" (2032)	7'-2" (2184)	7'-10" (2388)	7'-10" (2388)
F ⁴	17'-0" (5182)	17'-0" (5182)	17'-0" (5182)	19'-0" (5791)

- 1 Clear inside dimensions.
- 2 Single car dimensions (Add 4" (102) for seismic).
- 3 Add 2" (51) for seismic.
- 4 Two car dimensions (Add 8" (203) for seismic).

For 500 fpm (2.5 m/s) and 700 fpm (3.6 m/s), chain compensation available up to 300'-0" of travel (91440). Rope compensation required above 300'-0" of travel (91440).

NOTE: Hoistway dimensions are based on 1" (25) out of plumb and no occupied space below hoistway. If these conditions cannot be met, then consideration must be given for additional required space.

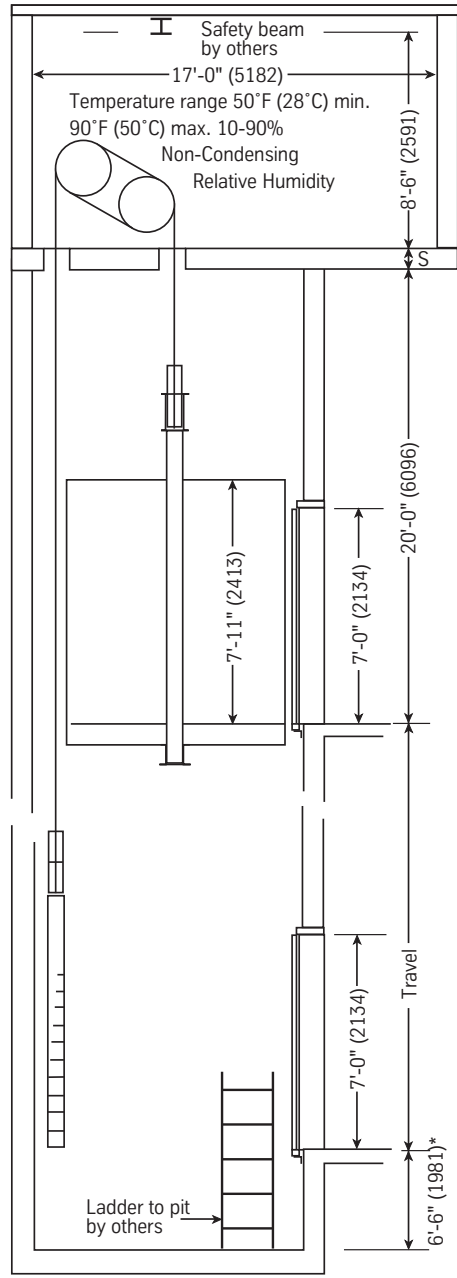

S = Concrete structural support slab by others. Machine room floor to support all elevator machine loads and floor loads per ASME A17.1.

*** Pit based on chain compensation. Add 2'-8" (813) for rope compensation.**

AC Gearless Traction Elevators

800 FPM (4.0 m/s) 1000 fpm (5.0 m/s) 1200 fpm (6.1 m/s)

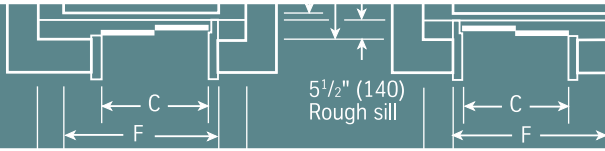

AC Gearless elevators with standard design can travel up to 1200 fpm (6.1 m/s) and are ideal for high-rise buildings of all kinds. These elevators deliver an unbeatable combination of speed, dependability and performance. For special design for speeds up to 1600 fpm (8.1 m/s) contact your local ThyssenKrupp Elevator representative.

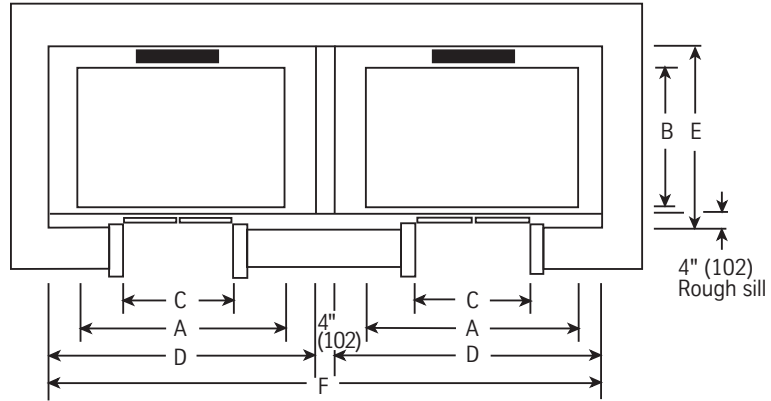
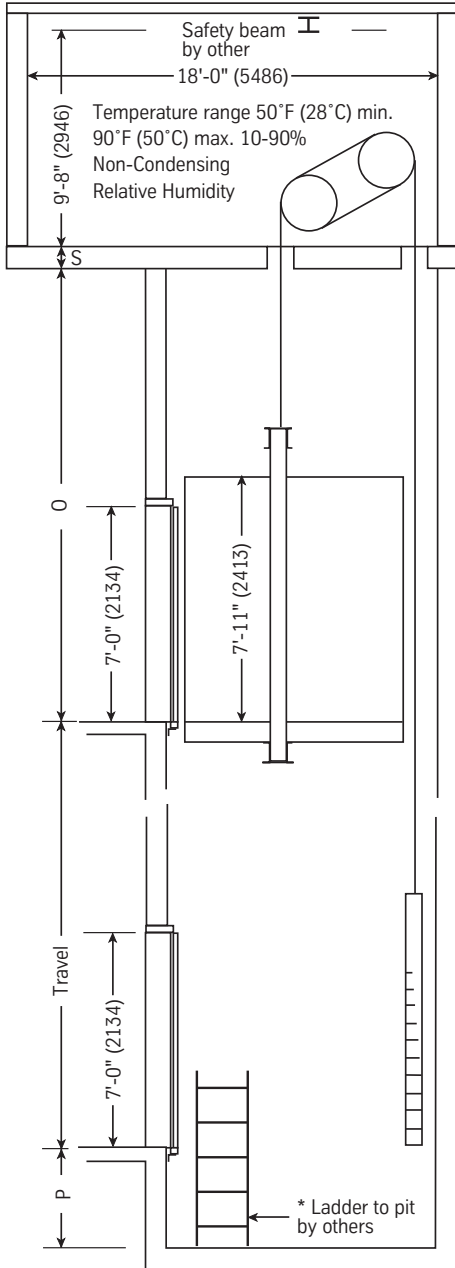

Dimensions	Capacity in pounds		
	3000 (1361 kg)	3500 (1588 kg)	4000 (1814 kg)
A ¹	6'-8" (2032)	6'-8" (2032)	7'-8" (2337)
B ¹	4'-9" (1448)	5'-5" (1651)	5'-5" (1651)
C	3'-6" (1067)	3'-6" (1067)	4'-0" (1219)
D ²	8'-4" (2540)	8'-4" (2540)	9'-4" (2845)
E ³	7'-2" (2184)	7'-10" (2388)	7'-10" (2388)
F ⁴	17'-0" (5182)	17'-0" (5182)	19'-0" (5791)

- Clear inside dimensions.
- Single car dimensions.
When speed = 800 fpm (4.0 m/s) add 4" (102) for seismic.
When speed = 1000 fpm (5.0 m/s) or 1200 fpm (6.1 m/s) add 2" (51) (3" (76) for seismic).
- Add 2" (51) for seismic. When speed = 1200 fpm (6.1 m/s) add 4" (102).
- Two car dimensions.
When speed = 800 fpm (4.0 m/s) add 8" (203) for seismic.
When speed = 1000 fpm (5.0 m/s) or 1200 fpm (6.1 m/s) add 4" (102) (6" (152) for seismic).

Minimum pit, overhead and machine room dimensions

Capacity in lbs.	Dimensions	Speed feet per minute (fpm)		
		800 (4.0m/s)	1000 (5.0m/s)	1200 (6.1m/s)
3000 (1361 kg)	O	20'-0" (6096)	24'-5" (7442)	27'-2" (8280)
	P	11'-4" (3454)	11'-6" (3505)	* 22'-6" (6858)
3500/4000 (1588/1814 kg)	O	21'-8" (6604)	24'-8" (7518)	27'-2" (8280)
	P	11'-4" (3454)	11'-6" (3505)	* 22'-6" (6858)

Rope compensation only.

NOTE: Hoistway dimensions are based on 1" (25) out of plumb and no occupied space below hoistway. If these conditions cannot be met, then consideration must be given for additional required space.

* Per ASME A17.1 rule 2.2.4.2 must have separate pit access door 10'-0" maximum from access door sill to the pit floor or 13'-9" maximum from access door sill to pit floor if there is not a building floor below the terminal floor.

S = Concrete structural support slab by others.
Machine room floor to support all elevator machine loads and floor loads per ASME A17.1.



Cab Options Design Perfection

Standard Cab Design

As shown below, our standard cab includes laminated plastic walls, a suspended ceiling with baked enamel frame, brushed stainless steel fronts with column type swing return and baked enamel doors. Our new Signa4™ signal fixtures are included as the standard in all TKE cabs.



Walls

Standard Designs

- Laminated Plastic (TKLP)
- Flat Steel Wall (TKS) (not shown)

Upgrade Designs

- Raised Applied Panels (TKAP)



- Available Styles:
- Vertical
 - Horizontal

Available Panel Finishes:

- Plastic Laminate
- Stainless Steel #4 #8 5WL
- Bronze Finish #4 #8

Available Reveal Finishes:

- Baked Enamel
- Stainless Steel #4 #8
- Bronze Finish #4 #8

Custom Veneer Applied Panel



- Available Panel Finishes:
- Mahogany
 - Maple
 - Walnut
 - Red Oak
 - Cherry

Doors

Our standard door height is 7'-0" (2134), but doors can be constructed up to 9'-0" (2743). Baked enamel and plastic laminate doors include a kickplate to match fronts. Doors have a baked enamel finish from our standard selector; or, provide us a paint sample and we can mix a color to your specifications.



Center-opening doors are standard for the 2500, 3000, 3500 and 4000 pound capacity SPF models.



Single-speed doors are standard for 2100 pound capacity SPF models.



Two-speed doors are standard for 4500 and 5000 pound capacity SPF models. 4'-6" doors are also available.

Upgrade Designs

- Stainless Steel #4 #8 5WL
- Bronze Finish #4 #8
- Plastic laminate without binders
- Plastic laminate with binders



Binders frame your plastic laminate doors.

- Stainless Steel #4 #8
- Bronze Finish #4 #8

Sills

Standard Design

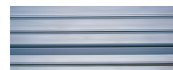

- Aluminum

Upgrade Designs



- Bronze Finish



- Nickel Silver

Fronts

Standard Design



Column Type

Available Finishes:

- Stainless Steel #4 #8 5WL
- Bronze Finish #4 #8

Upgrade Designs



Wrap Around

Available Finishes:

- Stainless Steel #4 #8 5WL
- Bronze Finish #4 #8



Full-Width Wrap Around

Available Finishes:

- Stainless Steel #4 #8 5WL
- Bronze Finish #4 #8

For more architectural products selections, contact your ThyssenKrupp Elevator sales representative.

Note: All dimensions in parentheses are in millimeters unless otherwise indicated. Dimensional data shown here complies with the current ASME A17.1 and CSA B44 Safety Code for Elevators. Local codes may vary from the national codes. Consult your local ThyssenKrupp Elevator representative for details.

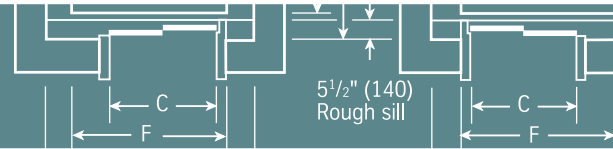

Ceilings

All of our suspended ceilings are mounted 7'-4" (2235) above the finished floor. Ceilings can be raised by extending the cab height.

Standard Design



Baked enamel suspended frame with white translucent light diffusers.

Available Frame Finishes:

- Stainless Steel #4 #8
- Bronze Finish #4 #8

Upgrade Designs

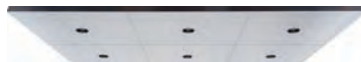

Island Type Halogen Downlight (Wood Core)

- Plastic Laminate
- Stainless Steel #4 #8 5WL
- Bronze Finish #4 #8



Halogen Downlights

- Baked Enamel
- Stainless Steel #4 #8 5WL
- Bronze Finish #4 #8

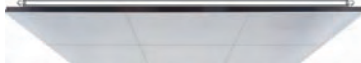

Island Type Perimeter Lighting (Wood Core)

- Plastic Laminate
- Stainless Steel #4 #8 5WL
- Bronze Finish #4 #8



Disc Light

Available Panel and Frame Finishes:

- Baked Enamel
- Stainless Steel #4 #8
- Bronze Finish #4 #8



Incandescent Downlight

- Baked Enamel
- Stainless Steel #4 #8 5WL
- Bronze Finish #4 #8

Handrails

Our handrails provide quality and durability with style and attractiveness.



Continuous Bar

Available sizes 1/4"(6) wide by:

- 2"(50) 4"(102) 6"(152)
- Stainless Steel #4 #8
- Bronze Finish #4 #8



Cylindrical

Available sizes:

- 1 1/2" (38) diameter 2" (50) diameter
- Stainless Steel #4 #8
- Bronze Finish #4 #8

For more architectural products selections, contact your ThyssenKrupp Elevator sales representative.

Note: All dimensions in parentheses are in millimeters unless otherwise indicated. Dimensional data shown here complies with the current ASME A17.1 and CSA B44 Safety Code for Elevators. Local codes may vary from the national codes. Consult your local ThyssenKrupp Elevator representative for details.

Standard Glassback Arrangements

Glassback cab options can be incorporated into any standard cab type as a premium option.

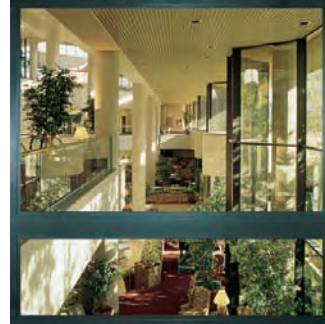

Full Height

Glass above and below handrail



Above Handrail

Modesty panel below handrail matches wall finish

Frame Finish:

- Baked Enamel Aluminum
- Stainless Steel Bronze

Miscellaneous Upgrades



Extended Cab

(Higher ceilings for transport of tall objects)



Protection pads for fronts and walls



Passenger Elevator Door ThyssenKrupp Entrance Details

Sill Support Supplied by ThyssenKrupp Elevator

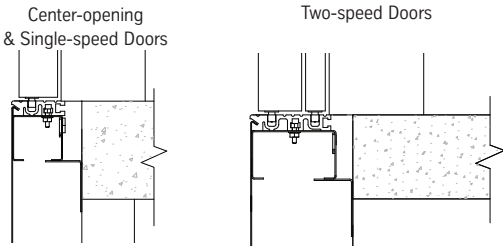

Center-opening Doors

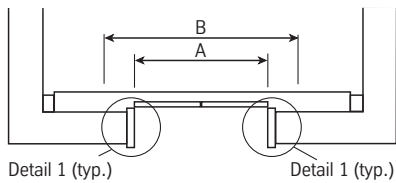

Two-speed Doors

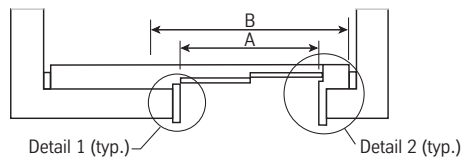

Single-speed Doors

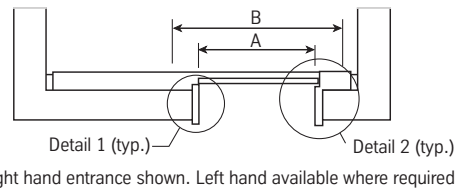

Drywall Construction

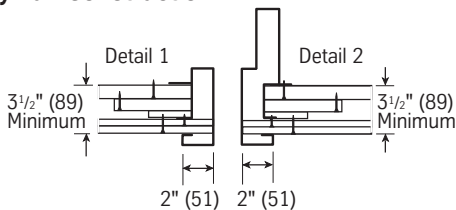

Masonry Construction

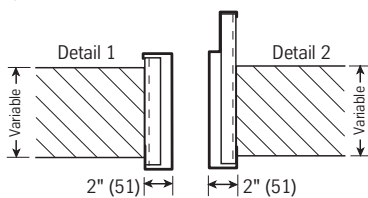

Single-speed Doors

A - Clear Opening B - Rough Opening

SPF 2100lb models	(ft-in)	3'-0"	4'-3"
	(mm)	914	1295
SPF 2500, 3000, 3500 and 4000lb models	(ft-in)	3'-6"	4'-9"
	(mm)	1067	1448
Center-Opening Doors			
All 2500, 3000, and 3500lb models	(ft-in)	3'-6"	4'-9"
	(mm)	1067	1448
4000lb models	(ft-in)	4'-0"	5'-3"
	(mm)	1219	1600
Standard Two Speed Doors			
All 4500, 5000lb and 50H models	(ft-in)	4'-0"	5'-3"
	(mm)	1219	1600
Optional Two-Speed Doors (4'-6" Wide)			
All 4500, 5000lb and 50H models	(ft-in)	4'-6"	5'-9"
	(mm)	1372	1753

Center-opening & Single-speed Doors

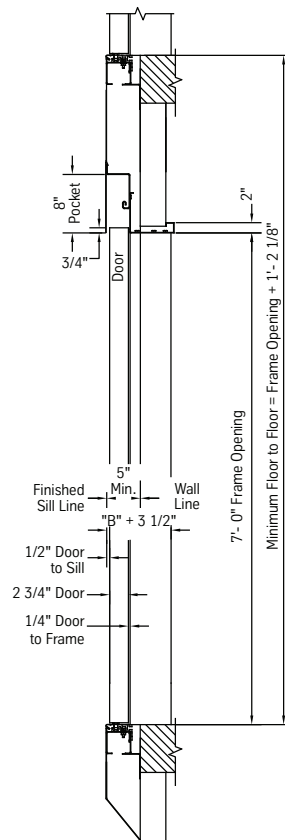

Two-speed Doors

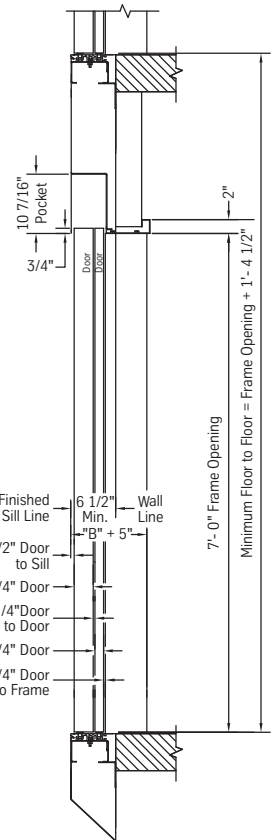

Note: Front walls should be left out until entrances are set in place or leave a minimum rough opening that is 15" (381) wider and 15" (381) higher than frame opening of doorway.

Note: For openings over 8'-0" (2438) consult factory.

Note: These diagrams show wall thickness and construction detail required in order to supply a minimum 1 1/2 HR. Warnock Hersey Label on entrances. Contact your local ThyssenKrupp Elevator representative for additional details.

Note: All dimensions in parentheses are in millimeters unless otherwise indicated. Dimensional data shown here complies with the current ASME A17.1 and CSA B44 Safety Code for Elevators. Local codes may vary from the national codes. Consult your local ThyssenKrupp Elevator representative for details.

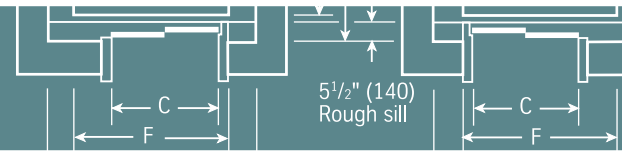

Work Not Included in the Elevator Contract*

The following preparatory work is required in order to properly install the elevator equipment. The cost of this work is not included in the elevator proposal, since it is a part of the building construction.

1. A plumb and legal hoistway, properly framed and enclosed and including a pit of proper depth, and a pit ladder for each elevator. Drains, lights, access doors, waterproofing and hoistway ventilation, as required.
2. Enclosed elevator equipment room with electrical work outlets, adequate lighting, and heating and ventilation sufficient to maintain the room at a temperature of 50°F minimum to 100°F maximum.
3. Adequate supports and foundations to carry the loads of all equipment, including supports for guide rail brackets.
4. Complete connections from the electric power mains to each controller, including necessary circuit breakers and fused mainline disconnect switches.
5. Electric power of the same characteristics as the permanent supply without charge for the construction, testing and adjusting.
6. Proper trenching and backfilling for any underground piping or conduit.
7. Divider beams for rail brackets support as required.
8. Cutting of walls, floor, etc. and removal of such obstructions as may be necessary for proper installation of the elevator.
9. Grouting of door sills, hoistway frames, and signal fixtures after installation of the elevator equipment.
10. All painting, except as otherwise specified.
11. Temporary enclosures, barricades, or other protection from open hoistways and elevator work area during the time the elevator is being installed.
12. Temporary elevator service prior to completion and acceptance of complete installation.
13. Smoke sensors as required in accordance with NFPA**72E and ASME A17.1.***
14. All telephone wiring to machine room control panel, and installation of telephone instrument or other communication equipment in elevator cab with all connections to elevator traveling cable and in machine room.
15. A standby power source, including necessary transfer switches and auxiliary contact, where elevator operation from an alternate power supply is required.
16. Adequate storage facilities for elevator equipment prior to and during installation.
17. A means to automatically disconnect the main line power supply to the elevator prior to the application of water in the elevator machine room will be furnished by the electrical contractor. This means shall not be self-resetting.
18. Setting of anchors and sleeves.

*Refer to elevator layout drawings for details of each requirement.

**National Fire Protection Code

***Safety Code for Elevators and Escalators

version 07.08

All illustrations and specifications are based on information in effect at time of publication approval. ThyssenKrupp Elevator reserves the right to change specifications or design and to discontinue items without prior notice or obligation.

Copyright © 2008

ThyssenKrupp Elevator Corporation



ThyssenKrupp Elevator

P.O. Box 2177

Memphis, TN 38101

Tel: 877-230-0303 (Toll Free)

thyssenkruppelevator.com