



THz-Raman Spectroscopy Probe

For Advanced Materials Characterization

Coherent's TR-PROBE is the ideal tool for real time process monitoring of pharmaceutical and other industrial applications where understanding structural attributes like polymorphism, degree of crystallinity or hydration, or real time phase transformation is critical. The simple fiber optic output can be easily connected to virtually any spectrometer to turbocharge the performance of existing systems and enable access to the "Structural Fingerprint" region of Raman spectroscopy very close to the laser line (~ 5 to 200 cm^{-1}). Systems are available with up to 300 mW output at popular wavelengths, including 532 nm, 785 nm, 808 nm, 976 nm, and 1064 nm.

Coherent's THz-Raman[®] Spectroscopy Systems extend the range of traditional Raman spectroscopy into the terahertz/low-frequency domain, revealing the same range of energy transitions as terahertz spectroscopy without limiting the ability to measure the Raman "Chemical Fingerprint" region. Patented ultra-narrowband notch and ASE clean-up filters, combined with built-in thermal compensation and a wide range of sample accessories, deliver robust, stable performance for virtually any application. No special sample preparation is required, so real time, in situ analysis of material processes can be performed, eliminating the need for multiple instruments or offline sampling while lowering capital equipment, training, and maintenance costs.

FEATURES

- Robust, sealed patented optical design with broad operating temperature range for use in demanding environments
- Multiple interchangeable sample interface options available including:
 - contact/immersion probe tip
 - vial/tablet holder
 - steerable open beam
 - microscope adapter
 - transmission Raman adapter
 - FloodLight large area adapter
- Fiber coupled output enables easy interface to a wide range of spectrometers
- Simultaneous Stokes and anti-Stokes signals improve SNR while providing an inherent calibration reference
- Available at 532 nm, 785 nm, 808 nm, 976 nm, and 1064 nm excitation wavelengths
- Dual polarization/dual fiber output option available for depolarization studies at 532 nm

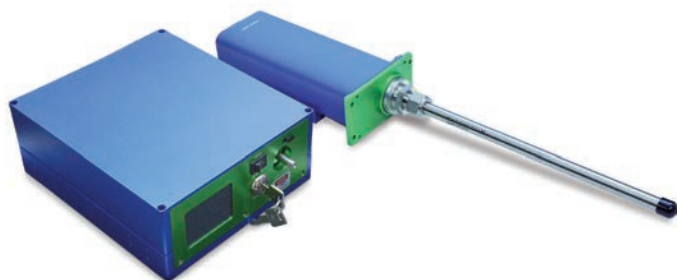

MONITORING OF CHANGES TO STRUCTURAL FORM

The TR-PROBE is a compact, robust THz-Raman probe that enables in-situ reaction or process monitoring, which can be flexibly configured with a variety of sample interface accessories, including immersion/contact probe tips, a vial/tablet holder, a transmission Raman adapter, a microscope mount, or a steerable non-contact optic (see all available options on pages 4 and 5). A separate CleanLine™ diode laser or DPSS/OPSL laser provides ASE-free excitation via a fiber optic coupling, enabling the probe to operate in harsher environments where electrical connections are not permitted. The athermal design allows usage over a wide range of operating temperature environments. The symmetry of the Stokes/anti-Stokes signals provides a spectral calibration reference in every measurement. This compact yet rugged design enables both in-line reaction monitoring and off-line testing of material properties with no special sample preparation required.

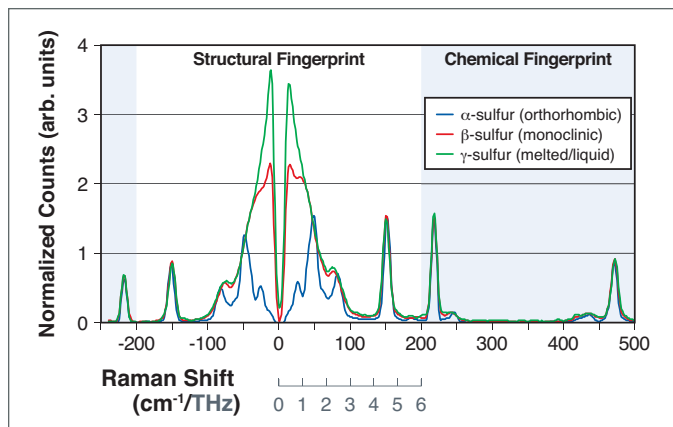

Figure 1. Phase changes in sulfur: The orthorhombic crystalline phase exhibits sharp peaks, indicating a high degree of order in the structure, whereas the the monoclinic form and liquid phases become increasingly disordered, leading to a broadening and ultimate disappearance of the distinctive peaks.

Challenge

Measurement and control of reactions, crystallization rates and/or amorphous states is increasingly important across the chemical, pharmaceutical and electronics industries where well controlled processes are required. Clear, unambiguous determination of material structure (such as polymorphs or amorphous vs. crystalline content), degree of crystallinity, and phase is essential to chemical process development, formulation, stability testing and material characterization (see figures 1 and 2 for examples). Most measurement modalities require special sample preparation for offline, destructive analysis and can't provide real-time feedback. THz-Raman enables real time, in situ testing of material structure to improve overall process yields and reduce the cost required for analytical testing.

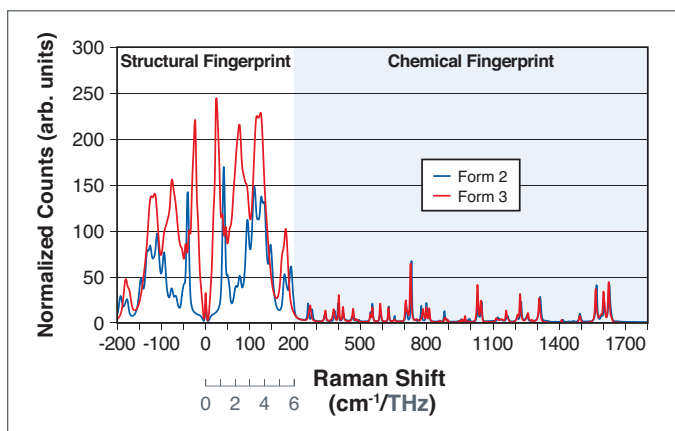

Figure 2. Full Raman spectrum of the pharmaceutical active ingredient Carbamazepine showing both the THz-Raman “Structural Fingerprint” and traditional “Chemical Fingerprint” regions for two different polymorphic forms of the drug. While the Chemical Fingerprint exhibits only minor differences between the two forms, it is easy to observe the differences in the Structural Fingerprint region. Note higher intensity and symmetry of low wavenumber signals that allow more rapid signal collection and improved reliability of the spectra.

BENEFITS

- Both chemical composition and molecular structure from one Raman measurement
- In-situ, real-time structural monitoring and chemical analysis
- Higher SNR with inherent calibration reference
- Faster, more comprehensive and reliable measurements
- Interchangeable sample interface
- Compact, easy to use, and adaptable to existing Raman systems

Coherent Solution

The low energy vibrational modes of a material correspond to movements of the entire molecule or crystal lattice, making them most sensitive to any changes in form. As materials change from disordered to highly ordered (e.g. amorphous to crystalline), the low frequency bands shift and become sharper. When structural changes to the polymorphic form or degree of hydration occur, or cocrystalline bonds are created or broken, the low wavenumber bands change as well (see Figure 3).

Up to 10X Typical Signal Increase

The low frequency vibrational bands also typically present with much stronger signal intensity since the molecular and intermolecular vibrations are much larger relative to the wavelength of light than traditional intramolecular vibrations found in the chemical fingerprint region. With up to 10X stronger signals than standard Raman, THz-Raman systems provide fast, unambiguous real-time measurement of crystallization and phase characteristics. The strong signal to noise (observed in Figures 4 and 5) means lower laser powers can be used or collection times can be reduced. When combined with the non-destructive nature of the test and no special sample preparation requirements, this enables rapid measurements to be taken in situ to monitor reaction processes on the order of seconds, minutes or hours.

APPLICATIONS

- Crystallization and reaction monitoring
- In-situ polymorph identification and analysis
- Crystalline vs. amorphous content quantification
- Cocrystal formation
- Biomolecular configuration states
- Structural properties of polymers
- Forensic analysis
- Trace detection and source attribution of explosives/hazmat/drugs
- Structural studies of nano- and bio-materials, photovoltaics, and semiconductors

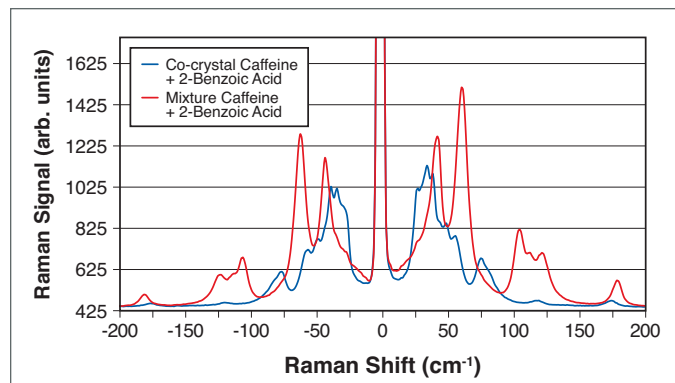

Figure 3. THz-Raman spectra for cocrystals and mixtures of Caffeine and Benzoic Acid showing clear differentiable peaks.¹

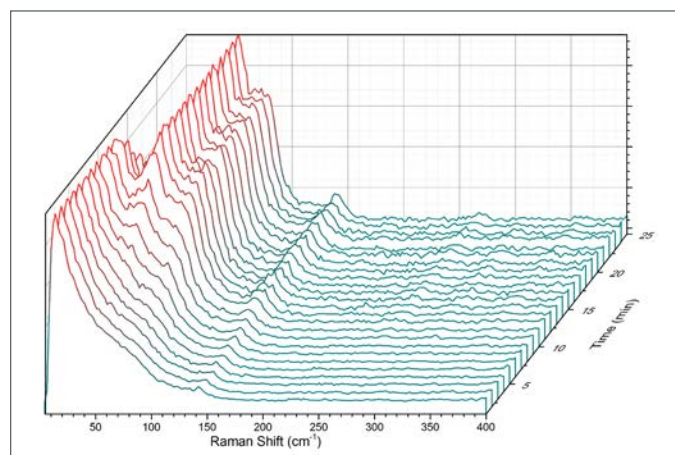

Figure 4. To simulate dynamic process measurements, a commercial Advil tablet was heated then cooled at room temperature while monitoring the THz-Raman spectra. The active ingredient was initially in an amorphous state, then transitioned to the stable crystalline form after ~15 minutes.

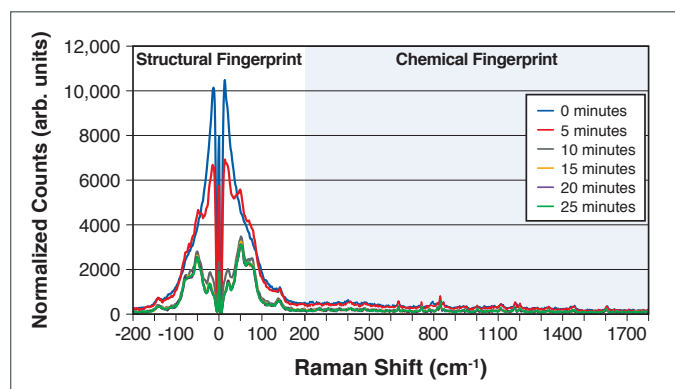
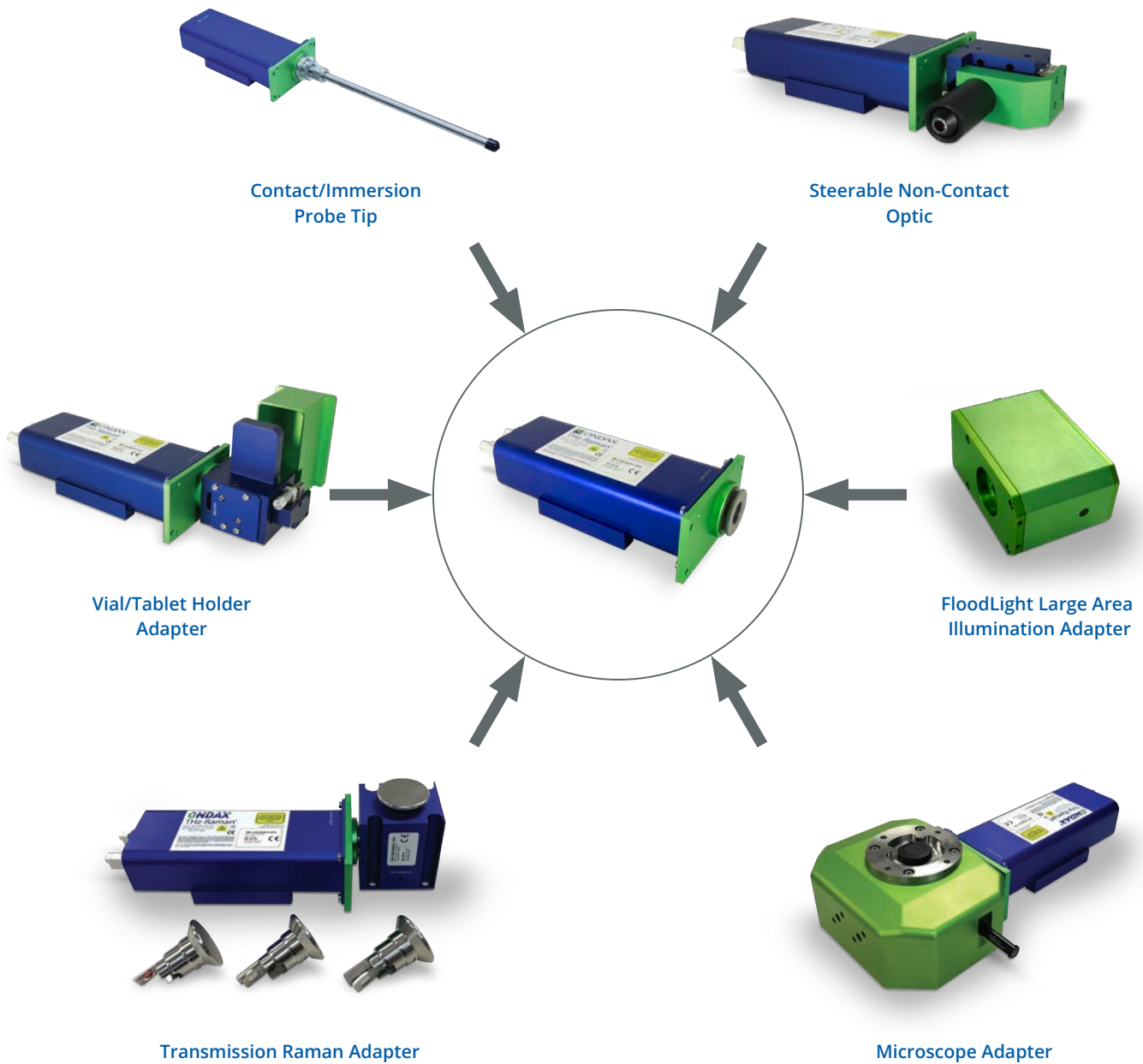

Figure 5. Individual spectra plotted in 5 minute increments for the dynamic process in Figure 2 showing the spectral transition as the tablet cools.

SAMPLE INTERFACE ACCESSORY OPTIONS:

The compact nature of the **TR-PROBE** combined with a wide number of sample interface accessories makes it very versatile for use in process monitoring as well as off-line testing of materials. Switching between sample interface accessories is simple with the standard dovetail adapter at the output port of the **TR-PROBE** head. See the associated THz-Raman Accessory datasheet for more details on each accessory option.



SAMPLE INTERFACE ACCESSORY DETAILS:**Contact/Immersion Probe Tip**

The contact/immersion probe tip uses a UV grade sapphire ball lens to focus the collimated output beam from the TR-PROBE head onto the sample with a $\sim 300\ \mu\text{m}$ working distance. Users simply touch the probe to the sample and collect reproducible spectra of liquids, solids, slurries, powders and heterogeneous mixtures. Available in either stainless steel or Hastelloy shafts, the probe tip comes in a standard length is 279.4 mm (11") with 12.7 mm (1/2") diameter but diameters from 3.18 mm (1/8") to several cm and lengths of 25.4 mm (1") to several meters are also available. Connection to the probe head is as simple as screwing into the threaded sample port with the included SwageLok mount.

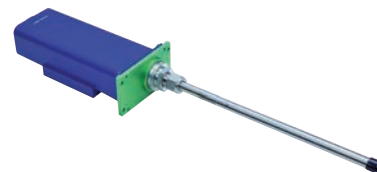
**Vial/Tablet Holder Adapter**

The vial/tablet holder adapter enables samples in standard HPLC or scintillation vials to be easily inserted into the chamber for quick measurement. Included are three vial inserts with diameters of 12 mm, 15 mm, and 17 mm (corresponding to standard 2 mL, 4 mL and 20 mL vials respectively) and one clamp based insert for holding tablets or short NMR tubes. Fine focus adjustments can be made using the micrometer actuator. A manual safety shutter is built in so the beam is automatically blocked when the chamber door is opened.

**Steerable Non-Contact Optic**

The steerable non-contact optic (NCO) adapter is the perfect solution for stand-off applications. The adapter simply clamps onto the dovetail flange of the sample port and can be rotated 360° to focus the beam onto the sample at any orientation. Included is an 8 mm working distance focusing optic but the SM1 threaded adapter allows any microscope objective lens to be inserted as well (with the appropriate thread adapter). Fine focus adjustments can be made using the micrometer actuator. A manual safety shutter is built in and can be engaged to block the laser output.

**Microscope Adapter**

Increase the functionality of your system by attaching the TR-PROBE or TR-BENCH onto any standard microscope with the microscope adapter. The microscope adapter can be configured for mounting on standard Leica, Olympus, Nikon or Zeiss microscopes through the interchangeable mounting rings. A simple microscope selector switch allows you to easily engage or remove the probe from the microscope optical axis without disturbing other microscope accessories. The dichroic mirror design allows shorter wavelengths from the illuminator to pass through the adapter while reflecting the laser and Raman signals so imaging and viewing ability is preserved.

**FloodLight Large Area Illumination Adapter**

When a larger illumination area is required to improve sample averaging, the FloodLight adapter can be connected between the sample port and any of the other sample accessories. Flip the switch on the powered connection and the illumination spot will be rapidly rastered over a large range of angles to produce a time-averaged large area focused spot, while still maintaining instantaneous diffraction limited performance necessary for best THz-Raman signal capture. Turn off the FloodLight switch and static performance is resumed to better observe and compare spatial variations in heterogeneous samples.

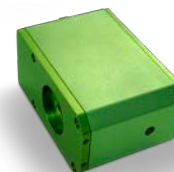
**Transmission Raman Adapter**

Quickly turn your TR-PROBE into a transmission Raman system for performing quantitative bulk sample analysis with the Transmission Raman adapter. Simply connect the excitation fiber from the laser unit directly to the fiber input on the transmission adapter. The included sample holders precisely place the sample in front of the excitation fiber to produce the optimum illumination spot for the sample. Multiple scattering events then occur through the sample volume before being collected from the rear surface at the probe sample port to provide a volumetric average of the entire sample vs. the surface-based signal collected from most opaque solids.



SPECIFICATIONS	TR-PROBE				
Wavelength (nm)	532	785	808	976	1064
Power at Sample Port (mW)	25 to 250 ¹	300			
Physical Dimensions ² (L x W x H)	215.9 x 76.2 x 58.4 mm (8.5 x 3.0 x 2.3 in)				

¹ Specify power level at time of order.
² Probe head only, does not include sample accessory.

MECHANICAL SPECIFICATIONS

TR-PROBE

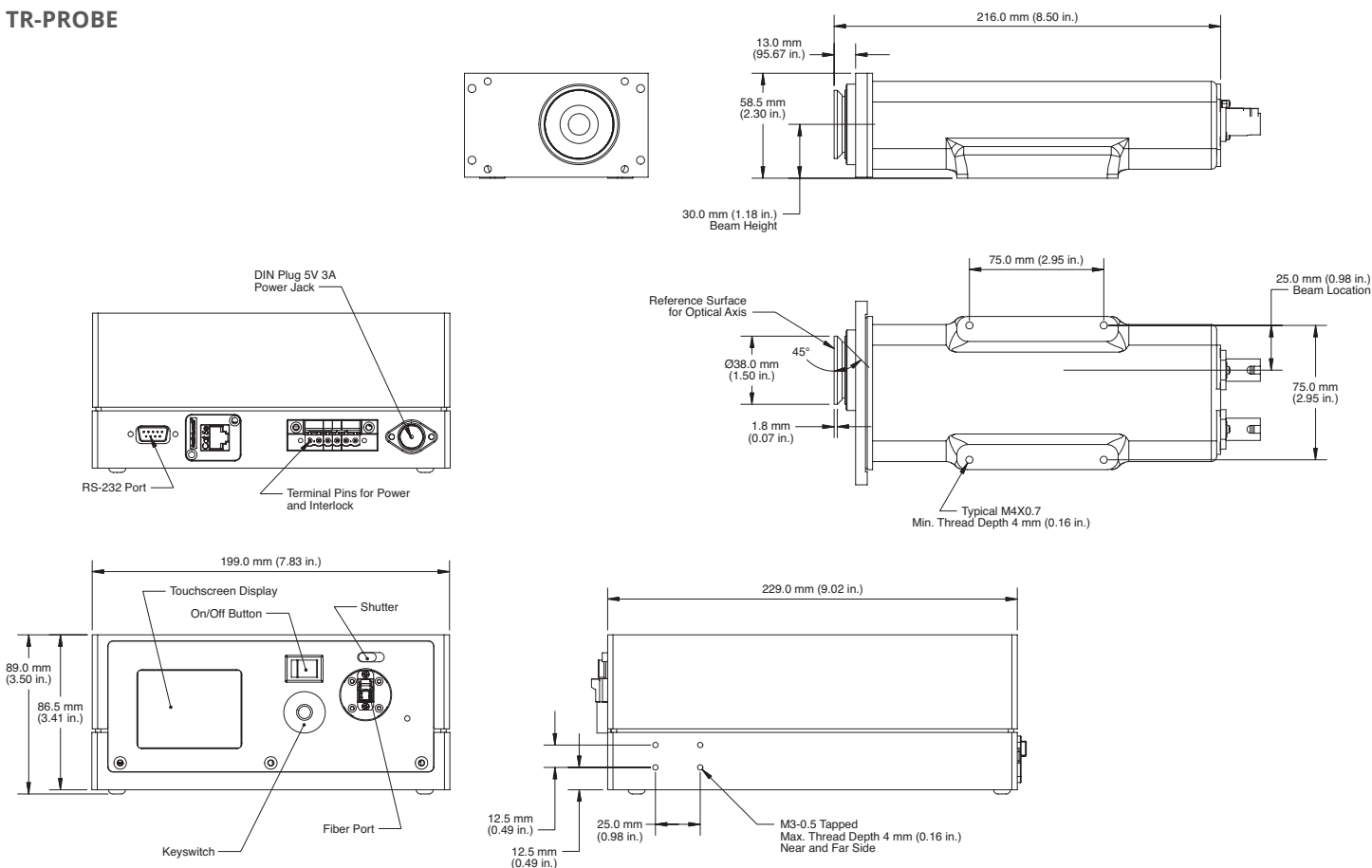

Coherent, Inc.,
 5100 Patrick Henry Drive Santa Clara, CA 95054
 p. (800) 527-3786 | (408) 764-4983
 f. (408) 764-4646

tech.sales@coherent.com www.coherent.com

Coherent follows a policy of continuous product improvement. Specifications are subject to change without notice. Coherent's scientific and industrial lasers are certified to comply with the Federal Regulations (21 CFR Subchapter J) as administered by the Center for Devices and Radiological Health on all systems ordered for shipment after August 2, 1976.
 Coherent offers a limited warranty for all THz-Raman Spectroscopy Probes. For full details of this warranty coverage, please refer to the Service section at www.coherent.com or contact your local Sales or Service Representative. MC-023-20-0M0620 Copyright ©2020 Coherent, Inc.

U.S. Patent No. 8,184,285
 U.S. Patent No. 7,986,407
 U.S. Patent No. 9,599,565
 U.S. Patent No. 9,587,983