

WELL-PLATE SYSTEM (WPS)



Ondax's new **TR-WPS Automated Well-plate Measurement System** combines high throughput screening (HTS) capability with our patented¹ low-frequency/THz-Raman® technology to **automatically capture the entire Raman spectrum from -800 cm⁻¹ to +2800 cm⁻¹** for common well-plate measurements. Ideal for screening and identification of polymorphic compounds and co-crystals, or quantifying degree of crystallinity in pharmaceuticals, THz-Raman® delivers fast, sensitive and reliable measurements of both chemical composition and molecular structure. The relative ease of sample handling and measurement ensures that the user spends more time with the data, rather than collecting it.

To ensure compliance with cGxP protocols, the WPS has been designed to be fully automated, from sample insertion to data generation. The sample is excited with a 785 nm Ondax CleanLine™ laser from below the well in an inverted microscope format. A plate autofocus system ensures measurement repeatability, and an integrated vision system with polarized light detection can be used to determine areas of interest within each well.

The **WPS™ Application Software** Interface has a highly intuitive GUI with a layered design, enabling fast learning and simplified operation, while providing extensive additional functionality in advanced mode.

FEATURES

- > Fully automated operation
- > Collects both Stokes and anti-Stokes signals from -800 to +2800 cm⁻¹ with ~4 cm⁻¹ spectral resolution
- > Configurable scanning patterns
- > **FloodLight™** Mode to enhance collection speed and averaging performance
- > Intra-well mapping data collection
- > Plate autofocus system
- > Automated calibration
- > Polarized Light Detection
- > SPC and ASCII File Formats
- > User-definable file descriptors
- > Save and recall experiment parameter configurations
- > Compatible with standard 6, 12, 24, 48, 96, 384, or 1536 well plates, as well as custom substrates
- > Advanced Mode enables user-definable patterns and sampling routines

EASY, SIMPLE OPERATION

1. Select one or multiple wells
2. Define integration pattern and parameters:
 - Single Point, XY Grid, Spiral, Polar
 - Total time per well
 - Inner /Outer Spiral Diameter
3. Collect, view and capture live spectra during alignment
4. View and save live video images

BUILT-IN SAMPLING PATTERNS

The WPSTM software is simple and intuitive, and allows Raman data to be saved in various file formats, including SPC or ASCII text. Measurements from each well-plate are stored for post-process analysis and archiving. User-definable descriptors and well number are appended to each file for easy identification and post-processing analysis, as well as an Excel-compatible ASCII summary file for the entire well-plate. Experiment parameters can be saved as a configuration file that may be imported into the GUI or launched from the command line, and the most-recent (last-used) method may also be automatically repeated n times with an optional delay between the repeats, simplifying the generation of data for statistics – particularly useful when determining limit of quantitation and detection.

SELECT WELL(S)

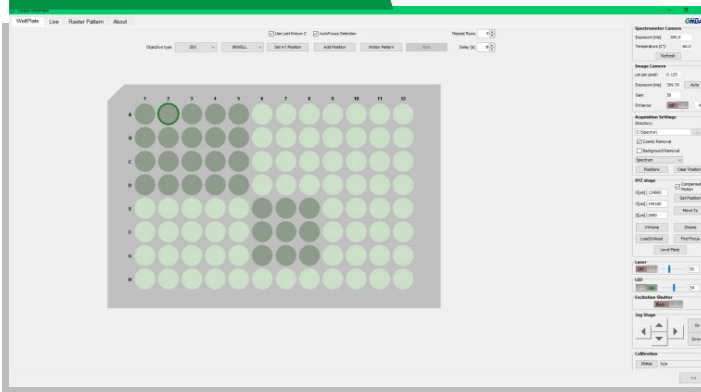

RASTER PATTERN MODE

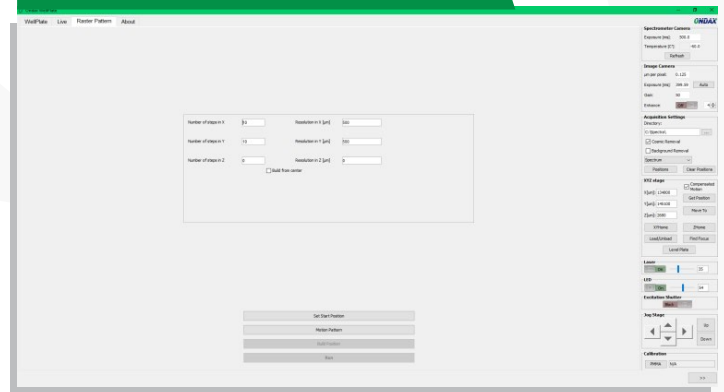

The **Select Wells** interface enables the user to easily define which wells to measure within a specific well-plate format. **Raster Mode** allows the user to scan around an area of interest, conveniently building a pattern from the center point outward or from a corner location. And **Advanced Mode**, a command line interface allows users to script and recall presets, or develop and execute novel sampling methods for their experiments. Up to 4 user-defined objectives may be automatically selected (e.g. from range of 2x-20x) to match desired spatial resolution within the well. A unique **Floodlight™** rapid scanning mode can be used to enlarge scanning area, giving it a larger effective scanning spot size and improving data collection speed.

LIVE MODE

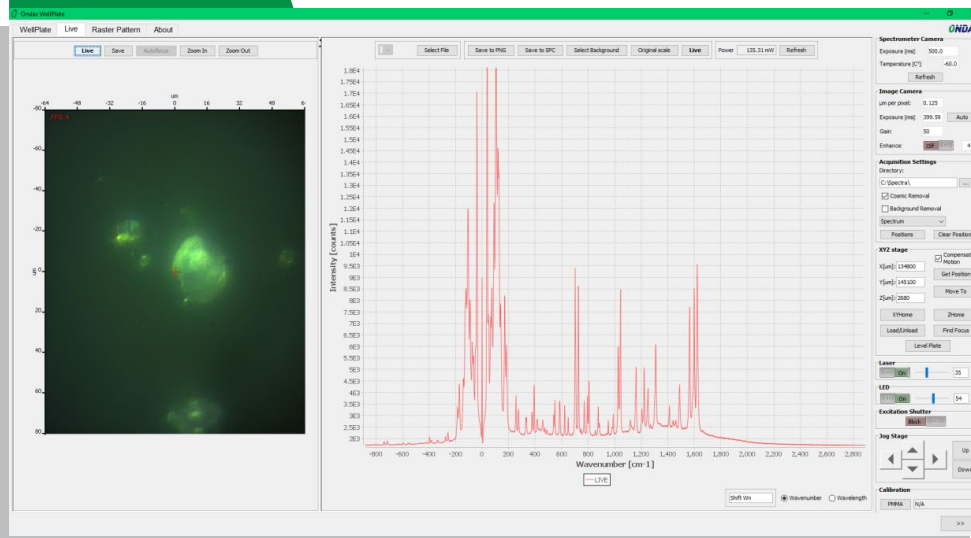

Live Mode provides a simultaneous, real-time display of both video image and spectra during measurement, with the capability of importing additional data for comparison. **Live Mode** also enables the user to visualize the material under study using polarized light microscopy.

Since solid samples are often inhomogeneous, the WPS software includes a variety of sampling patterns to enable spatial averaging. User-selectable built-in patterns include: **Single Point, Spiral, Polar, or Grid**. **Single Point** is most often used for initial alignment of the system to the area of interest, and maintains a stationary position during the measurement. The **Spiral** pattern is used to capture spectra over large areas (e.g. wells) and provides many data points for statistical averaging, as well as intra-well mapping (see following pages). The **Spiral** parameters can be adjusted to optimize measurement time and well plate area coverage¹. For the **Grid** pattern, the user specifies the step size (minimum 1 mm) and number of steps in both X and Y directions to create a cartesian grid of any size. Similar to Grid mode, **Polar mode** is an alternative pattern that takes measurements at many discrete points, but uses polar vs. cartesian coordinates to generate the pattern. For both Grid and Polar modes, data is recorded as an overall average, but also at each discrete location and is accessible for post-process analysis. Each pattern may also be repeated multiple times to generate additional data for statistical enhancement.

The appropriate sampling method can be determined by the user, selecting either the visual camera or real-time Raman spectra in the live mode to locate a starting position.

SINGLE POINT

SPIRAL

POLAR

GRID

¹As an example, for a well in a 96 well-plate, parameters of 1 minute acquisition time per well, with 1 mm inner diameter and 5 mm outer diameter, would result in 90% coverage when using a 20X objective.

INTRA-WELL MAPPING

The WPS software also provides several means of localized mapping of spectral peaks, whether within a well or on a slide. In the example below, an Excedrin tablet was crushed and placed in a thin glass-bottomed well plate to randomly distribute the primary constituents. (Excedrin = 250 mg Acetaminophen + 250 mg Aspirin + 5 mg caffeine).

Prior to crushing, Raman spectra were taken on the tablet surface (where the coating dominates the signal) and then on the inside of a broken tablet (where the Acetaminophen and Aspirin dominate) to identify and assign unique peaks for each material for post-process analysis. (Form 1 of acetaminophen = 86 cm^{-1} and the tablet coating = 143 cm^{-1} , see spectra below)

A detailed high-resolution scan (using a Grid scanning pattern of 200×200 microns with 10 micron step size) was performed on a specific region within the 6mm diameter well. The data was then used in post-processing to generate a Raman map using the intensity at the two identified peaks. The plot on the left shows the concentration (signal intensity) of Form I of acetaminophen (86 cm^{-1}) within the mapped region. The plot on the right shows the corresponding concentrations of the tablet coating (143 cm^{-1}) within the same region. This method can be useful for both identifying specific constituent locations as well as visualizing distributions within a user-defined area.

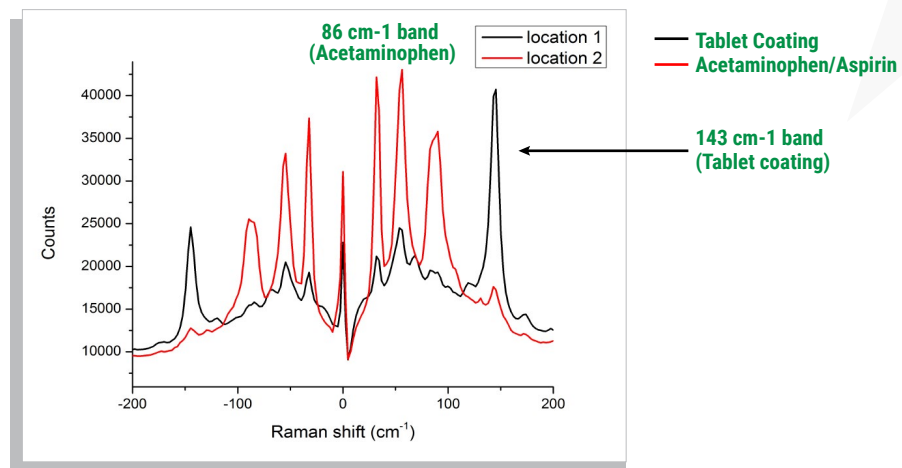
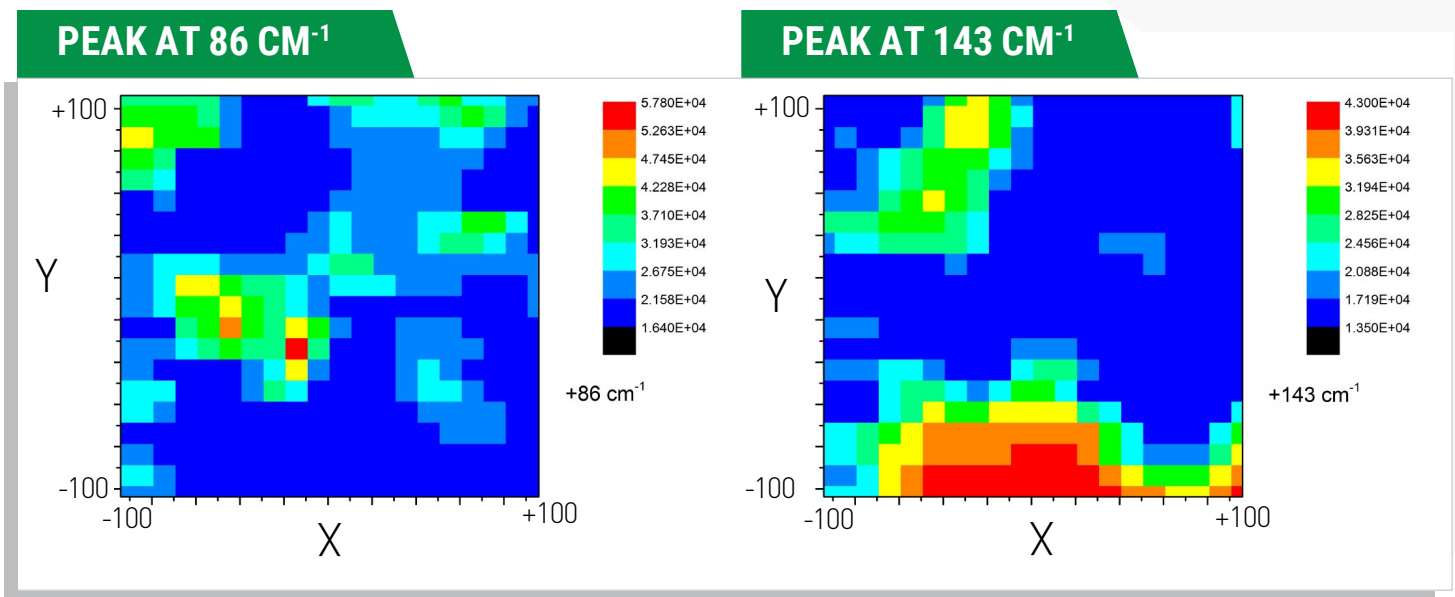

SPECTRAL COMPARISON OF TABLET CONSTITUENTS

A second example of the mapping capability of the WPS software also provides a means of **localized mapping of spectral peaks**. In the example below, powdered caffeine and acetaminophen were separately poured into a single well of a 96-well plate (6mm dia.). A reference spectrum of each component was first taken to establish unique peaks to use for post-process analysis (**86 cm⁻¹** for acetaminophen and **92 cm⁻¹** for caffeine, Figure 1).

A Spiral Scan was performed on the entire well to obtain an average spectrum for the well (Figure 2). Note that the THz-Raman signal was dominated by caffeine due to the larger Raman cross section of the material. The Spiral pattern was then mapped using Principal Component Analysis (PCA) to discriminate between Caffeine and Acetaminophen.

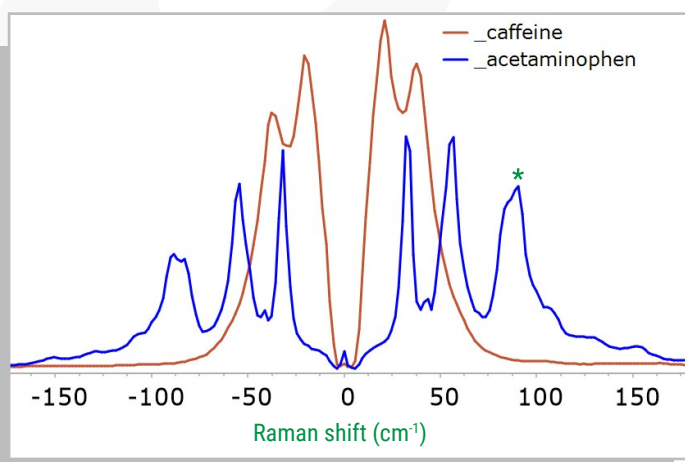

Fig. 1: Scaled reference spectrum of caffeine (red) and acetaminophen (blue).

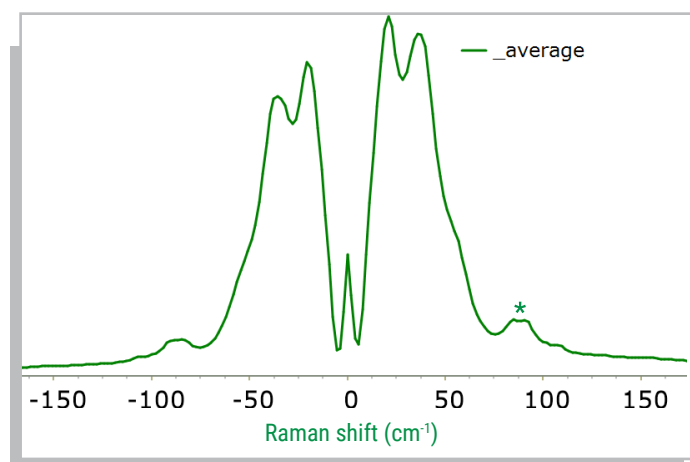

Fig. 2: Average spectrum for entire well. While the peak at 90 cm⁻¹ (marked with a *) from the acetaminophen can be observed, the spectrum is largely dominated by caffeine due to its larger Raman cross-section.

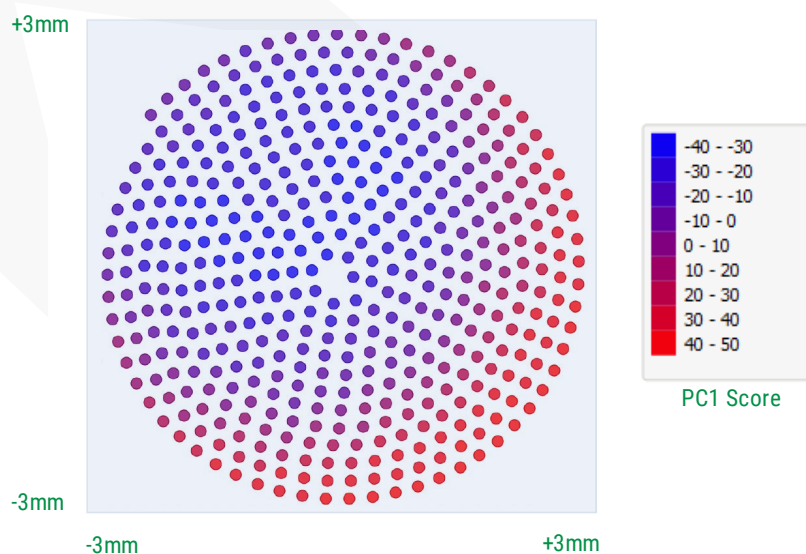

Fig. 3: Map of distribution of acetaminophen and caffeine in a single well of a 96 well plate. The axes indicate X and Y spatial locations. Each dot in the map represents an average spatial location, where a THz-Raman[®] signal was measured. A principal component analysis (PCA) of the data was performed and the dots are colored on the basis of the PC1 score: larger positive scores indicate a larger concentration of caffeine at that location (red) and more negative scores indicate a larger concentration of acetaminophen (blue).

POLARIZED LIGHT MICROSCOPY

In **Live Mode**, images using polarized light can be used to isolate regions of interest and perform spectral comparisons. In the example below, a ground Excedrin tablet is analyzed within a single well. The polarized light enhances the image of a crystalline region (green region) within the focal plane. By using the video image to position the excitation spot (indicated by the red circle), spectra can be collected from areas both inside (Location 1) and outside (Location 2) the region of interest.

The corresponding spectral comparison (shown at bottom) shows clear differences in composition and/or molecular form. The sharp peaks indicate highly crystalline forms for both areas.

**SPOT INSIDE REGION
(LOCATION 1)**

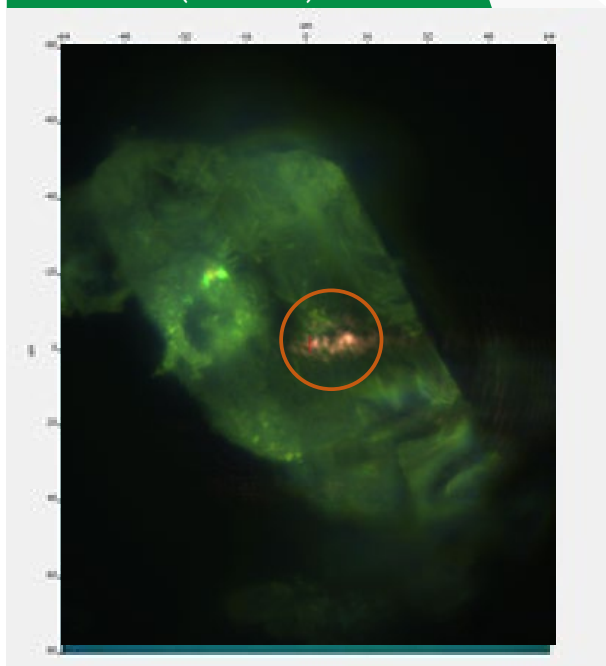

**SPOT OUTSIDE REGION
(LOCATION 2)**

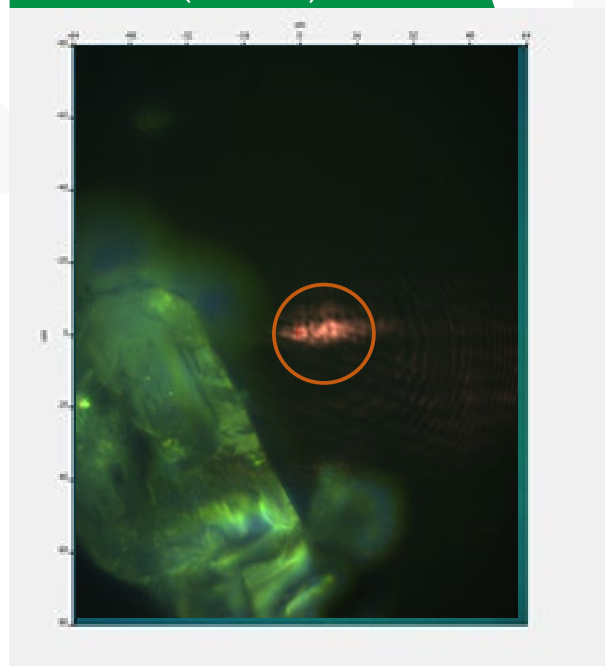

SPECTRAL COMPARISON

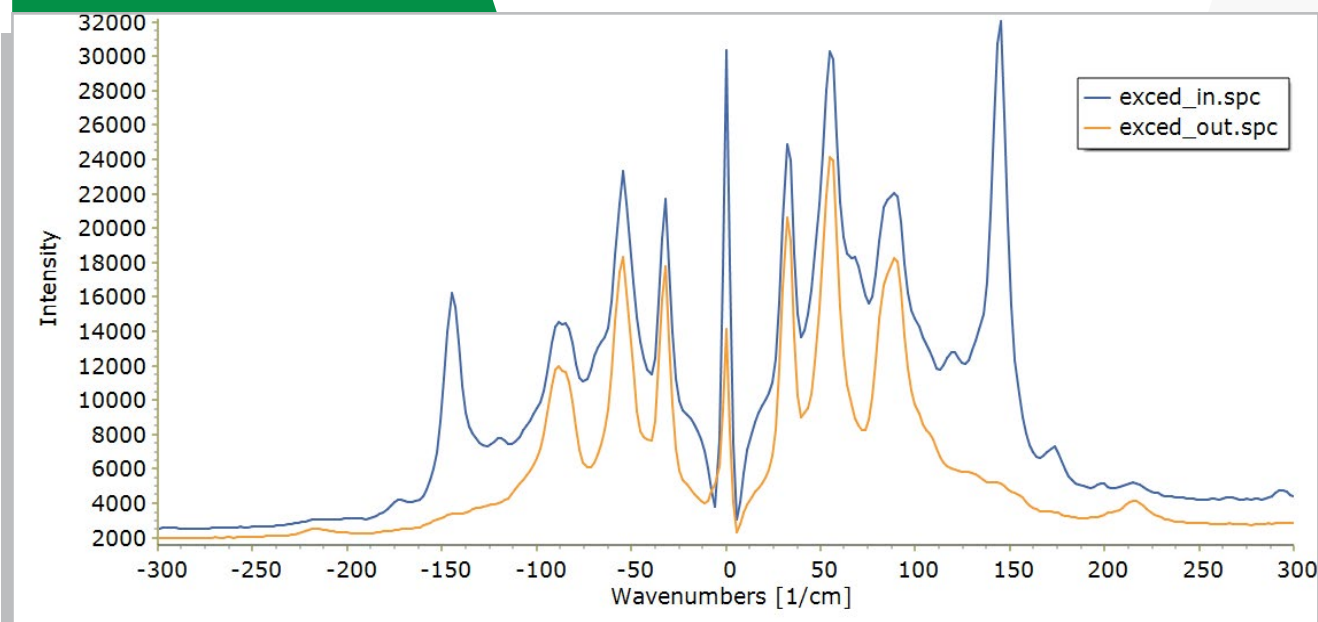

APPLICATIONS

THz-Raman[®] spectra show clear differentiation of structural attributes of the material, ideal for identification and screening of structural forms and phase, and quantification of crystalline content. Applications include polymorph identification, analysis and screening, determining amorphous/crystalline content, co-crystal identification and analysis, phase monitoring, and crystallization studies.

By simultaneously collecting both low-frequency and anti-Stokes signals as well as the traditional chemical fingerprint, THz-Raman[®] systems boost overall Raman intensity and improve SNR. The symmetrical nature of the anti-Stokes signals also act as a confirmation of Stokes peaks, while providing an inherent calibration reference that improves overall confidence and reliability.

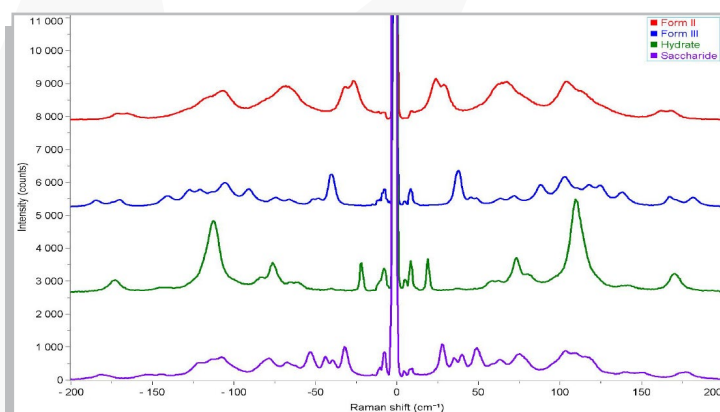

Polymorph Identification

Polymorphic forms and hydrates of pharmaceuticals can easily be distinguished in raw materials analysis, finished goods, process monitoring, and QC applications.

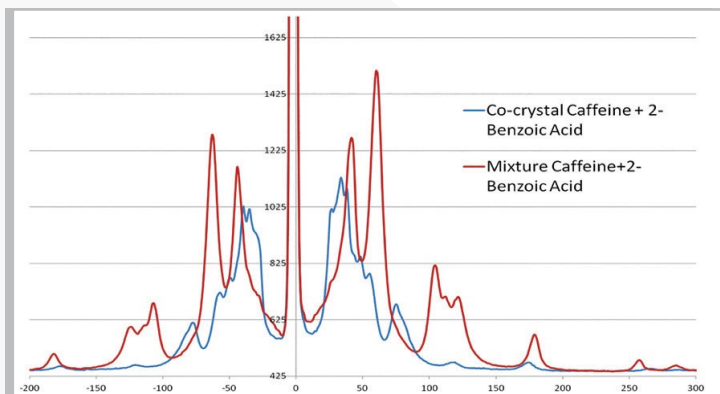

Crystal Monitoring and Analysis

Identifying and monitoring the formation of cocrystals is also improved using THz-Raman[®] spectra. The figure to the left shows the clearly recognizable peak shifts that occur when cocrystals are formed in a mixture of Caffeine and 2-Benzoic acid.

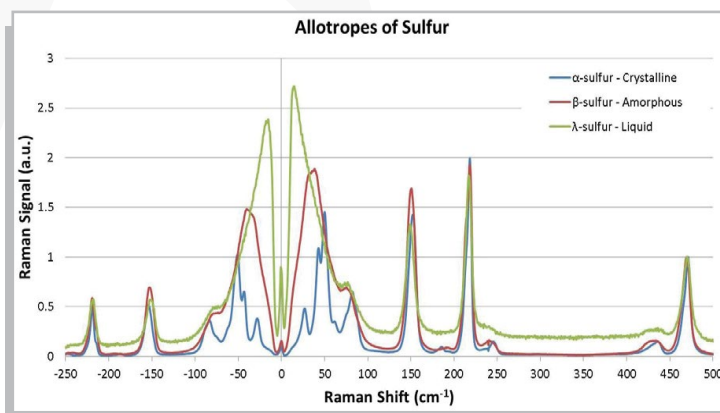

Phase Monitoring

Phase changes of Sulfur observed when heated from room temp. (α) to 95.2°C (β) and then to the melting point of 115.21°C (λ). Note the clearly recognizable changes in peak location, shape and magnitude in the THz-Raman[®] region. Crystalline phases result in sharp peaks, which broaden and dissipate as the sulfur liquifies.

SPECIFICATIONS

| PARAMETER | VALUE |
|---------------------|--|
| Laser Wavelength | 785nm |
| Laser Power | Up to 400mW at sample |
| Spectral Range | -800cm ⁻¹ to 2800cm ⁻¹ |
| Spectral Dispersion | 2 cm ⁻¹ per pixel |
| Focusing | Manual or Auto |
| Objectives | 4 user definable (e.g. 5x, 10x, 20x) |
| Maximum Sample Size | 125mm x 85mm (fits standard well plate) |
| Power/Voltage | 110-240 VAC ± 10%, 300W Maximum |
| Dimensions | 950mm (W) x 650mm (D) x 415mm (H) |
| Weight | 50kg |
| Laser Class | Class 1 Laser. Complied with IEC60825-1 |

All dimensions in mm

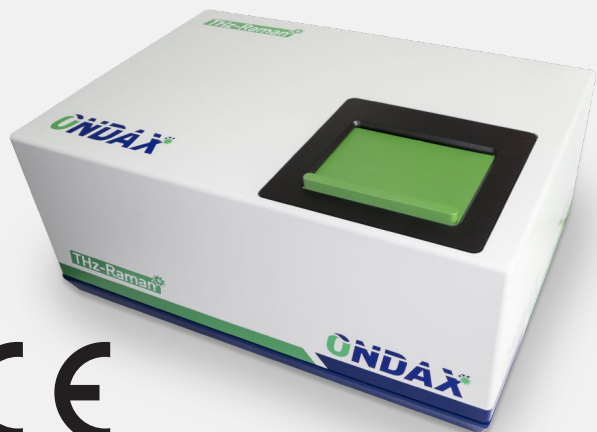
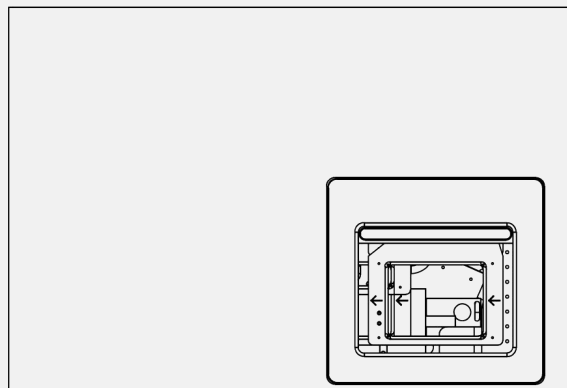
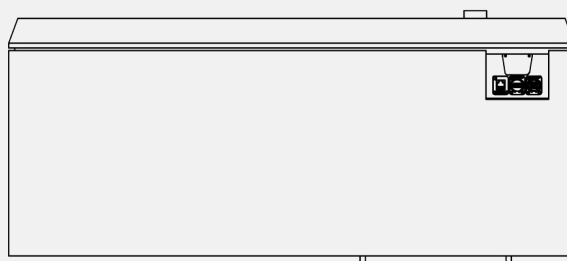
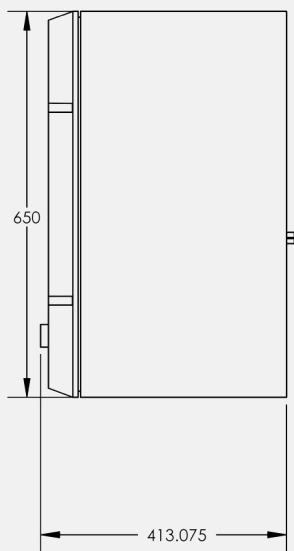

ONDAX*

850 E. Duarte Rd. Monrovia, CA 91016
 626.357.9600 (Tel)
 626.513.7494 (Sales Fax)
www.ondax.com
www.THz-Raman.com

For more information about Ondax products and the name of a local representative or distributor, visit www.ondax.com, email sales@ondax.com, or call 626.357.9600

No responsibility is assumed by Ondax, Inc. for use of this product nor for any infringements of patents and trademarks or other rights of third parties resulting from its use. No license is granted under any patents, patent rights or trademarks of Ondax, Inc., and the company reserves the right to make changes in specifications at any time without notice. Each purchased laser is provided with test data. Please refer to this data before using the laser.

© 2018 Ondax, Inc.