

THE



SERIES "MGA"

OPERATION MANUAL



SECOND EDITION

ALL CAR OWNERS

should read

Motoring

FIRST-CLASS TECHNICAL AND SPORTS SECTIONS ARE REGULAR FEATURES OF THIS WIDELY READ MONTHLY MAGAZINE

Technical articles dealing with maintenance and tuning help Morris, Wolseley, Riley and M.G. car owners to get the best out of their cars. Expert advice of technical staff is at the service of all readers

From newsagents or by postal subscription
13/6 per annum (United Kingdom)
12/- per annum (outside United Kingdom)

MOTORING
The Nuffield Organization
Cowley, Oxford, England

THE



(Series "MGA")

OPERATION MANUAL

SECOND EDITION

A copy of this Operation Manual is sent out with every M.G. (Series "MGA") car. Additional copies can be obtained at a nominal price and the part number, which should be quoted when ordering, is AKD.598.

Published by

THE M.G. CAR COMPANY LIMITED

Proprietors: Morris Motors Ltd.

ABINGDON-ON-THAMES

Telephone: Abingdon 251-2-3-4

Telegrams: Emgee, Abingdon

Sole Exporters

NUFFIELD EXPORTS LIMITED

Proprietors: Morris Motors Ltd.

COWLEY - OXFORD - ENGLAND

Telephone: Oxford, England, 77733

Telex: Morex, Oxford, England

Cables: Morex, Oxford, England

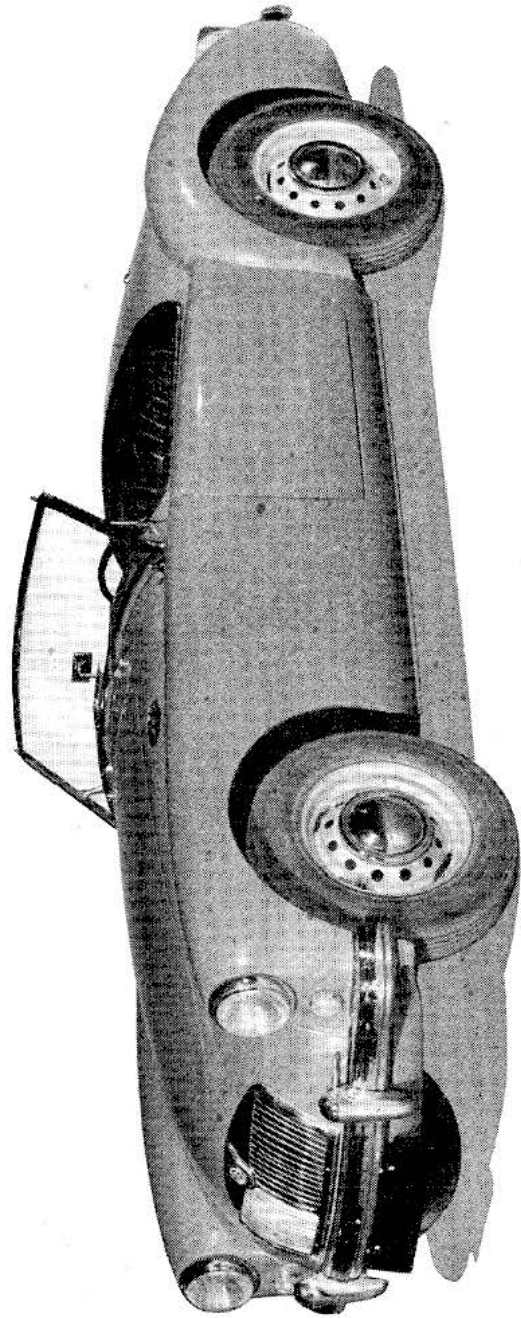

THE M.G. TWO-SEATER (SERIES "MGA")

The information contained in this operation manual has been confined to the essentials required for the proper running and driving of the car.

The inclusion of lengthy descriptions has been avoided and extensive use made of illustrations. Nevertheless the owner will find all the information required to maintain the car in first-class condition and give it those all-important items of attention which go so far to ensure trouble-free and satisfactory service.

For owners who desire more complete information concerning the maintenance and mechanism of their vehicles the M.G. Series "MGA" Workshop Manual is available at a moderate figure. Remember that M.G. Dealers are better equipped to provide routine and repair attention than the private owner.

Every M.G. car leaving our Works is capable of giving absolute satisfaction if proper attention is given to the essential maintenance detailed in this book.

If you encounter trouble, consult or write to your nearest M.G. Dealer or to the Service Department of the M.G. Car Company Ltd. without hesitation. They are at your service. Note, however, that all correspondence concerning exported vehicles must be addressed to Nuffield Exports Limited.

ALWAYS QUOTE THE ENGINE AND CHASSIS NUMBERS IN ANY CORRESPONDENCE CONCERNING THE CAR. THESE NUMBERS ARE STAMPED ON THE PLATE ON THE DASH PANEL BELOW THE BONNET.

GENERAL DATA

Engine	Four-cylinder overhead valve
Bore	2.875 in. (73.025 mm.)
Stroke	3.5 in. (89 mm.)
Capacity	1489 c.c. (90.88 cu. in.)
Firing order	1, 3, 4, 2
Valve clearance017 in. (.43 mm.) (hot)
Sparking plugs	Champion NA8 14 mm. $\frac{3}{4}$ in. reach
Sparking plug gap019 to .021 in. (.48 to .53 mm.)
Contact breaker gap014 to .016 in. (.36 to .41 mm.)
Rear axle ratio	4.3 to 1
Overall gear ratios :	
1st	15.652 to 1
2nd	9.520 to 1
3rd	5.908 to 1
4th	4.3 to 1
Reverse	20.468 to 1
Tyre size	5.60—15
Tyre pressures :	
Normal	Front : 17 lb./sq. in. (1.2 kg./cm. ²) Rear : 20 lb./sq. in. (1.4 kg./cm. ²)
Full load or fast driving	Front: 21 lb./sq. in. (1.48 kg./cm. ²) Rear : 24 lb./sq. in. (1.69 kg./cm. ²)
Competition work, sustained high-speed driving	Front: 23 lb./sq. in. (1.62 kg./cm. ²) Rear: 26 lb./sq. in. (1.83 kg./cm. ²)
Dimensions :	
Track—Front	Disc wheels 3 ft. 11 $\frac{1}{2}$ in. (1.206 m.) Wire wheels 3 ft. 11 $\frac{7}{8}$ in. (1.216 m.)
Rear	4 ft. 0 $\frac{3}{4}$ in. (1.238 m.) 4 ft. 0 $\frac{3}{4}$ in. (1.238 m.)
Turning circle	28 ft. (8.53 m.)
Toe-in	Nil
Wheelbase	7 ft. 10 in. (2.388 m.)
Length (overall)	13 ft. 0 in. (3.96 m.)
Width (overall)	4 ft. 10 in. (1.473 m.)
Height (overall)	4 ft. 2 in. (1.270 m.)
Ground clearance	6 in. (15.24 cm.)
Unladen weight (ready for road)	17 cwt. 3 qrs. (902 kg.)
Capacities :	
Fuel tank	10 gals. (45.4 litres, 12 U.S. gals.)
Cooling system	10 pints (5.67 litres, 12 U.S. pints)
Engine sump (including filter)	7 pints (4 litres, 8 $\frac{1}{2}$ U.S. pints)
Gearbox	4 pints (2.27 litres, 4 $\frac{3}{4}$ U.S. pints)
Rear axle	2 $\frac{3}{4}$ pints (1.56 litres, 3 $\frac{1}{4}$ U.S. pints)

Lamp bulbs—see page 39.

Note.—References to right or left hand in this instruction book are made when viewing the car from the rear.

CONTROLS

INSTRUMENTS

SWITCHES

HAND BRAKE

The hand brake lever is located alongside the gearbox cover and operates the rear wheel brakes only.

To operate, pull up the lever and press the knob in the end with the thumb to lock the lever in position. To release the brakes, pull upwards on the lever to release the lock automatically and then push downwards.

Always apply the hand brake when parking.

BRAKE PEDAL

The centre pedal operates the hydraulic brakes on all four wheels and will also operate the twin stop warning lamps when the ignition is switched on.

CLUTCH PEDAL

The left-hand pedal operates the hydraulic clutch release. Do not allow the foot to rest on the clutch pedal while driving as this will cause excessive wear of the operating mechanism.

GEAR LEVER

The four forward gears and the reverse gear are engaged by moving the lever to the positions indicated in the illustration inset opposite.

To engage the reverse gear move the lever to the left of the neutral position until resistance is felt, apply side pressure to the lever to overcome the resistance and then pull it backwards to engage the gear.

Synchromesh engagement is provided on second, third and fourth gears.

Ensure that the gear lever is in the neutral position before attempting to start the engine.

STEERING COLUMN ADJUSTMENT

A steering column which is adjustable for length is available as an optional fitting. This enables the steering wheel to be placed in the most comfortable driving position after slackening a clamp bolt below the wheel hub.

Always re-tighten the nut securely after adjustment. See the inset in the illustration opposite.

HEADLAMP BEAM DIP SWITCH

This is situated to the left of the clutch pedal and is foot-operated. The switch will dip the headlamp beams on one depression and raise them on the next.

To give the driver clear indication when the headlamp beams may dazzle approaching drivers a warning light in the speedometer dial glows when the headlamp beams are in the raised position.

BONNET LOCK RELEASE

The bonnet is hinged at the rear and the lock is released by pulling on the ring below the instrument panel on the extreme left-hand side of the car.

The bonnet is still held by the safety catch, which must be released before the bonnet can be raised. (See page 16.)

To re-lock the bonnet in the fully closed position after opening, press downwards on the front of the bonnet until the lock is heard to engage.

SEAT ADJUSTMENT

A lever is provided at the front of each seat and this must be pressed outwards to release the catches and allow the seat to slide.

The seat will lock in the desired position as the lever is released.

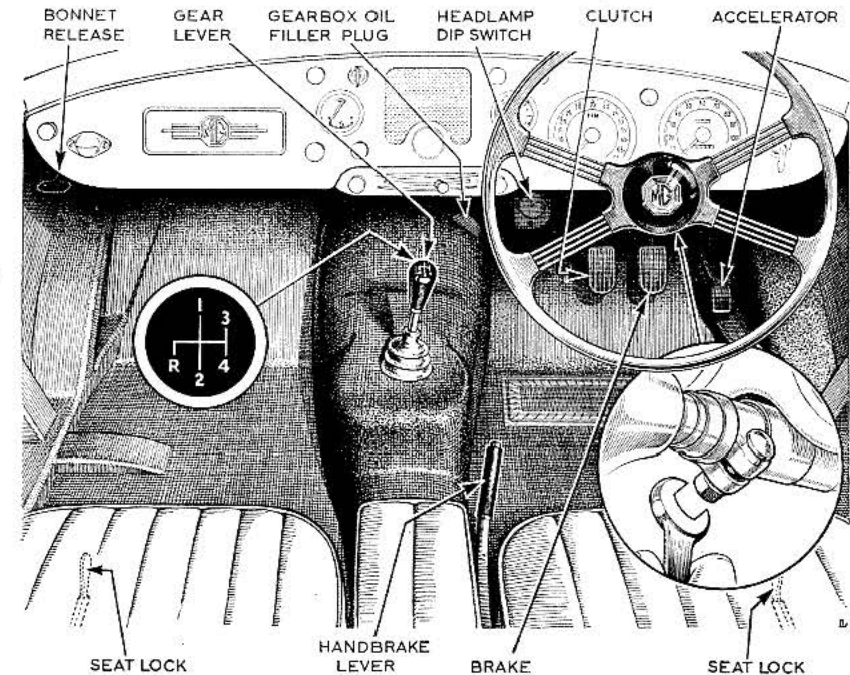

SPEEDOMETER

In addition to indicating the speed of the car, the speedometer records the trip and total distances. The trip recorder enables the distance of a particular journey to be recorded and is re-set to zero by pushing upwards the knob below the instrument and turning it anti-clockwise until the figures read zero.

MAIN BEAM WARNING LIGHT

The warning light at the bottom of the speedometer dial glows red when the headlamp main beams are in use, as a reminder to dip the beams when approaching other traffic.

ENGINE REVOLUTION INDICATOR

The speed of the engine is indicated by this dial which is calibrated in hundreds of revolutions per minute. Normal use of the engine will not require speeds over 5,000 r.p.m. and great care must be taken if the needle does approach the amber sector of the dial which commences at 5,500 r.p.m. Under favourable conditions the needle may be allowed to enter the amber sector but under no circumstances must it enter the red sector.

IGNITION WARNING LIGHT

The warning light at the bottom of the revolution indicator dial glows red when the ignition is switched on and will go out again when the engine is started and its speed is increased sufficiently for the dynamo to charge the battery. Should the light glow at all engine speeds, the dynamo is not charging the battery and the wiring circuit and dynamo drive belt should be examined immediately.

Do not leave the ignition switched on for more than a few moments while the engine is stationary.

OIL PRESSURE GAUGE

The pressure of the oil in the engine lubricating system as shown on the gauge should be between 30 lb./sq. in. and 80 lb./sq. in. (2.1 kg./cm.² and 5.6 kg./cm.²) under normal running conditions. Approximately 10 lb./sq. in. (0.7 kg./cm.²) should be shown when the engine is idling.

WATER TEMPERATURE GAUGE

The temperature of the cooling water leaving the cylinder head is indicated by this gauge and should be approximately 160° to 190° F. when the engine is running normally. If the normal running temperature is greatly exceeded the cause must be traced and rectified immediately.

HORN PUSH

This is the black button below the grille in the centre of the panel.

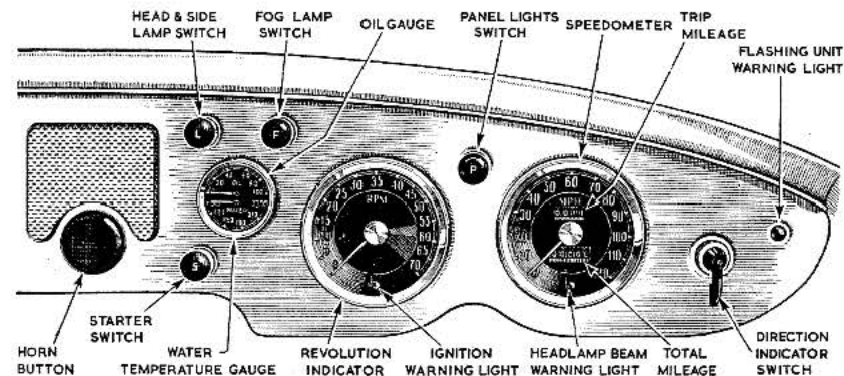

STARTER SWITCH

Pull out the knob marked "S" to operate the starter motor. The switch must be pulled out smartly and pushed in immediately the engine starts. If the engine does not start at once, allow it to come to rest before using the switch again.

LAMP SWITCH

To switch on the sidelamps, tail-lamps and number-plate illumination lamp, pull out the knob marked "L". Turn the knob clockwise and pull out again to switch on the headlamps. See "Headlamp Beam Dip Switch" on page 6.

FOG-LAMP SWITCH

A fog-lamp is not fitted as standard equipment, but the switch marked "F" on the instrument panel is connected to the battery and is ready for use when a fog-lamp is connected to it. Pull out the knob to switch on the fog-lamp.

PANEL LAMP SWITCH

To illuminate the instruments turn the control knob "P" clockwise. The first movement of the knob will switch on the lamps and further turning to the right will dim the lamps. The panel lamps will only operate when the sidelamps also are switched on.

DIRECTION INDICATOR SWITCH

The lever-type switch on the outer edge of the panel controls the flashing indicator unit. The unit will operate only while the ignition is switched on and flashes the sidelamp and tail-lamp on the side of the car to which the switch lever is moved until it is automatically switched off. While the flashing unit is switched on the warning light next to the switch will show green.

INSTRUMENTS AND SWITCHES

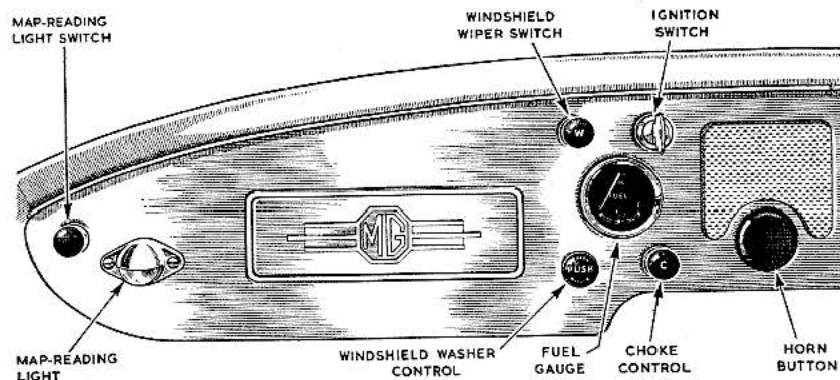

OPTIONAL EQUIPMENT

FUEL GAUGE

This operates only when the ignition is switched on and indicates the quantity of fuel in the tank.

CHOKE OR MIXTURE CONTROL

To enrich the mixture and assist starting when the engine is cold, pull out the knob marked "C" and lock it in position by turning it anti-clockwise. Turn the knob clockwise and push it inwards to the normal running position as soon as the engine is warm enough to run without the rich mixture. Never allow the engine to run for any length of time with the knob pulled out.

IGNITION SWITCH

Turn the ignition switch key clockwise to switch on the ignition. Do not leave it switched on when the engine is not running, except for very short periods.

The fuel pump and gauge are brought into action by this switch which is also the master switch for the windshield wipers and direction indicators. Without the removable key the engine cannot be started.

WINDSHIELD WIPER SWITCH

Pull out the control "W" to set the wiper blades in motion. Push in the knob to switch off the motor and park the blades. The windshield wipers are self-parking and operate only when the ignition is switched on.

MAP-READING LAMP

The map-reading lamp is controlled by the adjacent knob which must be pulled out to switch on the light. The lamp will only operate while the side-lamps are switched on.

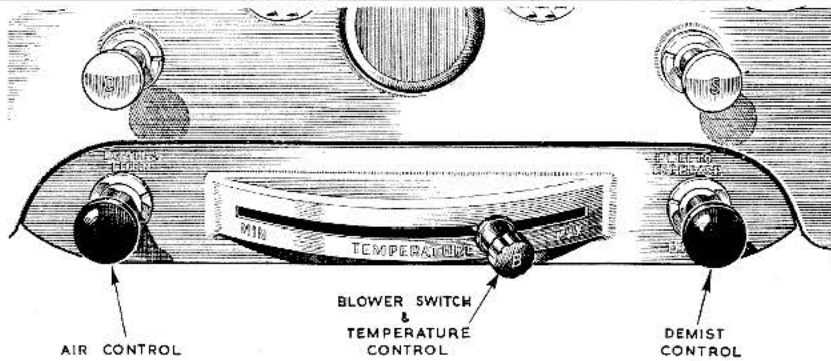

HEATING AND DEMISTING EQUIPMENT

When the 2.75 kw. heating and demisting unit is fitted, fresh air is ducted from the radiator grille to the heating element and blower motor mounted below the bonnet. Water from the engine cooling system is used to heat the element.

Warmed air issues from the toeboard or the windshield demisting vents according to the position of the controls mounted below the instrument panel. In warm weather the controls may be set to provide unheated fresh air for ventilation.

Air. The left-hand knob controls the air supply. When the knob is pushed in the air duct is open and air at atmospheric temperature will enter the car when it is in motion and will issue from the toeboard or demisting vents.

Air Blower. Pull out knob marked "B" on the temperature control lever to switch on the blower motor, if the ignition is switched on also, and this will increase the flow of air into the car and may be used to give a supply of air when the car is stationary or travelling at low speed.

If the blower motor is switched off and the air control knob pulled outwards to close the air duct, fresh air cannot enter the car from the toeboard or windshield vents.

Demist. The right-hand knob on the heater unit control panel operates a shutter in the panel above the gearbox cover. When the control is pushed into the normal position the shutter is open and most of the air from the unit will enter the car at the toeboard while some will issue from the vents below the windshield. As the knob is pulled out the shutter closes and more air is delivered to the demisting vents, giving the maximum supply of air to the windshield. This is the demist position of the control and also the windshield defrost position when the heater is operating and the blower is switched on.

Temperature. The temperature lever operates the water valve on the engine. When the lever is in the left-hand position the hot water supply is cut off and air entering the car through the unit will not be heated. As the lever is moved to the right the water supply is increased until the maximum temperature is obtained.

As a general guide, here are some of the more frequently required positions :—
No additional ventilation or heating. Pull out the air control, push the temperature control to the left.

- Hot weather.** Push in the air and demist controls. Move the temperature control to the left. To increase the supply of air switch on the blower motor.
- Warm weather.** Set the controls as for hot weather. To increase the supply of air switch on the blower motor. To prevent mist forming on the windshield pull out the demist control partially.
- Cold weather.** Place the air control in its normal position. Place the temperature lever according to the degree of heating required. Switch on the blower to increase the air supply (if demisting is required pull out the demist control).
- Severe cold.** Move the temperature control to the right for maximum heating and pull out the demist control fully to give a maximum supply of hot air to the windshield. Switch on the blower motor to increase air flow.

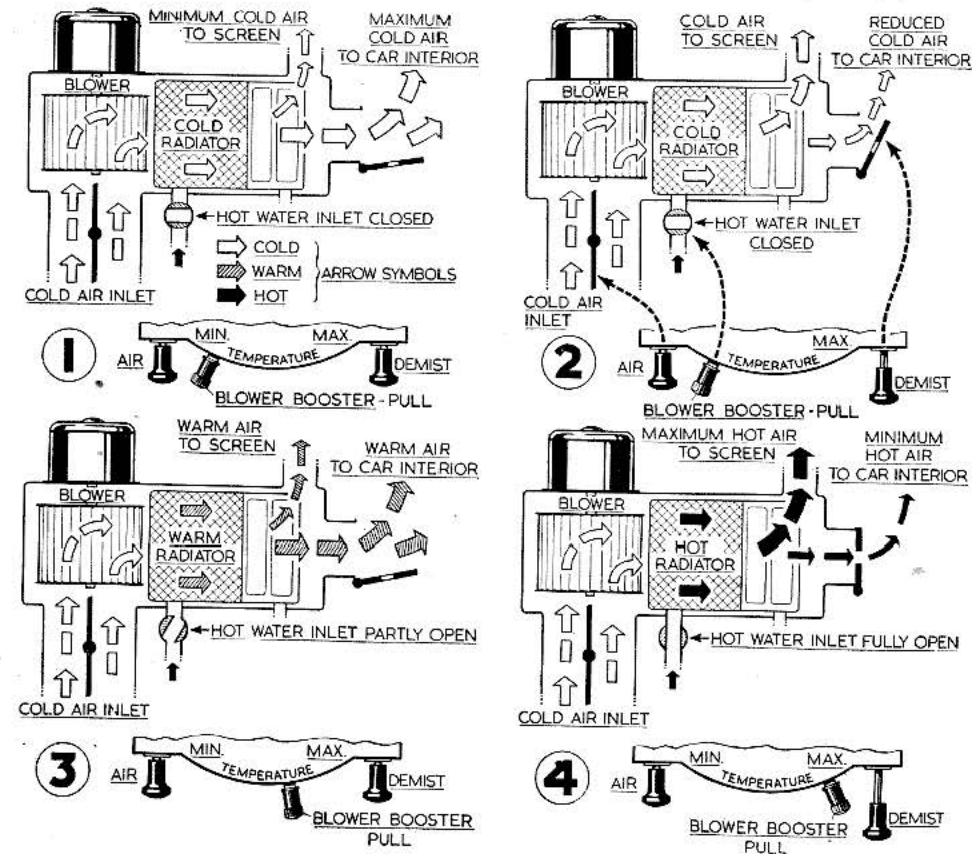

OPTIONAL EQUIPMENT

WINDSHIELD WASHER

The washing equipment supplied as an optional fitting is operated by pumping the knob on the instrument panel. As the knob moves towards the panel a jet of cleaning fluid is ejected onto the windshield from nozzles on the scuttle.

Set the windshield wipers in motion before operating the cleaning jets.

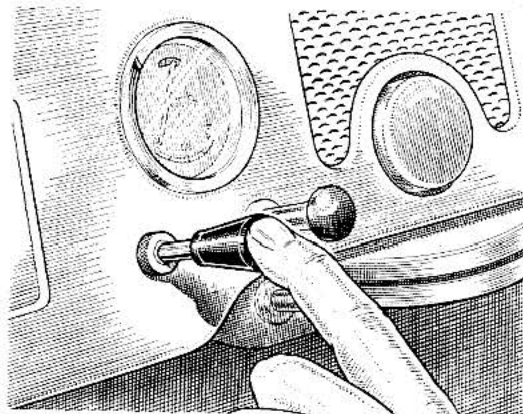

WINDSHIELD WASHER FLUID

Fluid for the windshield is stored in an unbreakable bottle clipped to the engine bulkhead. When refilling with fluid, unscrew the cap from the bottle and lift the bottle from its clip.

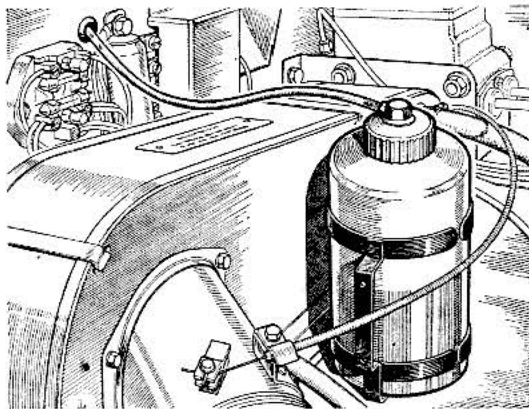

PREPARING FOR THE ROAD

The following items of equipment are available as optional fittings:

Wire wheels.

White-walled tyres.

Road speed tyres.

Rim embellishers.

Alternative axle ratio (4.55 to 1).

Adjustable steering column (see page 6).

Tonneau cover.

Radiator blind (see page 32).

Heating and demisting equipment (see pages 12 and 13).

Twin horns.

Fog-lamp (see page 9).

H.M.V. car radio (provision has been made for easy installation).

Windshield washer.

FILLING THE FUEL TANK

The quantity of fuel in the tank is indicated on the instrument panel and the filler cap is at the rear of the car on the right-hand side.

Lift the small lever on the cap to release and raise the cap. Press the cap downwards to close it.

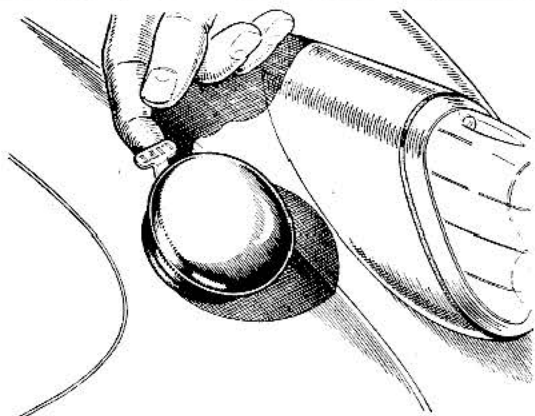

BONNET SAFETY CATCH

After releasing the bonnet lock from inside the car (page 7) push back the safety catch and raise the bonnet.

Release the prop from the under side of the lid and place its end in the hole provided in the deflector above the fan blades.

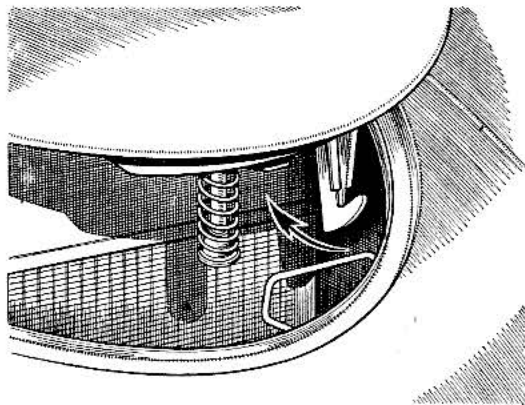

FILLING THE RADIATOR

The radiator should be filled until approximately 1 in. (25 mm.) of water is visible in the filler neck.

Unscrew the filler cap slowly if it is being removed while the engine is hot. The filler cap is retained by a bayonet catch with a graduated cam which permits release of internal pressure prior to removal. A lobe on the end of the cam guards against accidental release of the cap before the internal pressure is relieved. Protect your hand against escaping steam.

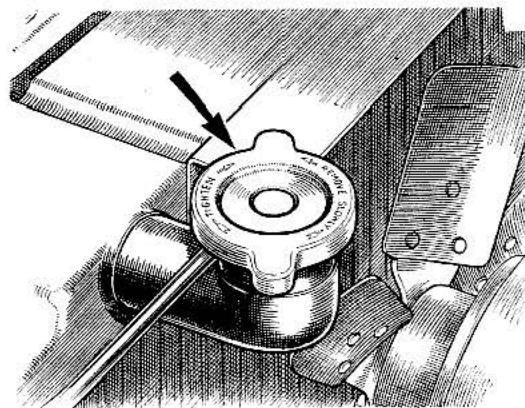

CHECKING THE ENGINE OIL

Check the supply of oil in the sump by withdrawing the dipstick on the right-hand side of the cylinder block. Wipe the lower portion of the rod, re-insert it and withdraw it again. Oil will cling to the rod and show the actual quantity present in the sump. The normal oil level is indicated by the "MAX" mark on the dipstick and should not be allowed to fall very far below this mark. Check the oil level every 250 miles (400 km.).

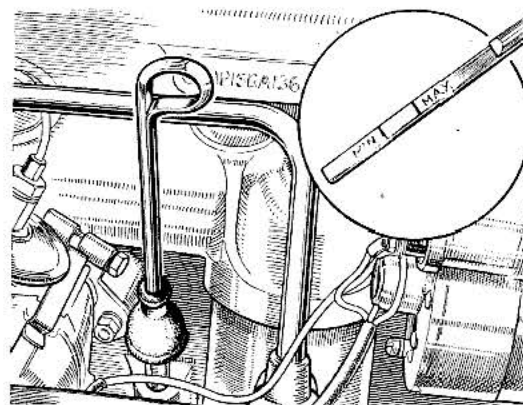

FILLING UP WITH ENGINE OIL

The filler cap is on top of the engine valve cover and is released by turning anti-clockwise.

When replacing the cap turn it clockwise to lock it in position.

Clean, fresh oil is essential and a list of the recommended lubricants is given at the end of this manual.

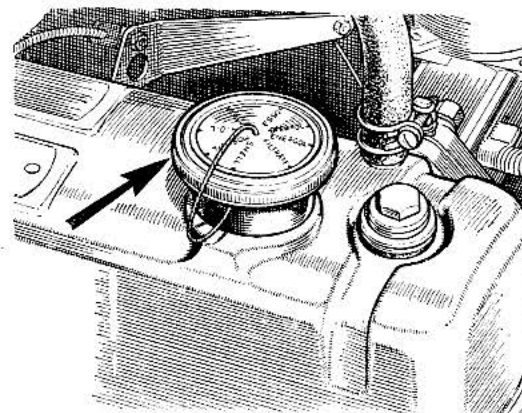

CHECKING TYRE PRESSURES

The tyre pressures should be checked and, if necessary, adjusted every 500 miles (800 km.). Gauges for testing tyre pressures can be bought from all reputable motor dealers. The correct tyre pressures are given on page 4.

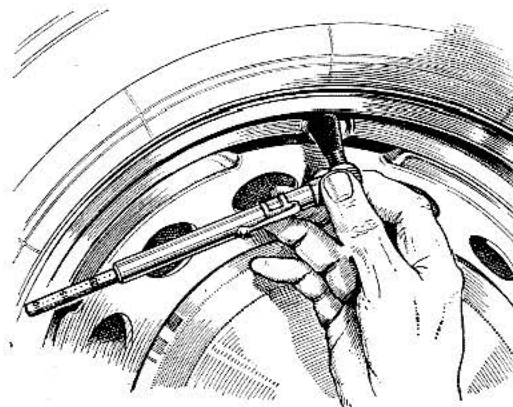

PREPARING FOR THE ROAD

STARTING UP

See that the gear lever is in the neutral position and that the hand brake is on. Pull out the mixture control knob and turn it to lock it in the open position. Use of this control is unnecessary when the engine is hot, and it need only be pulled out part of the way if the engine is warm.

Switch on the ignition and pull the starter switch knob smartly. The engine should revolve and start. Release the knob immediately the engine fires.

Gradually return the mixture control to the normal position as soon as the warming engine will allow.

WARMING UP

It is extremely bad practice to allow the engine to warm up from cold by letting it idle slowly. The correct procedure is to let the engine turn over fairly fast (approximately 1,000 r.p.m.), so that it attains its correct working temperature AS QUICKLY AS POSSIBLE.

RUNNING IN

It is a great mistake to drive a new car either fast or hard (such as labouring up inclines in top gear).

For the first 200 miles (320 km.) the engine revolutions must not exceed 2,000 r.p.m.

The engine speeds should then only be increased gradually and progressively until at least 1,000 miles (1600 km.) have been covered.

GOOD DRIVING

Always change down early when encountering a gradient. It is bad practice to allow an engine to labour on a hill and the engine is unable to pick up properly on the lower gear if changing is left too late.

Always take your foot off the clutch pedal when you are not actually operating the clutch. This saves clutch wear.

It is advisable to engage a lower gear when descending a steep hill and leave the clutch engaged to obtain the advantage of the braking action of the engine. Don't coast with the clutch pedal depressed.

Always apply the brakes gently and progressively. Violent braking throws unnecessary strain on the car and tyres, causes skidding and is dangerous. A good and careful driver anticipates the need for braking. Never attempt to engage reverse gear when the car is moving forwards or a forward gear when the car is moving backwards.

LUGGAGE AND TOOLS

LUGGAGE AND TOOLS

OPENING THE LUGGAGE BOOT

Tip forward the left-hand seat and pull the ring at the rear of the hood stowage compartment on the left-hand side.

Raise the boot lid and support it with the prop clipped to the underside.

To close the lid, stow the prop and press down until the lock is heard to engage.

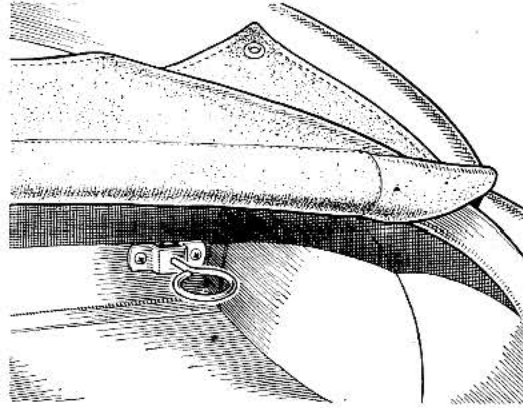

STARTING HANDLE AND TOOL KIT

The starting handle is located in spring clips above the spare wheel in the luggage compartment and the jack and tool kit are housed in a roll strapped above the spare wheel.

When using the starting handle keep the thumb on the same side of the handle as the palm of the hand for safety in case of a backfire.

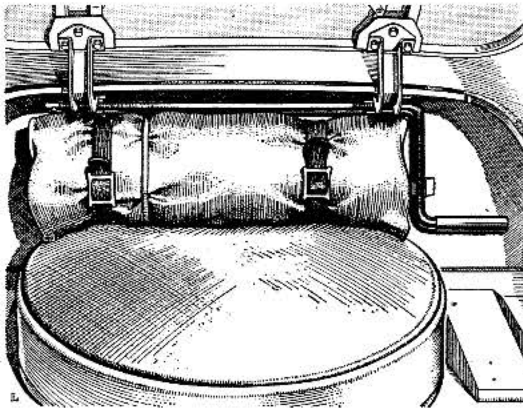

TOOL KIT CONTENTS

Ring-type tappet spanner.

Wheel brace (pressed wheels) or copper hammer (wire wheels).

Valve clearance gauge .017 in. (.43 mm.).

Sparking plug spanner $\frac{1}{2} \times \frac{9}{16}$ B.S.F.

Pair of pliers.

Grease gun.

Adjustable spanner.

Two tyre levers.

Cylinder head nut spanner.

Tyre valve spanner.

(The tools supplied may vary or be omitted from time to time as a result of design modifications.)

Distributor feeler and screwdriver.

Tyre pump.

Set of U.N.F. box spanners :

$\frac{7}{16} \times \frac{1}{2}$, $\frac{9}{16} \times \frac{5}{8}$, $\frac{11}{16} \times \frac{3}{4}$ and tommy bar.

Set of open-ended U.N.F. spanners :

$\frac{7}{16} \times \frac{1}{2}$, $\frac{9}{16} \times \frac{5}{8}$, $\frac{11}{16} \times \frac{3}{4}$.

Screwdriver (normal).

Screwdriver (recessed head).

Jack and jack handle.

Lockheed bleeder drain tube.

Gearbox and axle plug spanner.

"Tipon" paint touch-up pencil.

WHEELS AND TYRES

WHEELS AND TYRES

SPARE WHEEL

The spare wheel is housed in the luggage compartment and is clamped in position beneath the cover. Remember that the spare wheel tyre should be maintained at the normal running pressure of the rear tyres. For tyre pressures see page 4.

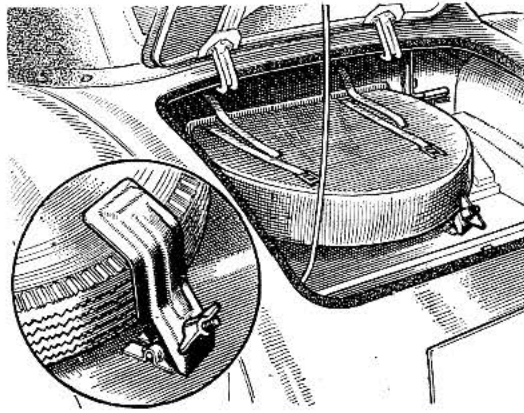

JACKING UP (FRONT)

The screw-type jack should be placed under the lower wishbones, with its pad engaging the depression between the spring seating and the lower link.

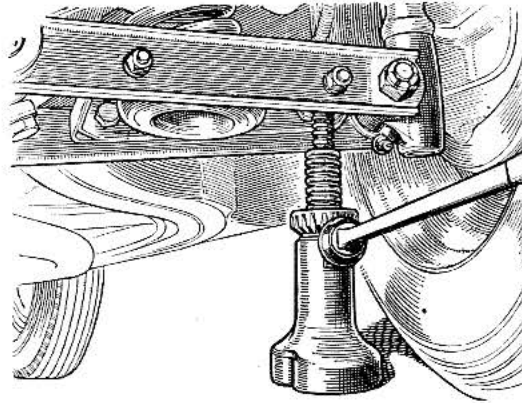

JACKING UP (REAR)

The screw-type jack should be placed under the rear spring, close to the axle, when lifting the rear of the car.

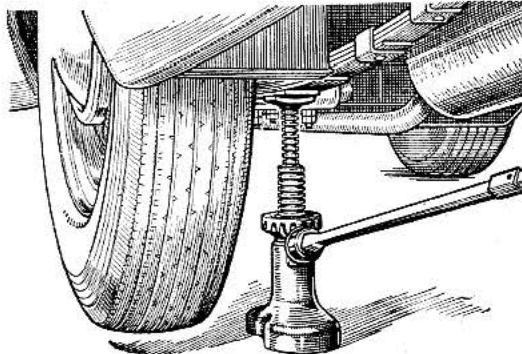

WHEELS AND TYRES

REMOVING THE WHEEL DISCS

Remove the wheel disc by inserting the flattened end of the wheel nut spanner in the recess provided in the road wheel and levering off the hub cover, using a sideways motion of the spanner and not a radial one. A radial movement of the spanner will open out the rim of the disc. To refit the hub disc, the rim should be placed over two of the buttons on the wheel centre and the outer face given a sharp blow with the fist over the third button.

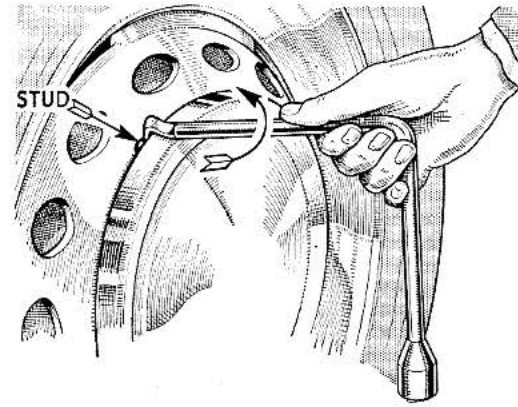

REMOVING PRESSED WHEELS

Slacken the four nuts securing the road wheels to the hub; turn clockwise to tighten and anti-clockwise to loosen. Raise the car to lift the wheel clear of the ground and remove the nuts. Withdraw the road wheel from the hub, taking care not to lose the brake adjuster hole seal. When replacing the road wheel ensure that the correct hole in the wheel is in line with the brake-drum hole and that the securing nuts are fitted with the taper side towards the wheel.

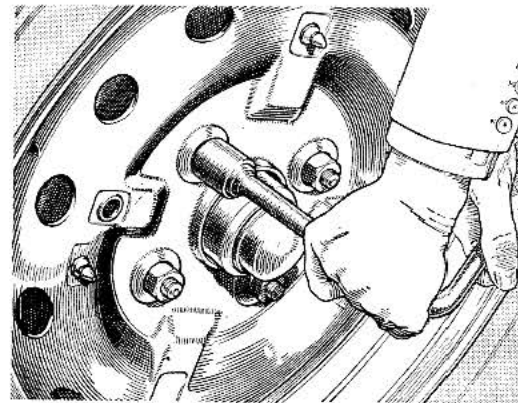

REMOVING WIRE WHEELS

Use the copper mallet provided in the tool kit to slacken the winged hub nut used to secure the wire wheel to its splined shaft. The hub nuts on the left-hand side of the car have right-hand threads (turn anti-clockwise to unscrew) and the nuts on the right-hand side of the car have left-hand threads (turn clockwise to unscrew).

A right-hand wheel is shown in the illustration.

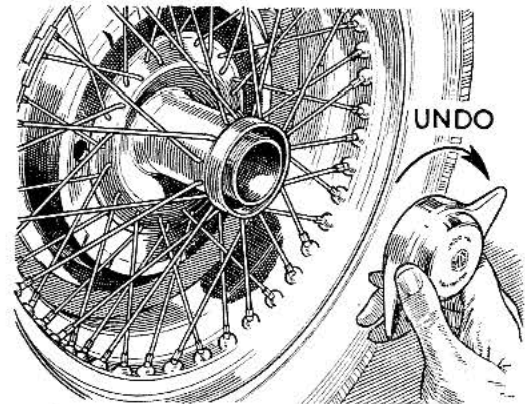

TYRE REMOVAL

Inextensible wires are incorporated in the edges of tyres. Do not attempt to stretch the edges of the tyre cover over the rim. Force is entirely unnecessary and dangerous, as it merely tends to damage the cover edges. Fitting or removing will be quite easy if the wire edges are carefully adjusted into the rim base. If the cover edge fits tightly on the rim seating it should be freed by using the tyre levers as indicated.

Remove all valve parts to completely deflate the tyre and push both cover edges into the base of the rim at the point diametrically opposite to the valve, then lever the cover edge near the valve over the rim edge (see illustration below).

This permits the tyre valve to be pushed through the hole in the rim and the inner tube to be withdrawn for attention when required.

TYRE REPLACEMENT

A similar technique has to be employed when replacing the tyre, first fitting the tyre into the rim at a point opposite to the valve, and finishing the fitting in the region of the valve, keeping the beaded edge in the well base of the rim.

REPAIRING TUBES

Have punctures or injuries vulcanised. Ordinary patches should only be used for emergencies.

Vulcanising is absolutely essential in the case of tubes manufactured from synthetic rubber.

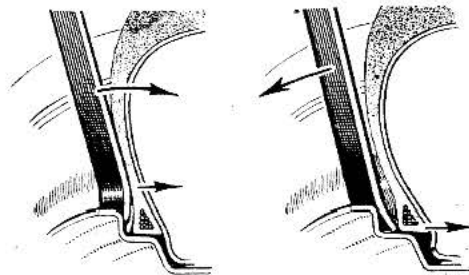

1. Insert lever between bead and rim with curved end against tyre. Press lever towards tyre.
2. Insert second lever in space between bead and rim, with curved end outwards, and pull lever away from tyre. Repeat at intervals round tyre until bead is free. Several circuits of tyre may be necessary.

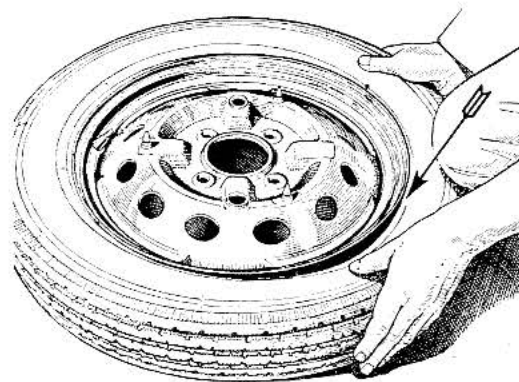

BALANCING TYRES

The light sides of the covers and the heavy sides of the tubes are marked with coloured spots. Tyres and tubes should be fitted with these spots coinciding to ensure the best balance.

When new tyres are fitted the wheels should be balanced as accurately as possible by your dealer, using special Dunlop wheel rim weights.

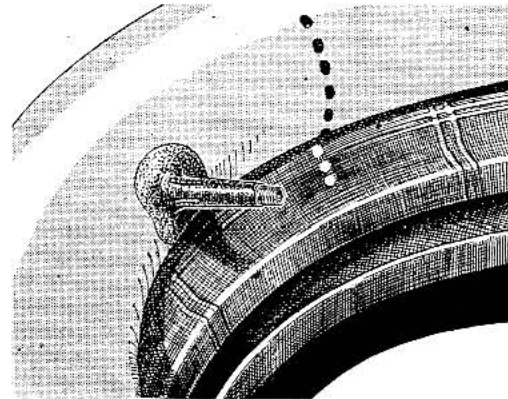

TYRE VALVES

The airtightness of the valve depends upon the proper functioning of its interior. It may be tested for airtightness by rotating the wheel until the valve is at the top and inserting its end in an eggcup full of water. If bubbles appear the interior is faulty and should be replaced by a new one.

VALVE INTERIORS

It is advisable always to have spare interiors handy, and these are procurable suitably packed in small metal containers. A small extracting and fitting tool is supplied in the tool kit.

Always make sure that valve interiors are screwed well home on replacement.

VALVE CAPS

The valve caps should be kept firmly tightened to prevent dust and water entering and damaging the valve seats. The caps also act as an additional air seal.

When they are removed for tyre inflation or removal they should always be placed in a clean place.

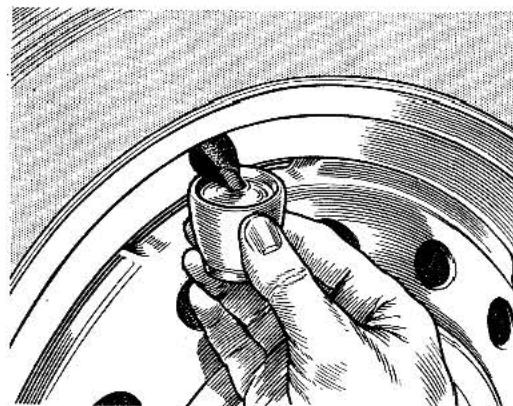

WHEELS AND TYRES

CARE OF TYRES

Every 3,000 miles (5000 km.) the running position of the tyres should be changed and the spare should come into use. This will equalise the tyre wear of the front and rear wheels and prolong the life of the tyres.

Inspect the tyres frequently and remove any pieces of flint, stone or glass which have become embedded in the covers.

See front wheel alignment, page 59.

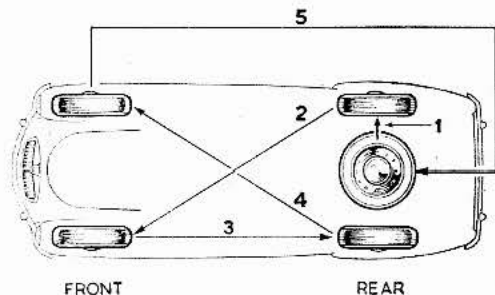

CARE OF WIRE WHEELS

Wire wheels will require periodic checking to see that no spokes have worked loose or are losing their tension.

This can be done by drawing a light spanner or similar metal object across the spokes, which should emit a clear ringing note. If any spokes are slack the note will be dull or flat by comparison.

Any small amount of individual slackness may be taken up by adjusting the spoke nipple with a spanner, but great care must be taken to ensure the general tension of the wheel is not upset by over-tightening any of the spokes as this will cause other spokes to break and the wheel to run out of truth.

If a spoke is replaced and it is found that the spoke end protrudes through the nipple body it must be filed off carefully to prevent any damage to the tube.

Tyres should be removed periodically so that the wheel rim can be examined for corrosion.

Any signs of rust must be removed by polishing with emery paper and the area afterwards protected with paint.

When a general overhaul of wheels becomes necessary, they should be sent to a wheel specialist for repair.

THE SIDESCREENS AND HOOD

CLEANING THE CAR

SIDESCREENS AND HOOD

SIDESCREENS

The sidescreens are attached to the doors by means of a pin and socket at the rear, and a bracket at the front which is clamped in position by a pin and wing nut.

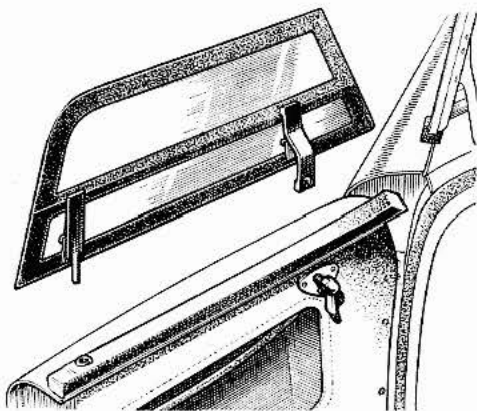

SIDESCREEN STOWAGE

The sidescreens are stowed in a container behind the seats and each should be placed in a separate pocket with the cranked bracket at opposite ends and facing the rear of the car.

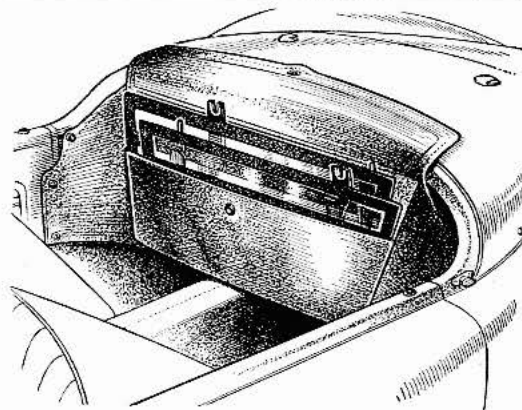

RELEASING THE HOOD

The hood is secured to the top of the windshield by two wing bolts which must be slackened to release the hood. When the hood is lowered fold it correctly to prevent damage.

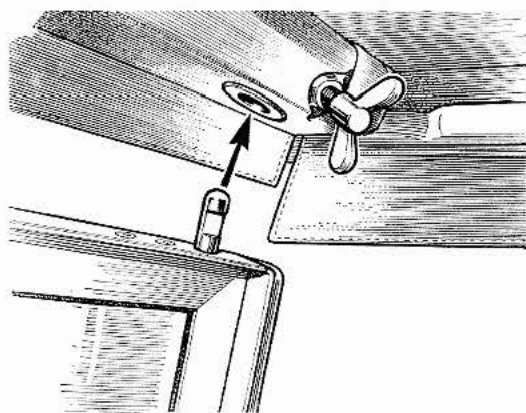

SIDESCREENS AND HOOD

FOLDING THE HOOD

Never fold the hood when it is wet or damp, wait until it is dry.

- (1) Release the hood from the pillars at the top of the windshield.
- (2) Release the rear of the hood from the three buttons and the turn-buckle at each side. Pull on the centre knob to release each button.
- (3) Raise the front of the hood slightly to release the tension in the canvas, and pull the bottom of the hood to the rear to release it from the two anchor brackets above the luggage boot lid.
- (4) Tip the seats forward, unfasten the sidescreen container and turn it over onto the tonneau panel.
- (5) Leave the rear window panel suspended over the body panel and collapse the hood into the stowage compartment, pulling the material clear of the

(Continued on page 30)

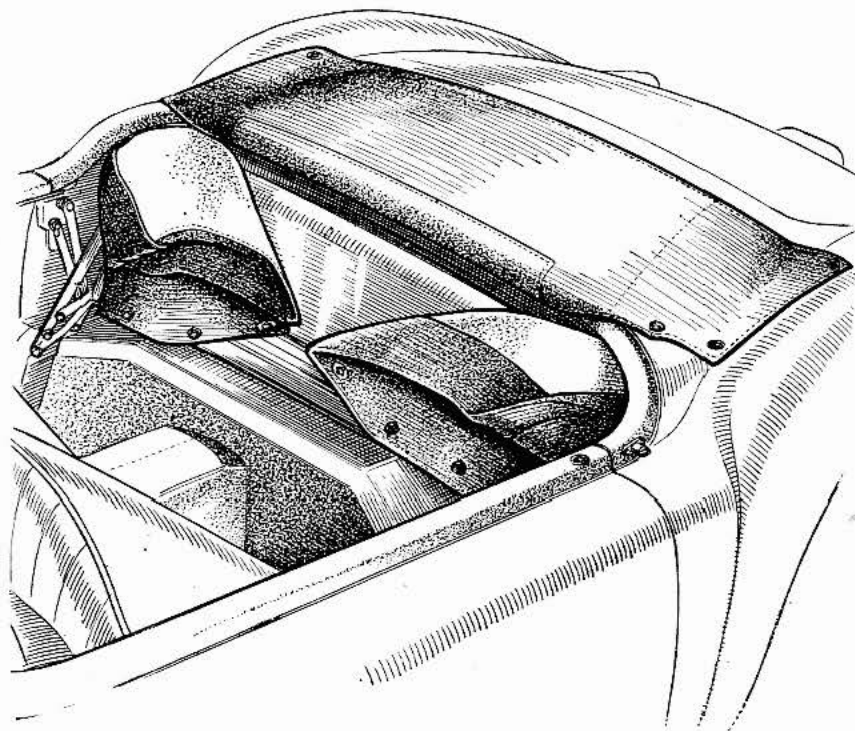

CLEANING THE CAR

hood irons and folding it over the front rail. Fold the rear window forwards over the hood, pulling out the spare material at each side and folding it neatly over the front of the window.

- (6) Push the folded hood well into the stowage compartment and bring the sidescreen container forward to cover the hood.
- (7) Remove the sidescreens and stow them in the container pockets with the cranked bracket of each screen at opposite ends and facing the rear.
- (8) Secure the sidescreen container over the folded hood with the six buttons.

CLEANING THE CAR

Bodywork. The car should be washed and dried thoroughly before applying polish. The use of a good non-abrasive polish is essential.

Grease and tar spots must be carefully removed with a wadding pad dipped in petrol (gasoline). Chromium plating should be washed frequently with soap and warm water only. Metal polishes, or abrasives of any sort, must not be used.

Windshield. Methylated spirits (de-natured alcohol) should be used to remove tar spots and other stains from the windshield. It has been found that the use of some silicon and wax-based polishes for this purpose can be detrimental to the wiper blades.

Upholstery. The upholstery should be cleaned at regular intervals by wiping it with a damp cloth and polishing it with a clean soft cloth when it is dry. The use of polish is quite unnecessary.

Hood. When necessary the hood cloth may be cleaned with water applied with a brush, without impairing its waterproof qualities. Soaps and detergents must **not** be used.

PAINTWORK DAMAGE

Scratches and minor damage to the finish may be repaired by the use of the "Tipon" touch-up brush and paint supplied with the tool kit. Thoroughly clean the damaged area before applying the paint.

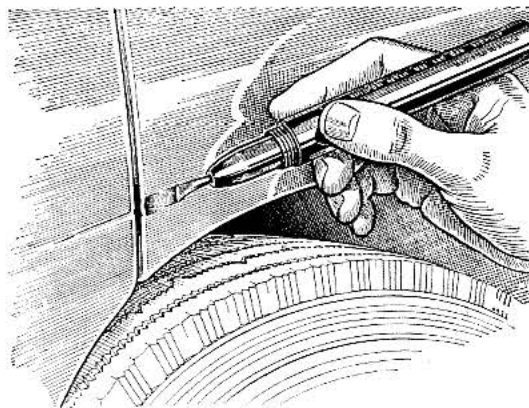

COLD WEATHER PRECAUTIONS

COLD WEATHER PRECAUTIONS

If the car is not stored in a warmed building, steps must be taken to prevent the cooling water from freezing during frosty weather. Water, upon freezing, expands, with the result that there is a very considerable risk of bursting either the radiator or the cylinder block by the pressure generated. As a precautionary measure when frost is anticipated, the water should be drawn from the radiator and engine (see page 33) before the car is stored for the night, or, better still, an anti-freeze solution may be used in the radiator.

We recommend owners to use Smiths "Bluecol," Shell "Snowflake," "Esso" Anti-freeze or Filtrate "Nevafreze" non-erosive anti-freeze in order to protect the cooling system during frosty weather and reduce corrosion to a minimum.

IMPORTANT

Never use a muff on the radiator grille to protect the cooling system in cold weather as this would seal the carburetter and heater unit air supply. The radiator must be protected by a blind such as the type available as an optional extra fitting.

WARNING

As the cooling system is sealed, relatively high temperatures are developed in the radiator upper tank. For this reason anti-freeze solutions having an alcohol base are unsuitable owing to their high evaporation rate producing rapid loss of coolant and a consequent interruption of the circulation of coolant.

Only anti-freeze of the ethylene glycol or glycerine type is suitable for use in the cooling system.

The correct quantities of anti-freeze for different degrees of frost resistance are:—

15° frost	1 pint (.57 litre ; 1.2 U.S. pints)
25° frost	1½ pints (.85 litre ; 1.8 U.S. pints)
35° frost	2 pints (1.1 litres ; 2.4 U.S. pints)

First decide what degree of frost protection is required before adding the anti-freeze to the radiator. If temperatures below 0° F. (−18° C.) are likely, solutions of 25% or more must be employed. Consult your local Dealer for the correct proportions.

Before introducing anti-freeze mixture to the radiator it is advisable to clean out the cooling system thoroughly by swilling out the passages with a hose inserted in the filler cap, keeping the drain taps open. Only top up when the cooling system is at its normal running temperature, in order to avoid losing anti-freeze due to expansion.

Make sure that the cooling system is watertight and examine all joints, replacing any defective rubber hose with new.

The capacity of the cooling system is 10 pints (5.7 litres, 12 U.S. pints).

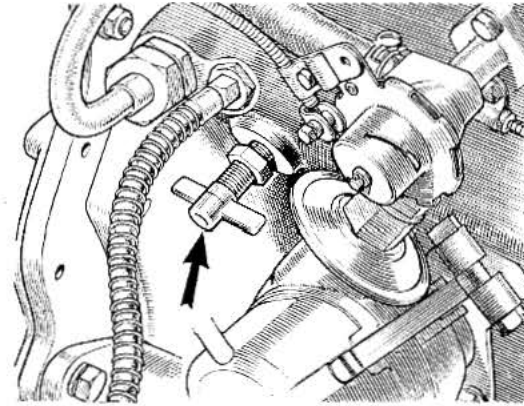

THE ENGINE DRAIN TAP

To drain the water from the engine, carefully release the radiator filler cap (see page 16) and open the tap on the rear right-hand side of the cylinder block.

To drain the cooling system completely the radiator drain tap also must be opened.

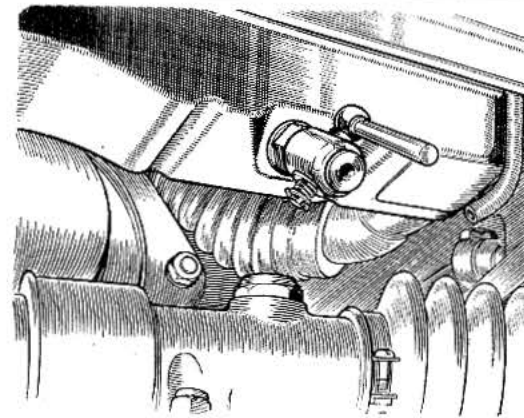

THE RADIATOR DRAIN TAP

This tap is located on the front of the radiator bottom tank on the left-hand side and is accessible from below the front bumper between the number-plate and the over-rider. Release the radiator filler cap carefully (see page 16) when draining the radiator. To drain the cooling system completely the engine drain tap must also be opened.

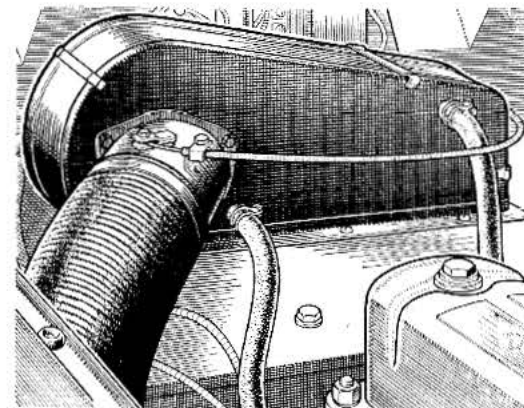

THE HEATER UNIT

When a heater unit has been fitted the water cannot be drained from it completely by opening the engine and radiator drain taps, and it is essential that an anti-freeze mixture is used in the cooling system to prevent damage by freezing.

To assist draining the system when a heater unit is fitted, the temperature control lever on the heater panel should be in the right-hand or "Max." position.

LUCAS SERVICE DEPOTS

BELFAST 51/55 Upper Library Street.	<i>Telegrams</i> : " Servdep, Belfast." <i>Telephone</i> : Belfast 25617.
BIRMINGHAM, 18 Great Hampton Street.	<i>Telegrams</i> : " Lucas, Telex, Birmingham." <i>Telephone</i> : Central 5050.
BRIGHTON, 4 85 Old Shoreham Road, Hove.	<i>Telegrams</i> : " Luserv, Brighton." <i>Telephone</i> : Hove 38993.
BRISTOL, 4 345 Bath Road.	<i>Telegrams</i> : " Kingly, Bristol." <i>Telephone</i> : Bristol 76001.
CARDIFF 54a Penarth Road.	<i>Telegrams</i> : " Lucas, Cardiff." <i>Telephone</i> : Cardiff 28361.
DUBLIN Portland Street North, North Circular Road.	<i>Telegrams</i> : " Luserv, Dublin." <i>Telephone</i> : Dublin 46195.
EDINBURGH, 11 60 Stevenson Road, Gorgie.	<i>Telegrams</i> : " Luserv, Edinburgh." <i>Telephone</i> : Edinburgh 62921.
GLASGOW, C.3 4/24 Grant Street (St. George's Road).	<i>Telegrams</i> : " Lucas, Glasgow." <i>Telephone</i> : Douglas 6591.
LEEDS, 8 64 Roseville Road.	<i>Telegrams</i> : " Luserdep, Leeds, 8." <i>Telephone</i> : Leeds 28591.
LIVERPOOL, 13 450/470 Edge Lane.	<i>Telegrams</i> : " Luserv, Liverpool, 13." <i>Telephone</i> : Stoneycroft 4721.
LONDON Dordrecht Road, Acton Vale, W.3.	<i>Telegrams</i> : " Dynamagna, Ealux, London." <i>Telephone</i> : Shepherd's Bush 3160.
LONDON 757/759 High Road, Leyton, E.10.	<i>Telegrams</i> : " Luserdep, Leystone, London." <i>Telephone</i> : Leytonstone 3361.
MANCHESTER Talbot Road, Stretford.	<i>Telegrams</i> : " Lucas, Stretford." <i>Telephone</i> : Longford 1101.
NEWCASTLE UPON TYNE, 1 64/68 St. Mary's Place.	<i>Telegrams</i> : " Motolite, Newcastle-on- Tyne." <i>Telephone</i> : Newcastle 25571.

In addition there are Lucas Service Agents in most centres.

A list of Lucas Overseas Depots can be obtained by application to :—

NUFFIELD EXPORTS LIMITED
COWLEY, OXFORD, ENGLAND

ELECTRICAL EQUIPMENT

FUSES

Fuse connecting "A1" and "A2".
This fuse protects the accessories which are connected so that they operate irrespective of whether the ignition is on or off.

Fuse connecting "A3" and "A4".
This fuse protects the accessories which are connected so that they operate only when the ignition is switched on. (Stop-lamps, etc.)

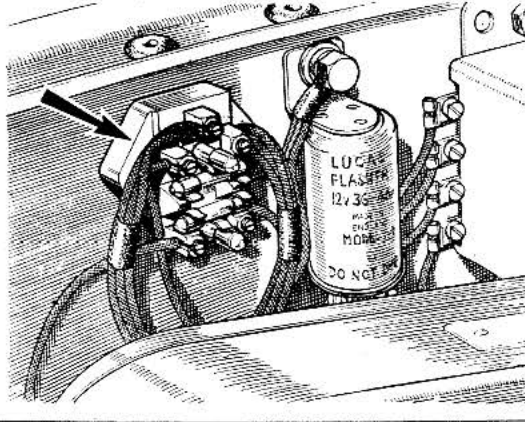

SPARE FUSES

Spare fuses are provided and it is important to use only the correct replacement fuse. The fusing value is marked on a coloured paper slip inside the glass tube of the fuse. If the new fuse blows immediately and the cause of the trouble cannot be found, have the equipment examined at a Lucas Service Depot.

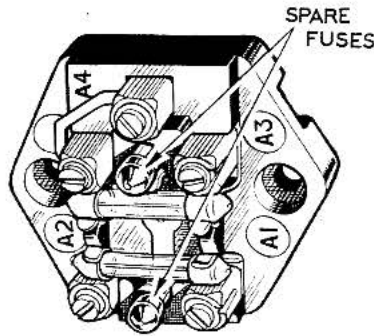

JAMMED STARTER PINION

In the event of the starter pinion becoming jammed in mesh with the flywheel, it can usually be freed by turning the starter armature by means of a spanner applied to the shaft extension at the commutator end. This is accessible after removing the small protective cap.

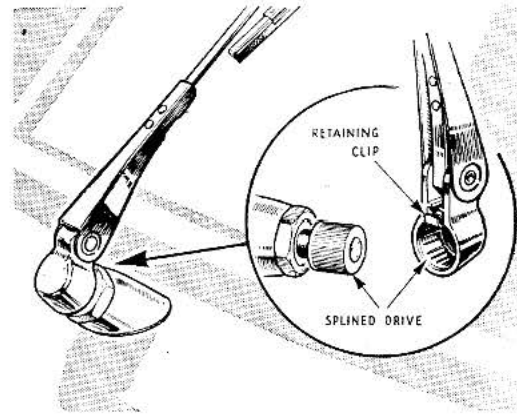
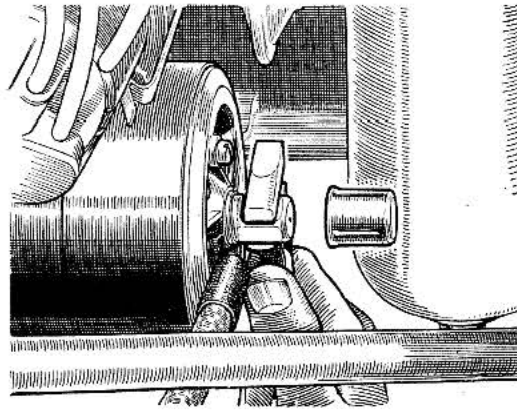

WINDSHIELD WIPER BLADES

To reposition the wiped area on the glass the arm must be withdrawn from the spindle, after pressing the spring retaining clip, and then refitted on another spline.

To disengage a blade, pull the arm away from the windshield and pivot the blade upwards.

When fitting a new rubber, withdraw the old squeegee from the flexible carrier, taking care not to lose the locating pins.

REMOVING THE LIGHT UNIT

To remove the light unit for bulb replacement, unscrew the securing screw at the bottom of the lamp rim and lift off the rim. Remove the dust-excluding rubber.

Press the light unit inwards against the tension of the three springs and turn it in an anti-clockwise direction until the heads of the retaining screws can pass through the enlarged ends of the keyhole slots in the rim.

Reverse this procedure to replace the light unit. The rubber seal is marked "Front" for correct replacement.

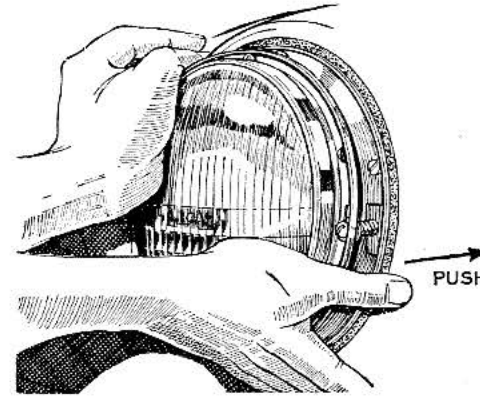

REPLACING HEADLAMP BULBS

Withdrawal of the light unit gives immediate access to the bulb carrier. Twist the back shell anti-clockwise and pull it off. The bulb can then be withdrawn from its holder.

Fit the replacement bulb in the holder, with the slot in its disc in engagement with the projection in the holder. Engage the projections on the back shell with the holder slots, press on and twist to the right until its catch engages.

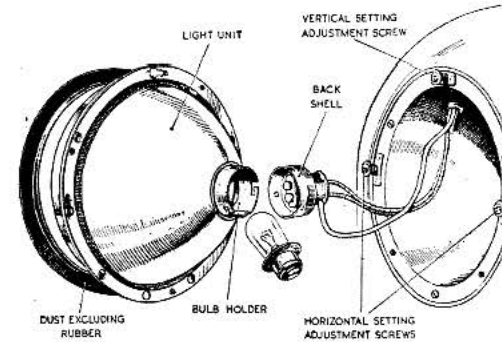

SETTING HEADLAMPS

The lamps should be set so that the main driving beams are parallel with the road surface or in accordance with local regulations. If adjustment is required, remove the rim as described on page 37. Vertical adjustment is made by turning the screw at the top of the lamp. Horizontal adjustment can be effected by using the adjustment screws on each side of the light unit.

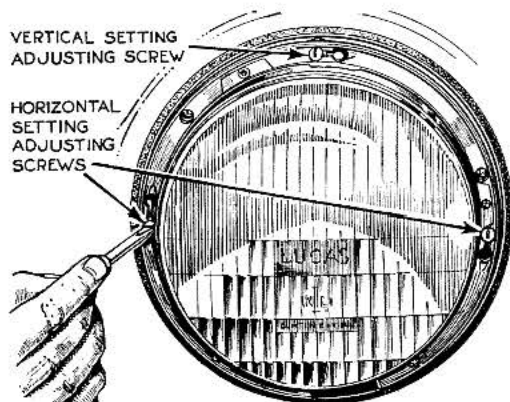

PILOT LAMPS

To reach the bulb, push the lamp front inwards and turn it anti-clockwise until it is free to be withdrawn. Reverse the movement to replace the front.

The locating pins on the bulb are offset to ensure that it is fitted correctly to give increased brilliance when the flashing equipment is operating.

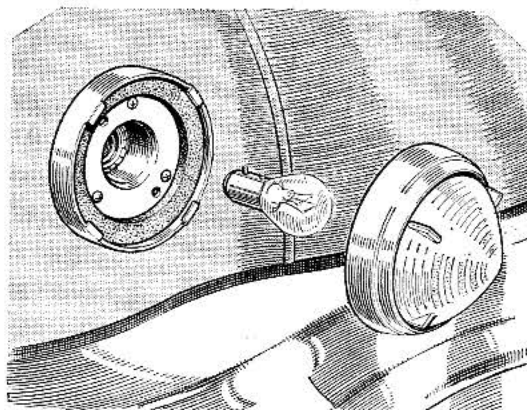

NUMBER-PLATE LAMP

The number-plate lamp only operates when the side- and tail-lights are switched on.

A single bayonet fixing bulb is fitted and the cover may be removed after slackening the small retaining screw.

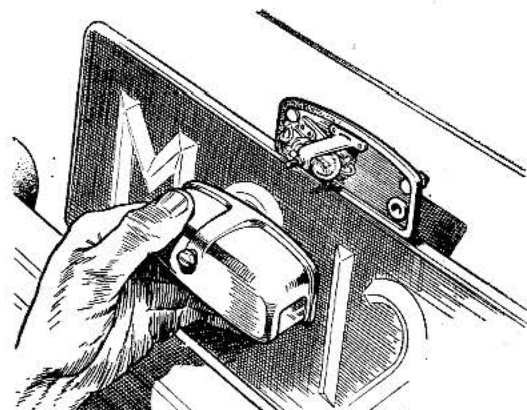

TAIL- AND STOP-LAMPS

Each lamp cover is secured by two screws and the bulb is accessible after the cover and rubber seal are removed.

The dual-filament tail- and stop-lamp bulb must provide the brighter light for stop and direction indication, and to ensure this the bulb has offset pegs and can only be fitted in one position.

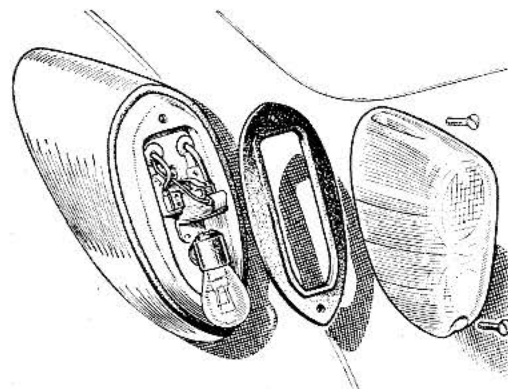

THE PANEL, MAP AND WARNING LIGHTS

There are four lamps illuminating the instruments and their locations, together with the three warning lamps and map lamp, are shown by the arrows in the accompanying illustration.

The bulbs are accessible from below the instrument panel.

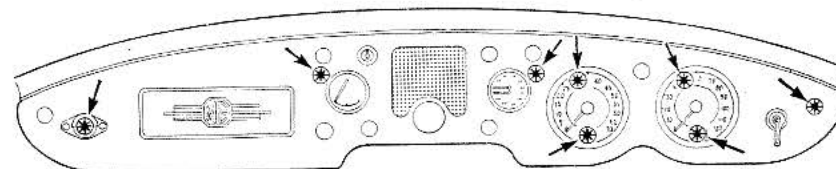

REPLACEMENT BULBS (12 VOLT)

	Watts	Lucas No.
Headlamps, Home and Export (RHD) (dip left)	42/36	(pre-focus) 354
Headlamps, Export and U.S.A. (LHD) (dip right)	36/36	(pre-focus) 301
Headlamps Export (Europe, except France) ..	45/35	(pre-focus) 360
Sidelamp and Stop tail-lamp (irreversible) ..	6/18	(S.B.C.) .. 361
Number-plate lamp	4	(M.C.C.) 222
Panel lights and warning lights	2.2	(M.E.S.) .. 987

ELECTRICAL

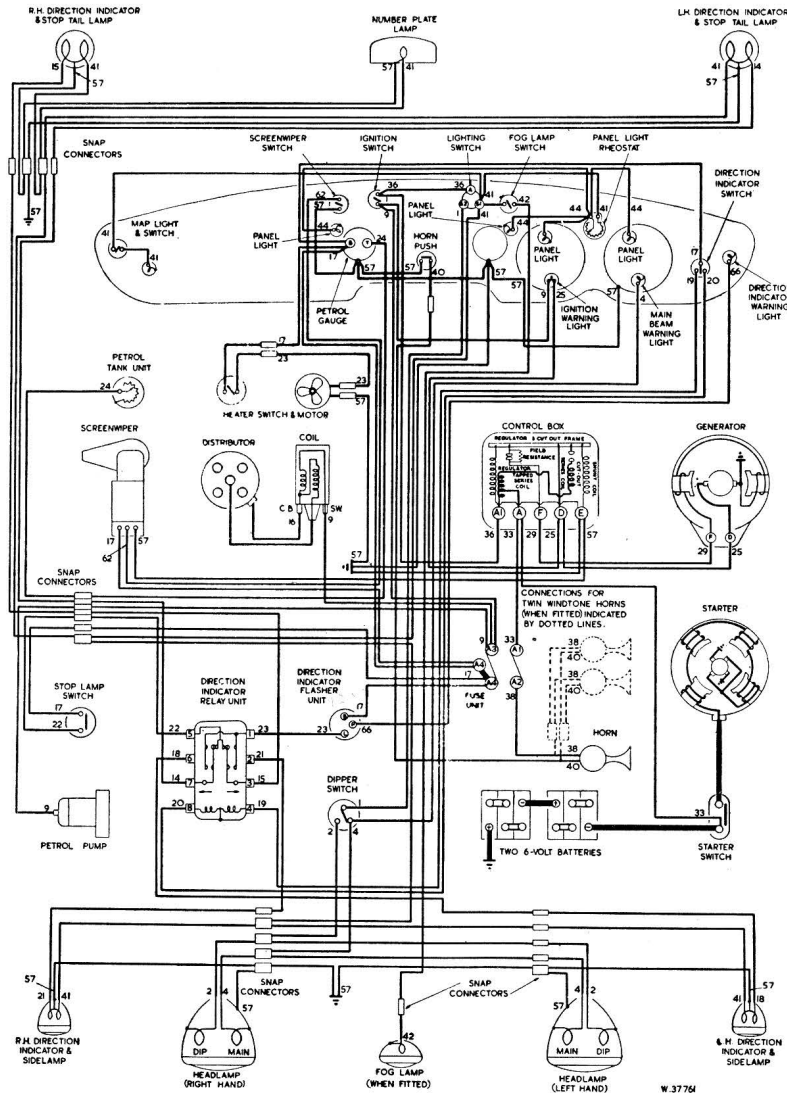

KEY TO CABLE COLOURS

1 Blue	18 Green with Red	35 Brown with Yellow	51 Purple with Yellow
2 Blue with Red	19 Green with Blue	36 Brown with Blue	52 Purple with Blue
3 Blue with Yellow	20 Green with Blue	37 Brown with White	53 Purple with White
4 Blue with White	21 Green with White	38 Brown with Green	54 Purple with Green
5 Blue with Green	22 Green with Purple	39 Brown with Purple	55 Purple with Brown
6 Blue with Purple	23 Green with Brown	40 Brown with Black	56 Purple with Black
7 Blue with Brown	24 Green with Black	41 Red	57 Black
8 Blue with Black	25 Yellow	42 Red with Yellow	58 Black with Red
9 White	26 Yellow with Red	43 Red with Blue	59 Black with Yellow
10 White with Red	27 Yellow with Blue	44 Red with White	60 Black with Blue
11 White with Yellow	28 Yellow with White	45 Red with Green	61 Black with White
12 White with Blue	29 Yellow with Green	46 Red with Purple	62 Black with Green
13 White with Green	30 Yellow with Purple	47 Red with Brown	63 Black with Purple
14 White with Purple	31 Yellow with Brown	48 Red with Black	64 Black with Brown
15 White with Brown	32 Yellow with Black	49 Purple	65 Dark Green
16 White with Black	33 Brown	50 Purple with Red	66 Light Green
17 Green	34 Brown with Red		

SERVICE ADJUSTMENTS

TOP DEAD CENTRE

The rim of the crankshaft pulley is marked with a notch which will coincide with the longest of the three pointers on the timing chain case when number 1 and number 4 pistons are in the top dead centre position. The two pointers next to the T.D.C. pointer indicate the 5° and 10° position before T.D.C. The ignition timing should be set 7° B.T.D.C.

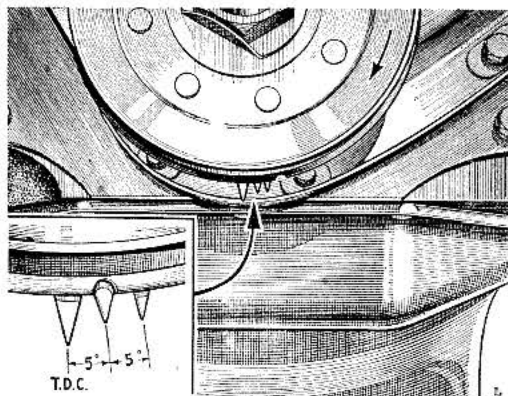

DISTRIBUTOR ADVANCE ADJUSTMENT

The automatic advance of the distributor timing is controlled by the induction manifold vacuum and a centrifugal mechanism. In addition, a vernier adjustment is provided to give control over the actual ignition point with varying conditions and fuel. Turn the milled nut clockwise to retard the ignition or anti-clockwise to advance and note the degree of change on the scale.

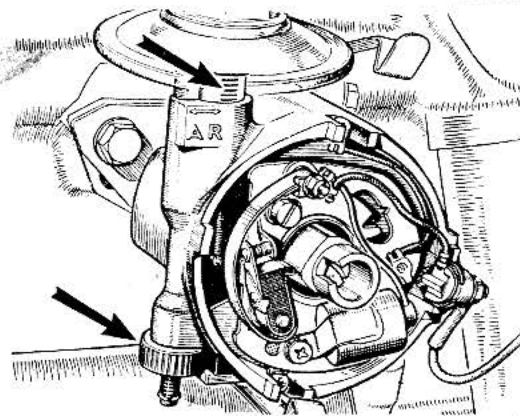

VALVE CLEARANCES

Both inlet and exhaust valves should have a clearance of at least .017 in. (.43 mm.) when hot. It is of utmost importance to set

No. 1 valve with No. 8 fully open	
No. 3 " " No. 6 " "	
No. 5 " " No. 4 " "	
No. 2 " " No. 7 " "	
No. 8 " " No. 1 " "	
No. 6 " " No. 3 " "	
No. 4 " " No. 5 " "	
No. 7 " " No. 2 " "	

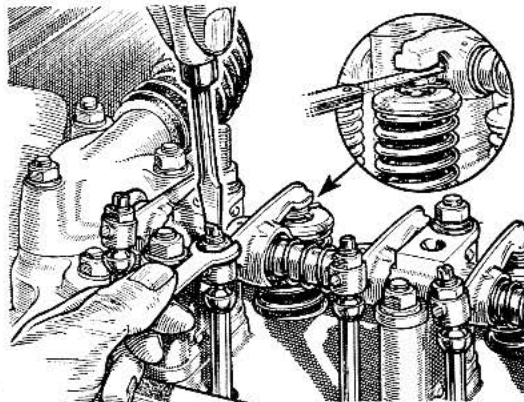

BRAKE ADJUSTMENT

Excessive brake pedal travel before the brakes come into operation is an indication that the brake-shoes must be moved nearer to the brake-drums. There are two brake adjusting screws for each front wheel brake and one screw for each rear brake. The arrows indicate the screws of a front brake after the wheel, brake-drum and hub have been removed.

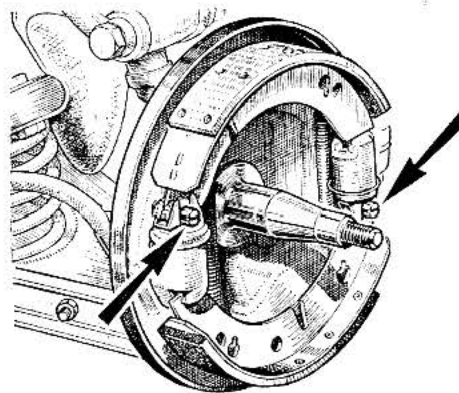

FRONT BRAKES

Apply the hand brake and use the jack to raise each wheel in turn. Remove the hub cap and rotate the wheel until one adjustment screw is visible through the small hole provided. Turn the screw in a clockwise direction until the wheel is locked, then turn anti-clockwise one notch only. The wheel should be free to rotate without the shoes rubbing. Turn the wheel until the opposite screw is visible, repeat procedure. Adjust the brakes on the other front wheel in a similar way.

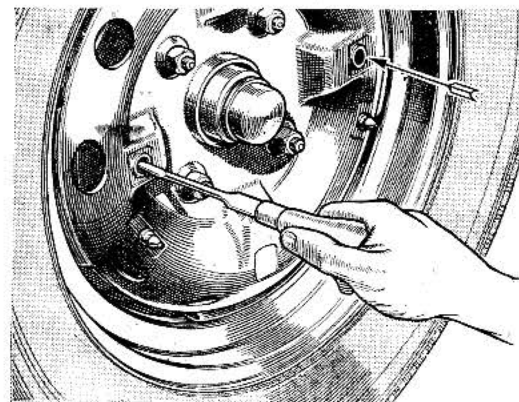

REAR BRAKES

The adjustment procedure is similar to that detailed above for the front brakes, except that one adjuster in each wheel controls both brake-shoes. Place blocks against the wheels remaining on the ground as it is essential that the hand brake should be fully released while the rear brake-shoes are being adjusted. Adjustment of the rear brake-shoes automatically adjusts the hand brake mechanism and no separate adjustment is required.

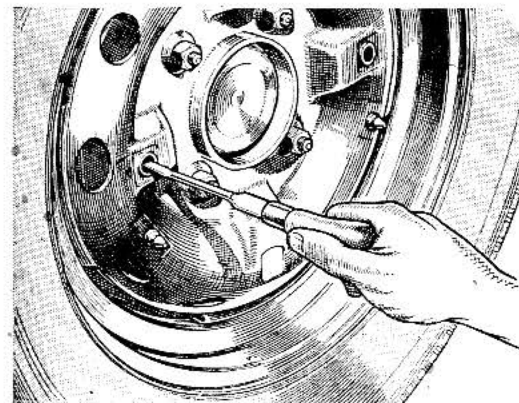

ADJUSTING THE JETS

Run the engine until it attains its normal running temperature and release the inter-carburetter throttle and mixture linkage. Set the slow-running screws on the carburetter throttle actuating levers so that the throttles are both open the same amount. This is indicated by the same suction noise at each carburetter.

Disconnect the mixture control wire from the end of the brass lever actuating the rear jet, and screw the jet adjusting nuts well downwards. Note that the jet actuating levers must be kept in contact with the jet heads the whole time.

The jet adjusting nuts should now be screwed upwards slowly (thus gradually weakening the mixture) until the engine idles evenly, firing on all cylinders regularly, and running at its best speed. This will be the normal slow-running position when the engine is hot, and as the jet needles are of the correct size the general performance on the road should be entirely satisfactory. Check by raising each carburetter piston with the pin indicated by the arrow. If the engine speed increases momentarily the setting is right. If the engine stalls the setting is too weak. If the engine speed increases permanently it is too rich.

The mixture control wire may be re-connected when the adjustment is satisfactory, care being taken to see that the control knob has ample clearance when the jet heads are in contact with the adjusting nuts. Final adjustment for slow running is then carried out by adjusting each of the carburetter throttle lever stop screws an equal amount before re-connecting the throttle and mixture linkage.

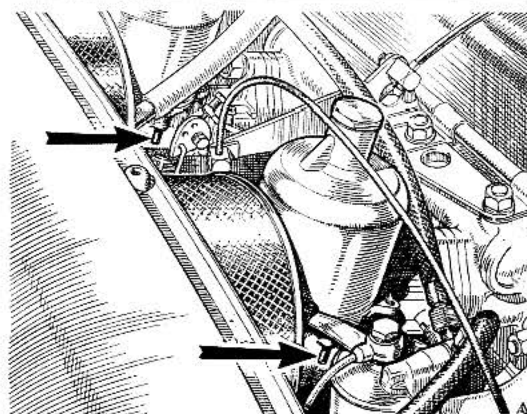
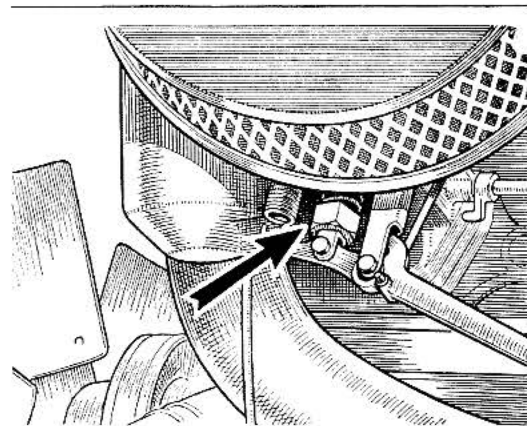
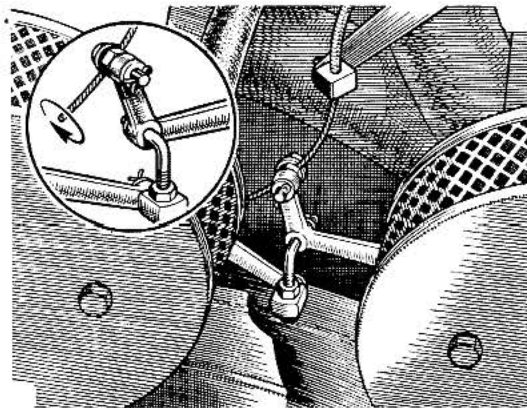

SLOW-RUNNING ADJUSTMENT

Slow-running adjustments are carried out by adjusting the position of the carburetter throttle lever stop screws, which are spring-loaded, until gentle slow running is attained.

Make sure that there is a small clearance between the mixture and throttle inter-connecting lever and its abutment screw.

It is important that both carburetters are set **exactly** alike and you are advised to entrust this to an M.G. Dealer.

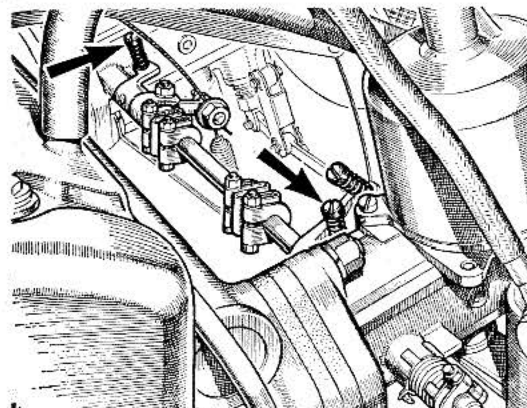

MIXTURE CONTROL LINKAGE ADJUSTMENT

When the mixture control knob on the instrument panel is right home there must be a small gap between the adjusting screw and the inter-connecting lever on the front carburetter. This gap determines the degree of inter-linkage between the throttle and the mixture control and should be set so that there is just clearance between the end of the adjusting screw and the anvil of the rocking lever linked to the jet operating lever.

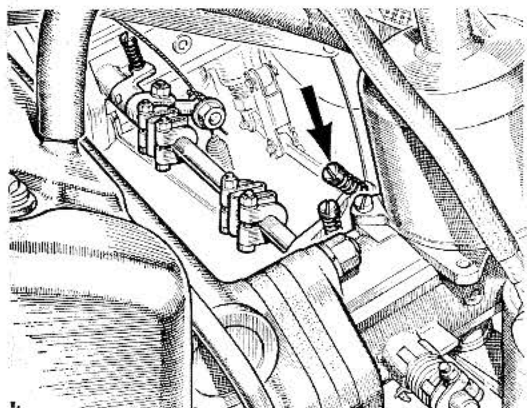

ACCESSORIES AND EQUIPMENT

The following proprietary equipment and parts therefor can be obtained direct from the Service Department of the M.G. Car Co. Ltd., or will be supplied by any authorised M.G. Dealer at current list prices.

All claims for replacement of alleged defective parts must, however, be referred direct to the respective manufacturers. See conditions of Warranty.

Note.—All correspondence and claims in connection with proprietary fittings on exported cars should be addressed to Nuffield Exports Limited, Cowley, Oxford, England, and not to the manufacturers.

<i>Name of Part</i>	<i>Name and address of Manufacturer</i>
Dynamo	Joseph Lucas Ltd., Great Hampton Street, Birmingham.
Starter	Ditto
Ignition Coil	Ditto
Distributor	Ditto
Switchbox	Ditto
Voltage Regulator	Ditto
Fuse Box	Ditto
Batteries	Ditto
Lamps	Ditto
Dip Switch	Ditto
Horn	Ditto
Starter Switch	Ditto
Windshield Wipers	Ditto
Electric Bulbs	Ditto
Stop-light Switch	Ditto
Flashing Light Unit and Relay	Ditto
Fuel Gauge and Attach.	British Jaeger Instruments Ltd., Chronos Works, North Circular Road, London, N.W.2.
Oil Pressure Gauge	Ditto
Speedometer and Cable	Ditto
Water Temperature Gauge	Ditto
Revolution Indicator	Ditto
Grease Gun	Tecalemit Ltd., Plymouth, Devon.
Oil Filter	Ditto
Carburetters	The S.U. Carburetter Co. Ltd., Wood Lane, Erdington, Birmingham, 24.
Fuel Pump	Ditto
Tyres	Dunlop Rubber Co. Ltd., Fort Dunlop, Erdington, Birmingham.
Hydraulic Dampers	Makers indicated on Dampers.
Radiator	To : Authorised M.G. Radiator Repair Station.
Tools	R. T. Shelley Ltd., Aston Brook Street, Birmingham.
Tyre Pump	Ditto
Jack	Abingdon King Dick Ltd., King's Road, Tyseley, Birmingham, 11.
Sparking Plugs	Champion Sparking Plug Co. Ltd., Feltham, Middlesex.
Air Cleaner	Vokes Ltd., Henley Park, Guildford.

MAINTENANCE PROCEDURE

MAINTENANCE SUMMARY

NOTE.—When carrying out the operations recommended at any particular mileage, it is important that all the operations given under the headings of shorter mileages are carried out at the same time.

After first 500 miles (800 km.). Drain old oil from engine; **do not flush out engine with paraffin** but merely fill with fresh oil. Examine valve rocker clearances and adjust if incorrect. Tighten cylinder head stud nuts. Check contact breaker gap.

Drain old oil from gearbox and rear axle and replenish with fresh oil.

Note.—This service is free under the M.G. 500 Miles Free Service Scheme. (See page 50.)

Every 250 miles (400 km.). Inspect oil level in crankcase. Refill if necessary. (See page 17.)

Every 500 miles (800 km.). Test tyre pressures. (See page 17.)
See that radiator is full of water.

Every 1,000 miles (1600 km.). Lubricate all grease nipples (except steering rack and pinion).
Examine oil level in gearbox (see page 51) and rear axle (see page 52) and replenish if necessary.

Examine fluid level in hydraulic brake gear supply tank and replenish if necessary. The tank should be full of fluid to within $\frac{1}{4}$ in. (6.3 mm.) of the bottom of the filler opening. **Use only Genuine Lockheed Brake Fluid.** (See page 52.)

Add oil to carburetter dashpots. (See page 52.) Lubricate carburetter controls.

Check battery cell specific gravity and top up batteries with distilled water. (See page 53.)

Make visual inspection of brake lines and pipes.

Check wheel nuts for tightness.

Examine all hydraulic dampers for leaks.

Every 3,000 miles (5000 km.). Drain engine. Refill with fresh oil. (See pages 54 and 17.)

Clean and re-oil air cleaners. (See page 54.)

Insert two drops of oil to Ref. F in Recommended Oils, page 64, to oil hole in dynamo rear end plate. (See page 54.)

Lubricate distributor as detailed on page 55.

Oil door hinges, bonnet lock and operating mechanism.

Check dynamo belt tension and adjust if necessary. (See page 55.)

Check and adjust if necessary distributor contact points. (See page 56.)

Clean and adjust sparking plug gaps. (See page 56.)

MAINTENANCE SUMMARY

Change position of wheels. (See page 26.)

Check brakes and adjust if necessary.

Check automatic ignition control, lubrication drive shaft and cam.

Every 6,000 miles (10000 km.). Drain gearbox. Refill with fresh oil to Ref. A, page 64. (See page 57.)

Drain rear axle and refill with fresh oil to Ref. B, page 64. (See page 57.)

Remove front wheel disc, prise off hub grease cap, fill with grease to Ref. C, page 64, and replace. (See page 57.)

Renew external oil filter element. (See page 58.)

Check valve clearances and adjust if necessary. (See page 42.)

Check and tighten if necessary, door hinge and striker plate fixing screws.

Clean fuel filters in carburetters and pump. (See page 58.)

Check fluid level in front hydraulic dampers. (See page 59.)

Tighten rear road spring seat bolts.

Check wheel alignment.

Every 12,000 miles (20000 km.). Fit new sparking plugs.

Check fluid level in rear hydraulic dampers. (See page 60.)

Apply gun filled with Hypoid oil to Ref. B, page 64, to nipple on steering rack and give up to 15 shots of oil. Give five shots only to the nipple on the steering pinion housing. (See page 61.)

Remove engine sump and pick-up strainer, clean and reassemble, filling with fresh oil.

Drain, flush out and refill radiator.

Check steering and suspension moving parts for wear.

Regular servicing, as proven by presentation of completed voucher counterfoils, could well enhance the value of your vehicle in the eyes of a prospective purchaser.

USE OF THE OILCAN

The owner is advised to keep an oilcan filled with a light oil (Ref. F, page 64) to apply to the bonnet lock and prop mechanism and the door locks and hinges, etc., at frequent intervals. Attention to such details ensures trouble-free action and prevents undue wear. Make sure that all articulated joints receive attention.

500 MILES (800 Km.) FREE SERVICE

During the early life of the car, soon after it has completed 500 miles (800 km.), you are entitled to have it inspected free of charge by the M.G. Dealer from whom you purchased it, or, if this should not be convenient, by any other M.G. Dealer by arrangement. This attention given during the critical period in the life of the car makes all the difference to its subsequent life and performance.

This service includes :—

Drain oil from engine, gearbox and rear axle, and refill.

Oil and grease all points of the car.

Tighten cylinder head and manifold nuts to recommended pressures.

Check tightness of valve rocker-shaft brackets to recommended pressures.

Check valve clearances and reset if necessary.

Tighten fan belt if necessary.

Check all water connections and tighten clips if necessary.

Examine and clean carburetters and reset slow-running adjustment if necessary.

Examine and adjust, if necessary, sparking plugs and distributor points.

Check working of automatic ignition controls and, if necessary, reset ignition timing.

Check front wheel alignment and steering connections. Adjust if necessary.

Check tightness of universal joint nuts, wheel nuts, spring clips and wing (fender) bolts.

Check clutch pedal for free movement and adjust if necessary.

Check fluid level in master cylinder and top up if necessary.

Check braking system functionally and bleed lines if necessary.

Check electrical system functionally.

Examine batteries and top up to proper level with distilled water or diluted acid as may be required. Clean and tighten terminals.

Inspect hydraulic dampers for leaks.

Test tyres for correct pressure.

Check doors for ease in opening and closing. If necessary lightly smear with a suitable lubricating agent all dovetails and striking plates.

ALL MATERIALS CHARGEABLE TO THE CUSTOMER

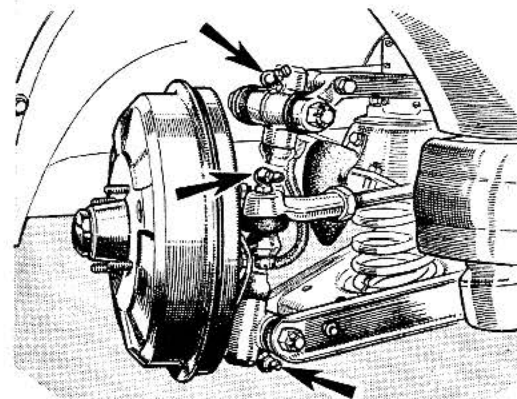

THE STEERING GEAR (D)

Grease nipples are provided at the top and bottom of each swivel pin and on the steering tie-rods. The grease gun should be filled with grease to ref. D (page 64) and applied to the nipples every 1,000 miles (1600 km.). Three or four strokes of the gun should be given.

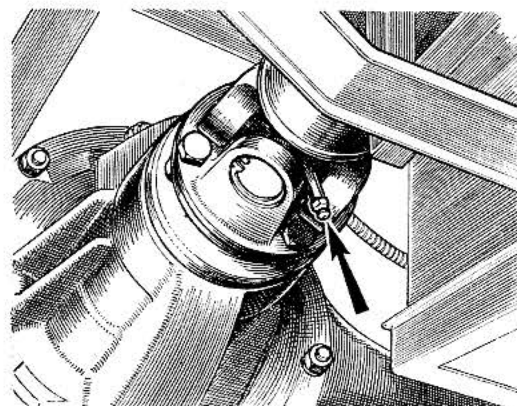

PROPELLER SHAFT (D)

The two needle-type universal joints should receive grease gun attention every 1,000 miles (1600 km.). The recommended lubricants are indicated under Ref. D on page 64.

The joints at the front and rear ends of the propeller shaft are each provided with a grease nipple and must be lubricated from the underside of the car.

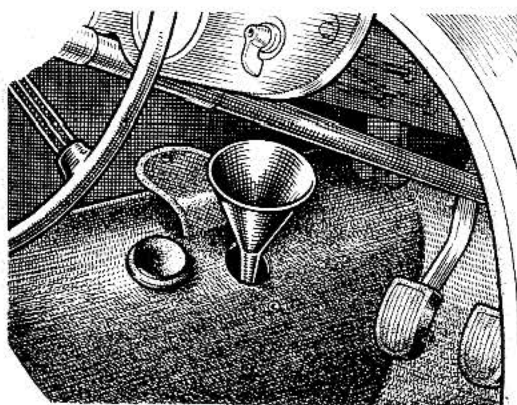

GEARBOX (A)

Replenishments should take place at intervals of 1,000 miles (1600 km.), care being taken to ensure that the gearbox is not filled above the "HIGH" mark on the dipstick. If the level is too high, oil may get into the clutch case and cause clutch slip. The combined filler plug and dipstick are located beneath the rubber plug on the gearbox cover.

Every 1,000 Miles (1600 Km.)

REAR AXLE (B)

The combined filler and level plug is reached from below the rear of the car and must be removed with the special key provided in the tool kit. The oil level should be checked at intervals of 1,000 miles (1600 km.), and replenished if necessary to the level of the filler plug hole.

Note.—It is essential that only **hypoid oil** be used in the rear axle. (See page 64.)

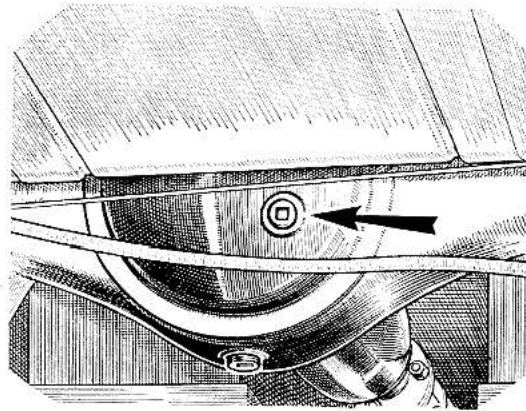

BRAKE FLUID

Every 1,000 miles (1600 km.) remove the combined hydraulic brake and clutch master cylinder cap and check the level of the fluid.

The master cylinder is mounted on the driver's side of the dash panel below the bonnet and the level should be $\frac{1}{4}$ in. (6.3 cm.) below the bottom of the filler neck and must never be above this.

Use only Lockheed Genuine Brake Fluid.

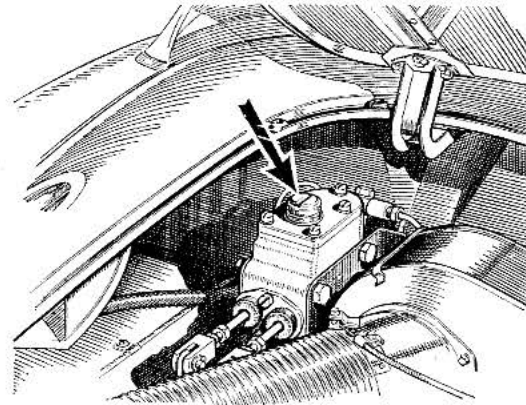

CARBURETTOR DAMPER (F)

Every 1,000 miles (1600 km.) unscrew the oil cap at the top of each suction chamber, pour in a small quantity of thin engine oil and replace the caps. **Under no circumstances should a heavy-bodied lubricant be used.**

Failure to lubricate the piston dampers will cause the pistons to flutter and reduce acceleration.

An oil indicated under Ref. F (on page 64) should be used.

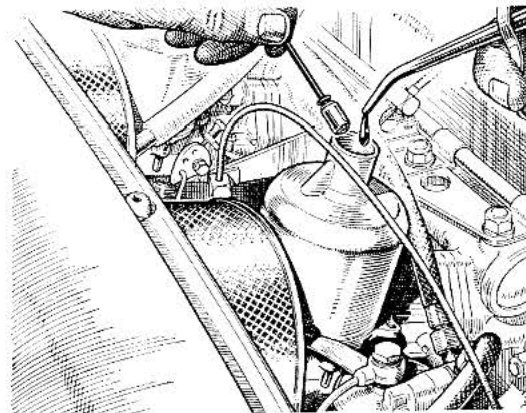

Every 1,000 Miles (1600 Km.)

TOPPING UP THE BATTERIES

Every 1,000 miles (1600 km.). Raise the hood, remove the spare wheel and hood stowage floor. The floor is secured by five quick-release screws. Remove the battery cell filler plugs and add sufficient **distilled water** to bring the surface of the electrolyte level **with the top of the separators**.

Do not use tap water.

Do not use a naked flame when examining the cells.

Do not overfill the cells.

Wipe away all dirt and moisture from the top of the batteries.

CHARGING THE BATTERIES

Never leave the batteries in a discharged condition for any length of time.

Have them fully charged, and every fortnight give them a short refreshing charge to prevent any tendency for the plates to become permanently sulphated.

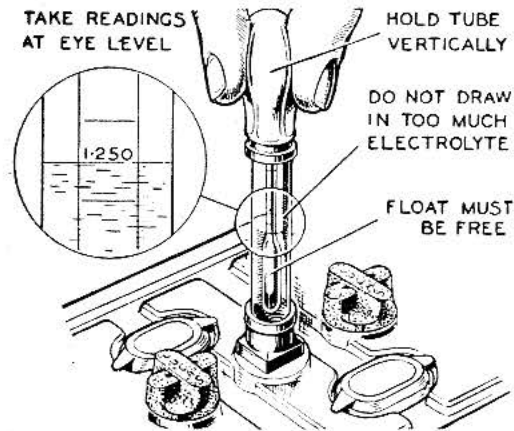

CHECKING SPECIFIC GRAVITY

Remove the filler plugs and take hydrometer readings of the specific gravity of the electrolyte in each of the cells. Readings should not be taken immediately after topping up the cells. The readings and their indications, assuming that the temperature of the solution is about 60° F. (16° C.), are as follows:—

1.280-1.300	Battery fully charged.
About 1.210	Battery about half-discharged.
Below 1.150	Battery fully discharged.

If one cell gives a reading very different from the rest, the battery should be examined by a Lucas Service Depot or Agent.

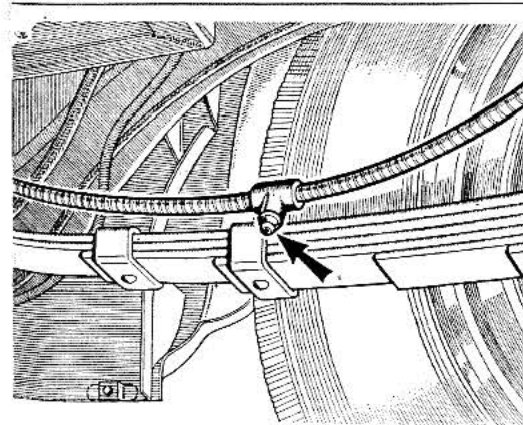

HAND BRAKE CABLES

The grease nipple on the hand brake cable should be given three or four strokes with a grease gun filled with grease to Ref. E (page 64) every 1,000 miles (1600 km.).

Every 3,000 Miles (5000 Km.)

DRAINING THE SUMP (A)

Drain the oil from the engine sump after 3,000 miles (5000 km.) and refill with new oil to Ref. A, page 64. The drain plug is on the right-hand side of the sump and should be removed after a journey, while the oil is still warm and will drain easily.

The sump capacity is 7 pints (4 litres, 8.5 U.S. pints) including the oil filter.

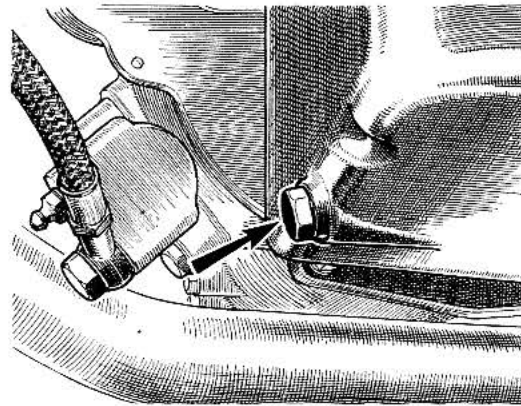

AIR CLEANER (A)

Every 3,000 miles (5000 km.) wash the filter element in petrol (gasoline) and allow to dry. Re-oil the element with S.A.E. 20 engine oil and allow to drain before reassembling.

When servicing, it is only necessary to withdraw the two hexagon-headed screws and lift off the outer cover to release the corrugated element. Re-assemble the front element with the corrugations clear of the breather spigot in the main filter case.

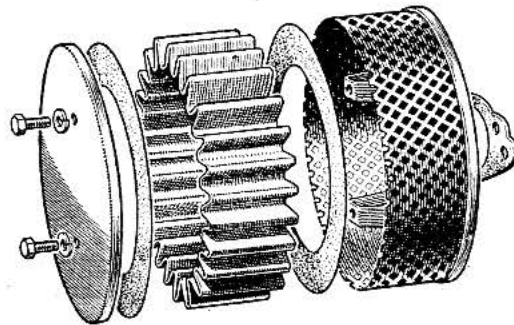

DYNAMO LUBRICATION

Every 3,000 miles (5000 km.) add two drops of engine oil to Ref. F (page 64) in the lubrication hole in the centre of the rear end bearing plate.

Do not over-oil.

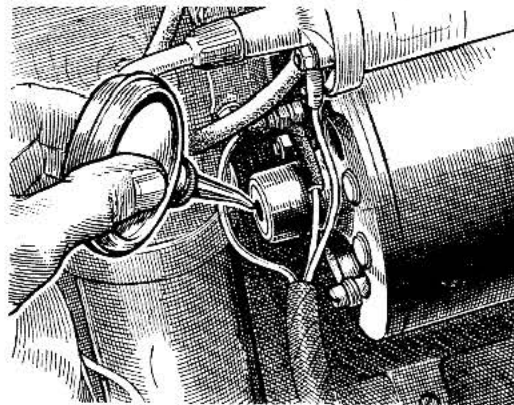

Every 3,000 Miles (5000 Km.)

DISTRIBUTOR CAM BEARING

Lift the rotor off the top of the spindle by pulling it squarely and add a few drops of thin engine oil to Ref. F (page 64) to the cam bearing. Do not remove the screw which is exposed.

There is a clearance between the screw and the inner face of the spindle for the oil to pass.

Replace the rotor with its drive lug correctly engaging the spindle slot and push it onto the shaft as far as it will go.

DISTRIBUTOR CAM

Lightly smear the cam with a very small amount of grease to Ref. D (page 64), or if this is not available, clean engine oil can be used.

AUTOMATIC TIMING CONTROL

Carefully add a few drops of thin engine oil to Ref. F (page 64), through the hole in the contact breaker base through which the cam passes. Do not allow oil to get on or near the contacts. Do not over-oil.

CONTACT BREAKER PIVOT

Add a spot of engine oil to Ref. F (page 64) to moving contact pivot pin.

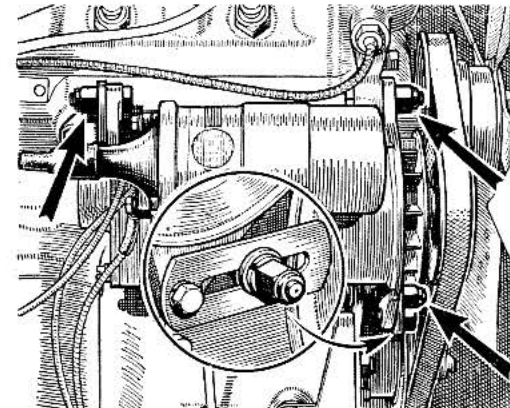
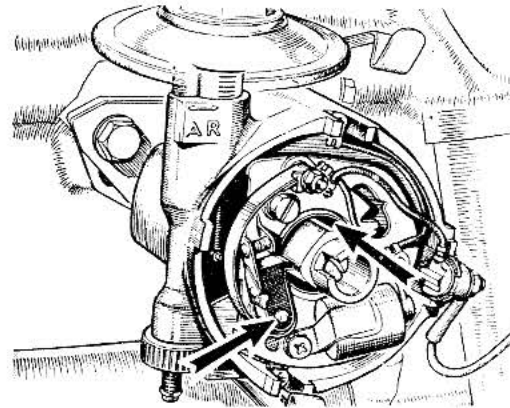
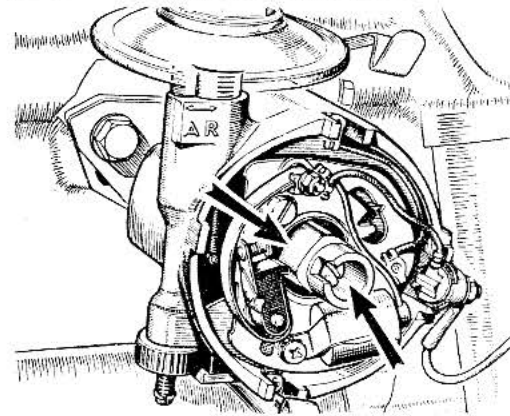

THE DYNAMO DRIVING BELT

Inspect the dynamo driving belt and adjust if necessary to take up any slackness. Care should be taken to avoid over-tightening the belt, otherwise undue strain will be thrown on the dynamo bearings.

The belt tension is adjusted by slackening the bolts of the dynamo cradle and moving the dynamo the required amount by hand. Tighten up the bolts thoroughly, particularly the one passing through the slotted adjusting link (inset).

Every 3,000 Miles (5000 Km.)

SPARKING PLUGS

The sparking plugs should be cleaned preferably by a garage with a special air blast service unit, and the gaps should be reset to $\cdot 019$ in. (48 mm.) every 3,000 miles (5000 km.).

Use the special Champion sparking plug gauge and setting tool and move the side wire on the plug, never the centre one.

Plugs which are oily, dirty or corroded cannot give good results. Fit a set of new plugs every 12,000 miles (20000 km.).

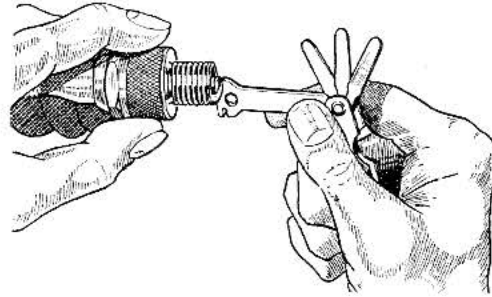

THE CONTACT BREAKER GAP

Every 3,000 miles (5000 km.) check the contact gap with the gauge on the small screwdriver in the tool kit. Turn the engine with the starting handle until the contacts are fully open and the gauge should then be a sliding fit. If the gap varies appreciably, slacken the contact plate screw, insert a screwdriver in the cut-out and move the plate until the gap is correct. Retighten the screw. The correct gap is $\cdot 014$ to $\cdot 016$ in. ($\cdot 36$ to $\cdot 41$ mm.) and the gauge is $\cdot 016$ in. thick.

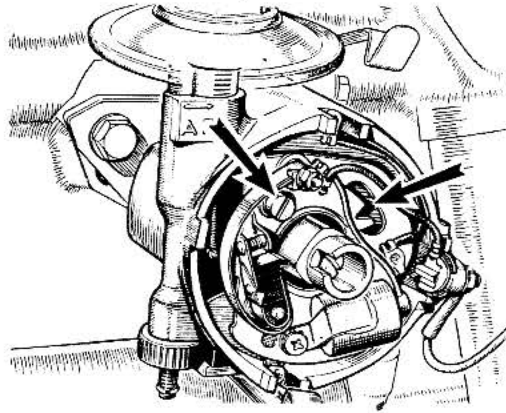

CLEANING THE CONTACTS

If the contacts appear pitted or blackened they should be removed and cleaned with a fine carborundum stone or fine emery cloth.

To release the contacts remove the nut, plain washer, and insulator from the retaining post and lift off the moving contact and the two insulating washers. Take out the two screws and remove the contact plate. Set the gap after replacing.

Wipe the inside and outside of the distributor cap to ensure that it is clean.

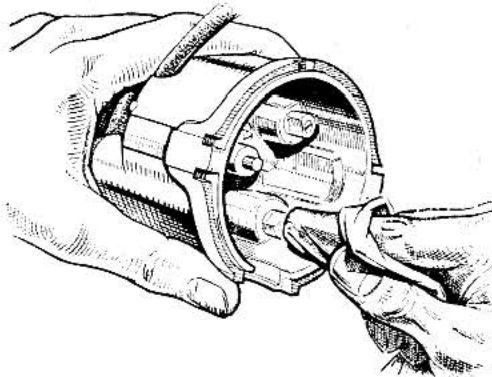

Every 6,000 Miles (10000 Km.)

DRAINING THE GEARBOX (A)

Drain the gearbox oil every 6,000 miles (10000 km.), using the special key in the tool kit to remove the drain plug.

When the gearbox has been drained completely, 4 imperial pints (2.2 litres, 4.8 U.S. pints) of oil are required to refill it. The oil should be poured in through the filler plug shown on page 51.

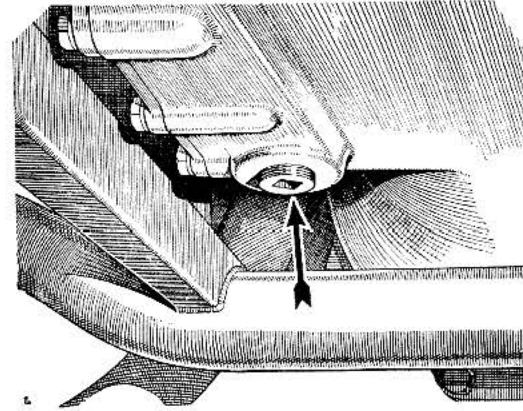

REAR AXLE (B)

Remove the drain plug with the special key in the tool kit and drain out the oil every 6,000 miles (10000 km.). Refill with **hypoid** oil to Ref. B (page 64) to the level of the filler plug hole.

Approximately $2\frac{3}{4}$ pints (1.56 litres, 3.5 U.S. pints) of oil are required to refill the axle.

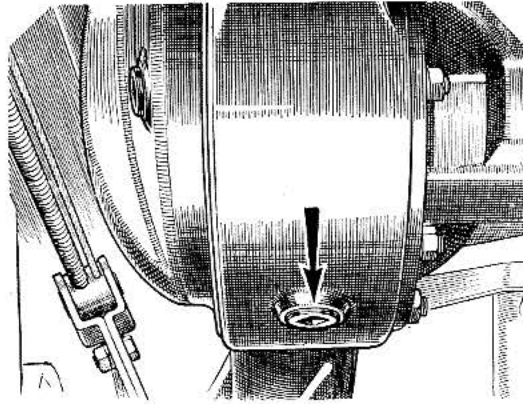

FRONT WHEEL HUBS (C)

Every 6,000 miles (10000 km.) the front wheel hub covers should be removed and the grease-retaining cap carefully prised off the end of each hub, refilled with grease to Ref. C (page 64) and replaced.

To lubricate the front hubs on cars fitted with wire wheels, the wheel retaining nuts must be unscrewed with the copper hammer in the tool kit (see page 23) and the hubs packed with grease to Ref. C.

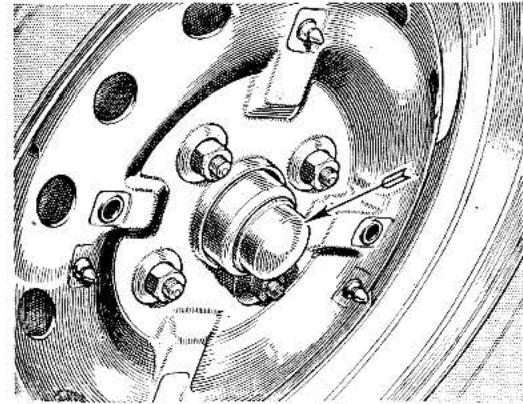

Every 6,000 Miles (10000 Km.)

THE OIL FILTER

The engine oil filter element must be renewed every 6,000 miles (10000 km.). The filter is released by undoing the central bolt securing the filter body to the filter head. When fitting the new element, make sure that the seating washer for the filter body is in good condition and that the body is correctly fitted.

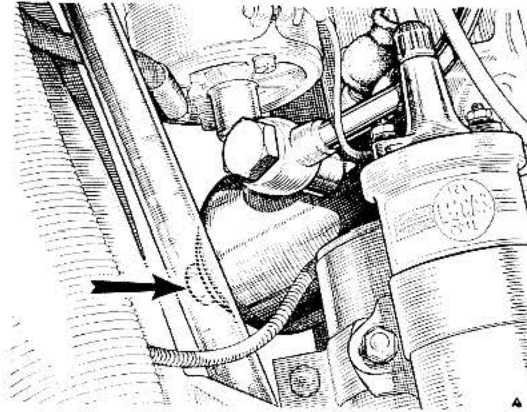

THE CARBURETTOR FILTERS

To ensure a free flow of fuel to the float-chambers the filters should be removed at intervals of about 6,000 miles (10000 km.) and thoroughly cleaned with a stiff brush and fuel. Never use rag. The filters are situated behind the banjo-type union at the junction of the fuel pipe to each float-chamber lid.

Replace the filters with their helical springs first and their open ends outwards. Replace the fibre washers correctly.

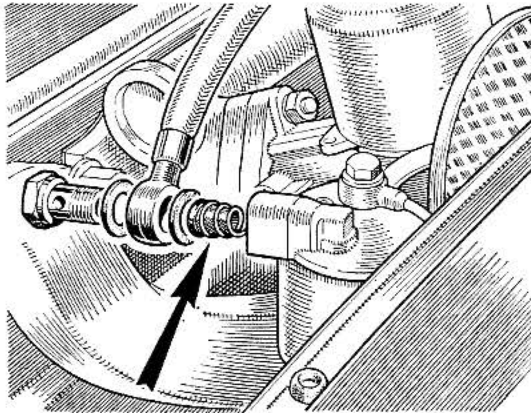

THE FUEL PUMP FILTER

Every 6,000 miles (10000 km.) clean off the fuel pump, withdraw the filter and clean it thoroughly in fuel. The filter is inserted into the bottom of the pump body and is released by unscrewing the hexagon plug.

When cleaning the filter do not use rag, always use a stiff brush and clean fuel.

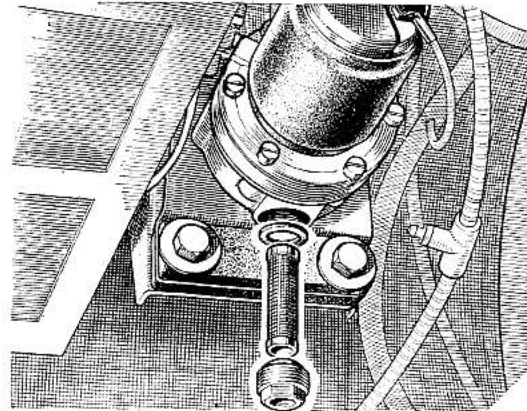

Every 6,000 Miles (10000 Km.)

FRONT DAMPERS

Every 6,000 miles (10000 km.) the front damper bodies and wing valance must be thoroughly cleaned, particularly round the filler plug on top of the damper body.

When clean, the filler plug may be removed and Armstrong piston-type fluid poured into the opening to make good any loss; fill to the level of the bottom of the filler plug hole. Rock the car before replacing the plug in order to expel trapped air.

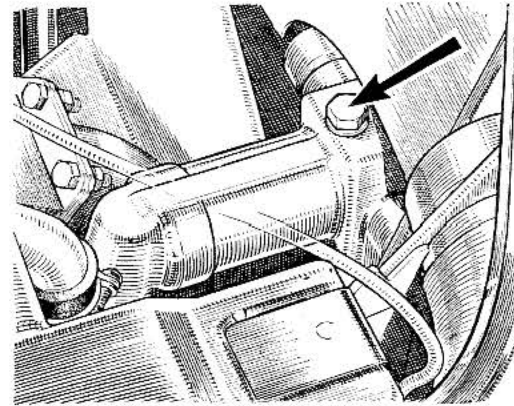

FRONT WHEEL ALIGNMENT

Excessive and uneven tyre wear is usually caused by faulty wheel alignment. The front wheels should be set parallel, and care should be taken that the measurements are taken at axle level and that the rims run true.

Since correct alignment is so important and entails the use of a special gauge, this work should be entrusted to an authorised M.G. Dealer.

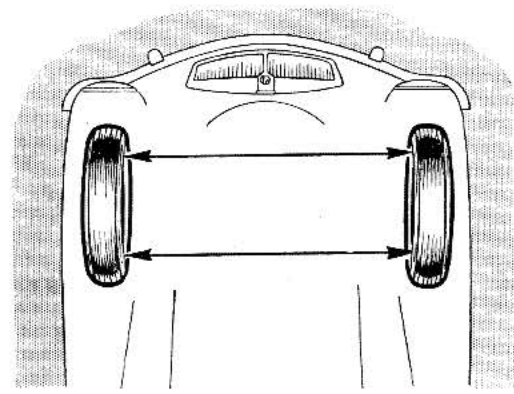

Every 12,000 Miles (20000 Km.)

REAR DAMPERS

It is not possible to top up the rear dampers in position and it is therefore necessary to remove them completely for cleaning and replenishing every 12,000 miles (20000 km.).

Clean the top of the damper and remove the filler plug. Add Armstrong piston-type hydraulic damper fluid until the level is just below the bottom of the filler hole. Work the arm up and down to expel trapped air before replacing the plug.

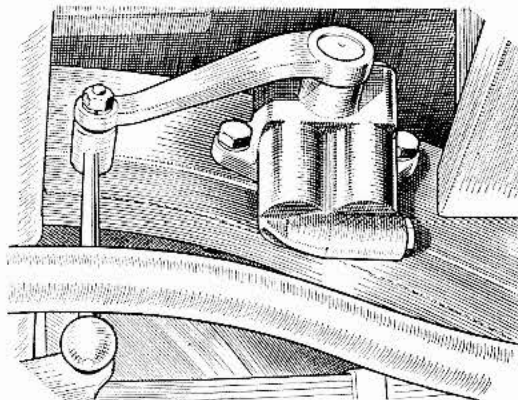

STEERING GEARBOX

The two oil nipples for the steering gearbox and pinion are reached from under the bonnet.

Give the gearbox nipple 15 strokes **only** every 12,000 miles (20000 km.) and give the pinion nipple five strokes **only** at the same time with a gun filled with oil to Ref. B, page 64.

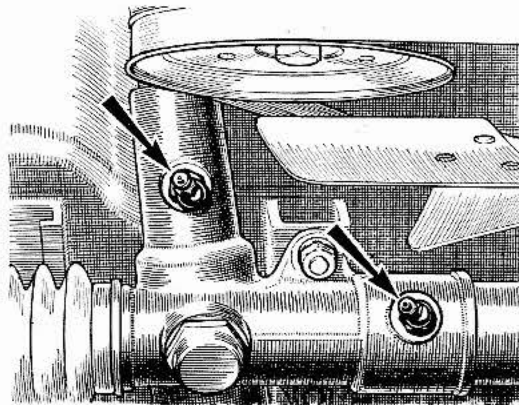

	<i>Page</i>		<i>Page</i>
A			
Accessories and equipment	46	Engine oil, checking	17
Adjusting the fuel mixture (jet) .. .	44	Engine oil, filling	17
Adjustment, distributor advance .. .	42	Equipment and accessories .. .	46
Adjustment, brake	43	External oil filter	58
Adjustment, seat	6	F	
Adjustment, slow-running	45	Filter, fuel pump	58
Adjustment, steering column .. .	6	Filter, oil	58
Adjustments, service	41	Filters, carburetter	58
Air cleaner	54	500 miles free service	50
Alignment, front wheel	59	Fog-lamp switch	9
B			
Balancing tyres	25	Free service, 500 miles	50
Battery charging	53	Front dampers	59
Battery, specific gravity	53	Front wheel alignment	59
Battery, topping up	53	Front wheel hubs	57
Bearing, distributor cam	55	Fuel gauge	10
Belt, dynamo driving	55	Fuel pump filter	58
Blades, windshield wiper	37	Fuel tank, filling	16
Bodywork, cleaning	30	Fuses	36
Bonnet lock release	7	G	
Bonnet safety catch	16	Gap, contact breaker	56
Brake adjustment	43	Gap, sparking plug	56
Brake fluid replenishment	52	Gauge, fuel	10
Brake, hand	6	Gauge, oil pressure	8
C			
Car and engine numbers	3	Gauge, water temperature	8
Carburetter damper	52	Gearbox drain plug	57
Carburetter filters	58	Gearbox oil filler and dipstick .. .	51
Carburetter mixture adjustment .. .	44, 45	Gearbox, steering	60
Carburetter slow-running adjustment	45	Gear lever	6
Choke control	10	General data	4
Cleaning the car	30	Good driving	18
Clearances, valve	42	H	
Clutch pedal	6	Hand brake	6
Cold weather precautions	31, 32	Hand brake cable	53
Contact breaker gap	56	Headlamp beam dip switch	7
Contacts, cleaning	56	Headlamp bulb, fitting	37
Controls	5	Headlamp light unit	37
Cooling system, draining	33	Headlamps, setting	38
D			
Dampers, front	59	Heater controls	12
Dampers, rear	60	Heater unit, draining	33
Data, general	4	Heating and demisting	12
Direction indicator switch	9	Hood, cleaning	30
Direction indicator warning lamp .. .	9	Hood, folding	29
Distributor advance adjustment .. .	42	Hood, releasing	28
Distributor, cleaning contacts .. .	56	Horn	9
Distributor, contact breaker gap .. .	56	Hubs, front wheel	57
Distributor cover	56	I	
Distributor lubrication	55	Ignition control	42
Drain plug, gearbox	57	Ignition switch	9
Drain plug, rear axle	57	Ignition warning light	8
Drain tap, engine	33	Instruments	5
Drain tap, radiator	33	J	
Draining heater unit	33	Jacking up car, front	22
Driving	18	Jacking up car, rear	22
Dynamo driving belt	55	Jack stowage	20
Dynamo lubrication	54	Jammed starter pinion	36
E			
Electrical equipment	35	L	
Engine and car numbers	3	Lamp, map-reading	11, 39
Engine drain tap	33	Lamp, number-plate	38
Engine lubrication	54	Lamp switch	9
		Lamps, fog switch	9
		Lamps, panel	9, 39
		Lamps, pilot	38

	<i>Page</i>		<i>Page</i>
Lamps, tail and stop	39	Spare wheel	22
Light unit, headlamp	37	Sparking plugs	56
Lock release, bonnet	7	Specific gravity, checking	53
Lubrication, air cleaner	54	Speedometer	8
Lubrication, carburetters	52	Starter pinion jammed	36
Lubrication chart	64	Starter switch	9
Lubrication, distributor	55	Starting handle	20
Lubrication, dynamo	54	Starting up	18
Lubrication, engine	54	Steering column adjustment .. .	6
Lubrication, front wheel hubs .. .	57	Steering gearbox	60
Lubrication, gearbox	51, 57	Steering gear, lubrication .. .	51
Lubrication, rear axle	52, 57	Steering tie- and track-rods .. .	51
Lubrication, steering gear	51	Switches	5
Lubrication, steering gearbox .. .	61	Switch, direction indicator .. .	9
Lubrication, steering tie- and track-		Switch, fog-lamp	9
rods	51	Switch, headlamp beam dip .. .	7
Lubrication, swivel pins	51	Switch, horn	9
Lubrication, propeller shaft	51	Switch, ignition	10
Lucas Service Depots	34	Switch, lamp	9
Luggage and tools	19	Switch, panel lamp	9
Luggage boot, opening	20	Switch, starter	9
		Switch, windshield wiper .. .	10
		Swivel pin lubrication	51
M			
Main beam warning light	7	T	
Maintenance procedure	48	Tail- and stop-lamps	39
Maintenance summary	48	Temperature gauge	8
Map-reading lamp	11, 39	Tool kit	20
Mixture, adjusting	44, 45	Tools and luggage	19
Mixture control	10	Top dead centre	42
O			
Oilcan, use of	49	Topping up the battery	53
Oil filler and dipstick, gearbox .. .	51	Track- and tie-rods, steering .. .	51
Oil filter, external	58	Tubes, repairing	24
Oil pressure gauge	8	Tyre care	26
Optional equipment	11	Tyre pressures, checking .. .	17
		Tyre removal	24
		Tyre replacement	24
		Tyre valves	25
		Tyres and wheels	21
		Tyres, balancing	25
P			
Paintwork damage	30	U	
Panel lamp bulbs	39	Upholstery, cleaning	30
Panel lamp switch	9	V	
Pedals	6	Valve caps	25
Pilot lamps	38	Valve clearances	42
Preparing for the road	15	Valve interiors	25
Propeller shaft universal joints .. .	51	Valves, tyre	25
R			
Radiator drain tap	33	W	
Radiator, filling	16	Warming up	18
Rear axle drain plug	57	Warning light, direction indicators	9
Rear axle filler and level plug .. .	52	Warning light, ignition	8
Rear brake adjustment	43	Warning light, main beam .. .	8
Rear dampers	60	Wheel alignment, front	59
Recommended lubricants	64	Wheel discs, removing	23
Repairing tubes	24	Wheel hubs, lubrication	57
Replacement bulbs	39	Wheel, spare	22
Revolution indicator	8	Wheels and tyres	21
Running in	18	Wheels, removing	23
S			
Safety catch, bonnet	16	Wheels, wire	26
Seat adjustment	6	Windshield washer	14
Service adjustments	41	Windshield wiper blades .. .	37
Setting headlamps	38	Windshield wiper switch .. .	10
Sidescreens	27, 28	Wiring diagram	40
Slow-running adjustment	45		

KEY TO RECOMMENDED LUBRICANTS

Component	A			Gearbox	B		C	D	E	F
	Engine and Air Cleaner				Steering Box and Rear Axle (Hypoid Gears)					
Climatic Conditions	Tropical and temperate down to 32° F. (0° C.)	Cold and extreme cold down to 0° F. (-18° C.)	Arctic below 0° F. (-18° C.)	All temperatures	Tropical and temperate down to 10° F. (-12° C.)	Extreme cold below 10° F. (-12° C.)	All conditions	All conditions	All conditions	All conditions
"CASTROL"	"Castrol" X.L.	"Castrolite"	"Castrol" Z	"Castrol" X.L.	"Castrol" Hypoy	"Castrol" Hypoy 80	"Castrolite" L.M.	"Castrolite" L.M.	"Castrolite" L.M.	"Castrolite"
"ESSO"	"Esso" Extra Motor Oil 20 W/30	"Esso" Extra Motor Oil 20 W/30	"Essolube" 10	"Essolube" 30	"Esso" Expee Compound 90	"Esso" Expee Compound 80	"Esso" Multipurpose Grease H	"Esso" Multipurpose Grease H	"Esso" Multipurpose Grease H	"Esso" Extra Motor Oil 20 W/30
"MOBIL"	Mobiloil "A"	Mobiloil "Arctic"	Mobiloil 10 W	Mobiloil "A"	Mobilube "G.X." 90	Mobilube "G.X." 80	Mobilgrease M.P.	Mobilgrease M.P.	Mobilgrease M.P.	Mobiloil "Arctic"
B.P. "ENERGOL"	"Energol" S.A.E. 30	"Energol" S.A.E. 20 W	"Energol" S.A.E. 10 W	"Energol" S.A.E. 30	"Energol" E.P. S.A.E. 90	"Energol" E.P. S.A.E. 80	"Energrelase" L.3	"Energrelase" L.3	"Energrelase" L.3	"Energol" S.A.E. 20W
"SHELL"	"Shell" X-100 30	"Shell" X-100 20/20 W	"Shell" X-100 10W	"Shell" X-100 30	"Shell" Spirax 90 E.P.	"Shell" Spirax 80 E.P.	"Shell" Retinax A	"Shell" Retinax A	"Shell" Retinax A	"Shell" X-100 20/20 W
"FILTRATE"	Medium "Filtrate" 30	Zero "Filtrate" 20	Sub-Zero "Filtrate" 10	Medium "Filtrate" 30	Hypoid "Filtrate" Gear 90	Hypoid "Filtrate" Gear 80	Super Lithium "Filtrate" Grease	Super Lithium "Filtrate" Grease	Super Lithium "Filtrate" Grease	Zero "Filtrate" 20
"STERNOL"	"Sternol" W.W. 30	"Sternol" W.W. 20	"Sternol" W.W. 10	"Sternol" W.W. 30	Ambroleum E.P. 90	Ambroleum E.P. 80	"Ambroline" L.H.T. Grease	"Ambroline" L.H.T. Grease	"Ambroline" L.H.T. Grease	"Sternol" W.W. 20
"DUCKHAM'S"	Duckham's N.O.L. "Thirty"	Duckham's N.O.L. "Twenty"	Duckham's N.O.L. "Ten"	Duckham's N.O.L. "Thirty"	Duckham's Hypoid 90	Duckham's Hypoid 80	Duckham's L.B. 10 Grease	Duckham's L.B. 10 Grease	Duckham's L.B. 10 Grease	Duckham's N.O.L. "Twenty"

