

## **Antorchas de soldadura WIG/TIG** *TIG Welding torches*

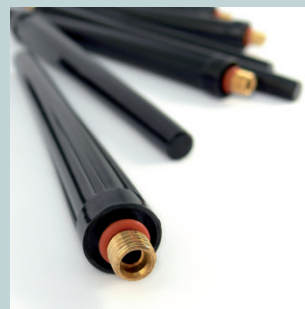



## Información para pedidos WIG/TIG / Ordering information

Refrigeradas por gas / Gas cooled	4 ... 5
Refrigeradas por agua / Water cooled	6 ... 8
Modelos con interruptor de láminas / Models with blade switch	9

## Piezas de repuesto y consumibles / Spare parts and consumables

TBi SR 9, TBi SR 20, TBi SR 21	10 ... 11
TBi SR 17, TBi SR 18, TBi SR 26	12 ... 13
Modelos MultiLock / Models MultiLock	14
TBi XCT 200W, TBi XCT 400W	15
TBi SR 24G, TBi SR 24W	16
TBi SR 25G FX, TBi SR 25W FX	17
TBi AW 424, TBi AW 427	18
TBi SR 400	19
TBi SR 12	21

## Empuñaduras y módulos / Handles and modules

Empuñadura de precisión / Precision Handle	20
Empuñaduras en tubo y conmutadores / Handle tubes and switches	22
Empuñaduras en tubo para antorchas con válvula / Handle tubes for torch bodies with valve	23
Modelos con interruptor de láminas / Models with blade switch	24 ... 25

## Antorchas automáticas / Machine Torches

Antorchas automáticas / Machine Torches	26
-----------------------------------------	----

## Kits de consumibles / Consumables kit

Kits de consumibles / Consumables kit	27
---------------------------------------	----

## Accesorios / Accessories

Aportador de hilo frío / TIG-Cold-Wire-Feeding	28
La herramienta de montaje TBi WIG/TIG / TIG assembly fixture	27
Electrodos de tungstenos TBi / TBi Tungsten Electrodes	27

## Refrigeradas por gas / Gas cooled



TBi SR 9 (FX)    TBi SR 17 (FX)    TBi TM 125    TBi SR 26 (FX)    TBi SR 26 HD (FX)

Conexión / Connection	Standard	Standard, FX	415P09	413P09	415P17	413P17	TBi TM 125	415P26	413P26	TBi SR 26 HD (FX)
M12x1	Standard		0	0	0	0	*	0	-	-
	Standard, FX		0	0	0	0	-	0	-	-
G 1/4"	Standard		2	2	2	2	*	2	-	-
	Standard, FX		2	2	2	2	-	2	-	-
G 3/8"	Standard		3	3	3	3	*	3	-	-
	Standard, FX		3	3	3	3	-	3	-	-
TSB 10/25 (Ø 9 mm)	Standard		3B	3B	3B	3B	*	3B	-	-
	Standard, FX		3B	3B	3B	3B	-	3B	-	-
TSB 35/50 (Ø 13 mm)	Standard		3C	3C	3C	3C	*	3C	415P28 3C	413P28 3C
	Standard, FX		3C	3C	3C	3C	-	3C	-	-
TSB 10/25 Mono (Ø 9 mm)	Standard		B	B	B	B	402P5MCLC *	*	-	-
	Standard, FX		B	B	B	B	-	*	-	-
TSB 35/50 Mono (Ø 13 mm)	Standard		C	C	C	C	*	C	-	-
	Standard, FX		C	C	C	C	-	C	-	-
Euro-W5G	Standard		Y	Y	Y	Y	*	Y	-	-
	Standard, FX		Y	Y	Y	Y	-	Y	-	-
Euro-GZ	Standard		9	9	9	9	*	8	-	-
	Standard, FX		9	9	9	9	-	8	-	-

Todas las conexiones comunes de maquinaria disponibles en stock. Más información a petición. /

Torch connections for all types of power sources are on stock. More information on request.

### Nota / Note

¡El cabezal TIG se debe pedir por separado! / TIG-head is to be ordered separately!



Por favor, indique el módulo de interruptor deseado / Please indicate the required switch module

C



**Pulsador doble**  
Double function switch

P

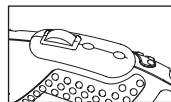

**Pulsador doble con potenciómetro, 10 kΩ**  
Double function switch with poti, 10 kΩ

D

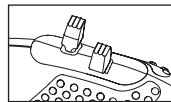

**Doble palanca /**  
Dual levers



TBi SR 24G	TBi SR 25G FX	TBi SR 9 V (FX)	TBi SR 17 V (FX)	TBi SR 26 V (FX)	TBi SR 26 HDV(FX)	TBi SR 9 P (Aut)	TBi SR 26 P (Aut)	TBi Aut 22G
415P23 0 -	- 413P25 0	405P09V 0 403P09V 0	405P17V 0 403P17V 0	405P26V 0 403P26V 0	-	491P09700 -	491P26700 -	491P23700 -
415P23 2 -	- 413P25 2	405P09V 2 403P09V 2	405P17V 2 403P17V 2	405P26V 2 403P26V 2	-	491P09702 -	491P26702 -	491P23702 -
415P23 3 -	- 413P25 3	405P09V 3 403P09V 3	405P17V 3 403P17V 3	405P26V 3 403P26V 3	-	491P09703 -	491P26703 -	491P23703 -
415P23 3B -	- 413P25 3B	405P09V3B 403P09V3B	405P17V3B 403P17V3B	405P26V3B 403P26V3B	-	491P0970B -	-	-
415P23 3C -	- 413P25 3C	405P09V3C 403P09V3C	405P17V3C 403P17V3C	405P26V3C 403P26V3C	405P28V3C 403P28V3C	491P0970C -	491P2673C -	-
* -	- *	* *	* *	* *	-	* -	* -	491P2371B -
* -	- *	* *	* *	* *	-	* -	* -	491P2371C -
415P23 Y -	- 413P25 Y	* *	* *	* *	-	* -	* -	* -
415P23 9 -	- 413P25 9	* *	* *	* *	-	491P09709 -	491P26708 -	* -

Por favor, indique el tipo de paquete de mangueras deseado /  
Please indicate the required cable type

**1** Manguera con revestimiento de goma (estándar) /  
Rubber outer cover (standard)

**L** Manguera con revestimiento de cuero frontal  
(Aprox. 0,6 m), resto en goma /  
Leather cover in the front (0.6 m), rubber cover

**T** Manguera con revestimiento textil /  
Textile outer cover

Por favor, indique la longitud del paquete  
de mangueras deseado /  
Please indicate the required cable length

**4** 4 m / 12 ft

**8** 8 m / 25 ft

\* Número de artículo a petición /  
\* Part-No. on request

Refrigeradas por agua /  
Water cooled



			TBi SR 18 (FX)	TBi SR 20 (FX)	TBi SR 21 (FX)	TBi TM 250	TBi SR 24W (FX)
	<b>M12x1</b>	Standard	415P18 0	415P20 0	415P21 0	*	415P24 0
		Standard, FX	413P18 0	413P20 0	413P21 0	-	413P24 0
	<b>G 1/4"</b>	Standard	415P18 2	415P20 2	415P21 2	*	415P24 2
		Standard, FX	413P18 2	413P20 2	413P21 2	-	413P24 2
	<b>G 3/8"</b>	Standard	415P18 3	415P20 3	415P21 3	*	415P24 3
		Standard, FX	413P18 3	413P20 3	413P21 3	-	413P24 3
	<b>TSB 35/50</b> (Ø 13 mm)	Standard	415P18 C	415P20 C	415P21 C	402P6MCLC	415P24 C
		Standard, FX	413P18 C	413P20 C	413P21 C	-	413P24 C
	<b>Euro-W5W</b>	Standard	415P18 Y	415P20 Y	415P21 Y	*	415P24 Y
		Standard, FX	413P18 Y	413P20 Y	413P21 Y	-	413P24 Y
	<b>Euro-WZ-0</b>	Standard	415P18 5	415P20 5	415P21 5	*	415P24 5
		Standard, FX	413P18 5	413P20 5	413P21 5	-	413P24 5

Todas las conexiones comunes de maquinaria disponibles en stock. Más información a petición. /

Torch connections for all types of power sources are on stock. More information on request.

**Nota / Note**

¡El cabezal TIG se debe pedir por separado! /  
TIG-head is to be ordered separately!



Por favor, indique el módulo de interruptor deseado /  
Please indicate the required switch module

<b>C</b>		<b>Pulsador doble</b> Double function switch
<b>P</b>		<b>Pulsador doble con potenciómetro, 10 kΩ /</b> Double function switch with poti, 10 kΩ
<b>D</b>		<b>Doble palanca /</b> Dual levers



TBi SR 25W FX	TBi AW 424	TBi AW 427	TBi SR 400	TBi XCT 200W	TBi XCT 400W	TBi SR 12	TBi SR 18 V (FX)	TBi SR 20 V (FX)
- 401P25 0	414P24 0 -	404P27 0 -	415P40 0 -	415PX2 0 -	415PX4 0 -	405P12R 0 -	405P18V 0 403P18V 0	405P20V 0 403P20V 0
- 401P25 2	414P24 2 -	404P27 2 -	415P40 2 -	415PX2 2 -	415PX4 2 -	405P12R12 -	405P18V 2 403P18V 2	405P20V 2 403P20V 2
- 401P25 3	414P24 3 -	404P27 3 -	415P40 3 -	415PX2 3 -	415PX4 3 -	405P12R13 -	405P18V 3 403P18V 3	405P20V 3 403P20V 3
- 401P25 C	414P24 C -	404P27 C -	415P40 C -	415PX2 C -	415PX4 C -	405P12R1C -	405P18V C 403P18V C	405P20V C 403P20V C
- 401P25 Y	414P24 Y -	404P27 Y -	415P40 Y -	415PX2 Y -	415PX4 Y -	405P12R1Y -	405P18V Y 403P18V Y	405P20V Y 403P20V Y
- 401P25 5	414P24 5 -	404P27 5 -	415P40 5 -	415PX2 5 -	415PX4 5 -	405P12R15 -	405P18V 5 403P18V 5	405P20V 5 403P20V 5

Por favor, indique el tipo de paquete de mangueras deseado /  
Please indicate the required cable type

**1** Manguera con revestimiento de goma (estándar) /  
Rubber outer cover (standard)

**L** Manguera con revestimiento de cuero frontal  
(Aprox. 0,6 m), resto en goma /  
Leather cover in the front (0.6 m), rubber cover

**T** Manguera con revestimiento textil /  
Textile outer cover

Por favor, indique la longitud del paquete  
de mangueras deseado /  
Please indicate the required cable length

**4** 4 m / 12 ft

**8** 8 m / 25 ft

\* Número de artículo a petición /  
\* Part-No. on request

Refrigeradas por agua /  
Water cooled



			TBi SR 18 P (Aut)	TBi SR 20 P (Aut)	TBi Aut 22W
	<b>M12x1</b>	Standard	491P18700	491P20700	491P22700
	<b>G 1/4"</b>	Standard	491P18702	491P20702	491P22702
	<b>G 3/8"</b>	Standard	491P18703	491P20703	491P22703
	<b>TSB 35/50</b> (Ø 13 mm)	Standard	491P1870C	491P2070C	491P2270C
	<b>Euro-W5W</b>	Standard	491P1870Y	491P2070Y	491P2270Y
	<b>Euro-WZ-0</b>	Standard	491P18705	491P20705	491P22705

Todas las conexiones comunes de maquinaria disponibles en stock. Más información a petición. /  
Torch connections for all types of power sources are on stock. More information on request.

Por favor, indique la longitud del paquete de mangueras deseado /  
Please indicate the required cable length

<b>4</b>	4 m / 12 ft
<b>8</b>	8 m / 25 ft



## Modelos con interruptor de lámina / Models with blade switch

### Refrigeradas por gas / Gas cooled



			TBi SR 9 (FX)	TBi SR 17 (FX)	TBi SR 26 (FX)	TBi SR 24G
	<b>TSB 35/50</b> (Ø 13 mm)	Standard Standard, FX	405P917 1 403P917 1	405P917 2 403P917 2	405P917 5 403P917 5	405P917 7 -
	<b>TSB 35/50 Mono</b> (Ø 13 mm)	Standard Standard, FX	405P91761 403P91761	405P91762 403P91762	405P91765 403P91765	405P91767 -

### Refrigeradas por agua / Water cooled



			TBi SR 18 (FX)	TBi SR 20 (FX)	TBi SR 21 (FX)	TBi SR 400	TBi SR 24W (FX)
	<b>TSB 35/50</b> (Ø 13 mm)	Standard Standard, FX	405P917 3 403P917 3	405P917 4 403P917 4	405P917 9 -	405P917 8 -	405P917 6 403P917 6

Por favor, indique el tipo de paquete de mangueras deseado / Please indicate the required cable type

- 5** Manguera con revestimiento de goma (estándar) / Rubber outer cover (standard)
- L** Manguera con revestimiento de cuero frontal (Aprox. 0,6 m), resto en goma / Leather cover in the front (approx. 0.6 m), rubber
- T** Manguera con revestimiento textil / Textile outer cover

Por favor, indique la longitud del paquete de mangueras deseado / Please indicate the required cable length

- 4** 4 m / 12 ft
- 8** 8 m / 25 ft

Otros modelos disponibles a petición / Other models available on request

TBi SR 25G,  
TBi SR 25W

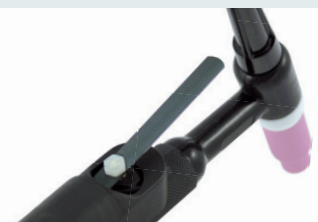

#### Aviso / Note

Por favor, tenga en cuenta que, para los modelos TBi SR 18, TBi SR 26 y TBi SR 400, el cuerpo de la antorcha es distinto al cuerpo de la versión con empuñadura Precisión /

Please note that the torch body for models TBi SR 18, TBi SR 26 and TBi SR 400 is different from the torch body for the Precision handle

# TBi SR 9 , TBi SR 20 , TBi SR 21



TBi SR 9 (FX)

**TBi SR 9 (FX)**  
refrigerada por gas /  
gas cooled  
60% (10 min.)  
AC: 80 A  
DC: 110 A  
Ø 0.5-1.6 mm



TBi SR 20 (FX)

**TBi SR 20 (FX)**  
refrigerada por agua /  
water cooled  
100% (10 min.)  
AC: 160 A  
DC: 220 A  
Ø 0.5-3.2 mm



TBi SR 21

**TBi SR 21 (FX)**  
refrigerada por agua /  
water cooled  
100% (10 min.)  
AC: 240 A  
DC: 340 A  
Ø 0.5-3.2 mm

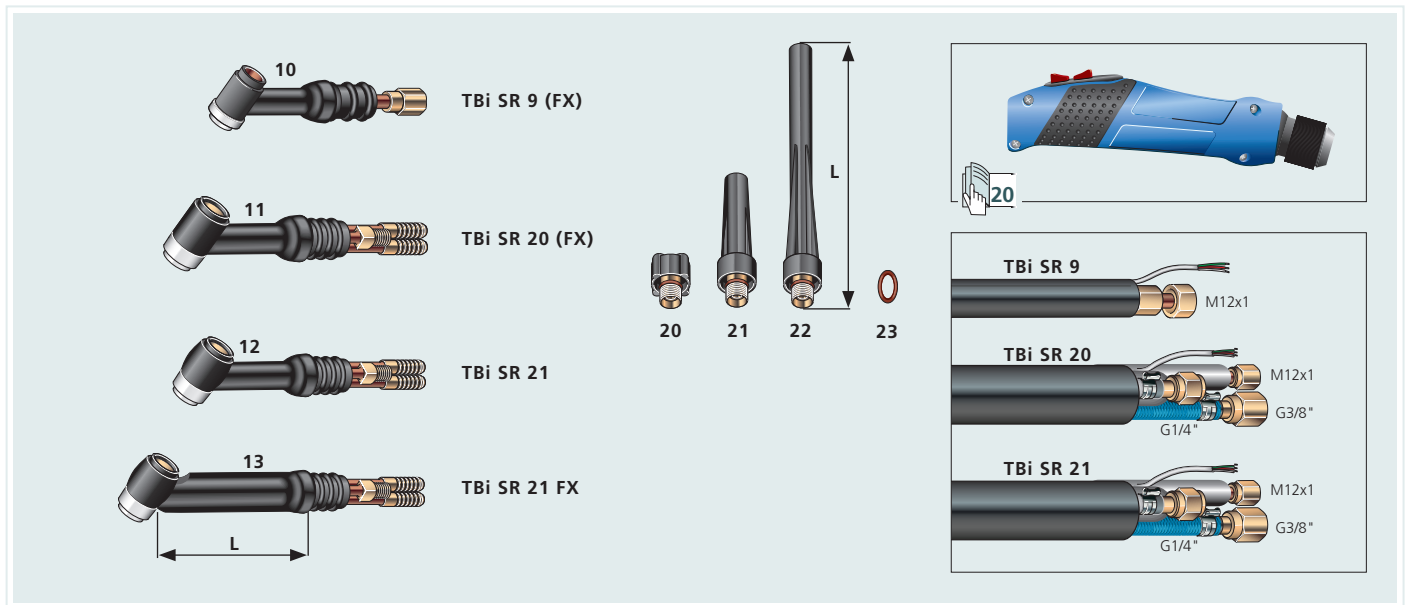

## Recambios / Spare parts

10	Cuello / Torch body	SR 9		L = 35 mm	405P090800
10	Cuello / Torch body	SR 9 FX (Estándar)	flexible / flexible	L = 35 mm	403P090800
10	Cuello / Torch body	SR 9 FX-L	flexible / flexible	L = 115 mm	403P090805
11	Cuello / Torch body	SR 20		L = 35 mm	405P200800
11	Cuello / Torch body	SR 20 FX (Estándar)	flexible / flexible	L = 35 mm	403P200700
11	Cuello / Torch body	SR 20 FX-L	flexible / flexible	L = 70 mm	403P200850
11	Cuello / Torch body	SR 20 FX-LL	flexible / flexible	L = 90 mm	403P200750
11	Cuello / Torch body	SR 20 FX-XL	flexible / flexible	L = 115 mm	403P200800
12	Cuello / Torch body	SR 21		L = 35 mm	405P210800
12	Cuello / Torch body	SR 21 FX (Estándar)	flexible / flexible	L = 65 mm	403P210700
12	Cuello / Torch body	SR 21 FX-L	flexible / flexible	L = 115 mm	403P210701
20	Tapón / Back cap	corta / short		L = 18 mm	41V33 401P200100
21	Tapón / Back cap	media / medium		L = 48 mm	41V35 401P200200
22	Tapón / Back cap	larga / long		L = 145 mm	41V24 401P200300
23	Junta torica / O-Ring				98W77 365P200046

## Consumibles / Consumables

▶	A	Aislante / Insulator	Estándar	598882	402P200900
	B	Adaptador / Adapter	Difusor de gas Jumbo / Jumbo Gas lens	54N63-20	401P200905

▶ = Estándar

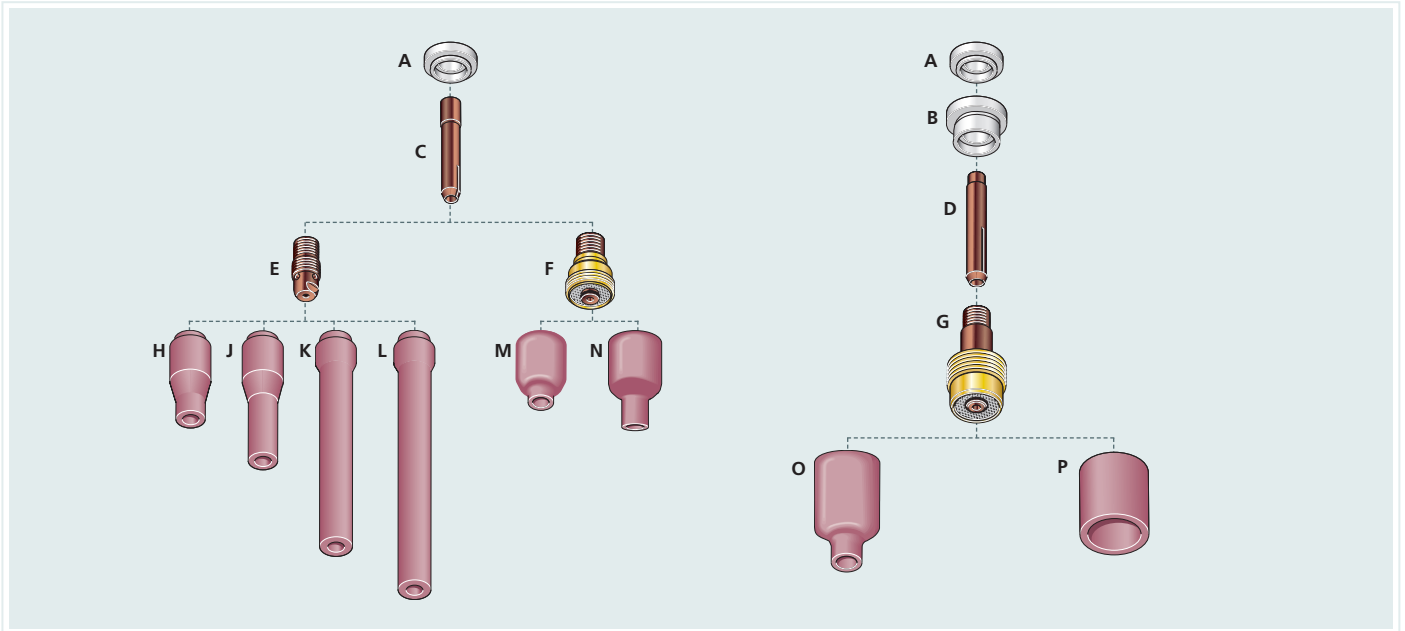

	Ø 0.5 mm Ø 0.020"	Ø 1.0 mm Ø 0.040"	Ø 1.6 mm Ø 1/16"	Ø 2.0 mm	Ø 2.4 mm Ø 3/32"	Ø 3.0 mm	Ø 3.2 mm Ø 1/8"
--	----------------------	----------------------	---------------------	----------	---------------------	----------	--------------------

**Porta tungstenos / Collets**

▶ C	Estándar, L=25.4 mm	13N20 401P200599	13N21 401P200600	13N22 401P200601	- 401P200604	13N23 401P200602	- 401P200605	13N24 401P200603
D	Jumbo, L=40.1 mm	-	13N21L 401P13N21L	13N22L 401P13N22L	-	13N23L 401P13N23L	-	13N24L 401P13N24L

**Porta toberas / Collet bodies**

▶ E	L=20.6 mm	Ø 0.5 - 1.6 mm 13N27 401P201001		Ø 2.0 - 2.4 mm 13N28 401P201002		Ø 3.0 - 3.2 mm 13N29 401P201003	
-----	-----------	---------------------------------------	--	---------------------------------------	--	---------------------------------------	--

**Difusor de gas / Gas lenses**

F	Estándar, L=21.5 mm	-	45V42 401P201300	45V43 401P201301	Ø 2.0 - 2.4 mm 45V44 401P201302		Ø 3.0 - 3.2 mm 45V45 401P201303	
G	Jumbo, L=40.5 mm	-	45V0204S 401P201350	45V116S 401P201351	Ø 2.0 - 2.4 mm 45V64S 401P201352		Ø 3.0 - 3.2 mm 995795S 401P201353	

	No. 3 Ø 5.0 mm Ø 3/16"	No. 4 Ø 6.5 mm Ø 1/4"	No. 5 Ø 8.0 mm Ø 5/16"	No. 6 Ø 9.5 mm Ø 3/8"	No. 7 Ø 11 mm Ø 7/16"	No. 8 Ø 12.5 mm Ø 1/2"	No. 10 Ø 16 mm Ø 5/8"
--	------------------------------	-----------------------------	------------------------------	-----------------------------	-----------------------------	------------------------------	-----------------------------

**Toberas cerámicas / Ceramic nozzles**

▶ H	Estándar, L=30.0 mm	-	13N08 401P201106	13N09 401P201107	13N10 401P201108	13N11 401P201109	13N12 401P201110	13N13 401P201111
J	Estándar, L, L=48.0 mm	796F70 401P201115	796F71 401P201116	796F72 401P201117	796F73 401P201118	-	-	-
K	Estándar, XL, L=63.0 mm	-	796F75 401P201126	796F76 401P201127	796F77 401P201128	-	-	-
L	Estándar, XXL, L=89.0 mm	-	796F79 401P201136	-	-	-	-	-

	No. 4 Ø 6.5 mm Ø 1/4"	No. 5 Ø 8.0 mm Ø 5/16"	No. 6 Ø 9.5 mm Ø 3/8"	No. 7 Ø 11 mm Ø 7/16"	No. 8 Ø 12.5 mm Ø 1/2"	No. 10 Ø 16 mm Ø 5/8"	No. 12 Ø 19 mm Ø 3/4"	Ø 24 mm
--	-----------------------------	------------------------------	-----------------------------	-----------------------------	------------------------------	-----------------------------	-----------------------------	---------

**Toberas cerámicas / Ceramic nozzles**

M	Difusor de gas, L=25.5 mm	53N58 401P201400	53N59 401P201401	53N60 401P201402	53N61 401P201403	53N61S 401P201404	- 401P201409	-
N	Difusor de gas, L, L=35.0 mm	53N58L 401P201408	53N59L 401P201405	53N60L 401P201406	53N61L 401P201407	-	401P201410	-
O	Difusor de gas, Jumbo L=48.0 mm	-	-	57N75 401P201451	-	57N74 401P201452	53N88 401P222250	53N87 401P222251
P	Difusor de gas, Jumbo L=34.0 mm	-	-	-	-	-	-	53N89 401P222252

▶ = Estándar

# TBi SR 17 , TBi SR 18 , TBi SR 26



**TBi SR 17 (FX)**  
refrigerada por gas /  
gas cooled  
60% (10 min.)  
AC: 100 A  
DC: 140 A  
Ø 0.5-2.4 mm



**TBi SR 18 (FX)**  
refrigerada  
por agua /  
water cooled  
100% (10 min.)  
AC: 225 A  
DC: 320 A  
Ø 0.5-4.0 mm



**TBi SR 26 (FX)**  
refrigerada por gas /  
gas cooled  
60% (10 min.)  
AC: 140 A  
DC: 200 A  
Ø 0.5-4.0 mm



**TBi SR 26 HD (FX)**  
refrigerada  
por gas /  
gas cooled  
60% (10 min.)  
AC: 160 A  
DC: 230 A  
Ø 0.5-4.0 mm

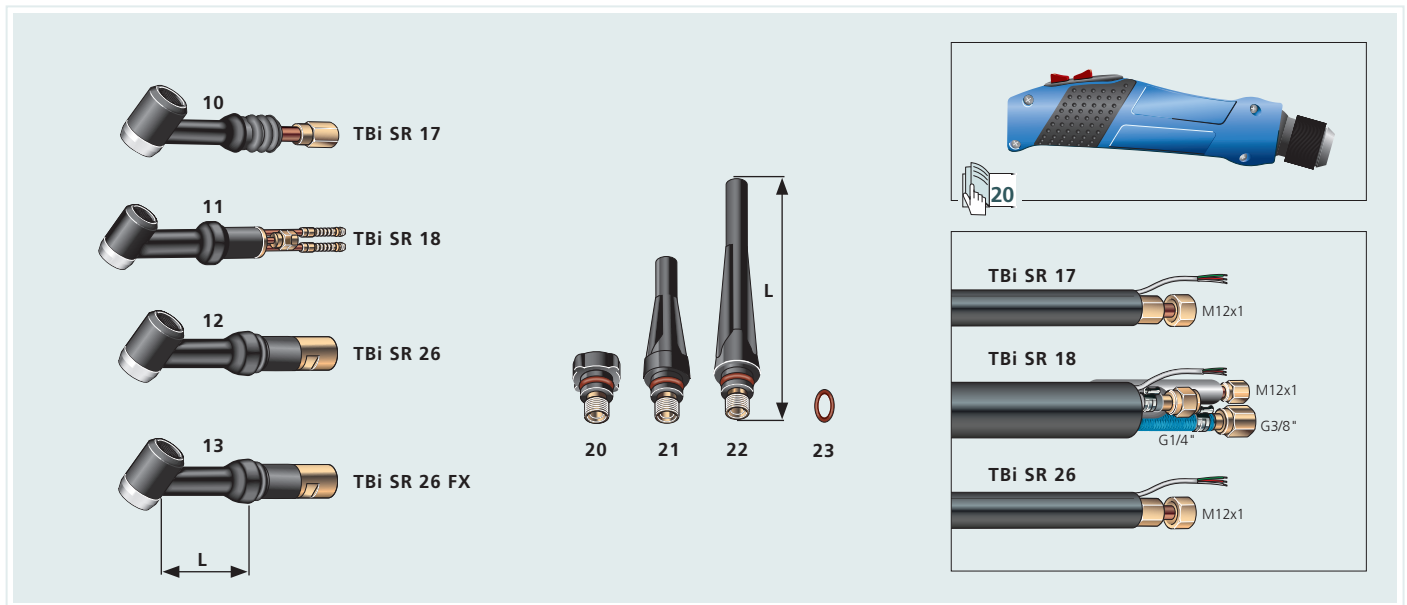

## Recambios / Spare parts

10	Cuello / Torch body	SR 17		L = 50 mm	405P170700
10	Cuello / Torch body	SR 17 FX	flexible / flexible	L = 50 mm	403P170700
11	Cuello / Torch body	SR 18		L = 50 mm	405P180702
11	Cuello / Torch body	SR 18 FX	flexible / flexible	L = 50 mm	403P180702
12	Cuello / Torch body	SR 26		L = 50 mm	405P260702
13	Cuello / Torch body	SR 26 FX	flexible / flexible	L = 50 mm	403P260702
20	Tapón / Back cap	corta / short		L = 24 mm	57Y04 402P170100
21	Tapón / Back cap	media / medium		L = 58 mm	57Y05 402P170150
22	Tapón / Back cap	larga / long		L = 140 mm	57Y02 402P170200
23	Junta torica / O-Ring				98W18 365P200096

## Consumibles / Consumables

▶ B	Aislante / Insulator	difusor de gas, pequeño / small, gas lens		402P956100
▶ C	Aislante / Insulator	Estándar	18CG	403P171000
▶ D	Aislante / Insulator	Difusor de gas / Gas lens	54N01	401P181100
▶ E	Adaptador / Adapter	Difusor de gas Jumbo / Jumbo Gas lens	54N63	401P171105

▶ = Estándar

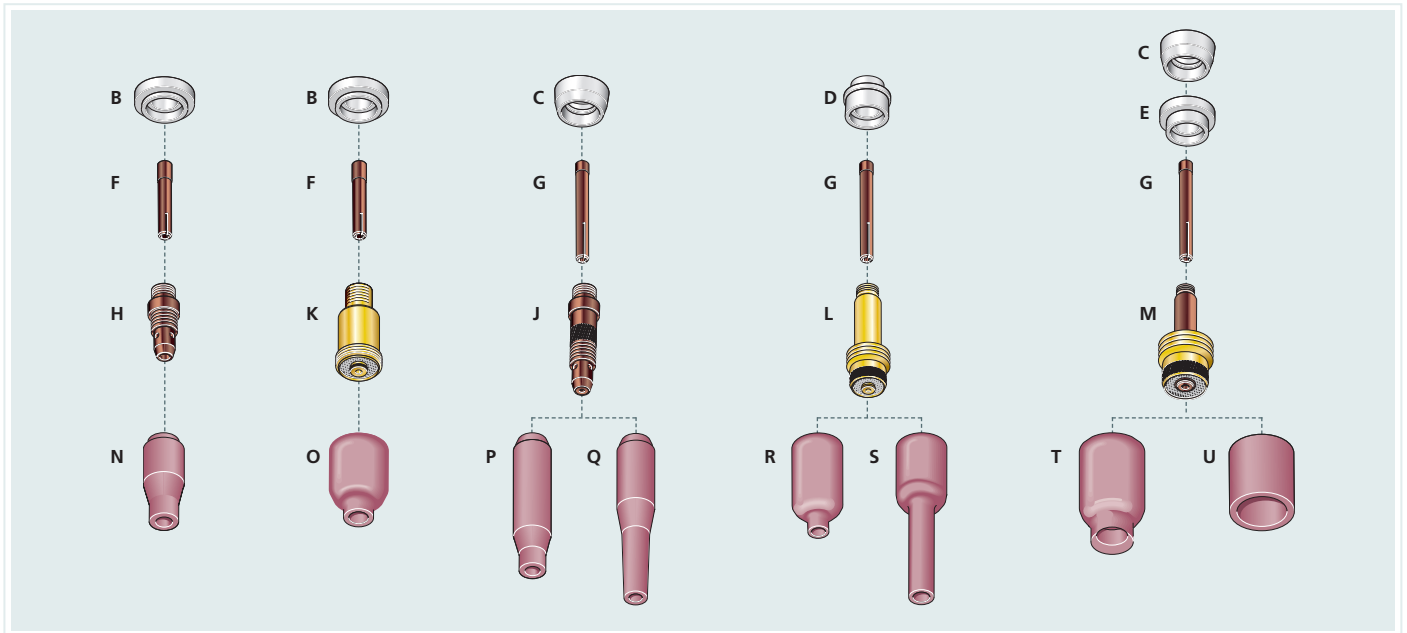

	Ø 0.5 mm Ø 0.020"	Ø 1.0 mm Ø 0.040"	Ø 1.6 mm Ø 1/16"	Ø 2.0 mm	Ø 2.4 mm Ø 3/32"	Ø 3.0 mm	Ø 3.2 mm Ø 1/8"	Ø 4.0 mm Ø 5/32"
--	----------------------	----------------------	---------------------	----------	---------------------	----------	--------------------	---------------------

**Porta tungstenos / Collets**

F	corta / short L=29.3 mm	-	10N22S 402P10N22S	10N23S 402P10N23S	-	10N24S 402P10N24S	-	10N25S 402P10N25S	-
▶ G	Estándar L=50.0 mm	10N21 402P170499	10N22 402P170500	10N23 402P170502	-	10N24 402P170503	-	10N25 402P170504	54N20 402P170505

**Porta toberas / Collet bodies**

H	corta / short L=24.5 mm	-	Ø 1.0-1.6 mm 17CB22 402P17CB22		Ø 2.0-2.4 mm 17CB23 402P17CB23		Ø 3.0-3.2 mm 17CB24 402P17CB24		-
▶ J	Estándar L=47.0 mm	-	Ø 0.5 - 1.6 mm 10N31 401P180999		Ø 2.0-2.4 mm 10N32 401P181000		Ø 3.0-3.2 mm 10N28 401P181001		406488 401P181002

**Difusor de gas / Gas lenses**

K	corta / short L=27.0 mm	-	-	-	-	-	-	-	-
L	Estándar L=50.0 mm	-	45V24 401P181299	45V25 401P181300	Ø 2.0-2.4 mm 45V26, 401P181301		Ø 3.0-3.2 mm 45V27, 401P181302		45V28 401P181303
M	Jumbo L=50.0 mm	-	45V0204 401P181350	45V116 401P181351	Ø 2.0-2.4 mm 45V64, 401P181352		Ø 3.0-3.2 mm 995795, 401P181353		45V63 401P181354

	No. 4 Ø 6.5 mm Ø 1/4"	No. 5 Ø 8.0 mm Ø 5/16"	No. 6 Ø 9.5 mm Ø 3/8"	No. 7 Ø 11 mm Ø 7/16"	No. 8 Ø 12.5 mm Ø 1/2"	No. 10 Ø 16 mm Ø 5/8"	No. 11 Ø 17.5 mm Ø 11/16"	No. 12 Ø 19 mm Ø 3/4"	Ø 24.0 mm
--	-----------------------------	------------------------------	-----------------------------	-----------------------------	------------------------------	-----------------------------	---------------------------------	-----------------------------	-----------

**Toberas cerámicas / Ceramic nozzles**

N	corta / short L=30.0 mm	13N08 401P201106	13N09 401P201107	13N10 401P201108	13N11 401P201109	13N12 401P201110	13N13 401P201111	-	-	-
O	Difusor de gas, short L=25.5 mm	53N58 401P201400	53N59 401P201401	53N60 401P201402	53N61 401P201403	53N61S 401P201404	-	-	-	-
▶ P	Estándar L=47.0 mm	10N50 401P170907	10N49 401P170908	10N48 401P170909	10N47 401P170910	10N46 401P170911	10N45 401P170912	-	10N44 401P170913*-	-
Q	Estándar, L L=76.0 mm	10N50L 401P170923	10N49L 401P170914	10N48L 401P170915	10N47L 401P170916	-	-	-	-	-
R	Difusor de gas, L=42.0 mm	54N18 401P222200	54N17 401P222201	54N16 401P222202	54N15 401P222203	54N14 401P222204	-	54N19 401P222206	-	-
S	Difusor de gas, L L=76.0 mm	54N18 L 401P222211	54N17 L 401P222207	54N16 L 401P222208	54N15 L 401P222209	54N14 L 401P222210	-	-	-	-
T	Difusor de gas, Jumbo L=48.0 mm	-	-	57N75 401P201451	-	57N74 401P201452	53N88 401P222250	-	53N87 401P222251	53N89-L 401P222253
U	Difusor de gas, Jumbo L=34.0 mm	-	-	-	-	-	-	-	-	53N89 401P222252

\* L=50.0 mm

▶ = Estándar

## Modelos MultiLock / Models MultiLock



Modelos MultiLock /  
Models MultiLock

### Antorcha / Torch TM 125



**+ Cabezal / Head  
MultiLock 9/20**

60% (10 min.)  
AC: 80 A  
DC: 110 A  
Ø 0.5-2.4 mm

### Antorcha / Torch TM 250



**+ Cabezal / Head  
MultiLock 9/20**

100% (10 min.)  
AC: 160 A  
DC: 220 A  
Ø 0.5-3.2 mm



**+ Cabezal / Head  
MultiLock 17/18/26**

60% (10 min.)  
AC: 100 A  
DC: 140 A  
Ø 1.0-2.4 mm



**+ Cabezal / Head  
MultiLock 17/18/26**

100% (10 min.)  
AC: 225 A  
DC: 320 A  
Ø 1.0-4.0 mm

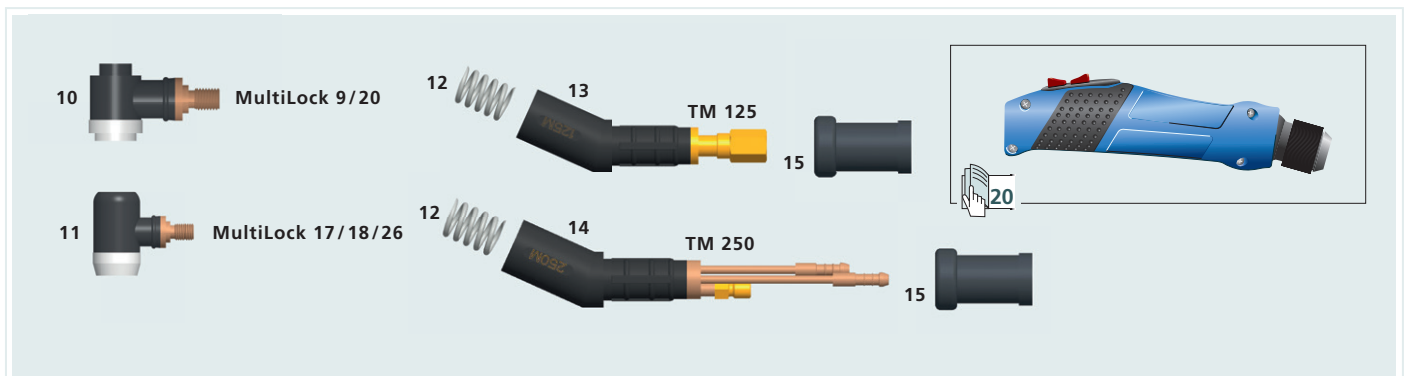

### Recambios / Spare parts

10	Cabezal / Head	MultiLock 9/20	402P550002
11	Cabezal / Head	MultiLock 17/18/26	402P550003
12	Muelle / Spring		402P550004
13	Cuello / Torch body	TM 125	402P550001
14	Cuello / Torch body	TM 250	402P600001
15	Soporte del cabezal / Front insert		402P600015



Combinado con piezas de desgaste TBi estándar. /  
Combined with Standard TBi wear parts.





TBi XCT 200W

**TBi XCT 200W**

refrigerada por agua / water cooled  
100% (10 min.)  
AC: 115 A  
DC: 250 A  
Ø 1.6-4.0 mm



TBi XCT 400W

**TBi XCT 400W**

refrigerada por agua / water cooled  
100% (10 min.)  
AC: 315 A  
DC: 450 A  
Ø 1.6-4.0 mm

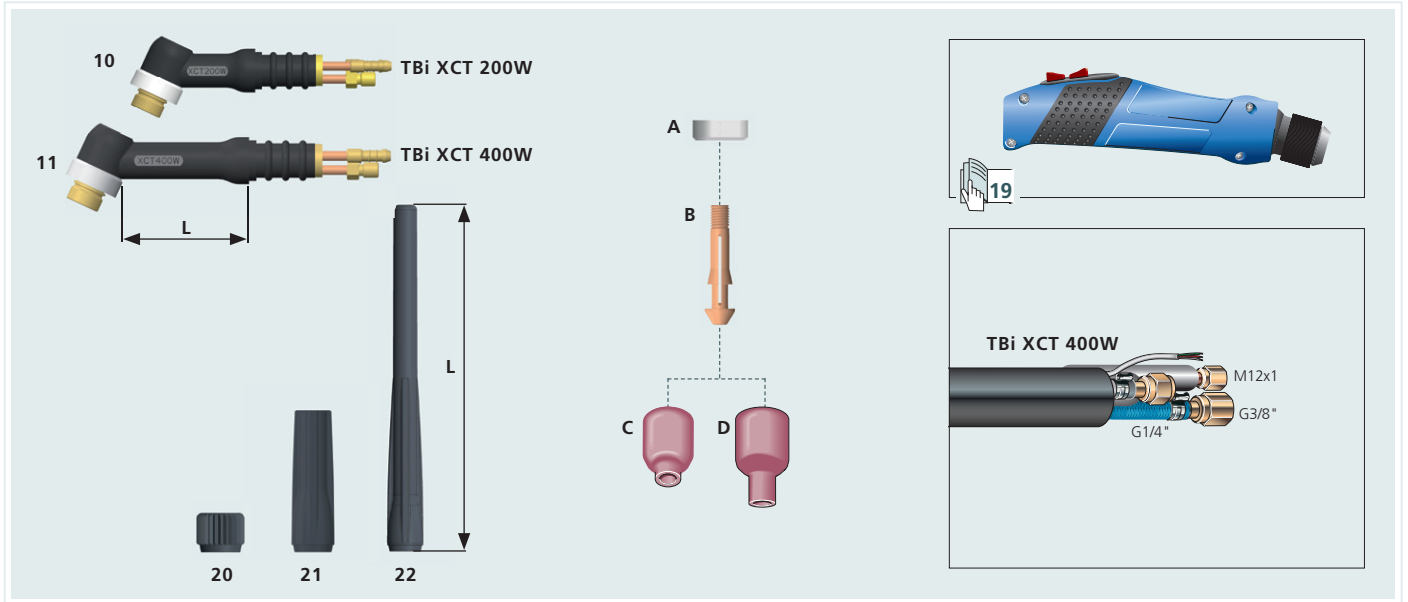

**Recambios / Spare parts**

10	Cuello / Torch body	XCT 200W	L = 32 mm	405PX20700
11	Cuello / Torch body	XCT 400W	L = 52 mm	405PX40700
20	Tapón / Back cap	corta / short	L = 13 mm	402PX40600
21	Tapón / Back cap	media / medium	L = 50 mm	402PX40650
22	Tapón / Back cap	larga / long	L = 145 mm	402PX40700
A	Aislante / Insulator			401PX40700

	Ø 1.6 mm Ø 1/16"	Ø 2.4 mm Ø 3/32"	Ø 3.2 mm Ø 1/8"	Ø 4.0 mm Ø 5/32"
--	---------------------	---------------------	--------------------	---------------------

**Porta tungstenos / Collets**

▶ B	L=44.0 mm	-	-	-	-
		401PX40501	401PX40502	401PX40503	401PX40504

	No. 4 Ø 6.5 mm Ø 1/4"	No. 5 Ø 8.0 mm Ø 5/16"	No. 6 Ø 9.5 mm Ø 3/8"	No. 7 Ø 11 mm Ø 7/16"	No. 8 Ø 12.5 mm Ø 1/2"	No. 10 Ø 16 mm Ø 5/8"
--	-----------------------------	------------------------------	-----------------------------	-----------------------------	------------------------------	-----------------------------

**Toberas cerámicas / Ceramic nozzles**

C	L=25.5 mm	53N58 401P201400	53N59 401P201401	53N60 401P201402	53N61 401P201403	53N61S 401P201404	-	401P201409
▶ D	L, L=35.0 mm	53N58L 401P201408	53N59L 401P201405	53N60L 401P201406	53N61L 401P201407	-	-	401P201410

# TBi SR 24G , TBi SR 24W



## TBi SR 24G

refrigerada por gas /  
gas cooled  
60% (10 min.)  
AC: 80 A  
DC: 110 A  
Ø 0.5-1.6 mm

## TBi SR 24W (FX)

refrigerada  
por agua /  
water cooled  
100% (10 min.)  
AC: 100 A  
DC: 140 A  
Ø 0.5-2.4 mm

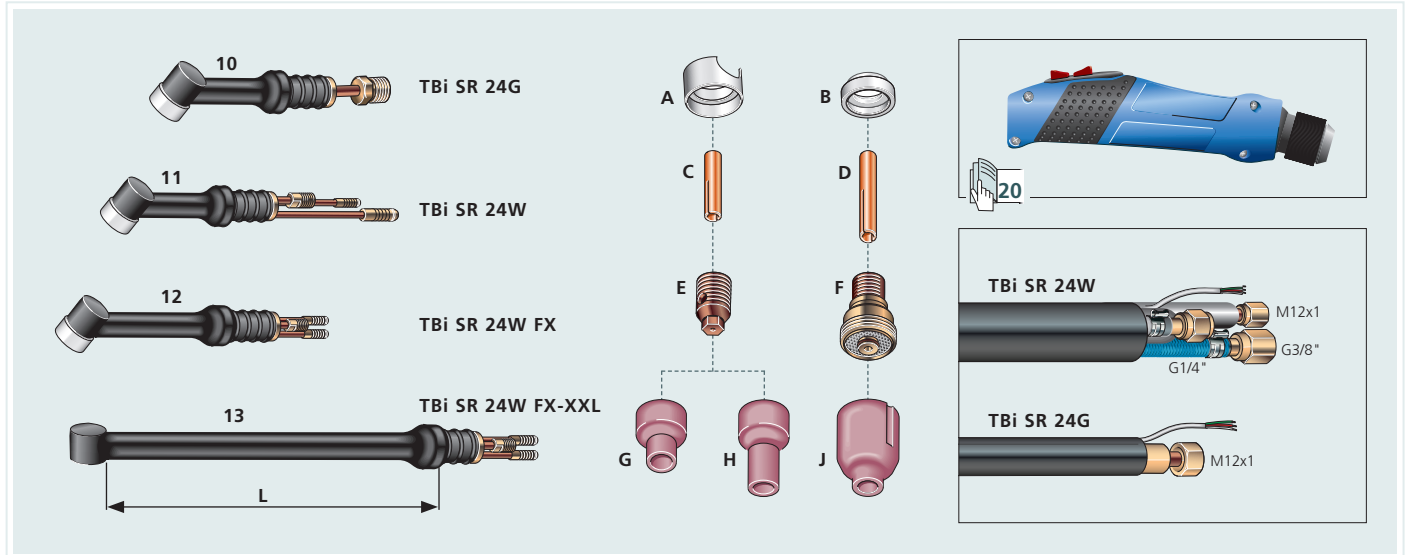

### Recambios / Spare parts

10	Cuello / Torch body	SR 24G		L = 50 mm	405P240800
11	Cuello / Torch body	SR 24W		L = 50 mm	405P240850
12	Cuello / Torch body	SR 24W FX (Estándar)	flexible / flexible	L = 65 mm	403P240700
12	Cuello / Torch body	SR 24W FX-L	flexible / flexible	L = 90 mm	403P240750
12	Cuello / Torch body	SR 24W FX-XL	flexible / flexible	L = 115 mm	403P240701
13	Cuello / Torch body	SR 24W FX-XXL	flexible / flexible	L = 290 mm	403P240770
A	Aislante / Insulator				53N22 401P240700*
B	Aislante / Insulator	Difusor de gas / Gas lens			53N66 401P240701

	Ø 0.5 mm Ø 0.020"	Ø 1.0 mm Ø 0.040"	Ø 1.6 mm Ø 1/16"	Ø 2.4 mm Ø 3/32"
<b>Porta tungstenos / Collets</b>				
C L=14.0 mm	53N15 401P240500	53N16 401P240501	53N14 401P240502	24C332 401P240505
D Gas lens, L=23.0 mm	-	53N63 401P240802	53N64 401P240803	24GLC332 401P240805
<b>Porta toberas / Collet body</b>				
E L=12.0 mm	53N17 401P241000	53N18 401P241001	53N19 401P241002	24CB332 401P241003
<b>Difusor de gas / Gas lens</b>				
F L=21.5 mm	-	45V42 401P201300	45V43 401P201301	45V44 401P201302

	No. 4 Ø 6.5 mm Ø 1/4"	No. 5 Ø 8.0 mm Ø 5/16"	No. 6 Ø 9.5 mm Ø 3/8"	No. 7 Ø 11 mm Ø 7/16"	No. 8 Ø 12.5 mm Ø 1/2"
<b>Toberas cerámicas / Ceramic nozzles</b>					
G Estándar, L=16.5 mm	53N24 401P240900	53N25 401P240901	53N27 401P240902	-	-
H Estándar, L, L=29.0 mm	53N24L 401P240903	-	53N26L 401P240904	-	-
J Difusor de gas / Gas lens L=25.5 mm	53N58 401P201400	53N59 401P201401	53N60 401P201402	53N61 401P201403	53N61S 401P201404

► = Estándar \* No compatible con el cuerpo de la antorcha SR 24W FX-XXL / Not compatible with torch body SR 24W FX-XXL





**TBi SR 25G FX**  
 refrigerada por gas /  
 gas cooled  
 60% (10 min.)  
 AC: 80 A  
 DC: 110 A  
 Ø 0.5-2.4 mm

**TBi SR 25W FX**  
 refrigerada  
 por agua /  
 water cooled  
 100% (10 min.)  
 AC: 100 A  
 DC: 140 A  
 Ø 0.5-3.2 mm

TBi SR 25G FX / TBi SR 25W FX

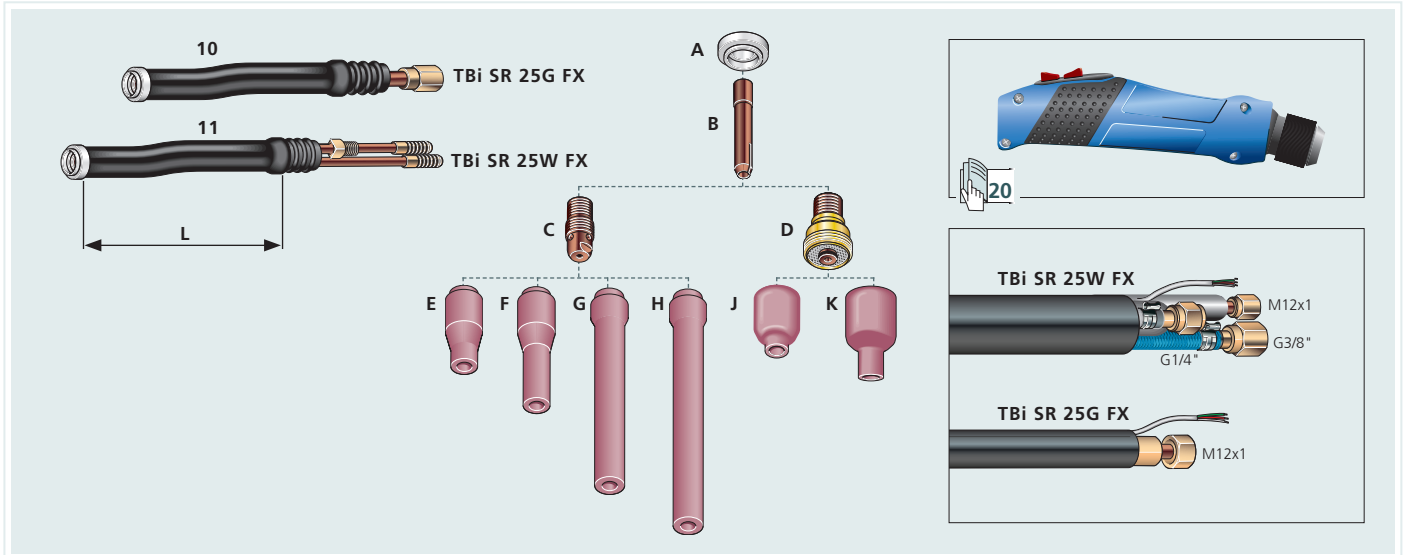

### Recambios / Spare parts

10	Cuello / Torch body	SR 25G FX	flexible / flexible	L = 120 mm	401P250200
11	Cuello / Torch body	SR 25W FX (Standard)	flexible / flexible	L = 120 mm	401P251200
11	Cuello / Torch body	SR 25W FX-L	flexible / flexible	L = 300 mm	401P251201
A	Aislante / Insulator				401P250800

	Ø 0.5 mm Ø 0.020"	Ø 1.0 mm Ø 0.040"	Ø 1.6 mm Ø 1/16"	Ø 2.0 mm	Ø 2.4 mm Ø 3/32"	Ø 3.0 mm	Ø 3.2 mm Ø 1/8"
--	----------------------	----------------------	---------------------	----------	---------------------	----------	--------------------

### Porta tungstenos / Collets

► B	Standard, L=25.4 mm	13N20 401P200599	13N21 401P200600	13N22 401P200601	- 401P200604	13N23 401P200602	- 401P200605	13N24 401P200603
-----	---------------------	---------------------	---------------------	---------------------	-----------------	---------------------	-----------------	---------------------

### Porta toberas / Collet body

► C	L=20.6 mm	Ø 0.5 - 1.6 mm 13N27 401P201001		Ø 2.0 - 2.4 mm 13N28 401P201002		Ø 3.0 - 3.2 mm 13N29 401P201003	
-----	-----------	---------------------------------------	--	---------------------------------------	--	---------------------------------------	--

### Difusor de gas / Gas lens

D	L=21.5 mm	-	45V42 401P201300	45V43 401P201301	Ø 2.0 - 2.4 mm 45V44 401P201302		Ø 3.0 - 3.2 mm 45V45 401P201303	
---	-----------	---	---------------------	---------------------	---------------------------------------	--	---------------------------------------	--

	No. 3 Ø 5.0 mm Ø 3/16"	No. 4 Ø 6.5 mm Ø 1/4"	No. 5 Ø 8.0 mm Ø 5/16"	No. 6 Ø 9.5 mm Ø 3/8"	No. 7 Ø 11 mm Ø 7/16"	No. 8 Ø 12.5 mm Ø 1/2"	No. 10 Ø 16 mm Ø 5/8"
--	------------------------------	-----------------------------	------------------------------	-----------------------------	-----------------------------	------------------------------	-----------------------------

### Toberas cerámicas / Ceramic nozzles

► E	Estándar, L=30.0 mm	-	13N08 401P201106	13N09 401P201107	13N10 401P201108	13N11 401P201109	13N12 401P201110	13N13 401P201111
F	Estándar, L, L=48.0 mm	796F70 401P201115	796F71 401P201116	796F72 401P201117	796F73 401P201118	-	-	-
G	Estándar, XL, L=63.0 mm	-	796F75 401P201126	796F76 401P201127	796F77 401P201128	-	-	-
H	Estándar, XXL, L=89.0 mm	-	796F79 401P201136	-	-	-	-	-
J	Difusor de gas, L=25.5 mm	-	53N58 401P201400	53N59 401P201401	53N60 401P201402	53N61 401P201403	53N61S 401P201404	-
K	Difusor de gas, L, L=35.0 mm	-	53N58L 401P201408	53N59L 401P201405	53N60L 401P201406	53N61L 401P201407	-	-

► = Estándar

# TBi AW 424 , TBi AW 427



## TBi AW 424

refrigerada por agua / water cooled  
100% (10 min.)  
AC: 280 A  
DC: 400 A  
Ø 1.0-4.0 mm



## TBi AW 427

refrigerada por agua / water cooled  
100% (10 min.)  
AC: 350 A  
DC: 500 A  
Ø 2.4-8.0 mm

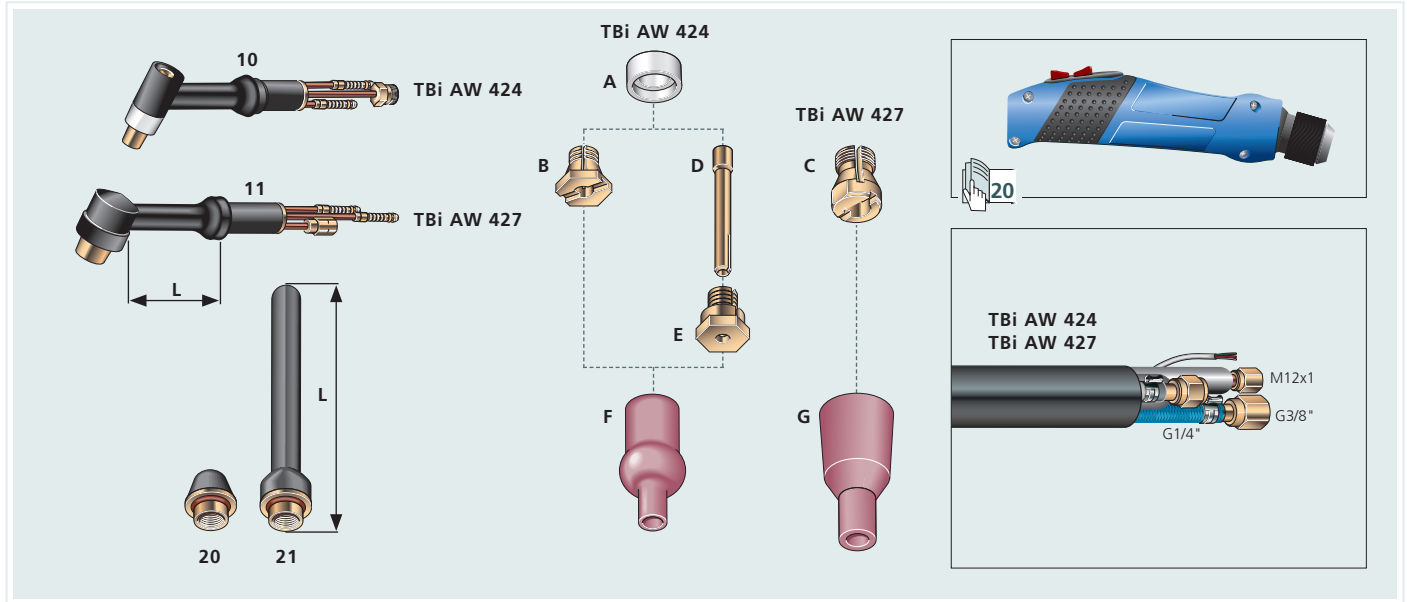

### Recambios / Spare parts

10	Cuello / Torch body	AW 424	L = 55 mm	404P240702
11	Cuello / Torch body	AW 427	L = 55 mm	404P270702
20	Tapón / Back cap	corta / short	L = 16 mm	411-30 404P240100
21	Tapón / Back cap	larga / long	L = 101 mm	411-70 404P240200
A	Aislante / Insulator	AW 424	200 NG	404P280300

	Ø 1.0 mm Ø 0.040"	Ø 1.6 mm Ø 1/16"	Ø 2.4 mm Ø 3/32"	Ø 3.2 mm Ø 1/8"	Ø 4.0 mm Ø 5/32"	Ø 4.8 mm Ø 3/16"	Ø 6.4 mm Ø 1/4"	Ø 8.0 mm Ø 5/16"
--	----------------------	---------------------	---------------------	--------------------	---------------------	---------------------	--------------------	---------------------

### Pinza portapieza / direct clamping collet

B	AW 424, L=10.5 mm	-	221.00 404P240501	222.00 404P240502	223.00 404P240503	224.00 404P240504	-	-	-
C	AW 427, L=17 mm	-	-	223-07 404P270499	224-07 404P270500	225-07 404P270501	226-07 404P270502	227-07 404P270503	228-07 404P270504

### Porta tungstenos / Collets

D	AW 424, L=59 mm	964.01 404P240602	965.01 404P240603	966.01 404P240604	967.01 404P240605	968.01 404P240606	-	-	-
---	--------------------	----------------------	----------------------	----------------------	----------------------	----------------------	---	---	---

### Carcasa de porta-tungstenos / Collet body

E	AW 424, L=10.5 mm	961.41 404P240902	961.51 404P240903	961.61 404P240904	961.71 404P240905	961.81 404P240906	-	-	-
---	----------------------	----------------------	----------------------	----------------------	----------------------	----------------------	---	---	---

	No. 4 Ø 6.5 mm Ø 1/4"	No. 5 Ø 8.0 mm Ø 5/16"	No. 6 Ø 9.5 mm Ø 3/8"	No. 7 Ø 11 mm Ø 7/16"	No. 8 Ø 12.5 mm Ø 1/2"	No. 9 Ø 14 mm Ø 9/16"	No. 10 Ø 16 mm Ø 5/8"	Ø 18 mm
--	-----------------------------	------------------------------	-----------------------------	-----------------------------	------------------------------	-----------------------------	-----------------------------	---------

### Toberas cerámicas / Ceramic nozzles

F	Estándar, L=44.0 mm	130-00 404P241100	131-00 404P241101	132-00 404P241102	133-00 404P241103	134-00 404P241104	135-00 404P241105	136-00 404P241106	- 404P241108
G	Estándar, L=54.0 mm	-	141-00 404P271100	142-00 404P271101	143-00 404P271102	144-00 404P271103	-	145-00 404P271104	-



**TBi SR 400**  
 refrigerada por agua / water cooled  
 100% (10 min.)  
 AC: 315 A  
 DC: 450 A  
 Ø 1.0-4.8 mm

TBi SR 400

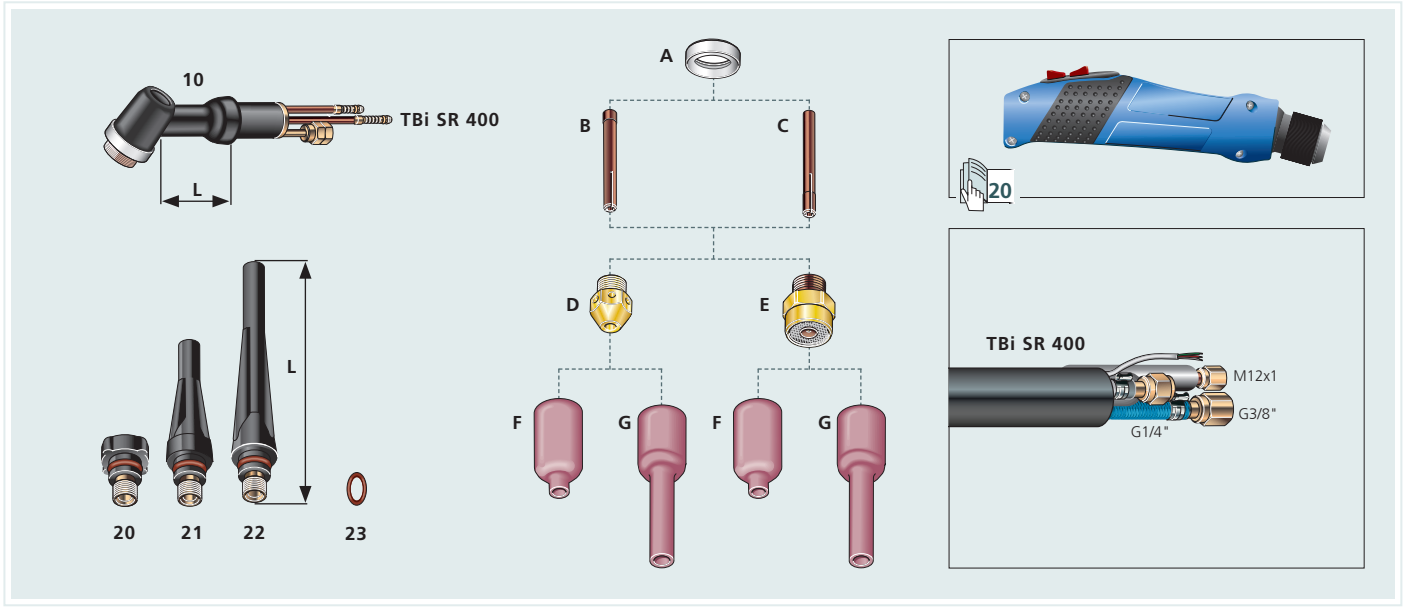

**Recambios / Spare parts**

10	Cuello / Torch body	SR 400	L=50 mm	405P400802
20	Tapón / Back cap	corta / short	L=24 mm	57Y04 402P170100
21	Tapón / Back cap	media / medium	L=58 mm	57Y05 402P170150
22	Tapón / Back cap	larga / long	L=140 mm	57Y02 402P170200
23	Junta torica / O-Ring			98W18 365P200096
A	Aislante / Insulator			18NG 405P400001

	Ø 1.0 mm Ø 0.040"	Ø 1.6 mm Ø 1/16"	Ø 2.4 mm Ø 3/32"	Ø 3.2 mm Ø 1/8"	Ø 4.0 mm Ø 5/32"	Ø 4.8 mm Ø 3/16"
--	----------------------	---------------------	---------------------	--------------------	---------------------	---------------------

**Porta tungstenos / Collets**

▶ B	Estándar, L=50 mm	10N22 402P170500	10N23 402P170502	10N24 402P170503	10N25 402P170504	54N20 402P170505	-
C	Heavy duty, L=50 mm	-	-	-	10N25HD 405P400504	54N20HD 405P400505	18C36 405P400506

**Carcasa de porta-tungstenos / Collet body**

▶ D	L=19.5 mm	Ø 1.0-3.2 mm 405P401000		Ø 3.2-4.8 mm 405P401001		
-----	-----------	----------------------------	--	----------------------------	--	--

**Difusor de gas / Gas lens**

E	L=21.3 mm	18GL04 405P401301	18GL16 405P401302	18GL32 405P401303	18GL18 405P401304	18GL53 405P401305	18GL36 405P401306
---	-----------	----------------------	----------------------	----------------------	----------------------	----------------------	----------------------

	No. 4 Ø 6.5 mm Ø 1/4"	No. 5 Ø 8.0 mm Ø 5/16"	No. 6 Ø 9.5 mm Ø 3/8"	No. 7 Ø 11 mm Ø 7/16"	No. 8 Ø 12.5 mm Ø 1/2"	No. 11 Ø 17.5 mm Ø 11/16"
--	-----------------------------	------------------------------	-----------------------------	-----------------------------	------------------------------	---------------------------------

**Toberas cerámicas / Ceramic nozzles**

▶ F	Estándar, L=42.0 mm	54N18 401P222200	54N17 401P222201	54N16 401P222202	54N15 401P222203	54N14 401P222204	54N19 401P222206
G	Estándar, L, L=76.0 mm	54N18 L 401P222211	54N17 L 401P222207	54N16 L 401P222208	54N15 L 401P222209	54N14 L 401P222210	-

▶ = Estándar

# Empuñadura de precisión / Precision Handle



## Empuñaduras y módulos / Handles and modules



### Módulos / Modules

1	Funda de goma / Cover	-	401P102023	401P102038
2	Placa / PC-Board	-	384P101035	384P101050
3	Módulo PSD completo / PSD module cpl.	401P101090	-	-

### Empuñadura con módulo PSD incluido / Handle incl. PSD

10	Empuñadura pequeña, solo como reemplazo para antorchas con PSD / <i>handle small, replacement for torches with PSD only</i> SR 9, SR 17, SR 20, SR 21, SR 24, XCT 400W	401P101012	-	-
11	Empuñadura grande, solo como reemplazo para antorchas con PSD / <i>handle large, replacement for torches with PSD only</i> SR 18, SR 26, AW 424	401P101512	-	-

### Empuñaduras, módulo incluido / Handle incl. module

10	Empuñadura pequeña / <i>handle small</i> SR 9, SR 17, SR 20, SR 21, SR 24, SR 25, XCT 400W	-	401P101020	401P101030
11	Empuñadura grande / <i>handle large</i> SR 18, SR 26, SR 400, AW 424, AW 427	-	401P101520	401P101530

### Consumibles / Spare parts

D	Rótula / Ball joint	SR 9, 17, 24 G, 25 G	401P102026
E	Rótula / Ball joint	SR 20, 21, 24 W, 25 W, XCT 400W	401P102029
F	Rótula / Ball joint	SR 18, 26, 400, AW 424, 427	401P102032

### Cuellos y equipamiento de antorchas 10-19 / Torch bodys and equipment

► = Estándar



**TBi SR 12**  
 refrigerada  
 por agua /  
 water cooled  
 100% (10 min.)  
 AC: 350 A  
 DC: 500 A  
 Ø 2.4-6.4 mm

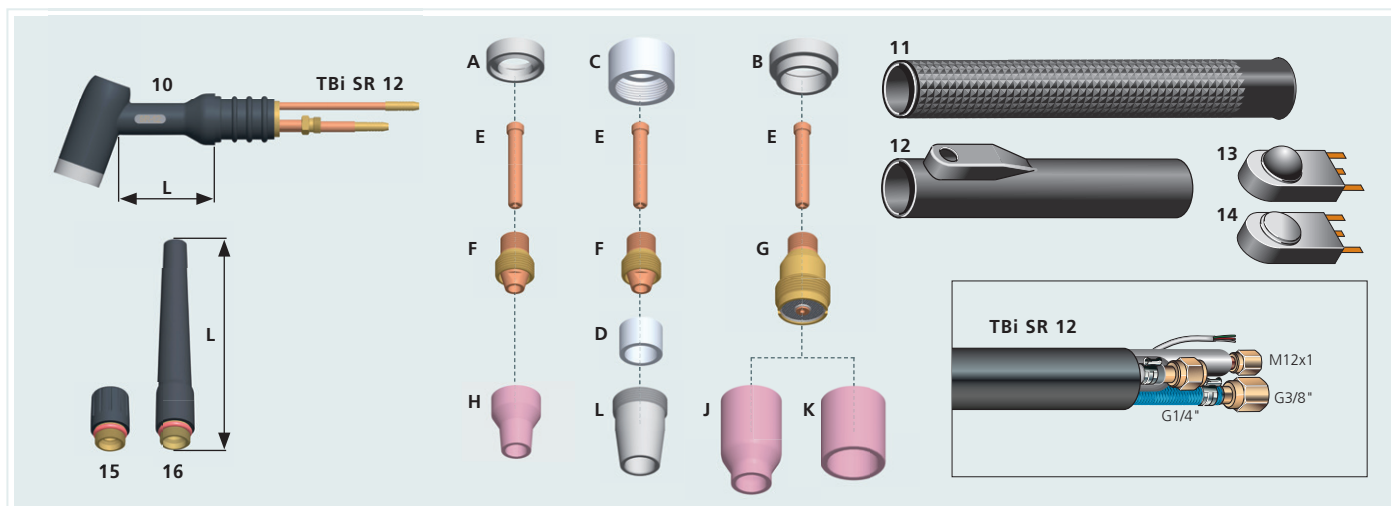

**Recambios / Spare parts**

10	Cuello / Torch body	SR 12	L = 60 mm	405P120800
11	Empuñadura en tubo / Handle tube			85WP13 405P120900
12	Manguito de interruptor/ Switch boot			401P120600
13	Interruptor / Switch	circular / round		385P033009
14	Interruptor / Switch	plano / flat		385P233009
15	Tapón / Back cap	corta / short	L = 31 mm	56Y45 405P120100
16	Tapón / Back cap	larga / long	L = 115 mm	56Y44 405P120200
A	Aislante / Insulator	Estándar		12NG 405P120300
B	Aislante / Insulator	Difusor de gas / Gas lens		12GLG 405P120301
C	Aislante / Insulator	Boquilla de gas metálica/ Metal nozzle		12MNG 405P120302
D	Casquillo aislante / Insulating sleeve			85Z99 405P120303

	Ø 2.4 mm Ø 3/32"	Ø 3.2 mm Ø 1/8"	Ø 4.0 mm Ø 5/32"	Ø 4.8 mm Ø 3/16"	Ø 6.4 mm Ø 1/4"
--	---------------------	--------------------	---------------------	---------------------	--------------------

**Porta-tungstenos / Collet**

E	L=60,2 mm	85Z15 405P120502	85Z16 405P120503	85Z17 405P120504	85Z18 405P120505	85Z19 405P120506
---	-----------	---------------------	---------------------	---------------------	---------------------	---------------------

**Porta toberas / Collet body**

F	Ø 2.4-6.4 mm 11WP65, 405P121000				
---	------------------------------------	--	--	--	--

**Difusor de gas / Gas lens**

G	11GL32 405P121302	11GL18 405P121303	11GL53 405P121304	11GL36 405P121305	- 405P121306
---	----------------------	----------------------	----------------------	----------------------	-----------------

	No. 4 Ø 6.5 mm Ø 1/4"	No. 5 Ø 8.0 mm Ø 5/16"	No. 6 Ø 9.5 mm Ø 3/8"	No. 7 Ø 11 mm Ø 7/16"	No. 8 Ø 12.5 mm Ø 1/2"	No. 10 Ø 16 mm Ø 5/8"	No. 12 Ø 19 mm Ø 3/4"	Ø 24 mm
--	-----------------------------	------------------------------	-----------------------------	-----------------------------	------------------------------	-----------------------------	-----------------------------	---------

**Toberas cerámicas / Ceramic nozzles**

H	Estándar, L=32.0 mm	14N57 401P101700	14N58 401P101701	14N59 401P101702	14N60 401P101703	14N61 401P101704	-	-	-
J	Difusor de gas, Jumbo L=48.0 mm	-	-	57N75 401P201451	-	57N74 401P201452	53N88 401P222250	53N87 401P222251	53N89-L 401P222253
K	Difusor de gas, Jumbo L=34.0 mm	-	-	-	-	-	-	-	53N89 401P222252

**Toberas metálicas / Metal nozzles**

L	Estándar, L=40.7 mm	-	-	-	-	86Z02 405P120701	86Z03 405P120702	86Z06 405P120703	-
---	------------------------	---	---	---	---	---------------------	---------------------	---------------------	---

► = Estándar

## Empuñaduras en tubo / Handle tubes

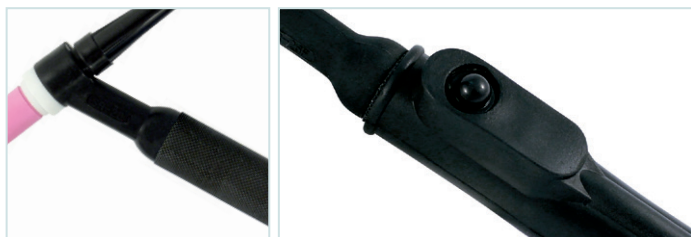

## Empuñaduras en tubo y conmutadores / Handle tubes and switches

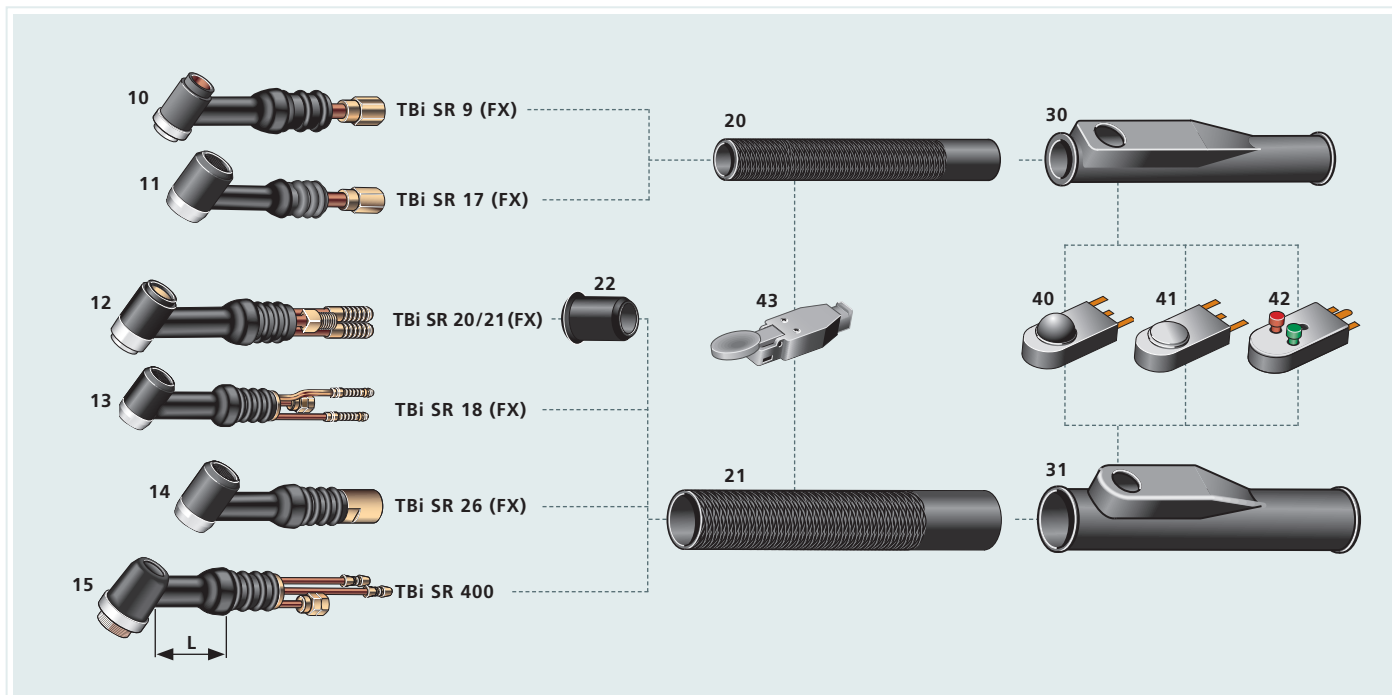

### Recambios / Spare parts

10	Cuello / Torch body	SR 9		L = 35 mm	405P090800
10	Cuello / Torch body	SR 9 FX	flexible / flexible	L = 35 mm	403P090800
11	Cuello / Torch body	SR 17		L = 50 mm	405P170700
11	Cuello / Torch body	SR 17 FX	flexible / flexible	L = 50 mm	403P170700
12	Cuello / Torch body	SR 20		L = 35 mm	405P200800
12	Cuello / Torch body	SR 20 FX	flexible / flexible	L = 35 mm	403P200700
12	Cuello / Torch body	SR 21		L = 35 mm	405P210800
12	Cuello / Torch body	SR 21 FX	flexible / flexible	L = 65 mm	403P210700
12	Cuello / Torch body	SR 21 FX-L	flexible / flexible	L = 115 mm	403P210701
13	Cuello / Torch body	SR 18		L = 55 mm	405P180700*
13	Cuello / Torch body	SR 18 FX	flexible / flexible	L = 55 mm	403P180700*
14	Cuello / Torch body	SR 26		L = 50 mm	405P260700*
14	Cuello / Torch body	SR 26 FX	flexible / flexible	L = 50 mm	403P260700*
15	Cuello / Torch body	SR 400		L = 50 mm	405P400800*

### Empuñaduras en tubo / Handle tubes

20	Empuñadura en tubo / Handle tube	SR 9, SR 17	D=20,5 mm / L=130 mm	H 100	402P171301
21	Empuñadura en tubo / Handle tube	SR 18, SR 20, SR 26, SR 400	D=27,5 mm / L=154 mm	H 200	402P180801
22	Casquillo de inserción / Front insert	SR 20			401P201360

### Manguitos de interruptor / Switch boots

30	Manguito de interruptor / Switch boot	SR 9, SR 17		BS-1	401P170600
31	Manguito de interruptor / Switch boot	SR 18, SR 20, SR 26, SR 400		BL-1	402P180600

### Interruptor / Switches

40	Interruptor / Switch		circular / round	SW-1	385P033009
41	Interruptor / Switch		plano / flat	SW-1	385P133009
42	Interruptor de presión doble / Double function switch		rojo, verde / red, green		385P033014
43	Interruptor de cuchara / Spoon switch				385P120002

\* No compatible con la empuñadura de precisión TBi / Not compatible with TBi Precision handle

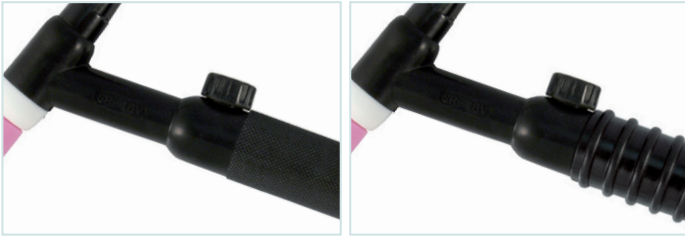

**Empuñaduras en tubo para antorchas con válvula /**  
*Handle tubes for torch bodies with valve*

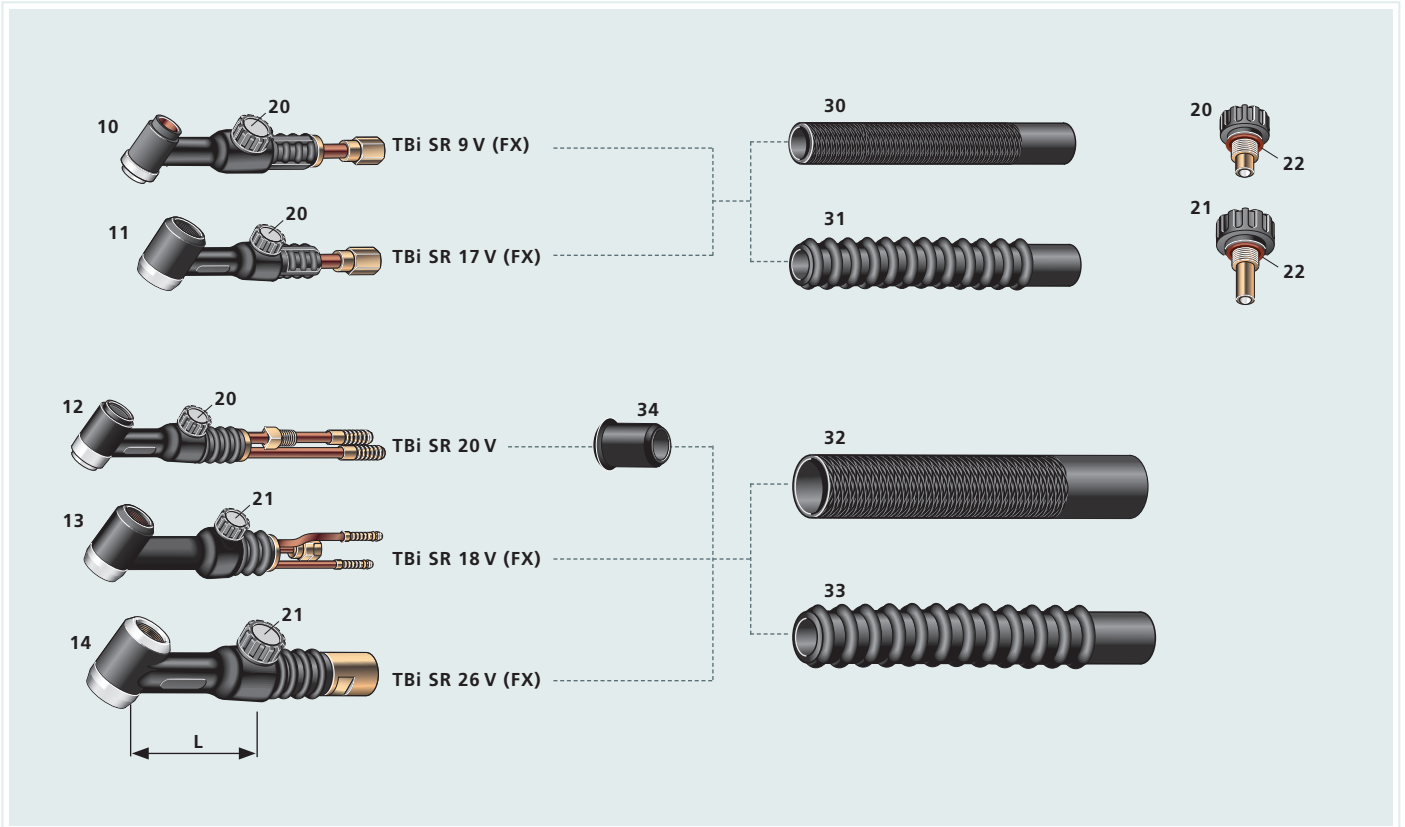

## Recambios / Spare parts

10	Cuello / Torch body	SR 9 V		L = 50 mm	405P090850
10	Cuello / Torch body	SR 9 V FX	flexible / flexible	L = 50 mm	403P090900
11	Cuello / Torch body	SR 17 V		L = 50 mm	405P170800
11	Cuello / Torch body	SR 17 V FX	flexible / flexible	L = 50 mm	403P170800
12	Cuello / Torch body	SR 20 V		L = 50 mm	405P200850
13	Cuello / Torch body	SR 18 V		L = 70 mm	405P180750
13	Cuello / Torch body	SR 18 V FX	flexible / flexible	L = 65 mm	403P180800
14	Cuello / Torch body	SR 26 V		L = 65 mm	405P260800
14	Cuello / Torch body	SR 26 V FX	flexible / flexible	L = 65 mm	403P260800
20	Válvula / Valve	SR 9 V, SR 17 V, SR 20 V			405P172400
21	Válvula / Valve	SR 18 V, SR 26 V			405P262400
22	Junta torica / O-Ring				365P018047

## Empuñaduras en tubo / Handle tubes

▶ 30	Empuñadura en tubo lisa / Handle smooth	SR 9 V, SR 17 V	D=20,5 mm / L= 130 mm	H 100	402P171301
▶ 31	Empuñadura en tubo con nódulos / Handle ribbed	SR 9 V, SR 17 V	D=20,5 mm / L= 130 mm	H 100R	402P179264
▶ 32	Empuñadura en tubo lisa / Handle smooth	SR 18 V, SR 20 V, SR 26 V	D=27,5 mm / L= 154 mm	H 200	402P180801
▶ 33	Empuñadura en tubo con nódulos / Handle ribbed	SR 18 V, SR 20 V, SR 26 V	D=27,5 mm / L= 154 mm	H 200R	405P260801
▶ 34	Casquillo de inserción / Front insert	SR 20 V	D=21,5 mm / L= 27 mm		401P201360

## Equipamiento 11-19 / Equipment

▶ = Estándar

## Modelos con interruptor de láminas / Models with blade switch

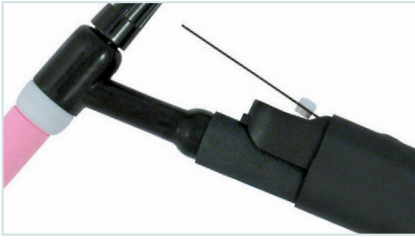

### Modelos con interruptor de láminas / Models with blade switch

#### Refrigerada por gas / Gas cooled



**TBi SR 9 (FX)**  
60% (10 min.)  
AC: 80 A  
DC: 110 A  
Ø 0.5-1.6 mm

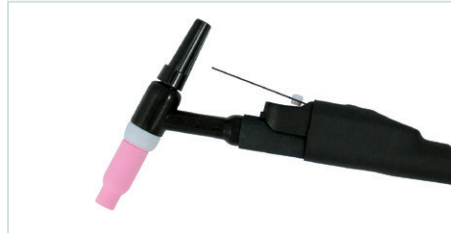

**TBi SR 17 (FX)**  
60% (10 min.)  
AC: 100 A  
DC: 140 A  
Ø 0.5-2.4 mm

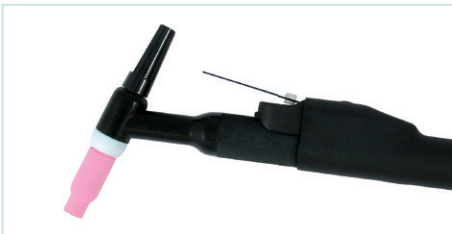

**TBi SR 26 (FX)**  
60% (10 min.)  
AC: 140 A  
DC: 200 A  
Ø 0.5-4.0 mm

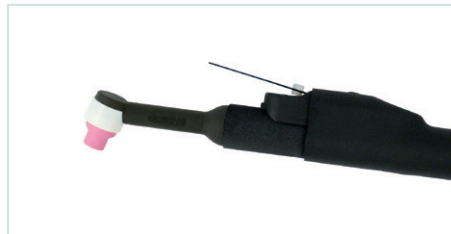

**TBi SR 24G**  
60% (10 min.)  
AC: 80 A  
DC: 110 A  
Ø 0.5-1.6 mm

#### Refrigerada por agua / Water cooled

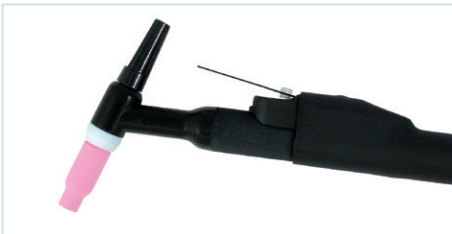

**TBi SR 18 (FX)**  
100% (10 min.)  
AC: 225 A  
DC: 320 A  
Ø 0.5-4.0 mm



**TBi SR 20 (FX)**  
100% (10 min.)  
AC: 160 A  
DC: 220 A  
Ø 0.5-3.2 mm

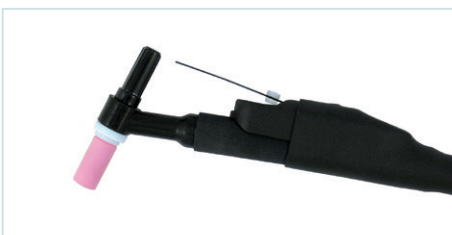

**TBi SR 21 (FX)**  
100% (10 min.)  
AC: 240 A  
DC: 340 A  
Ø 0.5-3.2 mm

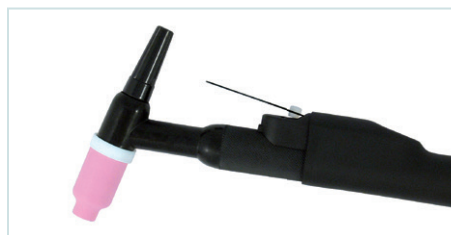

**TBi SR 400**  
100% (10 min.)  
AC: 315 A  
DC: 450 A  
Ø 1.0-4.8 mm

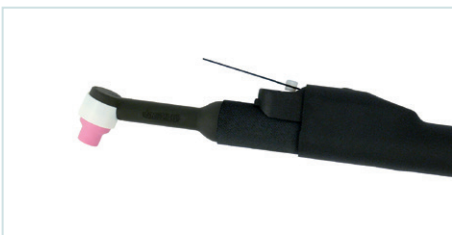

**TBi SR 24W (FX)**  
100% (10 min.)  
AC: 100 A  
DC: 140 A  
Ø 0.5-4.0 mm

Otros modelos disponibles a petición /  
Other models available on request

TBi SR 25G,  
TBi SR 25W





## Modelos con interruptor de láminas / Models with blade switch

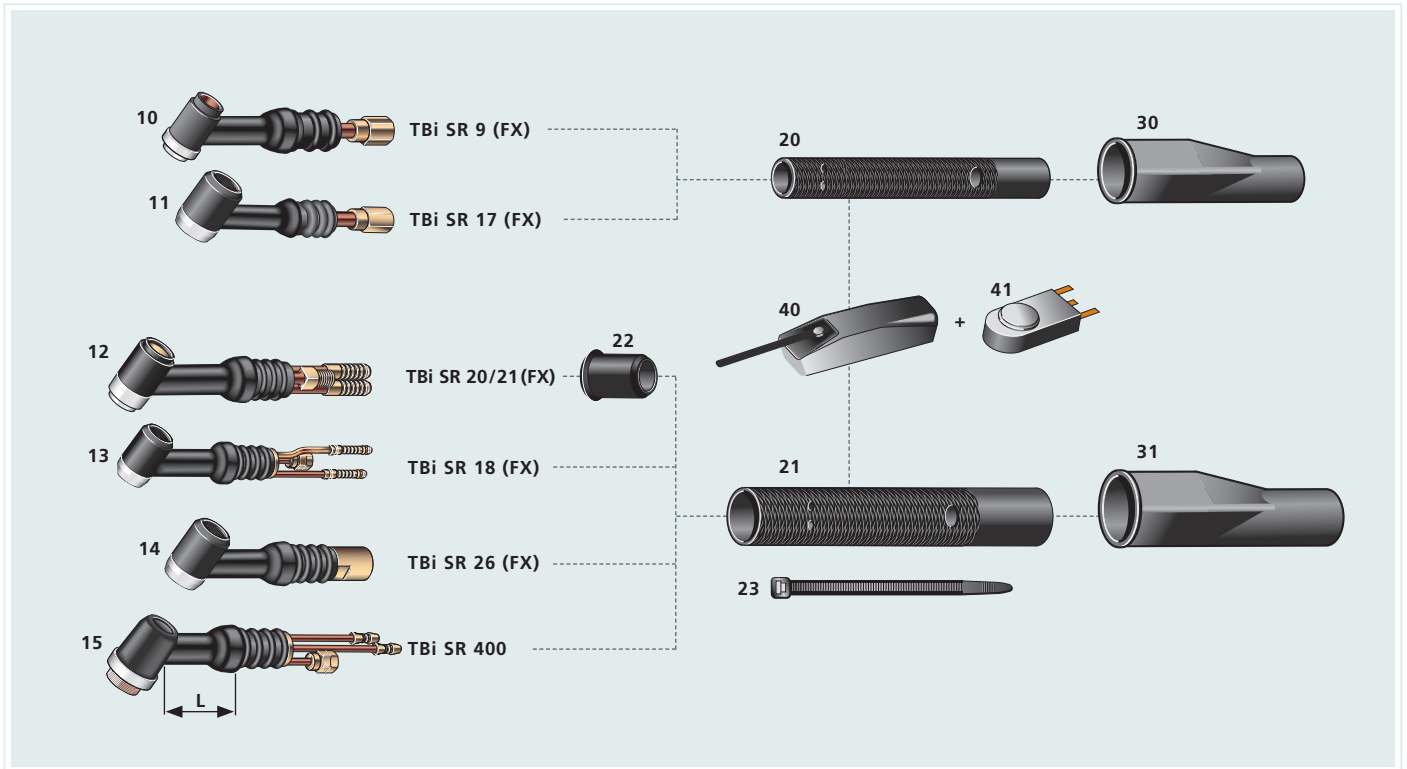

### Recambios / Spare parts

10	Cuello / Torch body	SR 9		L = 35 mm	405P090800
10	Cuello / Torch body	SR 9 FX	flexible / flexible	L = 35 mm	403P090800
11	Cuello / Torch body	SR 17		L = 50 mm	405P170700
11	Cuello / Torch body	SR 17 FX	flexible / flexible	L = 50 mm	403P170700
12	Cuello / Torch body	SR 20		L = 35 mm	405P200800
12	Cuello / Torch body	SR 20 FX	flexible / flexible	L = 35 mm	403P200700
12	Cuello / Torch body	SR 21		L = 35 mm	405P210800
12	Cuello / Torch body	SR 21 FX	flexible / flexible	L = 65 mm	403P210700
12	Cuello / Torch body	SR 21 FX-L	flexible / flexible	L = 115 mm	403P210701
13	Cuello / Torch body	SR 18		L = 55 mm	405P180700*
13	Cuello / Torch body	SR 18 FX	flexible / flexible	L = 55 mm	403P180700*
14	Cuello / Torch body	SR 26		L = 50 mm	405P260700*
14	Cuello / Torch body	SR 26 FX	flexible / flexible	L = 50 mm	403P260700*
15	Cuello / Torch body	SR 400		L = 50 mm	405P400800*

### Empuñadura en tubo / Handle tube

20	Empuñadura en tubo / Handle tube	SR 9, SR 17	D=20,5 mm / L= 130 mm	402P171302
21	Empuñadura en tubo / Handle tube	SR 18, SR 20, SR 26, SR 400	D=27,5 mm / L= 154 mm	402P180802
22	Casquillo de inserción / Front insert	SR 20		401P201360
23	Brida de sujeción / cable tie / Collier serre-câble			391P000069

### Manguito de interruptor / Switch boot

30	Manguito de interruptor / Switch boot	SR 9, SR 17		401P102051
31	Manguito de interruptor / Switch boot	SR 18, SR 20, SR 26, SR 400		401P102052

### Interruptor / Switches

40	Interruptor de láminas / Blade switch			402P101002
41	Interruptor Crouzet / Crouzet switch		plano / flat long life	SW-1 385P233009

\* No compatible con la empuñadura de precisión TBi / Not compatible with TBi Precision handle

### Cuellos y equipamiento de antorchas 11-19 / Torch bodies and equipment

# Antorchas automáticas / Machine Torches

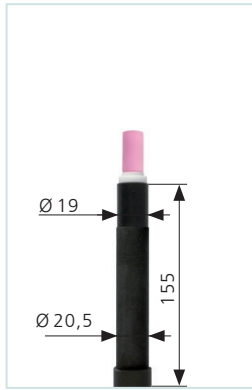

## TBi SR 9 P (Aut)

refrigerada por gas /  
gas cooled  
60% (10 min.)  
AC: 80 A  
DC: 110 A  
Ø 0.5-1.6 mm



## TBi SR 18 P (Aut)

refrigerada  
por agua /  
water cooled  
100% (10 min.)  
AC: 225 A  
DC: 320 A  
Ø 0.5-4.0 mm

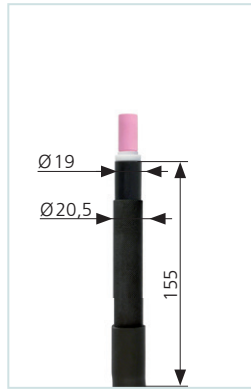

## TBi SR 20 P (Aut)

refrigerada  
por agua /  
water cooled  
100% (10 min.)  
AC: 105 A  
DC: 140 A  
Ø 0.5-3.2 mm



## TBi SR 26 P (Aut)

refrigerada por gas /  
gas cooled  
60% (10 min.)  
AC: 140 A  
DC: 200 A  
Ø 0.5-4.0 mm

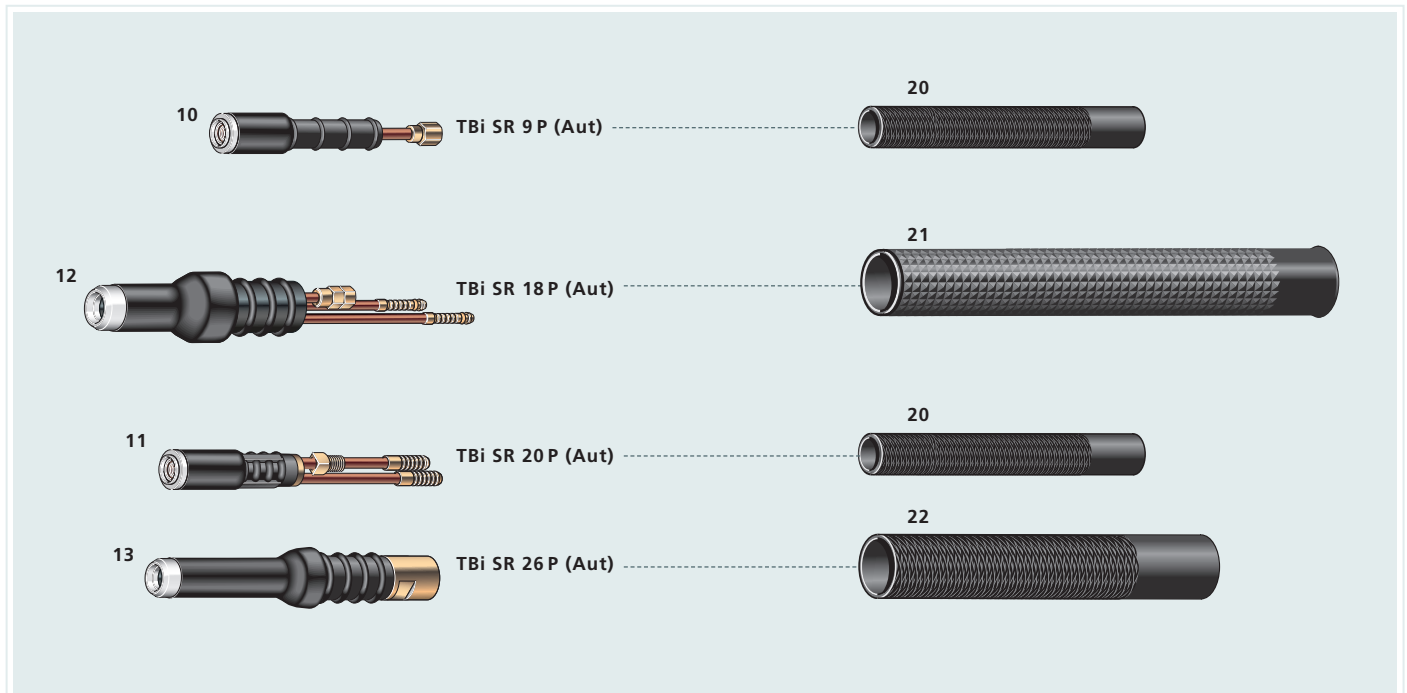

### Recambios / Spare parts

10	Cuello / Torch body	SR 9 P (Aut)	405P090900
11	Cuello / Torch body	SR 20 P (Aut)	491P200001
12	Cuello / Torch body	SR 18 P (Aut)	491P180001
13	Cuello / Torch body	SR 26 P (Aut)	405P260900

### Empuñaduras en tubo / Handle tube

▶ 20	Empuñadura en tubo / Handle tube	SR 9 P (Aut), SR 20 P (Aut)	D=20,5 mm / L=130 mm	402P171301
▶ 21	Empuñadura en tubo / Handle tube	SR 18 P (Aut)	D=35 mm / L=250 mm	491P180800
▶ 22	Empuñadura en tubo / Handle tube	SR 26 P (Aut)	D=27,5 mm / L=154 mm	402P180801

### Equipamiento 11+13 / Equipment / Equipment

▶ = Estándar



**Kits de consumibles para antorchas TBI WIG**  
Consumable kits for TBI TIG torches

para / for

**TBi SR 9, TBi SR 20, TBi SR 21**

para electrodos / for electrode	Kit estándar para / Std. Kit for	Número de art. / Part. no.
Ø 1.0 mm	-	401P200400
Ø 1.6 mm	<b>TBi SR 9</b>	401P200401
Ø 2.4 mm	<b>TBi SR 20 TBi SR 21</b>	401P200402
Ø 3.2 mm	-	401P200403

**Contenido de los kits / Content of the kits**

				
Estándar, L=30.0 mm	Estándar, L=20.6 mm	Estándar, L=25.4 mm		
No. 5 Ø 8.0 mm / 5/16"	401P201107	401P201001	401P200600	401P200300
No. 6 Ø 9.5 mm / 3/8"	401P201108	401P201001	401P200601	401P200300
No. 7 Ø 11.0 mm / 7/16"	401P201109	401P201002	401P200602	401P200300
No. 8 Ø 12.5 mm / 1/2"	401P201110	401P201003	401P200603	401P200300

para / for

**TBi SR 17, TBi SR 18, TBi SR 26**

para electrodos / for electrode	Kit estándar para / Std. Kit for	Número de art. / Part. no.
Ø 1.0 mm	-	402P170400
Ø 1.6 mm	<b>TBi SR 17</b>	402P170401
Ø 2.4 mm	<b>TBi SR 18 TBi SR 26</b>	402P170402
Ø 3.2 mm	-	402P170403
Ø 4.0 mm	-	402P170404

**Contenido de los kits / Content of the kits**

				
Estándar, L=47.0 mm	Estándar, L=47.0 mm	Estándar, L=50.0 mm		
No. 4 Ø 6.5 mm / 1/4"	401P170907	401P180999	402P170500	402P170200
No. 5 Ø 8.0 mm / 5/16"	401P170908	401P180999	402P170502	402P170200
No. 6 Ø 9.5 mm / 3/8"	401P170909	401P181000	402P170503	402P170200
No. 7 Ø 11.0 mm / 7/16"	401P170910	401P181001	402P170504	402P170200
No. 8 Ø 12.5 mm / 1/2"	401P170911	401P181002	402P170505	402P170200

## Aportador de hilo frio / TIG-Cold-Wire-Feeding

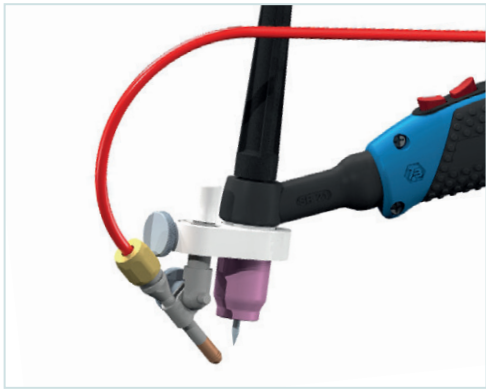

**Aportador de hilo frio /**  
*TIG-Cold-Wire-Feeding*



Para / for **TBi SR 9, TBi SR 20, TBi SR 21**

**481P101023**

Puede obtener mas detalles en la documentación técnica /  
*More details can be found in the technical documentation*



Para / for **TBi SR 17, TBi SR 18, TBi SR 26**

**481P101024**

Puede obtener mas detalles en la documentación técnica /  
*More details can be found in the technical documentation*

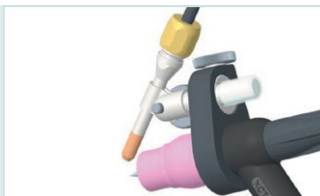

Para / for **TBi XCT 200W, TBi XCT 400W**

**481P101028**

Puede obtener mas detalles en la documentación técnica /  
*More details can be found in the technical documentation*

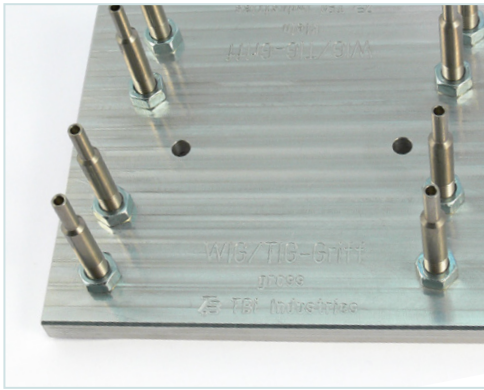

Accesorios TBI TIG /  
TBI WIG/TIG Accessories

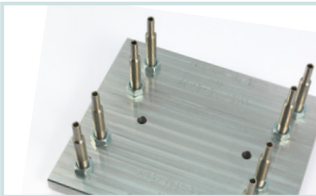

La herramienta de montaje TBI WIG/TIG  
Es adecuado para ambos tamaños de la carcasa de la  
empuñadura TBI Precision.

WKZP200000

La antorcha se puede colocar y fijar con precisión con la  
ayuda del dispositivo de montaje. Facilita todo el trabajo  
de montaje en la carcasa con la empuñadura abierta, que  
se puede llevar a cabo de forma segura y profesional de  
esta manera.

*TBI TIG assembly fixture  
is suitable for both sizes of TBI Precision handle.  
TBI TIG torches can be precisely positioned and fixed in the  
mounting fixture. It facilitates all assembly work on the open  
handle, which can be done safely and professionally in this way.*



Electrodos de tungstenos TBI  
- Cumplen con DIN EN ISO 6848  
- Calidad de un fabricante europeo  
Disponibles en los colores:  
Oro Plus, Gris, Verde y Azul

Ver folleto separado  
„Electrodos WIG“ o en  
nuestra página WEB:  
TBI-industries.com

*TBI Tungsten Electrodes  
- Conform to standard DIN EN ISO 6848  
- Quality from a European manufacturer  
Available colors:  
Gold Plus, Gray, Green and Blue*

*See separate flyer  
„TBI TIG electrodes“  
or on our WEB page:  
TBI-industries.com*

Ready for Tomorrow.

© 2021 TBI Industries GmbH. Todos los derechos reservados. Sujeto a cambios técnicos. No está permitida la copia o reproducción, tampoco parcialmente. / All rights reserved. Subject to change without notice. Excerpts and reprints not permitted. / Tous droits réservés. Sous réserve de modifications techniques. Copie/reproduction même partielle non autorisée. Nr. DOKP121014, 02/2021.

TBI Industries GmbH  
Ruhberg 14  
35463 Fernwald-Steinbach  
Germany

Tel. +49 6404 9171-0  
Fax. +49 6404 9171-58  
[www.tbi-industries.com](http://www.tbi-industries.com)  
[info@tbi-industries.com](mailto:info@tbi-industries.com)