



Gardenhouse24.co.uk

TIMBER GARDEN PRODUCTS

General assembly instructions

for 28–90mm timber products



Dear Client

Thank you for purchasing the high-quality timber products of Gardenhouse24. Your new timber product is manufactured from slow-growing and CE-certified Nordic wood by the craftsmen of Astel Garden, the most experienced wooden house manufacturer in the Baltic States.

The fact that this product has made its way to you is an assurance of quality. All of our products go through an inspection process before being packaged and shipped out. We have the FSC certificate for the production and sale of garden houses.

Your new timber product is made using the most sustainable construction material available today - wood. Some rough edges, and plane marks on the backs of roof boards or wall beams are not signs of inferior quality but the result of the production processes. These are not considered to be defects. Some resin pockets, cracks, ingrown knots, or small fissures where these exist are also not classed as being defects but something that is unique to every tree from where they have made their way into your product. Rest assured that they do not compromise the structure's quality and are also not considered to be defects.

The nature of the wooden material makes every timber product unique in its look and texture, and also poses some challenges in regards to transportation, storage, installation, and maintenance. This is why we would like you to follow the installation instructions step-by-step and very carefully in order to avoid any irreversible damage.

This is a general assembly instruction manual that includes several ways of completing specific installation processes. For detailed information regarding your specific product, please follow the manual that is provided with the cabin itself.

PLEASE READ THE FOLLOWING INSTRUCTIONS IN FULL BEFORE STARTING THE ASSEMBLY



It may be tempting to try and explore ways of completing the assembly in an easier way, but we assure you that following the assembly instructions on a step-by-step basis is more often than not the fastest way of completing your product safely because it helps you to avoid errors and damage that may slow you down in the process.

Furthermore, if you have no prior experience in construction work, we strongly advise you to leave the installation work to a professional. Errors that may be made during the installation process may lead to injury or product damage which is expensive to repair and voids our 5-10 year warranty (depending upon the product).

Please note that the pictures and illustrations are just part of a general installation guide that can apply to many of our products such as, for example, the installation of wall beams or floors applying to all of our products, although the quantity of materials required does vary from product to product.

To be sure of the quantity of parts you will need, inspect the parts list thoroughly and make sure you have everything you need before you start work.

If some extra boards are left over after the completion of the product then don't worry. We sometimes include extra boards to make the package solid and compact. If you still feel that the materials that have been included should be installed somewhere in your cabin, please consult our customer support team.

Table of contents

Preparation works	4
Assembly	8
Wall bearers	8
First row of wall beams	9
Wall beams	11
Doors and windows	12
Threaded bars	15
Storm braces	16
Gables	17
Rafters	18
Roof boards and roof covering	19
Roof with parapets	23
Floor boards	25
Terraces	27
Terrace canopy support posts	29
Wooden building maintenance	30
After-sales service	32



Preparation works

1. 1. Inspect the installation kit thoroughly

After the product has been delivered in a flat pack, we advise you to inspect the installation kit thoroughly to check that all parts are present and correct. **Open the package on the day of installation.** We provide a detailed parts list with the products and recommend that you double-check to make sure that the kit is complete before you start any assembly work. Every part on the list has a description, dimensions, and quantity, with a drawing of its appearance.

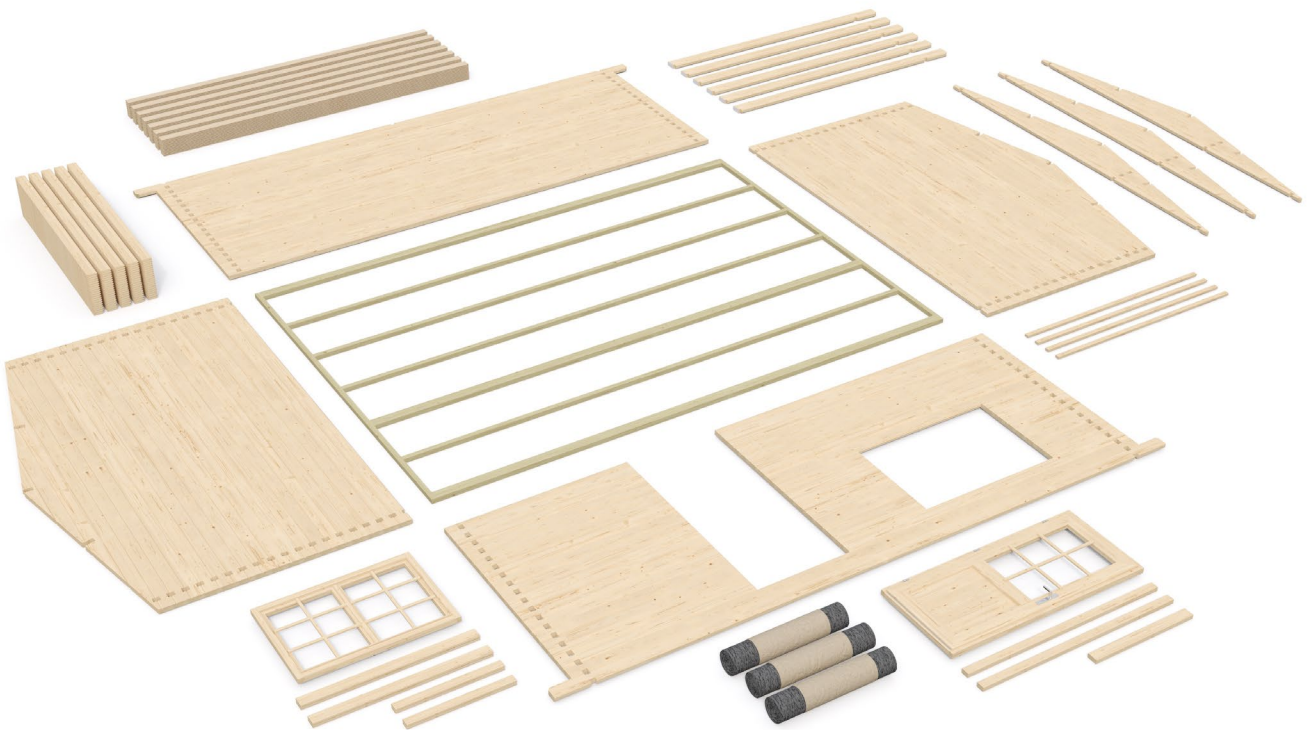

If you find any defects then please let us know. We'll be more than happy to replace any parts that are not up to standard. If you find any defects or parts that have been damaged during transportation, please take a picture of the parts as soon as possible and forward them to our customer support team as soon as possible. If you find that you are not satisfied with the product then take a look at our returns policy on our website:

<https://gardenhouse24.co.uk/warranty-quality-guarantee>



When you have ensured that all the parts are present and up to expectations, place them on a pallet or any other clean dry surface to avoid staining the wood. Untreated wood especially is very difficult to clean afterwards; hence we advise you to avoid staining it in the first place.

2. Read through the manual carefully

When you have made sure that you have all the components that are necessary for the installation, please read through the manual. This makes sure that you are fully prepared for all the steps of the installation process and can call for additional help if you need it. If you decide during the read-through that you need professional help, we strongly advise you to use it.

The installation manual describes the assembly on a step-by-step basis, and has drawings to illustrate the processes and the positions of the wooden details in relation to each other. We have written the instructions in easy-to-understand terms to avoid any misunderstanding that may lead to you harming yourself or the product.



If any questions arise during the read-through or during the installation process, please contact our customer service team and we'll help you out!

3. Make sure you have all the tools necessary for assembly

Now that you have the complete installation kit and you're familiar with the assembly instructions, make sure that you have all the tools necessary to complete the installation work. Depending on the product the specialist tools required may vary, but the basic toolkit includes:



Drill with a cross head screwdriver



Drill with a set of installer bits



Work gloves



Hammer



Utility knife



Stepladder



Water level



Tape measure



Pliers



Rubber mallet



Saw



Adjustable wrench

4. The foundation – the basis of your building

All of our products need a flat, level foundation to be installed upon. While some of the smaller models up to 16m² in ground space can be installed on an impregnated wooden post foundation, other products need either a strip foundation, a concrete slab foundation, or other variations of concrete foundations. The best type of foundation for most of our timber products is an insulated concrete slab foundation because it provides the greatest levels of stability and the best thermal insulation qualities.

Whichever form of foundation you choose, please make sure that it is flat, level, and stable throughout. A uniform foundation helps to make sure that the assembly goes smoothly and all the parts fit together, and that the building will last at least as long as we have promised. Crooked and bad quality foundations may lead to problems while fitting and operating doors and windows, but may also result in the twisting of wooden parts and even premature rotting.



The type of foundation that may be suitable for your product depends upon the soil, the structure, and of course your budget. Our assembly crew can construct a sufficient base or foundation for you. In the case of wooden post foundations we strongly advise you to use our construction services. You can order the construction with a post foundation when ordering the product itself. In the case of concrete foundations we are more than happy to help with constructing a sturdy, level base. Please ask for a quote. You can also use the services of a construction company of your choice, in which case we can provide you with the blueprints with exact measurements for the base for your product.

5. Get sufficient help before you begin the installation

While almost all of the components are manufactured exactly to requirements and are marked in a way that makes them easy to spot and install in the right place, the assembly still needs some construction experience in order to be carried out successfully and professionally. Some of the materials needs to be cut, or cut to a specific measurement during the installation, while general construction knowledge will help to avoid simple mistakes that may affect or compromise the quality of the building. That's why we offer a specialist installation service that will carry out the work for you, but you can also feel free to hire a local professional to do the assembly work for you.

The assembly of our products is a two-person job. If you decide to install the product alone, Gardenhouse24 will not be responsible for any injuries or harm done to the product.



There is a reason why even some of the most simple pieces of furniture have a requirement for two persons for the assembly. Some of the larger and heavier parts need at least two people to be able to lift them safely and need some adjusting and fiddling to fall into place.

If you do decide to install the product yourself then please seek appropriate help beforehand. If you can't find anyone to help you with the installation, we strongly advise you to use professional services such as, for example, our specialist installation service.

If you have any doubts or questions during the installation process, feel free to contact our customer support centre.

6. Plan the installation work for the right time

We strongly advise you not to leave the details contained in the packaging exposed to the elements. This is why the packaging should be opened on the day of installation. Check the weather report and, if possible, **plan the installation for a dry, sunny day. Wind, snow, ice, or rain may damage the product.**

Assembling your timber product

With all the preparation work done, now is the time to start the actual assembly of the product. We strongly recommend that you follow the steps described in the installation manual on a step-by-step basis because this is usually the fastest way to complete the installation correctly. This way you'll avoid common mistakes that may lead to problems and stoppages during installation, and may also lead to you damaging the product.

While it may be tempting to cut corners, please follow all the steps in the correct order.

Wall bearers

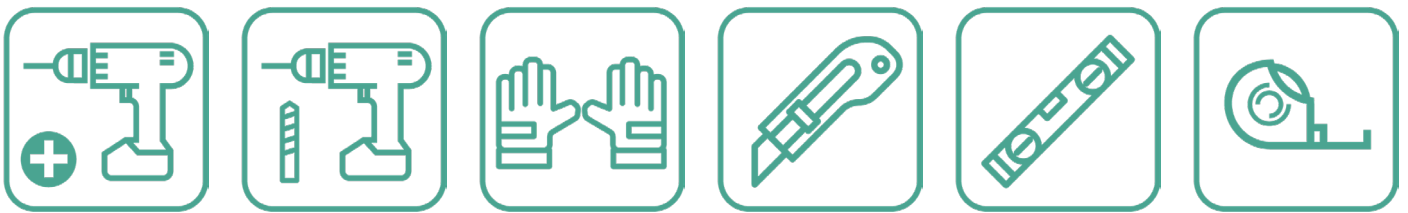

The first job after a sufficient foundation is in place is to install the impregnated wall bearers. **But before laying down the wall bearers, a moisture barrier needs to be installed between the foundation and the bearers themselves** (use roofing felt or a special moisture barrier that is available from DIY stores). The moisture barrier will add an additional level of protection to your timber product, keeping the moisture away from the wooden construction which will prevent premature rotting. 

Please note that the moisture barrier is not included as standard in the installation kit.



When the moisture barrier is installed, place the bearers on the foundation according to the structure plan. Make sure that the diagonals of the wall bearers are equal and that the bearers lay flat and straight on the foundation. If done correctly, all of the corners for the wall bearers should be at a 90 degree angle.

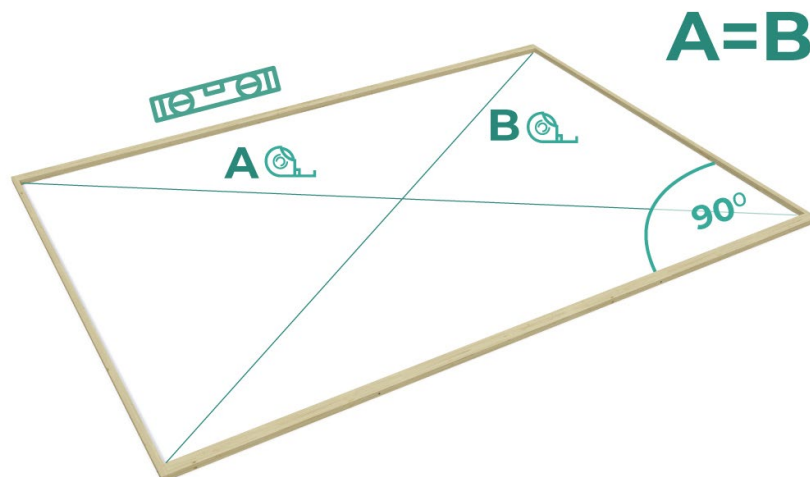

When you have made sure that the bearers are positioned correctly and match the cabin measurements, secure the outer planks together with screws. After that assemble the whole foundation frame. Make sure that the frame is level and well-balanced to ensure a trouble-free installation.

When the wall bearers have been properly assembled, screw the bearers into the foundation with anchor screws.

Before affixing any screws we recommend pre-drilling holes to avoid the risk of splitting wooden details.



The first row of wall beams

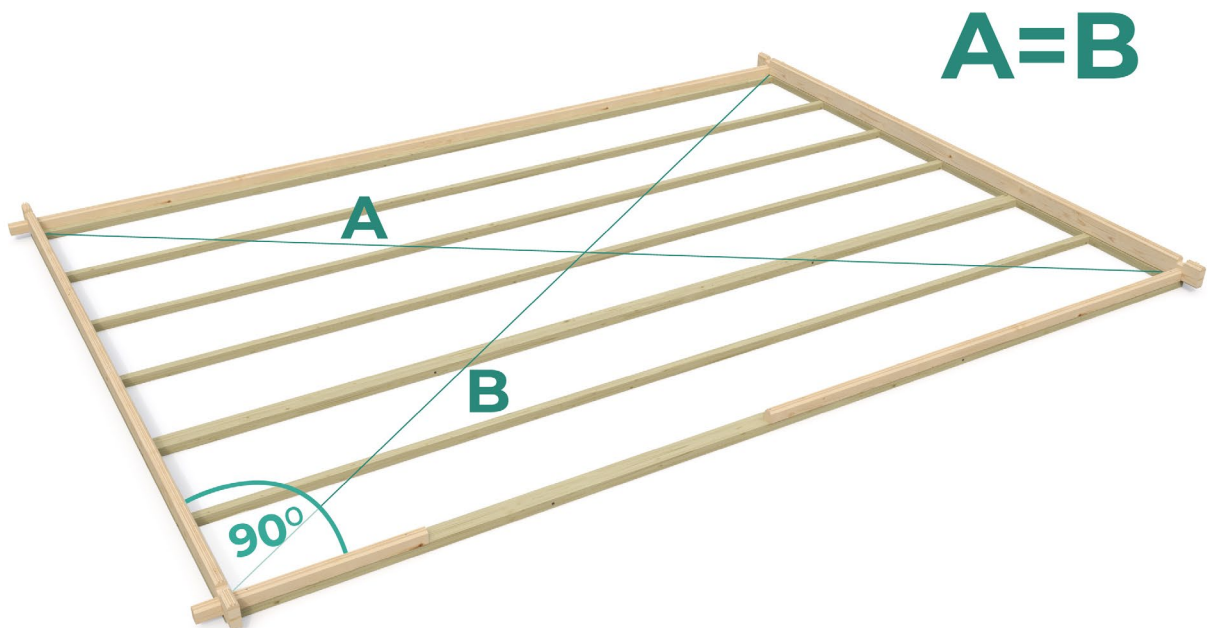

When the wall bearers are in place and are affixed to the foundation, it is time to install the first row of wall beams. Place the wall beams directly onto the bearers. When installed correctly, the edge of the bottom row should reach 5mm over the edge of the wall bearers. **Please make sure that the gap between the first row wall beams and the foundation (or the ground) is at least 45mm.**



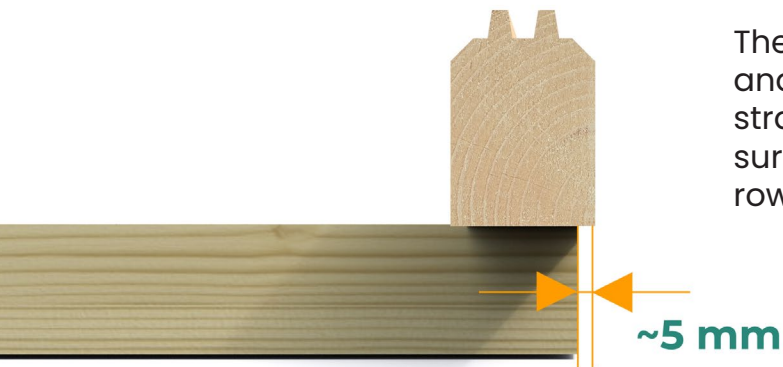

Then affix the first row of wall beams to the wall bearers with screws.

NB: Only the first row of wall beams is secured with screws.

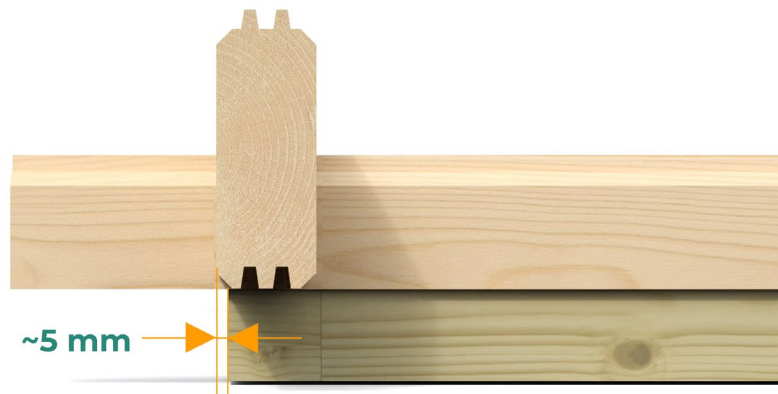

Installing wall beams



Now, when the first row of wall beams has been installed and affixed to the wall bearers, it's time to install the remaining wall beams. Please follow the instructions carefully, so that every piece ends up in the right position. **Please note that the remaining wall boards are not secured with screws.** Some of the products have metal rods that need to be installed into pre-drilled holes after the wall installation is complete, and some products have adjustable storm braces that secure the construction parts together.



Please note that the wall beams have to interlock at the ends, but the tongues and grooves of the boards have also to interlock along the sides.



If necessary, use a rubber mallet and a wooden tile to gently manipulate the wall beams into place. Never hit the tongue and groove ends with a metal hammer - wood deforms easily and this way you'll compromise the integrity of the structure, while also causing damage that may lead to trouble when fitting together the components. **When you have installed six rows of wall planks, measure the diagonals once again to make sure they are equal.**

Installing doors and windows



There are two correct ways of installing the doors and windows for our timber products:

1. During the installation of wall beams
2. When the wall installation has been completed

Installing doors and windows during the installation of wall beams

Our windows have four lathes inside and four lathes outside. Our doors have three lathes inside and three lathes outside because the doors don't need a lathe at the bottom.

To install the doors and windows during the installation of wall beams, secure both the inside and outside lathes to door and window frame with screws.

Install the doors and windows into the walls at the time indicated in the instruction manual to ensure that they fit safely, and then finish off the installation of wall beams.

Installing doors and windows after the walls have been completed

To install the doors and windows after the walls have been completed, initially secure only the outer lathe to the window and door frames. Then secure them in place and after that secure the inner lathe.



Please make sure that you secure the door and window lathe to the door and window frames – not the wall beams. Securing the door and window lathe directly to the wall beams won't allow the wood to contract or expand naturally, leading to the creation of gaps and poor thermal insulation.

Window installation:

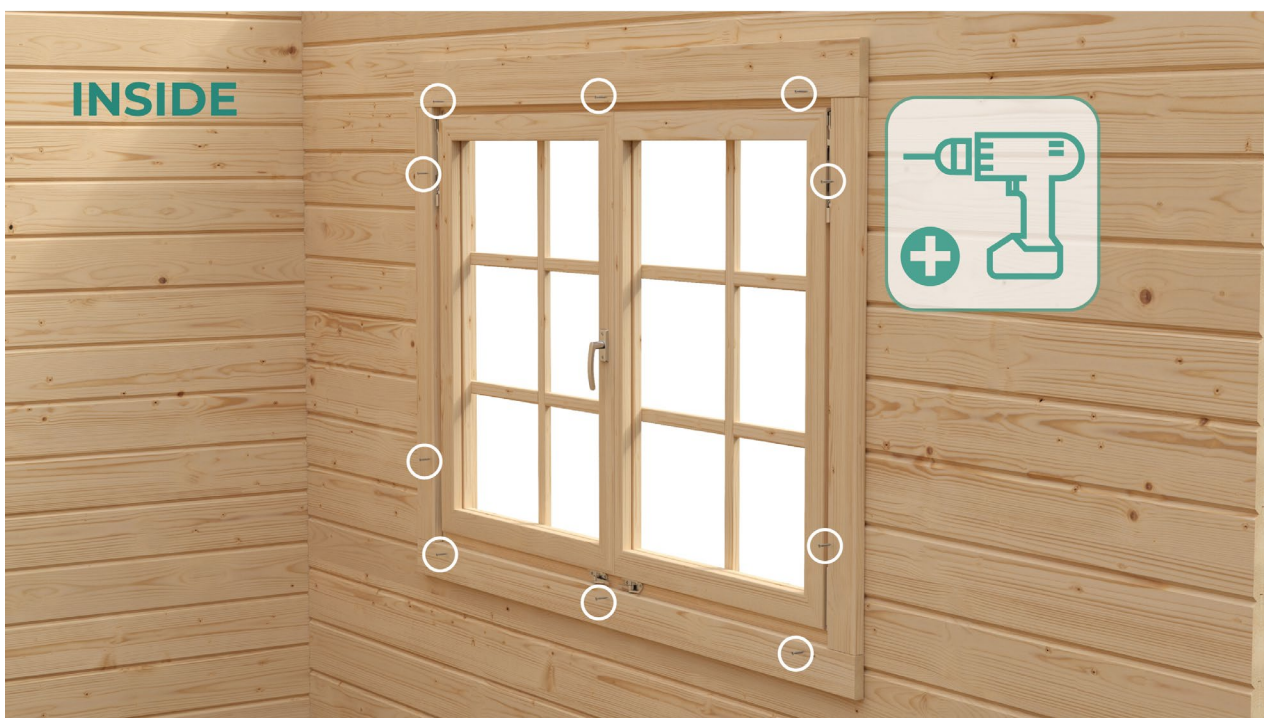
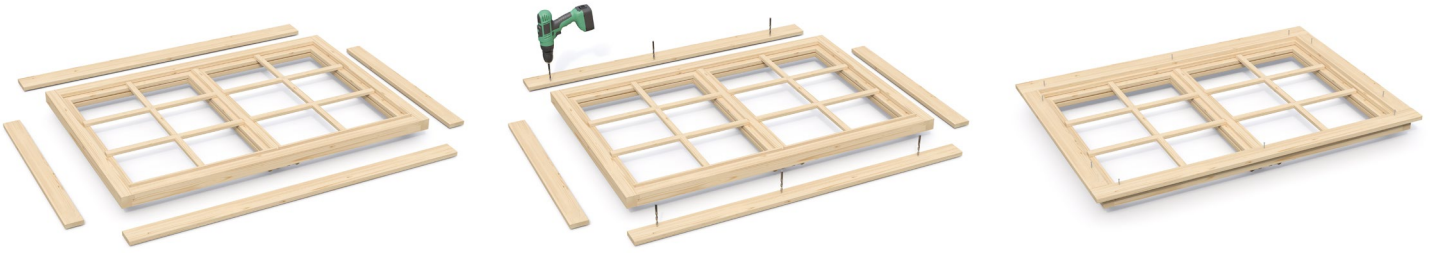

Door installation:



Please note that the holes for windows and doors are a few centimetres bigger than the door and window frames. These gaps allow the wood to settle during the first year after installation and should disappear over time. **Please do not fill the gaps with expanding foam or any other insulating agent during the first year after installation!**



Installing threaded bars

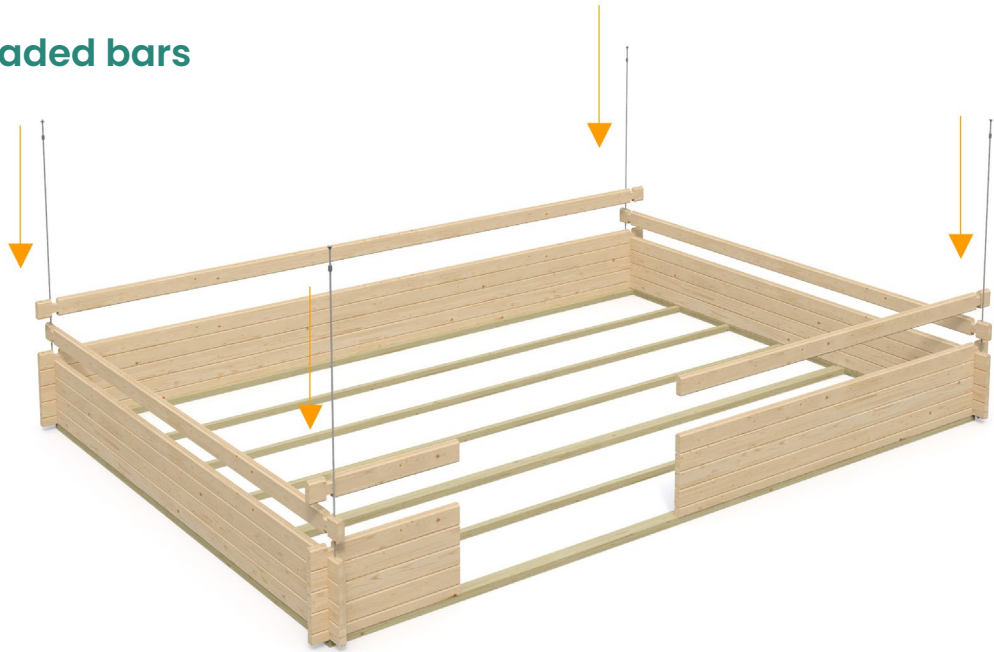

Most of our products have threaded bars that need to be installed into the pre-drilled holes in the walls from top to bottom.



The threaded bars are for wind protection and will be secured from the top and bottom. The top of the threaded bars should be secured with an impact nut and the bottom with a washer and nut.



Please leave the nut finger-tight to allow for the contraction and expansion of the wooden details during the settling period. The nuts should be tightened regularly. For more information on maintenance have a look at www.gardenhouse24.co.uk/wooden-building-maintenance

Installing storm braces

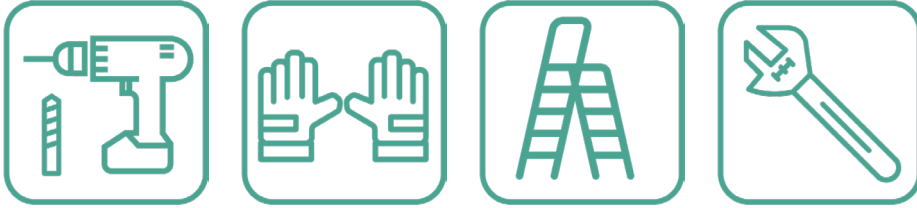

If your product comes with wooded storm braces, please install them after completing the wall installation. For that you need to measure the location of the storm braces and mark the drill holes. The top of the storm brace should be attached to the gables and the braces have to be cut into correct lengths if needed. Drill the holes and fasten the storm braces with washers and nuts. **Like threaded bars, the bottom nut should be finger-tight to allow for the contraction and expansion of wooden details.** If it is fastened too tightly then the wood won't settle and this will lead to problems in the future.

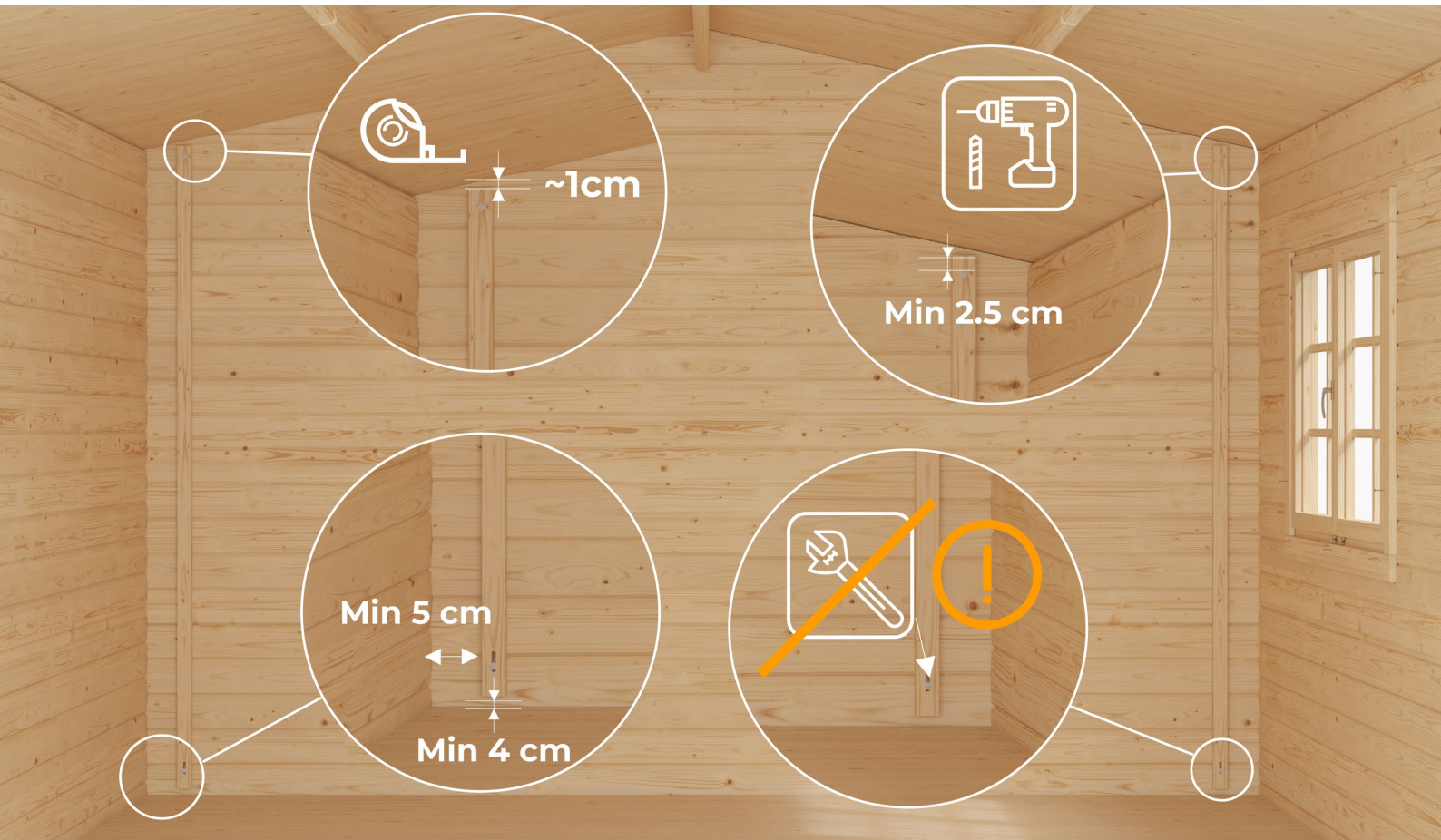

Installing gables

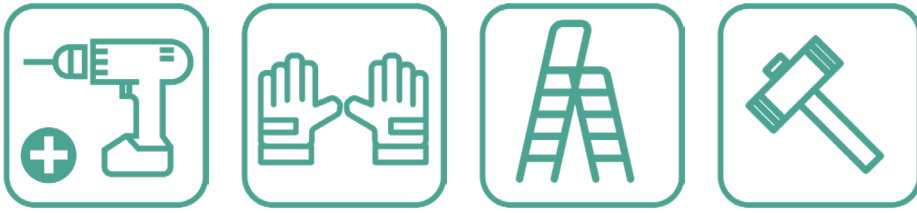

After the walls have been assembled, it's time to install the gables. The gables should always be installed as a whole, so if your product came with the gables in an unassembled state, please assemble them with screws before installation onto the building.

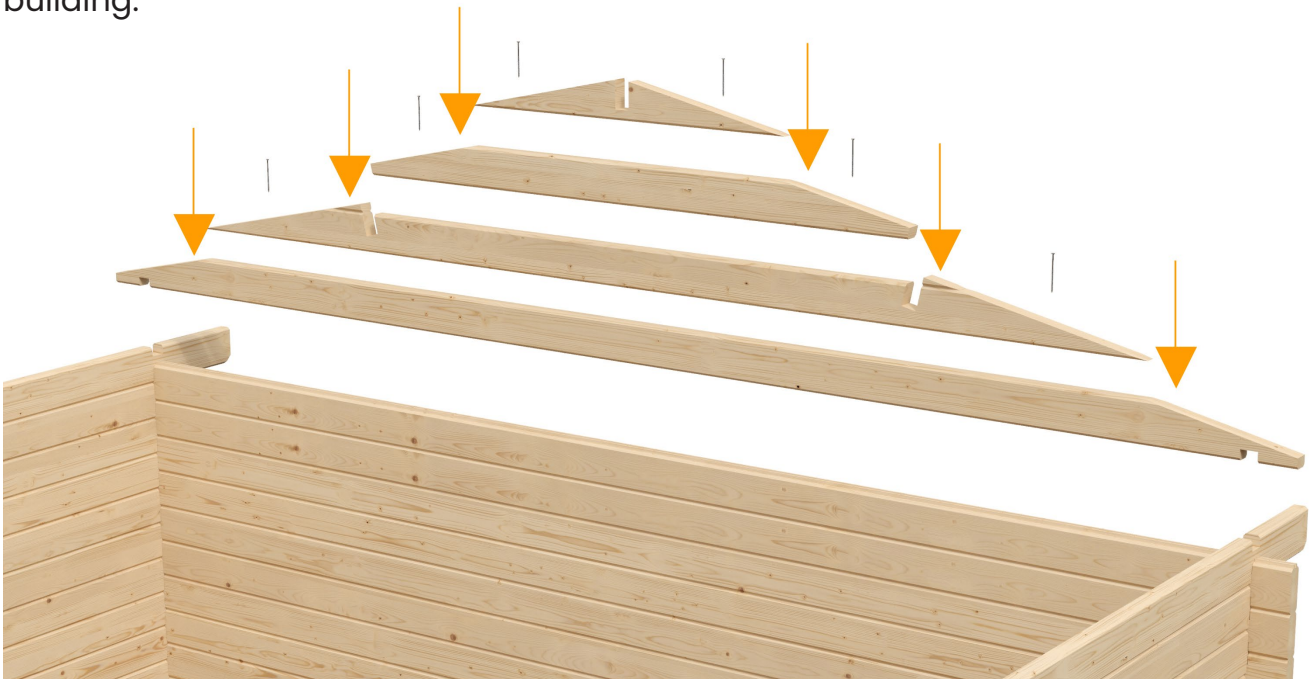

Attach the gables on top of the walls with the screws provided in the installation kit before moving on to the rafters.

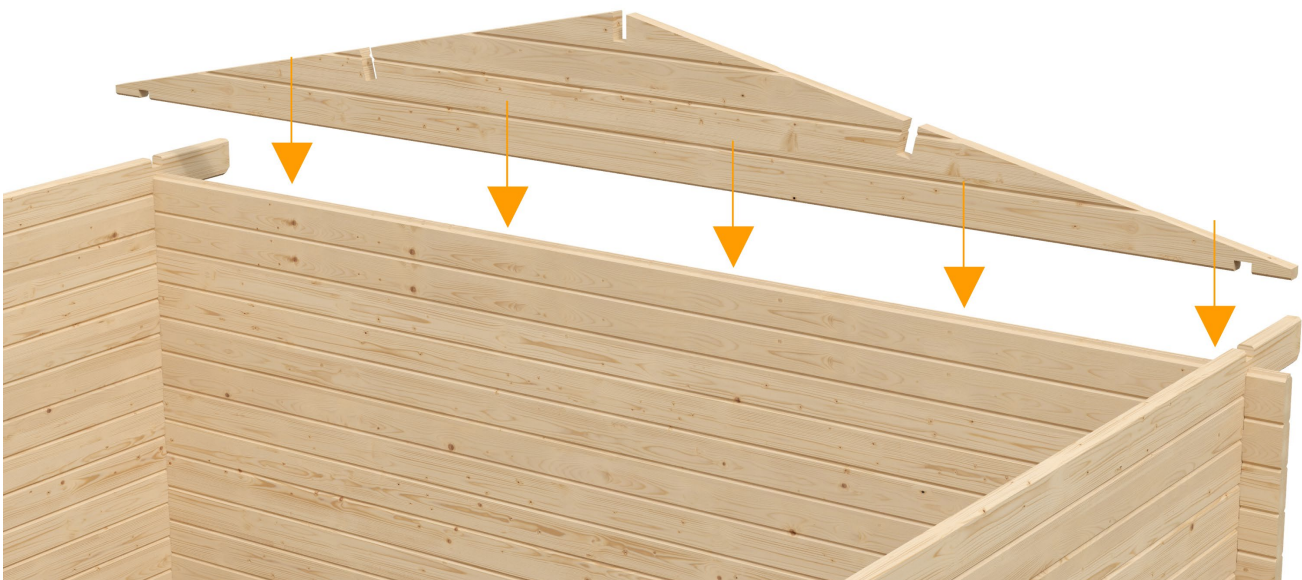

Installing rafters



The rafters should be installed into the mounting spaces that have been pre-cut into the gables. The tops of the rafters should be level with the top of the gable. If needed, use a hammer block and a rubber mallet to fit them accordingly. When in place, secure the rafters to the gables with screws.

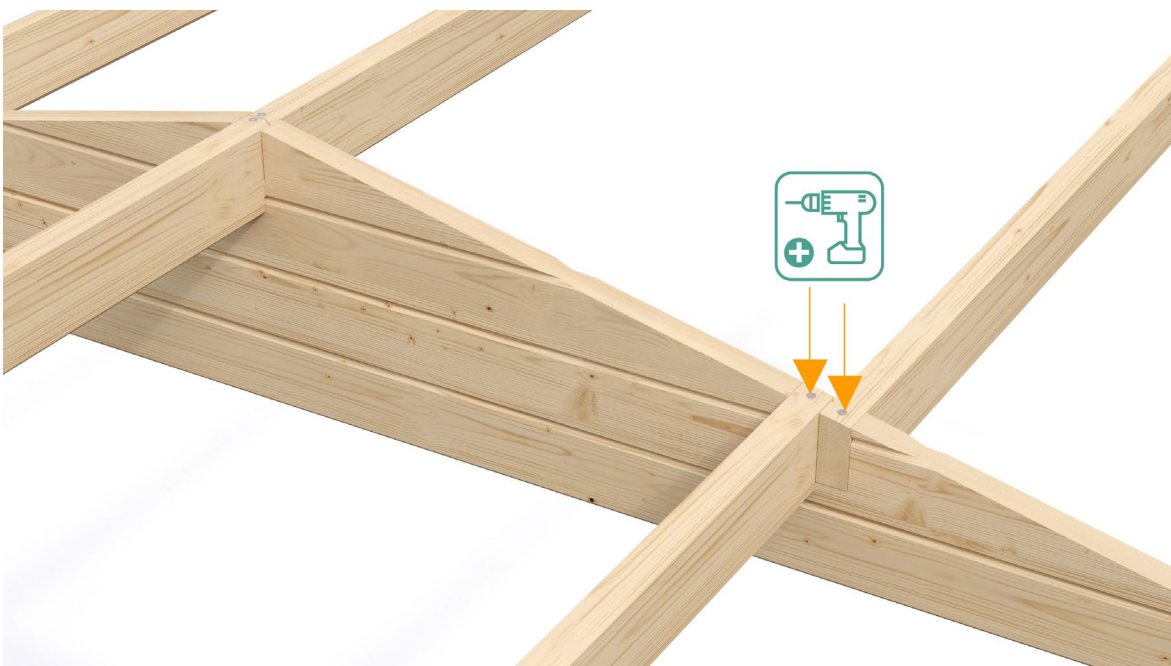
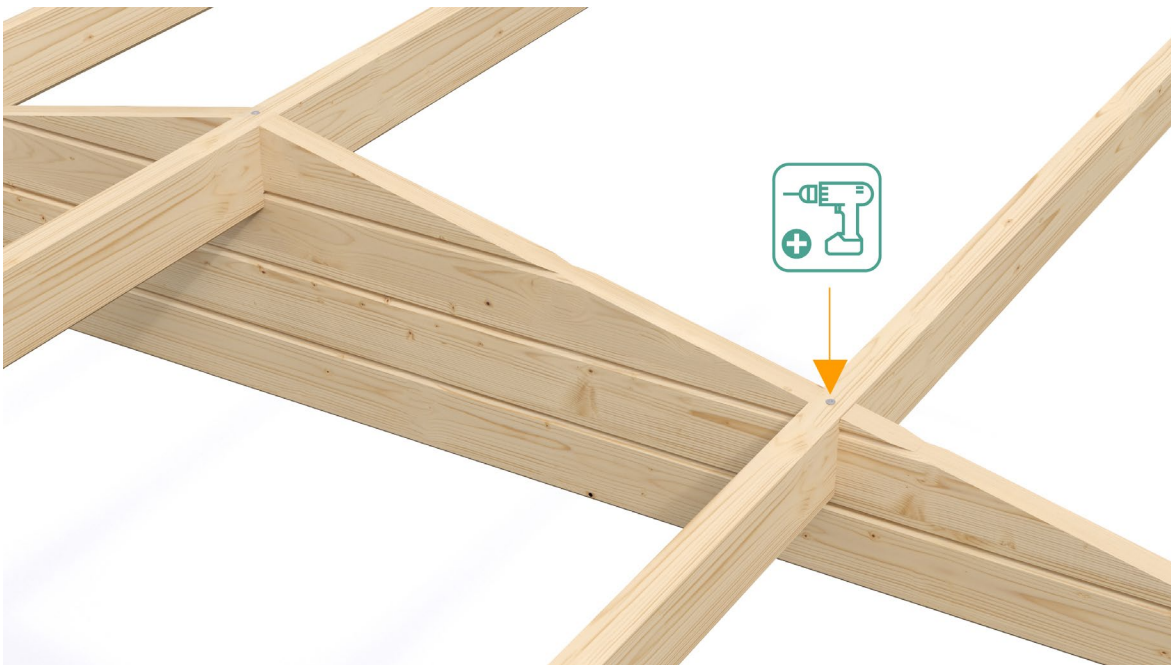

Installing roof boards



You should start installing the roof boards from the front of the cabin and working towards the back. Use a safe and stable ladder such as, for example, a stepladder, and secure the roof boards to the gables, side walls, and every rafter with nails.



The roof boards should end evenly with the rafters. If needed, measure and cut the last roof board so it will end evenly in line with the ends of the rafters.

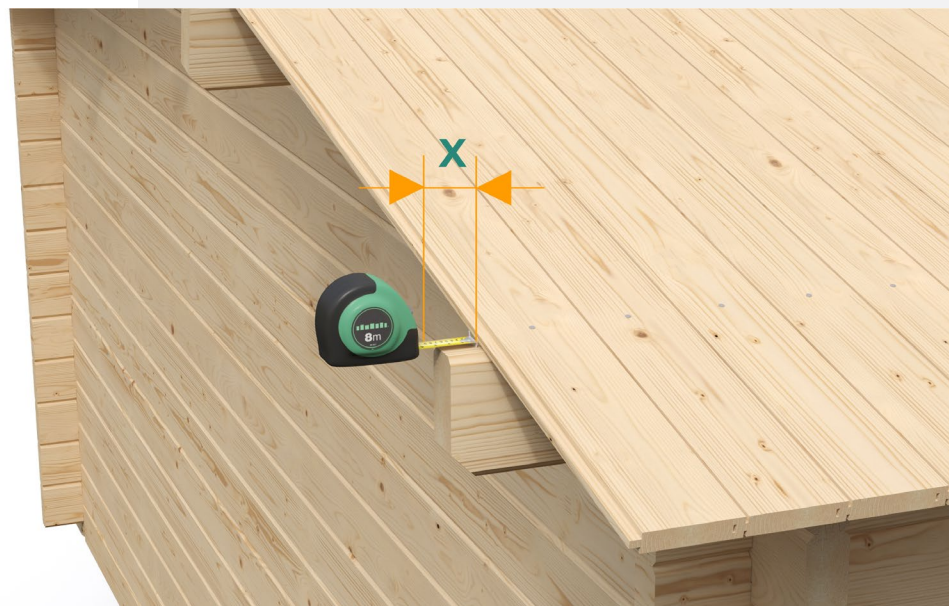
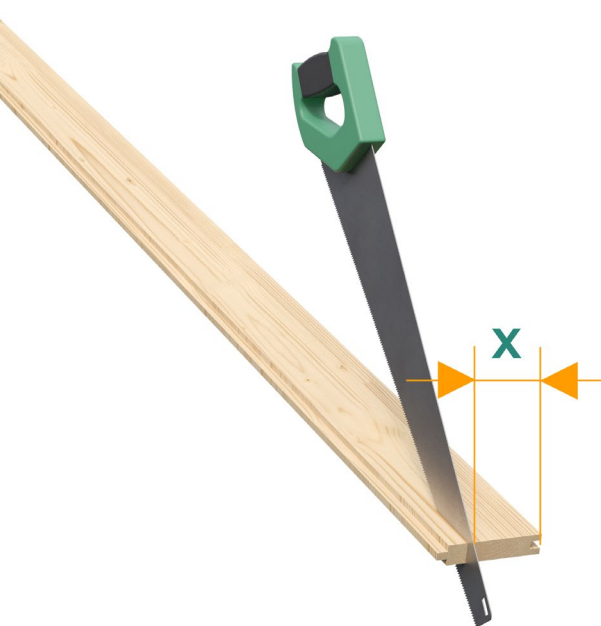

Installing the roof covering

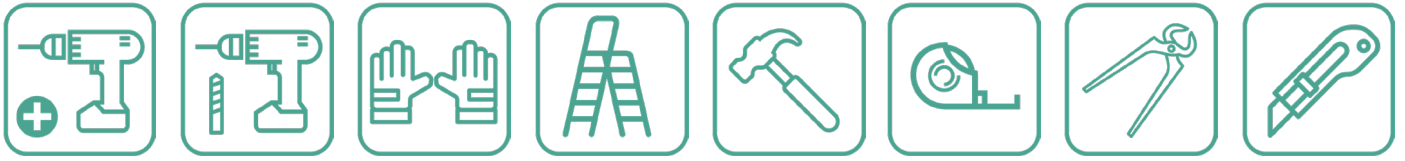

First install the eave reinforcements and the eaves themselves onto the sides of the roof boards.



Some of our products have bitumen shingles included in the installation kit, and for those models that do not have bitumen shingles as standard, you can buy them as additional items from our store.



DO NOT leave the roof board uncovered because wood itself is not a sufficient roof covering and will not protect your product from rain, hail, snow, and other damage.



Follow the guidelines presented with the shingle packages for correct installation to make sure you use the shingles correctly and that you will be able to cover the whole roof with the shingles that you have ordered.

The incorrect way of installing shingles:

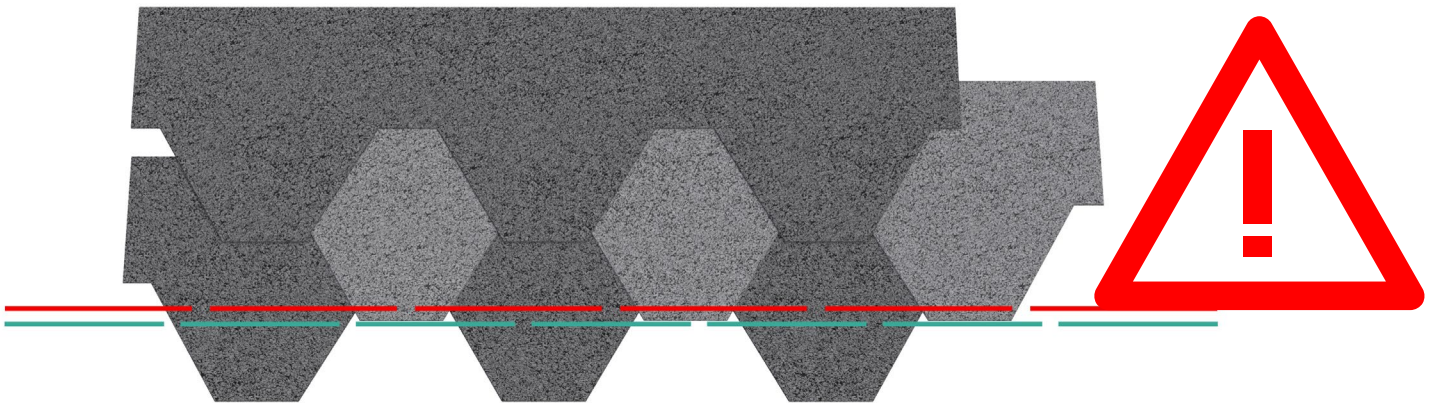

The correct way of installing shingles:

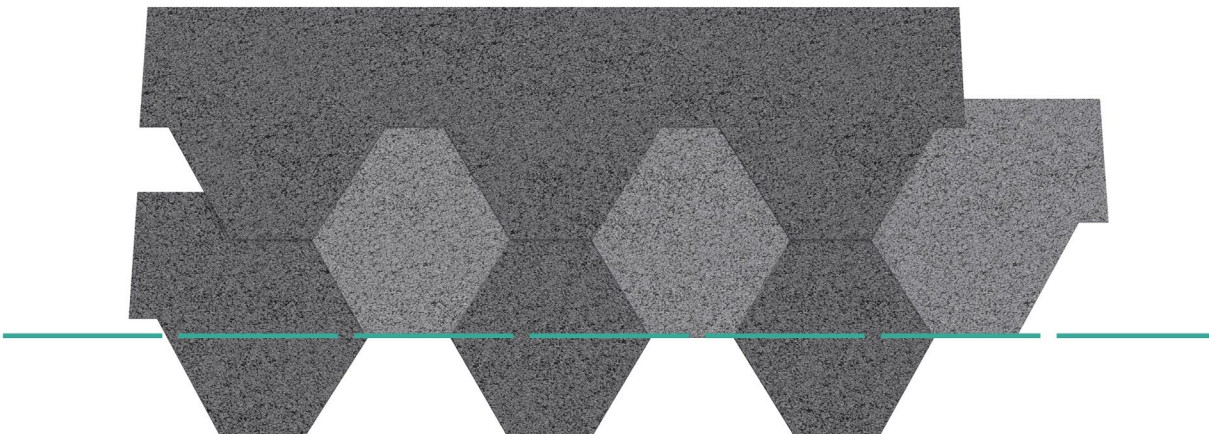

When you have finished installing the roof covering, attach the ridge boards with screws at the end of every rafter. The top edge of the ridge boards should be level with the upper edge of the roofing. Then install the roofing bars on top of the roof covering material and ridge boards, fastening them to the ridge boards with nails.

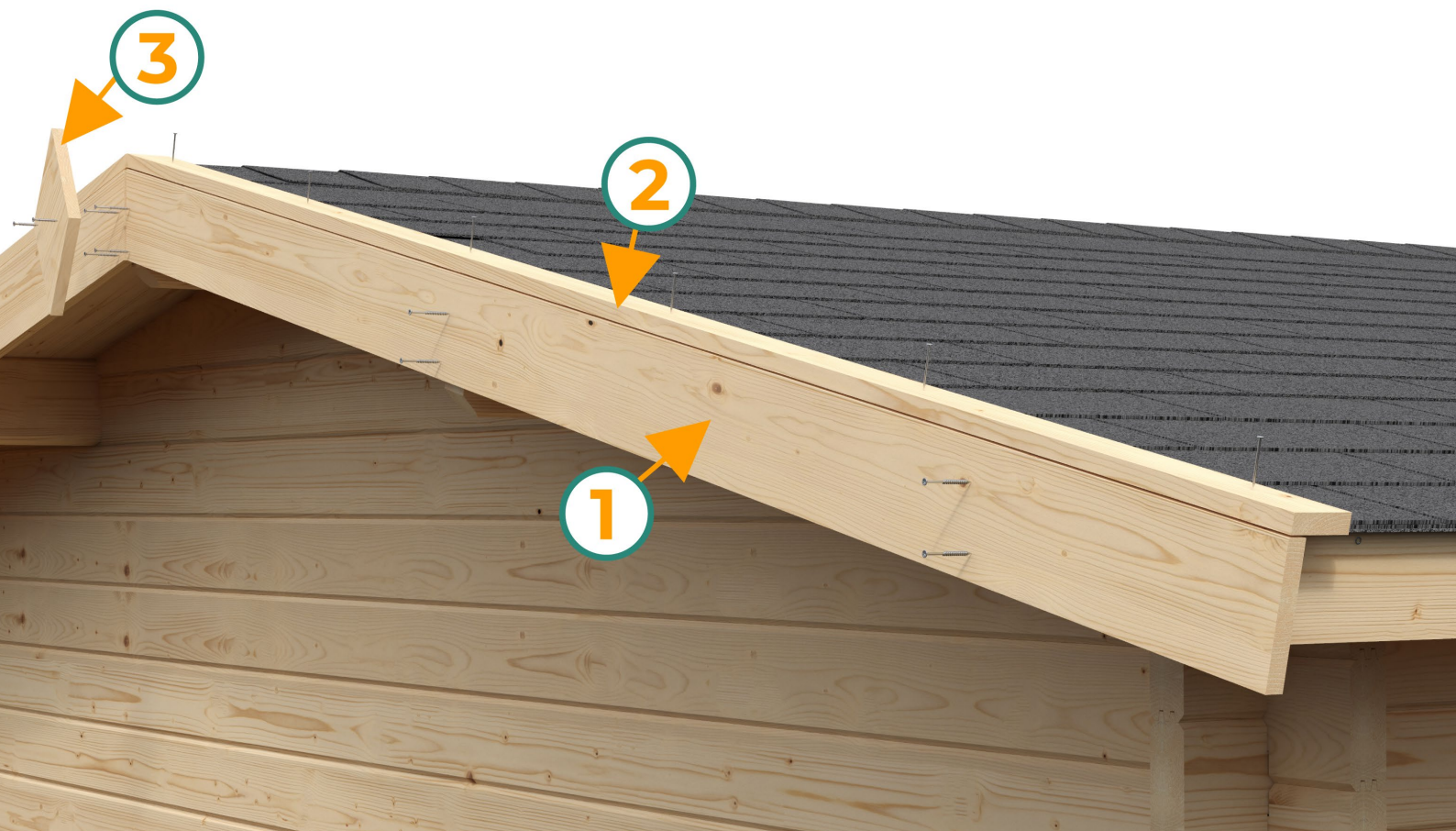

Installing roofs with parapets (pelmets)



If you have purchased a product with a flat roof, then please ensure that you carefully follow the installation instructions that have been provided with your garden room, because installing a flat roof is not like installing a gable roof.

You should be able to tell the top wall beams apart easily because they run at an angle, making them higher at the front and lower at the back. You should also easily be able to locate the top planks for the front and back wall because they have pre-cut tenons for the purlins. Install the rafters firmly into the pre-cut openings and use a rubber mallet to secure them in place if necessary. Attach the purlins to the side walls with screws at both ends.

When the purlins are in place, it's time to install the roof boards. **Please note that the roof boards may be up to 10cm shorter than the top beams for the side walls.** This is done to make sure that the roof has an opening at the back to allow rain water to run down without being obstructed. The roof boards are installed correctly when they are even at the front of the cabin (at the higher end) and leave an even gap at the back of the roof (the lower end). Place the first roof board so that it is aligned with the ends of the rafters, either from right to left or left to right. You may need to cut the last roof board to make it even with the ends of the rafters on the other side of the roof.

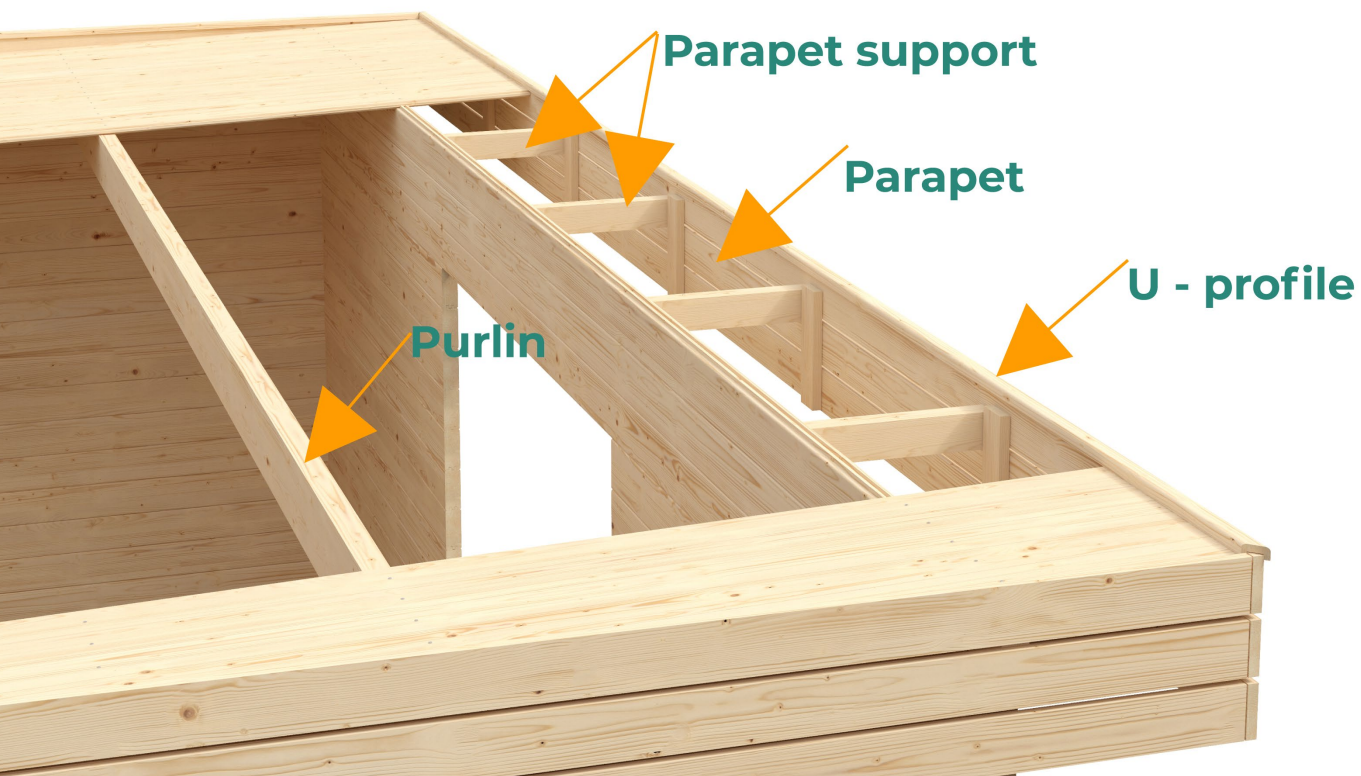

Now it's time to install the parapets. Start from the front, then install the sides, and finally the back. The height of the parapet location is usually not fixed, so we recommend lifting the top side of the front parapet approximately 5cm higher than the top of the roof boards so that you have enough room for the roof covering and a U-profile strip if your product has one.

Fasten the parapets in the front, and at the back to the ends of the top wall beams. The front and back parapets need to have additional parapet supports installed as well.

The side parapets are fastened to the ends of the purlins. Installing the parapets in this way will add to the durability and longevity of the construction.

For large models, the parapet may come in several pieces. If that is the case then please secure them together using parapet connection strips.

After installing the parapets you can install the U-profile strips on top (if your product has them) and a roof covering of your choice. **Please do not leave the roof uncovered!**



Installing floorboards



The floorboards should be installed by fastening them to the base frame. **If you want to insulate the floor, please make sure that you do it before you fasten down the floorboards.**

Fasten the first floorboard to every beam of the base frame with two nails, and for the rest of the boards, use one nail for each beam.

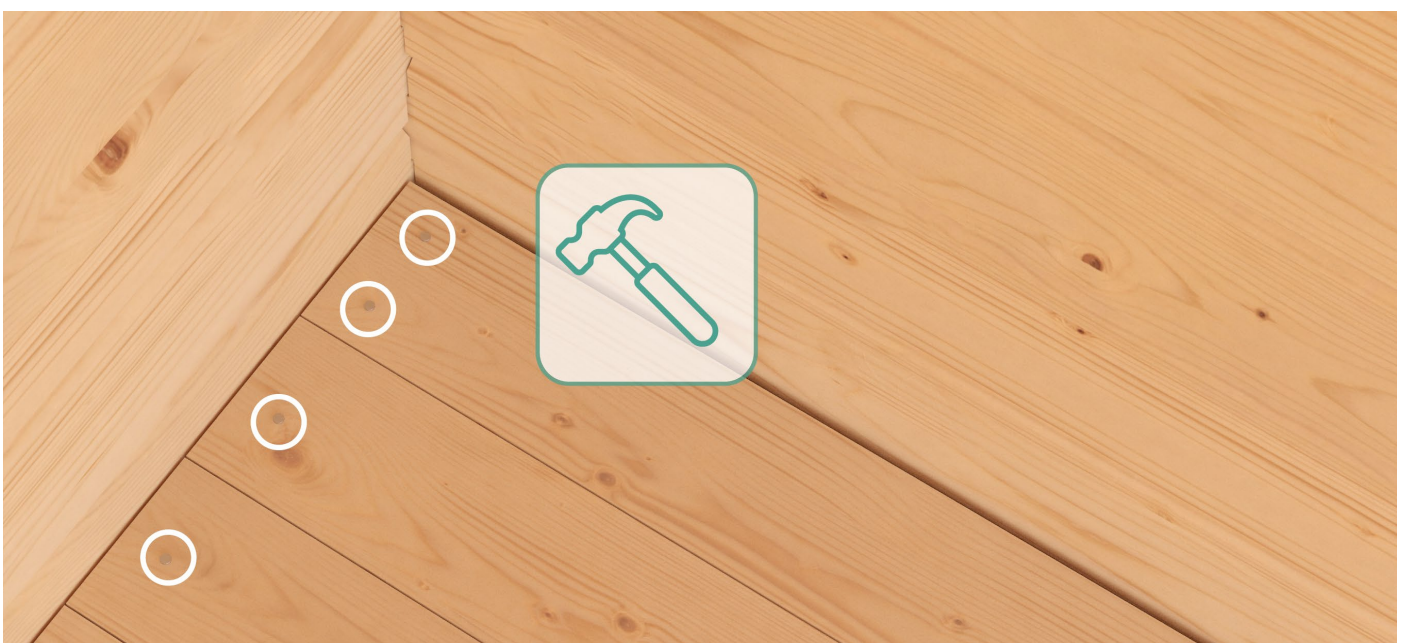

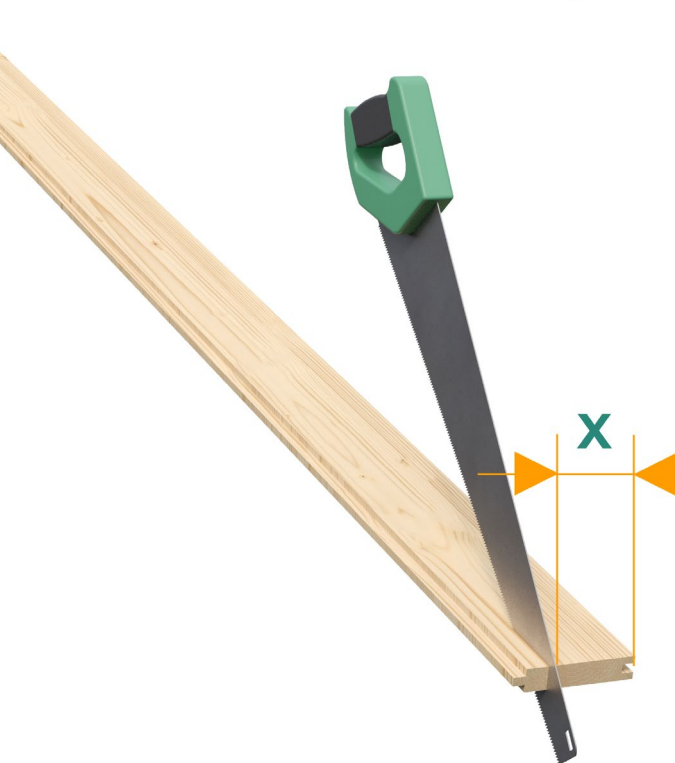

The last floorboard may need to be cut to width, as it may not fit into the space left between the last complete floorboard and the wall. Measure the gap and cut the last floorboard accordingly.



Please bear in mind the fact that if you want to treat the floorboards after installation then you should ensure that you cover the installed boards with cardboard, paper, or some other form of covering as untreated floorboards stain very easily and will be difficult to get clean afterwards.

Installing an integrated terrace



Many of Gardenhouse24's products come with a terrace included. Some products have open terraces, while others also have railings.



Install the terrace boards by affixing them to the base frame beams. **Please leave a 5-10mm gap between each of the boards and affix every terrace board to every base frame beam with two nails.** Start with a full board and, if required, cut the last board to width.

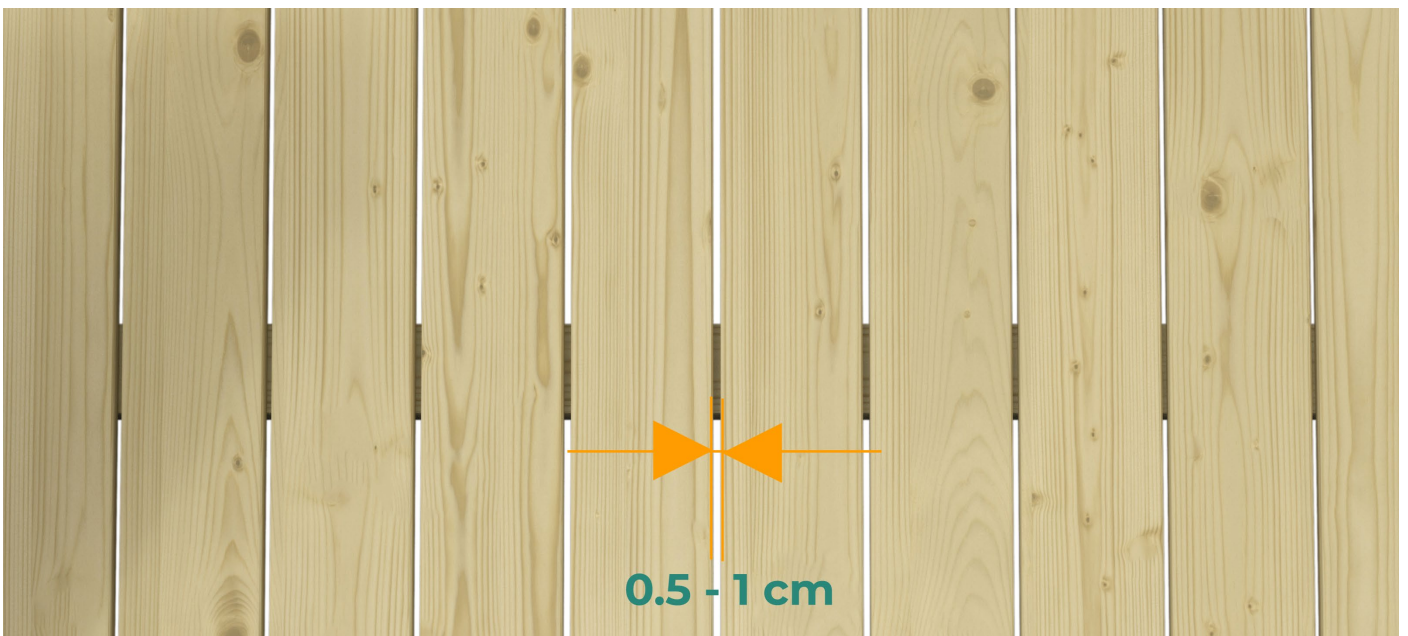



If these have not been installed with the main construction, you can now assemble the railings if your model has them. When your product has an integrated terrace with railings, the railings should be affixed to the main construction using a connection board.

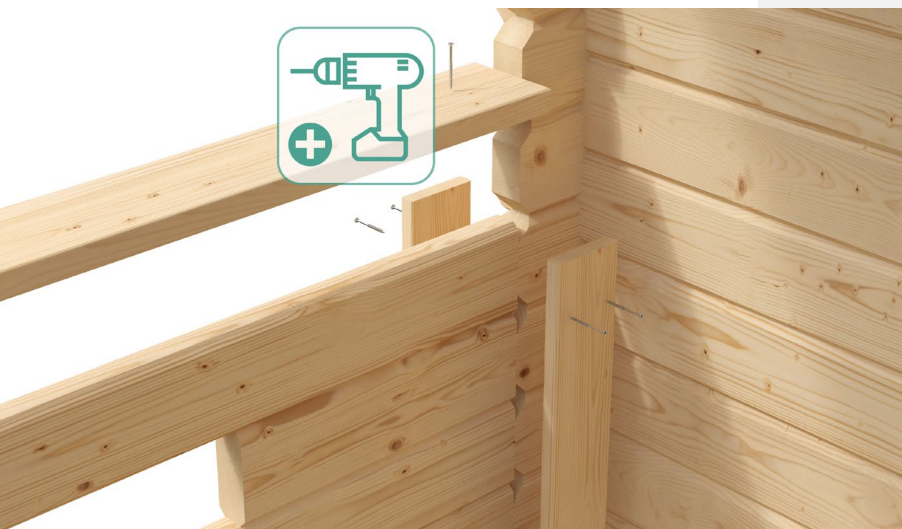

It is important to check regularly whether the connection boards allow the wall beams to expand and contract naturally. If required you should release the screws for the connection boards for a short period of time. Install the edge boards for the railings to complete the terrace installation.



Installing terrace support posts for models with terrace canopies



Large open terraces with canopies usually need several support posts to help support the weight of the canopy safely and to add to the structural integrity of the building.

You may need to cut the support posts to length before installation. Before cutting, please make sure that there is approximately 5cm of space between the bottom of the support post and the base frame so that you can install an adjustable metal post stand.

Insert the metal stands into predrilled holes at the bottom of the posts and affix the stands to the posts with screws. **Installing the posts accordingly gives you the opportunity to adjust the support posts as your new timber product settles into place, preventing the emergence of gaps in the walls.**



Wooden building maintenance – the basics

Timber buildings have a natural look and a healthy indoor climate, but using wood as the main construction material has its own requirements. If you want to preserve the longevity of your building and keep our warranty valid, please follow the maintenance guidelines carefully.



Treating wooden details

The first and second layer of any paint or oil-based preservative should be applied as soon as possible after the cabin is installed. **All of the wooden details on the building (the inner walls, outer walls, floor boards, roof boards, door frames, window frames, and so on) should be treated with wood preservative.** After the first treatment has been completed, this process should be repeated regularly according to the stipulations of the maintenance manual for your product, and usually every five years. If you fail to follow the treatment guidelines, our warranty becomes void.

The exterior treatment should be carried out only in dry conditions. Please do not apply exterior paint or preservative in damp or wet weather.

The storm braces

Our products are equipped with metal rods – storm braces – which should be inserted through the entire wall after it has been erected. The rods should be affixed from above with a washer and nut, and hand-tightened from the bottom. This should be done regularly – every two months in the first year and not less than once every four months afterwards.

Please use a spanner only when the nut won't move by hand due to rust. You can use a spanner to loosen the nut, but the tightening should ideally always be done by hand.

Allow the wood to settle

The logs in wall constructions should never be mechanically fixed together by screws or any other forms of fixing. Tongue-and-groove milled logs are designed to preserve the integrity of the structure. If you are planning on installing insulation or drywalling, you should use floating lathes with a tolerance of at least 7cm to allow the wood to expand, contract, and settle.

Please note that wood is a natural construction material. Cracks and knots in wooden details are totally natural and are not a sign of poor product quality. They do not compromise the integrity or performance of your product and are not considered to be defects.

If you choose not to insulate the floor of your cabin and do not install a heating system, please note that the floorboards for your product may develop gaps that could need adjusting.

Take note of what types of doors and windows come with your product

Although the majority of our products come with doors and windows that have rubber sealing as a standard feature, there are some products that have STANDARD door and window constructions which do not have rubber seals. This means that these doors and windows may suffer some leakage during potential extreme weather conditions, and this is not a sign of poor product quality.

If you have doors and windows with no rubber sealing, we advise you to install silicone or rubber seals behind the architraves. This is considered to be part of the basic maintenance regime and is not something that will be done unless you ask for it specifically.

When your product comes with door and window models that have rubber sealing as standard, extra sealing won't be necessary.

Adjust the doors and windows

Doors and windows with wooden frames may develop problems when opening and closing due to the natural settlement of the wooden frames. To ensure they function correctly, please take the time to adjust them accordingly.

When installing your product you may notice that the openings for doors and windows are bigger than the items themselves. This, once again, is necessary for the initial settling process. If you feel that you'd like to fill out the gaps that are left behind the door and window frame fixing boards with expanding foam or another insulating agent, please do not do that during the first two years after installation. If you still feel that it is necessary then it can be carried out

After-sales service

Please note that any defect, missing parts, or other product-related problems should be declared within ten days of receiving the product. In the case of production or transportation-related defects, please include pictures of the problem. Please also include your order number.

Our after-sales service will replace defective parts or ship out the missing ones. For a swift service, please fill in the missing and defective parts form correctly and send it to us via our support email address: support@gardenhouse24.co.uk

You'll find the missing parts declaration (downloadable) with instructions at: www.gardenhouse24.co.uk/returns

For our general terms and conditions, please visit: www.gardenhouse24.co.uk/terms-and-conditions

Please keep the package tag and order details until the end of the warranty period, in case they are needed for reference.

Thank you for buying our Nordic timber products and we hope you'll enjoy them for years to come!

Gardenhouse24 team



ABC Garden LTD
65 London Wall LONDON EC2M 5TU
info@gardenhouse24.co.uk
+44 20 7193 7889