

TIMKEN



BEARING DAMAGE ANALYSIS REFERENCE GUIDE

TIMKEN EXPERTISE

With broad and deep expertise in material science and tribology, we've developed this guide to help you identify and analyze bearing damage, including possible causes and preventative courses of action.

If you have bearing damage beyond the scope of this guide, contact our service engineering team. We can work with you – often on-site – to get to the root cause of your problems. We also offer in-depth training that's customized to your specific industry or application.

TYPES AND CAUSES OF BEARING DAMAGE

Many different factors can cause bearing damage. Those listed in this guide are the most commonly identified types and causes of damage for anti-friction bearings, including cylindrical, spherical, tapered and ball designs. Always follow proper bearing maintenance and handling practices to help ensure your bearings achieve optimal performance levels.

WARNING

Failure to observe the following warnings could create a risk of death or serious injury.

Proper maintenance and handling procedures are critical. Always follow installation instructions and maintain proper lubrication.

Never spin a bearing with compressed air. The rollers may be forcefully expelled.

Overheated bearings can ignite explosive atmospheres. Special care must be taken to properly select, install, maintain, and lubricate bearings that are used in or near atmospheres that may contain explosive levels of combustible gases or accumulations of dust such as from grain, coal, or other combustible materials. Consult your equipment designer or supplier for installation and maintenance instructions.

If hammer and bar are used for installation or removal of a part, use a mild steel bar (e.g., 1010 or 1020 grade). Mild steel bars are less likely to cause release of high-speed fragments from the hammer, bar or the part being removed.

WARNING

Failure to observe the following warnings could create a risk of serious injury.

Tensile stresses can be very high in tightly fitted bearing components. Attempting to remove such components by cutting the inner rings may result in a sudden shattering of the component causing fragments of metal to be forcefully expelled. Always use properly guarded presses or bearing pullers to remove bearings from shafts, and always use suitable personal protective equipment, including safety glasses.

CAUTION

Failure to follow these cautions may result in property damage.

Do not use damaged bearings.

Do not use damaged housed units.

Warnings for this product line are in this catalog and posted on www.timken.com/warnings.

NOTE

Do not use excessive force when mounting or dismantling the unit.

Follow all tolerance, fit, and torque recommendations.

Always follow the Original Equipment Manufacturer's installation and maintenance guidelines.

Ensure proper alignment.

Never weld housed units.

Do not heat components with an open flame.

Do not operate at bearing temperatures above 121° C (250° F).

DISCLAIMER

This guide is provided solely to give you analysis tools and data to assist you in your product selection. Product performance is affected by many factors beyond the control of Timken. Therefore, you must validate the suitability and feasibility of all product selections for your applications.

Timken products are sold subject to Timken terms and conditions of sale, which include our limited warranty and remedy. You can find these at www.timken.com/termsandconditionsofsale.

Please consult with your Timken engineer for more information and assistance.

Every reasonable effort has been made to ensure the accuracy of the information in this writing, but no liability is accepted for errors, omissions or for any other reason.

TABLE OF CONTENTS

Bearing Damage: Overview of the Facts	4
Suggested Procedure for Bearing Analysis	5
Wear – Abrasive Contamination	6
Abrasive Wear	6
Wear – Grooving	6
Wear – Pitting and Bruising	7
Adhesive Wear	7
Etching – Corrosion	8
Fatigue Spalling	9
Geometric Stress Concentration (GSC) Spalling	9
Point Surface Origin (PSO) Spalling	9
Inadequate Lubrication	10
Level 1 – Discoloration	10
Level 2 – Scoring and Peeling	10
Level 3 – Excessive Roller End Heat	11
Level 4 – Total Bearing Lockup	11
Excessive Preload or Overload	12
Excessive Endplay	13
High Spots in Housing	13
Handling and Installation Damage	14
Damaged Bearing Cages or Retainers	15
Improper Fitting Practices in Housing or on Shaft	16
Cam Fracture: Wide Inner Ring Ball Bearings	16
Misalignment and Inaccurate Seat and Shoulder Machining	17
Brinell and Impact Damage	18
False Brinelling	19
Burns from Electric Current	20
Understanding Bearing Life	21
Glossary	22

PREPARATION AND APPROACH TO BEARING DAMAGE ANALYSIS

BEARING DAMAGE: OVERVIEW OF THE FACTS

Timken analyzes bearings from operations across the world. Our bearing service and repair specialists find that 50 percent of the bearings submitted to us haven't reached their calculated lives.

In some cases, the cause is contact fatigue (inclusion origin, point surface origin, geometric stress concentration and micro-spalling). In 90 percent of the cases, the cause is non-fatigue factors, including:

- Foreign materials.
- Corrosion.
- Inadequate lubrication.
- Improper handling.
- Bad running conditions.

If you're concerned that your bearing is deteriorating, look for the following signs:

- Vibrations – whether felt by hand or measured with a frequency analyzer.
- Abnormal noises.
- Displacement of rotational centerline.
- Running temperature increase.
- Odd smells.
- Lubricant deterioration.
- Lubricant leakage.
- Visual discovery during routine maintenance check.

SUGGESTED PROCEDURE FOR BEARING ANALYSIS

Follow the steps below for an accurate and complete analysis when investigating any bearing damage or system breakdowns. If you need help, contact one of our sales or service engineers.

1. Gather operating data from bearing monitoring devices; analyze service and maintenance records and charts; and secure application diagrams, graphics or engineering drawings.
2. Prepare an inspection sheet to capture all your observations. Take photographs throughout the procedure to help document or describe the damaged components.
3. Extract any used lubricant samples from bearings, housing and seal areas to determine lubricant conditions. Package it separately and label it properly.
4. Secure a sample of new, unused lubricant. Record any specification or batch information from the container. Obtain the technical specifications and any related material safety data (handling, disposal, toxicological) documentation to accompany lubricant shipments.
5. Check the bearing environment for external influences, like other equipment problems, that preceded or occurred at the same time bearing damage was reported.
6. Disassemble the equipment (either partially or completely). Record an assessment of the mounted bearing condition.
7. Inspect other machine elements, especially the position and condition of components adjacent to the bearing, including locknuts, adapters, seals and seal wear rings.
8. Mark and record the mounted position of the bearings and components prior to removal.
9. Measure and verify shaft and housing size, roundness and taper using certified gauges.
10. Following removal, but before cleaning, record observations of lubricant distribution and condition.
11. Clean parts and record the manufacturers' information from markings on the bearing rings (part number, serial number, date code).
12. Analyze the condition of the internal rolling contact surfaces, load zones and the corresponding external surfaces.
13. Apply preservative oil and repackage the bearings to avoid corrosion.
14. Compile a summary report of all data for discussion with Timken sales or service engineers.

WEAR – ABRASIVE CONTAMINATION

Foreign particles cause wear and damage. Foreign particle contamination can cause abrasive wear, bruising or circumferential lining (grooving).

ABRASIVE WEAR

Fine foreign material in the bearing can cause excessive abrasive wear. Sand, fine metal from grinding or machining, and fine metal or carbides from gears wear or lap the rolling elements and races. In tapered bearings, the roller ends and inner ring rib wear to a greater degree than the races. This wear causes increased endplay or internal clearance, which can reduce fatigue life and create misalignment in the bearing. Abrasive wear also can affect other parts of the machine in which the bearings are used. The foreign particles may get in through badly worn or defective seals. Improper initial cleaning of housings and parts, ineffective filtration or improper filter maintenance can allow abrasive particles to accumulate.

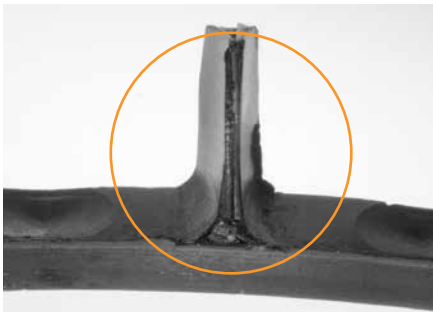

Fine particle contamination entered this spherical roller bearing and generated wear between the cage surfaces, rollers and races.

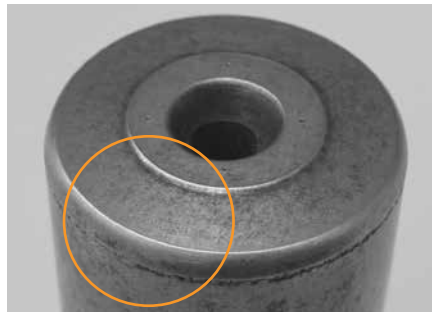

The roller end wear on this spherical bearing also was caused by fine particle contamination.



Fine particle contamination caused abrasive wear on this tapered roller bearing.

WEAR – GROOVING

Extremely heavy wear from chips or metal particles can cause grooving. These contaminants become wedged in the soft cage material and cut grooves in the rolling elements. This condition generates improper rolling contact geometry and can reduce service life.

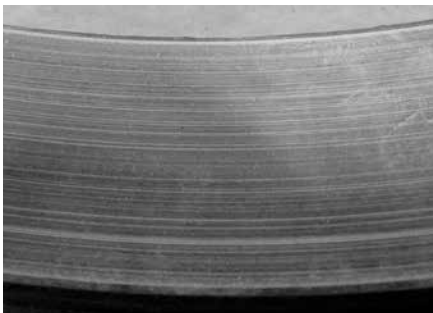

Circumferential grooves in ring raceway cause improper rolling contact, reducing bearing life.



Circumferential grooving on rollers.



Circumferential grooving.

WEAR – PITTING AND BRUISING

External debris contamination rolling through the bearing may cause pitting and bruising of the rolling elements and races.

Common external debris contaminants include dirt, sand and environmental particles. Typical causes of internal debris contamination include wear from gears, splines, seals, clutches, brakes, joints, improperly cleaned housings, and damaged or spalled components. These hard particles travel within the lubrication, through the bearing and eventually bruise (dent) the surfaces. Raised metal around the dents acts as surface-stress risers to cause premature spalling and reduce bearing life.



A tapered roller bearing inner ring with spalling from debris contamination bruises.

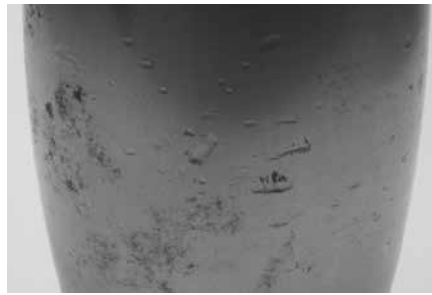

Hard particles caused contamination bruising on this spherical roller bearing.



Debris from other fatigued parts, inadequate sealing or poor maintenance caused bruising on this tapered roller bearing race.

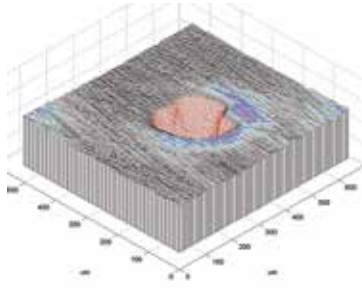
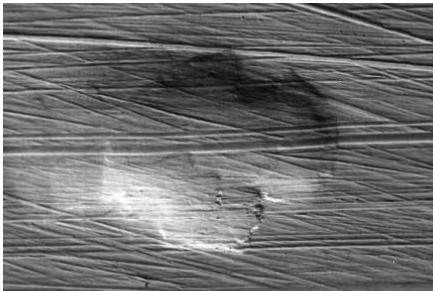

This photo, taken with a microscope, shows a debris contamination bruise on a bearing race. A corresponding surface map of the dent is shown to the right.

ADHESIVE WEAR

Typical causes include improper oil film, excess cage friction and gross roller sliding.

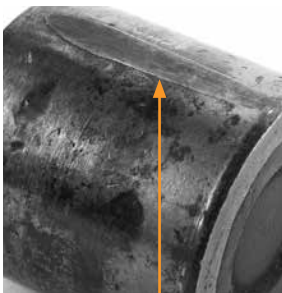

Roller flats, adhesive and skidding wear on raceway surface.

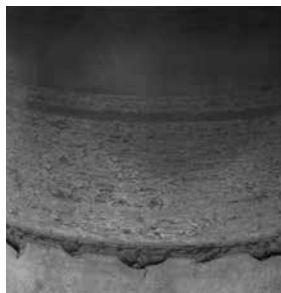

Spherical roller bearing with adhesive wear.



Roller end with adhesive wear.



Adhesive wear on bearing inner ring.

ETCHING – CORROSION

Etching (or corrosion) remains one of the most serious problems anti-friction bearings encounter. Without adequate protection, the high degree of surface finish on races and rolling elements makes them susceptible to corrosion damage from moisture and water.

Etching is typically caused by condensate collecting in the bearing housing from temperature changes. Moisture or water can get in through damaged, worn or inadequate seals. Improperly washing and drying bearings when you remove them for inspection also can cause considerable damage. After cleaning and drying or preparing bearings for storage, coat them with oil or another preservative and wrap them in protective paper. Always store bearings, new or used, in a dry area and keep them in their original packaging to reduce the risk of static corrosion appearing before mounting.



This outer ring has heavy corrosion on the race. This type of corrosion may only be a surface stain without pitting. If the staining can be cleaned with a fine emery cloth or crocus cloth, the bearing may be reused. If there are pits that cannot be cleaned with light polishing, the bearing should either be discarded or, if practical, refurbished.

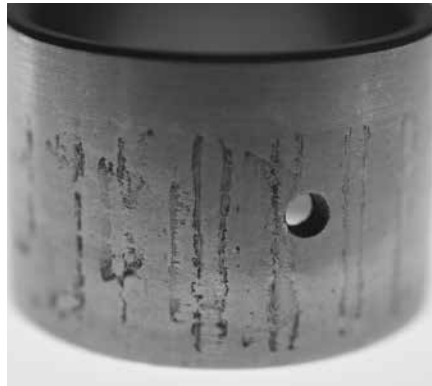

This cylindrical bearing inner ring has etching and corrosion.



Advanced spalling initiated at water etch marks on the outer ring race makes this bearing unsuitable for further service.



Advanced etching.



Advanced corrosion and etching.

FATIGUE SPALLING

Spalling is the pitting or flaking away of bearing material. Spalling primarily occurs on the races and the rolling elements. We show many types of “primary” bearing damage throughout this reference guide that eventually deteriorate into a secondary spalling damage mode.

GEOMETRIC STRESS CONCENTRATION (GSC) SPALLING

Causes for this type of damage mode include misalignment, deflection or edge loading that initiates high stress at localized regions of the bearing. It occurs at the extreme edges of the race/roller paths. Shaft or housing machining errors can also cause GSC spalling.

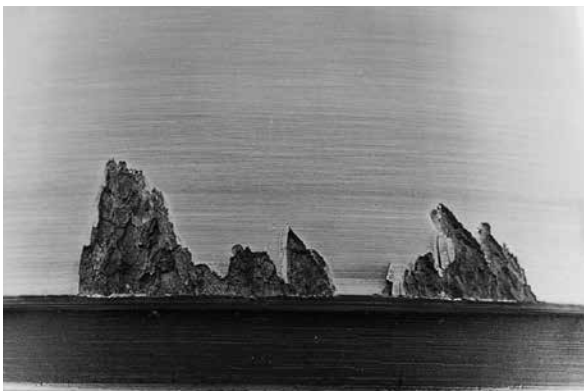

Misalignment, deflections or heavy loading on this tapered roller bearing caused GSC spalling.

POINT SURFACE ORIGIN (PSO) SPALLING

Very high and localized stress generates this type of damage mode. The spalling damage is typically from nicks, dents, debris, etching and hard-particle contamination in the bearing. It's the most common type of spalling damage, and often appears as arrowhead-shaped spalls, propagating in the direction of rotation.



PSO spalling caused by debris or raised metal exceeding the lubricant film thickness on this tapered roller bearing inner ring.

INADEQUATE LUBRICATION

Inadequate lubrication can create a wide range of damage conditions. Damage happens when there isn't a sufficient amount of bearing lubricant to separate the rolling and sliding contact surfaces during service.

It's important that the right lubricant amount, type, grade, supply system, viscosity and additives are properly engineered for each bearing system. Base your selection on history, loading, speeds, sealing systems, service conditions and expected life. Without proper consideration of these factors, you may experience less-than-expected-bearing and application performance.

The damage caused by inadequate lubrication varies greatly in both appearance and performance. Depending on the level of damage, it may range from very light heat discoloration to total bearing lockup with extreme metal flow.

The following section outlines the progressive levels of bearing damage caused by inadequate lubrication.

LEVEL 1 – DISCOLORATION

- Metal-to-metal contact results in excessive bearing temperature.
- High temperatures result in discoloration of the races and the roller.
- In mild cases, the discoloration is from the lubricant staining the bearing surfaces. In severe cases, the metal is discolored from high heat.

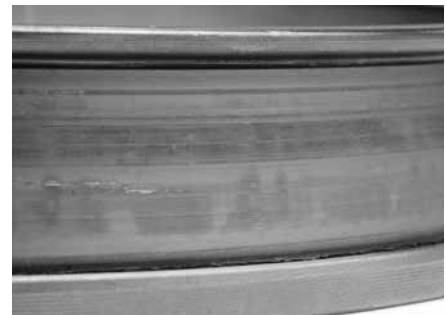

Level 1 – Discoloration due to elevated operating temperatures.

LEVEL 2 – SCORING AND PEELING

- Insufficient or complete lack of lubricant.
- Selecting the wrong lubricant or lubrication type.
- Temperature changes.
- Sudden changes in running conditions.



Level 2 – Micro-spalling or peeling results from thin lubricant film due to high loads/low speed or elevated temperatures.



Level 2 – Advanced rib scoring is due to inadequate lubricant film.



Scoring damage on roller end.

LEVEL 3 – EXCESSIVE ROLLER END HEAT

- Inadequate lubricant film results in localized high temperatures and scoring at the large ends of the rollers.

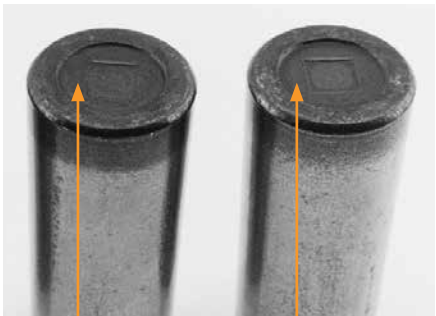

Level 3 – Heat damage on these tapered rollers was caused by metal-to-metal contact.



Rib and roller end heat damage.

LEVEL 4 – TOTAL BEARING LOCKUP

- High localized heat produces metal flow in bearings, altering the original bearing geometry and material.
- This results in skewing of the rollers, destruction of the cage, metal transfer and complete seizure of the bearing.

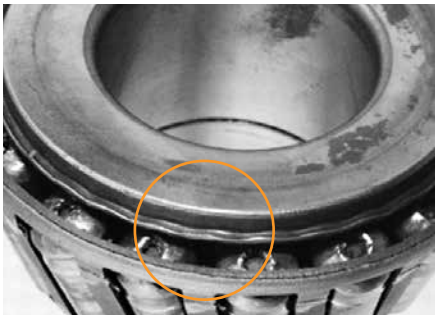

Inner ring rib deformation from excessive heat generation.



Cage damage from bearing lockup.



Cage damage from bearing lockup.

Careful inspection of all bearings, gears, seals, lubricants and surrounding parts may help determine the primary cause of damage.

EXCESSIVE PRELOAD OR OVERLOAD

Excessive preload can generate a large amount of heat and cause damage similar in appearance to inadequate lubrication damage. The two causes may be confused, so check the bearing thoroughly to determine the root problem.

A lubricant that's suitable for normal operation may be unsuitable for a heavily preloaded bearing, as it may not have the film strength to carry the very high loads. The lubricant breakdown in high preloads can cause the same type of damage shown in the previous description of inadequate lubrication damage.

Another type of damage can result from heavy preloads even if you use a lubricant (such as an extreme pressure type of oil) that's engineered to carry heavy loads. Although the lubricant can handle the loads so that there's no rolling element or race scoring, the heavy loads may cause premature fatigue spalling. The initiation of this spalling, and subsequently the life of the bearing, would depend on the amount of preload and the capacity of the bearing.



Heavy spalling and fracturing from high loads on this spherical roller bearing.



High loads resulted in fatigue spalling on this cylindrical roller bearing.



This ball bearing inner ring depicts fatigue spalling from high loads. The fracture is a secondary damage mode.



Overloading on this cylindrical roller bearing caused roller surfaces to fracture.



High loads and low speeds caused insufficient lubricant film on this tapered roller bearing inner ring.



A heavily overloaded tapered roller bearing resulted in premature, severe fatigue spalling on the rollers. The load was so heavy that large pieces of metal broke off the rollers.

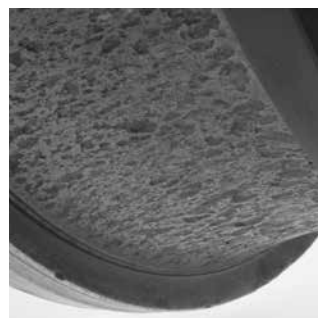

This spherical roller bearing race shows severe peeling and spalling due to high loads.

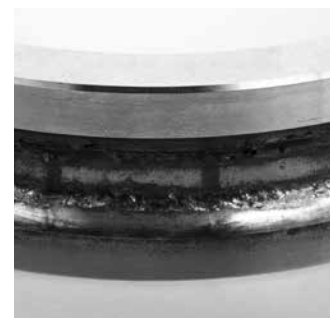

Fatigue spalling from excessive preload.

EXCESSIVE ENDPLAY

Excessive endplay results in a very small load zone and excessive looseness between the rollers and races outside the load zone. This causes the rollers to unseat, which leads to roller skidding and skewing as the rollers move into and out of the load zone. This movement creates scalloping in the outer ring, and cage wear from excessive roller movement and the impact of the rollers with the raceway.



Scalloping marks in the outer ring are common with excessive endplay. This occurs when unloaded rollers enter the small load zone and are suddenly exposed to heavy loads.



Cage pocket damage results from excessive roller movement.



Heavy wear in the small end of the cage pockets is typical of excessive endplay.

HIGH SPOTS IN HOUSING

Careless handling or damage caused when driving outer races out of housings or wheel hubs can create burrs or high spots in the outer race seats. If a tool gouges the housing seat surface, it will leave raised areas around the gouge. If you don't scrape or grind down these high spots before reinstalling the outer race, the high spot will transfer through the outer race and cause a corresponding high spot in the outer race's inside diameter. Stresses increase when the rolling elements hit this high area, which can result in lower than predicted service life.



The marks visible on the outside diameter of this outer ring are caused by a high spot on the housing. The outer ring race was found spalled at the location that corresponds to the outer ring mark from heavy contact with the housing high spot.

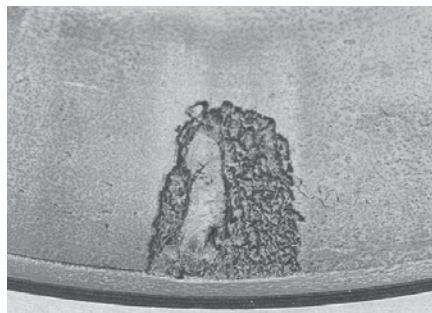

Localized spalling on this outer ring race resulted from a stress riser created by a split housing pinch point.

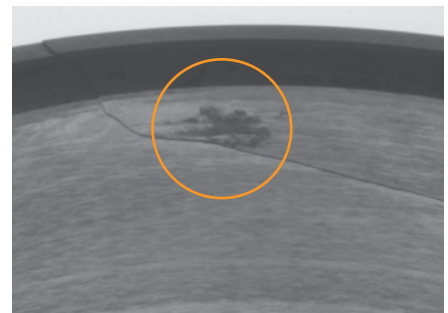

This ball bearing inner ring fracture resulted from installation on top of a metal contaminant or raised metal nick.

HANDLING AND INSTALLATION DAMAGE

Be careful when handling and assembling bearings so that you don't damage the rolling elements, race surfaces and edges. Deep gouges in the race surface or battered and distorted rolling elements will make metal rise around the gouged or damaged area. High stresses will occur as the rolling elements go over these surfaces, creating premature, localized spalling. The immediate effect of these gouges and deep nicks will be roughness, vibration and noise in the bearing.

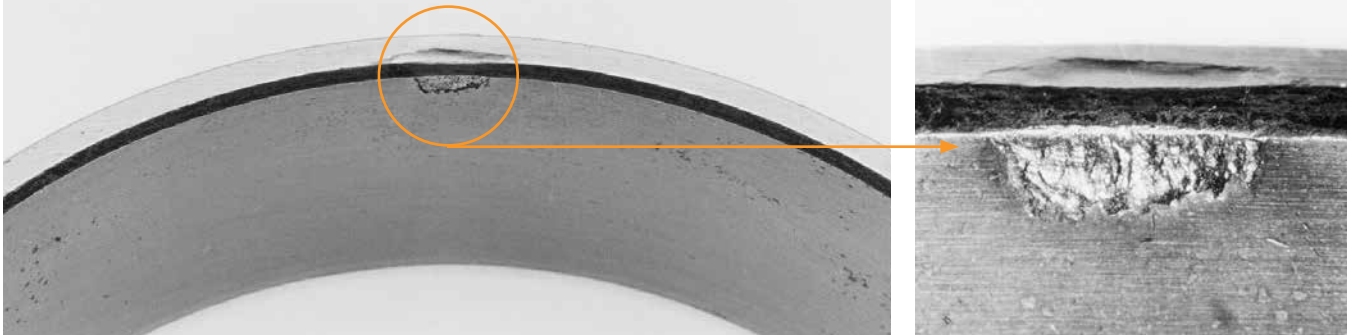

A hardened driver caused outer ring face denting on this tapered roller bearing.



This spherical roller bearing inner race depicts a fractured small rib caused by the use of improper installation tools.

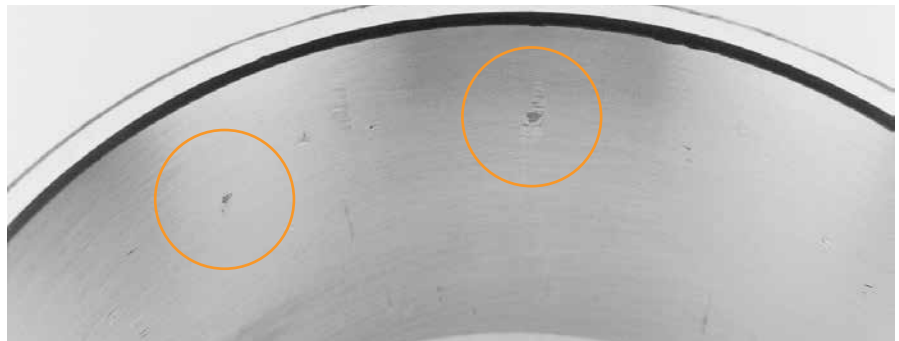

Tapered roller spaced nicking was caused by the roller edges hitting the race during installation. These nicks/dents have raised edges that can lead to excessive noise, vibration or act as points of stress concentration.

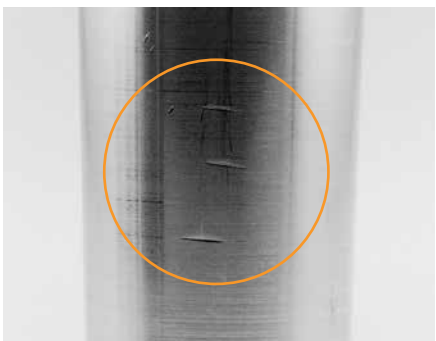

Rough handling or installation damage resulted in nicks and dents in this tapered bearing roller.



Point Surface Origin (PSO) spalling.

DAMAGED BEARING CAGES OR RETAINERS

Careless handling and using improper tools during installation may cause cage or retainer damage. Cages or retainers are usually made of mild steel or brass and can be easily damaged, which can cause premature bearing performance problems.

In some applications, environmental and operating conditions can cause fractured cages or retainers. This type of damage is too complex to cover in this reference guide. If you experience this problem, contact your Timken sales or service engineer.

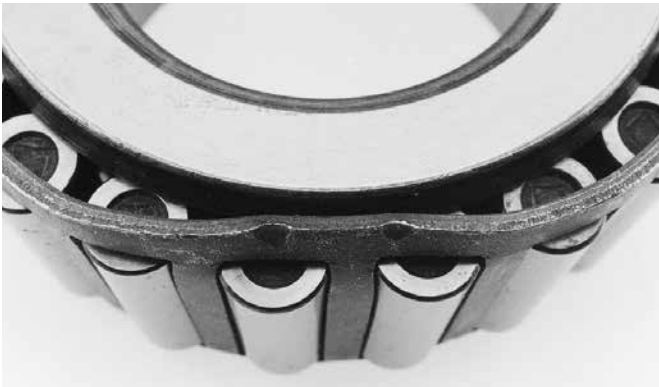

This cage deformation was caused by an improperly installed or dropped bearing.



Binding and skewing of these tapered rollers was due to compression of cage ring during installation or interference during service.

IMPROPER FITTING PRACTICES IN HOUSING OR ON SHAFT

Typical causes include wrong size and poor form, shaft or housing stress risers and inaccurate machining. Follow the manufacturer's recommended bearing fit to ensure your bearings perform properly.

In general, you should apply the rotating bearing race with a press or tight fit. An example is a wheel hub, where the outer race should be applied with a press fit. The races on a stationary axle would normally be applied with a light or loose fit. Where the shaft rotates, the inner race should normally be applied with a press fit and the outer race may be applied with a split fit or even a loose fit, depending on the application.



A worn-out housing caused this bearing to lose fit and fret (move) during service. As a result, metal tearing and wear occurred on this spherical outer ring.



Classic fretting corrosion from poor fitting practice is depicted here. Relative movement under load between the bearing and its seat caused this worn and corroded condition.

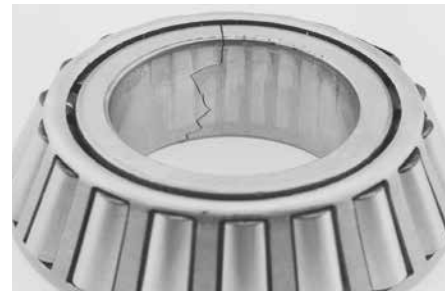

An out-of-round or oversized shaft caused this fracture on a tapered roller bearing inner ring.



A loose outer ring fit in a rotating wheel hub (typically tight) caused this bearing race damage.



Cracked outer ring in a wheel hub. The outer ring turns and wears the outer ring seat so the fit becomes more loose. Then the outer ring starts to stretch or roll out. Wear and stretching continues to the point where the metal reaches its breaking point and the outer ring cracks open.

CAM FRACTURE: WIDE INNER RING BALL BEARINGS

An undersized shaft or an outer ring that cannot be aligned due to the housing may cause a broken cam, a misaligned travel path or bearing wobble.

This type of bearing damage may be prevented by using the correct size shaft and by using the Timken self-aligning feature, a spherical outer ring to compensate for initial misalignment and correctly mount bearings.



Fractured wide inner ring with locking collar due to undersized shaft

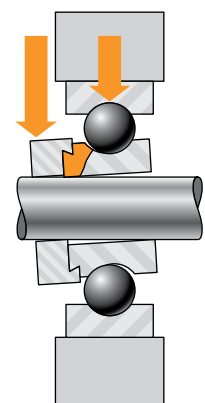

Shaft below suggested tolerance levels.

MISALIGNMENT AND INACCURATE SEAT AND SHOULDER MACHINING

Misaligned bearings will shorten bearing life. This reduction depends on the degree of misalignment. To gain more life from the bearing, the seats and shoulders supporting the bearing must be within the specified limits set by the bearing manufacturer.

If misalignment exceeds those limits, the load on the bearing won't be distributed along the rolling elements and races as intended. Instead, it will be concentrated on only a portion of the rollers or balls and races. In cases of extreme misalignment or off angle, the load will be carried only on the extreme ends of the rolling elements and races.

A heavy concentration of the load and high stresses at these points will cause early metal fatigue.

Typical causes of misalignment:

- Inaccurate machining or wear of housings or shafts.
- Deflection from high loads.
- Out-of-square backing shoulders on shafts or housings.

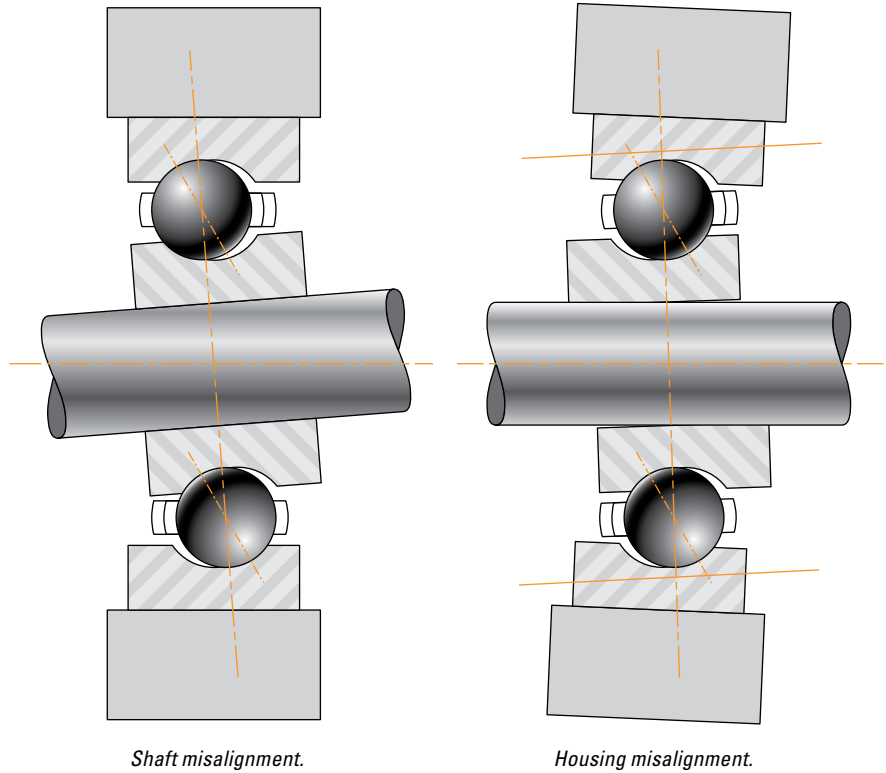

Deflection, inaccurate machining or wear of bearing seats caused an irregular roller path on this tapered roller bearing outer ring.



Heavy loads causing shaft deflection can lead to GSC spalling in this cylindrical roller bearing inner ring.



Geometric Stress Concentration (GSC) spalling.

BRINELL AND IMPACT DAMAGE

Improper mounting and disassembly methods and/or extremely high operational impact or static loads may cause brinelling.

Brinell from improper assembly and disassembly happens when a force is applied against the unmounted race. When mounting a bearing on a shaft with a tight fit, pushing the outer race will exert an excessive thrust load and bring the rolling elements into sharp contact with the race, causing brinell.

The first illustration below shows incorrect removal of a bearing, while the second shows the correct way to mount or dismount a bearing by applying the force to the tight-fitted race.

Extremely heavy impact loads, which may be short in duration, can result in brinell of the bearing races. Sometimes, they can even fracture the races and rolling elements.

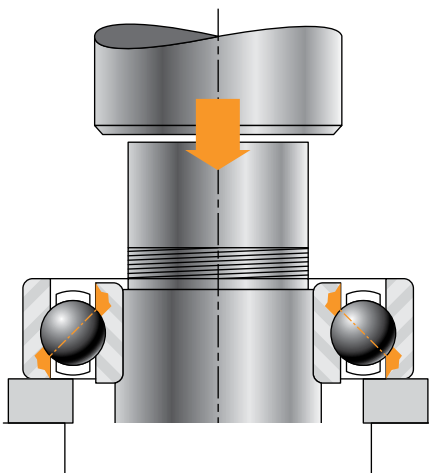

Incorrect removal of a bearing.

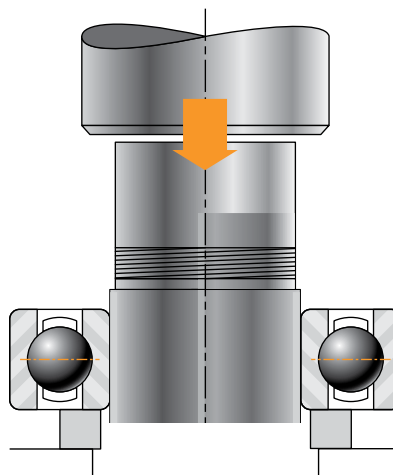

Correct removal of a bearing.

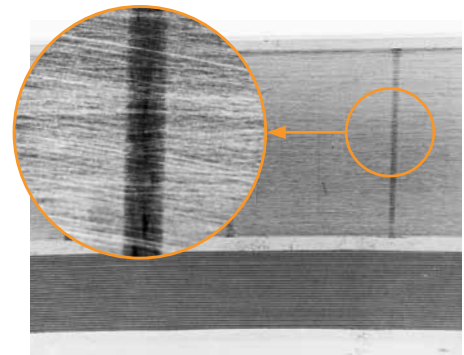

A heavy impact load on this tapered bearing outer ring caused brinell and impact damage. These same indentations are evident on the inner ring. This is true metal deformation and not wear as with false brinelling. The close-up view of one of the grooves shows the grinding marks still in the groove.

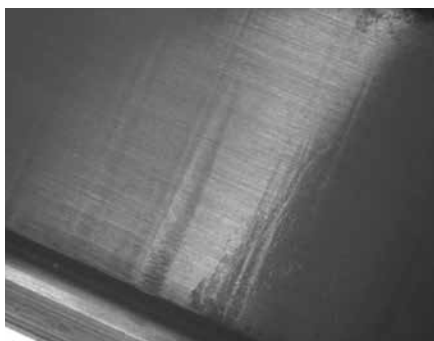

This inner ring of a spherical roller bearing shows roller impact damage from shock loading.



Note shock loading caused brinell damage on this ball bearing inner ring.

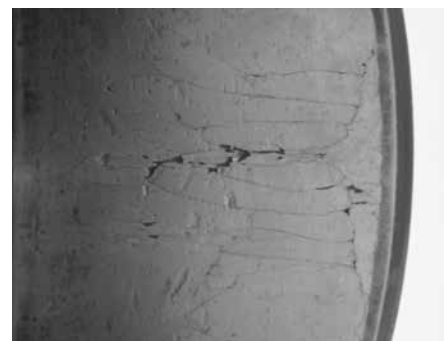

This cylindrical roller bearing inner ring was crushed by an application failure during service.

FALSE BRINELLING

As the name indicates, false brinelling isn't true brinelling or denting. It's actually fretting wear caused by slight axial rolling-element movements while the bearing is stationary. Vibration can make the rolling element slide back and forth across the race, wearing a groove into the race.

Roller bearings also exhibit false brinelling when they're used in positions that encounter very small reversing angular oscillation (less than one complete rotation of the rolling element).

You can distinguish false brinelling from true brinelling by examining the depression or wear area. False brinelling will actually wear away the surface texture, whereas the original surface texture will remain in the depression of a true brinell.

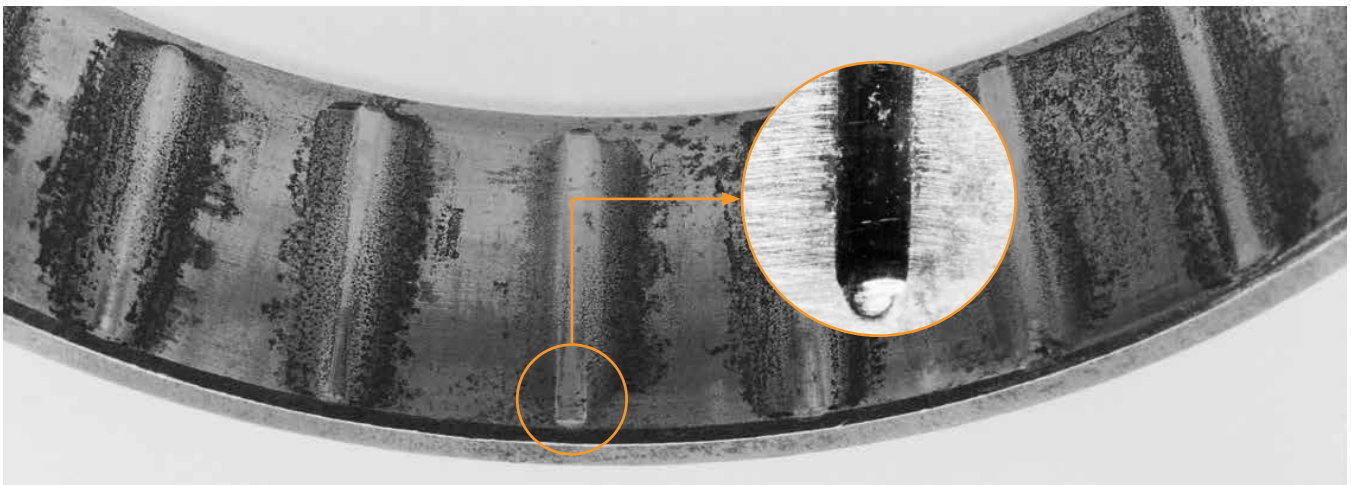

Wear caused by vibration or relative axial movement between the rollers and races is depicted in this tapered roller bearing outer ring.

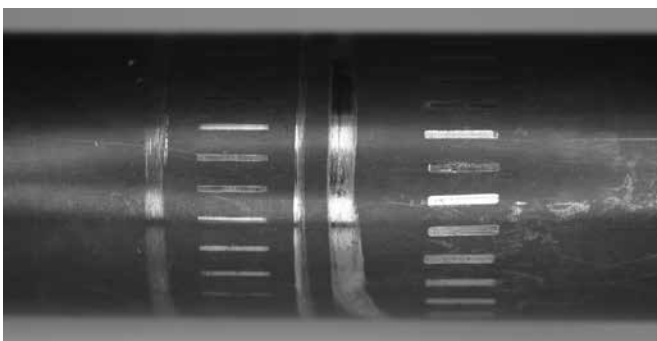

False brinell on a shaft where a cylindrical bearing was mounted.



Heavy false brinell on outer race.

BURNS FROM ELECTRIC CURRENT

Arcing, which produces high temperatures at localized points, occurs when an electric current that passes through a bearing is broken at the contact surfaces between the races and rolling elements.

Each time the current is broken while passing between the ball or roller and race, it produces a pit on both parts. Eventually fluting develops. As it becomes deeper, it creates noise and vibration. A high-amperage current, such as a partial short circuit, will cause a rough, granular appearance. Heavy jolts of high-amperage charges will cause more severe damage, welding metal from the race to the ball or roller. These metal protrusions on the roller will, in turn, cause a crater effect in the race, generating more noise and vibration.

Causes of arcing include static electricity from charged belts or processes that use calendar rolls, faulty wiring, improper grounding, welding, inadequate or defective insulation, loose rotor windings on an electric motor and short circuits.

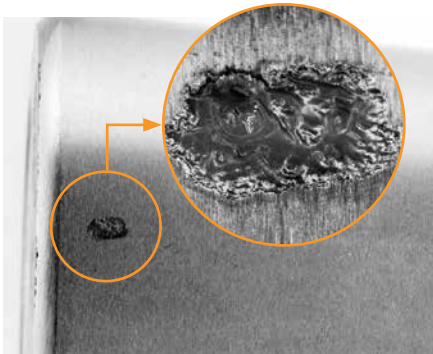

Electric arc pitting or small burns, magnified 10X here, were created by arcs from improper electric grounding while the bearing was stationary.



Welding on a machine, while the bearings were rotating, caused electric arc fluting on this spherical roller bearing.

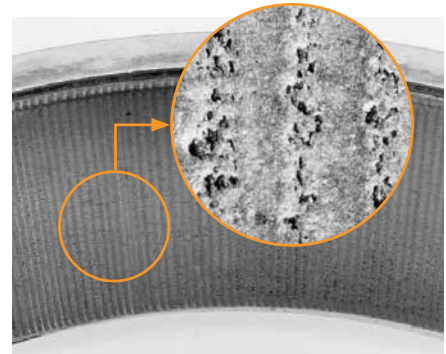

Magnified 10X, this fluting, defined as a series of small axial burns, was caused by an electric current passing through the bearing while it was rotating.



Roller with electric arc burns.



Burns from electric current.

UNDERSTANDING BEARING LIFE

Bearing Service Life

Bearing service life is based on many factors. Depending on the application requirements, the actual service life can greatly vary. For example, a machine tool spindle bearing may be unfit for further service because of minor wear that affects spindle accuracy. In contrast, a rolling mill roll neck bearing may have a satisfactory service life even if the bearing developed spalling damage, as long as the spalls are properly repaired in a timely fashion.

Reduced service life can be caused either individually or by any combination of:

- Faulty mounting.
- Improper adjustment.
- Insufficient lubrication.
- Contamination.
- Improper or abusive handling.
- Poor housing support.
- High-static misalignment or shaft and housing deflection.
- Poor or inconsistent maintenance practices.

The life of your bearing also depends on the load zone obtained under operating conditions. Generally speaking, the greater the load zone, the longer the life of the bearing under stabilized operating conditions.

The diagram below shows this relationship for tapered roller bearings; other roller bearings with radial loads possess a similar performance relationship.

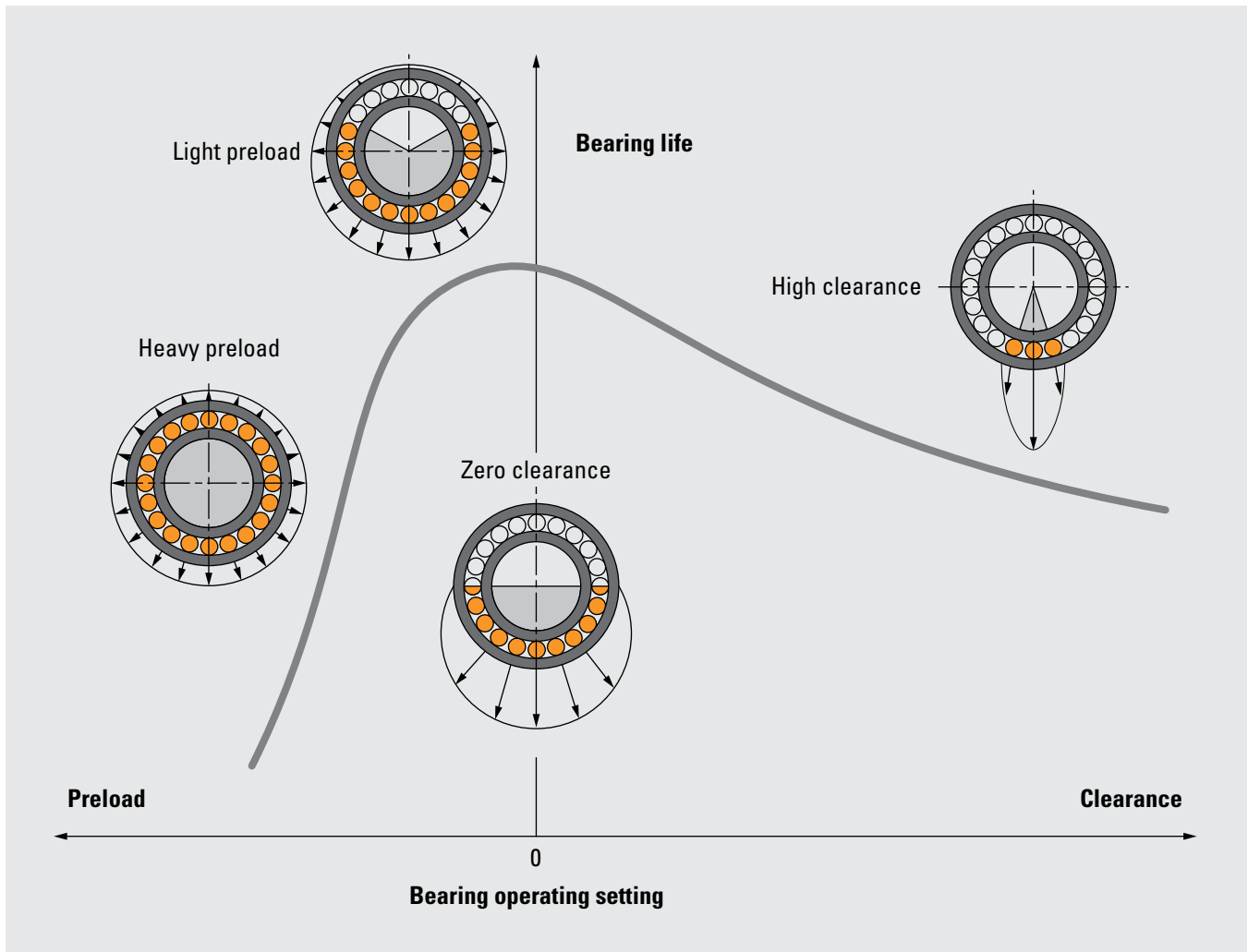

Bearing life vs. bearing operating setting.

GLOSSARY

Abrasive Wear

Usually occurs when foreign particles cut the bearing surfaces.

Adhesive Wear

Caused by metal-to-metal contact, resulting in scuffing or scoring of the bearing surfaces.

Angular Contact Ball Bearing

Ball bearing whose internal clearance and race location result in predetermined angle of contact.

Axial Endplay

The total relative measurable axial displacement of the shaft to the housing in a system of two angular contact bearings, such as angular contact ball bearings or tapered roller bearings.

Axial Internal Clearance

In radial bearing types, total maximum permissible axial displacement (parallel to bearing axis) of inner ring relative to outer ring.

Axial Load

Load acting in direction parallel with bearing axis. Also known as thrust.

Brinelling

A dent or depression in the bearing raceway due to extremely high-impact or static loads.

Brinelling – False

Wear grooves in the raceway caused by minute movement or vibration of the rolling elements while the bearing is stationary.

Bruising

The denting or plastic indentation in the raceways and rolling elements due to the contamination of foreign particles in the bearing.

Etching – Corrosion

Usually caused by moisture or water contamination and can vary from light staining to deep pitting.

Fatigue

The fracture and breaking away of metal in the form of a spall. Generally, there are three modes of contact fatigue recognized:

- Geometric stress concentration.
- Point surface origin.
- Inclusion origin.

Fillet Radius

Shaft or housing corner dimension that bearing corner must clear.

Fixed Bearing

Bearing which positions shaft against axial movement in both directions.

Floating Bearing

Bearing so designed or mounted as to permit axial displacement between shaft and housing.

Fluting

Electro-etching on both the inner and outer ring.

Fretting Corrosion

Usually occurs on the bores, outside diameters and faces of bearing races due to minute movement of these surfaces and the shaft or housing. Red or black oxide of iron is usually evident.

Housing Fit

Amount of interference or clearance between bearing outside surface and housing bearing seat.

Life

The theoretical bearing life expectancy of a group of bearings can be calculated from the operating conditions and the bearing load rating based on material fatigue. These calculations must assume that the bearings are correctly mounted, adjusted, lubricated and otherwise properly handled.

Misalignment

A bearing mounted condition whereby the centerline of the inner race is not aligned with the centerline of the outer race. Lack of parallelism between axis of rotating member and stationary member is a cause of misalignment, as are machining errors of the housing/shaft, deflection due to high loads, and excessive operating clearances.

Preload

The absence of endplay or internal clearance. All of the rolling elements are in contact or in compression with the inner and outer rings. Internal load on the rolling elements of bearing, which is the result of mounting conditions or design. Can be intentional or unintentional.

Radial Internal Clearance

In radial bearing types, the total maximum possible radial displacement (perpendicular to bearing axis) of inner ring relative to outer ring.

Radial Load

Load acting in direction perpendicular with bearing axis.

Scoring

Caused by metal-to-metal contact, resulting in the removal and transfer of metal from one component of a bearing to another. Various degrees of scoring can be described as scuffing, smearing, sliding, galling or any other sliding motion.

Shaft Fit

Amount of interference or clearance between bearing inside diameter and shaft bearing seat outside diameter.

Spalling – Flaking

A breaking away of metal on the raceway or rolling elements in flake or scale-like particles.

TIMKEN

The Timken team applies their know-how to improve the reliability and performance of machinery in diverse markets worldwide. The company designs, makes and markets bearings, gear drives, automated lubrication systems, belts, brakes, clutches, chain, couplings, linear motion products and related power transmission rebuild and repair services.

Stronger. By Design.

www.timken.com