

Titus Group  
Product brochure



**Titus**  
**Technologies**

# Contents

---

1	Automation Systems	1.1
2	Die Cast Technologies	2.1
3	Tooling	3.1
4	Titusonic	4.1
5	The Titus Group Profile	5.1

---

# Unique automated process solutions for a wide range of industries



Electrical industry

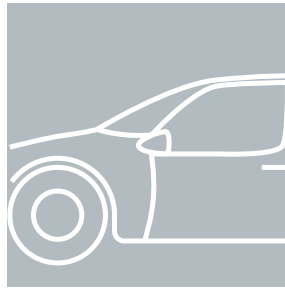

Automotive industry

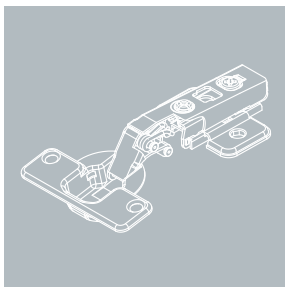

Metal processing

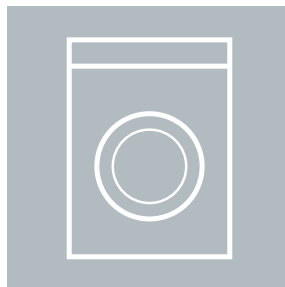

House-hold appliances



Medical devices

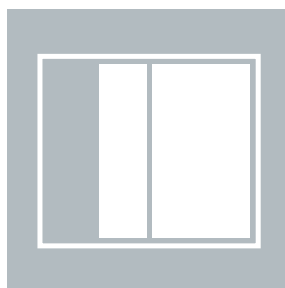

Furniture industry



## Small and precision components' engineering excellence

- Capable of solving the most demanding requirements
- Constant development of competences to keep pace with the latest technology advancements

## Design support

- Engineering support to adapt the product design for the most efficient assembly, maximized productivity, lower production costs and shorter time to market

# Automation Systems



## Proven Technology

- Our solutions have been used in own manufacturing of high-volume hardware and components for few decades
- The most demanding machine solutions are commissioned by our long-term partners

## Quality

- Integrated quality checks for consistent components quality
- Robust construction assures a life-long reliable functioning
- On-line monitoring system

## Fully Integrated Manufacturing

- Titus Group has the competence, experience and resources to offer support in all phases of the product life cycle: from product design to efficient high volume manufacture of small precision components

# Automation Systems

## Technical Guide

### Markets served

Automotive	Pedal box, turbo compressor, heating spark plug, handbrake, licence plate lamp, oil filter
Household appliances components	Heater, washing machine door block, switch circuit plate, hydrostat
Electro components	Electric motor, current electromagnet, switches, sockets, connectors, printed circuit board
Medical and pharmaceutical products with cleanroom requirements	Medical test tube, transducer
Metal processing industry	Concealed hinges, soft closing systems, window fittings
Furniture industry	Cam and dowels drilling and insertion
Other components	Dampers

### Machine building principles

Modifiability	The assembly system can be modified, rebuilt or upgraded with additional workstations during its lifecycle to suit the product redesign needs.
Integrability	The assembly system can be integrated into an existing manufacturing or warehousing automated system.
Versatility with self-adjustment	The machine can be programmed to allow the assembly of multiple product versions. The system will reset automatically according to the item number entered by the machine operator.
High productivity	All assembly system components, from construction frame through transport system, workstations and programming, are tailored to follow the productivity requirements of high-volume precision parts manufacturing.

#### Energy efficiency

Each working station on the machine operates through sensors' control to achieve optimal energy and compressed air supply.

#### Robust and rigid construction

Devised to suit high-speed and high-volume process, the sturdy steel construction of Titus automated assembly systems ensure a life-long high reliability of even the most precise operations, like measuring. Fewer downtimes contribute to lower maintenance costs.

It enables comfortable transport and short set-up times at customer premises.

#### Design support

Our team of engineers can provide support during the product development stage in order to ensure that products are engineered to maximize productivity, improve automation system, lower the manufacturing costs, and shorten time to market.

# Automation Systems

## Workstations

In many years of providing assembly solutions, we have solved a wide variety of technical challenges which has

provided us with a broad base of knowledge that we use to solve the most demanding tasks in automated assembly.

### Component handling

Pick and place units, robots

Rotation units, grips

Vacuum, electromagnetic, pneumatic and mechanical



Hydrostat transfer from blister to transport line

### Feeders

Vibrators, rotators, bowl and linear feeders

Special solutions



Unit that divides and doses miniature screw springs

**Mechanical operations**

Screw driving, orbital riveting, thread cutting, winding

To appropriate height or depth, moment or angle

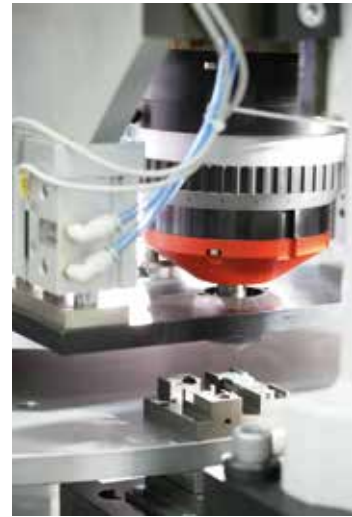

Riveting unit

**Dosing**

Liquids, silicone, paint, grease, oil, gels, powder, additives, sand

Precise filling of small quantities of various liquids or powders

Special solutions



Paint dosing

**Thermal processing**

Heating, drying, cooling

Air and water cooling, silicon drying, ultraviolet, induction heating



Cooling



# Automation Systems

## Workstations

### Welding and Connecting

Welding (TIG, ultrasonic), orbital riveting, gluing, soldering



Ultrasonic welding



Soldering

### Control and Testing stations

Finished part control or intermediate inspections

- Dimensions, temperature measurement
- Product shape
- Liquid, air sealing
- Strength
- Hardness
- Temperature
- Electrical resistance

Custom test stations for assembled part's functionality checks, built upon customer requirements.

Video inspection

Robot guided controls

Sensor control: inductive, optical an pressure sensors, flow and force meters, colour and contrast, temperature and laser sensors, acoustical/noise check



Pedal box robot video inspection

**Marking, labelling**

Mechanical stamping, ink-jet printers, laser printers

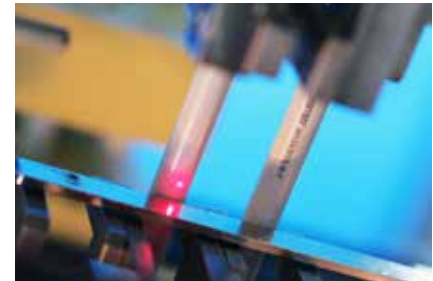

Laser labelling



Ink-jet printing

**Packing**

In boxes, smaller containers, blisters

- With packing track
- Mechanical, with robots,
- With or without counting of parts

**Process programming**

Our proprietary software “Monitoring” collects, elaborates and transfers the data to a PC. It enables events’ recording and statistical processing that are displayed in graphs, chart pies,...

It can be integrated with existing ERP and upgraded to allow for advanced functions.

All the equipment built in the line is freely programmable assuring line upgrade to specific needs.

ONLINE Service enables remote maintenance, diagnostics and program errors’ solving.

- Highly intuitive and user-friendly graphic interface
- Error history
- Display of alarm messages
- Interface language can be adapted to customer's request

**Our partners**

Festo, SMC, FDS, Bodmer, Links, Baltec, Trumpf, Baluf, Turck, Bosch, Miachi, Stöger, Deprag, Weiss, ABB, Epson

# Assembly Lines with Asynchronous Transport System

- When over 12 workstations are required
- When more parts will be assembled on a single line
- Free access to all workstations
- Easy feeding and delivery of components



Work stations are located consecutively in a line.

It can be built as a combined system with inclusion of indexing table assembly machines.

## Asynchronous transport system

One-lane or two-lane

Smooth, impact free motion sequence

Vertical or horizontal

Additional working stations can be added easily without having to disassemble the transport system.

Circle flow possible (KARE)

Precise and quick positioning at the workstation with precise pallet blocking system

## Pallets

The product is being assembled on a pallet transported between workstations.

## Coding

### Mechanical

A two-position system identifying parts with defect

### Electronic

Enables complex information storage. A plurality of signals are recorded allowing for identification of type of defect on the workpiece.

Signal read-out and encoding device emit control signal and direct the process. The piece can be excluded from the process or redirected according to type of mistake.

Samples of products



Electric motor



Washing machine door lock



Heating spark plug



Hydrostat



Medical test tube



Pedal box

# Rotary Indexing Table Assembly Machines

- Appropriate when up to 12 workstations are required
- Floor space saving
- High productivity
- Short delivery times



Work stations are located around a rotary indexing table.

Automated quality check can be positioned on all workstation.

Composition of two or more rotary indexing tables allows for compact design and more sub assembly stations when space is limited.

## NC rotary indexing table

Numerical controlled rotary indexing table that allows application of more than 12 workstations.

Samples of products



Window fittings



Soft closing system



Heater



Connectors

# Standard Modules

- Standard preassembled parts
- Faster construction and assembly of rotary indexing tables and assembly lines
- The possibility of subsequent installation in the line

## Rotary vibration feeder



Rotary vibration feeders ensure correct and fluent product flow and feeding of workstation.

Vibrators differ according to:

- dimensions of primary bases of vibrators and the dosing direction,
- types and sizes of bowls,
- types and sizes of noise insulation,
- types and height of bearers.

## Linear vibration feeder VP-13



For automatic filling of rotary vibration feeders.

The level of the filling in the rotary vibration feeder is controlled by the level probe.

Linear vibration feeder VP-13 is used for the line transport of different parts.

**Capacity**  
20 l

## Line vibration feeder VP-06



Line vibration feeder VP-06 is used as an extension for adding elements from the rotary vibration feeder to the workstation.

**Motorised stores and elevators**

For automatic filling of rotary vibration feeder.

The level of the filling in the bowl is controlled by the level probe.

The level probe switches on or switches off the electric motor of motorised store.

**Capacity motorised stores**

150 l

**Capacity elevators**

200 l

400 l

**Dosing modules****Description**

For automatic dosing of screws from rotary vibration bowls to a screwdriver unit.

The dosing module depends on the type and the size of dosing and on the size of rotary vibration feeder.

**Packing routes**

For handling of empty and full boxes.

Possibility of installing one or several packing units using a wide band transporter that supplies empty boxes onto the packing route.



# Complete multi-slide die casting solutions



## **Total in-house engineering expertise**

- Die cast machine design development and construction
- Tool design, tool making and sampling
- Integration of automation and robotics into the die cast process
- Component re-engineering capabilities available

## **Highly effective die casting machines**

- Fast cycling
- Very efficient tool/machine combinations
- Easy to operate
- Fast tool changes

# Die Cast Technologies



## Multi-slide die cast tooling

- In-house multi-slide tooling expertise
- In-house tooling facility
- High precision
- Complex form castings

## Multi-slide die cast processes

- Over-moulding machines
- Wheel weight machines
- Multi-slide machines
- Automatic ingot feeders
- In-process automation

## Custom die casting

- High quality components
- Zinc components from 1g to 1000g
- Dimensional consistency over high volume production runs
- Service tailored to individual customer requirements

# Die Cast Technologies

## Product Overview and Process Benefits

### Machines

#### Manufacturing systems for the die casting industry:

- Pneumatic multi-slide machines: 2 tonne locking force
- Hydraulic multi-slide machines: 20 tonne locking force
- Wheel balance weights machines
- Over-moulding machines

We believe our range of machines covers all user needs for the production of precision zinc die castings and can be used for component manufacture for a broad spectrum of industries.

### Multi-Slide Die Casting Technology

Our machines have up to 6 independently programmable tool movements; ideal for the production of small zinc die castings with complex forms.

The multi-slide approach enables castings of complex forms to be produced and can eliminate the need for secondary operations.

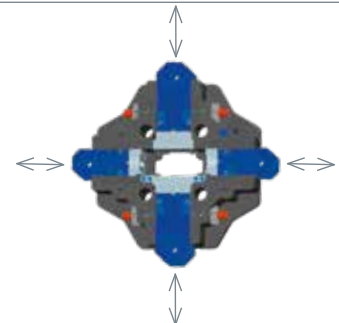

### Split Line Injection

#### Optimise raw material and process energy inputs

Injecting zinc at the tool split-line optimises process inputs. Less zinc is needed to manufacture components when compared with conventional machines and importantly less energy is required to re-process sprues.

Casting yields are considerably better than conventional die casting systems. Casting yields of up to 90% of raw material are possible.

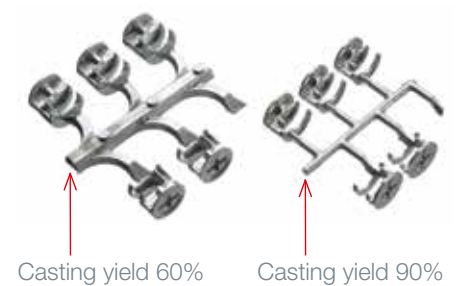

### Machine Controls

All machines are equipped with control systems that continually monitor machine performance in order to optimise production outputs:

- PC based touch screen operator interface
- PLC based machine control

The control system incorporates:

- 'Live' process feedback about machine performance
- Machine set up and programming
- Full fault analysis with error messaging system
- Machine controllers can be networked and machine performance can be remotely monitored
- Remote network support



**CombiCasting  
Zinc Over-Moulding**

Combi over-moulding uses zinc and steel raw materials to produce components made from a combination of both materials. In the over-moulding process a pre-formed steel insert is placed into a mould, then zinc is injected into the mould, covering all or part of the insert.

The resultant 'combi-style' products can have significantly improved performance and features. Also, raw material costs are reduced by the means of substitution, zinc is replaced with steel.

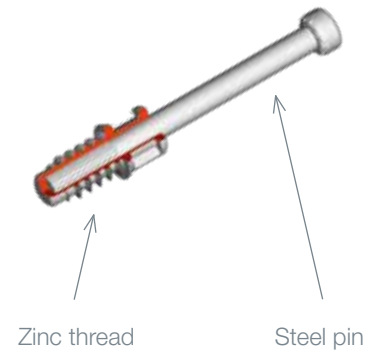

**Wheel Balance Weight Technology**

We can provide a complete range of production equipment for the manufacture of all types of balance weights:

- cast clip-on weights
- all steel clip-on weights
- steel adhesive weights
- zinc adhesive weights

The machines are fast cycling and have high output rates compared to traditional balance weight machinery.



**Custom Precision Die Castings**

Titus die casting machines have excellent performance characteristics which allow us to produce and deliver parts to the most demanding of quality standards. We can offer a custom die casting service from several locations around the world.

**Key features and advantages**

- high dimensional accuracy
- complex form castings
- complete range of post casting operations
- components from 1g to 1000g in zinc or aluminium

- zinc over-moulding technology
- custom die casting service tailored to individual customer requirements



**Build Quality**

All components used in the manufacture of our machines are specified and manufactured to the highest standards.

All bought in components used are branded products and are widely available.

Customisation of machine specification to suit customer needs.

Our equipment is built by qualified and experienced engineers within our ISO 9001:2008 certified manufacturing system. All machines are 'wet' run and fully trialled before they are shipped as are all of the multi-slide tools we produce ensuring trouble free start-ups.

# Hydraulic Multi-Slide Die Casting Machines

## Hydraulic multi-slides



- Powerful and accurate multi-slide die casting machine
- High productivity zinc die casting
- Split-line injection
- Castings with minimal porosity and excellent surface finish
- Quality consistency over high volume production runs

## LamaCaster H65

Ideal for the production of complex small zinc components that require the highest levels of surface finish with minimum porosity.

- Locking force: 8 tonnes
- Tool size: 100mm x 65mm
- Shot weight: up to 60g
- Dry cycle speed: 55 cycles per minute

## LamaCaster H100

Suited to four-slide production requiring minimal porosity and good surface finish.

- Locking force: 20 tonnes
- Tool size: 100mm x 100mm
- Shot weight: up to 225g
- Dry cycle speed: 55 cycles per minute

## Examples of castings



### Technical details

..... see page 2.10

### Accessories and spare parts

..... see page 2.9

# Pneumatic Multi-Slide Die Casting Machines

## Pneumatic multi-slides



- Fast cycling
- Low operating costs
- Split line injection
- Compact and flexible design
- High quality parts with complex forms
- Low capital investment costs and fast start up times

## LamaCaster 65

Delivers speed and repeatability in the production of small zinc components.

- Locking force: 2 tonnes
- Tool size: 65mm x 65mm
- Shot weight: up to 60g
- Dry cycle speed: 100 cycles per minute

## Examples of castings



### Technical details

→ see page 2.10

### Accessories and spare parts

→ see page 2.9

# Zinc Over-Moulding CombiCast Machines

## CombiCast machines



- Assembly of two parts in a single operation, usually steel inserts and zinc
- Fast feeding
- Assembly accuracy and strength
- Significant component's cost reduction
- 'Combi' casting technology can be used in conjunction with all LamaCaster hydraulic and pneumatic machines

## Lama CombiCaster

For the production of complex two-material components - zinc casting onto inserts made from another material.

- Locking force: dependant on machine
- Tool size: determined by product
- Shot weight: up to 60g
- Dry cycle speed: up to 100 cycles per minute

## Zinc over-moulding

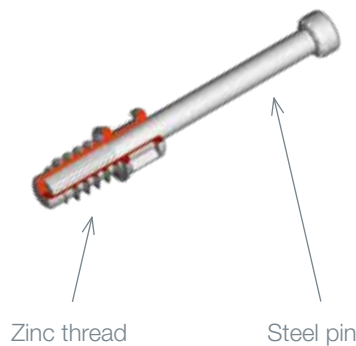

Over-moulding combines zinc and steel materials to form a completed part. The over-moulding process uses pre-formed steel inserts that are placed into a mould. The zinc material is then injected into the mould around the insert thereby forming the finished part.

Re-engineering an existing one-material product into a 'combi' product can improve the product features. The product performance can also be improved by using the most appropriate material for each product feature. An added benefit of 'Combi' cast technology is that it reduces dependence on a single raw material.

## Examples of castings



Combi dowel



### Technical details

..... see page 2.10

### Accessories and spare parts

..... see page 2.9

# Wheel Balance Weights Machines

<p><b>Wheel balance weights machines</b></p> 	<ul style="list-style-type: none"> <li>· Speed and repeatability in casting of zinc wheel balance weights</li> <li>· Compact and flexible design</li> <li>· Customized to individual customer product requirements</li> <li>· Fast production rates</li> <li>· High speed clip transport and feeding system with robotic option</li> <li>· Consistent part quality</li> </ul>
<p><b>LamaCaster BW60</b></p>	<p>For the production of 'clip-on' weights from 5g to 60g.</p> <ul style="list-style-type: none"> <li>· Production rate: Up to 1200 parts p/hr.</li> <li>· Tool size: 65 x 65mm</li> <li>· Dry cycle speed: 50 cycles per minute</li> </ul>
<p><b>LamaCaster BW30-2</b></p>	<p>For the production of 'clip-on' weights from 5g to 30g. Two cavity system that delivers higher production rates.</p> <ul style="list-style-type: none"> <li>· Production rate: Up to 2500 parts per hour</li> <li>· Tool size: 65mm x 65mm</li> <li>· Dry cycle speed: 50 cycles per minute</li> </ul>
<p><b>LamaCaster BW250</b></p>	<p>For the production of truck 'clip-on' weights up to 250g.</p> <ul style="list-style-type: none"> <li>· Production rate: 1000 pcs per hour</li> <li>· Tool size: 80mm x 60mm</li> <li>· Dry cycle speed: 40 cycles per minute</li> </ul>
<p><b>Wheel balance weights technology</b></p> 	<p>We can provide a complete range of wheel balance weights solutions for customer specific designs, including the assembly of adhesive blanks onto tape.</p> <p>LamaCaster technology provides lead free wheel weights solutions:</p> <ul style="list-style-type: none"> <li>· Zinc cast clip-on weights</li> <li>· Zinc adhesive weights</li> <li>· Steel clip-on weights</li> <li>· Steel adhesive weights</li> </ul>

**Technical details**

..... see page 2.10

**Accessories and spare parts**

..... see page 2.9



# Precision Die Casting

## Custom die casting service



Titus die casting machines have excellent performance characteristics which allow us to produce and deliver to our customers parts to the most demanding of quality standards. We can offer a custom die casting service from several locations around the world.

## Key features and advantages

- High dimensional accuracy
- Complex form castings
- Complete range of post casting operations
- Zinc components up to 1000 g
- Zinc over-moulding technology
- Value engineering and custom die casting service tailored to individual customer requirements

## Examples of castings



Technical details

→ see page 2.10

# Accessories and Spare Parts

<p><b>Automatic ingot feeder Integrated</b> For the controlled feeding of zinc ingots. Available on all LamaCaster die casting machines.</p>		<p><b>Capacity</b> up to 15 ingots (approx. 90kg)</p> <p><b>Feed rate</b> Maximum 6kg/min</p>
<p><b>Automatic ingot feeder Stand-alone</b> For use with most conventional die casting machines.</p>		<p><b>Capacity</b> up to 15 ingots (approx. 90kg)</p> <p><b>Feed rate</b> Maximum 6kg/min</p>
<p><b>Melt pot</b> For use on all Titus die casting machines.</p>		<p><b>Power rating</b> 18 Kw</p>
<p><b>Gooseneck – injection unit</b> For use on all Titus die casting machines.</p>		<p>Gooseneck re-conditioning service also available</p>
<p><b>Multi-slide die casting tools</b></p>		<p>See page 3.5</p>

# LamaCaster Machine Specification

	Hydraulic die casting machines		Pneumatic die casting machines	Die casting machines for wheel balance weights			Zinc over moulding machines
	LamaCaster H65	LamaCaster H100	LamaCaster 65	LamaCaster BW60	LamaCaster BW30-2	LamaCaster BW250	Lama CombiCaster
<b>Slide Movemet/ Tool</b>							
No. of slides	4	4	4	4	4	3	2
Max. stroke (theoretical)	50 mm	50 mm	40 mm	38 mm	38 mm	40 / 900 mm	40 mm
Locking force	8 t	20 t	2 t	2 t	2 t	2 t	2 t
Nominal die size	100 x 65 mm	100 x 100 mm	65 x 65 mm	65 x 65 mm	65 x 65 mm	60 x 60 mm 80 x 60 mm	65 x 65 mm
No. of cavities				1	2	1	
<b>Melt pot</b>							
Heat power	18 kW	24 kW	18 kW	18 kW	18 kW	24 kW	18 kW
Melt rate	80 kg/hr	105 kg/hr	80 kg/hr	80 kg/hr	80 kg/hr	80 kg/hr	80 kg/hr
Melt pot capacity	160 kg	160 kg	160 kg	160 kg	160 kg	160 kg	160 kg
<b>Pneumatics / hydraulics</b>							
Line pressure (max.)	120 bar	8 bar / 120 bar	8 bar	8 bar	8 bar	8 bar	8 bar
Air consumption	25 m3/hr	50 m3/hr	100 m3/hr	54 m3/hr	54 m3/hr	30 m3/hr	100 m3/hr
Capacity of air reservoirs	12 l	12 l	18 l	18 l	18 l	18 l	18 l
Dry cycle speed (cycles per/min.)	55	55	100	50	50	40	100
<b>Injection</b>							
Injection piston diameter	25.4 mm	25.4 / 40 mm	25.4 mm	25.4 mm	25.4 mm	50 mm	25.4 mm
Injection cylinder diameter	63 mm	63 mm	100 mm	100 mm	100 mm	100 mm	100 mm
Max. injection cylinder stroke	30 mm	45 mm	30 mm	30 mm	30 mm	30 mm	30 mm
Max. shot weight (theoretical)	100 g	360 g	100 g	108 g	108 g	360 g	100 g
Max. recommended shot weight	60 g	225 g	60 g	60 g	60 g	250 g	60 g
<b>Nozzle</b>							
Heat power	500 W	500 W	500 W	500 W	500 W	500 W	500 W
<b>Power supply</b>							
Three phase	50 amps 400 V	50 amps 400 V	32 amps 400 V	32 amps 400 V	32 amps 400 V	50 amps 400 V	32 amps 400 V



# Engineering and production of tooling for various industries



## **Gravity tools for turbochargers**

- High productivity
- Excellent mechanical properties of the product

## **High precision construction**

- Optimal tool design
- High productivity
- Reliable tool performance

# Tooling

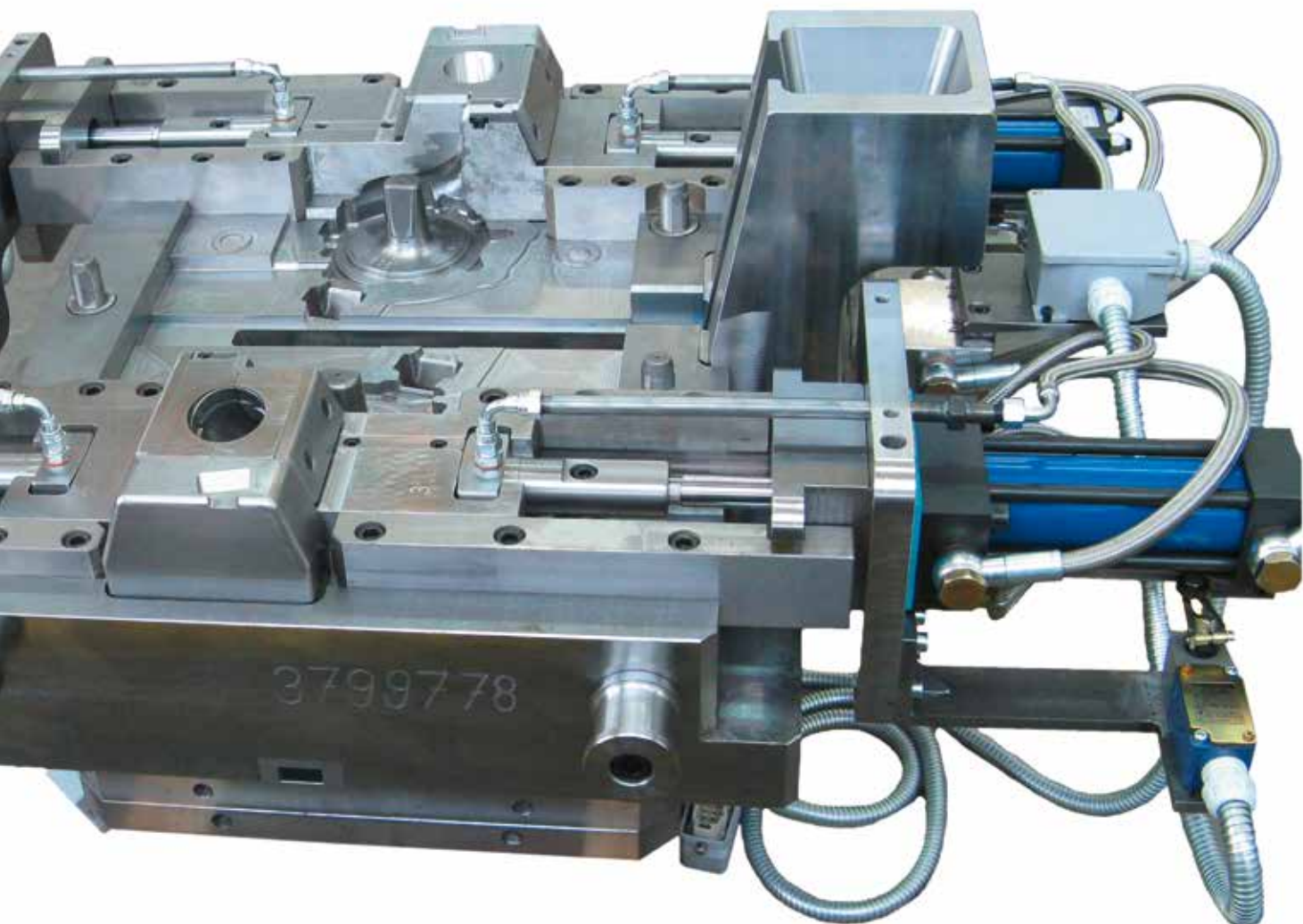

## Innovative turnkey solutions

- Tailored to unique customer needs
- High quality of products made by our tools

## Full support to our customers

- In the planning process
- During the implementation phases
- After the tool is in production

## Tool service

- Assistance to improve tools' performance
- Assistance in development of new products' tools
- Regular maintenance and service

# Tooling

## Technical Guide

### Markets served

Automotive industry

Tools for:

- turbochargers: housings, cores and volutes
- engine mounts
- headlight supports
- hinges for automobile hood
- wheel balance weights (wheel equipment)
- motorcycle front forks: housings and cores
- motorcycle engine cover

Electric

- axels
- housings
- contacts
- supports and housings for lights

Household appliances

- washing machine door hinge

Metal working

- furniture connectors
- concealed hinges
- dampers
- wire joiners

Toy industry

- manual typewriter

Die casting industry

- tools, melt pots, goose necks

Automation systems

- standard modules and transport
- pallets for assembly lines

### Design and building of tools

We conform to following principles and methods:

**APQP** (advanced product quality planning) and **PPAP** (production part approval process) – method of approving production process that is capable of consistently producing a conforming product.

**FMEA** (failure mode and effect analysis) of products and processes

**SMED** (single minute exchange of die)

### Software equipment

At tool construction and design we use the most advanced software solutions and 3D CAD/CAM design software. The CAD software used is Pro/Engineer and the CAM system is Mastercam. This allows us to offer the highest level of design quality and building of customized tools. Optimal tool design and construction provide high productivity and long life of a tool.

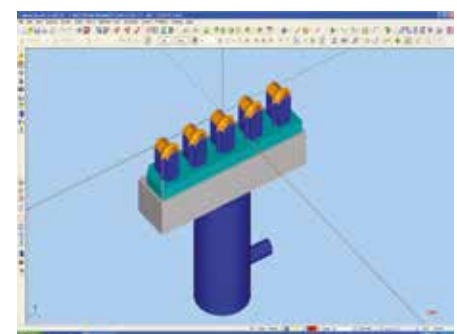

**Manufacturing equipment**

Tools are manufactured using advanced CNC machines: MahoDeckel, Charmilles, Agie, Hauser and Jung.

We are equipped with a 3D DEA coordinate measuring machine for inspection and Mytutoyo optical measuring machine.

operation	model	manufacturer	workpiece weight (max)	X max (mm)	Y max (mm)	Z max (mm)	4. os max (mm)	5. os max (mm)	N max	Control
CNC milling	VCP710	Micron	1600	710	650	450	table rotation		20.000	TNC 430
	DMU80P	Deckel-Maho	800	800	700	600			18.000	TNC 426
Coordinate grinding	S3	Hauser	/	400	250	100	/	/	/	CNC314
Die Sinking	Roboform 200	Charmilles	500	320	220	320	/	/	/	Roboform
Wire erosion	Classic	Agie	450	350	250	250	70	90		Agie Vision
	Challenge	Agie	400	500	350	250	70	90		Agie Vision
Profile grinding	JF520 MS	Jung	50	450	175	250	/	/	/	/
Measuring machine	Gama 1202	DEA	/	1050	950	650	/	/	/	/
Die sinking	Roboform 550S	Agie	1600	600	400	450	/	/	/	FAWC180 IWB

**Operations**

standard processing methods	X max (mm)	Ymax (mm)	piece	
Grinding	Surface grinding	750	250	1
	Surface grinding	800	500	1
	Surface grinding	250	500	1
	Surface grinding			1
Milling	Milling machine	900	350	5
	Milling machine	2000	700	1
	Copying Milling	360	200	1
Turning	Lathe			2
Sawing	Sawing machines			1
Drilling	Precise drilling	600	400	1
	Drilling machines			3
	Auxiliary drilling machines			1
Sandblasting	Sandblasting machine			1



# Gravity Die Casting Tools

- Precise tooling with tight tolerances
- Ability to cast complex product shapes
- Dimensional accuracy and repeatability of castings
- The highest level of flexibility in tool construction

## Gravity die casting tools

We specialize in design and construction of turbo charger housings, coring and volutes.

### Max. tool size

Depends on customer request

### Weight of castings

Up to 15kg



## Aluminium castings from our tools



turbo charger cores and housing

motorcycle back fork housings and cores

motorcycle engine cover

engine mount

# High Pressure Die Casting Tools

- High precision
- High productivity
- Dimensional consistency over high volume production runs
- For the manufacturing of components from 1 to 1000g

<p><b>Conventional tools</b></p>	<p>Nr. of slides depends on product specifics.</p> <p>For machines with locking force up to 120 tonnes and max line pressure 300 bar.</p> <p>To be used with zinc alloys.</p>	<p><b>Max. tool size</b> 800 x 600 x 600mm</p> <p><b>Weight of castings</b> Up to 1000g</p>
<p><b>Multi-slide tools</b></p> 	<p>Up to 5 slides.</p> <p>For machines with locking force up to 2 tonnes and line pressure up to 8 bar.</p> <p>To be used with zinc, lead or tin based alloys.</p>	<p><b>Max. tool size</b> 300 x 300mm</p> <p><b>Weight of castings</b> From 60 to 225g</p>

## Castings made by our tools



wheel weights for automobiles and trucks

furniture fittings

parts for electric appliances

components for automotive

# Stamping Tools

- High precision
- Long life expectancy
- High productivity levels
- Wide range of applicability

## Progression tools



The most suitable method of designing new tools is chosen on the basis of customer's sketch or 3D model.

**Max. tool size**  
2500 x 1000 x 700mm

**Strip thickness**  
up to 6mm

## Transfer tools



Design and construction includes tooling and a transfer system.

**Max. tool size**  
3000 x 1500mm

### Protective hard coatings

To improve tool life expectancy and productivity

- In highly demanding applications
- On high volume tools

**Strip thickness**  
up to 2mm

## Deep drawing stamping tools



We advise the most suitable number of tool steps to ensure:

- Good performance
- Long life expectancy
- High product quality

**Max. tool size**  
2500 x 1000 x 700mm

**Strip thickness**  
up to 2mm

Design and manufacture of tools for cold bending of sheet metal.

## Castings made by our tools



Tools for furniture fittings, automotive industry and other industries

# Plastic Injection Mould Tools

- High production rates
- Repeatable high tolerances



Tools for production of parts from thermoplastics.

**Max. tool size**  
1000 x 1000mm

## Thermoplastic products made by our tools



Plastic parts for house-hold appliances, automotive products, furniture hardware, electroindustry

## Clean and fast assembly of furniture cabinets

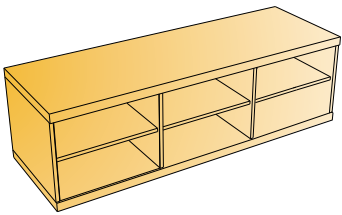

Rigid cabinet assembly

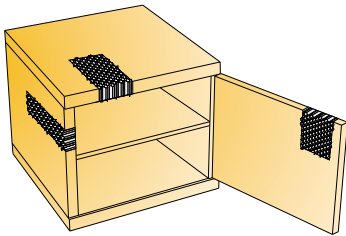

Frameless Hollow Core Board assembly



### Revolutionary ultrasonic fastening

- Faster
- Cleaner
- Stronger

### Advantages over traditionally glued dowels

- Bonds in three to four seconds
- Exceptional strength

# Titusonic Technology

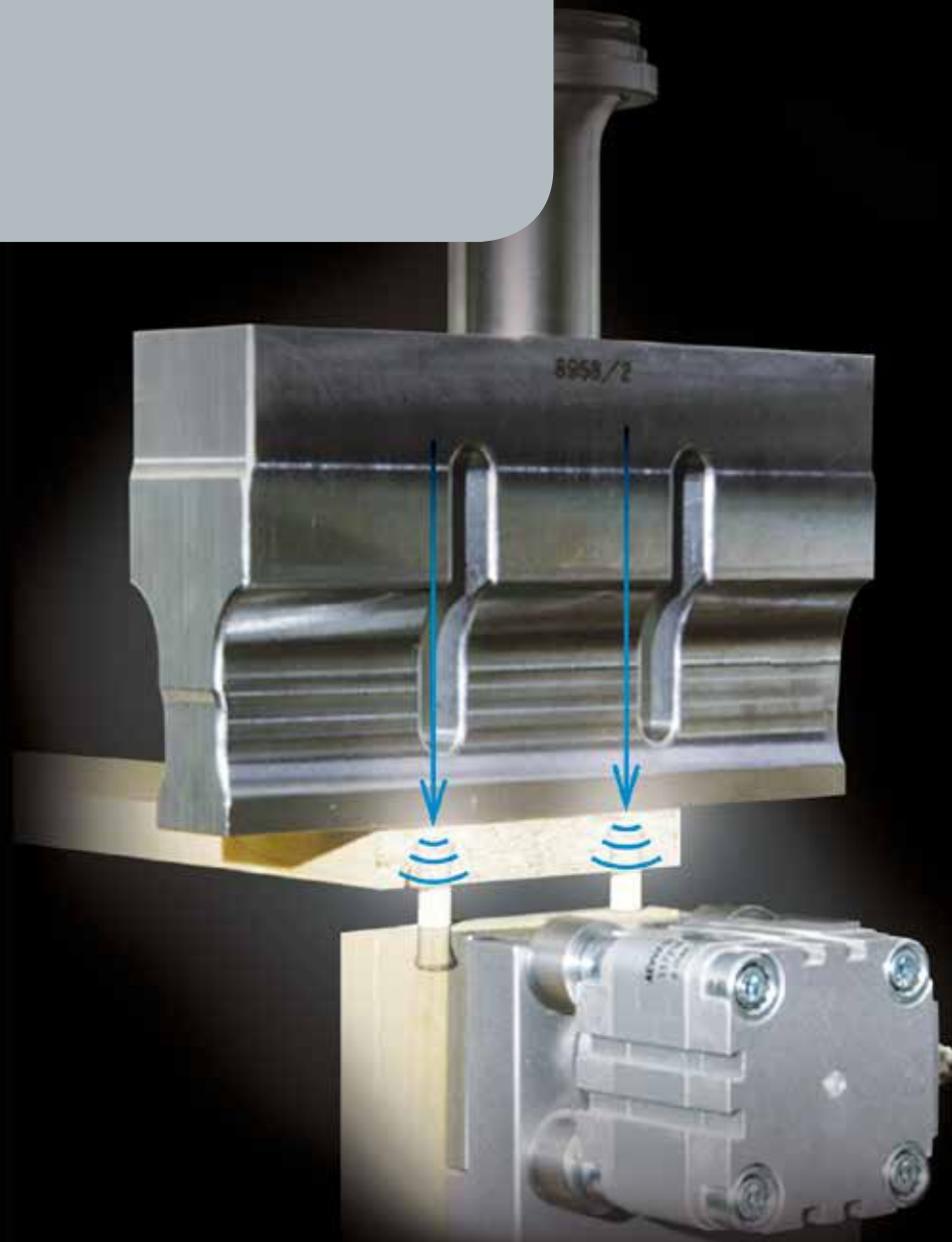

## Quality assured

- The Titusonic process utilizes a Statistical Process Control (SPC) to monitor performance
- Each pressing is recorded and can be checked for quality reasons at any time

## Can be applied to most wood based materials

- MDF, HDF
- Chipboard
- Most solid woods
- Plywood
- Frameless HCB

## HCB fastening with Ultrasonics

- Doesn't require inner frame for fastening strength
- Can be applied in random positions
- Can be tailored to anchor most conventional fittings

# The Fastening Revolution

## Technology

### Titusonic®

Is a part of the Titus Group which has been involved in design and manufacture of connectors for the furniture market for over 30 years. Titusonic® products are based on the revolutionary WoodWelding® fastening process for ultrasonically bonding wood materials without the use of adhesives, providing

The advanced process can be adapted into many product categories with the first two industrial applications in wood technology being Titusonic® cabinet fastening (Sonic Rivet) and Titusonic® Hollow Core Board (HCB) fastening, jointly developed with and licensed from WoodWelding SA, Switzerland.

**Exceptional strength**  
**Speed of fastening**

---

### Ultrasonic process

When using the WoodWelding® process ultrasonic energy of approximately 20.000 cycles per second is applied. Adding pressure to the process, the liquified plastic connector element is forced into the wood utilising the natural porosity of most wood based materials such as chipboard, MDF, HDF and plywood. Most solid woods can also be used with this process, which takes only seconds to complete.

Traditionally wood products are joined together using mechanical fasteners such as wooden dowels and glue, screws or other connecting fittings. However these methods produce their own problems, which are largely resolved by the use of WoodWelding® technology. It takes fastening of wood products into the 21<sup>st</sup> century with a process which can be likened to welding of steel in car manufacture and shipbuilding.

# Titusonic® Cabinet Assembly

## Ultrasonic fastening

### Titusonic® Sonic Rivet



The Titusonic® Sonic Rivet replaces the commonly used wooden dowel and glue in the construction of cabinets and other furniture products.

### Fastening process

The WoodWelding® process uses a plastic dowel – Titusonic® Sonic Rivet, which is simply inserted in one side (no glue) and the panels pre-assembled and then placed in the press.

### Pre-assemble the cabinet and place it into the press

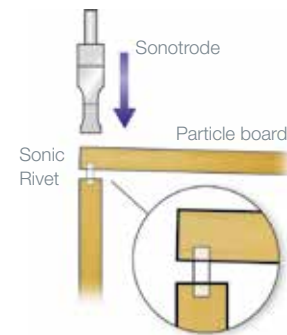

Pressure is applied to the joint whilst the ultrasonic energy is activated. The process time is about 1-2 seconds during which time the plastic dowel melts only at the ends and the plastic integrates with the chips in the particle board so that it bonds the boards together.

### Ultrasonic energy bonds the boards together

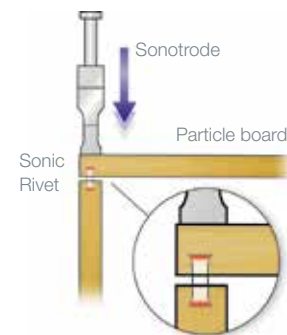

There is then a very short dwell time of about 2 seconds when the dowel shrinks in length so as to provide an additional clamping force (pulling together of the joint). The cabinet can then exit the press and is at full strength so it can be handled in a normal way and indeed instantly packed and despatched to the customer.

### After 2 seconds of dwell time the cabinet can exit the press

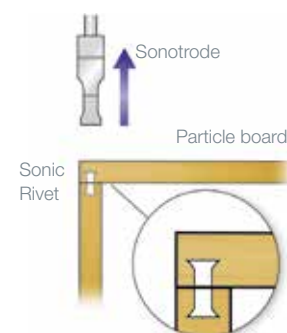



# Titusonic® Sonic Rivet

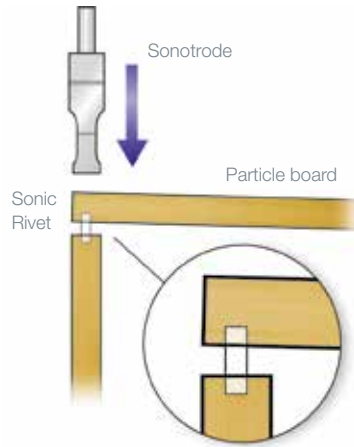
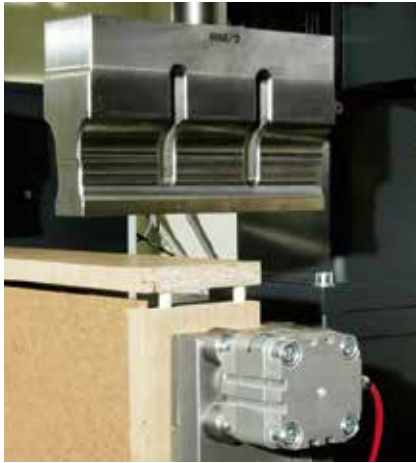
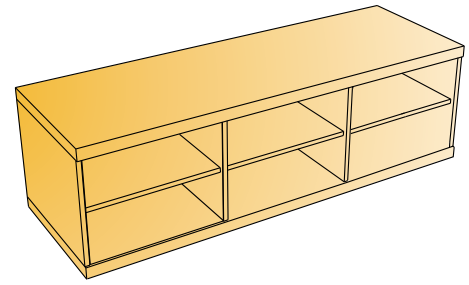

The Titusonic® Sonic Rivet or “Hidden Dowel” has four key advantages over traditional methods of cabinet assembly. It is:

### Quicker

The complete cycle time through a production press can be improved by between 3 and 6 times. The dwell time in a traditional press can be between 20 and 60 seconds waiting for the glue to go off sufficiently. The dwell time for the new Titusonic® dowel is about 2 seconds. The difference is made up of delivery and exit times from the press which are not altered by this process.

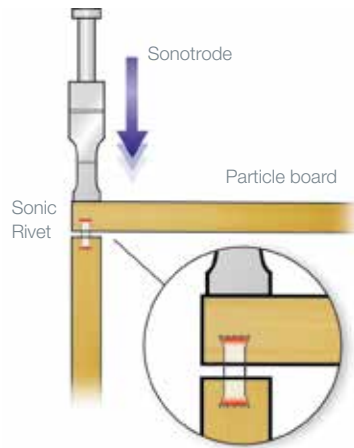

### Stronger

The product is approximately 30% stronger than its traditional wooden dowel rival.

### Cleaner

No more glue! This simplifies machinery and eliminates clean down at end of shift. Much furniture needs cleaning of glue which has spread.

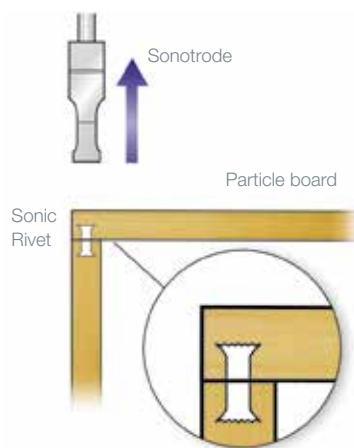
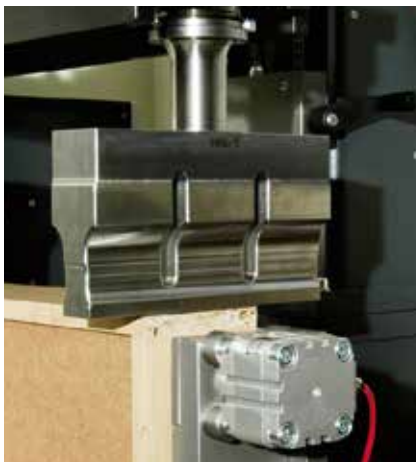

### Repeatable / Measurable

The new product is an engineered process. The old product is wood and glue which varies according to a number of factors. The new product is more reliable, repeatable, with performance that is more recordable, measurable and traceable for quality purposes.

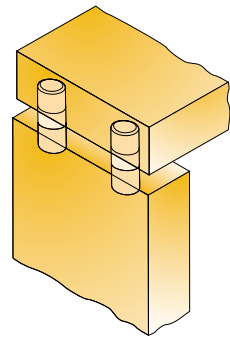

**Titusonic® Sonic Rivet**



Made of plastic

Dimensions (mm)	Item number
Ø6 x 30	SR 0716
Ø6 x 40	SR 0726
Ø8 x 30	SR 0712
Ø8 x 40	SR 0725

**Ligmatech MDE120 cabinet press with ultrasonics**



# Titusonic® Sonic Insert

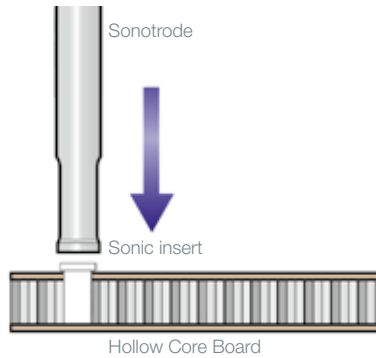
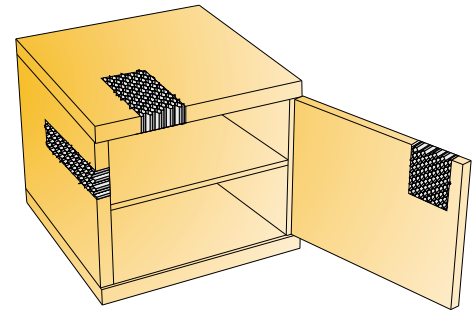

Hollow core boards (HCB) have slowly been introduced into furniture over the last 15 years and a few leading manufacturers have invested heavily in the production and use of this new type of light weight panel. These first HCB production lines demand the use of a frame to support and separate the thin panel surfaces and to enable edgebanding to be applied with conventional machines. These frames also enable the use of conventional hardware such as assembly fittings, hinges and drawer runners which can be attached to them. However the frames are expensive to fabricate and heavy, so defeat the prime benefit of HCB which is to provide a panel which is as light as possible.

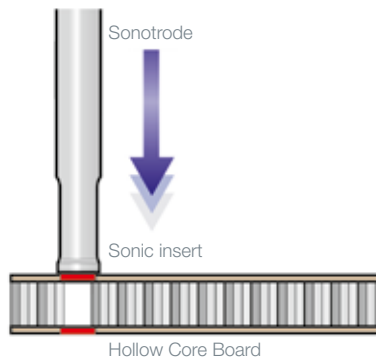

## Frameless HCB

The two main problems in the use of frameless HCB are:

- **How to apply an edge**
- **How to assemble the boards and fasten fittings into them**

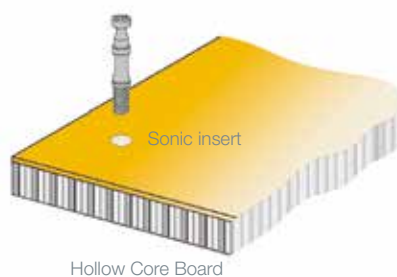

Titusonic® is offering a revolutionary fastening solution – WoodWelding® Technology. The process focuses the ultrasonic energy onto specific locations on a plastic insert or fitting so that with applied pressure it melts into the porous surfaces of the HCB, at both the top and bottom of a blind hole (see illustration) in about 1 second and then solidifies in 1-2 seconds more. The process is fast, consistently gives strong results and eliminates the need for glue. This provides the ultimate solution as Titusonic® inserts can be placed in random positions on a HCB panel providing the flexibility that furniture designers require.

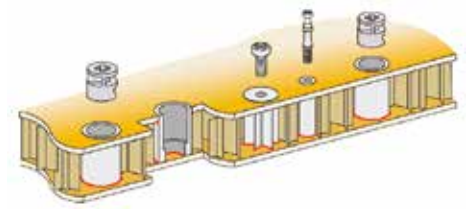

		Dimensions (mm)	Item number
<b>Sonic Insert Dowel mount</b>  Made of plastic		Ø10 x 38	SI 0607
<b>Sonic Insert Cam house</b>  Made of plastic		Ø18 x 38	SI 0608
<b>Sonic Insert Round</b>  Made of plastic		Ø25 x 19 x M5	SI 0616
		Ø25 x 22 x M5	SI 0611
		Ø25 x 30 x M5	SI 0610
		Ø25 x 50 x M6	SI 0602
		Ø40 x 50 x M6	SI 0618
		Ø40 x 50 x M8	SI 0621
<b>Sonic Insert Spoked</b>  Made of plastic		Ø25 x 30 x M5	SI 0609
		Ø25 x 50 x M6	SI 0603
		Ø40 x 50 x M6	SI 0619
		Ø40 x 50 x M8	SI 0622

**Gateway 1000/2000**  
Titusonic® table press  
for small volume application



**Weeke ABL210 stop-go line**  
for drilling and insertion of  
Titusonic® HCB inserts





# The Titus Group Profile

# Titus Group

Titus focuses on the design, manufacture and distribution of connectors, concealed hinges drawers and soft closing mechanisms in furniture and household appliances.

Titus Group is owned and managed from its headquarters in United Kingdom. We are able to provide products and services to every customer around the world based on manufacturing facilities in Europe, North America, China, SE Asia, Australia and New Zealand.

**Quickfit technology makes Titus the World leader in connectors for RTA furniture**

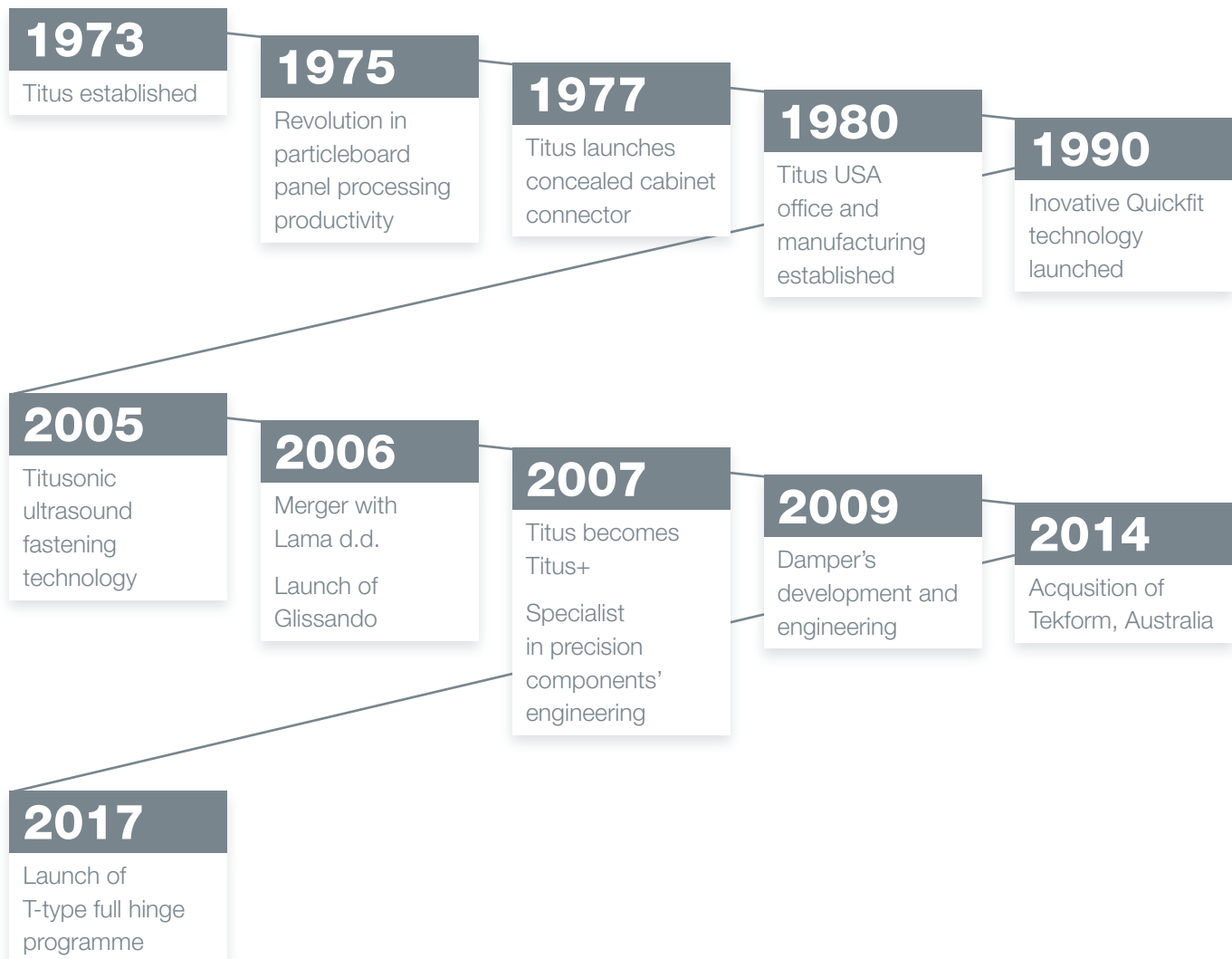

## Vision

The world's best engineering for precision components

## Mission

To provide manufacturers with components' solutions that improve competitiveness

## Titus Business Philosophies and Principles

- Gain total knowledge of our customers and their markets
- Focus on identifying and creating high volume component niches
- Meet our customers' expectations with global consistency
- Build long term associations with customers, suppliers, colleagues and shareholders
- Invest in the abilities of individuals at every level
- Continuously enhance input efficiency and sustainability

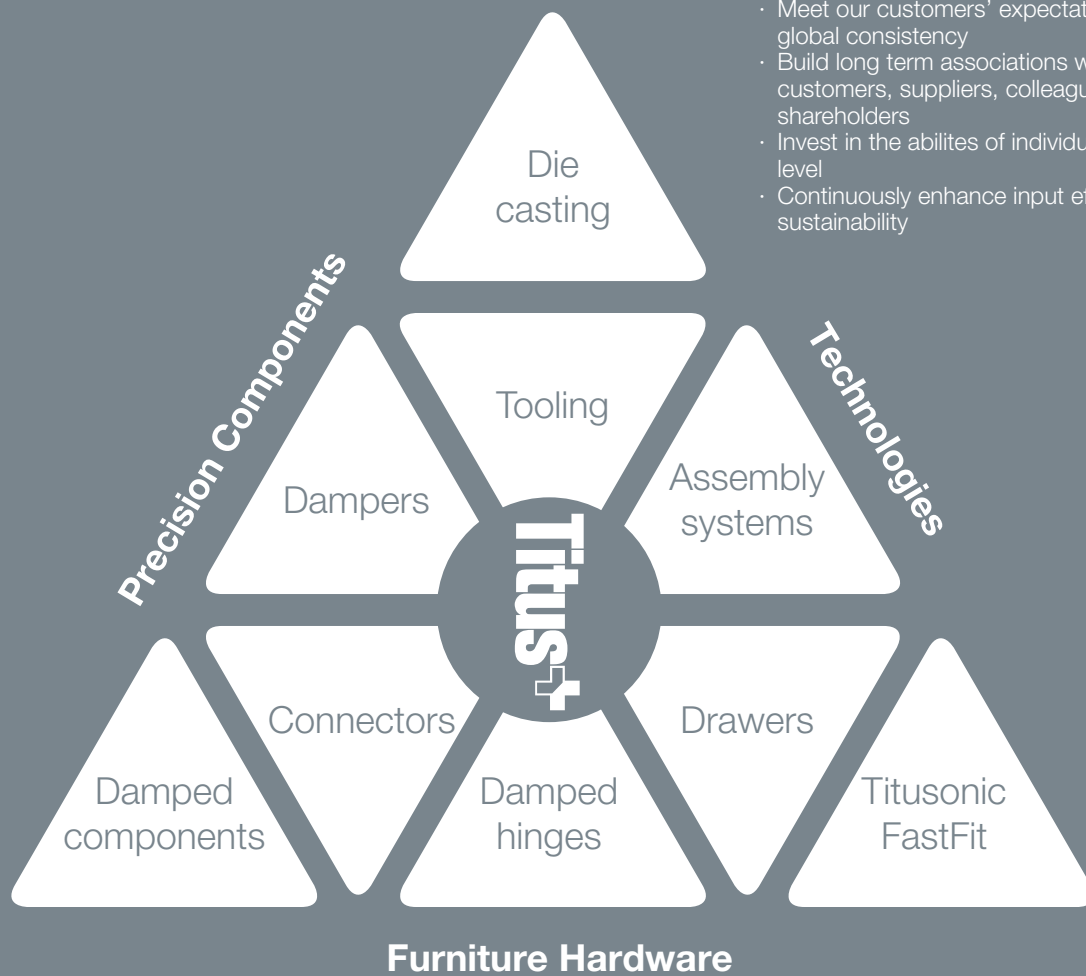

## Furniture Hardware

- Cabinet connectors
- Concealed hinges
- Soft closing systems
- Drawers and drawer systems
- Kitchen accessories
- Furniture locks
- Decorative

## Components

- Dampers
- Precision components

## Technologies

- Automation systems
- Precision castings
- Die cast technologies
- Tooling
- Ultrasound fastening technology
- FastFit technology



# 'Totally Integrated Engineering'

## Product Design

Design and engineering of unique components  
Consistent and repeatable product quality

## Manufacturing Technologies

to improve productivity and product quality

## Manufacturing Operations

A wide array of technologies and services required for high volume production of precision components available in-house

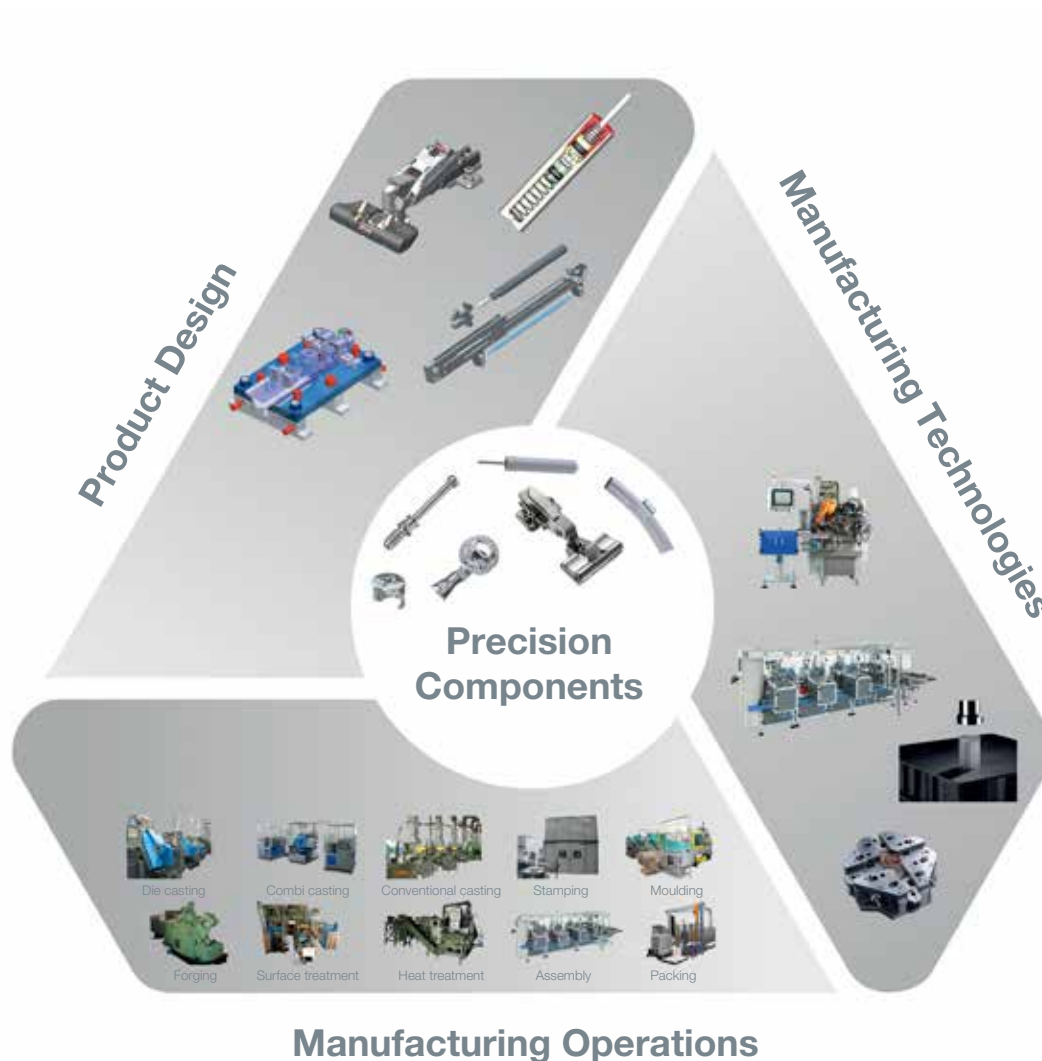

## Fittings for purpose

Unique product advantages for better value for money and lower 'total installed cost'

## Innovations that improve

with less parts, less different parts, less preparation actions, faster assembly

## Fast time-to-market

# Quality

## Continuous Improvement

The Titus Group Mission, to improve the competitiveness of our customers, encourages us to continuously improve our products, services, processes and competencies of our employees.

## Quality

We believe that the Titus Mission is achieved most effectively through the management of our design, manufacturing and service activities in conformance with the ISO 9001 standard for quality management. Quality has a broad meaning for us: it is our guide to the selection of materials, work, processes, internal relations and cooperation with partners.

## Products

Our integrated quality system produces technically optimized products of high quality. They are assessed regularly in our own test labs as well as by internationally renowned institutions, such as LGA from Germany, CTBA from France, FIRA from United Kingdom, CATAS from Italy, AIDIMA from Spain, and others.



# Global Sales, Distribution and Engineering Support

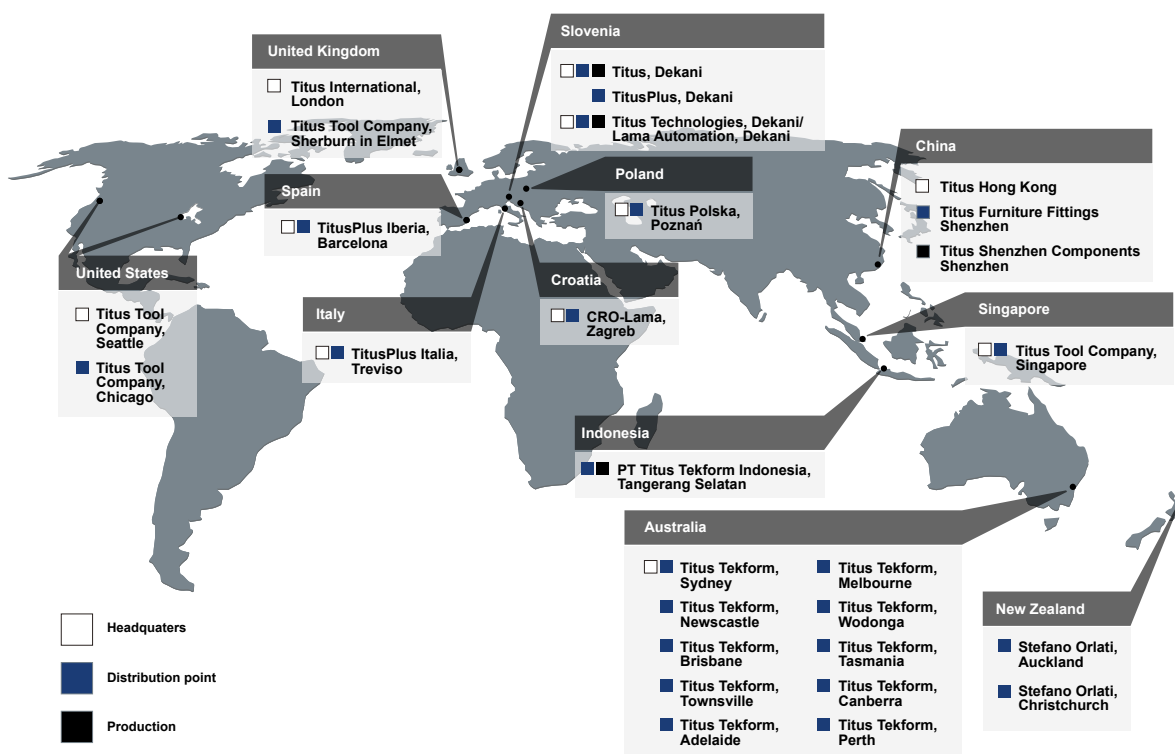

## Europe

**TitusPlus d.o.o.**  
 Dekani 5  
 SI-6271 Dekani, Slovenia  
 +386 566 90 213  
 +386 566 90 205 Fax  
 info@titusplus.com

**Titus d.o.o. Dekani**  
 Dekani 5  
 SI-6271 Dekani, Slovenia  
 +386 566 90 213  
 +386 566 90 205 Fax  
 info@titusplus.com

**Titus Technologies  
 Lama Avtomatizacija d.o.o.**  
 Dekani 5  
 SI-6271 Dekani, Slovenia  
 +386 566 90 146  
 technologies@titusplus.com

**Titus Tool Company Ltd.**  
 10 Blackburn Industrial Estate  
 Enterprise Way  
 Sherburn in Elmet  
 LS256NA, United Kingdom  
 +44 1977682 582  
 +44 1977680 481 Fax  
 uk@titusplus.com

**CRO LAMA d.o.o.**  
 Rakitska 10a  
 Rakitje  
 HR-10437 Bestovje, Croatia  
 +385 1 3323 033  
 +385 1 3323 233 Fax  
 croatia@titusplus.com

**Titus Polska Sp. z o.o.**  
 ul. Stefańskiego 17 A  
 PL-62-002 Suchy Las/Poznań  
 Poland  
 +4861 811 5402 Phone/Fax  
 +4861 811 5684 Phone/Fax  
 +4861 821 9362  
 poland@titusplus.com

**TitusPlus Italia S.r.l.**  
 Via Aquileia 9  
 Frazione Olmi  
 31048 San Biagio di Callalta (TV)  
 +39 04 221 650 120  
 +39 04 221 650 136 Fax  
 italia@titusplus.com

**TitusPlus Iberia S.L.U.**  
 C/ Luxemburg 16,  
 08520 Les Franqueses del Valles  
 +34 938 715 404  
 +34 670 349 774 Mobile  
 iberia@titusplus.com  
 www.titusplusiberia.com

## America

**Titus Tool Co. Inc.**  
 2800 156th Avenue SE  
 Suite 135  
 Bellevue, WA 98007, USA  
 800 762 1616 toll free  
 +1 425 746 2080  
 +1 425 746 2344 Fax  
 usa@titusplus.com

**Titus Tool Co. Inc.**  
 11056 W. Addison Street  
 Franklin Park, IL 60131, USA  
 +1 253 872 2829  
 +1 253 872 2827 Fax  
 usa@titusplus.com

## Australia

**Titus Tekform Pty Ltd**  
 Unit 1, 41-43 Whyalla Place  
 Prestons NSW 2170  
 Australia  
 +61 2 9286 0007  
 +61 2 9826 0074 Fax  
 www.titustekform.com.au  
 info@titustekform.com.au

**Stefano Orlati NZ**  
 34 Waipareira Avenue  
 Henderson  
 Auckland, New Zealand  
 +64 9 837 0886  
 +64 9 837 8003Fax  
 www.titustekform.com.au  
 info@titustekform.com.au

## Asia

**Titus Tool Co. Pte. Ltd.**  
 5004 Ang Mo Kio Ave 5  
 Techplace II #04-01  
 Singapore 569872  
 +656383 3922  
 +656383 3178 Fax  
 singapore@titusplus.com

**Titus Shenzhen Components Co. Ltd**  
 1st Floor, Building No.2,  
 Heng Changrong High-tech Industrial Park  
 ShangNan South Road  
 Shangjin Street  
 Baoan District Shenzhen Province  
 PRC  
 +86 755 8348 0916  
 +86 8359 2676 Fax  
 china@titusplus.com

**PT Titus Tekform Indonesia**  
 Taman Tekno Blok L2 / 7  
 BSD Sektor XI - Tangerang 15314  
 Indonesia  
 T. +62 21 7587 3578  
 F. +62 21 7587 3574  
 Indonesia@titusplus.com

## Headquarters

Titus International Ltd  
 325 Euston Road  
 London  
 NW1 3AD, United Kingdom  
 info@titusplus.com

www.titusplus.com  
 info@titusplus.com

# Important Information

## **General Terms and Conditions**

Terms and conditions of sale of items from the catalogue are subject to valid General Terms and Conditions of Lama Avtomatizacija d.o.o. which are published on [www.titusplus.com](http://www.titusplus.com).

## **Product Information**

The details and information stated in the product catalogue shall only be deemed legally binding element of any contract with the customer only if the contract expressly refers to such details and information.

## **Intellectual Property**

Titus International reserves all intellectual property rights worldwide for all information contained in this catalogue.

## **Trademarks**

Titus and Titusonic are registered trademarks of Titus International Ltd. Lama is a registered trademark of Lama d.d. Dekani. Woodwelding is a registered trademark of WW SA.

# Notes

Lined area for writing notes, consisting of 20 horizontal lines.



*Your authorized dealer*

Titus Group  
[www.titusplus.com](http://www.titusplus.com)

Titus Technologies 01.3 ENG June2018