



OWNER'S GUIDE



MXT/MXT 300

*White's Electronics, Inc. -
Manufacturers of the World's Finest Metal Detectors*

To see complete details or to purchase the White's MXT Standard Metal Detector, visit:
<http://www.metaldetector.com/whites-mxt-standard-metal-detector>

To see complete details or to purchase the White's MXT Standard Metal Detector, visit:
<http://www.metaldetector.com/whites-mxt-standard-metal-detector>

MXT Table of Contents

Chapter 1 Assembly	2
Assembly Instructions	3
Chapter 2 Batteries	4
Standard Battery Holder	4
Using the	
Standard Battery Holder	4
Rechargeable Battery (Opt.)	5
Battery Check	5
Chapter 3 MXT Quick Start	6
Chapter 4 Display	8
Coin & Jewelry	8-9
Relic	10-11
Prospecting	12-13
Chapter 5 Controls	14
Mode	14-15
Trac.....	16-17
Gain.....	18-19
Dual Control	20-22
Disc	20-21
SAT	22
Threshold.....	23
Chapter 6 Searching	24
Pinpoint Technique	24
Headphones	25
Field Use & Tuning Tips "Coin & Jewelry"	26-27
Field Use & Tuning Tips "Relic"	28-29
Field Use & Tuning Tips "Prospecting"	30-31
Chapter 7 Information	32
Proper Care	32
Service	33
Warranty	34
Warranty Transfer	35
Video and Owner Information.....	36

Assembly

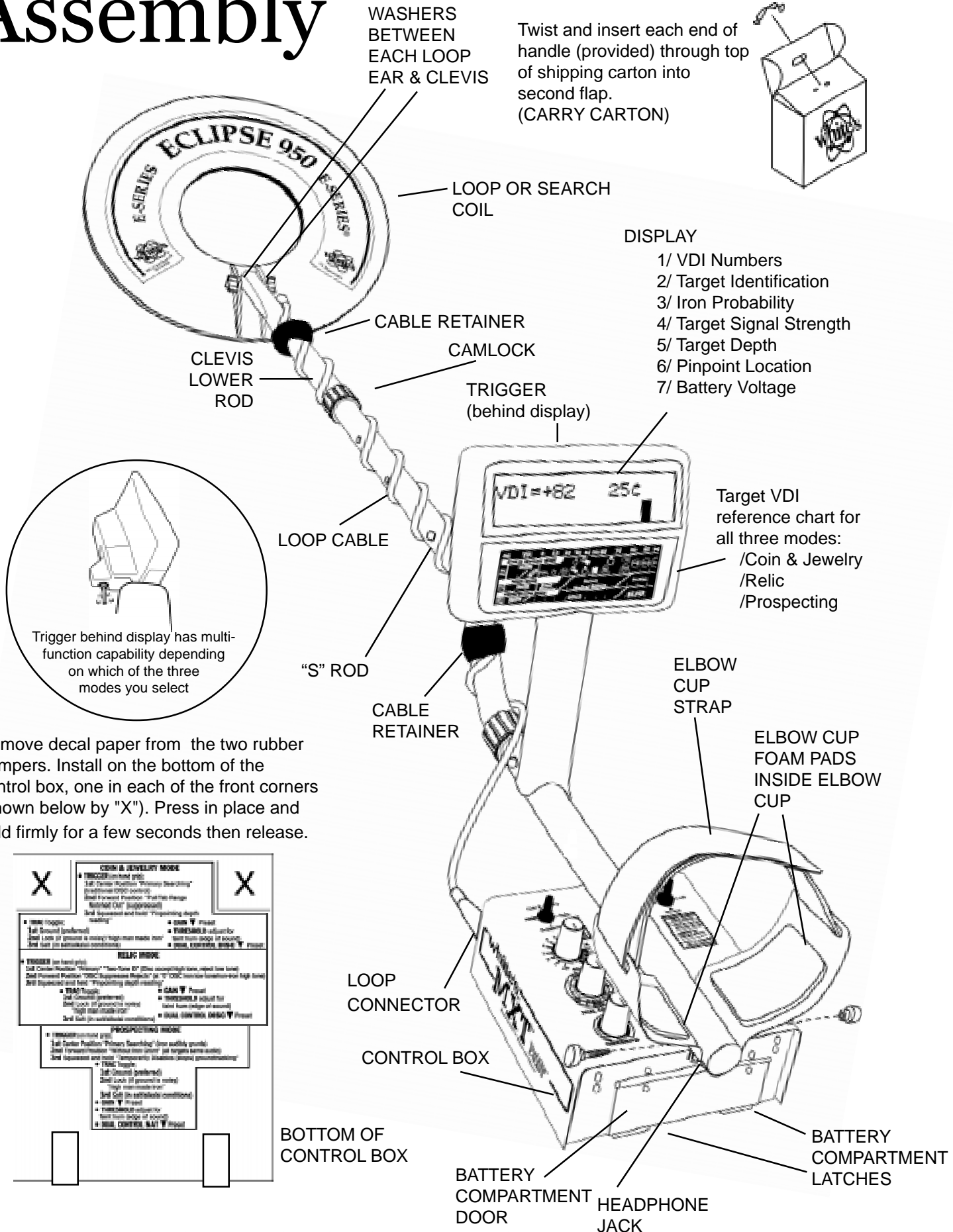

Remove decal paper from the two rubber bumpers. Install on the bottom of the control box, one in each of the front corners (shown below by "X"). Press in place and hold firmly for a few seconds then release.

Assembly Instructions

1. Remove all parts from shipping carton and check the assembly page to make sure all parts are present.
2. There are rubber washers between clevis/lower rod and loop ears. **Use only nonmetallic washers, fiber bolt, and thumbnut to secure loop/search coil to clevis/lower rod.**
3. Unlock "S" rod camlock and insert clevis/lower rod into curved "S" rod so that stainless steel spring clip buttons line up and lock into one of the adjustment holes in the curved "S" rod. Turn camlock to secure. The second or third adjustment holes are suitable for average size adults. Individuals 6' or taller should use the fully extended position. Individuals well over 6' tall should purchase the optional *Tall Man Rod*.
4. Unravel loop cable and wind the cable around the clevis and rod assembly, first revolution over the top of the rod. Wind cable all the way to the top of the curved "S" rod, about five revolutions. Use the black cable retainers, one near the loop, and one near the top of the curved "S" rod, to hold the loop cable in place.
5. Unlock control box rod camlock and insert curved "S" rod so that stainless steel spring clip buttons line up and lock into the rod on top of the control box. The "S" rod is designed to curve up toward the display. However, those who prefer to sweep the loop close to their feet may desire to assemble the "S" rod to curve down toward the ground. Turn camlock to secure. Plug loop connector into control box, screw lock ring to secure.
6. Grip the instrument by the handle, with your arm in the elbow cup with strap secure, and sweep the loop/search coil over the floor. If the instrument fit feels uncomfortable, adjust the elbow cup by removing and repositioning the bolt/thumbnut and installing in one of the optional positions. If necessary, readjust clevis/lower rod length with the spring clip buttons so that the search coil can be held near the floor without requiring stooping over.
7. Remove the protective paper from the two black elbow cup foam pads. Carefully align pads on the inside of the elbow cup, one on each side of the center rod, and press firmly into place.
8. Adjust the elbow cup strap so that it is loose enough for you to slide your arm in and out without loosening each time you want to set the detector down. The elbow cup strap provides extra leverage and control. However, some prefer not to use it.
9. Install battery as described in the next section, **decal facing down**, with plastic tab and steel contacts facing toward inside of battery compartment.
10. It should be noted at this point that the detector may not work as expected indoors due to the high degree of metals used in modern construction. It is best to tune and practice out-of-doors to ensure stable, predictable results. Additionally, freshly-buried targets will not produce the normal depth and discrimination results of targets that have been naturally lost and settled in the ground. Due to the abnormality caused by digging a hole in the ground matrix, and the sophistication of the ground rejection circuitry, it may take a number of years for freshly-buried targets to respond at true depths and discrimination accuracy. The best way to determine true detection depth is in real search conditions.

Batteries

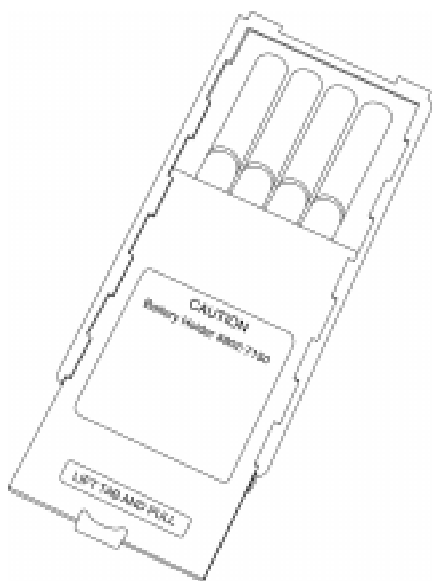

Standard Battery Holder

1. The standard battery holder holds eight “AA” cell batteries equalling 12 volts total. Alkalines are recommended for use with this model. During normal searching conditions you can expect about 40 hours of hunting time from a quality set of eight alkaline batteries.

2. Non-alkaline batteries can be used in this holder. When non-alkalines or rechargeable “AA” cells are used, detecting time (before replacement/recharge) may be reduced to about 30-35 hours.

3. The battery voltage appears automatically on the display when the Gain is used to turn the MXT “ON”. Once the batteries become weak (8 volts) “Lo Bat” will automatically appear on the display during searching. At that point the batteries should be replaced. Alkalines provide some reserve time after “Lo Bat” appears, rechargeable do not.

4. The battery compartment opens by gently pulling down on the front of each of the two latches (on the bottom of the control box) releasing the catch and hinging open the door.

Using the Standard Battery Holder

1. Slide open the battery holder lid (decal side of battery holder) by applying gentle upward pressure on the tab of the door so that it unlocks. Slide the door away from the battery box exposing the cell positions.

2. Remove any old cells from the holder. Note the (+) and (-) positions of each cell and the (+) and (-) for each position marked inside the cell tray. Install new “AA” cells **noting carefully the correct (+) and (-) positions.**

If the cells are installed incorrectly, the detector may require service by an Authorized Service Center.

3. Slide the door closed so that it snaps securely.

4. Insert the battery holder into the detector so that the decal is facing down, with the battery holder door tab and metal contact points facing toward the inside of the battery compartment.

Close the battery compartment door and secure the two latches on the bottom of the case. Hook the front of each latch first, then press down on the rear.

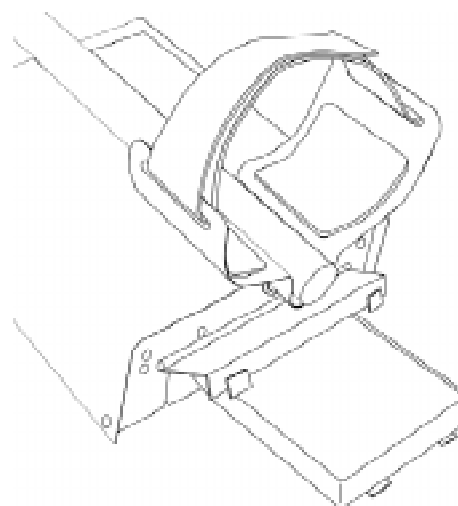

Rechargeable Battery (Opt.)

A rechargeable battery system is not standard equipment with your MXT, however, high quality systems are available.

White's rechargeable battery #802-5211, and charger #509-0022 are recommended and offer quick charge and overnight charge options.

Rechargeable batteries deliver fairly constant voltage until they're nearly dead. If you use them until they are dead, they will deteriorate more quickly than if you only use them till their voltage starts to drop significantly. Therefore, rechargeables should be taken out of service and recharged as soon as you notice "LoBat" on the display.

Rechargeable batteries will not provide the same amount of continuous use as a new set of Alkaline batteries.

Non-rechargeable batteries will start to drop in voltage as soon as they are put into use and then steadily diminish in voltage till they die. The Nicad rechargeable battery pack, however, will diminish very slowly (plateau) in somewhat of a flat line and then drop like a rock.

Headphone use prolongs all battery life.

Battery life will vary a great deal with temperature, number of target signals, battery type, brand, and shelf life.

Alkaline Batteries may be used (in a pinch) well into the "LoBat" indication. Rechargeables can not.

When traveling far from home it is always a good idea to carry 8 extra penlight alkaline batteries with you.

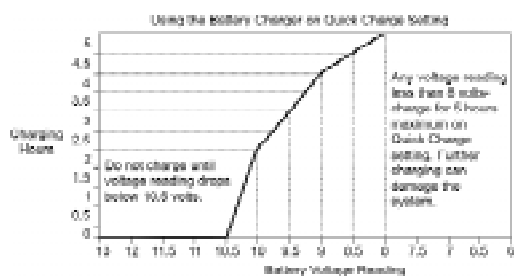
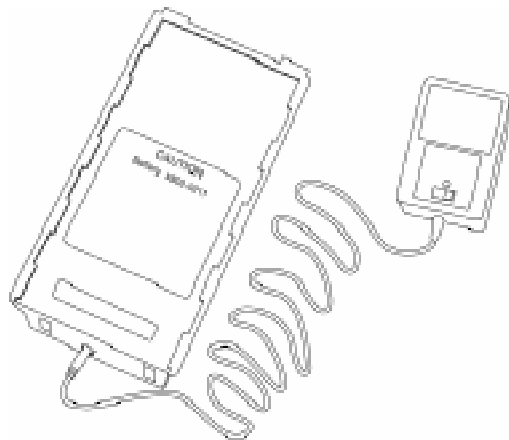

MXT Quick Start

Trigger Switch has three positions;

1. Forward (Alternate Mode).
2. Center (Primary Search).
3. Squeeze and Held (Pinpoint).

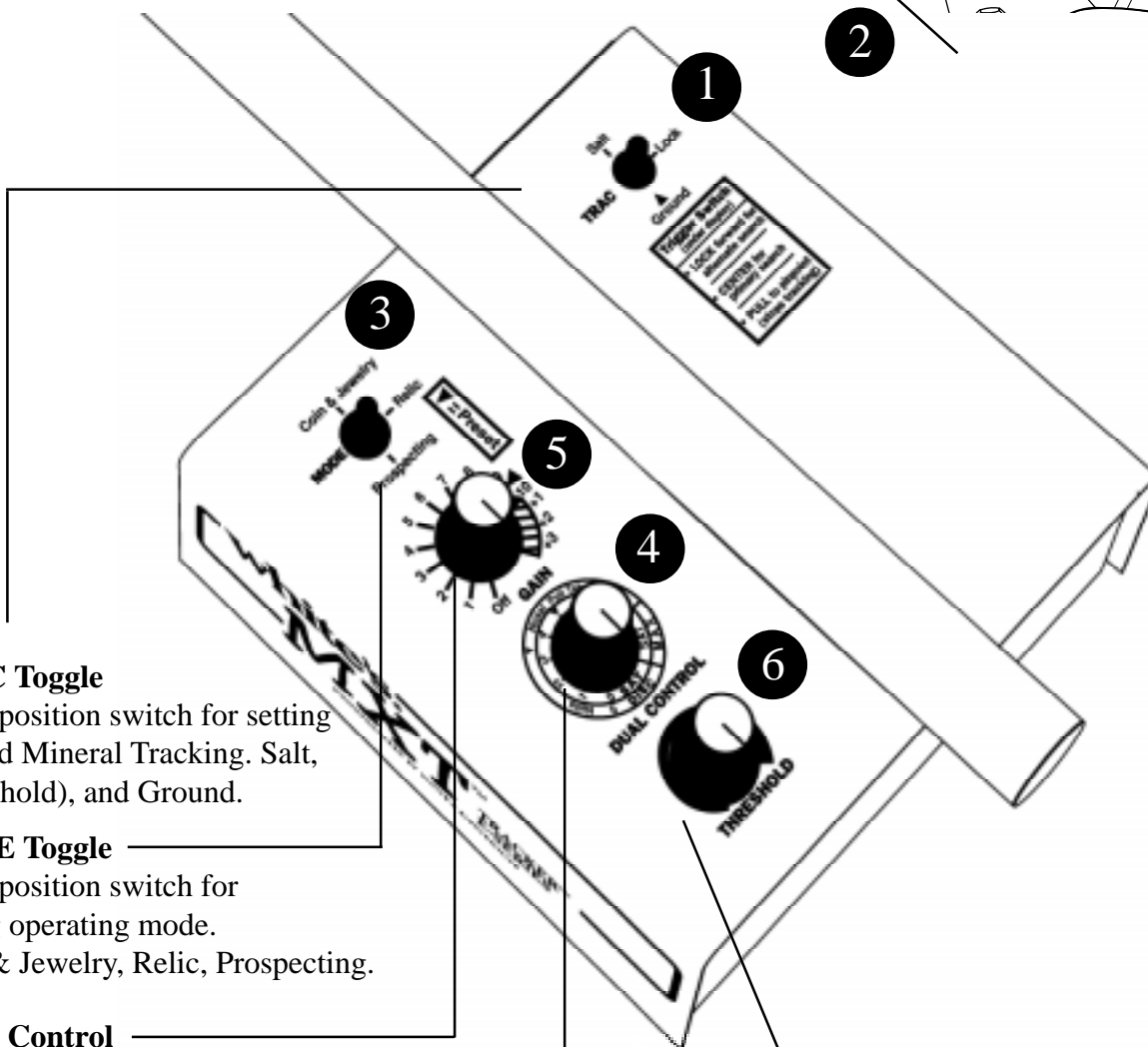
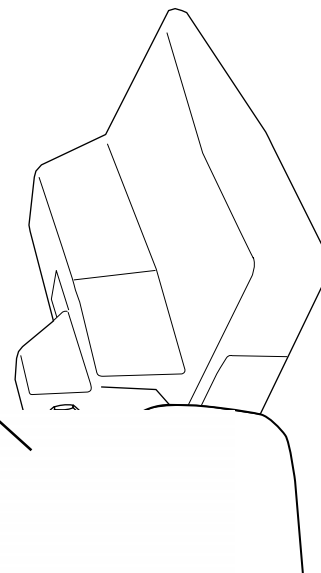

TRAC Toggle

Three position switch for setting Ground Mineral Tracking. Salt, Lock (hold), and Ground.

MODE Toggle

Three position switch for setting operating mode. Coin & Jewelry, Relic, Prospecting.

GAIN Control

Turns the MXT ON/OFF and adjusts the signal strength of targets, ground, and electrical interference.

DUAL CONTROL

In Coin & Jewelry and Relic Modes establishes the level of trash metal rejection (Discrimination). In the Prospecting Mode establishes Self Adjusting Threshold (SAT), the speed at which the THRESHOLD "hum" recovers from the affects of inconsistencies in ground mineralization.

THRESHOLD Control

Establishes the slight background sound "faint hum" or edge of sound, that is heard continuously during searching. Once this edge of sound has been located some operators prefer to adjust slightly counterclockwise of it to achieve silent search, no continuous background hum, during searching.

Quick Start Instructions

With the MXT properly assembled and the batteries installed, follow the instructions below to start finding treasures!

- 1 Set the **Ground Balance Toggle** to the Ground position. "▼"
- 2 Set the **Trigger Switch** (under the hand grip) to the center (Primary Search) position.
- 3 Set the **MODE toggle** to the position that best describes your searching desire, Coin & Jewelry, Relic, or Prospecting.
- 4 Set the **DUAL CONTROL** to the DISC ring "▼" for Coin & Jewelry and Relic Mode or to the SAT ring "▼" for Prospecting Mode.
- 5 Turn the **GAIN** control clockwise until the power clicks "ON". Rotate the **GAIN** control clockwise to "▼".
- 6 Adjust the **THRESHOLD** control until you hear a soft threshold "hum" (faint sound).
- 7 **Lower the search coil** to the ground, then "pump" the coil up and down 2"-4" a couple of times and **Fast AutoTrac** will automatically balance or track out the ground mineralization.
- 8 Start **swinging the search coil** in wide sweeps that overlap each other as near the ground surface as possible.
- 9 If you experience **false signals or constant beeping or popping** and you are not near common sources of electrical interference, set **TRAC** to **LOCK** and/or reduce **GAIN** (counterclockwise) slightly and try again. It is normal to hear very slight fluctuations in the **THRESHOLD** "hum" as the MXT tracks out the ground mineralization.

When operating in the Prospecting Mode, first try reducing the Gain and/or increasing the SAT speed. SAT speeds as high as HYPERSAT may be necessary in some ground conditions. If Gain and SAT adjustments do not smooth performance, then switch to the Trac Lock position.

* SPECIAL NOTICE

If you attempt to demonstrate or test the MXT by waving targets in the air in front of the search coil, it is **ESSENTIAL** to have the **GROUND BALANCE** toggle in the **Lock** position, **NOT** Ground or Salt.

This is necessary, for when the MXT is in the Ground or Salt positions, the search coil must *SEE* ground while it is passing over the target or it will think that the target *IS* ground and will attempt to track it out. This is the case in all MODEs.

You may, however, demonstrate the fast ground balancing feature of Ground or Salt by waving or pumping a mineralized rock in the air in front of the search coil.

Testing the MXT with targets while in TRAC Ground or Salt positions must be done in or on the ground.

7

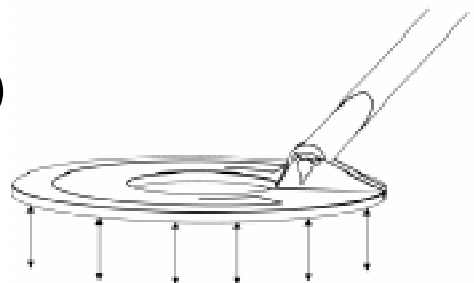

8

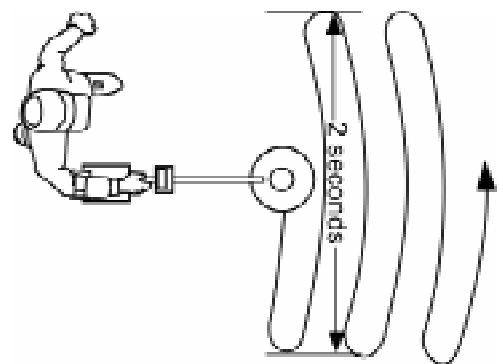

MXT Display Indication

The MXT display and reference label below the display provide a wealth of information about the metal target. It is important, however, to understand the display information should only be consulted after a solid repeatable audio tone "beep" has been located.

The MODE selection changes the type and content of the information shown by the display better suiting the MXT to the application, Coin & Jewelry, Relic, or Prospecting.

In all MODEs, the display will momentarily show a software version and battery voltage upon first turning the GAIN "on". The MXT operates on a twelve volt battery system which with new quality batteries will indicate 12 + volts. During searching "LoBat" will start appearing on the display at 8 volts and anything 8 volts and below are suspect for replacement. If using rechargeable batteries 8 volts is surely the end of their performance. If you are using quality alkaline batteries you do have a reserve after 8 volts. The MXT utilizes a low voltage regulator. Quality alkaline batteries will provide normal performance (in a pinch) well into the LoBat indication.

Coin & Jewelry MODE;

The Coin & Jewelry MODE provides 5 different significant indications on the display.

1. VDI = number - The VDI (Visual Discrimination Indication) is a reference number dictated mostly by the metals targets exact alloy, size, and shape. The reference label below the display provides a comparison of known targets and their common VDI numbers. Like targets produce like VDI numbers. Similar targets produce similar VDI numbers. And different targets produce different VDI numbers. Different metal targets, however, may share the same VDI numbers based on their electrical characteristics. VDI numbers from -95 to +94 are available and cover the entire range of alloys and sizes.

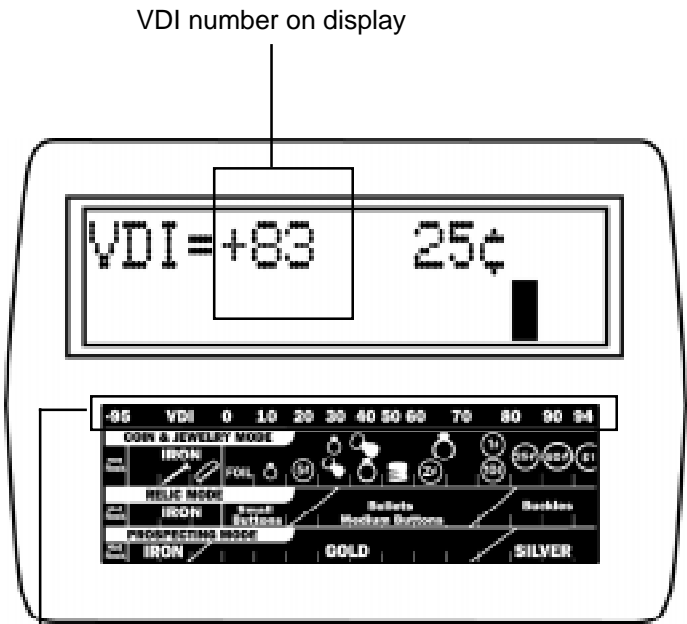
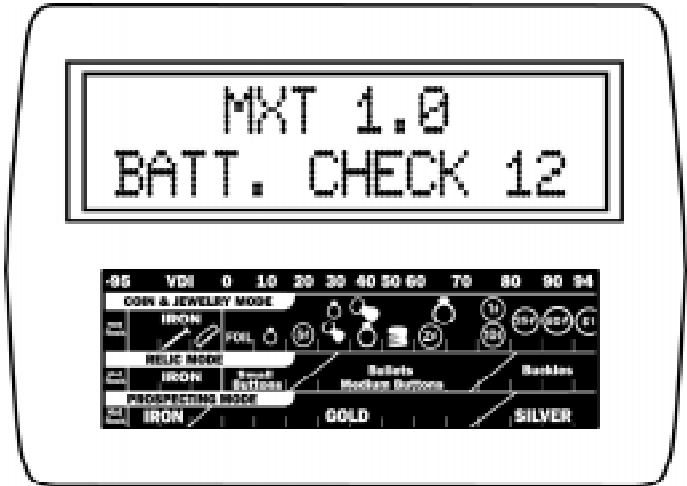

VDI number range on reference label

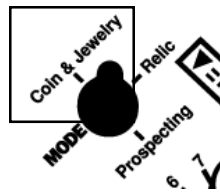

Mode toggle switch forward for Coin and Jewelry

8 [To see complete details or to purchase the White's MXT Standard Metal Detector, visit: http://www.metaldetector.com/whites-mxt-standard-metal-detector](http://www.metaldetector.com/whites-mxt-standard-metal-detector)

Half block indicating MXT is not certain but possible.

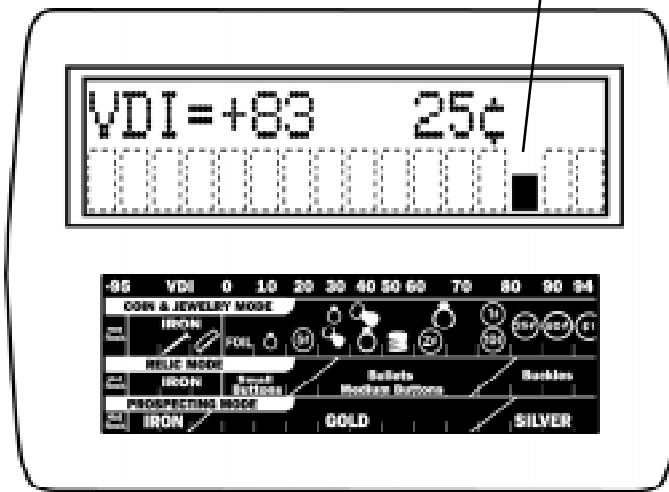

Note: Dotted blocks for illustration purposes only.

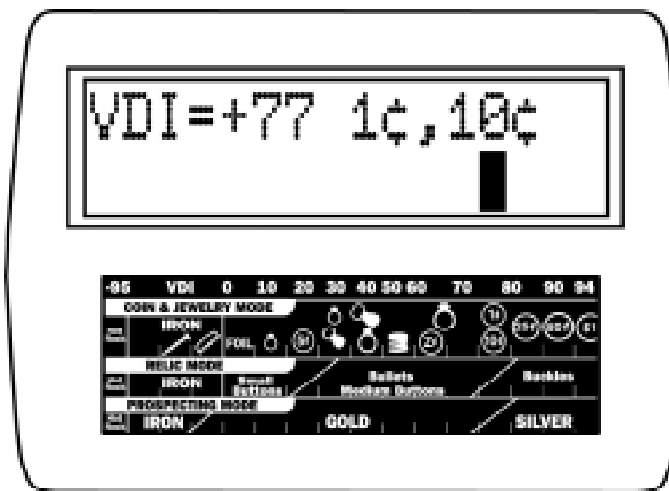

Note: In this case, the 1¢ is the probable ID.

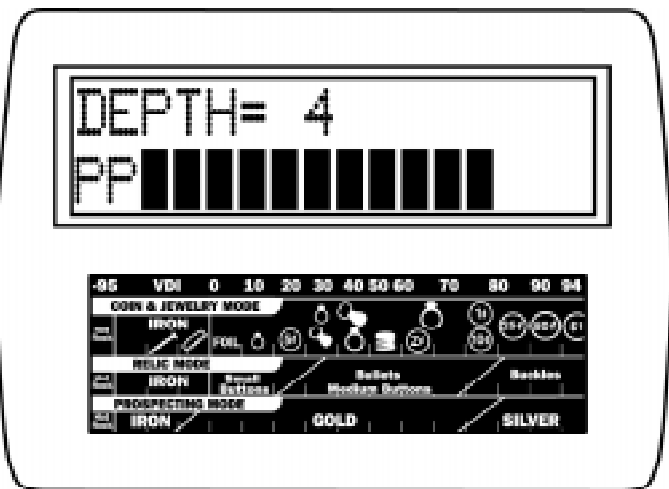

2. Blocks - A series of 16 blocks appear along the bottom portion of the display and line up with the indications on the reference label below the display. It is important to note these blocks are a different separate opinion compared to the VDI number and they may or may not agree. There is significance to how these blocks appear. A full block indicates the MXT is confident of indication. A half block indicates the MXT is not confident but is making an educated indication. A quarter block indicates the MXT is not confident at all, guessing based on what little information the target is producing.

3. Labels - The most common metal target (or targets in some cases) to indicate that particular Block is listed on the display as well as referenced in an expanded format on the label below the display. If two targets are listed the first to be listed is the most common and the second listed slightly less common than the first.

4. Depth Indication - Trigger (on hand grip) squeezed and held, the display indicates the depth of coin sized metals. Starting at 12 inches and indicating in descending order (as the target gets closer to the bottom of the search coil) the DEPTH = 12 provides not only an aid in better locating the target in the ground (how deep you will need to dig) but also clues as to if the metal target is likely worth digging. For example if the display is unsure (quarter block indication), is indicating in the FOIL range, and the depth reads deep 6 to 12 inches, you should dig the target. Only the heavier more valued targets get deeper into undisturbed ground. If the display reads unsure (quarter block), indicates in the FOIL area, and the depth reads shallow 0 to 2 inches, the target is most likely not worth digging. Foil will not sink deeply into undisturbed ground. Targets that indicate depth readings from 3 - 5 inches are not as predictable.

5. PP Blocks - Trigger (on the hand grip) squeezed and held, the PP blocks aid in pinpointing the exact center of the metal target. Only when the search coil is directly over the center of the metal target (longest possible length PP Blocks) is the depth reading giving you the most accurate depth indication. Also of importance is that with some experience the relative size and shape of the metal target can be recognized during pinpointing.

Chapter 4 MXT Display

Relic MODE;

The Relic MODE also provides 5 different significant indications on the display.

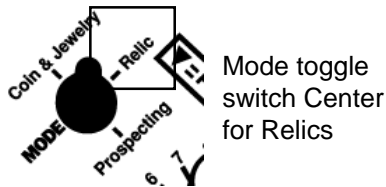

1. VDI = number - As with the Coin and Jewelry mode the relic VDI (Visual Discrimination Indication) is a reference number dictated mostly by the metal targets exact alloy, size, and shape. And just like coins and jewelry, relics can present with similar VDI numbers for different objects because their makeup and electrical characteristics are similar. Using the reference label below the display one can see that iron relics are still in the low VDI numbers and objects like brass buttons and buckles with a high concentration of non-ferrous metal or alloy rate higher VDI numbers compared to their size and purity.

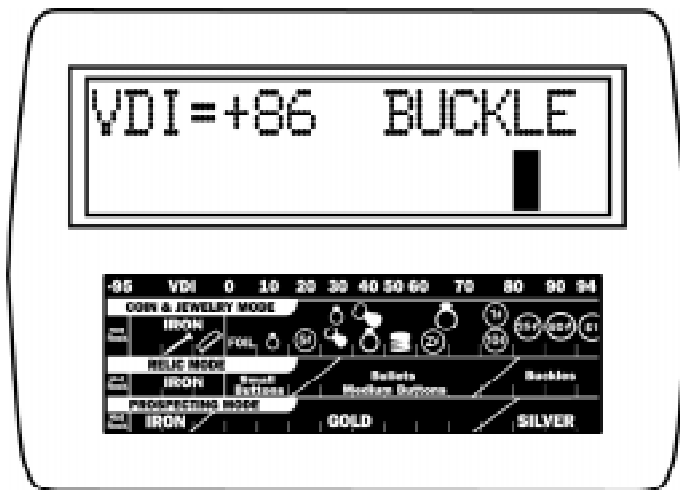

NOTE: The filled in block and the VDI number are separate opinions by the software and may agree or disagree.

2. Blocks - The MXT Relic mode uses the same sixteen filled in Blocks as Coin and Jewelry mode to further confirm, on the reference label, the connection between the VDI number and software's best determination of the target identity. The vertical size (one quarter, one half, or the whole block) tells one how sure the MXT is of the target ID. Full bar and half bar usually means dig. Quarter blocks are uncertain.

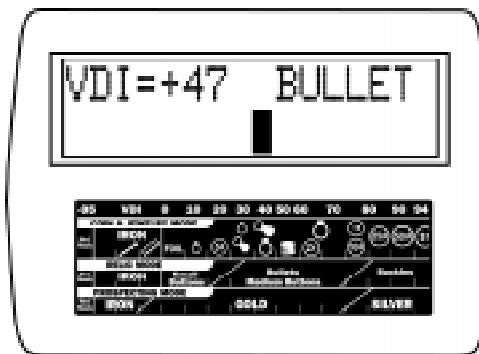

NOTE: The top display is a sure ID. The bottom display with its quarter size bar suggests uncertain unless the Depth reading is 6-12.

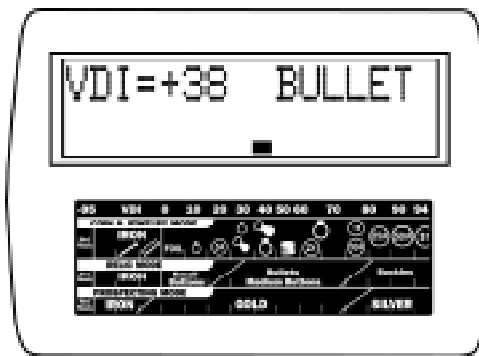

3. Labels - In Relic mode you will see target ID labels in the upper right of the display. The labels are Hot Rock, IRON, BUTTON, BULLET and BUCKLE. Obviously there are many more relic items possible. Just keep your imagination open for what possible objects were produced in metal and how they might compare in size and alloy to the ones mentioned above.

4. Depth Indication - Trigger (on hand grip) squeezed and held, the display indicates the depth of coin sized metals. Just as in the Coin and Jewelry mode, Depth not only tells you how deep the target is but combined with the block reading and target label on the right side of the display it can indicate if the item is worth digging. A 6 - 12 Depth reading and any Block indication means dig. Shallower targets and a quarter or half size block suggests trash. This is because the heavier more desirable targets settle deeper into undisturbed ground. The shallower Depth readings should have full Blocks to warrant digging.

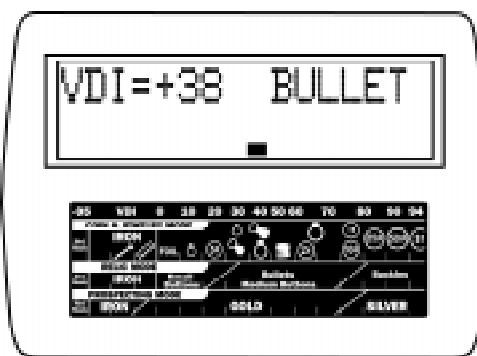

NOTE: Before squeezing the trigger, the quarter Block reading says the MXT is not sure. A Depth reading can help you decide to dig or not.

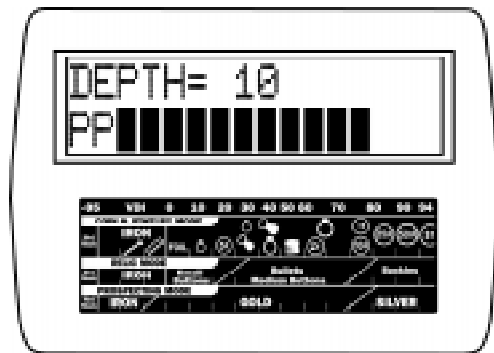

A depth of 10 suggests you should dig.

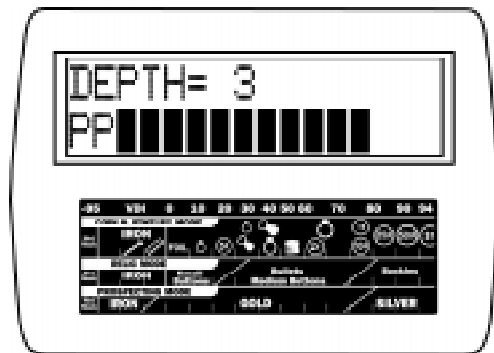

In this case a depth of 3 with only a quarter block filled suggests the target is questionably trash.

5. PP Blocks - Relic mode Pinpointing works the same as in Coin and Jewelry mode. With the trigger (on the hand grip) squeezed and held, the PP (pinpoint) blocks aid in pinpointing the exact center of the metal target.

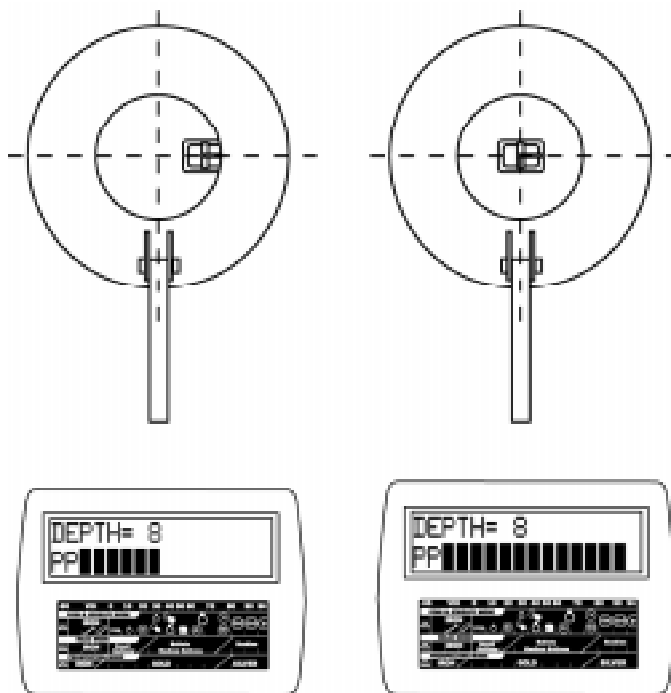

NOTE: Please refer to page 24 for the proper "X" ing technique to "Pinpoint" the exact center of the target.

Prospecting MODE

The Prospecting MODE changes the display information significantly.

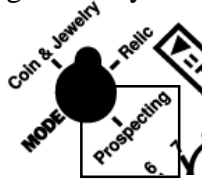

Mode toggle switch Down for Prospecting

Gold in its natural state can be any size and shape from very tiny pinhead size flakes to large placer gold nuggets as well as veins of various size in quartz rocks. The Prospecting MODE takes these facts into consideration and changes the display accordingly. When prospecting an operator must expect to dig nonferrous (not of iron) trash metals such as aluminum foil, lead, and small brass. Any of these metals can and do elicit the same response as gold and **MUST BE DUG**. Attempts should be made to avoid only IRON targets and only when possible. The MXT displays information which is intended to help the user determine whether the target is NON-IRON (dig) or IRON (don't dig). In heavy mineralized ground tiny pieces of gold can sometimes look like IRON to a metal detector and small pieces of IRON can look like gold. The VDI numbers and Iron Probability scale both provide help in determining when to dig.

The Prospecting MODE provides four significant display indications.

1. VDI - The VDI number is listed on the display and referenced on the label below the display. Gold can indicate anywhere from slightly negative to +80 on the scale, however, most small nuggets indicate in the -20 to +40 range. Metals that indicate above +80, or below -20 are highly unlikely to be gold unless they are conglomerated with highly unusual alloys. If the VDI number tends to jump back and forth from small negative numbers to small positive numbers it is usually a small piece of some metal and should be investigated by digging. Remember, small flakes of gold in bad ground can read into the small negative range. A magnet on your digging pick can sort out a small shard of iron quickly.

2. IRON TARGET? - Indicates the likelihood the target is ferrous (iron) expressed in a %. This indication can be different in different areas depending upon the degree of mineralization. As a general rule targets registering 60%, 70%, 80%, 90% are going to be iron. 80% and over will produce the audio grunt in the primary (Trigger Center) mode. Targets that register 10%, 20%, 30% or 40% are going to be gold or (lead, copper, aluminum, brass). All targets registering 50% or below should be investigated.

As mentioned under the VDI section, iron ground mineralization can distort the way the detector reacts to gold. It is always a good idea to place a test nugget just under the surface of the ground wherever you are going to be prospecting and note how it reacts to the IRON TARGET %. This will give you a gauge as to what to expect. The degree of dependability is affected by ground minerals and the size of the target. It is not uncommon for a small piece of gold in very bad ground to read 70% probability of being iron. Remember when in doubt...DIG. Use both the VDI and % IRON PROBABILITY. Dig often at first, till you get a feel for the area and accuracy in that ground.



NOTE: The display reading above would indicate a target with a proper VDI number for gold and a low enough iron target percentage to dig.

3. GND - Indicates the phase (measurement) of the ground . This is useful in two different environments.

A. Within a dry wash the gold will settle with the heavier materials (black sands). When searching you notice the ground phase is declining (lowering in number), generally you are working further away from the heavy black sand deposits. If you notice the ground phase is increasing, generally you are working toward (closer) to the heavier deposits. By following the more intense ground phase you increase your likelihood of finding nuggets.

B. Checking outcropping or veins, the ground phase can also be useful in a similar way by indicating the consistency or change of the veins ground phase.

Generally speaking, the ground numbers will hold fairly consistent in most open terrain areas, such as hydraulic sites and desert areas. GND readings in the high 70's and 80's are considered heavy iron mineralization. Alkali or salt areas will display much lower numbers, possibly into the 30's and 40's.

Ground phase indications are a doubled edged sword. Higher numbers simply mean predominately ferrous (iron) such as black sands / magnetite. Lower numbers simply mean less iron and/or predominately conductive nonferrous (not of iron) content, such as gold per ton of rock. So in a dry wash, outcropping, or vein, a shift in either direction (higher or lower numbers) may be of interest. For example a black sand streak may have a lot of flour gold at one end. It will indicate a high ground phase number on the end without the flour gold, and a lower ground phase on the end with the flour gold. The same applies to veins or an outcropping. It is the change that brings about the interest more so than if it is either high iron (high number) or high conductive (lower numbers). Knowing that the ground is high iron (magnetite), outlining black sand pockets, and checking veins for consistency (change), and comparing rock samples for possible assay, are the common uses of ground phase. Again, change is of the most interesting, not direction.

Use Ground Numbers First to Find Gold Bearing Ground in a Dry Wash

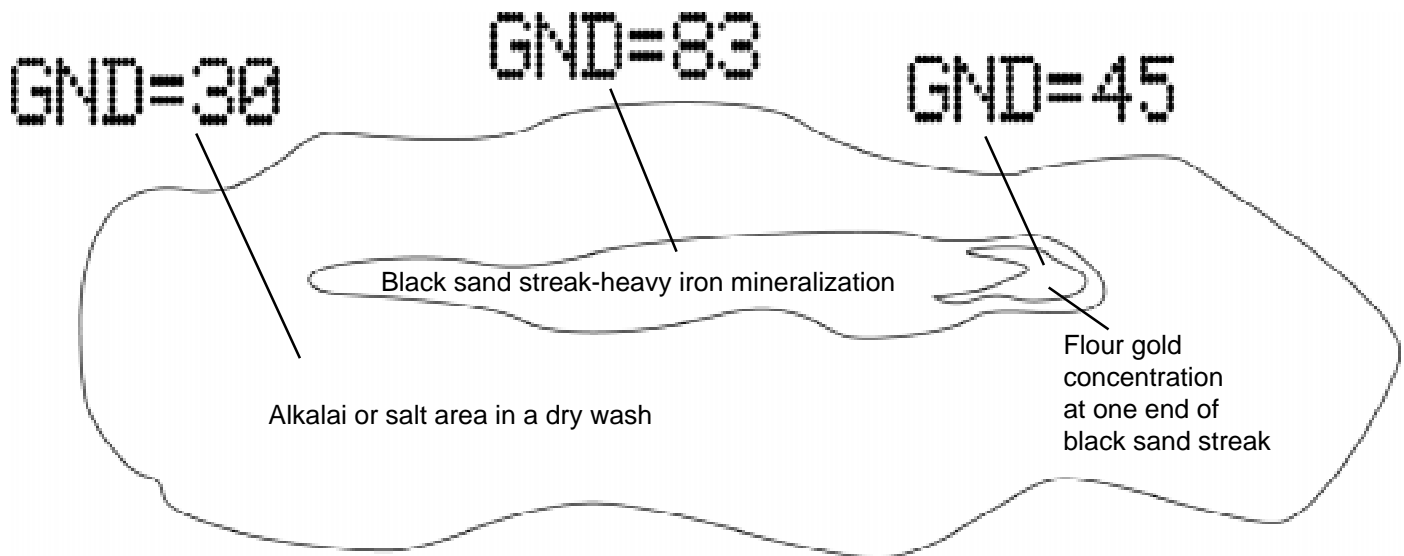

NOTE: Watching the change in Ground Number in the upper right of the display, you will first look for a change to a high number indicating high mineralization or black sand. When that streak is identified you will then look for the Ground Number to lower again at one end of the streak indicating where the flour gold concentrated or washed down to that end.

Controls

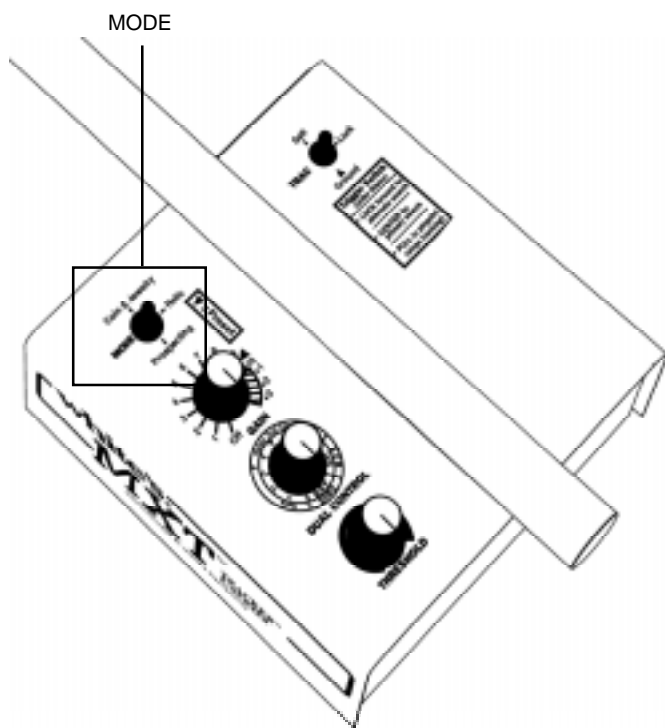

MODE Toggle

The MODE toggle selects the operating MODE or type of searching desired on that particular outing. Major changes occur with the selection between the three available operating MODEs. For example the function and information of the display changes between the three MODEs, the function and available features of the TRIGGER switch on the hand grip changes between the three MODEs, and the DUAL CONTROL function changes between the MODEs. For quick field reference, the silk screen painted on the bottom of the control box is provided to simplify these changes and features.

Further explanation is provided as follows;

COIN & JEWELRY MODE

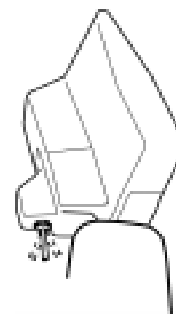

***Trigger (on hand grip);**

Center Position "Primary Searching" (traditional DISC control) . In other words with the Trigger on the hand grip in the center position, the DISC control works like most traditional metal detectors in that metal items below the DISC control setting are suppressed (quiet or broken) by the audio and metal items accepted by the DISC control setting produce a smoother solid audio beep.

Forward Position (Alternate Mode) "Pull Tab Range Notched Out (suppressed)".

In other words with the Trigger on the hand grip in the forward position, the typical pull tab range is rejected regardless of the DISC controls position. If you are accepting nickels, pull tabs above that setting on the DISC control range are still suppressed (quiet or broken) by the audio.

Squeezed and held "Pinpointing/Depth Reading".

When operating in the Coin & Jewelry MODE when the Trigger on the hand grip is squeezed and held, the display provides a screen that indicates the depth of coin sized targets. Once released the trigger will automatically return to the Center "Primary Search" position.

***DUAL CONTROL DISC "P" Preset**

While operating in the Coin & Jewelry MODE The DUAL CONTROL functions as a traditional discrimination control. Further clockwise settings provide greater degrees of trash metal rejection. Further counterclockwise settings provide lesser degrees of trash metal rejection.

RELIC MODE

***Trigger (on hand grip)**

Center Position "Primary" "Two Tone ID" (disc accept high tone, reject low tone).

In other words while operating in the Relic MODE, targets below the DISC control setting produce a beep lower in pitch, targets above the DISC control setting produce a beep higher in pitch. Two different tones, lower trash/rejects, higher good metals, accepts all based on the DISC control setting. Edgy target responses are normal for this mode as it technically is a Mixed Mode with all metal and Disc working simultaneously. Unlike other White's models some loop motion is always required for good target responses. Targets singles that are not readily identifiable are assigned a tone between the two, Threshold pitched.

Forward Position (Alternate Mode) "DISC Suppresses Rejects" (at "0" DISC iron low tone/non-iron high tone).

While operating in the Relic mode with the Trigger on the hand grip in the forward position, and the DISC control set in any typical trash rejection setting, discrimination against trash metals occurs like any traditional metal detector in that metals below the Disc setting are suppressed (quiet or broken) and metals above the DISC setting produce a smoother solid beep. With the trigger forward and the DISC control set to ZERO, however, ferrous metals (iron) produces a lower pitch beep and nonferrous metals (not iron) produce a higher pitch beep.

Squeezed and held "Pinpointing/Depth Reading".

When operating in the Relic MODE when the Trigger on the hand grip is squeezed and held, the display provides a screen that indicates the depth of coin, medium button, medium bullet sized targets. Once released the trigger will automatically return to the Center "Primary Search" position.

***DUAL CONTROL DISC Preset.**

While operating in the Relic MODE the DUAL CONTROL functions as a traditional discrimination control. Further clockwise settings provide greater degrees of trash metal rejection. Further counter-clockwise settings provide lesser degrees of trash

PROSPECTING MODE

***Trigger (on hand grip) - Center Position "Primary Searching" (iron audibly grunts).**

While operating in the Prospecting MODE, iron targets 80% and over produce an audio grunt when detected.

Forward position (Alternate Mode) "Without Iron Grunt" (all targets same audio).

The audio produces the same basic VCO audio beep (zip sound) regardless of metal type. Iron doesn't grunt.

Squeezed and held "Temporally Disables (stops) ground tracking".

Depth reading can only accurately be calibrated by knowing ahead of time approximate target size. No two nuggets are the same size so any attempts to apply depth indications are fundamentally flawed (in error). Therefore while operating in the Prospecting MODE rather than giving a known flawed depth indication, squeezing and holding the Trigger on the hand grip simply and temporarily stops ground tracking. This is an important feature. In order for the MXT to recognize a target in mineralized ground it must first be able to cancel the ground mineral. This is done by the fast tracking system built into the software. It must actually see ground with every sweep (on either side of the target) in order to separate the target from the ground. This is easily done during the normal process of detecting. However, when a target has been detected, the user usually hovers for a while over the target and makes repeated passes in order to decide whether or not to investigate the signal. thus, analyzing audio and display information. This hovering can often cause the detector to see more target than ground and cause the detector to think the target is ground and attempt to track into it. Squeezing and holding the trigger when analyzing the signal stops tracking and prevents errors.

***DUAL CONTROL SAT Preset.**

While operating in the Prospecting MODE, the DUAL CONTROL functions as a Self Adjusting Threshold (SAT) control to smooth inconsistencies in the ground and thus the Threshold. More on SAT under the section dedicated to the DUAL CONTROL.

[To see complete details or to purchase the White's MXT Standard Metal Detector, visit:](http://www.metaldetector.com/whites-mxt-standard-metal-detector)

<http://www.metaldetector.com/whites-mxt-standard-metal-detector>

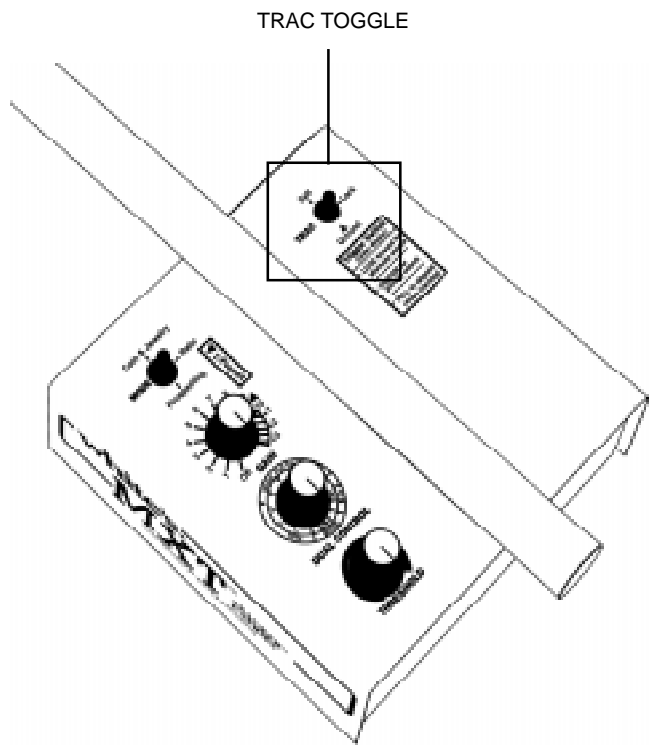

TRAC Toggle

The TRAC toggle selects the type of ground mineral rejection (ground balance) and automatic tracking to ground mineral changes best suited to the specific area. Three different positions each for a specific ground condition (ground type) are provided.

The **Ground** position is used for normal or typical ground conditions. In this position the MXT will quickly compensate for ground minerals in a few pumps of the search coil over the ground being searched and quickly (automatically) track to any ground changes as you sweep the search coil during searching. For most operators the Ground position will be used for over 90% of your searching conditions.

The **Lock** position monitors, however, doesn't track to changing ground conditions. Man made iron decomposes to the point of tricking the Ground and Salt position tracking into thinking it is a mineralized part of the ground. This can create noise and instability during searching as the tracking system bounces radically up and down the scale, always searching for a good ground rejection setting and is never able to find it. This makes it difficult for an operator to recognize worthwhile targets and/or run at the higher performance GAIN settings. In these conditions it is recommended to first go to the Ground position and pump the search coil over a clean area of ground representative of the area (free of man made iron) then switch the TRAC control to Lock. By doing so stability and success searching these trashy areas will improve dramatically. Because ground changes are monitored during Lock, once an operator switches back to either Ground or Salt tracking positions, updates to an appropriate ground setting are virtually instantaneous.

Another example of when Lock would be used is if a particular mineralized rock or patch creates difficulties in searching an area. A hard rock mine for example with a low mineralized base rock and random high mineralized rocks or patches. Place the TRAC control in the Ground position and balance "pump the search coil" over a representative sample of the high mineral rock or patches. Then Lock in that ground rejection setting "place the TRAC control in the Lock position". The entire area can then be searched without the distraction of the inconsistencies the high mineral patches create.

The **Salt** position provides an extended ground balance and tracking range to compensate for conductive salts also called alkali. Ground rejection against salt/alkali slightly overlaps the lower end of the conductive target (metal) range. In other words if you ground balanced against significant salts, some loss of sensitivity to lower conducting metals (metals low on the VDI target scale) can be expected. The advantage and performance improvements of rejecting the salt, however, far outweighs any loss. Because the Salt TRAC setting can track well into the target range it is not recommended for normal conditions, only for areas known to contain salt. Salt water beaches for example or alkali desert regions. The Ground setting will not track into the nonferrous metal region. The Salt setting will. The MXT ground rejection system is capable, in both the Ground and the Salt settings, of considering some iron a ground mineral.

If operating in a known salt area, salt water beaches for example, it is not necessary to balance in the Ground TRAC setting. Simply select the Salt TRAC setting and proceed to pump the search coil over the ground to be searched. The Salt setting will balance and then track to changes identically to the Ground setting only with an extended range, well into the conductive target area.

Summary - The **Ground** TRAC setting is recommended for most searching conditions. **Lock** is used to hold a ground rejection setting that is first established in the Ground or Salt TRAC positions. Lock is recommended for areas that cause detector instability due to extreme ground peculiarities such as a lot of decomposing man made iron. Salt provides extended ground rejection range to compensate for conductive salt/alkali conditions. The Salt setting can ground cancel extreme enough to reduce sensitivity to low conducting metals, metals that appear low on the VDI scale. The Ground TRAC setting will not balance nor track into the nonferrous metal region. Despite this drawback the Salt setting still provides improved overall performance while operating in the salt/alkali ground condition.

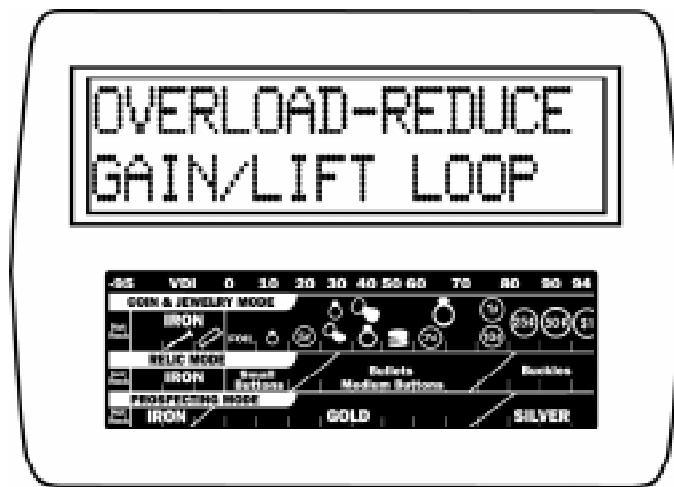
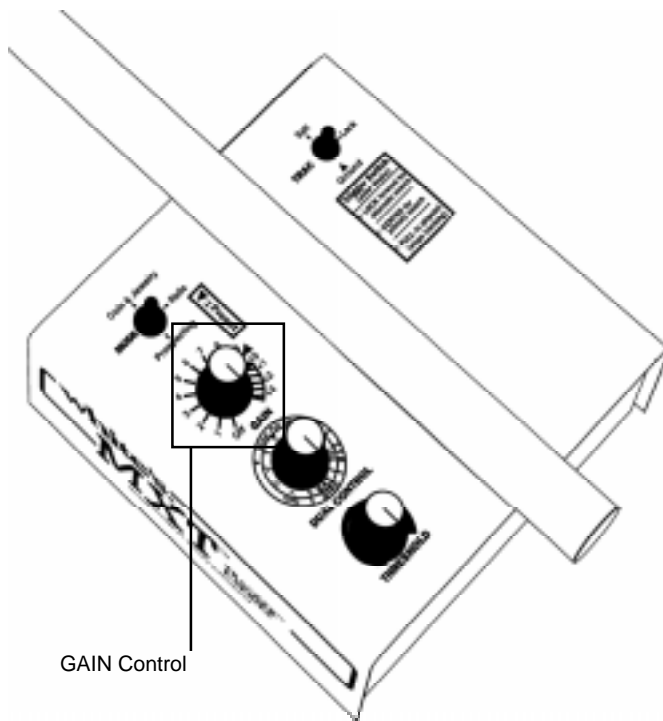

NOTE: Ground Mineralization too high, large or shallow target message.

Gain Control/ON-OFF

With the GAIN control, you turn the instrument on/off and select the signal strength. You might expect increased signal strength to always find more at greater depths. However, high ground mineralization will "bounce" the signal back and mask good targets. It is therefore necessary to ADJUST the GAIN to give you the maximum allowable GAIN without masking targets or overloading the circuit and at the same time allowing you to operate the detector with a constant faint threshold hum so that faint signals (deep or small targets) can be detected.

This is where the new MXT can help you out. When ground mineralization is too high for the current GAIN control setting, the display indicates **"OVERLOAD-REDUCE GAIN/LIFT LOOP"** along with an audible "squawk". Reduce the GAIN till the overload warning ceases. On occasion, while searching, you might sweep the loop over a very large or very shallow target. The message on the LCD display will read **"OVERLOAD-REDUCE GAIN/LIFT LOOP"**. All such targets should be checked by sweeping the loop a little higher over the area and noting the display and audio indications. The MXT will self correct after the message and you can continue to search as normal.

Gain Adjustment

1. The GAIN control knob turns the MXT ON and OFF and controls the GAIN. Starting from the POWER OFF position and going clockwise, the power is turned ON and the dial increases the GAIN from a minimum level of "1" to a maximum level of "+3". Set the control to the "Initial Setting Triangle" (between level 9 & 10).

2. Although the setting of (9-10) gives more than ample GAIN, if the ground mineralization is low enough, you might attempt to raise the GAIN above this level toward +3.

Gain Adjustment (continued)

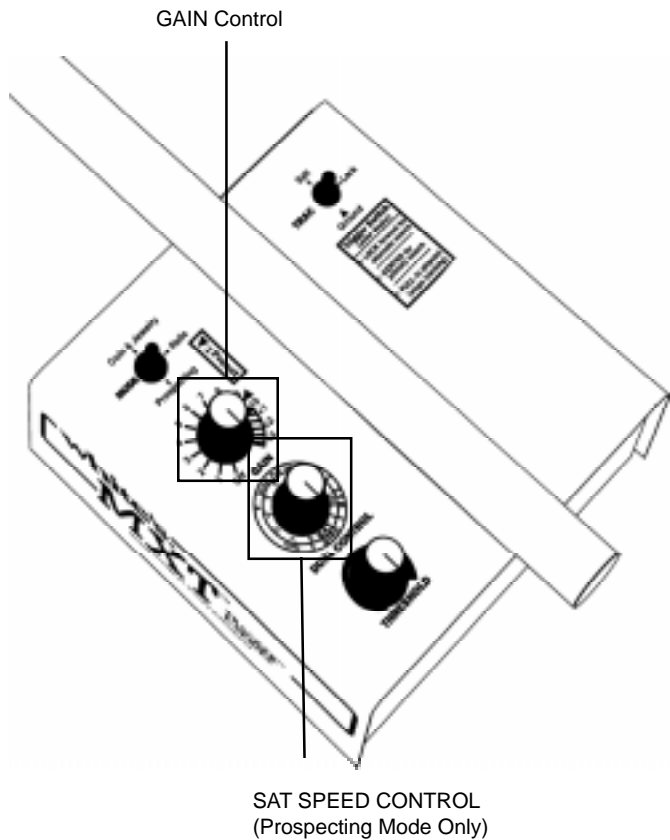

Gain Adjustment (continued)

If, of course, "**OVERLOAD-REDUCE GAIN/LIFT LOOP**" message is displayed common for very nasty ground mineralization, you must heed it and reduce the GAIN rather than raise it.

3. The object of increasing the GAIN is to get the maximum available depth from the detector WITHOUT causing the "**OVERLOAD-REDUCE GAIN/LIFT LOOP**" message to appear which indicates an overload of the circuit.

4. In addition, any increase in GAIN adjustment should NOT BE at the expense of maintaining a smooth and constant THRESHOLD "hum". False signals, beeps and static from bits of mineralization, erratic behavior, and lapses in THRESHOLD all can be the result of running with too much GAIN.

5. In the Prospecting MODE the use of the SAT (variable self-adjusting threshold) control will help to maintain a smooth THRESHOLD "hum" particularly at higher GAIN settings and will be covered in a later section.

6. While using a steady slow search coil sweep speed, simultaneously advance GAIN towards "+3". If the "**OVERLOAD-REDUCE GAIN/LIFT LOOP**" alert keeps popping up on the display, if a quiet smooth background THRESHOLD "hum" doesn't continue, or if ground noises are a problem reduce GAIN.

7. The trash I.D. capability of the MXT also functions more accurately when the GAIN is set at a level which allows for smooth operation. Too much GAIN can cause bad ground to distort the proper identification of iron and non-iron targets.

8. Note: It is normal to hear changes, clicks or soft beeps, coming from the audio (speaker) during GAIN adjustments as the circuit shifts between hardware and software gains (different electrical parts of the circuitry). The GAIN control adjusts both the hardware gain (hard physical component) as well as the software gain (computer code) alternating between the two throughout it's range. As the MXT shifts between these two intricate parts of the circuitry an audio indication notes the transitions. This can be helpful. If you adjust the Gain slightly, the audio notes a significant rather than slight change.

9. The MXT provides more GAIN control range than is typically useful assuring performance is not left on the plate due to restricted assess/range. Likely few areas will allow maximum GAIN (full clockwise) without at least some degree of radical (noisy) operation. Setting in the + area requires a high degree of operator skill.

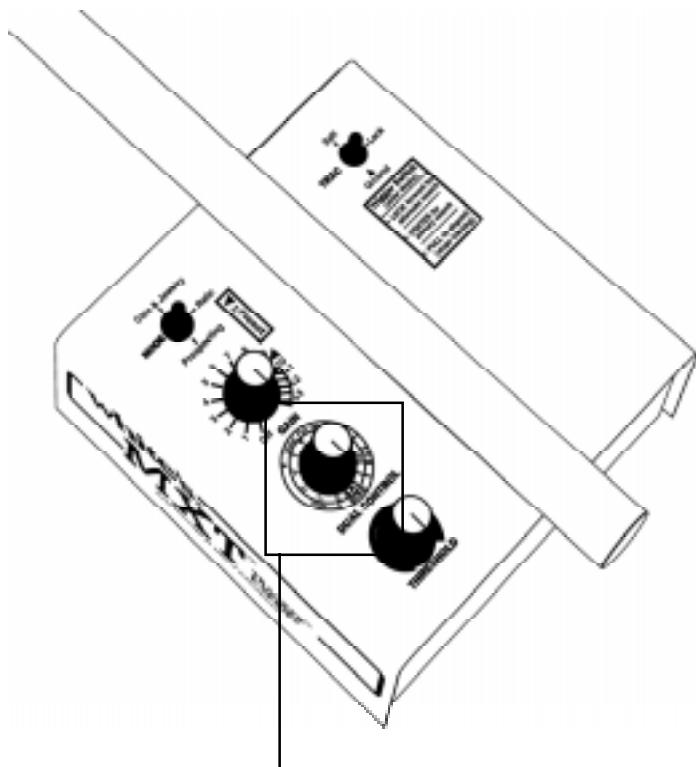

DUAL CONTROL

DISC -DISCRIMINATION (outer ring)
When in COIN & JEWELRY and RELIC MODE

VARIABLE SELF ADJUSTING THRESHOLD SPEED (SAT)
When in Prospecting MODE.

Dual Control

While operating in the Coin & Jewelry or Relic MODEs the Dual control operates as a DISC (discrimination) control.

DISC (Discrimination) is used to adjust the level of audio rejection against trash metals.

The "P" (Preset) just below NICKEL is recommended for most general purpose searching. In this position, the detector will provide a reject response to most iron and light foil and respond to most valuables including jewelry.

Positions lower than "P" (counterclockwise) provide less trash metal rejection, to the point of detecting virtually all types of common metals.

Positions higher than "P" (clockwise) will reject more trash metals including aluminum pull tabs. The display will continue to indicate I.D. even though the audio discriminator will signal with a reject (suppressed or broken) sound. Nickels and some jewelry will also be rejected with DISC settings much greater than "P".

The "P" position is recommended for most MODES. If when searching at the "P" position you feel you are digging too much trash, adjust DISC slightly clockwise and try again. Finding the lowest (furthest counterclockwise) position that eliminates the common trash metals in your area is important in order to find items of jewelry.

The MXT provides six significantly different DISC (Discrimination) modes.

1. Traditional DISC mode is available;

A. In the Coin & Jewelry MODE with the Trigger on the hand grip in the center position

B. And in the Relic MODE with the Trigger in the forward position (with the DISC control used for typical trash rejection).

When a trash metal is being rejected in a Traditional DISC MODE, it will produce no beep at all or a suppressed beep that is shorter sounding typically inconsistent, a click or flutter-sounding beep. When a valuable metal is accepted it will produce a consistent, smooth, solid, and longer sounding beep. When operating below Threshold "silent search" very deep or small targets may appear as mere threshold level responses.

Some large trash metals, such as pieces of lead, pot metal, aluminum, tin, brass, copper, or significant iron will produce a good sound regardless of the DISC control position. An operator must dig these unusual scrap metals to be a successful detectorist.

2. Pull Tab Notch (Coin & Jewelry Mode).

A. While operating in the Coin & Jewelry MODE with the Trigger on the hand grip in the forward position, the Pull Tab range is "notched out" or suppressed regardless of where the DISC control is set. This can be used exclusively as a search MODE or switched to from the center position (traditional DISC) to quickly audibly determine if the target located falls within the Pull Tab range or not. The DISC control should be used at or near "P" to allow for the nickel range to be accepted or ideally set to the highest setting that accepts the nickel.

3. Two Tone I.D. (Relic Mode).

A. While operating in the Relic MODE with the Trigger on the hand grip in the center position, and the DISC control set at any typical rejection level, two tone I.D. also referred to as a "Mixed Mode" (characteristics of both all metal and Disc features) is available. Metals set to be rejected by the DISC control setting produce a lower pitched beep, targets accepted by the DISC control setting produce a higher pitched beep. Some search coil motion is required to achieve detection with either tone.

4. Ferrous (iron) & Nonferrous (not iron) tone I.D. (Relic Mode).

A. While operating in the Relic MODE with the Trigger on the hand grip in the forward position, and the DISC set to "0", Ferrous (iron) metals produce a lower pitch beep and Nonferrous (not iron) produce a higher pitch beep.

5. Iron Grunt (Prospecting Mode)

A. While operating in the Prospecting MODE, with the trigger in center primary position, significant ferrous (iron) produces a distinctive audio grunt, nonferrous (not iron) produces a high pitch VCO dependant zip zip sound.

B. With the Trigger in the forward position all metals respond with the same VCO dependant zip zip sound.

NOTE* THE VISUAL IRON I.D. SYSTEM IS OPERATING IN ALL THREE TRIGGER POSITIONS. The % of Iron Probability is indicated on the display. This system is totally independent of the Audio System.

An operator may wish to choose different DISC levels based on their preferred type of discrimination when using either the Coin & Jewelry or Relic Modes.

The loop must be swept (in motion) for metals to respond and provide accurate discrimination. Each pass of the loop from left to right (or from right to left) should overlap the last by at least 50% and take about two seconds.

At this point, it is a good idea to find an area out-of-doors relatively free of metal to practice. Place a coin on the ground. Pass the loop over the coin. Note that some loop movement is necessary to receive a good clean sound. Note that if you sweep the loop too slow the coin doesn't respond well.

DUAL CONTROL, SAT

When in the Prospecting MODE the DUAL CONTROL is used to adjust the level or speed of SAT (Self Adjusting Threshold). The Threshold or continuous faint hum heard during operation of the MXT can rise or disappear due to environmental interference or by interference of ground mineralization. This can be heard as chatter when excessive. Faster SAT speeds tend to calm this interference allowing for target sounds to be separated from ground noise.

The MXT is computerized, which allows improved SAT in ways not practical in the past. These improvements "kick in" progressively at higher settings allowing better ground silencing in highly variable ground. At these higher settings, cold rocks (rocks well below the current ground mineral rejection level) will sound "different" giving a "double blip" sound or vanishing entirely, rather than giving the "boing" sound you will get at lower settings.

Another difference between a gold nugget and a cold rock is that when you sweep back and forth, the gold nugget will "stay in one spot" but the cold rock will seem to keep wandering around. This can also be the case with a pocket of negative mineralization.

GAIN and VARIABLE SAT (Self Adjusting Threshold) Speed:

The TRAC feature compensates for common ground minerals in the area. The SAT control compensates for the inconsistency of the ground mineralization. The greater the degree of inconsistencies, the more SAT is needed to quiet ground noise. If the THRESHOLD becomes too erratic or noisy, it might be necessary to use the SAT feature and/or reduce the GAIN control. This noisy behavior will make it difficult to recognize a true target (possible nugget) from pieces of mineral, commonly referred to as "hot rocks". It is not wise to keep a high level of GAIN if the detector will not operate smoothly. This is a false sense of security. Maintain as smooth a threshold as you can.

Recognizing a true target is the most important part of detecting. This is an example of when less GAIN will produce more nuggets. You must be the best judge of just how much noise you can tolerate and still identify nuggets, and thus the amount of SAT and GAIN to use to produce the desired results in your area. Therefore, if you have been operating your MXT at the full level of GAIN (+3) and you determine that this is too high because either the threshold is erratic or the detector is giving false signals; always begin by reducing the GAIN toward the Initial Setting triangle. If this does not correct the problem, start adding some SAT speed by turning the SAT control slowly clockwise. If this does not correct the problem, go back to the GAIN and reduce it a little more and add a bit of SAT. As I mentioned earlier it is sort of like seasoning a pot of soup. Some salt and some pepper. Remember any drop in GAIN below (7-8) will result in some loss of depth. Any increase in SAT speed above the "P" setting may also effect overall depth.

However, before reducing the Gain below 7 - 8 you might try to experiment a bit with the HYPERSAT range of the SAT control. This function is unique to White's SAT. The Threshold will almost buzz and loss of depth will be minimal. Reserve this option for situations where ground is unusual or conditions extreme. If you can't control your Threshold with small reductions in Gain or small increasing SAT, then "jump start" your SAT into the HYPERSAT range. Before attempting this, you might practice sweeping over a test nugget to learn to identify it's sound with HYPERSAT.

We like to use the analogy of driving on a straight road versus a curvy road. The object is to get from point A to point B. 65 m.p.h. might get you there on a straight road, but you will have to slow to 35 m.p.h. if the road is curvy, or you will end up off the road. The straight road is like low mineralized ground and the curvy road is like heavy mineralization. High Gain and slower SAT will not get you the Gold in heavy mineralization as well as lower GAIN and faster SAT.

Threshold Control

The THRESHOLD control sets the loudness of the background "hum" or edge of sound. This background "hum" should normally be maintained during searching. In order to hear the tiniest and deepest targets the THRESHOLD "hum" should be set at the faintest audible level. It can be slightly scratchy, chatter or static like but it must be constant so as to not miss that small or deep targets. At this point, we can't recommend too highly the advantage of using HEADPHONES. With HEADPHONES you can lower THRESHOLD "hum" levels, you will hear the faintest of target signals while cancelling out environmental background noise and improving concentration.

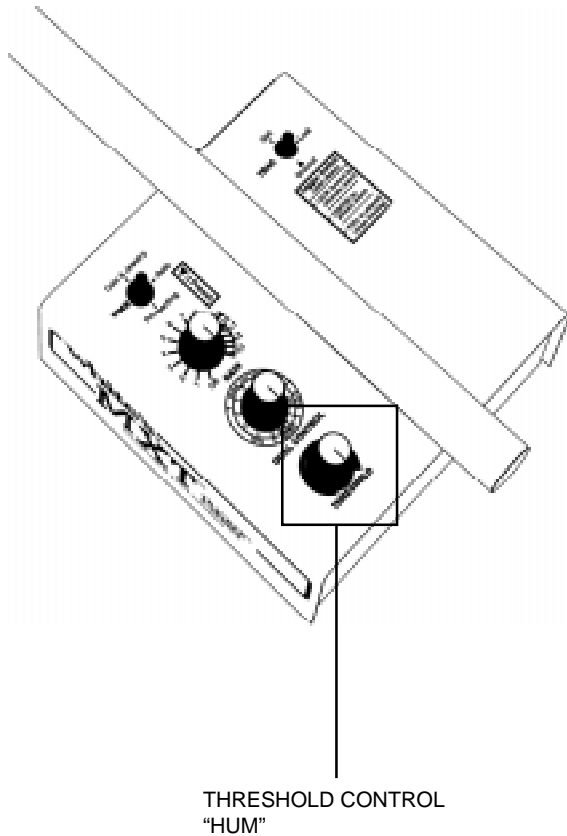

Threshold Adjustment

The MXT has an improved microprocessor driven THRESHOLD control that is adjusted with a single turn. It does not, therefore, require a 10 turn pot for precise adjustment. Digital software provides much higher resolution, thus you can set the "hum" faster and more accurately. Set the knob all the way to the left or counterclockwise and then rotate it clockwise until the faintest audible level of "hum" is attained (edge of sound). If the "hum" disappears for any reason (other than bumping the control) you may be either swinging the coil too fast or your GAIN control is set too high, or in the prospecting MODE you may need to increase the speed of SAT.

Silent Search

With microprocessor driven THRESHOLD controls arguably skillful operators can "cheat the system" and use silent search with high performance results. Once the threshold is found, edge of sound, setting the Threshold control slightly counterclockwise achieves silent search where no threshold hum is heard during searching. By further optimizing Gain to radical levels, much of that resulting noise can be hidden under the Threshold and thus good field results. Best reserved for more experienced operators, a balancing act between higher Gain V.S. a stronger response required to surpass the threshold setting, must be achieved and understood.

Pinpointing

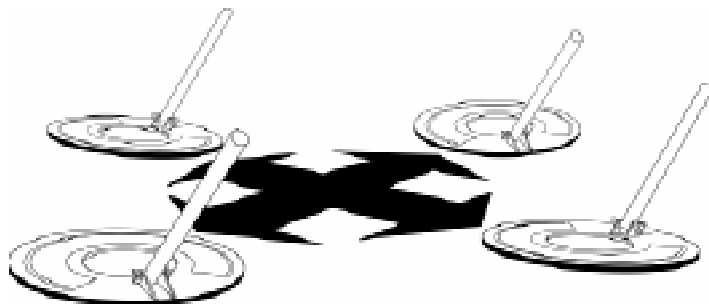

NOTE: Turn the detector 90° to the first side to side loop movement and repeat for "X"ing the center.

Pinpoint Technique

Due to the wide scan nature of modern search coils it can be difficult to locate small targets under the physical center of the loop. Use an "X" marks the spot technique as shown in the diagram to identify the portion of ground the metal target is in. Prospecting for small nuggets, because small metal targets are more difficult to isolate to an exact location compared to coin or relic hunting, may require removing the soil under the center of the "X" until the target is no longer in the hole, but in your pile of dirt. Techniques for examining the pile of dirt are discussed later in the manual.

Again, the procedure is to sweep over the target from side to side noting the side to side center. Then turn 90 degrees and sweep the coil side to side noting the center from this new direction. "X" marks the spot that you need to dig. You can practice with a coin or small pieces of lead or gold on top of the ground to become acquainted with the technique.

During Prospecting it is a good idea to have a magnet handy, preferably in the handle of your digging pick, to pull iron out of the dirt pile. It will speed up your recovery time. It will work on small almost invisible iron rocks as well.



Headphones

The headphone jack on the GMX is located on the control box above the battery compartment. There is a dust cover on the headphone jack that needs to be removed before the stereo plug from the headphone is inserted. Replace it when headphones are not being used. Most users prefer high quality stereo headphones so White's has chosen to wire the headphone jack for stereo. If you have a mono headphone, you can purchase an adapter that will allow sound in both earpieces. Some headphones come with a switch for stereo or mono jacks.

In choosing headphones, make sure they have a VOLUME CONTROL as there is no target volume control on the GMX. This is an important comfort issue. Remember that you want the faintest THRESHOLD "hum" possible but a strong comfortable target signal. With headphones you will be able to work with a lower THRESHOLD "hum", hear fainter target signals, avoid bothering others with a "beeping" box, and save on battery life. Many high quality headphones from full ear enclosure to lightweight summer models that offer a bit more safety in snake and bear country are available on the market. Higher impedance headphones (60 Ohms or greater) give the most sensitivity and are better for hearing the tiny targets most likely to be heard while prospecting. Properly balanced impedance is important as well as low distortion.

Field Use & Tuning Tips

Coin & Jewelry MODE

1. MODE to Coin & Jewelry

2. **Trigger (on hand grip)** center "primary Searching" position.

3. **TRAC** to Ground position.

4. **GAIN** to "P" position.

5. **Threshold**, adjust for slight hum (edge of sound).

6. **DUAL CONTROL** to DISC "P".

7. **Pump the search coil** on the ground to be searched until ground ceases to respond.

8. **Move the coil** just over the ground and listen for the distinct repeatable beep produced by a good metal target. It is wise to plant metals just under the soil to practice on in order to learn to recognize what it will sound like. Planting a metal target disturbs the ground mineral, which usually reduces the depth it would have been found in undisturbed ground. It will take practice to determine the proper search speed and technique. Do not go too fast. Try to overlap your sweep path so that you won't miss the small and/or deeper metal targets.

9. Once a solid repeatable beep is located:

A. Consult the display information.

B. Squeeze and hold the Trigger on the hand grip and "X" the area to pinpoint and note how deep you will need to dig listed on the display.

OPTIONAL method for Pull Tab/Jewelry separation:

10. Once a solid repeatable beep is located

A. Push the Trigger forward and sweep the search coil over the target area.

1. If it still beeps it is likely a coin worth digging, proceed with 2.

a. If it doesn't beep it is in the Pull Tab range, Squeeze and hold the Trigger on the hand grip and check the depth. If it is shallow (0 - 2 inches) depending on the hardness of the ground, it is most likely a Pull Tab and should be ignored. If it is deeper (beyond 2 inches) depending upon the hardness of the ground, it is likely heavier gold jewelry and should be dug.

2. Consult the display information.

3. Squeeze and hold the Trigger on the hand grip and "X" the area to pinpoint and note how deep you will need to dig listed on the display.

11. Heavy Pull Tab. In areas littered with hundreds of Pull Tabs it may be necessary to search full time in the Trigger forward position and save your time and efforts digging coins and jewelry that indicate outside the pull tab range.

11. Ground Mineralization:

A. For Salt/Alkali environments proceed exactly as above only with the TRAC toggle in the Salt position.

B. For areas with an abundance of decomposed man made iron (which may make the MXT appear unstable only during search coil sweeps), proceed exactly as above only once you pump the loop over the ground, then set the Trac control to Lock.

Coin & Jewelry MODE

The Coin & Jewelry MODE provides good general purpose searching for a wide variety of targets and environments.

From residential yards, parks and school grounds, farm fields, to beaches (for beaches use TRAC Salt), the Coin & Jewelry MODE should be used if there is any doubt at all regarding which of the three available MODEs is most practical for your current search.

As the name implies, Coins & Jewelry are the primary goals of this mode, however, these settings and features will also respond to any better alloy including common relics and any other item made of a valued metal alloy.

The 1st choice a user should consider is the selection of an appropriate TRAC toggle setting for the area. The Ground setting and Salt settings should be almost self explanatory. If you are searching in typical ground, use the TRAC Ground setting. If you are in a salt water or desert alkali ground condition, use the TRAC Salt setting. When to use the Lock setting can be less obvious. If it seems like something is wrong with the detector, wildly fluctuating Threshold hum (only while sweeping the search coil), try the Lock setting. If the detector smooths out and starts operating more predictably, you made the correct choice. If there isn't any change, you may need to either reduce the Gain control counterclockwise and/or increase the Dual control (Disc) clockwise and try again. An area littered with man made iron would dictate the Lock setting. On the other hand an area littered with small aluminum foil would not, such an area would dictate the Reduced Gain and/or higher discrimination settings.

The 2nd choice is Gain. Some areas require, and some operators just prefer the more predictable operation reduced Gain settings provide, where as others prefer to push Gain to the limits of their patience to find the deepest targets. There is a point of diminishing returns either indicated by the display telling you to lift the loop due to a Gain setting too high for the ground, or a user missing targets because they can not sort them from sporadic noise experienced at high Gain.

To see complete details or to purchase the White's MXT Standard Metal Detector, visit:
<http://www.metaldetector.com/whites-mxt-standard-metal-detector>

The 3rd choice is the alternate MODE "Pull Tab Notch" accessed by pushing the Trigger (on the hand grip) forward. Many prefer, after locating a target in the primary Trigger center position, to check targets with the Pull Tab Notch, others use the Pull Tab Notch as their primary search mode. It depends a lot on the area and degree of aluminum Pull Tabs present. Remember, the display will indicate if a metal target is in the Pull Tab range in either Trigger position. Also remember a metal target that indicates in the Pull Tab range however, provides a deep depth indication, is more likely to be jewelry than a Pull Tab. There are three types of targets that typically indicate in the Pull Tab range, Aluminum, Lead, Brass, and Gold. Without consistency in size/shape, all a metal detector can tell you is that it indicates within that range of targets. It is up to the operator to identify the common trash items of each area and then gamble with the odds weighing the likelihood of good targets compared to wasted time digging trash.

The 4th choice is the level of audio Discrimination (DUAL CONTROL). The "P" setting provides a popular setting rejecting most iron and small foil and accepting nickels and most jewelry. Remember you have the display to further sort out accepted metals. However, if the common trash of the area consistently produces an audio to the point of distracting from finding anything at all, an operator can increase discrimination (clockwise) and cherry pick the area for silver and copper. If a hot spot of multiple coins is located an operator may then want to search isolated spots within that area at lower discrimination settings. Even with modern discriminating metal detectors, it takes a good deal of patience to search high trash areas.

The 5th choice is Threshold level. It is best to search with a continuous hum or threshold (edge of sound). You can hear rejected targets (threshold fades) and be made aware when and where concentrations of trash items lay, indicating traffic areas more likely to produce good targets. It, however, requires more patience and concentration. Finding the Threshold, and then setting the Threshold just counterclockwise of it (Silent Search), provides good performance for those who can not tolerate the continuous Threshold hum all the time.

Chapter 6 MXT Searching

Relic MODE

1. **MODE to Relic.**
2. **Trigger (on hand grip)** center "primary Searching" position.
3. **TRAC** to Ground position.
4. **GAIN** to "P" position.
5. **Threshold**, adjust for slight hum (edge of sound).
6. **DUAL CONTROL** to DISC "P".
7. **Pump the search coil** on the ground to be searched until ground ceases to respond.
8. **Move the coil** just over the ground and listen for the distinct repeatable beep (high or low tone) produced by a metal targets. It is wise to plant metals just under the soil to practice on in order to learn to recognize what it will sound like. Planting a metal target disturbs the ground mineral, which usually reduces the depth it would have been found in undisturbed ground. It will take practice to determine the proper search speed and technique. Do not go too fast. Try to overlap your sweep path so that you won't miss the small and/or deeper metal targets. Targets too deep or small to achieve good tone identification will sound at the threshold level tone.

9. Once a solid repeatable beep is located:

- A. Consult the display information.
- B. Squeeze and hold the Trigger on the hand grip and "X" the area to pinpoint and note how deep you will need to dig listed on the display.

OPTIONAL method for lesser interest in iron and/or quieter searching:

10. Lock Trigger (on hand grip) forward.

- A. Rejected targets are now suppressed

28 rather than indicating a lower pitched beep.

To see complete details or to purchase the White's MXT Standard Metal Detector, visit:
<http://www.metaldetector.com/whites-mxt-standard-metal-detector>

11. Ferrous (iron) / Nonferrous (not iron) I.D. (Archeologist) or Mixed Mode.

- A. Lock Trigger (on hand grip) forward.
- B. Set DISC control to "0".
- C. Ferrous (iron) indicates with a lower pitched beep.
- D. Nonferrous (not iron) indicates with a higher pitched beep.
- E. Some loop motion is required for detection and identification to occur.

12. Ground Mineralization:

- A. For Salt/Alkali environments proceed exactly as above only with the TRAC toggle in the Salt position.
- B. For areas with an abundance of decomposed man made iron (which may make the MXT difficult to operate), proceed exactly as above only once you pump the loop over the ground in the Ground TRAC setting, then set the TRAC control to Lock.

The Relic MODE also provides good general purpose searching for a wide variety of targets and environments although it will require greater patience to use in populated areas compared to Coin & Jewelry as the Relic MODE is designed to locate a wider variety of metal alloys.

As the name and target labels imply, the Relic MODE is designed with late century war artifacts in mind as the primary goals, however, these settings and features will also respond to any better alloy including common coins and any other item made of a valued metal alloy.

In the primary Trigger (on the hand grip) center position, any target accepted by the discrimination setting produces a higher pitch beep and any metal target rejected by the discrimination setting produces a lower pitched beep. Uncertain targets may respond in-between with the Threshold pitch.

The 1st choice a user should consider is the selection of an appropriate TRAC toggle setting for the area. The Ground setting and Salt settings should be almost self explanatory. If you are searching in typical ground, use the TRAC Ground setting. If you are in a salt water or desert alkali ground condition, use the TRAC Salt setting. When to use the Lock setting can be less obvious. If it seems like something is wrong with the detector, wildly fluctuating Threshold hum (only during sweeping the search coil), try the Lock setting. If the detector smooths out and starts operating more predictably, you made the correct choice. If there isn't any change, you may need to return to the Ground or Salt setting and either reduce the Gain control counterclockwise and/or increase the Dual control (Discrimination) clockwise and try again. An area littered with man made iron would dictate the Lock setting. On the other hand an area littered with small aluminum foil would not, such an area would dictate Reduced Gain and/or higher Disc settings.

The 2nd choice is Gain. Some areas require, and some operators just prefer, the more predictable operation reduced Gain settings provide, where as others prefer to push Gain to the limits of their patience to find the deepest targets.

There is a point of diminishing returns either indicated by the display telling you to lift the loop due to a Gain setting too high for the ground, or a user missing targets because they can not sort them from sporadic noise experienced at high Gain.

The 3rd and 4th choices are the traditional discriminator accessed by pushing the Trigger (on the hand grip) forward and using a typical discrimination level. Or reducing discrimination to "0" and utilizing a high tone for nonferrous (not of iron) and low tone for ferrous (iron). The traditional discriminator produces fewer noises suppressing any metal target signal below the discrimination setting. Reducing the discrimination to 0 for two tone requires greater patience as all metals respond with either a high tone (not iron) or low tone (iron). The advantage is in sorting multiple targets, and locating iron.

The 4th choice is the level of audio Discrimination (DUAL CONTROL). The "P" setting provides a popular setting rejecting most iron and small foil and accepting nickels and most jewelry. Remember you have the display to further sort out accepted metals. However, if the common trash of the area consistently produces an audio to the point of distracting from finding anything at all, an operator can increase discrimination (clockwise) and "cherry pick" the area for silver and copper. If a hot spot of multiple coins is located an operator may then want to search isolated spots within that area at lower discrimination settings. Even with modern discriminating metal detectors, it takes a good deal of patience to search high trash areas.

The 5th choice is Threshold level. It is best to search with a continuous hum or threshold (edge of sound). You can hear rejected targets (threshold fades) and be made aware when and where concentrations of trash items lay, indicating traffic areas more likely to produce good targets. It, however, also requires more patience and concentration. Finding the Threshold, and then setting the Threshold just counterclockwise of it, provides good performance for those who can not tolerate the continuous Threshold hum.

Chapter 6 MXT Searching

Prospecting MODE

1. **MODE to Prospecting.**
2. **Trigger (on hand grip)** center "primary Searching" position.
3. **TRAC** to Ground position.
4. **GAIN** to "P" position.
5. **Threshold**, adjust for slight hum (edge of sound).
6. **DUAL CONTROL** to SAT "P".
7. **Pump the search coil** on the ground to be searched until ground ceases to respond.
8. **Move the coil** just over the ground and listen for the distinct repeatable beep produced by a metal target. The Prospecting Mode utilizes a VCO (Voltage Controlled Oscillator) audio thus the pitch of the beep varies with the strength of the target. It is wise to plant metals just under the soil to practice on in order to learn to recognize what it will sound like. Planting a metal target disturbs the ground mineral, which usually reduces the depth it would have been found in undisturbed ground. It will take practice to determine the proper search speed and technique. Do not go too fast. Try to overlap your sweep path so that you won't miss the small and/or deeper metal targets.

9. Once a solid repeatable VCO beep is located:

- A. Consult the display VDI number and % ? Iron.
- B. Squeeze and hold the Trigger on the hand grip and "X" the area to pinpoint.

OPTIONAL method for iron.

10. Lock Trigger (on hand grip) forward.

- A. Ferrous (iron) targets now sound the same as all other metals rather than being indicating by a grunt.

11. Ground Mineralization:

- A. For Salt/Alkali environments proceed exactly as above only with the TRAC toggle in the Salt position.
- B. For areas with an abundance of decomposed man made iron (which may make the MXT difficult to operate), proceed exactly as above only once you pump the loop over the ground in the Ground TRAC setting, then set the TRAC control to Lock.
- C. For highly inconsistent ground it may be necessary to increase the Dual Control SAT adjustment clockwise. Hyper SAT provides threshold maintenance for the most extreme conditions. Search coil motion becomes increasing more critical at these higher SAT speeds.



PROSPECTING MODE

The Prospecting MODE will require greater patience to use compared to the Coin & Jewelry and Relic MODEs. It is designed to locate all varieties of metal alloys and then give some indications as to if the metal being detected is made of ferrous (iron) or nonferrous (not iron).

As the name and target labels imply, the Prospecting MODE is designed to find gold nuggets, however, these settings and features will also respond to all metal alloys including common coins.

In the primary Trigger (on the hand grip) center position, any target likely to be iron (ferrous) produces an audio grunt and any metal target not readily identified as iron (nonferrous) produces a traditional VCO pitched beep (zip sound). With the Trigger (on the hand grip) in the forward position, or squeezed and held position, all metals produce the same traditional VCO pitched beep (zip sound) and ground tracking doesn't occur.

The 1st choice a user should consider is the selection of an appropriate TRAC toggle setting for the area. The Ground setting and Salt settings should be almost self explanatory. If you are searching in typical ground, use the TRAC Ground setting. If you are in a salt water or desert alkali ground condition, use the TRAC Salt setting. When to use the Lock setting can be less obvious. If it seems like something is wrong with the detector, wildly fluctuating Threshold hum (only during search coil passes), try the Lock setting. Before switching to the Lock setting, be sure to pump the search coil up and down over the ground a few times in the Trac Ground or Salt setting to insure that you have achieved proper ground balance for that area. If the detector smooths out and starts operating more predictably in Lock, you made the correct choice. If there isn't any change, you may need to return to the Ground or Salt setting and either reduce the Gain control counterclockwise and/or increase the Dual control (SAT) clockwise and try again. An area littered with man made iron would dictate the Lock setting. On the other hand an area with very inconsistent ground would not, such an area would dictate Reduced Gain and/or higher SAT settings.

The 2nd choice is Gain. Some areas require, and some operators just prefer, the more predictable operation normal "P" or reduced Gain settings provide. Where as others prefer to push Gain to the limits of their patience to find the deepest targets. There is a point of diminishing returns either indicated by the display telling you to lift the loop due to a Gain setting to high for the ground, or a user missing targets because they can not sort them from sporadic noise experienced at high Gain.

The 3rd choices goes hand in hand with the Gain setting and is the SAT speed or level controlled by the DUAL CONTROL. Higher (faster) SAT speeds are more user friendly, however, may compromise some sensitivity particularly to small nuggets as well as adding additional search coil sweep requirements. On the other hand faster SAT will allow for higher Gain settings and more inconsistent ground conditions. A balancing act must be achieved between the Gain control and SAT speed that provides both good performance and enough stability to recognize nuggets from ground or external noise. A new SAT feature "Hyper SAT", provides for the most extreme conditions with very unique characteristics.

The 4th choice is Threshold level. It is best to search with a continuous hum or threshold (edge of sound). You can hear smaller and/or deeper nuggets and be made aware when the SAT speed is doing its job maintaining the Threshold hum. It, however, also requires more patience and concentration. Finding the Threshold, and then setting the Threshold just counterclockwise of it, provides good performance for those who can not tolerate the continuous Threshold hum.

The 5th choice is if you prefer the normal Primary search MODE, Trigger (on hand grip) in center position, that provides a distinctive grunt on iron, or the Trigger forward position that produces the same VCO audio tone for all targets.

Information

Proper care

I. Cleaning

A. Both the coil and rod are waterproof and can be cleaned with fresh water and mild soap. The control box is not water proof and must be kept dry. **Never** lift a wet coil above the height of the control box as water can run down the inside of the rod damaging the electronics. A damp cotton cloth can be used to wipe off a dirty control box.

II. Weather

A. Do not expose your detector to the conditions of a car trunk during winter and/or summer extremes.

B. Protect it from direct sunlight during storage.

C. The control box is rain resistant. However, it must be protected from heavy rain.

III. Storage

A. When the instrument is not in use, make sure it is turned OFF.

B. If you plan on storing your detector for long, remove the battery holder from the instrument and remove the batteries from the holder.

C. Store the instrument indoors, in an area where it will be protected from abuse. Over the years White's has noted more service repairs and physical damage, on units in storage than those experiencing daily use.

IV. Additional Precautions

A. Avoid dropping your detector while attempting to set it down to dig.

B. Avoid using your detector for leverage when standing up from a dig.

C. Do not use any lubricants, such as WD-40, on any part of your detector.

D. Do not modify your instrument during its warranty period.

Service

White's reputation has been built on quality products backed by quality service. Our Factory Authorized Service Centers are factory trained and equipped. They offer the same quality service as the factory. Service before and after the sale is the cornerstone of our customer relations.

White's Authorized USA Service Centers:

Centerville Electronics
13810 B Braddock Road
Centerville, Virginia 20121
Toll Free 1-888-645-0202
Fax: 1-703-222-8625
E-Mail: centelec@vwx.com

Geoquest
106 US Hwy. 46
Saddle Brook, New Jersey 07662
Toll Free: 1-877-772-7443
Fax: 1-973-772-7773
E-Mail: geoquest@erols.com

Electronic Exploration
700 South Main
Lombard, Illinois 60148
Toll Free: 1-800-392-3223
Fax: 1-630-620-1005
E-Mail: tony@ee-il.com

White's Electronics, Inc.
1011 Pleasant Valley Road
Sweet Home, Oregon 97386
Telephone: 1-541-367-6121
Fax: 1-541-367-6629
E-Mail: nbaker@whiteselectronics.com

Before shipping detectors for service:

- A.** Contact your Dealer. There may be a quick, simple fix or explanation that will prevent having to send the detector in for service.

- B.** Double check the obvious, such as batteries, and try the detector in another area to be sure there is not interference.

- C.** Be sure to send all necessary parts with your detector, such as search coil, batteries and holders, as these items can result in symptoms.

- D.** Always include a letter of explanation about your concerns, even if you have talked to the Service Center by telephone.

- E.** Take care in packaging instruments for shipping and always insure your package.

Warranty

If within two years (24 months) from the original date of purchase, your White's detector fails due to defects in either material or workmanship, White's will repair or replace at its option, all necessary parts without charge for parts or labor.

Simply return the complete detector to the Dealer where you purchased it, or to your nearest Authorized Service Center. The unit must be accompanied by a detailed explanation of the symptoms of the failure. You must provide proof of date-of-purchase before the unit is serviced.

This is a transferable manufacturer warranty, which covers the instrument two years from the original purchase date, regardless of the owner.

Items excluded from the warranty are non-rechargeable batteries, accessories that are not standard equipment, shipping / handling costs outside the continental USA, Special Delivery costs (Air Freight, Next Day, 2nd Day, Packaging Services, etc.) and all shipping / handling costs inside the continental USA 90 days after purchase.

White's registers your purchase only if the Sales Registration Card is filled out and returned to the factory address by your dealer, soon after original purchase for the purpose of recording this information, and keeping you up-to-date regarding White's ongoing research & development.

The warranty does not cover damage caused by accident, misuse, neglect, alterations, modifications, unauthorized service, or prolonged exposure to corrosive compounds, including salt.

Duration of any implied warranty (e.g., merchantability and fitness for a particular purpose) shall not be longer than the stated warranty. Neither the manufacturer or the retailer shall be liable for any incidental or consequential damages. Some states however, do not allow the limitation on the length of implied warranties, or the exclusion of incidental or consequential damages. Therefore, the above limitations may not apply to you.

In addition, the stated warranty gives you specific legal rights, and you may have other rights which vary from state-to-state.

The foregoing is the only warranty provided by White's as the manufacturer of your metal detector. Any "extended warranty" period beyond two years, which may be provided by a Dealer or other third party on your detector, may be without White's authority involvement and consent, and might not be honored by White's Electronics, Inc.

Warranty Transfer

If for any reason you should sell your MXT prior to the date the warranty expires, the remaining warranty is transferable. **This transfer is authorized by calling 1-800-547-6911, and getting an Authorization Number.**

Simply fill out the following information, including the Authorization Number, seal it in a stamped envelope, and send it to **White's Electronics, 1011 Pleasant Valley Road, Sweet Home, Oregon 97386.** The remaining warranty period will then be available to the new owner.

The Warranty Statement applies to both the original owner as well as the second owner.



 **WARRANTY TRANSFER**

Original Owner:

Name: _____

Address (Which appears on the original warranty card):

Instrument Serial Number: _____

Original Purchase Date: _____

New Owner:

Name: _____

Address: _____

Comments: _____

Distributor Authorization Code: _____

Video

A Video cassette detailing the proper use of the MXT is available. This video explains how to use the MXT in the field, as well as explaining the many varied options. Intended for English speaking persons, it is recorded on VHS format.

White's recommends this video cassette as a valuable learning aid for both beginners, and experienced metal detector users. For more information, please contact your Dealer.

Owner Information

Serial Number: _____ (*inside of battery compartment*)

Purchase Date: _____ (*The date on the sales receipt*)

Dealer Name: _____

Address: _____

Telephone #: _____

Payment method: _____

Personal markings: _____

A message from ...

**Kenneth R. White, President
White's Electronics, Inc.**



metal detectors

It is with pride that we put our American Made label on every metal detector we build. At our facility here in Sweet Home, Oregon, we've been proudly building the world's finest metal detectors in the world for over fifty years now.

It starts in Marketing and Engineering with a plan using the very latest technology to design detectors better than the ones before. Once we've thoroughly tested and refined a new design in the field, it's ready for production. We take raw metal, bend, paint, bake and silkscreen to form a housing. Wire is wound, plastic is formed, and foam is inserted to construct a loop. Rods are bent and punched. Boards are stuffed and soldered. Knobs and displays are added. Manuals and catalogs are designed and written right here.

At every step of the way, quality is foremost. Each detector is quality checked after each process, and bench-tested one more time before it goes out the door. And if you need service, our Customer Service Department does their best to repair your detector quickly so you can get back out in the field.

Finally, finished detectors are shipped out the door here in Sweet Home to virtually every corner of the world.

It has always been my philosophy to keep our people working by keeping our customers happy. I'm proud of our metal detectors, and of the people here at White's who build them for you.

White's Electronics, Inc.
1011 Pleasant Valley Road
Sweet Home, Oregon 97386
USA
www.whiteselectronics.com

621-0462

Distribution: 1-800-547-6911
Factory: 1-541-367-6121
FAX: 1-541-367-6692
e-mail: info@whiteselectronics.com

To see complete details or to purchase the White's MXT Standard Metal Detector, visit:
<http://www.metaldetector.com/whites-mxt-standard-metal-detector>