



A whole new control experience

# Touchpoint Plus

## Delivering reliable control

- Honeywell reliability from the most trusted experts in gas detection
- Built-in battery backup for constant uptime
- Robust, shockproof housing for a wide range of industrial environments

## Flexible capabilities

- Compatible with the full range of Honeywell gas detectors
- Powered audiovisual alarms simplify field installation
- Configuration includes easy grouping and voting alarm logic without specialist knowledge
- Next-generation compatibility

## Providing ease and efficiency

- Quick and easy installation, configuration, commissioning and maintenance
- Easy diagnostics, data and reporting
- Minimised training time
- Large colour touchscreen LCD
- Multilingual capabilities
- Green-yellow-red status at a glance

**Touchpoint Plus brings a whole new control experience to your small system of gas detectors.**

**Touchpoint Plus is an easily configurable, wall mounted control system that supports up to eight channels of gas detection. Its modular approach enables you to take control and configure what you need for a wide range of applications.**

The signature feature of the Touchpoint line is a user-friendly touchscreen interface, and the Touchpoint Plus takes it to a new level. With this unique interface, it's easier than ever to see the status of your system at a glance - maximizing the time you have to make the right decisions. The intuitive, multilingual interface, simplifies operation and reduces training requirements. The full colour traffic light style status indication provides clarity from a distance too.

Touchpoint Plus includes a comprehensive set of outputs as standard including common alarms and dedicated drives for remote audiovisual indicators. Its modularity enables you to customise your system to meet your specific application requirements. Selecting the right detector for use with your controller can deliver significant savings in startup costs and on-going operations. Our global partner network and dedicated application specialists are able to help make the right choices for your industry.

**With everything at your fingertips, you can take ownership of your system and operate it with confidence, ensuring the safety of your people and productivity of your site.**



# Unique User Experience



## Taking the user experience to a whole new level

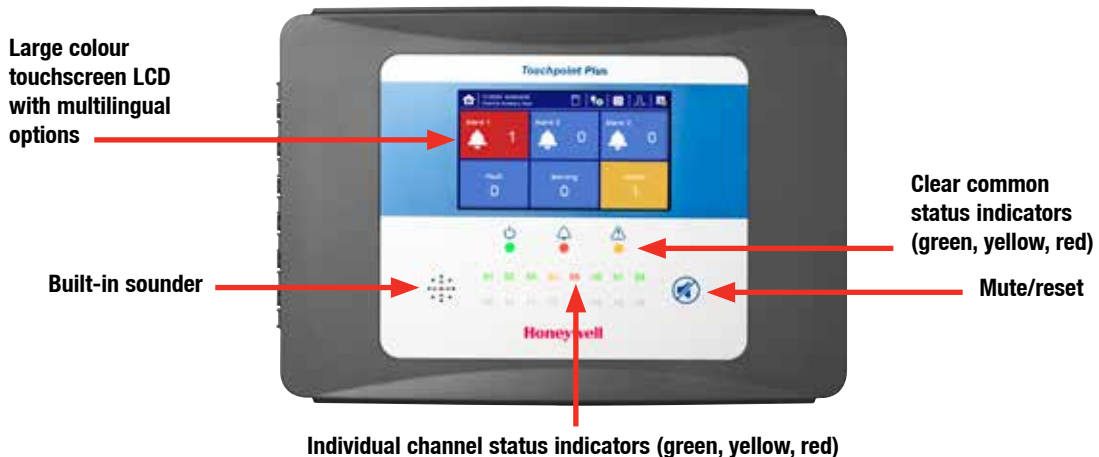

# One System Solution

## Honeywell Analytics' one system solution to meet your safety requirements

Touchpoint Plus provides a reliable safety solution for small scale gas detection systems across a wide range of applications and industries.

As the heart of your gas detection system, Touchpoint Plus is designed to work with Honeywell's industry leading gas detectors and drive actuators, audible and visual alarms to provide a complete end-to-end solution that you can configure as your own.

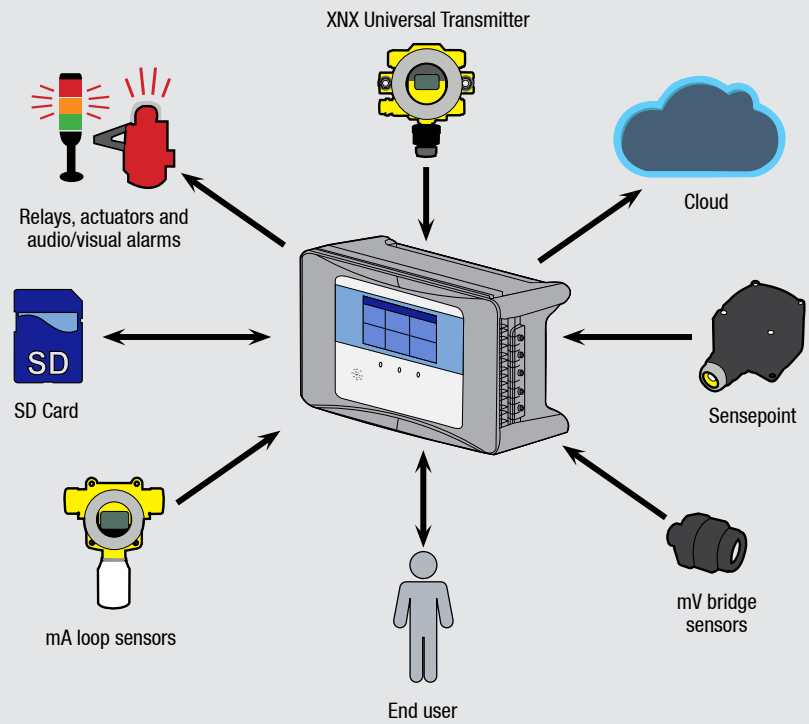

## Typical example of a small gas detection system using Touchpoint Plus

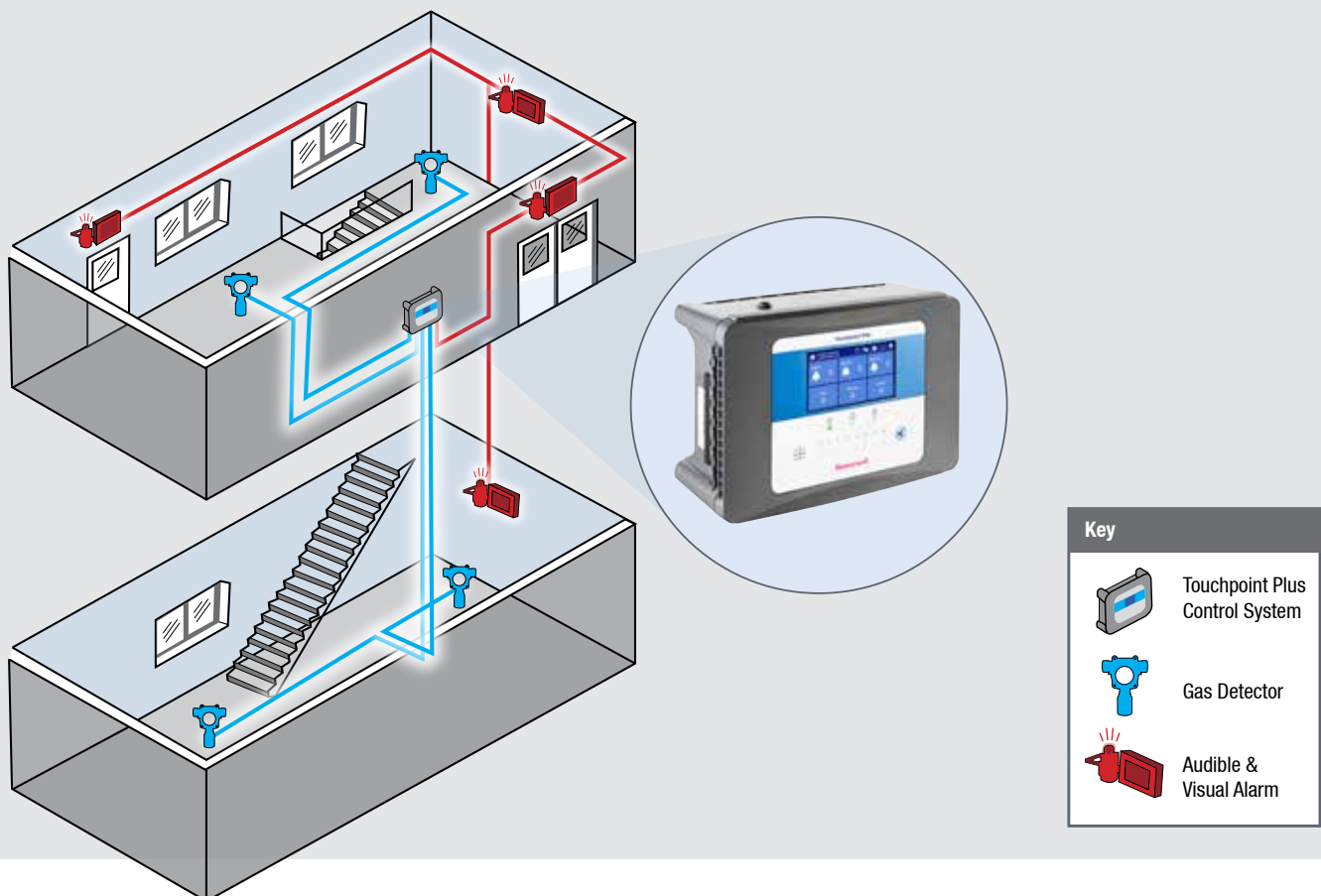



## Designed for speed and reliability

Made of high-impact polymer plastic, Touchpoint Plus is versatile and durable. It's dust-proof, water-proof and has been tested to withstand the toughest environments in which our customers operate - indoors and out. So you can count on the Touchpoint Plus to stand up to the challenges of industrial environments, from mechanical rooms to chemical plants.

Touchpoint Plus is supplied with pre-drilled and sealed cable entries and a unique tiered internal arrangement providing ease of access to save installers time and money.

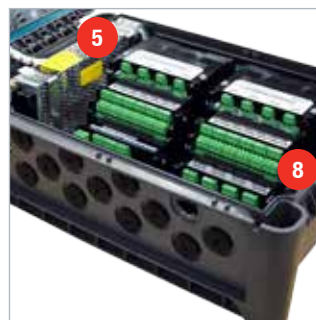
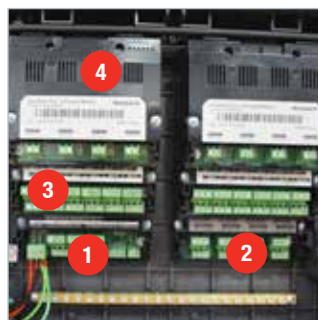
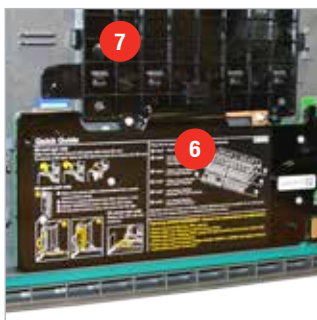

1. Main module
2. Input module
3. Relay output module
4. mA output module
5. Power supply
6. Display module
7. Touchscreen
8. Backup battery

## System Configuration Options

### Provided as standard

- Dedicated powered audiovisual alarm drives
- Common alarm outputs, one for fault and two configurable
- Datalogging to SD Card
- Remote reset and inhibit inputs

### Options

- Choice of AC mains or DC supply voltage
- Optional backup battery
- Choice of 2, 4 or 8 mA or mV inputs
- Optional expansion unit with up to 16 inputs\*
- Choice of 12 or 24 relay outputs
- Choice of 4 or 8 mA outputs
- Optional RS485 Modbus RTU\*
- Optional TCP/IP Modbus/HTTP\*

\*Contact Honeywell Analytics for availability

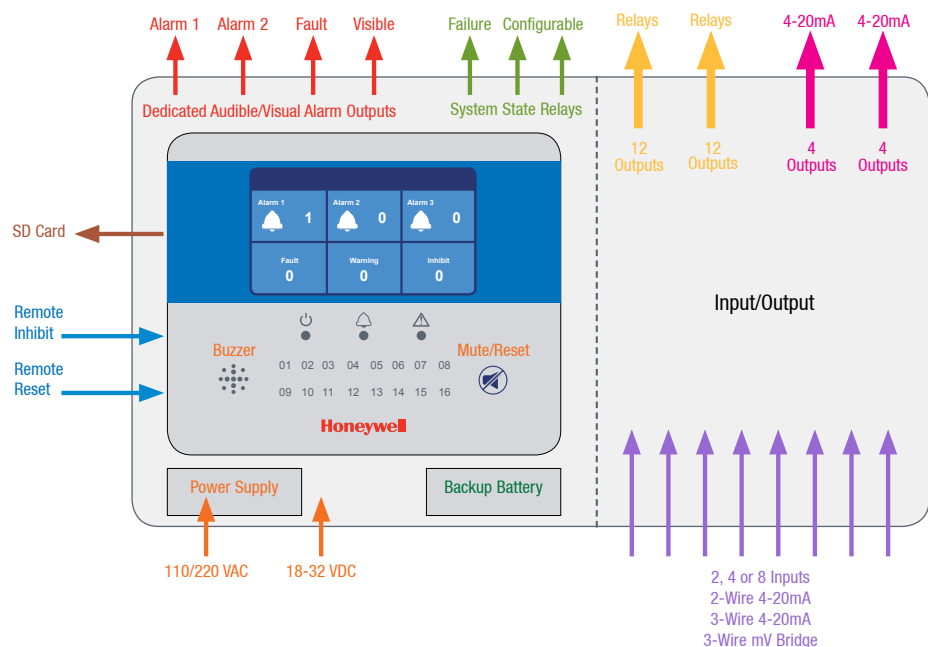

# Installation

## Quick and easy installation - designed to save you time and money

Touchpoint Plus can be directly wall mounted, or for an easier 1-man installation use the optional mounting plate. Open the hinged front cover to find plenty of space for wiring and a unique tiered terminal arrangement for easy access. Cable entries are pre-drilled and sealed ready to use reducing installation time and cost further.

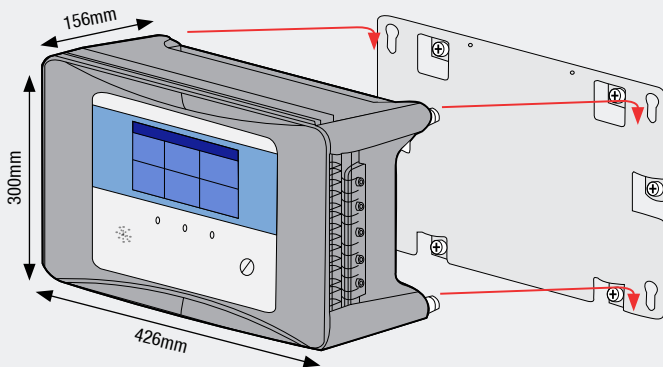

Optional Mounting Plate

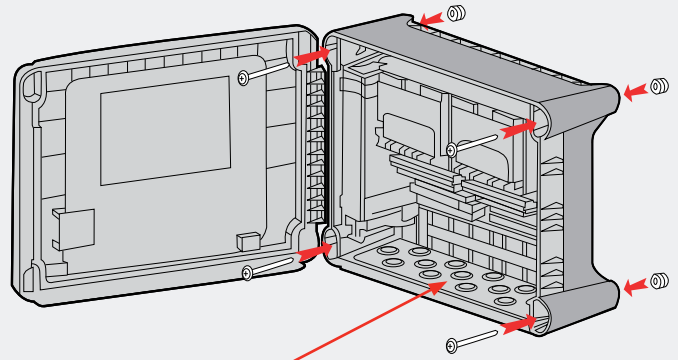

Touchpoint Plus is supplied with 13 pre-drilled and sealed cable entries for for PG16/M20 glands.

Direct Surface Mounting

## Sensor Connection - compatible with a wide range of field devices

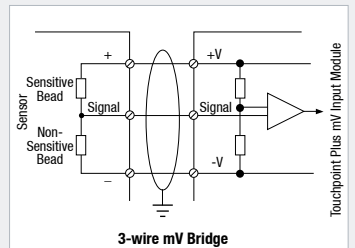
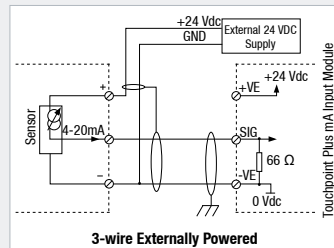
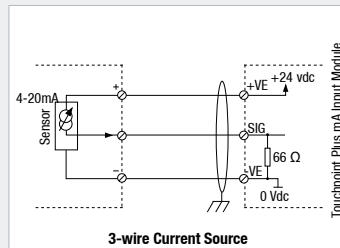
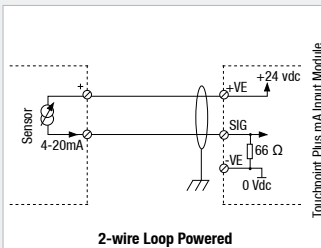

## Available gas detectors

### Sensepoint

### Signalpoint

### 705

### Searchpoint Optima Plus

Simple devices, intrusive configuration, power up to 8 devices directly from Touchpoint Plus



### Sensepoint XCD

### Series 3000 MkII/MKIII

### RAEGuard II PID

Enhanced devices, non-intrusive local operation, adjustment in field, power up to 8 devices directly from Touchpoint Plus



### XNX Universal Transmitter

### Searchline Excel

### Combinations of the above

High integrity devices, specialised configuration, adjustment in the field, monitor up to 8 devices with external power as required



Note: Other field devices available on request.

# Technical Specifications and Ordering Information



General Specification	
<b>Capacity</b>	Up to 8 channels with base unit, up to 16 channels with expansion unit*
<b>Type of Inputs</b>	2 or 3 wires, mA, mV, max. 15W per channel, max 40W total (with dedicated A/V drive) / 68W total (without dedicated A/V drive)
<b>Size (wall-mounted version)</b>	426 mm × 300 mm × 156 mm (16.8" x 11.8" x 6.1")
<b>Housing Material</b>	Polycarbonate ABS
<b>Weight</b>	Max 8.5 kg (18.7 lb)
User Interface (UI)	
<b>Display</b>	7" colour LCD touchscreen. Graphic User Interface
<b>Visual Indicators</b>	3 LEDs for master indicators. LED for each channel. Green: Normal; Yellow: Fault; Inhibit; Red: Alarm
<b>Audible Alarm</b>	≥ 70dB @ 1m
<b>Button</b>	Common for reset/mute operation
<b>Language</b>	English, French, German, Italian, Dutch, Spanish, Portuguese, Russian, Chinese
Power Supply	
<b>Power AC</b>	110/220VAC, 50-60Hz Manual switching
<b>Power DC</b>	18 to 32 VDC (+/-10%) Typical 24VDC
<b>Power Consumption</b>	Max 105W (including detector and external devices)
Environmental	
<b>Operating</b>	-10°C to +55°C (14°F to +131°F) continuous, up to 95% RH (non-condensing), IP65 and NEMA 4X
<b>Storage</b>	Instrument -25°C to +60°C. (-13°F to +140°F), up to 95% RH (non-condensing)
I/O Capacity	
<b>4-20mA Input</b>	2 or 3 wire, 2/4/8 channel modules

I/O Capacity continued	
<b>mV Input</b>	Catalytic type flammable gas detectors (Honeywell models). 2/4/8 channel modules
<b>Dual Input*</b>	2 channel mA + 2 channel mV module or 4 channel mA + 4 channel mV module
<b>Relay Output</b>	12 or 24 relay outputs, NO/C/NC changeover, 5A@30VDC/250VAC, user configurable - energised/de-energised, latching/non latching, time delay
<b>4-20mA Output</b>	4 or 8 isolated repeated mA outputs, 0-22mA, 0-100%FSD = 4-20mA
<b>Common Inputs</b>	Remote reset, remote inhibit
<b>Common Outputs</b>	Four powered A/V outputs for alarms and fault, three common alarm outputs
Approvals	
<b>Electromagnetic Compatibility and Electrical Safety</b>	EMC/RFI (EN 50270:2015) LVD (EN 61010-1:2010) CSA-C22.2 No. 61010-1-04 UL 61010-1 (3 <sup>rd</sup> Edition) and 508
<b>Performance*</b>	Designed to meet - EN 50271:2010; EN 60079-29-1:2007; EN 45544-1 /-2 /-3:2015; EN 50104:2010 C22.2 No. 152-M1984, ISA 12.13.01
<b>Safety Integrity*</b>	Designed to meet - IEC/EN 61508:2010 and EN 50402:2005+A1:2008 SIL2 certification
Others	
<b>Backup Battery</b>	22.2V Lithium Ion Battery, 2600mAh capacity (>30 minutes for typical system)
<b>Data logging</b>	Configuration, logged events and data

\*Contact Honeywell Analytics for availability

## Ordering Information

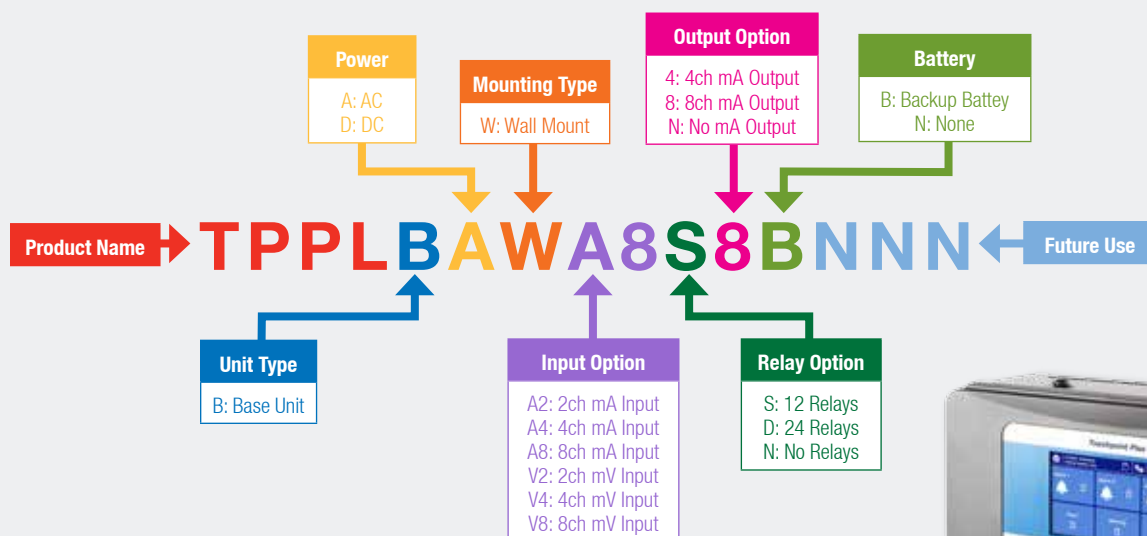

# Honeywell Analytics Gas Detection



Available from:

Environmental and Gas Monitoring Ltd.

Unit 5 Barrmill Road

Galston

Ayrshire

KA4 8HH

Tel 01563 820444

Fax 01563 820163

[www.egm-ltd.com](http://www.egm-ltd.com)

email [info@egm-ltd.com](mailto:info@egm-ltd.com)

[www.honeywellanalytics.com](http://www.honeywellanalytics.com)

[www.raesystems.com](http://www.raesystems.com)

**Honeywell Analytics**  
Experts in Gas Detection

**BWF**  
Technologies  
by Honeywell

**RAE**  
SYSTEMS  
by Honeywell

**Please Note:**

While every effort has been made to ensure accuracy in this publication, no responsibility can be accepted for errors or omissions. Data may change, as well as legislation, and you are strongly advised to obtain copies of the most recently issued regulations, standards, and guidelines. This publication is not intended to form the basis of a contract.

13496\_H\_Touchpoint Plus\_DS01157\_V1\_EMEA

06/15

© 2015 Honeywell Analytics

**Honeywell**