

Chapter 6

Contents

6 Detector Plan..... 6-2

6.1 Detection Type 6-3

 6.1.1 Inductive Loop Detection 6-4

 6.1.2 Multiple Detection Technologies at a Single Intersection 6-4

6.2 Detection Basics..... 6-5

 6.2.1 Presence Detection 6-5

 6.2.2 Advance Detection (or Volume Density Detection) 6-6

 6.2.3 Signal Timing Functions That May Be Used With Detection..... 6-8

6.3 Beyond Basic Detection 6-9

 6.3.1 Interchange Ramps..... 6-9

 6.3.2 Temporary Bridge Signals (one-lane, two-direction) 6-9

 6.3.3 Bicycle Detection 6-10

 6.3.4 Adaptive Signal Timing Detection..... 6-11

 6.3.5 Railroad Detection..... 6-11

 6.3.6 Automated Traffic Signal Performance Measures (ATSPM) 6-12

6.4 Detection Zone Layout Considerations..... 6-12

 6.4.1 Advance Stop Bars 6-12

 6.4.2 Bridge Decks 6-12

 6.4.3 Wide Corner Radius..... 6-13

 6.4.4 Accesses: Driveways, Streets, and Alleys 6-13

 6.4.5 Short Minor Street/Driveway Signalized Approaches 6-15

6.5 Conduit and Junction Box System 6-17

6.6 Synchronous Data Link Control (SDLC) – Bypassing the Detection Input File..... 6-18

6.7 Detection Input File 6-19

6.8 Radar Detector Unit Placement and Labeling 6-20

6.9 Video Detection Camera Placement and Labeling 6-23

6 Detector Plan

This chapter will discuss all the design elements that are needed for detection system, in order of the recommended process for designing a new traffic signal. Design of the detection system typically begins after the signal design.

Detection is required for all vehicle phases to enable the use of Automated Traffic Signal Performance Measures (regardless if any vehicle phases are recalled.)

A separate detection plan sheet is no longer required for radar/video detection. It is still required if loops are approved for use (See Section 6.1.)

Show radar/video equipment on the signal plan sheet **only** (only show the detector unit, detector conduit, and detector wiring.) See Figure 6-1.

Radar/video detection zones and coverage areas are shown on the cabinet print only **at the signal timer's request**. The Region Signal Timer will configure the zone set up. Provide the cabinet print at DAP for the signal timer to review and provide a preliminary configuration. See Chapter 20 for more information on coordinating with the Signal Timer and the process for creating the cabinet print.

Figure 6-1 | Signal Plan Sheet – Show and Detail all radar equipment

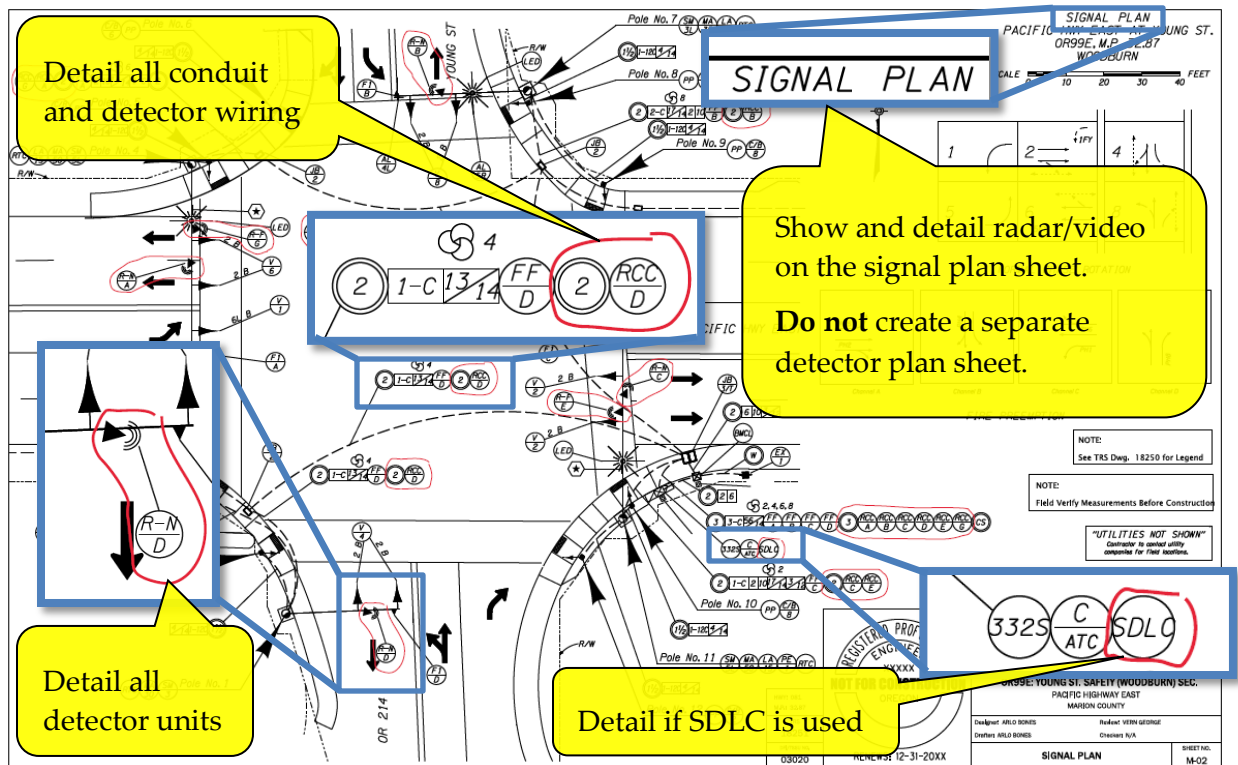

6.1 Detection Type

ODOT's default standard detection type is radar (includes bike detection). Video detection may also be used with concurrence from the region signal operations engineer (Section 6.9 contains specific information for video detection that is in addition to, or differs from the information contained in this chapter that is for radar.) ODOT has selected these non-invasive forms of detection as the standard for the following reasons:

- Ease of moving detection zones (future paving projects and temporary lane configurations can be accommodated.)
- Cost effective for providing automatic traffic signal performance measures (ATSPM) which can require significantly more points of detection than traditional detection layouts.
- Ability to easily maintain detection zones (repairing damaged inductive loops requires a contractor. Historically, ODOT has not been successful repairing damaged loops in a reasonable timeframe due to limited maintenance funding.)
- Simplifies the controller cabinet hardware and improves troubleshooting ability (when using the standard SDLC connection.)
- Ability to accommodate dynamic entry speeds to the intersection for improved dilemma zone protection (e.g. red/green extension)

No form of detection is without drawbacks and non-invasive forms can have issues with occlusion, less accurate counting, weather, etc. Non-invasive forms of detection may not be the perfect solution in every case, however, these drawbacks will be tolerated to achieve the higher level benefits listed above.

Non-invasive forms of detection are typically mounted on the mast arm, luminaire arm or vertical signal pole and should work well in the majority of locations. However, there are situations where additional detection devices or unique mounting locations (e.g. stand-alone vehicle pedestals):

- Roadway/intersection geometry that limits the line of sight for the detection device.
- Low illumination levels.
- Occlusion.
- Existing conduit condition/fill rate will not allow adding new wiring.

Non-invasive detection devices used on the project must be listed on the approved traffic signal product lists (green sheets and/or blue sheets.) Devices not listed on the green and/or blue sheets require approval from the State Traffic Signal Engineer.

Other forms of detection, such as inductive loops and preformed inductive loops may be used only if an investigation finds that non-invasive detection is not feasible. For example:

- Retro-fit situations where conduit condition/fill rate limits installation of additional cables *and* installing stand-alone vehicle pedestals to mount the devices is not an option.
- Controller cabinet space limitation *and* replacing the controller cabinet is not an option.

This investigation should be done as early as possible in the design process, ideally before DAP. In these cases, the region traffic engineer should concur with the investigation to use loops and send justification to the State Traffic Signal Engineer for approval via email. If the State Traffic Signal Engineer approves use of loops, the Traffic Signal Asset Management Program will track these locations to enable proper scoping and funding of future projects.

When a project impacts ANY existing loop detection, it should be replaced with non-invasive detection.

Installing loops should be avoided.

6.1.1 Inductive Loop Detection

Loop detection is no longer the ODOT standard as advances in controller cabinet hardware and software are making it less desirable from an efficiency, cost effectiveness and maintenance standpoint. Loop detection is also not compatible with an SDLC connection in the 332s controller cabinet and limits the ability to implement automatic traffic signal performance measures (which is a high priority for the agency.)

If the State Traffic Signal Engineer approves the use of loops on your project, information for how to detail and show loops on a detector plan sheet will be provided. See the 2017 version of this manual (archived and available on the [traffic signals website](#)) and the standard details for more information on loop detection design/installation).

6.1.2 Multiple Detection Technologies at a Single Intersection

The preference is to keep detection design, installation and maintenance as standard and simple as possible. This is best achieved with one detection technology. Use of multiple detection technologies at a single intersection is discouraged as it can be challenging to configure the hardware in the controller cabinet, resulting in non-standard arrangements that are more difficult to maintain and troubleshoot. However, there may be times where it is acceptable to have multiple technologies (e.g. using a new technology for bike and pedestrian detection). The State Traffic Signal Engineer will approve use of multiple detection technologies on a case-by-case basis.

6.2 Detection Basics

Detection allows the signal controller to service signal phases and provide variable amounts of green time based on the demand. Detection needs are determined by the desired signal operation; therefore it is important to have a basic understanding of the signal operation standards that dictate the standards for vehicle detection design.

Each signalized intersection is the result of side street (typically city or county road) intersecting with a mainline (state highway.) In the case where a state highway intersects with another state highway, one route must be designated the mainline and the other route will be the side street. This is usually easy to determine based on traffic volumes, posted speeds and the presence of stop/yield control at the intersection prior to signalization. There cannot be two mainlines or two side streets, there must be one of each designated for each intersection. This fundamental principle results in signal operations that will meet driver expectation; drivers **do not** expect to stop on a mainline roadway and **do** expect to stop on a side street. This designation is shown in the operational approval based on how the phases are labeled (phases 2 and 6 are mainline through phases and phases 4 and 8 are side street through phases.)

6.2.1 Presence Detection

Presence detection is used for each vehicle lane (except mainline right turn only lanes that do not have an overlap phase) and each bicycle lane. The length of the presence detection and its use varies slightly depending on the lane use and phasing (See Figure 6-2 for the standard presence zone layout):

- When used on side streets (phases 3, 4, 7, and 8) and mainline left turn phases (phases 1 and 5), it is placed at the stop bar, covers a total of approximately 75 feet. It is designed to place a call into the signal controller when a vehicle approaches on a red indication and to extend the green time based on vehicle demand of queued vehicles proceeding on a green indication. Side street phases and left turn phases are **not** recalled like the mainline through phases, and therefore will not turn green unless there is vehicle demand.
- When used for mainline through phases (phases 2 and 6), it is placed at the stop bar, covers approximately 20 feet and is designed to provide additional data needed for automated traffic signal performance measures.
- When used for a bicycle lane, it is placed at the stop bar, covers approximately 50 feet. It is designed to place a call into the signal controller when a bike approaches on a red indication (for bike lanes on the side street) and extend the green time based on the slower traveling speed of a cyclist approaching on a green indication (for bike lanes on the side street and mainline.)

Count zones and yellow-red zones (data needed for automated traffic signal performance measures) as shown in Figure 6-2 are also provided by the near range detector unit.

Figure 6-2 | Detection Basics – Presence Detection For all Vehicle and Bike Lanes (including Count and Yellow-Red detection) Standard Layout

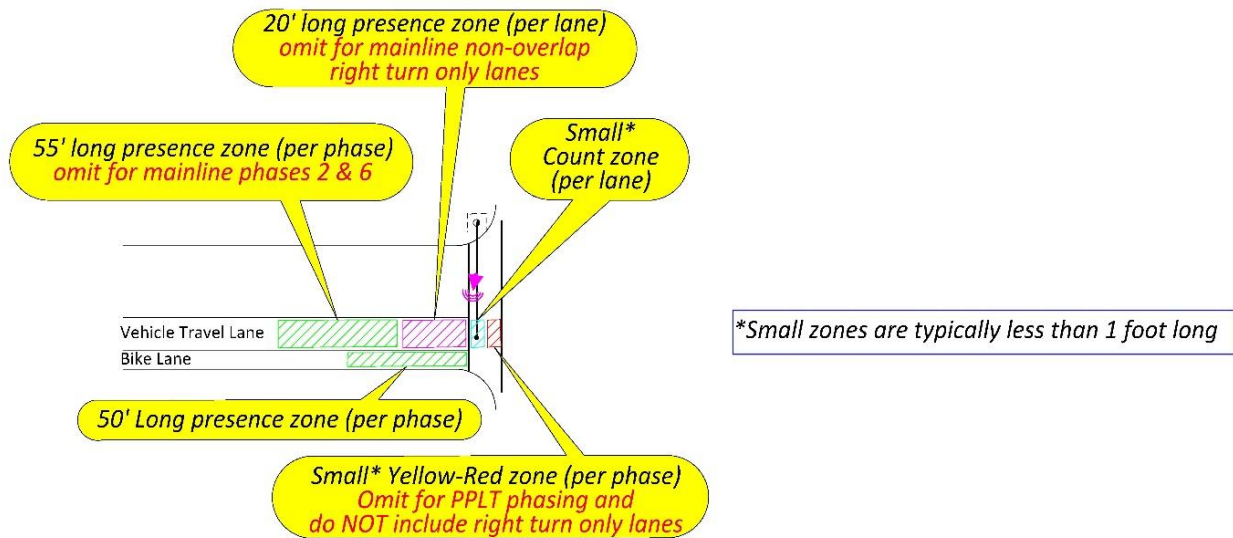

STANDARD PRESENCE DETECTION (Near-Range Unit)

6.2.2 Advance Detection (or Volume Density Detection)

Advance detection is used for the mainline through phases (phases 2 and 6) and interchange off-ramps. See Figure 6-3 for the standard advance detection zone layout. It can detect vehicles approximately 900 feet away from the stop bar. Only 460 feet from stop bar is required to adequately detect vehicles up to 55 mph. However, detecting vehicles approximately 900 feet from the stop bar may be desirable for approaches with high speed and high semi-truck volumes. Advance count zones as shown in Figure 6-3 are also provided by the far range detector unit. See section 6.8 for more information.

Advanced detection is designed to extend green time and protect the dilemma zone for a vehicle approaching the intersection (where a vehicle is too close to properly stop at the intersection and too far away to properly get through the intersection before the yellow terminates.) Each vehicle actuation during the mainline green phase will extend the green time such that the vehicle may continue through the intersection without stopping. Radar detection provides great flexibility for detecting vehicles within the range/view of the device and is also capable of using algorithms to better protect the dilemma zone, even for vehicles that are accelerating or decelerating when approaching the traffic signal.

While advance detection can put a call into the controller when the vehicle approaches on a red indication, the call function is fulfilled primarily by presence detection instead. Additionally, the standard for signal timing is to always recall the mainline through phases, which makes the call feature unnecessary for these phases (e.g. a vehicle actuation is **not** required to bring up the mainline through phases.) When only the mainline phases are recalled, the signal will “rest” in green on the mainline when there are no vehicle actuations.

Figure 6-3 | Detection Basics – Advance Detection Standard Layout

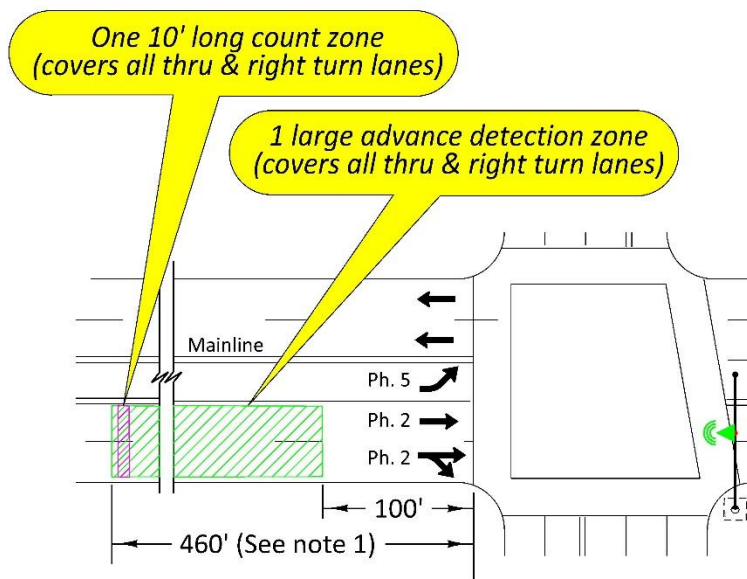

STANDARD ADVANCE DETECTION (Far-Range Unit)

Notes:

1. Detection that starts 100' from the stop bar and extends a minimum of 460' from the stop bar is acceptable for posted speeds of 55 mph and lower. However, the far-range unit on the green sheets is capable of reaching 900'.
2. If MaxAdapt is used (Verify with Region Traffic), add a Near-Range Unit to provide advance Count Detection Zones as shown in Figure 6-5.

6.2.3 Signal Timing Functions That May Be Used With Detection

The following functions are used by the signal timer to make the traffic signal operate efficiently and collect data:

- **Extend/Carryover/Stretch** – this function is only active during the green phase of the associated signal phase. It allows the green time to be extended based on the parameters within the signal timing. It also allows the input of a detector to remain “on” for a pre-defined amount of time after the actual vehicle actuation has turned off, effectively elongating the size of the detection zone.
- **Call** – this function is only active during the red phase of the associated signal phase. It allows the signal controller to service the associated signal phase within the parameters of the normal phase rotation; signal phases other than the mainline through phase are only serviced if there is demand.
- **Delay** – this function is only active during the red phase of the associated signal phase. It allows the input of a detector to remain “off” for a pre-defined amount of time during the actual vehicle actuation, reducing the chance of unnecessarily serving a phase from unintended actuations (e.g. vehicles turning right on red.)
- **Count** – this function simply counts the number of actuations. The ability to count actuations provides critical volume data to the signal timer developing the appropriate signal timing parameters throughout the life of the traffic signal. Count detection is also needed for certain automatic traffic signal performance measures.

6.3 Beyond Basic Detection

Depending on the location, desired signal operation and other unique circumstances at the intersection, you may need to consider additional detection beyond the basics.

6.3.1 Interchange Ramps

For interchange ramps, the detection is treated similar to the detection for a side street phase (see Section 6.2.1.) The only exception is advance detection, which is also used (see Section 6.2.2) based on the higher prevailing speed of a vehicle that has just exited the freeway.

In addition to standard presence and advance detection, “dump” detection may also be desired. Dump detection may be necessary for an interchange ramp to prevent ramp queues from backing up onto the freeway by allowing the signal controller to give priority and extended green time to the ramp phase if the queue reaches a certain point for a certain period of time. Downstream “flushing” of queued vehicles may also need to occur to prevent spillback onto the freeway mainline. Dump detection may be used if engineering judgment determines a need. Verify dump detection needs with the region signal operations engineer.

It is always preferable to have the ramp alignment be designed to accommodate the calculated design life 95 percentile queue length, which would eliminate the need for dump detection. However, this is not always feasible. An operational analysis is always required to determine if dump detection is needed and to determine the optimal placement of the detection. This will likely require a stand-alone near-range detector unit mounted on vehicle pedestal within 20 feet of the where the detection zones are needed.

6.3.2 Temporary Bridge Signals (one-lane, two-direction)

Temporary bridge signals are used to allow travel in both directions in one lane. Presence detection is used as shown in Figure 6-4.

Figure 6-4 | Temporary Bridge Signal Presence Detection

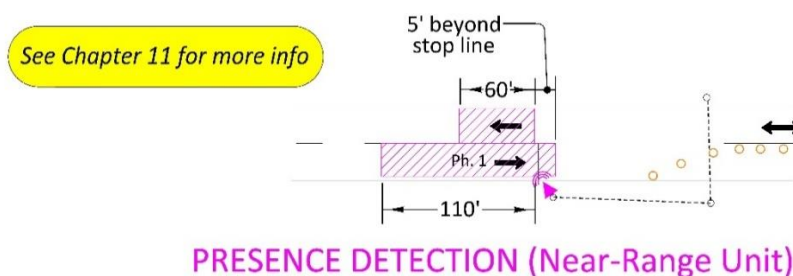

6.3.3 Bicycle Detection

Bicycle detection should be installed where bike lanes are present. See Section 6.2.1. If no bike lanes are present, but there is a high volume of bike riders, you may use bike detection on the shoulder or other locations if engineering judgment determines a need.

Bicycle detection should also be used in bike boxes when the signal phases are not recalled.

Note that properly detecting bicycles is challenging for most forms of detection due to bike material composition (problematic for loops), detecting the difference between vehicles and bikes (problematic for radar), and paths that cyclists choose take (problematic for all forms of detection.)

Fortunately, non-invasive detection technology is improving rapidly and is getting much better at distinguishing bikes from other vehicles (even traveling in the same lane). Verify bike detection needs with the region signal operations engineer and available technologies with the State Traffic Signal Engineer.

6.3.4 Adaptive Signal Timing Detection

Adaptive signal timing detection works much differently than the standard detection discussed in Section 6.2. Typically more detection is needed for adaptive to work properly, as the adaptive software collects more data to use in determining how to operate the signal. When designing a detection system that will be using adaptive signal timing, it is important to follow the software manufacturer’s recommendations for detection placement.

In addition to the standard advance detection shown in Figure 6-3, count detection placed beyond the anticipated queue (in free-flow traffic) as shown in Figure 6-5 may be recommended for optimal performance when using MaxAdapt adaptive signal timing. Work with Region Traffic to determine the site specific detection needs.

Figure 6-5 | MaxAdapt Advance Count Zone Layout for Radar Detection

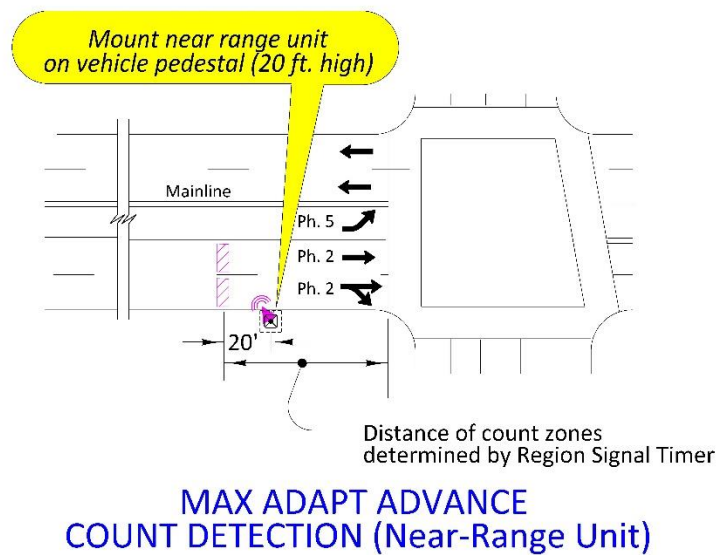

Region traffic engineer approval is required for use of adaptive signal timing.

6.3.5 Railroad Detection

Depending on the location of the railroad crossing, the intended signal operation and rail crossing order requirements, additional vehicle detection zones may be necessary for proper detection. See Chapter 16 for more information on railroad related signal design.

6.3.6 Automated Traffic Signal Performance Measures (ATSPM)

ODOT has committed to implementing ATSPMs as part of FHWA’s Every Day Counts 4 initiative. Certain detection zones are included solely for ATSPM data collection which can be used to track performance measures at signalized intersections and assess impacts of timing and operation decisions in real time. The presence detection and advance detection standard shown in Figure 6-2 and Figure 6-3 will be able to capture the following ATSPM (See Traffic Signal Management Plan for more information):

- Red light running (Safety.)
- Split failure (Safety and Operations.)
- Purdue Coordination (Operations.)
- Arrival on red/green (Safety and Operations.)

6.4 Detection Zone Layout Considerations

Standard detection zone layout is shown Figure 6-2 and Figure 6-3. These zones should be used as an initial starting point when deciding where to mount the detector units, but keep in mind that site specifics may require the signal timer to make some adjustments to the zones, mounting location, or signal timing parameters in order to operate as intended (see Section 6.4 for more info on modifying placement of detection.) Always discuss any site specific considerations with the Region Signal Timing Staff to ensure the concern can be properly addressed. Also keep in mind that sometimes the occurrence of the event in question may not happen frequently enough to warrant any signal timing or detection coverage area modification.

6.4.1 Advance Stop Bars

If a crosswalk is present, the near side of the crosswalk bar functions as the stop line for vehicles. Separate advance stop bars prior to a crosswalk are only used when the geometry of the intersection cannot accommodate the design vehicle’s turning path without them. Advance stop bars also require Region Traffic Engineer approval. With that said, advance stop bars should not be used in lieu of proper geometric design; the roadway should be designed to accommodate the design vehicle without use of advance stop bars whenever feasible. If an advance stop bar is used, detection is not typically needed between the advance stop bar and the crosswalk marking, but it can be used if engineering judgement determines a need.

6.4.2 Bridge Decks

There are only two types of detection that can be used on a bridge deck:

- Non-invasive (e.g. video, radar, etc.) is the default standard. This type of detection is the only viable solution for existing bridge decks.

- Preformed loops, which are installed on top of the bridge rebar prior to the deck pour. This type of detection should be avoided if possible. If used, the signal designer will need to coordinate with the bridge designer. See Standard Detail DET 4435.

6.4.3 Wide Corner Radius

An intersection with wide radii (typically rural locations that do not have a bike lane), may need a larger detection coverage area to properly accommodate vehicles and bikes. For non-invasive detection, this is very easy to implement if the device is mounted and aimed to cover the radius.

Figure 6-6 | Detection Placement Considerations: Wide Radius

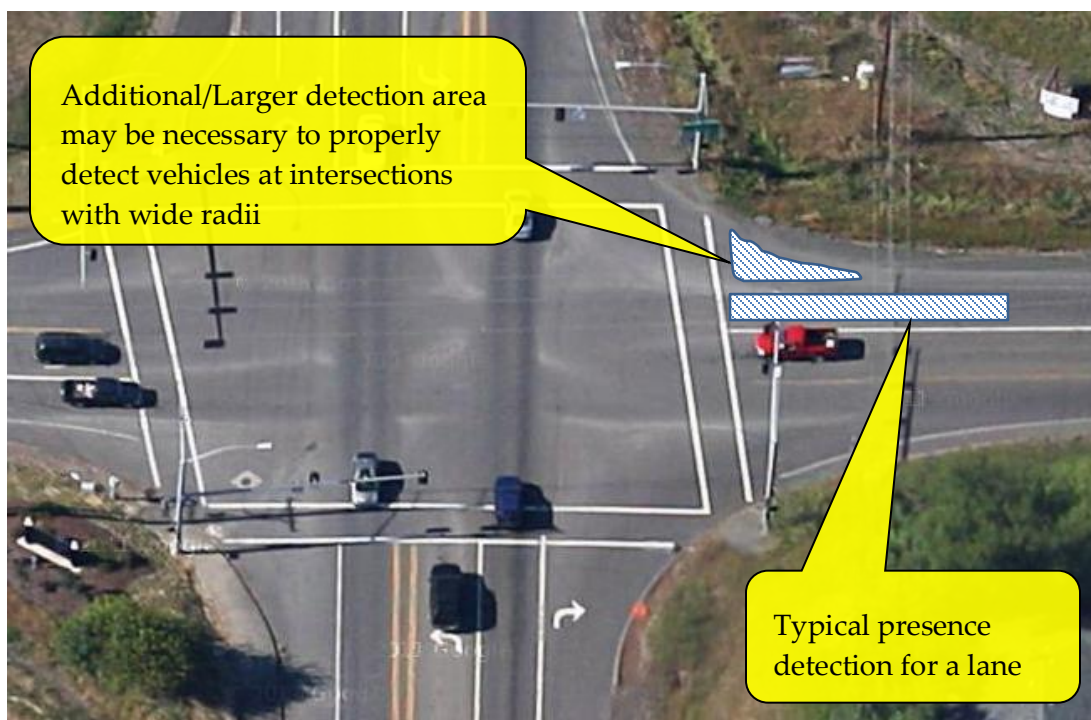

6.4.4 Accesses: Driveways, Streets, and Alleys

Vehicles accessing driveways, streets or alleys near signal detection may result in unintentional actuations that adversely affect the efficiency of the intended signal operation. This can lead to motorist frustration, longer queue lengths and more traffic congestion. One of the best solutions to improve signal operations and overall safety is to remove or restrict certain movements of any access that is within the influence area of the signalized intersection. Coordinate with the appropriate region traffic and access management staff to discuss the

possibility of removal or restriction of movements. If removal or restriction is not an option, the following alternative option should be considered for mainline advance detection.

Note: Unintentional actuations are less of a problem for non-invasive forms detection as the detection zones can be configured for a specific direction of traffic (e.g. they will not activate if a vehicle drives over the zone the wrong way). Loop detection cannot distinguish direction of travel and therefore has more potential for unintentional actuations.

The mainline advance detection is located within the travel path of vehicles turning right onto the adjacent side street. See Figure 6-7. The main concern is that these right turning vehicles will unnecessarily extend the green phase on the mainline. In this case, the advance detection could be adjusted slightly closer to the stop bar so that the detection is located outside the travel path of those right turning vehicles (approx. 30 feet or less.) Note: this may still be an issue for non-invasive forms of detection as the directionally programmed detection zones will not solve this type of unintended actuation.

Figure 6-7 | Detection Placement Considerations: Right Turns Impacting Mainline Detection

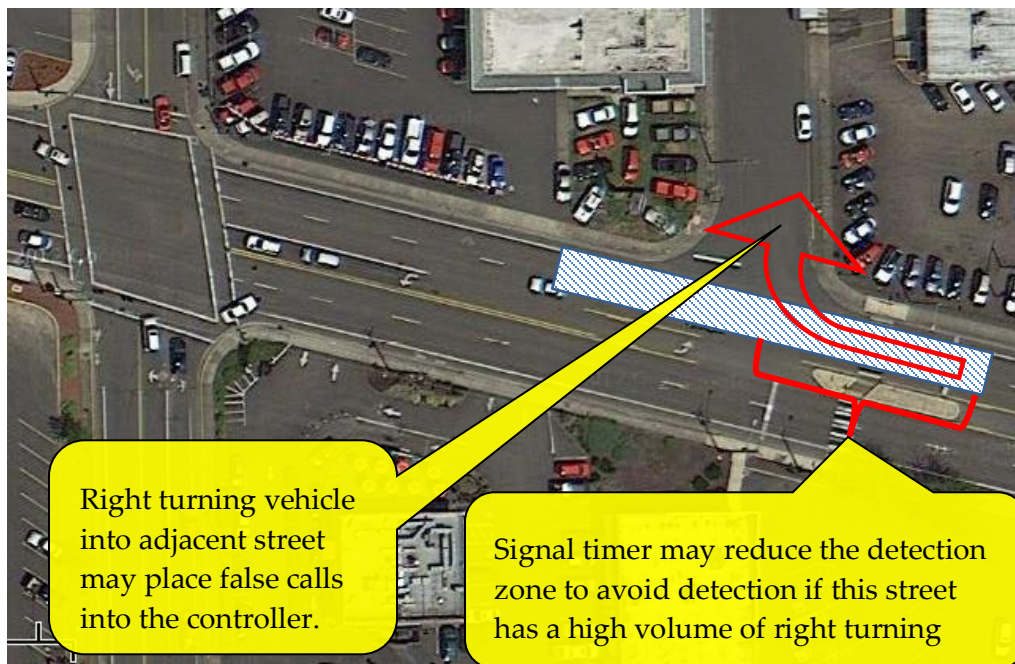

6.4.5 Short Minor Street/Driveway Signalized Approaches

The standard placement for presence detection covers approximately 75 feet. However, if the minor phase approach is short in distance (e.g. to a driveway) or the pavement doesn't extend very far past the radius, the signal timer will shorten the actual detection zone to reasonable distance based on site conditions. See Figure 6-8. If the signalized driveway approach is for a private residence (e.g. the general public will not use it), pushbutton detection should be used as it is more predictable, reliable, and cost effective. See Figure 6-9 for example.

Figure 6-8 | Detection Placement Considerations: Short Minor Street/Driveway Signalized Approaches

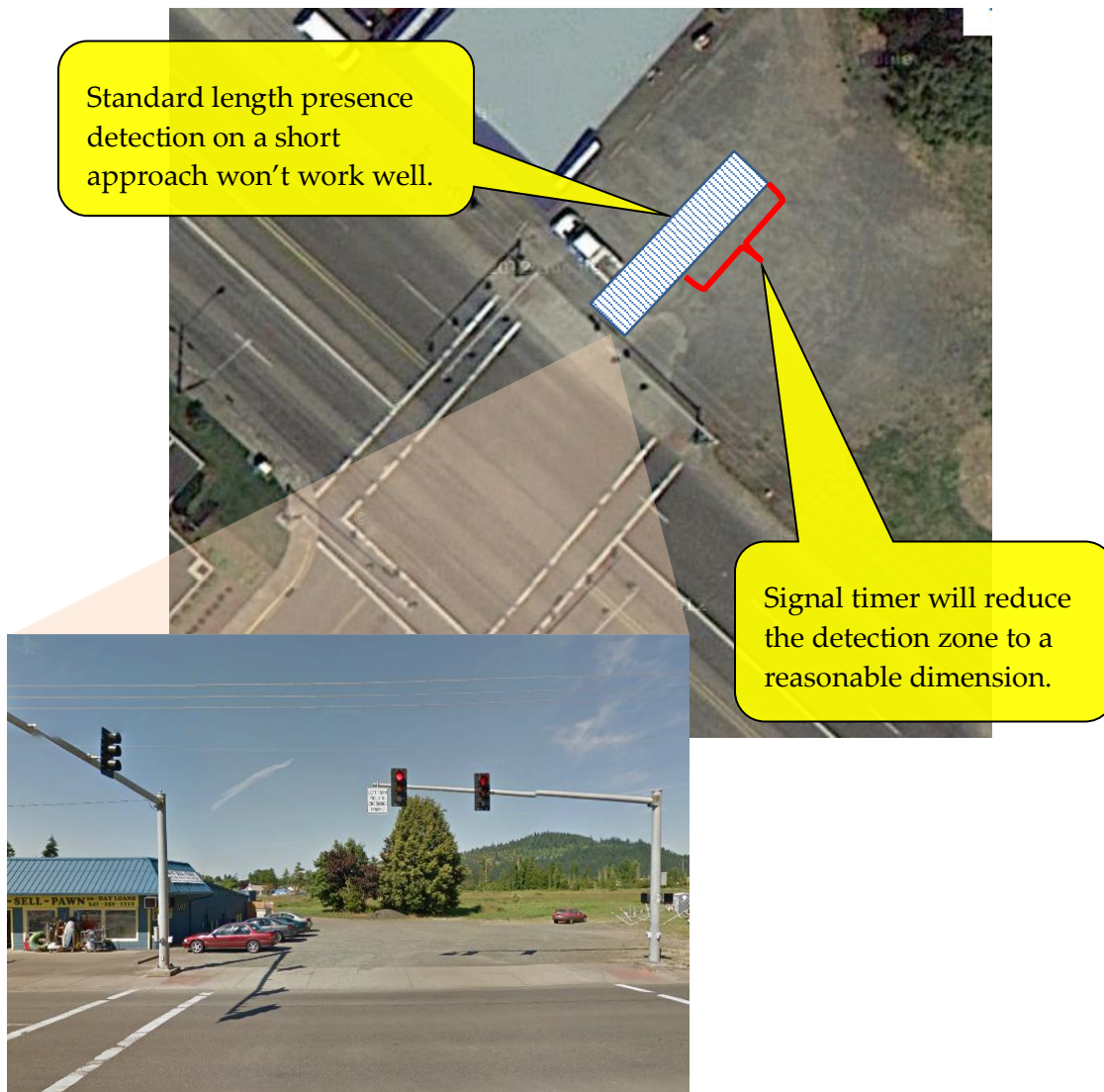

Figure 6-9 | Detection Placement Considerations: Private Driveway Signalized Approaches



6.5 Conduit and Junction Box System

Detection equipment wiring should be placed in a conduit exclusively used for detection. The conduit system for detection equipment is separate from the signal conduit system, but it follows the same route (in the same trench) and size requirements as the signal system conduit to each pole where radar/video units are mounted. The junction boxes placed in each quadrant for signal system conduits should be used for the detection system conduit. See Figure 6-10 and Chapter 5 for additional information on conduit and junction boxes.

If detector units are mounted at locations other than the signal poles, extend conduit and place a JB/2 size junction box next to the pole/pedestal it is mounted on. See Figure 6-10.

In retro-fit situations, the radar/video detection wiring may be contained within the same conduit as the signal system if the maximum wire fill rate (See Chapter 5) is not exceeded.

Figure 6-10 | Radar/Video Detection Conduit and Junction Box System

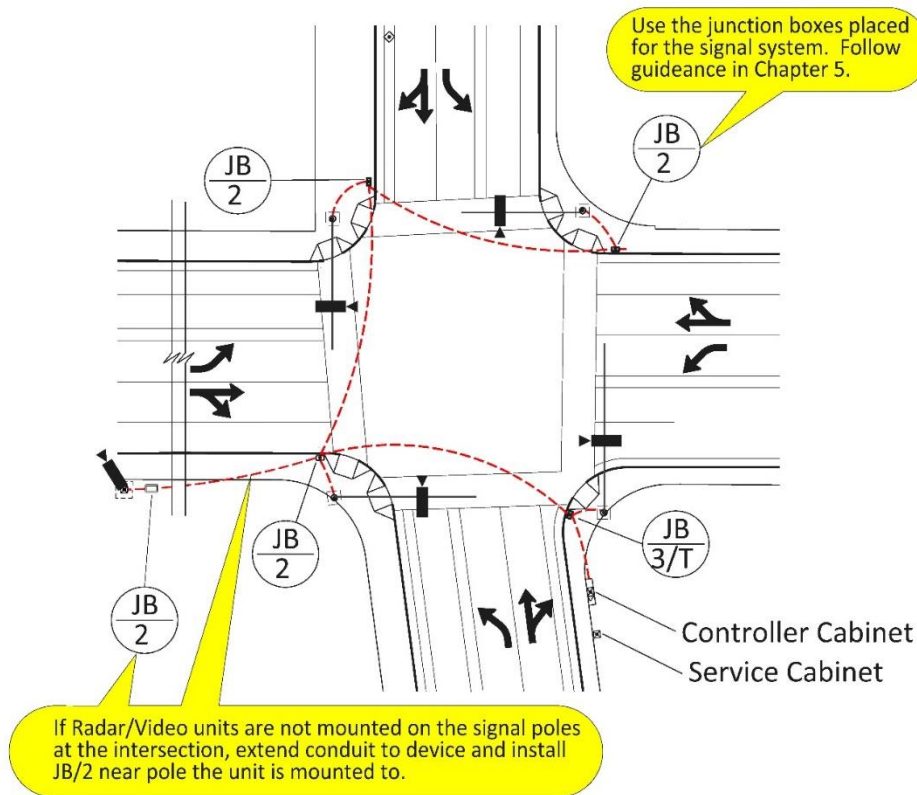

6.6 Synchronous Data Link Control (SDLC) – Bypassing the Detection Input File

SDLC is a serial communications standard for transmitting data and is the new standard for wiring radar and video hardware in the controller cabinet. It is used to pass information directly between the controller and radar/video interface devices. An SDLC cable plugs into the controller and into the radar/video interface device. This communication bypasses the input file and the C1 and C11S controller connectors. See Figure 6-11.

SDLC cannot be used with the 2070 and Voyage as the software is unfinished for SDLC communication.

SDLC cannot be used for loop detection.

Existing controller cabinets should update the controller cabinet equipment (An ATC controller and radar/video interface devices) to accommodate the SDLC connection if possible.

Figure 6-11 | Signal Controller Cabinet Detection with SDLC

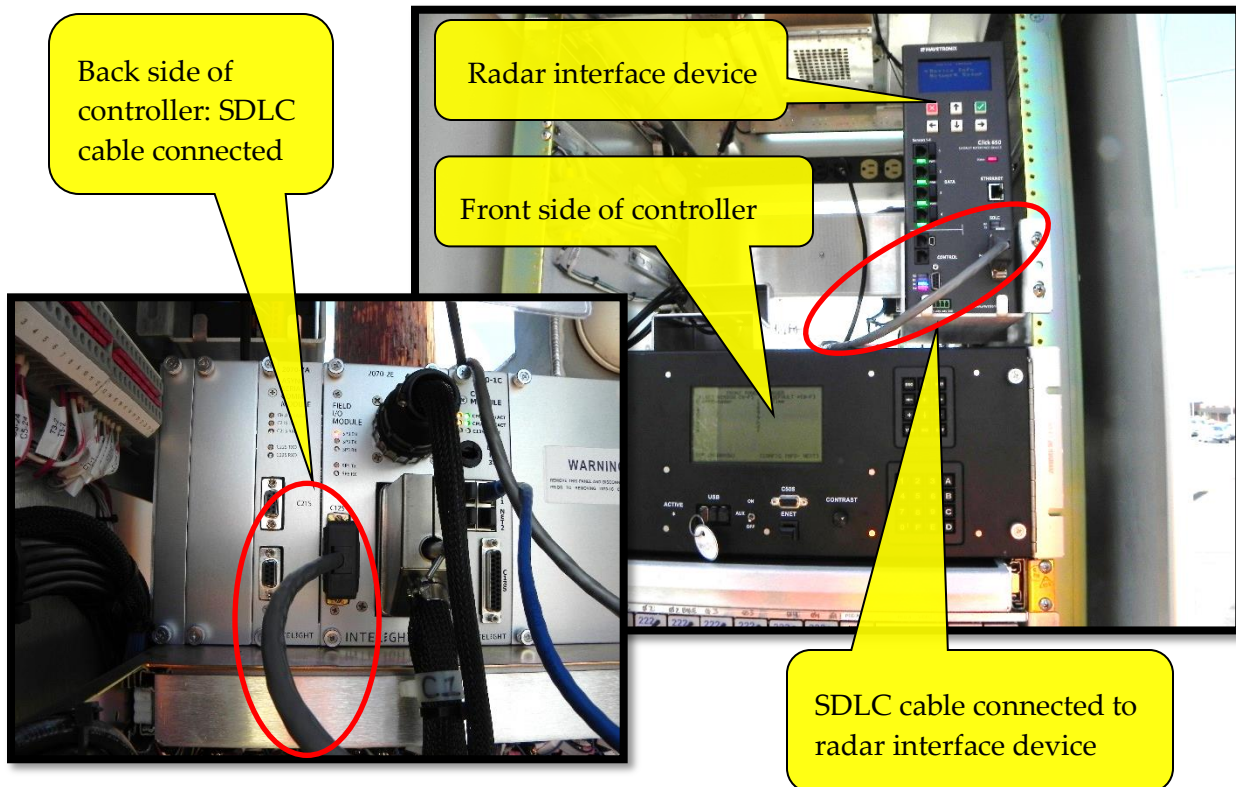

6.7 Detection Input File

The signal timer is responsible for configuring the detection input file and this information is now only shown in the cabinet prints. Detector input files and information associated with input file terminations are no longer shown on the contract plan sheets. See Chapter 20 for more information about coordinating with the signal timer and creating the cabinet print.

Figure 6-12 | 332 Signal Controller Cabinet Detection Input File Location

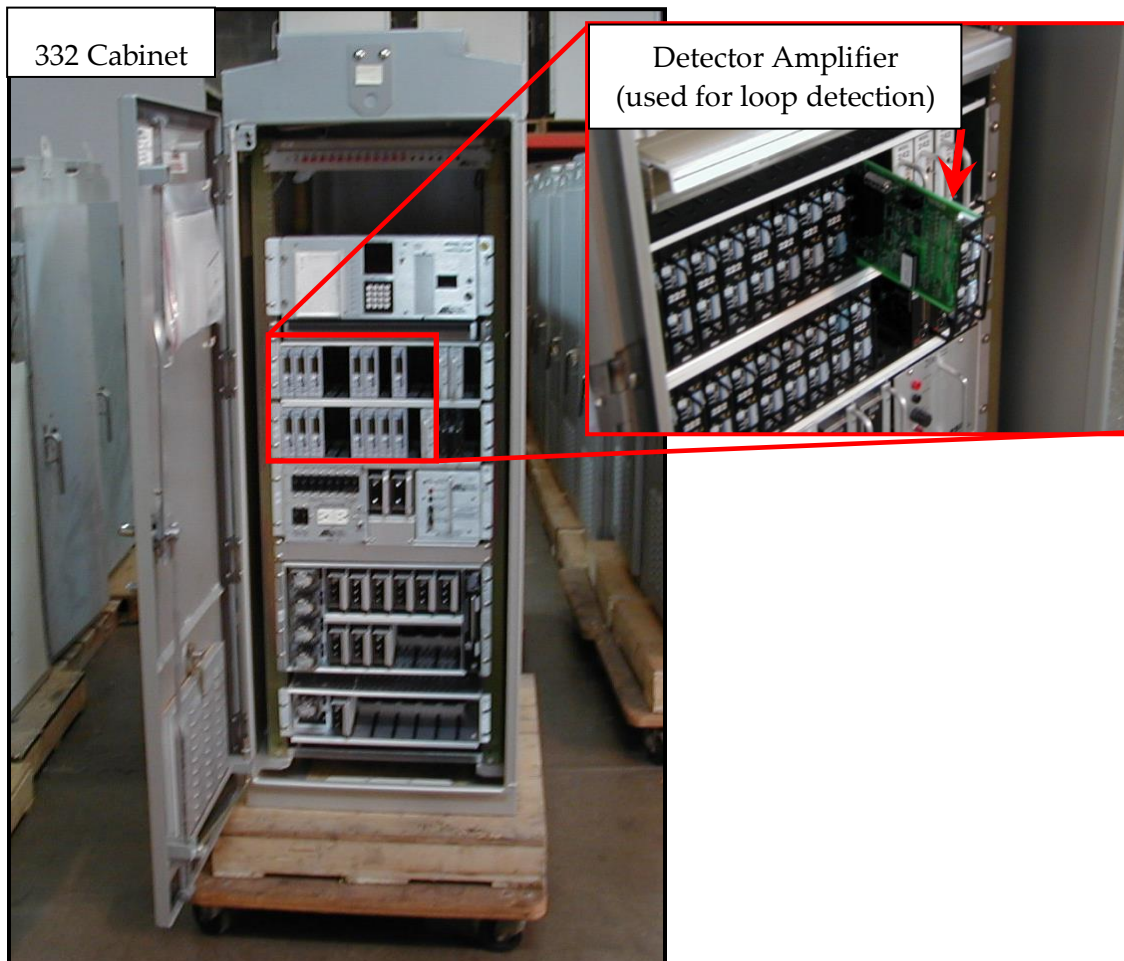

6.8 Radar Detector Unit Placement and Labeling

The type of radar unit and the detection zone area will determine the best mounting location for the unit. A field visit is highly recommended to confirm that the intended placement of the detector unit will not have any obstacles in the way that may cause dead spots in the detection zones (such as vegetation, trees, other signal heads, etc.) A few general rules of thumb for the three different types of radar units:

- **Near-range radar units**

Near-range radar units are typically used for presence detection, it has an arc shaped detection area that extends 140' from the device. This can provide detection inputs for multiple phases and can separate detection inputs for adjacent lanes/phases. Make sure that this arc shaped detection covers the basic zones of detection shown in Figure 6-2.

Near-range radar units are recommended for counting at low speeds (less than 35 mph); it is not as accurate at higher speeds, but still performs adequately with an accuracy around 95%. The backside of the mast arm with at least a 14 foot offset from the nearest detection zone is the recommended location, but other locations may be acceptable as per the manufacturer. See Figure 6-13.

For large intersections with high traffic volumes, bike lanes or other vehicle lanes may be occluded by large vehicles in adjacent lanes. Detection is critical on the side street, left turn phases, or when a bike phase is provided (e.g. any phase that does not operate as a recalled phase needs detection to bring up a green indication.) In these cases, consider an additional near-range unit to provide adequate detection of all lanes. Verify detection needs with the signal timer.

Figure 6-13 | Near Range Unit Coverage Area

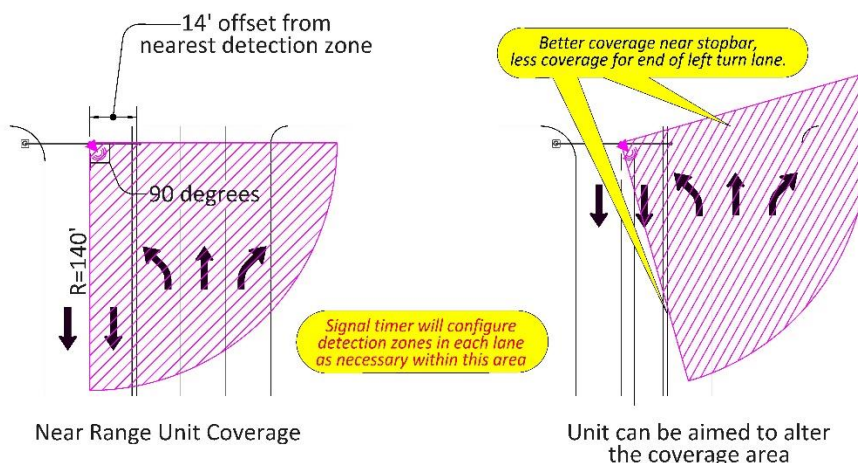

- **Far-range radar units**

Far-range radar units are typically only used for the mainline, recalled through phase, it has a long, somewhat narrow shaped detection area that extends out to 900 feet. Each unit can only be used for a single phase and it cannot provide separate detection inputs for adjacent lanes (e.g. one big zone configuration will cover *all* lanes for phase 2.) The units track vehicle speed and can calculate an estimated time of arrival to prevent vehicles from being caught in the dilemma zone. The units can also be set up to include advanced count zones in pulse mode at between 350 feet and 600 feet to collect arrival-on-green data. The advanced count zone should be placed as far back as possible to avoid queues degrading the data quality. The far side mast arm is the preferred mounting location for these units because the sensor cannot detect vehicles in the first 100 feet. The unit may also be mounted in several different locations, as per the manufacturer. See Figure 6-14.

Figure 6-14 | Far Range Unit Coverage Area

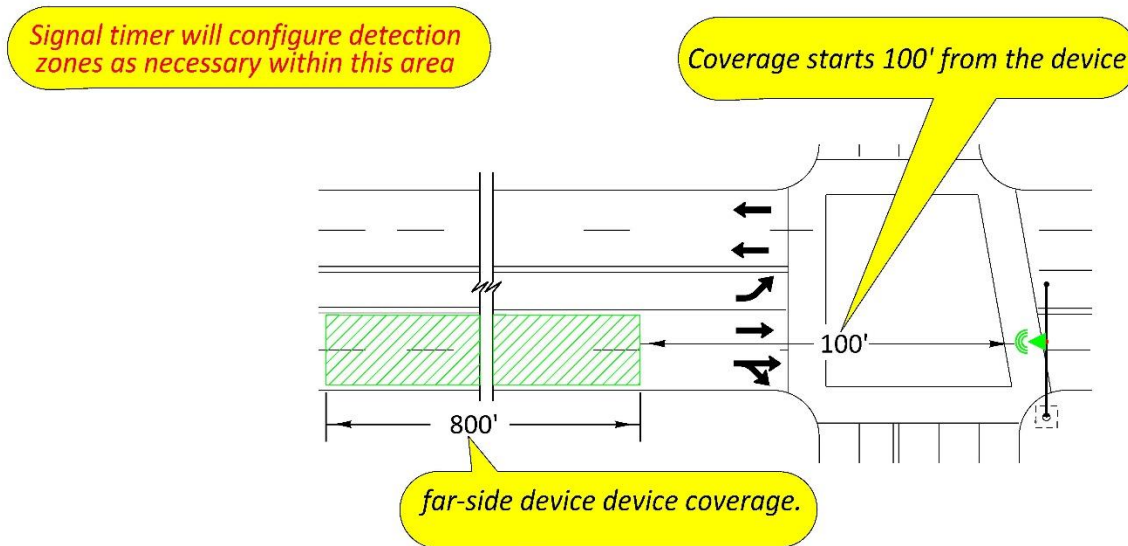

Far Range Unit Coverage Area

- **Side-fire radar units**

Side-fire radar units are typically only used for ramp meter mainline count detection (see Chapter 13 for more info). They should not be used for signalized intersections as the near-side and far-side units adequately address the detection needs. Also, these units require additional equipment in the traffic signal controller cabinet that doesn't integrate well. As such, they shall only be used if approved by the State Traffic Signal Engineer. The unit is aimed perpendicular to traffic with the detection zone spanning the entire approach. This device is accurate at counting all vehicles, even at high speeds (greater than or equal to 35 mph.) This unit should be mounted according to the manufacturer's recommendations for the offset/height requirements.

The radar units should be placed and labeled by phase as shown in Figure 6-15. If the standard placement of radar devices on the mast arm pole/mast arm is not feasible (e.g. retro-fit with conduit fill issues), will not provide the desired detection zone coverage, or there are concerns about occultation, detector units should be installed on stand-alone vehicle signal pedestals. Supplemental detector units, in addition to the detector units on the mast arm pole/mast arm, may also be considered to get the proper detection zone coverage. Work with the region signal timer during the DAP review of the detector zones on the cabinet print (See Chapter 20) to determine the proper placement and number of detector units needed.

Figure 6-15 | Standard Radar Labeling & Typical Placement

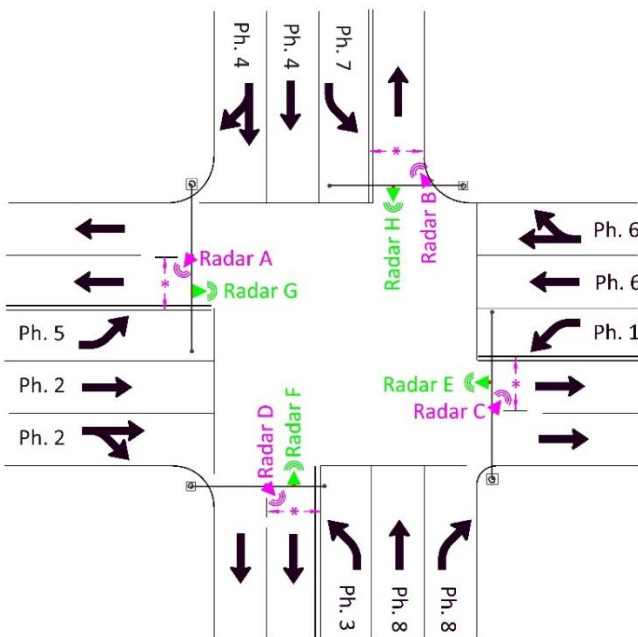

Radar Label	Phase	Radar Type
A*	2 & 5	Near/Matrix
B*	4 & 7	Near/Matrix
C*	6 & 1	Near/Matrix
D*	8 & 3	Near/Matrix
E	2	Far/Advanced
F***	4	Far/Advanced
G	6	Far/Advanced
H***	8	Far/Advanced
I Thru Z**	Misc.	Misc.

*12' device offset from lane that will have a detection zone

** If a detector does not fall into the standard label/phase shown above, then assign it a letter alphabetically between I and Z

*** Not typically installed for the side street. Verify with Region Signal Operations Engineer.

6.9 Video Detection Camera Placement and Labeling

On the mainline, one camera is used for the detection zones within 200 feet of the stop line (typically mounted on the mast arm for presence detection) and another camera is used for detection zones located more than 200 feet from the stop line (typically mounted on the luminaire arm for advance detection.)

On the side street, one camera is typically used per approach (usually only presence detection is needed on the side street.)

Cameras should be mounted on as stable a fixture as possible. Cameras should be able to view 450 feet if mounted at 45 feet. Typical mounting is on a luminaire arm or mast arm. Accurate vehicle detection is optimized by placing the camera directly over the lane(s) it will be monitoring. Otherwise, occlusion may cause false or missed calls. Each detection zone (See sections 6.2 and 6.3 for standard detection zone layout) should be adequately illuminated for detection at night.

The cameras should be placed and labeled by phase as shown in Figure 6-16.

Figure 6-16 | Standard Camera Labeling & Typical Placement

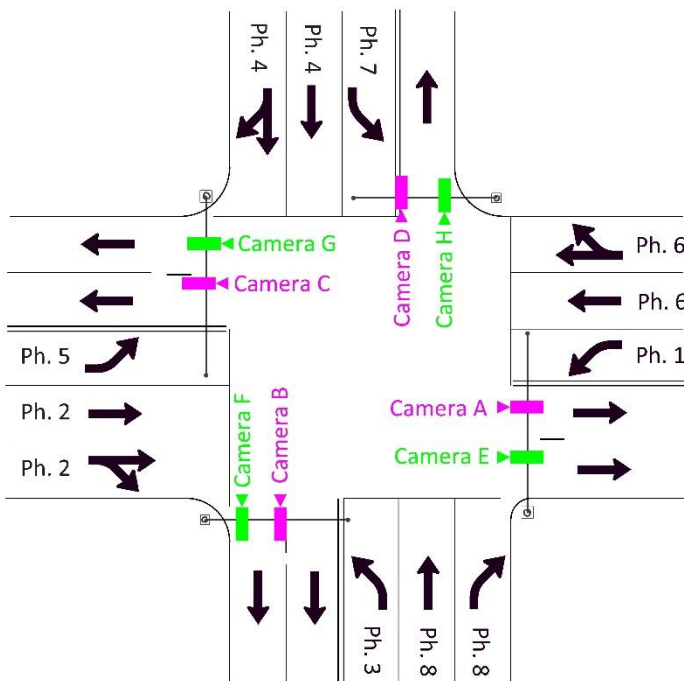

Camera Label	Phase	Typ. Mount Location
A	2 & 5	mast arm
B	4 & 7	Luminaire arm or mast arm
C	6 & 1	mast arm
D	8 & 3	Luminaire arm or mast arm
E	2	Luminaire Arm
F***	4	Luminaire Arm
G	6	Luminaire Arm
H***	8	Luminaire Arm
I Thru Z**	Misc.	Misc.

** If a detector does not fall into the standard label/phase shown above, then assign it a letter alphabetically between I and Z

*** Not typically installed for the side street. Verify with Region Signal Operations Engineer.