



**An Roinn Iompair,
Turasóireachta agus Spóirt**
Department of Transport,
Tourism and Sport

ROAD MARKINGS

CHAPTER 7
August 2019

Traffic Signs Manual

Chapter 7 – Road Markings

Contents

	<u>Page</u>
7.1 Introduction	6
General.....	6
The Function Of Road Markings	6
Classes Of Marking	7
Speed	8
Legal.....	8
Materials	8
7.2 Transverse Markings	9
Stop Line (RRM 017).....	9
Tram Stop Line (RRM 031)	11
Yield Line (RRM 018).....	11
No Entry Line (RRM 019).....	12
7.3 Longitudinal Markings	15
Centre Line Markings	15
Climbing / Overtaking Lanes	23
Right-Turn Lanes.....	25
Passing Lanes On Type 3 Dual Carriageways	25
Lane Lines (RRM 003)	26
Merge/Diverge Lane Line (RRM 028)	27
Edge Of Carriageway Lines (RRM 025, RRM 026 & RRM 027).....	27
Raised Profile Edge Markings.....	29
7.4 Hatched Markings	33
Motorways And High-Quality Dual Carriageways	34
Other Roads	36
7.5 Worded And Diagrammatic Markings	41
Stop (M 114).....	41
Triangular Yield Marking (M 115).....	41
Slow (M 106)	42
Look Left/Right (M 107I/R)	42
Arrows	43

Lane Destination Markings (M 105)	47
School Keep Clear Marking (RRM 010).....	49
School Warden Crossing Patrol Point (M 121)	50
Speed Markings (M 108)	51
Emergency Telephone And Chainage Markings (M 120)	52
7.6 Parking Restrictions And Parking Bays	53
Parking Restrictions	53
Parking Bays	54
Taxi Stand (RRM 029).....	56
Loading Bay (RRM 009).....	57
Electric Vehicle Recharging Bay (RRM 034)	57
7.7 Bus And Tram Markings.....	58
Bus Stop (RRM 030)	58
Bus Lanes	60
Tram Lanes	65
7.8 Cycle Tracks	67
With-Flow Cycle Tracks.....	67
Contra-Flow Cycle Tracks.....	69
Cycle Tracks Not On The Carriageway.....	69
7.9 Yellow Box Markings	71
7.10 Reflecting Road Studs.....	73
7.11 Priority Junctions.....	76
Ghost Island Junctions	80
Right-Turn Junctions On Dual Carriageways.....	80
7.12 Signal Controlled Junctions	84
7.13 Roundabouts	86
Normal Roundabouts	86
Mini-Roundabouts (RRM 033)	91
7.14 Grade-Separated Junctions	93
7.15 Level Crossings.....	94

7.16 Pedestrian Crossings	96
Zebra Crossing (RPC 001).....	96
Signalised Pedestrian Crossing	97
Zig-Zag Markings (RPC 002)	98
7.17 Traffic Calming	102
7.18 Yellow Bar Markings	103
Appendix 7a: Lettering For Worded Markings	106
Appendix 7b: Airport, Ferry And Disabled Persons Symbols	112
Appendix 7c: Schedule Of Road Markings	113

7.1 Introduction

GENERAL

- 7.1.1 This Chapter provides details of the road markings which may be used on roads in Ireland, including their layout and symbols, the circumstances in which each marking may be used and guidance on positioning them. The chapter should be read in conjunction with other relevant chapters. Further information on the use of the Manual is given in Chapter 1.
- 7.1.2 For the purposes of this Manual:
- **Shall** or **must** indicates that a particular requirement is mandatory;
 - **Should** indicates a recommendation; and
 - **May** indicates an option.
- 7.1.3 The diagrams for each marking indicate any variants which are permitted. The standard dimensions for markings are given on the diagrams or in the relevant tables in this chapter.
- 7.1.4 Most road markings are regulatory markings which are referred to in the relevant legislation (see Chapter 1). Regulatory road markings have numbers which are prefaced by RRM and RPC. Markings which are non-regulatory have numbers prefaced by the letter M. Where variations are allowed (such as in the case of centre line markings) suffix codes have been provided to assist designers and contractors to identify the variants. It should be noted that the suffixes do not form part of the legal descriptions of the markings.
- 7.1.5 It should be noted that markings conforming to the previous designs will continue to have legal effect. However, all new or reapplied markings should conform to the new designs.
- 7.1.6 Certain regulatory markings (such as Stop and Yield Lines and those relating to parking restrictions) are associated with regulatory signs. The latter are described in Chapter 5.

THE FUNCTION OF ROAD MARKINGS

- 7.1.7 Road markings may be defined as markings on the surface of the road for the control, warning, guidance or information of road users. They may be used to supplement upright signs, or they may be used alone.

7.1.8 Road markings have the limitation that they may be obscured by snow, leaves or debris on the carriageway. Their conspicuity is impaired when wet or dirty and their durability depends largely on their exposure to traffic wear. Nevertheless, they serve a very important function in conveying information and requirements to drivers which might not otherwise be possible by the use of upright signs. They have the advantage that they can often be seen when an upright sign is obscured, and, unlike such signs, they can provide a continuing message to the moving driver and, as such, worded markings must be laid as words would typically be read, i.e. from top to bottom.

For example;

STAY IN LANE would be laid on the carriageway as follows;

STAY		LANE
IN	and not as	IN
LANE		STAY

7.1.9 The continued increase in the volume of traffic using the roads makes the extensive use of road markings essential to ensure that full advantage is taken of the available road space. In particular, widespread use of lane markings is desirable. Enhancing lane discipline adds to the safety of traffic, besides improving traffic flows.

7.1.10 Road markings should be considered in detail at design stage in respect of new or improved roads and junctions. The markings for existing roads are best considered on plan before the work is undertaken.

CLASSES OF MARKING

7.1.11 Road markings may be classified as follows:

- Transverse markings, which are at right-angles (or thereabouts) to the centre line of the carriageway;
- Longitudinal markings (including double line systems);
- Hatched markings;
- Worded and diagrammatic markings;
- Markings indicating parking and loading requirements;
- Bus and tram markings;
- Cycle track markings;
- Yellow box markings; and
- Road studs.

7.1.12 The various classifications are covered in this chapter in the above order in Sections 7.2 to 7.10. Sections 7.11 to 7.16 illustrate their application in specific circumstances. Markings used for traffic calming purposes are included in Section 7.17, and Section 7.18 describes the use of transverse yellow bar markings.

SPEED

7.1.13 Throughout this Chapter reference is made to the 'speed' of traffic, for example to determine the appropriate dimension of line marking to be used, or to define the visibility requirements for a continuous line system. Wherever 'speed' is mentioned, it shall be determined as follows:

- On new or improved roads, 'speed' is the Design Speed, calculated in accordance with Transport Infrastructure Ireland Standard DN-GEO-03031 ¹;
- In the case of existing roads, 'speed' is the speed limit, except when there is a significant difference between the speed limit and actual vehicle speeds, in which case:
- 'speed' shall be the observed 85th percentile approach speed of private cars. This is the speed which is exceeded by only 15% of cars in dry weather and may be measured by accepted speed survey methods.

LEGAL

7.1.14 Traffic signs and road markings are provided in accordance with signs regulations or directions of the Minister of Transport. They may be laid only by or on behalf of the Road Authority. Markings with the prefix RRM or RPC are regulatory road markings, and attention is drawn to the statutory requirement for the Road Authority to consult with the Commissioner or appropriate delegated officer in the Garda Síochána where such markings are being provided. Markings with the M prefix have no regulatory significance.

7.1.15 Some road markings indicate a legal requirement (for example the transverse Stop Line, or longitudinal parking restriction markings) and may be accompanied by regulatory signing as specified in Chapter 5.

MATERIALS

7.1.16 The specifications for road markings, including materials, equipment and methods of application, are detailed in the Transport Infrastructure Ireland publication CC-SPW-01200 *Specification for Road Works Series 1200 - Traffic Signs and Road Markings* ², to which the provision of road markings should conform.

7.1.17 The colour of road markings shall be white, unless otherwise stated in the Manual.

¹ Transport Infrastructure Ireland. *DN-GEO-03031, Road Link Design* (formerly NRA TD 9). Part of the TII Design Manual for Roads and Bridges. TII, Dublin.

² Transport Infrastructure Ireland. *CC-SPW-01200, Specification for Road Works - Series 1200 - Traffic Signs and Road Markings*. Part of the TII Specification for Road Works. TII, Dublin.

7.2 Transverse Markings

7.2.1 The prescribed transverse markings comprise:

- Stop Line;
- Tram Stop Line;
- Yield Line; and
- No Entry Line.

STOP LINE (RRM 017)

7.2.2 A 200mm wide Stop Line, RRM 017 indicates the position in advance of which a vehicle must be brought to a complete halt. At signals for level crossings or for swing or lifting bridges, the Stop Line shall be 300mm wide (see Section 7.15).



RRM 017 – Stop Line

† Note: A special width of 300mm shall be used for Stop Lines at level crossings and swing or lifting bridges.

Junction Stop Line

7.2.3 The marking consists of a single continuous line 200mm in width (RRM 017) and should be supplemented by a Stop Sign (RUS 027, see Chapter 5). Where a road joins a national road, a Stop Line and Sign should normally be used. Section 7.11 gives examples of the use of the Stop Line and associated road markings at priority junctions.

7.2.4 The edge of the Stop Line nearest to the major road should not be closer than 600mm to the line of the back of the paved area of the major road. Only in limited circumstances should it be sited elsewhere and then it must be sited so as to halt a driver where visibility is best.

7.2.5 On a two-way road the Stop Line should always be accompanied by a Continuous Centre Line, RRM 001, extending longitudinally back from the junction. In normal circumstances this should extend for 20m from the Stop Line, but this may be reduced to a minimum of 8m as site conditions require. On roads less than 5.3m width only, the centre line marking may be reduced to 2m.

7.2.6 The STOP worded marking, M 114, may be used to increase conspicuity, as described in Section 7.5. Where used it should have letters of height either 1600mm or 2800mm; the larger size is recommended for use on high-speed approaches.

Traffic Signal Stop Line

- 7.2.7 At traffic signals the Stop Line is a single continuous line 200mm in width (RRM 017). At signals for level crossings or swing or lifting bridges the line is 300mm wide.
- 7.2.8 At traffic signals, including pedestrian signals, the Stop Line is normally located 1m to 2m before the nearside primary signal, but site conditions may necessitate variations to this distance. Section 7.12 gives examples of the use of the Stop Line at signal-controlled junctions, Section 7.15 at level crossings and Section 7.16 at pedestrian crossings. See also Chapter 9.

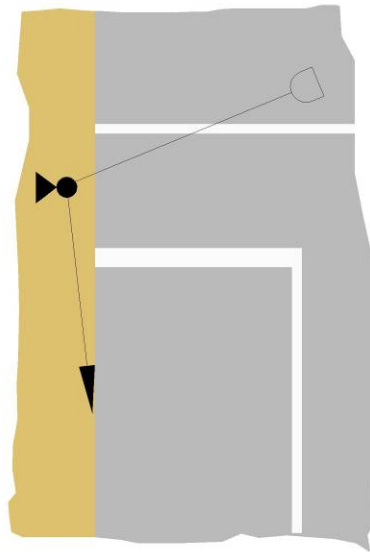

Figure 7.1: Stop Line at Signalled Controlled junction

Advance Cycle STOP Lines

- 7.2.9 Where there is a need to assist cyclists in establishing their position in advance of other traffic at a signal-controlled Stop Line (for example, to facilitate safer right-turn manoeuvres), an Advanced Stop Line may be provided. They shall not be used at level crossings or standalone signal-controlled crossings for pedestrians, cyclists or equestrians.
- 7.2.10 Vehicles other than cycles must stop at the first line when signalled to do so. A cycle track must be provided to enable cyclists to enter the reservoir lawfully: i.e. without crossing the first Stop Line. The area between stop lines across the full width of the approach is available for cyclists to wait at the red light. This area and the approach lane may be highlighted using coloured surfacing. Both Stop Lines shall be 200mm wide.
- 7.2.11 For guidance on the design and layout of cycle facilities refer to Department of Transport guidelines for cycling facilities.

TRAM STOP LINE (RRM 031)

7.2.12 The Tram Stop Line, RRM 031, indicates the point beyond which a light rail vehicle shall not proceed when stopping in compliance with the appropriate regulatory sign or traffic signal (see Chapters 5 and 9).

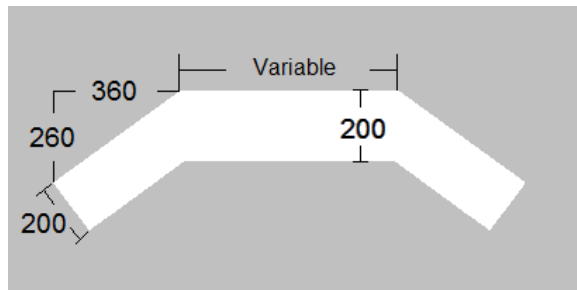

RRM 031 – Tram Stop Line

YIELD LINE (RRM 018)

7.2.13 The Yield Line marking, RRM 018, imposes a requirement on all approaching traffic to yield to conflicting traffic. The edge of the transverse line nearest to the major road should not be closer than 600mm to the line of the back of the paved area of the major road.

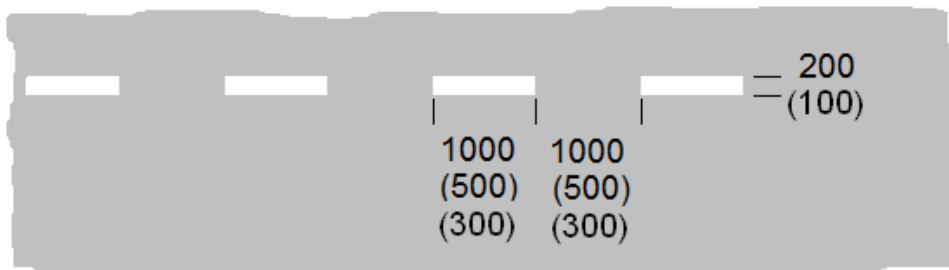

RRM 018 – YIELD Line

7.2.14 The marking generally consists of a 200mm wide broken line comprising 1000mm marks and 1000mm gaps. Where the width of the approach lane is not sufficient to display this pattern, segments of 500mm marks and 500mm gaps may be used instead. This dimension is also used at Zebra pedestrian crossings, where it forms part of marking RPC 001 (see Section 7.16). The 100mm wide, 300mm segment and gap is reserved for cycle track yield lines, where it is designated as marking RRM 018C (see Section 7.8).

7.2.15 The Yield Line should normally be supplemented by the Yield Sign (RUS 026, see Chapter 5) at priority-controlled junctions. On national roads the Yield Sign must always accompany the Yield Line. The Yield Sign is not required to accompany the Cycle Yield Line, RRM 018C.

7.2.16 On two-way roads, the marking generally extends to the centre of the carriageway of the minor road. On a one-way road it is carried

across the whole width of the minor road. The precise location of the marking nearest to the major road in relation to the edge of the major road is governed by the same considerations as pertain to the Stop Line. At junctions, the Yield Line is normally accompanied by one or more Triangular Yield Markings, M 115 (see Sections 7.5 and 7.11).

7.2.17 On two-way roads, the Yield Line should be accompanied by a Continuous Centre Line, RRM 001, extending longitudinally back from the junction for a minimum distance of 20m from the Yield Line but this may be reduced to a minimum of 8m as site conditions require. On roads less than 5.3m width only, the centre line marking may be reduced to 2m.

7.2.18 Section 7.11 gives examples of the use of the Yield Line at priority junctions.

NO ENTRY LINE (RRM 019)

7.2.19 The No Entry Line, RRM 019, indicates to drivers the point beyond which entry is prohibited. It also indicates the position at which a driver emerging from a one-way street must yield to conflicting traffic. The marking consists of one continuous line and one broken line comprising 1000mm marks and 1000mm gaps. The lines are 200mm wide and are spaced 300mm apart. It should be accompanied by No Entry and either Stop or Yield Signs. Its use is illustrated in Section 7.11.

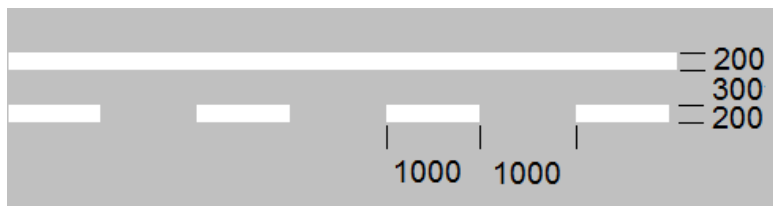

RRM 019 – No Entry Line

Priority Junctions

7.2.20 The marking shall extend across the entire width of a one-way road. The precise location of the continuous marking nearest to the major road is governed by the same considerations as the Stop Line.

7.2.21 The No Entry Line must be accompanied by the regulatory signs defined in Chapter 5: i.e. No Entry Signs (RUS 050) on both sides of a one-way road at its junction with an intersecting road and No Left Turn and No Right Turn Signs (RUS 013 and RUS 012) on the approaches to the junction on the intersecting road.

7.2.22 The No Entry Line shall not be used at locations where an exemption to the No Entry Sign exists: i.e. where the No Straight Ahead Sign (RUS 011) is used with exemption plates (see Chapter 5).

Roundabouts

- 7.2.23 The No Entry Line is also used at the entry arms of roundabouts, to indicate the location at which traffic approaching the roundabout shall yield to traffic on the circulating carriageway. This is illustrated in greater detail in Section 7.13, and in Chapter 10.
- 7.2.24 When used at roundabouts, they shall be supplemented by Yield (RUS 026) and/or Mini-roundabout (RUS 049) upright signs as described in Chapter 5, and may also be accompanied by Yield triangle markings, M 115, in each approach lane. Depending upon site conditions, No Entry signs (RUS 050) may be provided to prevent circulating traffic from turning the wrong way into an approach road.

One-Way Systems and Dual Carriageways

- 7.2.25 When the major road is one-way or a dual carriageway, Lane Indication Arrows (as described in Section 7.5) should be used on the major road instead of No Entry Lines to provide clear indications of traffic direction to traffic emerging from the minor road (see Figure 7.2). No Entry signs may still be provided as appropriate.

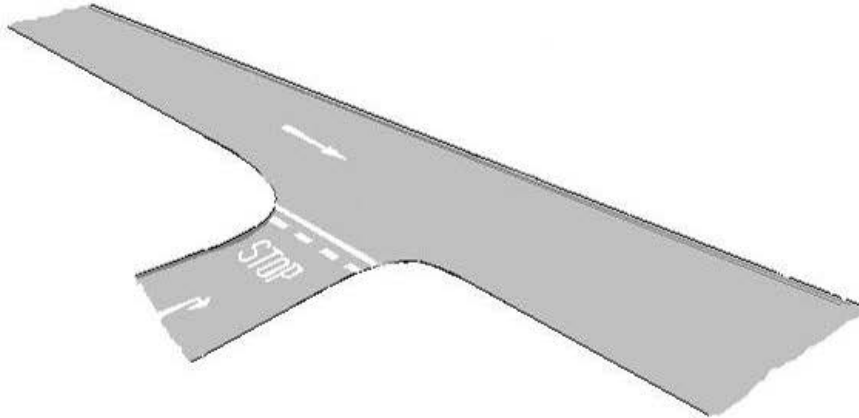

(a) Road Markings at the Junction of Two One-Way Roads

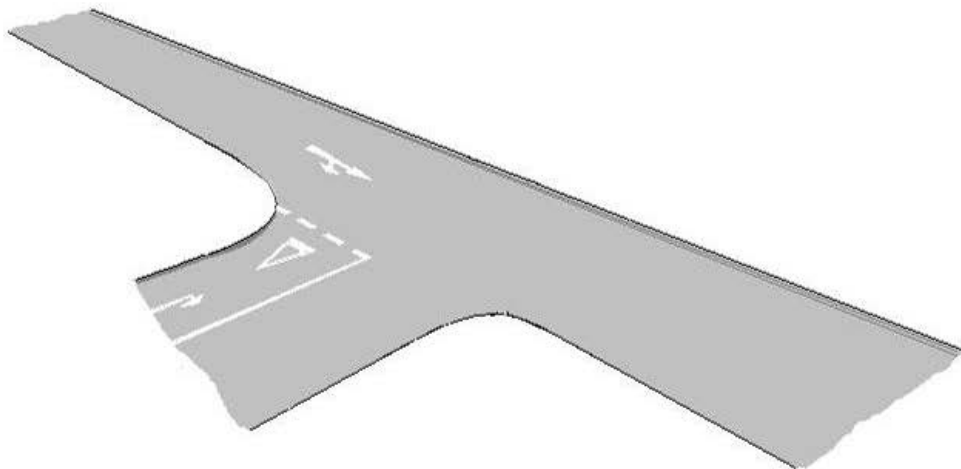

(b) Road Markings Where a Two-Way Road Meets a One-Way

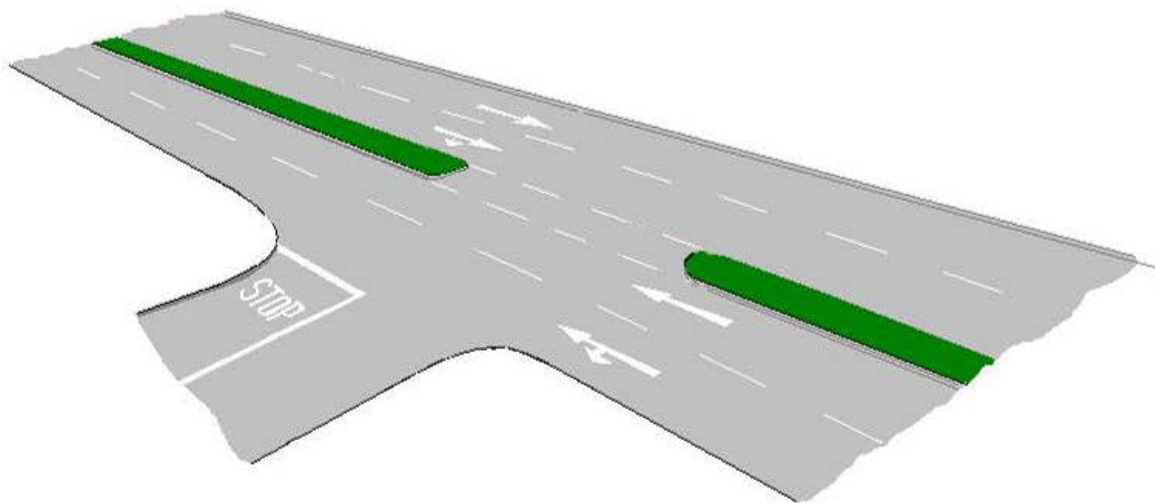

(c) Road Markings at a Junction with a Dual Carriageway

Figure 7.2: Markings at Typical Priority Junctions

Note:

See to Chapter 5 for upright sign requirements.

7.3 Longitudinal Markings

- 7.3.1 The benefits to be gained from the use of lane, centre and edge of carriageway lines in both urban and rural areas cannot be emphasised enough. By guiding and confining traffic to its correct lane, the lines have an important bearing on safety, besides ensuring that all the available carriageway space is used to its maximum capacity.
- 7.3.2 Drivers need to be able to detect guidance markings at a distance equivalent to a minimum of two seconds of travel time. If the visibility is less than this, drivers tend to adjust too late when the road changes direction. They run too close to the centre line on left hand bends, or too close to the road edge on right hand bends. The higher the prevailing traffic speed, the greater the visibility distance required to maintain this two-second 'preview' time. If it is not provided, drivers tend to miss the curve, or proceed in a series of staggers.
- 7.3.3 A variety of factors influence the visibility distance of road markings. It is increased when a line is wider, has a higher line-to-gap ratio or has a higher coefficient of retroreflective luminance. For the purpose of determining the size of marking to be used, reference should be made to the 'speed' of traffic, which should be determined as described in Section 7.1.
- 7.3.4 In general, for any given road configuration there will be alternative dimensions prescribed for centre, lane and edge lines: one for traffic speeds of 60km/h or less (predominantly urban areas), the other for speeds greater than 60km/h (predominantly rural areas). Special cases such as motorways are noted in the relevant sections.
- 7.3.5 Where the traffic speed (for the purposes of determining which size of marking should be used) varies along a route, resulting in a mixture of marking sizes along that road, judgement should be exercised to select the more appropriate marking size to adopt for consistency along its length.
- 7.3.6 Longitudinal lines should be formed of full multiples of the line module length; use of segments of line module lengths should be avoided. Where continuous longitudinal lines are used, it is permitted to incorporate 'drainage gaps' as required to prevent surface water ponding. These gaps should be no longer than 100mm and may be spaced at intervals of not less than 2m.
- 7.3.7 Longitudinal lines laid on road pavement joints are not durable. For that reason, when roads are being surfaced, longitudinal joints in surfacing should be offset from the locations at which centre, edge and lane lines are to be placed, as shown in Fig 7.2(a) Longitudinal Line Offset from Surfacing Joint

**Figure 7.2(a):
 Longitudinal Line
 Offset from
 Surfacing Joint**

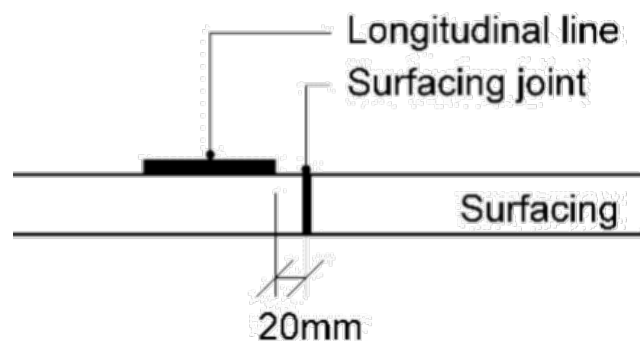

CENTRE LINE MARKINGS

- 7.3.8 The centre line markings described in this Section should be used on single-carriageway roads to separate traffic travelling in opposite directions.
- 7.3.9 A centre line marking (and the centre of a Double Line system) is usually positioned on the geometric centre of the carriageway; however, they may be laid off-centre in certain situations, such as where parking is provided along one side, and on roads with an additional lane in one direction (e.g. a bus, cycle or climbing lane).
- 7.3.10 The visibility distances used in selecting the appropriate type of centre line marking are stated in Table 7.3. It should be noted that for short interruptions to visibility it does not automatically follow that a more restrictive centre line type must be used. Judgement should be used but, in general, a short obstruction to visibility occurring over a distance of no more than one third of the length W-S in Table 7.3(a) may be disregarded.
- 7.3.11 The minimum length of a stretch of centre line marking of any one type should be W - S in Table 7.3(a), except where otherwise stated in this Chapter (see 7.3.18 iii for example)
- 7.3.12 On roads of 6.0m or more in width, centre line markings should be provided. Broken Centre Lines, RRM 002A or B, may be provided where forward visibility is considered adequate for drivers to observe and react to oncoming vehicles. Where forward visibility is limited, for example on bends, humps or dips, the centre line markings should be Warning Lines, RRM 002C or D, or Continuous Lines RRM 001, as appropriate.
- 7.3.13 Centre line markings on two-lane roads on which the speed is 80km/h or less should generally be 100mm wide. On roads with a speed in excess of 80km/h 150mm wide centre line markings should generally be used; however, for rural roads of national classification, centre line markings should generally be 150mm wide, regardless of the speed. It is important that Lane Lines, RRM 003, which separate traffic travelling in the same direction, should not be mistaken by drivers for centre line markings, which separate traffic travelling in opposite directions. Consequently, on multi-lane roads a 150mm wide centre line marking should be used.

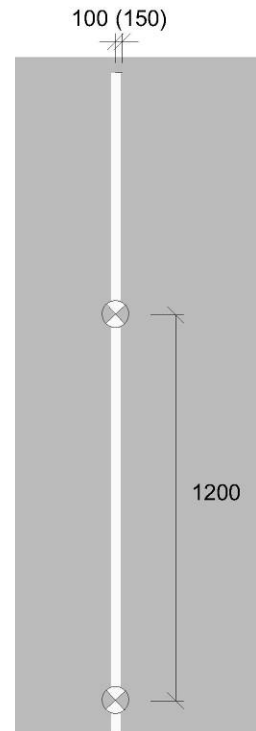

**RRM 001:
 Continuous Single
 Centre Line**

Narrow Roads

- 7.3.14 On narrow roads, over-running of the carriageway edge causing maintenance problems can occur if centre line markings are provided. Drivers might also expect a road marked with a centre line to be wide enough for opposing lanes of traffic to pass. Therefore, on roads less than 5.0m width, centre line markings should be omitted. For widths between 5.0m and 6.0m, provision of a centre line marking is optional. In general, well-aligned roads wider than 5.5m should be provided with a centre line marking; poorly-aligned roads below 5.5m width should not, and judgement should be used in intermediate cases. Section 7.3.54 provides guidance on the use of Edge Lines where provision of a centre line marking is not feasible.
- 7.3.15 Use of a Double Line System (as described in 7.3.28) should generally be avoided on roads less than 6.0m wide

Broken Centre Line (RRM 002A and B)

7.3.16 Two alternative dimensions for Broken Centre Lines are prescribed. The standard modules (the combination of one segment and one gap) are 12m (RRM 002A) and 6m (RRM 002B), and their use is specified in Table 7.1.

Table 7.1: Broken Centre Line RRM 002 A and B

Speed (km/h)	Marking	Line Length (mm)	Gap Length (mm)	Line Width (mm)	Stud Spacing (mm)
> 80	RRM 002A	3000	9000	See paragraph 7.3.13	See Section 7.10
≤ 80	RRM 002B	3000	3000		

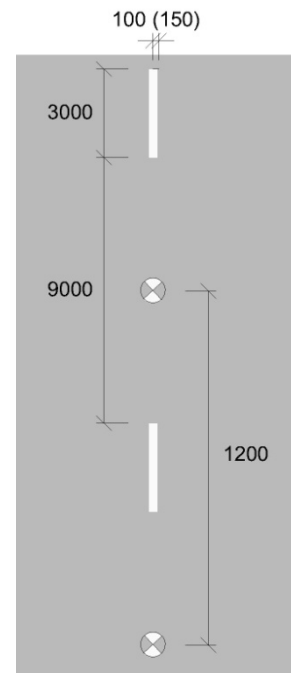

**12 metre Module
RRM 002A**

7.3.17 In certain circumstances Broken Centre Line, RRM 002A or B should be replaced by Warning Centre Line, RRM 002C or D (see following paragraphs), or Continuous Centre Line, RRM 001, or Double Line System.

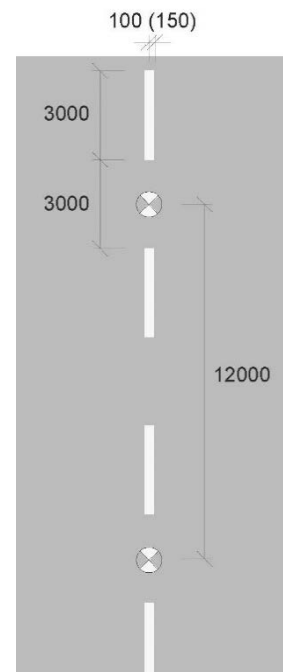

**6 metre Module
RRM 002B**

**RRM 002:
Broken Centre
Line**

Warning Centre Line (RRM 002 C and D)

7.3.18 As described earlier in this Section, the prominence of longitudinal markings can be enhanced by increasing the line-to-gap ratio. Where forward visibility is restricted, or on the approach to some other hazard (e.g. a roundabout or other junction), the centre line marking may be replaced with Warning Lines (RRM 002C or D).

- 7.3.19 Warning Centre Lines should be used in the following situations:
- i. on bends and crests where forward visibility is restricted to less than the distance recommended for use of Broken Centre Line, but still exceeds the visibility criteria for Continuous Line. Table 7.3 gives the visibility distances S and W (for specific speed ranges) between which Warning Centre Lines should normally be provided;
 - ii. where it is necessary to highlight the presence of a road junction, central refuge, level crossing or other hazard and Continuous Lines are not being provided;
 - iii. at rural junctions where Continuous Line markings are not being provided. A minimum length of seven marks of Warning Centre Line should be provided on each major road approach; and
 - iv. on the approach to a Continuous Line to give advance warning.

For cases i, ii and iv above, the minimum length of Warning Centre Line should be W - S stated in Table 7.3(a).

7.3.20 Two patterns of Warning Line are prescribed. The standard modules (the combination of one segment and one gap) are 6m (RRM 002C) and 4m (RRM 002D), and their use is specified in Table 7.2.

Table 7.2: Size of Centre Line Warning Marking RRM 002 C and D

Speed (km/h)	Marking	Line Length (mm)	Gap Length (mm)	Line Width (mm)	Stud Spacing (mm)
> 80	RRM 002C	4000	2000	See paragraph 7.3.13	See Section 7.10
≤ 80	RRM 002D	3000	1000		

7.3.21 Overuse of the marking should be avoided. Its use where not justified will devalue its effect. Particular care should be taken in urban areas where there might be a temptation to use it extensively.

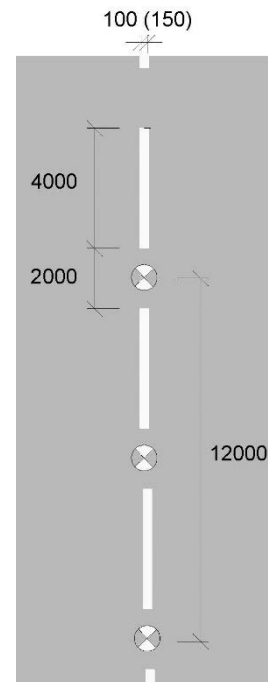

**6 metre Module
RRM 002C**

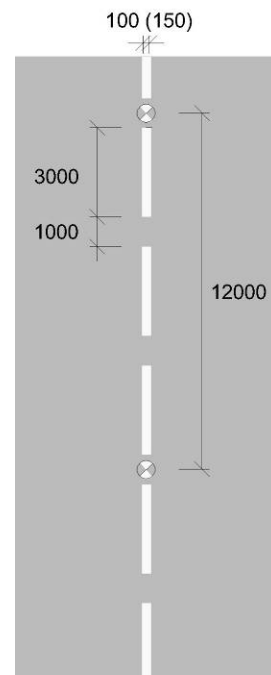

**4 metre Module
RRM 002D**

**RRM 002:
Warning Centre
Line**

Continuous Centre Line (RRM 001)

- 7.3.23 Where crossing of the centre line is to be prohibited, the longitudinal marking should be a Continuous Centre Line (RRM 001). Where the visibility distance is less than the value of S (Table 7.3), use of a Continuous Centre Line should be considered. However, see 7.3.14 for guidance on narrow roads below 6.0m width.
- 7.3.24 It should be noted that where the visibility standards are not satisfied, it does not automatically follow that continuous lines must be laid down. Judgement should be exercised in deciding whether, having regard to the width, alignment and traffic characteristics of the route, it is reasonable to impose the restrictions or whether Warning Centre Line should be used instead. Use of Warning Centre Line instead of Continuous Line may be considered on narrow or poorly aligned roads that are low speed, low volume, or carry significant volumes of slow-moving traffic (such as agricultural vehicles, cyclists and pedestrians). The wide variability in driving conditions on such roads is often not adequately catered for by precise marking of overtaking and non-overtaking sections. Provision of a Warning Centre Line may sometimes be preferable, allowing the driver flexibility to decide whether or not the prevailing traffic conditions permit safe crossing of the centreline.
- 7.3.25 Continuous Centre Line should be provided on the approach to a hazard located on the centre of the road, such as a physical island, a bollard or a ghost island sheltering a right-turn lane. The length should be no shorter than W - S stated in Table 7.3(a) and, in the case of a ghost island right-turn lane, the length should normally be measured to the direct taper of the right-turn lane (not to the commencement of the hatching).
- 7.3.26 It should be noted that drivers may cross a Continuous Line (whether a single line RRM 001 or one that is part of a Double Line System) to enter or leave land or premises on the right-hand side of the road. It is not necessary, therefore, to break the line at such locations. However, a Continuous Line should generally be broken across a junction by provision of five marks of RRM 003C line.
- 7.3.27 Overuse of the Continuous Centre Line marking should be avoided. It is important that it is not used where the appropriate criteria are not satisfied, otherwise it will lose the respect of drivers. In urban areas the centre line of the road is frequently crossed by drivers and, for that reason, a Continuous Centrelines should not generally be used in urban areas.

Roundabouts

- 7.3.28 A Single Continuous Line, RRM 001, should also be provided adjacent to the central island of a roundabout (see Section 7.13).

Double Line System

- 7.3.29 The Double Line System consists of two lines separated by a gap. Any of the three types of centre line markings (Broken, Warning or Continuous), may be used together to form a Double Line System. It permits each direction of travel to be separately marked according to the visibility available and is for use on rural roads of sufficient width (see 7.3.15) on which the visibility would warrant a different centre line marking in each direction of travel. The standard of visibility justifying the lengths of lines is strictly governed by the speeds of vehicles on the road. Table 7.3 sets out the visibility criteria for various speed ranges. Figure 7.2(b) shows examples of Double Line Systems and in the case of a system composed of two broken lines, the markings of the constituent lines should be co-ordinated as shown.
- 7.3.30 Sections of Double Line System formed of lines of the same type should not generally be longer than distance W – S stated in Table 7.3(a).
- 7.3.31 The width of the gap between lines forming a Double Line System should be a minimum of 100mm wide but should generally be the same width as each line comprising the double line system. The distance between the two markings may be increased to 1200mm in certain circumstances, accompanied by hatching as described in 7.3.34 to 7.3.35.

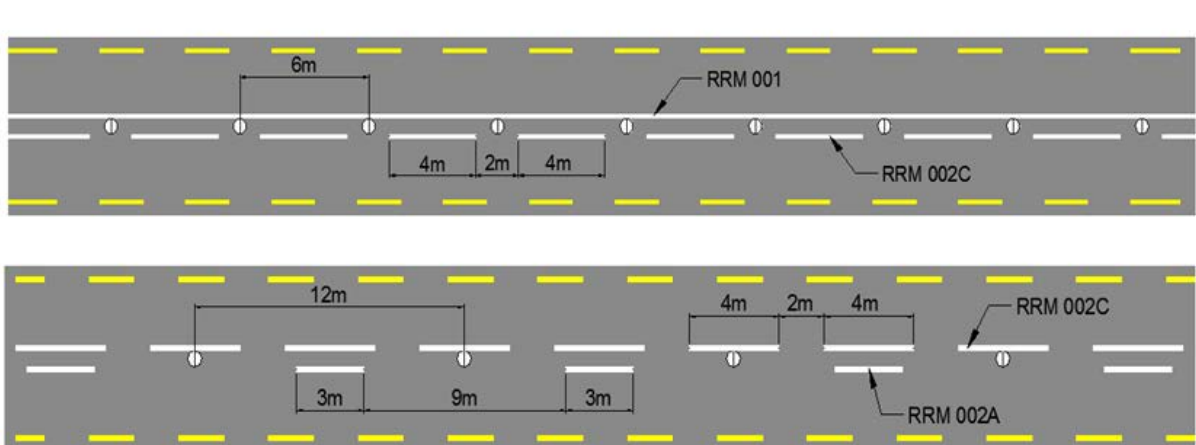

**Figure 7.2(b):
 Double Line System**

Table 7.3: Visibility Requirements

Visibility Distance (m) ¹		
Speed (km/h)	S ² Continuous Line	W ² Warning Line
≤ 50	85 ⁴	145
51 – 60	105 ⁴	175
61 – 70	125	205
71 – 85	145	245
> 85	175	290

Table 7.3(a): Line Length

Minimum Line Length (m)
W – S ³
60
70
80
100
115

Notes:

1. Visibility distance is measured from an eye height of 1.05m above the centre of the carriageway to a target at the same height on the centre of the carriageway;
2. The line type indicated in the table is to be provided when visibility is less than the relevant Visibility Distance;
3. The distance W - S is to be used as:
 - a. the minimum length of a Continuous Line, Warning Line or Broken Line in a direction of travel;
 - b. the minimum length of a Double Line System;
 - c. the maximum length of a section of Double Line System formed of lines of the same type.
4. Use of Continuous Centre Line within an urban area should be avoided.

7.3.32 Where a section of road forms a link between two sections of Continuous Centre Lines and this would result in a length of Warning Line of less than the length W - S stated in Table 7.3, Continuous Lines should be provided throughout.

Design of Centre Road Markings

7.3.33 A site visit should always be made when designing road markings, and designs should not be based solely on plans and longitudinal sections. During the preliminary marking out it will be possible to pin-point obstructions to sight lines on bends (e.g. bushes, hedges, banks, etc.). These should be removed where practicable and the prohibitory line terminals rechecked before lines are painted. Marking-out should be done while hedges are in full foliage. In addition, during the marking out operations special note should be taken of the existence of bus stops or other facilities which would tend to cause vehicles to stop on sections of road with continuous white lines. Between marking out and commencement date, every effort should be made to have them relocated outside the section.

7.3.34 The visibility distances used in the design should be based on the traffic speeds as set out in Section 7.1.

Bends and Crests

7.3.35 On sharp bends where a Double Line System is to be provided, the lines can be splayed to form a type of central 'ghost' island with a maximum overall outside width of 1.2m, provided there is ample room on either side to enable vehicles to negotiate the bend. The area between the lines must be hatched with inclined 200mm wide lines generally at 2.0m spacings but no greater than 3.0m spacings (M 104): see Figure 7.3. Abrupt changes to lane alignment, resulting from too sharp a taper rate, should be avoided.

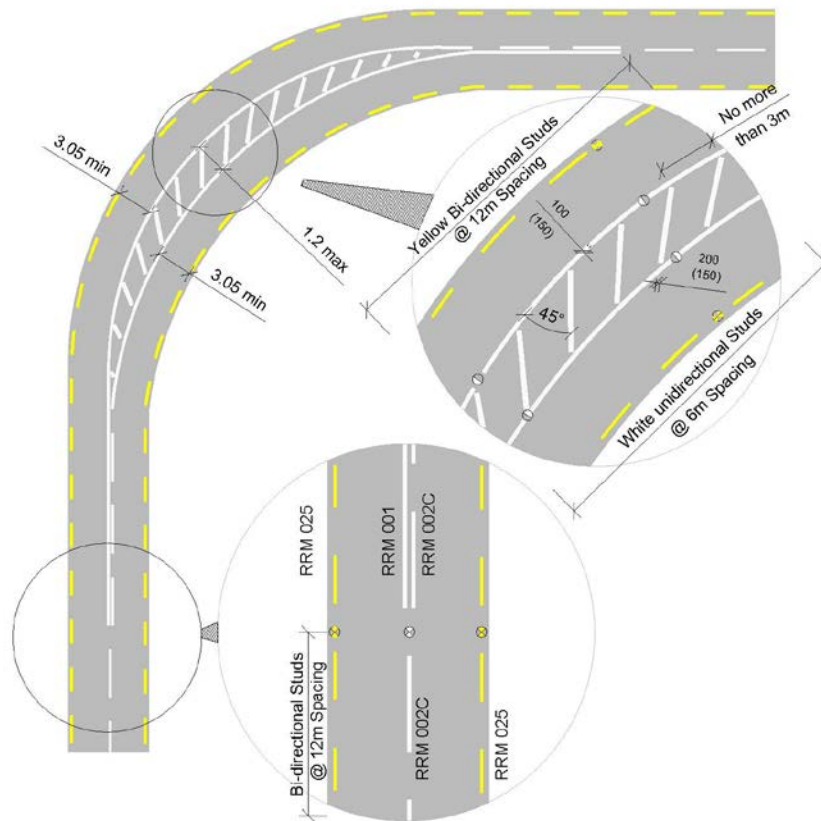

Figure 7.3: Hatching on Bend within Double Line System (M 104)

7.3.36 A crest may be treated in a similar way as a horizontal bend. Where a Double Line System is to be provided, the lines may be opened out at an inclination not exceeding 1 in 50 as they approach the point of minimum visibility (often not the highest point) to attain a maximum overall outside width of 1.2m.

Exceptional Use of Double Centre Lines

7.3.37 In exceptional circumstances, with the consent of the Overseeing Organisation, the Double Line System may be used even though the visibility conditions in both directions are better than the relevant distances in Table 7.3. Such circumstances might include markings carried out in conjunction with traffic calming measures, or to separate opposing traffic flows on three or four-lane single carriageway roads.

CLIMBING / OVERTAKING LANES

7.3.38 Where a climbing lane is provided on a single carriageway road, the three-lane climbing / overtaking section should be marked with a Lane Line, RRM 003 (100mm wide), separating the two uphill lanes and a Double Line System separating the uphill lanes from the downhill lane. The Double Line System should feature a Continuous Line, RRM 001, for uphill traffic in all cases, and either a Continuous Line or a Warning Line for downhill traffic, depending on visibility. A Broken Line, RRM 002A or RRM 002B, should not be used for downhill traffic.

7.3.39 To avoid frequent changes of pattern on long hills, or for safety reasons, the designer may use a downhill Continuous Line even where the visibility criterion for a Warning Line is satisfied. However, the use of a prohibitory line on long, straight sections should be avoided if possible.

7.3.40 The markings at the start of the climbing lane should be designed to encourage uphill drivers to keep to the left-hand lane unless overtaking.

7.3.41 The hatched area preceding the commencement of a climbing lane shall be formed by Diagonal Hatch markings (RRM 021, see Section 7.4) bounded on either side by Continuous Lines (RRM 001), as shown in Figure 7.4.

7.3.42 Typical layouts for the markings at the ends of a climbing lane are indicated in Figures 7.4 and 7.5. For guidance on the provision of climbing lanes see Transport Infrastructure Ireland Standard DN-GEO-03031³.

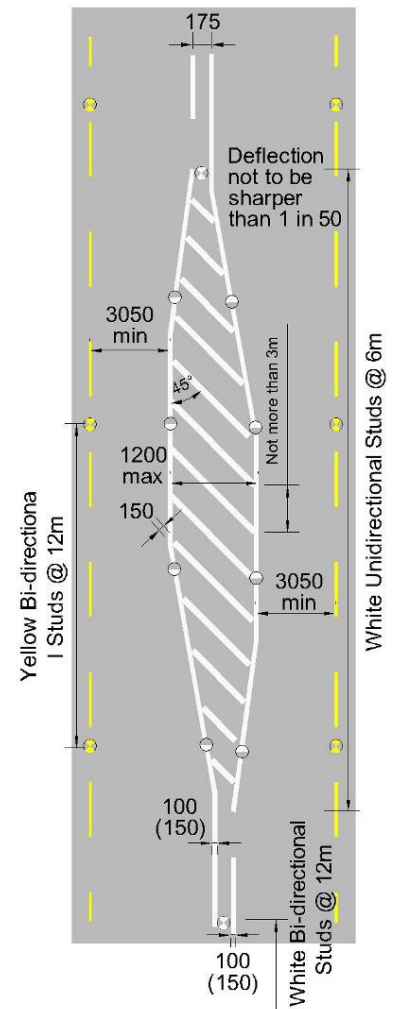

**M104
Ghost Island at
Crest**

³ Transport Infrastructure Ireland. *TII DN-GEO-03031, Road Link Design*. Part of the TII Design Manual for Roads and Bridges. TII, Dublin.

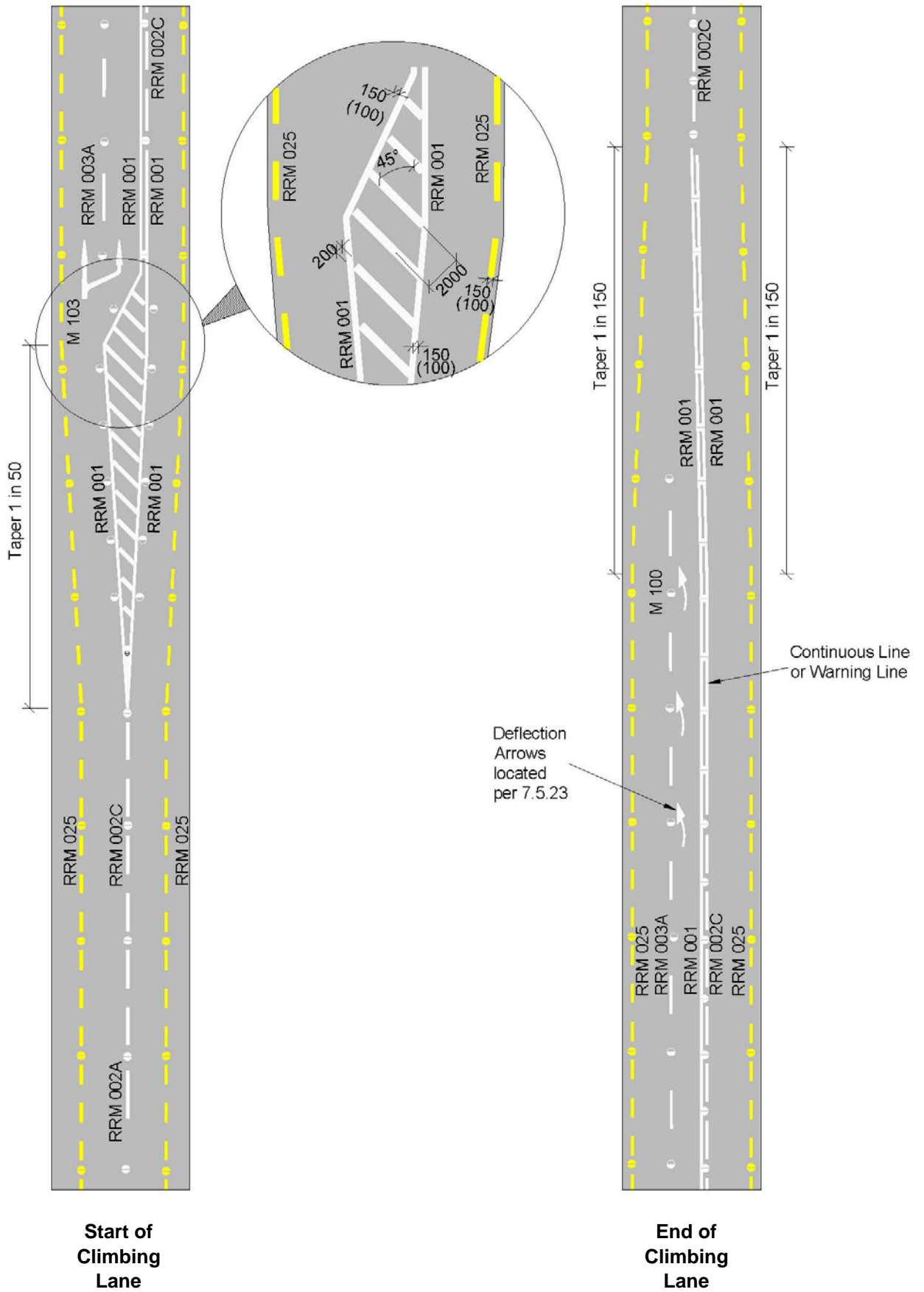

Figure 7.4: Longitudinal Lining for a Climbing Lane

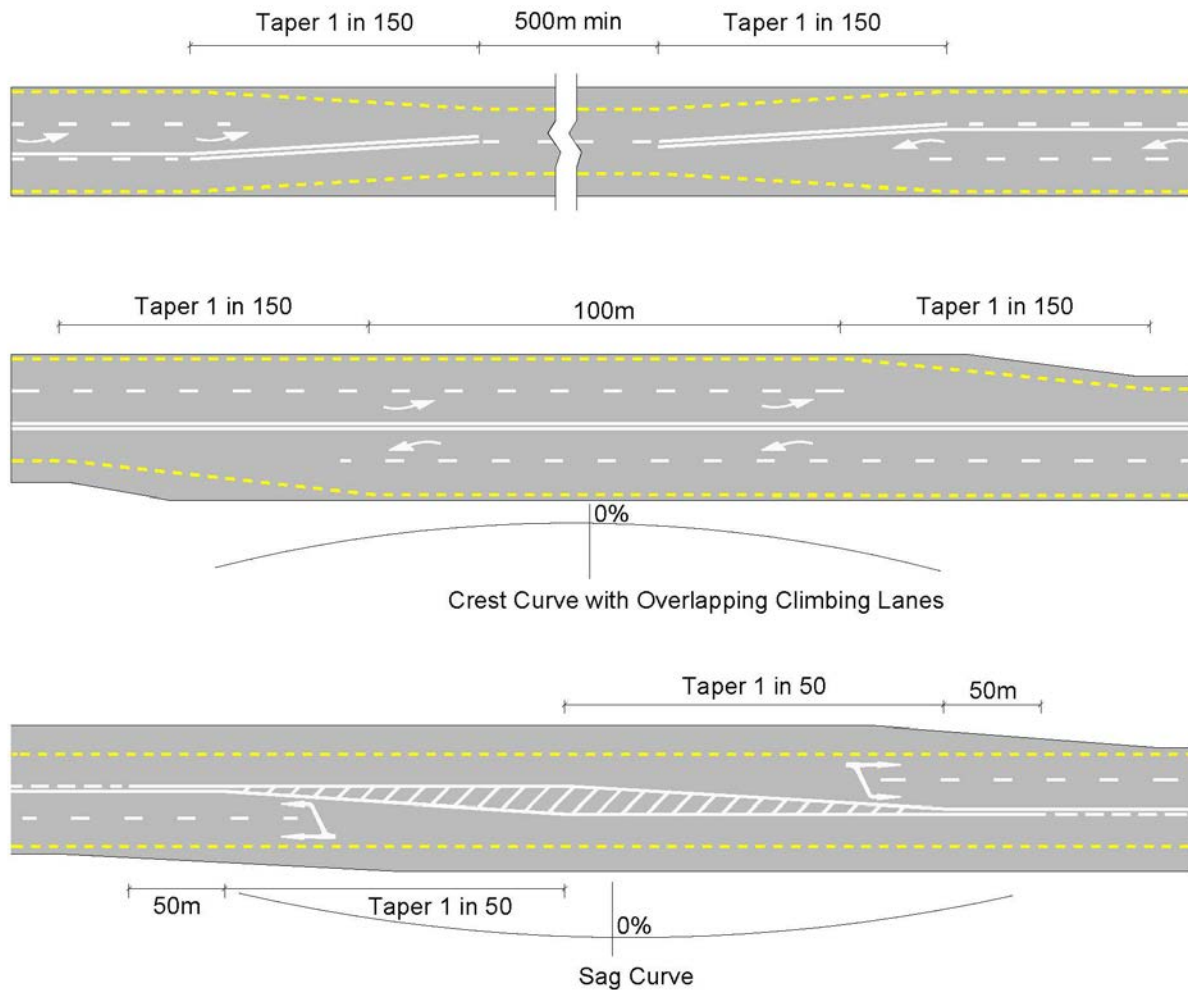

Figure 7.5:
Double Line System Between Two Climbing Lanes on a Crest or Sag

RIGHT-TURN LANES

7.3.43 For guidance on the provision of markings for right turn lanes on single and dual carriageways, see Section 7.11.

PASSING LANES ON TYPE 3 DUAL CARRIAGEWAYS

7.3.44 For guidance on the provision of markings at the ends of passing lanes on Type 3 Dual Carriageways, see Transport Infrastructure Ireland Standard DN-GEO-03031 ⁴.

⁴ Transport Infrastructure Ireland. *TII DN-GEO-03031, Road Link Design*. Part of the TII Design Manual for Roads and Bridges. TII, Dublin.

LANE LINES (RRM 003)

7.3.45 Lane Lines, RRM 003, (lane guidance markings) are used to divide the carriageway into two or more lanes for traffic travelling in the same direction. Their use can ensure that available carriageway space is used to its maximum. In helping vehicles to maintain a consistent lateral position, they also offer safety benefits and should be used wherever possible.

7.3.46 Two alternative longitudinal dimensions for lane guidance lines are prescribed. The standard modules (the combination of one segment and one gap) are 12 metres (RRM 003A) and 4 metres (RRM 003B). The 12-metre module is the default lane guidance marking for all roads.

7.3.47 It is important that lane guidance markings, which separate traffic travelling in the same direction, should not be mistaken by drivers for centre line markings, which separate traffic travelling in opposite directions. Consequently, on climbing or passing lanes on single-carriageway roads the narrower line width should be used for lane guidance markings, and the wider width for centre lines. On dual carriageways and motorways, the 100mm Lane Line width is usually sufficient, but where greater conspicuity is required (for example where it is important that drivers stay in lane through an intersection) the 150mm width may be used.

7.3.48 The 4-metre module is used on multi-lane approaches to signalised and priority junctions, roundabouts, level crossings or other hazards. A minimum of 5 markings should be provided on roads subject to a speed limit up to 50km/h, and 7 markings on roads with a greater speed limit.

7.3.49 The 4-metre module should also be used to delineate the edge of speed change lanes on the approaches to junctions (for example, a segregated right-turn lane). On motorways and high-speed dual carriageways, the edge of a merge or diverge lane shall be delineated with the 250mm wide Merge/Diverge Lane Line, RRM 028, described on the next page.

7.3.50 In certain situations, it may be necessary to provide Lane Lines which cross the path of conflicting traffic flows. This situation can occur for example on the circulating carriageway of a signalled roundabout or within the controlled area of a signal-controlled junction. In these instances, RRM 003C as described in Section 7.13 may be used.

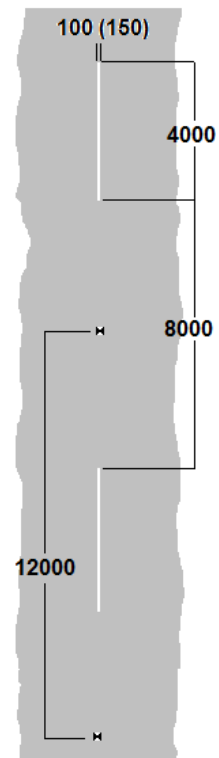

**12 metre module
RRM 003A**

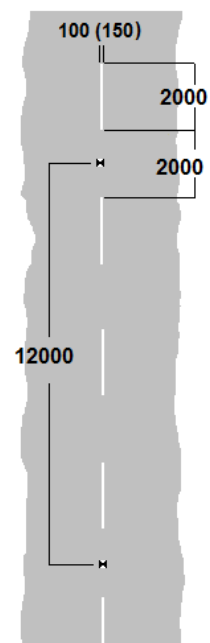

**4 metre Module
RRM 003B**

RRM 003: Lane Lines

MERGE/DIVERGE LANE LINE (RRM 028)

- 7.3.51 On motorways and high-speed dual carriageways, the boundary between a merge or diverge lane and the rest of the carriageway should be delineated with a Merge/Diverge Lane Line, RRM 028. This consists of a 250mm wide broken marking with 2m long lines and 2m gaps. Unidirectional green road studs should be laid at 8m centres along the marking (see Section 7.10).
- 7.3.52 The Merge/Diverge Lane Line should be marked from the start of a diverge lane (see Figure 7.7). A bifurcation arrow (M102) should be provided to highlight the presence of the diverge lane, and a short gap may be provided in the line and studs to accommodate the head of the diverge arrow. Chevron markings are normally required at merges and diverges in addition to Merge/Diverge Lane Lines (see Sections 7.4 and 7.14). Layouts of the signs and markings at typical junctions incorporating merges and diverges are illustrated in Chapter 10.
- 7.3.53 For extended diverge situations, for example at a diverge lane-drop, this marking is used to segregate the nearside lane(s) from the ahead lanes. The marking should commence at the first Advance Direction Sign (ADS), normally 1km in advance of the diverge point. However, in the case of an auxiliary merge/diverge, the marking should span between the merge and diverge points.

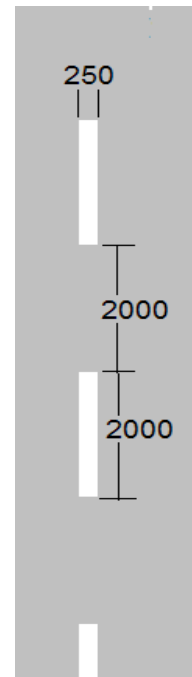

**RRM 028:
 Merge/Diverge
 Lane Line**

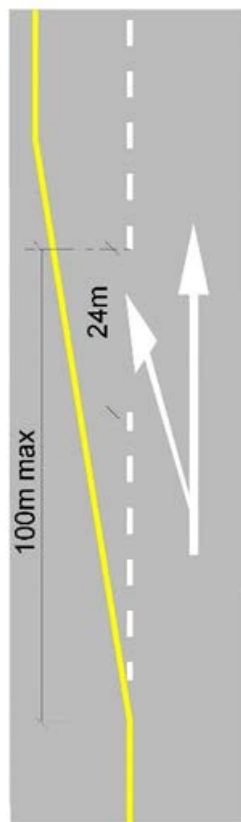

Diverge Lane Marking discontinued when the gap is 100m max in length or 2.5m from the taper.

**Figure 7.7:
 Start of Diverge Lane Marking**

EDGE OF CARRIAGEWAY LINES (RRM 025, RRM 026 & RRM 027)

7.3.54 The standard Broken Edge of Carriageway Line consists of a 2m mark, 2m gap in yellow (RRM 025). A continuous yellow line, RRM 026, is used exclusively on motorways to indicate that trafficking of the shoulder is not permitted. On the offside edge of motorways and dual carriageways a continuous white line, RRM 027, shall be used (See also paragraph 7.3.59). Table 7.4 gives guidance for the provision of Edge of Carriageway lines.

7.3.55 On rural single carriageway roads, the Broken Edge of Carriageway Line, RRM 025, is recommended to delineate the edge of the roadway. It should also be used to delineate the boundary between the traffic lane and hard shoulder where provided.

7.3.56 On narrow rural roads where it is not practicable to provide centre lines (for example, where the carriageway is less than 5.0m in width) consideration should be given to the laying of Broken Edge of Carriageway Lines to give drivers a visual indication of the road alignment. Paragraph 7.3.13 discusses this in greater detail.

7.3.57 The width of the marking depends upon the type of road. In general, on single carriageway roads, the width of the edge line should match that of the centre line. The guidance provided in 7.3.13 relating to width of centre line markings, should also be used for Edge of Carriageway Line width. A 100mm line width is generally sufficient on narrow roads on which a centre line is not being provided. On motorways and dual carriageways and national roads the 150mm width must always be used.

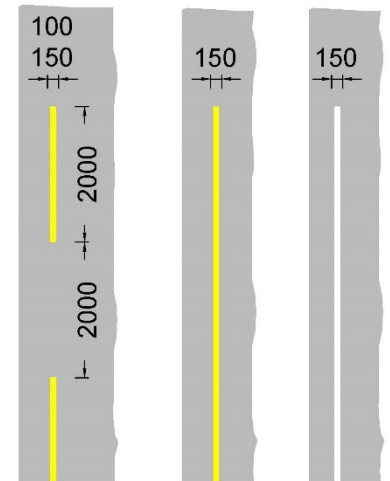

RRM 025 RRM 026 RRM 027

**Broken and Continuous
 Edge of Carriageway Lines**

Table 7.4: Provision of Edge of Carriageway Lines

Road Width / Type	Rural	Urban
< 5.0m	Optional	No
5.0 – 6.5m	Optional	Not generally
> 6.5m	Recommended	Not generally
4-lane	Yes	Not generally if kerbed. Yes otherwise.
Dual carriageway/Motorway	Yes	Yes

RAISED PROFILE EDGE MARKINGS

7.3.58 Raised profile markings consist of a continuous line marking with ribs across the line at regular intervals. The vertical edges of the raised ribs stand clear of the water film in wet conditions, improving retroreflective performance under headlight illumination. The ribs also provide an audible vibratory warning to drivers should they stray from the carriageway and run onto the marking.

7.3.59 Two types of Raised Profile Edge Marking are specified: Type M for use on motorways and high-quality dual carriageways (including slip roads) and Type A for use on all other roads, where the more aggressive rib of the Type M marking would have an unacceptable effect on cyclists and pedestrians.

Motorways and High-Quality Dual Carriageways

7.3.60 On motorways and high-quality dual carriageways, raised profile markings Type M to the dimensions shown in Figure 7.8 shall be used to form the continuous edge of carriageway markings (RRM 026 and RRM 027) including hatch boundary lines (RRM 021).

7.3.61 The base marking shall be no more than 6mm high. The up-stand of the ribs above the base marking must not exceed 11mm. The 500mm spacing is suitable for most edge lines laid on the main carriageway, and for continuous boundary lines to hatched areas (RRM 021). The 250mm spacing is recommended for use on slip roads, where the closer spacing helps to maintain the rumble effect, offsetting the likely lower speed. The colour of the markings shall be either white or yellow as appropriate.

Other Roads

7.3.62 On roads other than motorways and high-quality dual carriageways, raised profile lines Type A to the dimensions shown in Figure 7.8 may be used in the following circumstances:

- Continuous lines indicating the offside edge of carriageway on a dual carriageway (RRM 027);
- Continuous bounding line of a diagonal hatched area (RRM 021); and
- Continuous bounding lines of a chevron hatched area (RRM 021), when used between main carriageway and slip road, or between bifurcating or converging carriageways (but not at a roundabout).

7.3.63 The base marking shall be no more than 6mm high. The upstand of the ribs above the base marking must not exceed 8mm.

7.3.64 Where reflecting road studs are provided as part of a raised profile marking, the studs may be offset on the trafficked side of the marking as described in Section 7.10 to provide additional audible warning to drivers, to facilitate easier maintenance and renewal of the markings, and to ensure self-cleaning of the studs from over-running. However, before this arrangement is applied, regard should be had to the minimum clear lane width as detailed in the TII design standards.

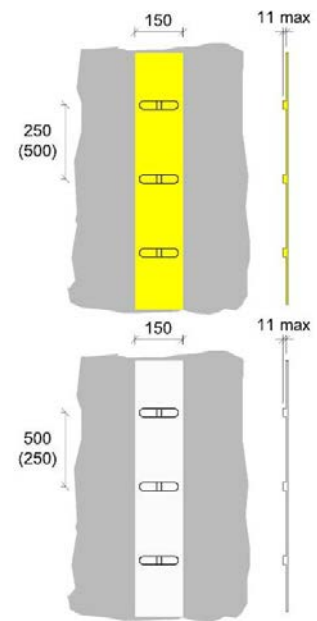

Motorways – Type M

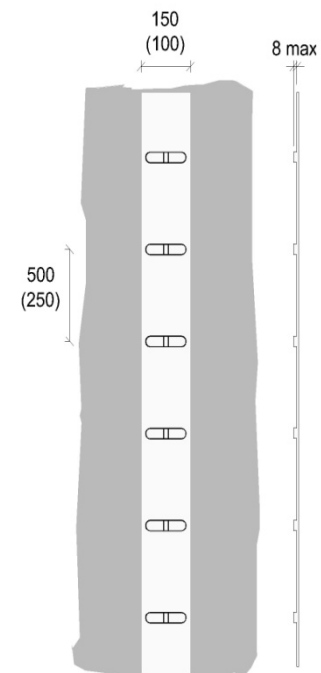

Other Roads – Type A

**Figure 7.8:
 Raised Profile
 Edge Markings**

- 7.3.65 Raised profile markings should not be laid where the noise produced by over-running vehicles is likely to cause annoyance to residents. Nor should they be used where pedestrians and cyclists cross the road (e.g. at refuges) or at other places where cyclists are likely to cross them. In such cases, a plain edge line should be used instead.
- 7.3.66 When raised profile markings are renewed, care must be taken to ensure that the rib height is not increased above the maximum recommended height.

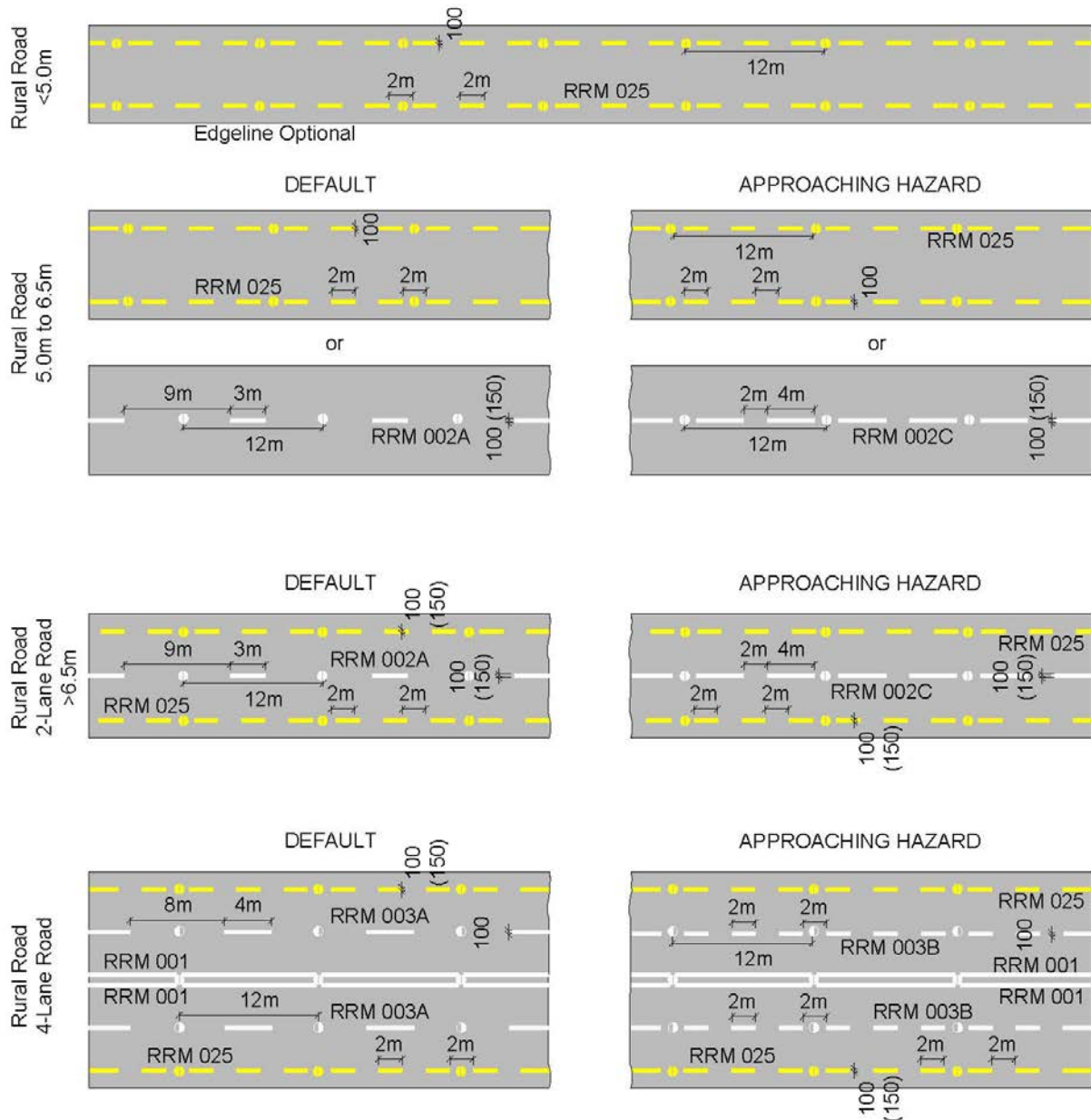

Figure 7.9:
Centre, Lane and Edge Markings for Rural Roads (>60km/h)

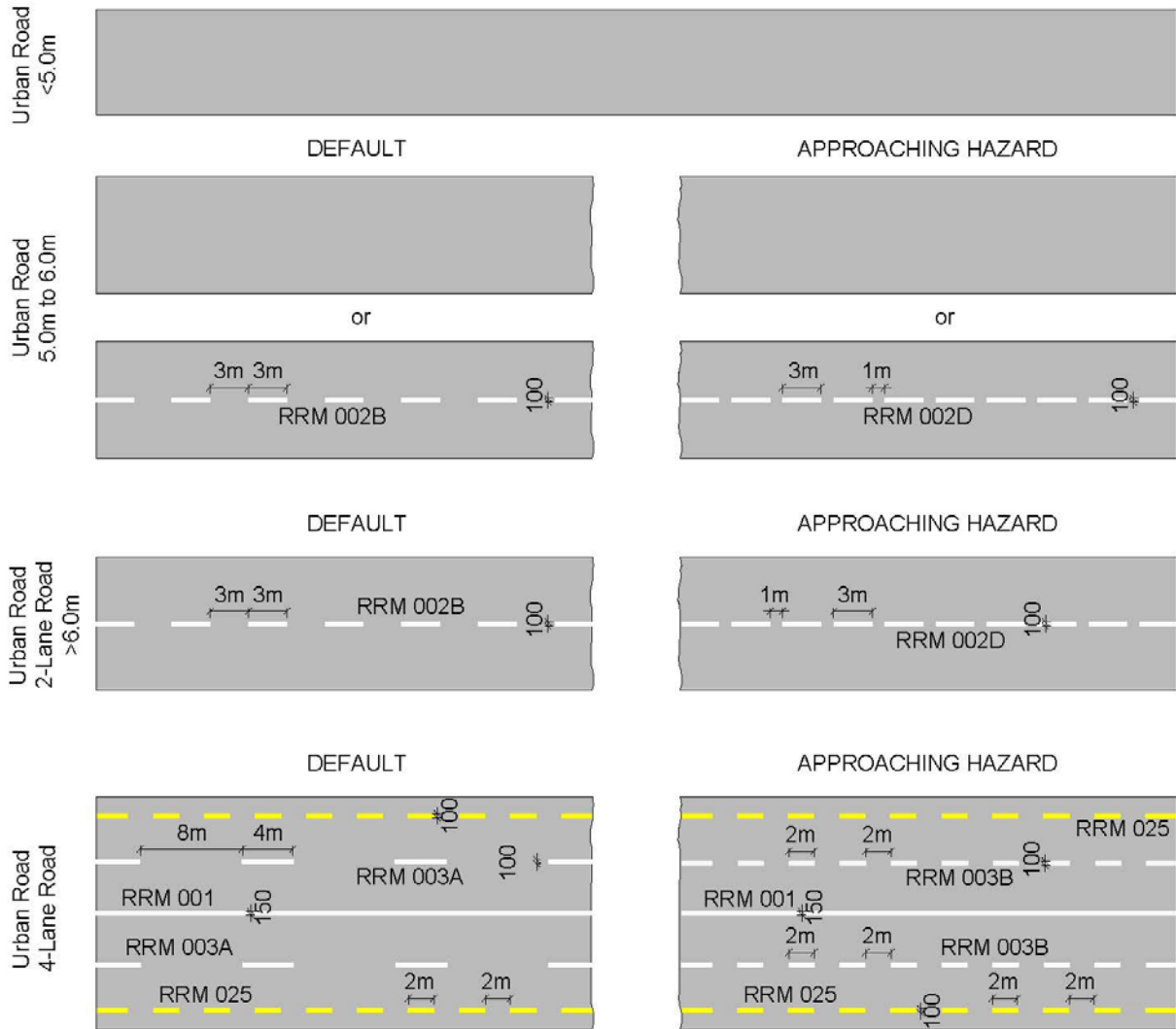

Figure 7.10:
Centre, Lane and Edge Markings for Urban Roads (≤60km/h)

NOTE: Studs are not normally provided when street lighting is present

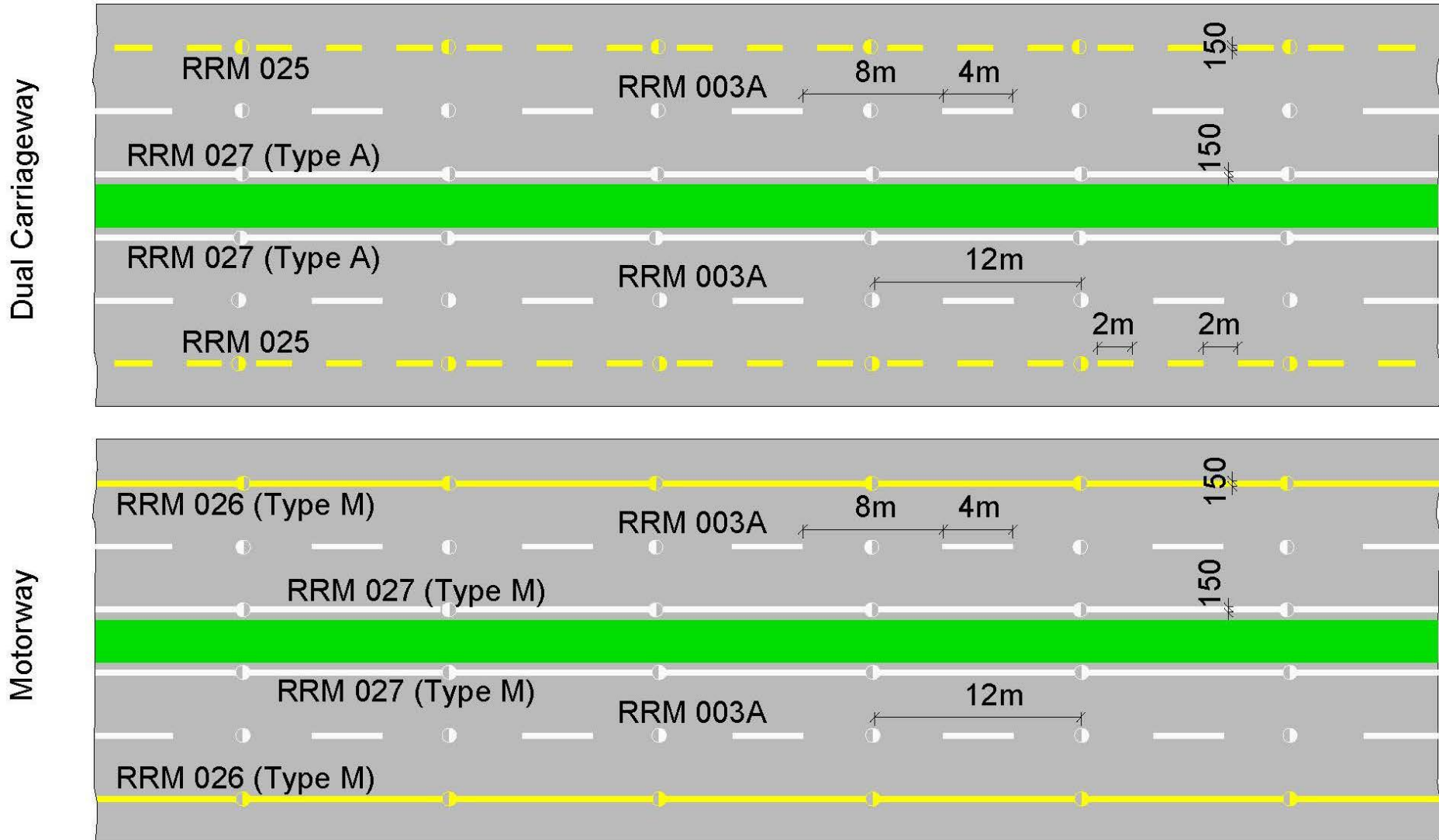

Figure 7.11:
Centre, Lane and Edge Markings for Dual Carriageways and Motorways (> 60km/h)

7.4 Hatched Markings

7.4.1 Hatched markings (RRM 021) consist of two elements – the bounding line or lines, which may be Continuous or broken, and the hatching itself. Hatched markings may be bounded by a Continuous Line (RRM 001) where entry to the hatched area is prohibited or by a Warning Line (RRM 002C or D) where entry is not prohibited. Applications include:

- the immediate approaches to channelising and central reserve islands;
- indication of a reduction in road width ahead;
- at locations where the road geometry may preclude the construction of physical islands due to likely over-running by certain vehicle classes; and
- other areas which drivers should not enter unless it is safe to do so.

7.4.2 Boundary line widths and the width and spacing of the hatch lines are dependent upon the type of road and the speed of traffic. Specific types of marking exist for motorways and high-speed dual carriageways, and for other roads. Table 7.5 summarises the alternative dimensions to be used for given speeds and road types. However, if this results in a mixture of sizes along a discrete route, engineering judgement should be exercised to determine the predominant size to be adopted for the route.

Table 7.5 Dimensions of Hatched Markings

Road / Layout	Speed (km/h)	Boundary Line Width (mm)	Diagonal Line Width ^a (mm)	Chevron Line Width (mm)	Spacing of Hatch Lines (mm)	
Single or Dual Carriageway	≤ 60	100	150	200	3000 (6000) †	See Figures 7.16 & 7.17
	61 – 100	150	200	500	2000 (4000) †	See Figure 7.18
High Quality Dual Carriageway or Motorway	100 – 120	150	500	1000	2000 (4000) *	See Figures 7.13 & 7.14
Widened Central Reserve	All	150	200	-	4000	See Figure 7.12
Climbing Lanes and Right-Turn Lanes (See Section 7.3)	All	150	200	-	2000 (4000) †	See Figures 7.4 & 7.15

† The larger dimensions for hatch spacing may be used when bounded by Warning Lines.

* The larger spacing is for use at central reserve widening.

7.4.3 Where hatched markings are used to separate traffic travelling in opposite directions, or to deflect traffic from a stationary feature, diagonal hatch lines shall be used. Where the marking is used to separate streams of traffic travelling in the same direction chevron hatch lines are used. With both diagonal and chevron hatched markings, care must be taken to ensure that the direction of the hatch relative to the direction of travel of adjacent vehicles is such as to present a series of transverse lines to vehicles straying into the hatched area.

MOTORWAYS AND HIGH-QUALITY DUAL CARRIAGEWAYS

- 7.4.4 White chevron markings (RRM 021) are the most common hatch marking on motorways and high-quality dual carriageways, and are used to divide traffic travelling in the same direction: for example, at the nosings of merge and diverge lanes. The chevron hatch line shall have a width of 1000mm at 2m spacing and shall be bounded by continuous white lines 150mm wide (see Figure 7.14).
- 7.4.5 Diagonal hatch markings (RRM 021) on motorways and high-quality dual carriageways will only be appropriate adjacent to the central reserve in the case of a lane drop, or exceptionally on the hard shoulder, and shall consist of 500mm wide markings at 2m spacing (see Figure 7.13).
- 7.4.6 The boundaries of such diagonal hatched areas shall be consistent with the prescribed edge markings for the type of road, as described in Section 7.3. Where hatching is required on the offside of a motorway or high-quality dual carriageway (for example at a lane drop – see Figures 7.13 and 7.21), a 150mm continuous white marking (RRM 027) shall be used to bound the hatching, and the bounding line and hatching shall be white. Raised rib markings should be used (on the bounding line only) in such circumstances.
- 7.4.7 On high speed dual carriageways, the boundary for diagonal hatching on the nearside of the carriageway shall be delineated by a 150mm wide broken yellow marking consisting of a 2m segment and 2m gap (RRM 025), and the hatching shall be yellow (Figure 7.13). If in exceptional circumstances hatching is required on the nearside of a motorway, yellow hatching and continuous boundary lines (RRM 026) shall be used.
- 7.4.8 Where a paved central reserve is widened in order to provide the required stopping sight distance, diagonal hatching should be provided on the widened reserve. In this location the bounding line shall be a Continuous White Edge Line (RRM 027) and the hatching shall be white lines at 4000mm spacing. After each group of four hatch lines, a gap of 12000mm may be provided before the next hatching (see Figure 7.12).

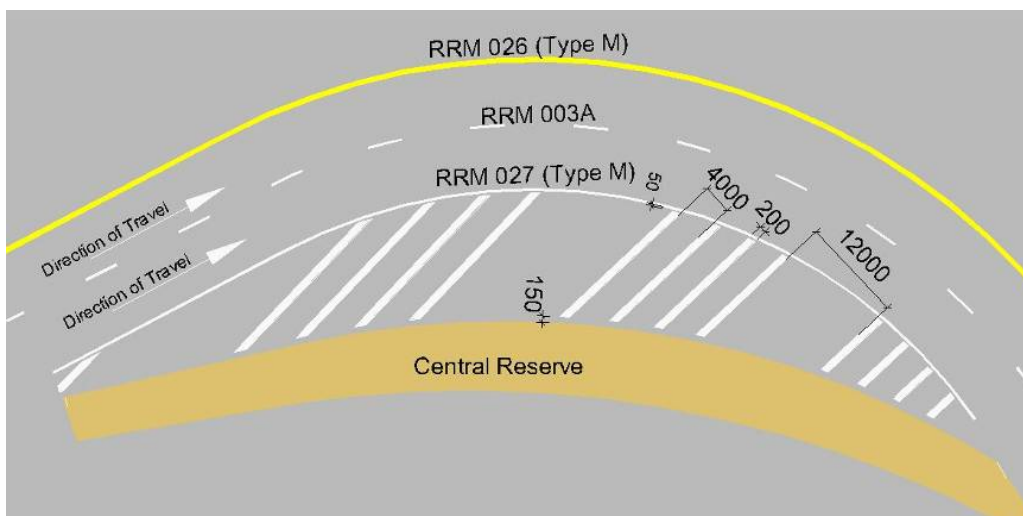
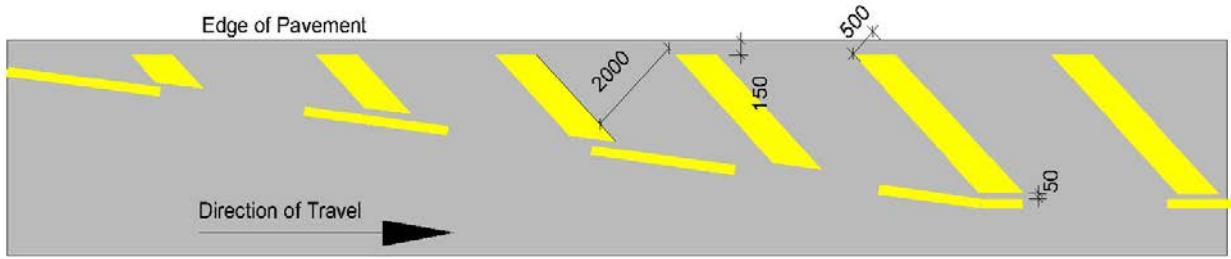
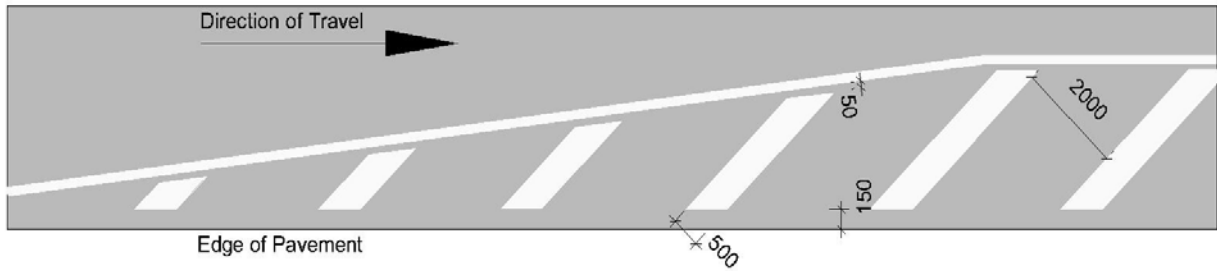

Figure 7.12:
Diagonal Hatched Marking for Use on Widened Central Reserves



Diagonal Hatched Marking for Use on Nearside of High-Quality Dual Carriageways



Diagonal Hatched Marking for Use on Offside of Motorways and High-Quality Dual Carriageways

Figure 7.13: (RRM 021)

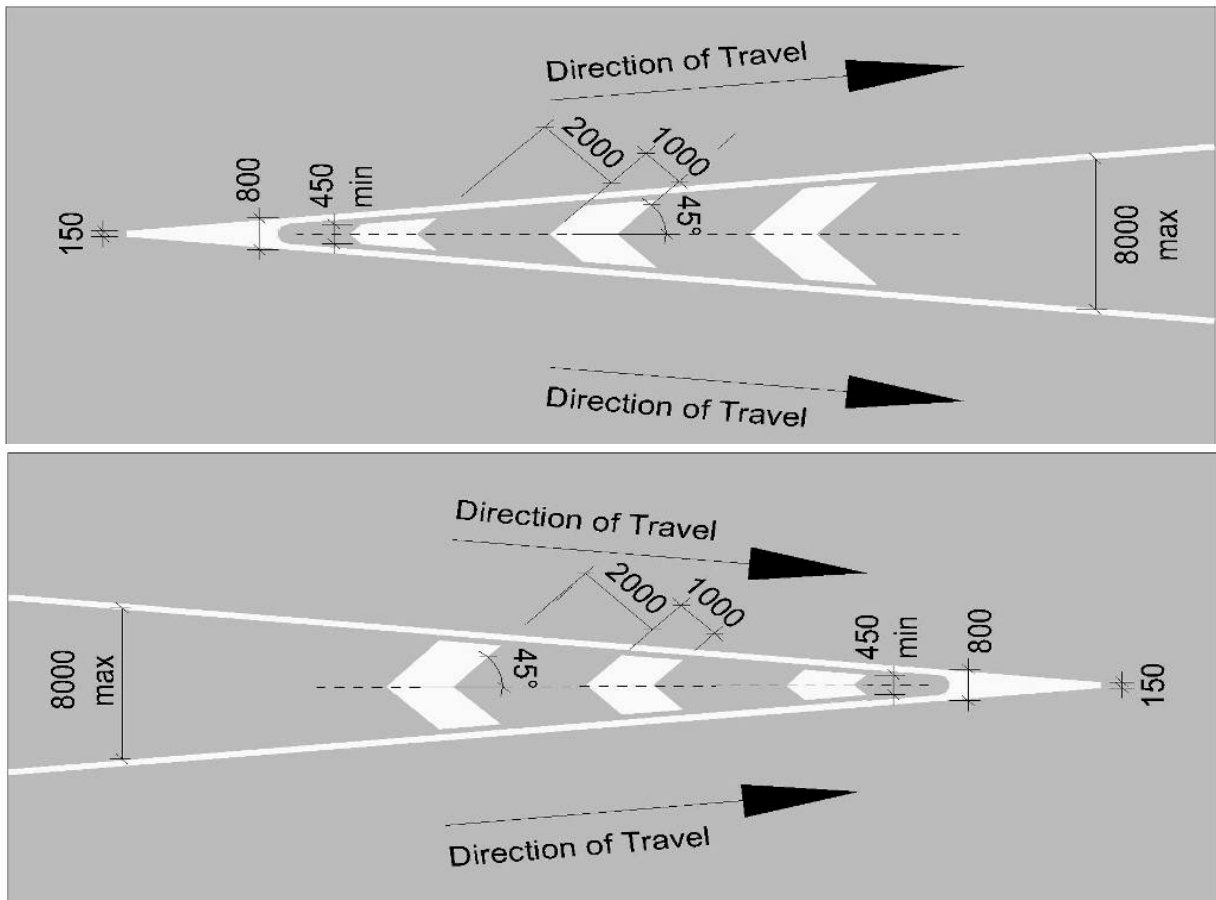

Chevron Markings for Diverging and Merging Traffic on Motorways and High-Quality Dual Carriageways

Figure 7.14: (RRM 021)

OTHER ROADS

- 7.4.9 On single carriageway roads the diagonal hatch is most common; it is used to separate streams of traffic travelling in opposite directions. Chevron hatching is used to segregate traffic travelling in the same direction (for example at splitter islands on one-way streets). Dimensions of hatched markings are given in Table 7.5.
- 7.4.10 Hatch lines shall be the same colour as the boundary lines; in most cases, therefore, hatching will be white. In circumstances where hatching is bounded by yellow edge lines (such as localised narrowing on the left side of the carriageway) the hatching shall be yellow (see Figure 7.19).
- 7.4.11 It is permitted to use different boundary line types on either side of a hatched area where appropriate. Figure 7.15 gives an example of how this could be applied in the vicinity of a short length right turn lane, where queuing right turning vehicles could impede straight ahead traffic. It would be acceptable for right turning traffic to enter the hatched area if the right turn pocket is full, but it would not be permitted for oncoming traffic to cross into the hatching.
- 7.4.12 Where there is a large area of hatching bounded by a Warning Line, the spacing between hatch marks may be increased to the bracketed dimension shown in Table 7.5.
- 7.4.13 Figures 7.16 to 7.18 provide a visual guide of which hatching should be used by road type, and Figures 7.19 and 7.20 illustrate the application of hatching in various scenarios.

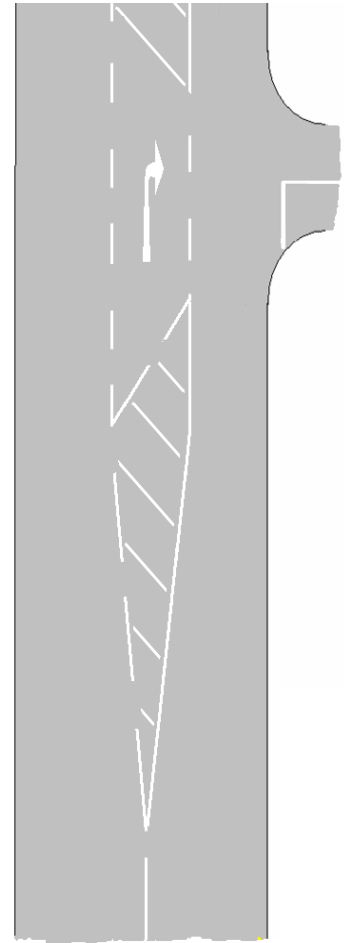

**Figure 7.15:
Use of Different
Boundary Lines at a
Limited-length Right
Turn Pocket**

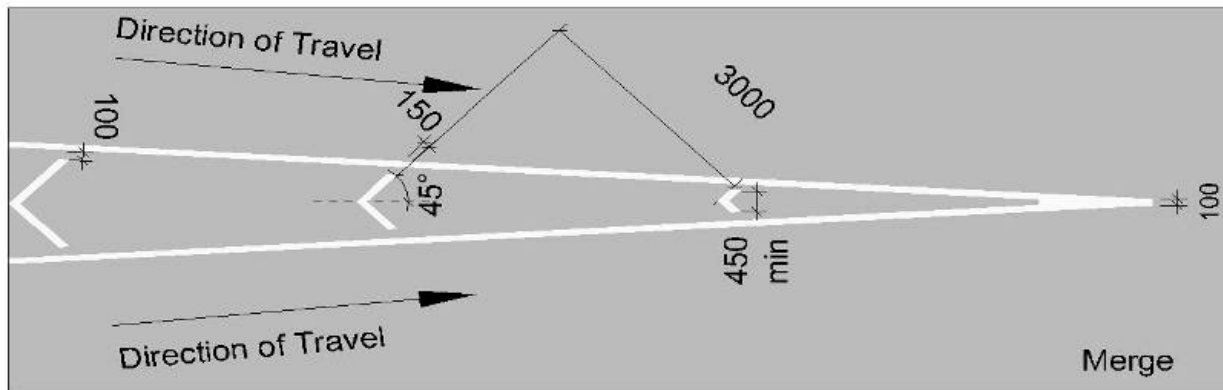
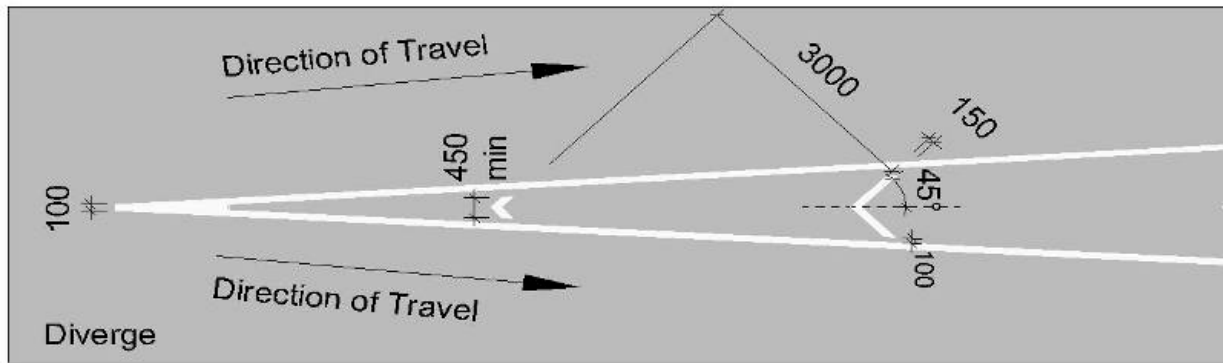
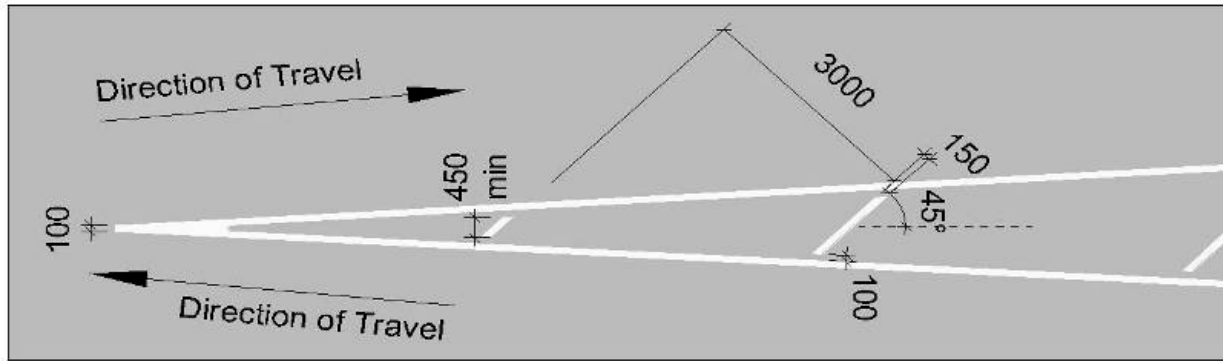

Figure 7.16: (RRM 021)
Hatched and Chevron Markings for Roads
≤ 60km/h
(Continuous Boundary Lines)

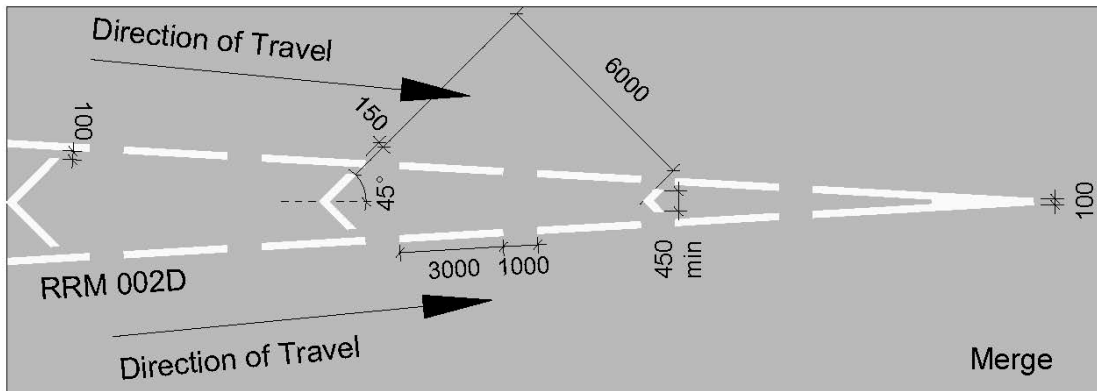
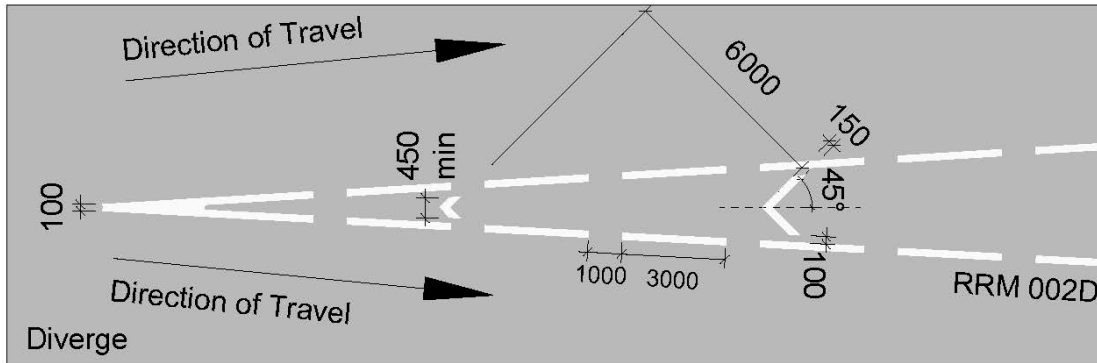
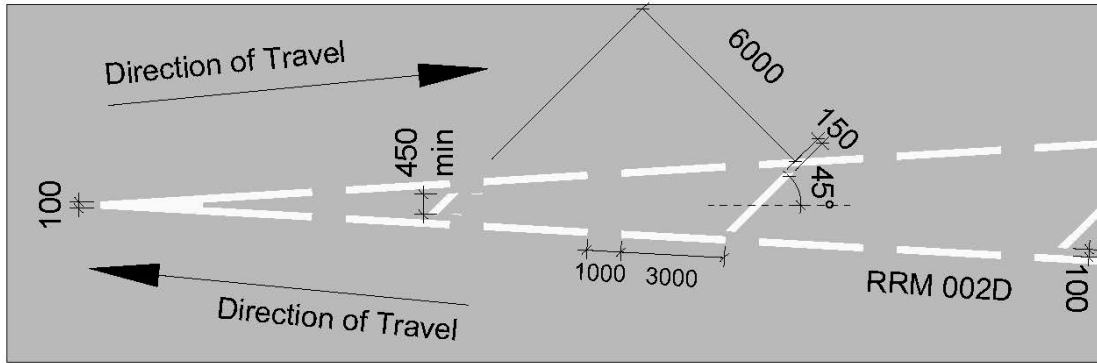
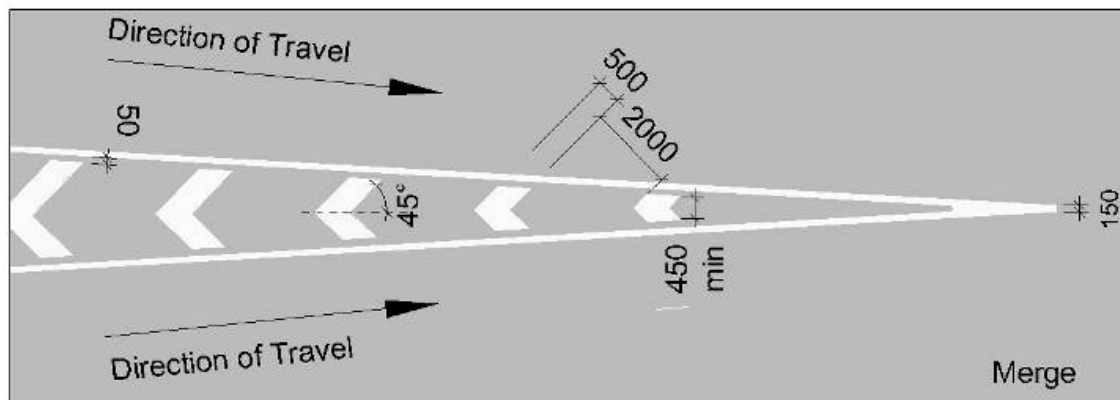
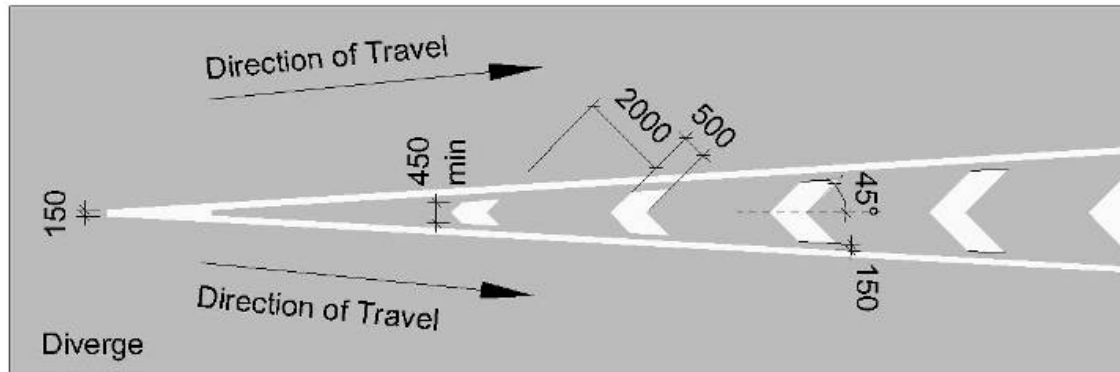
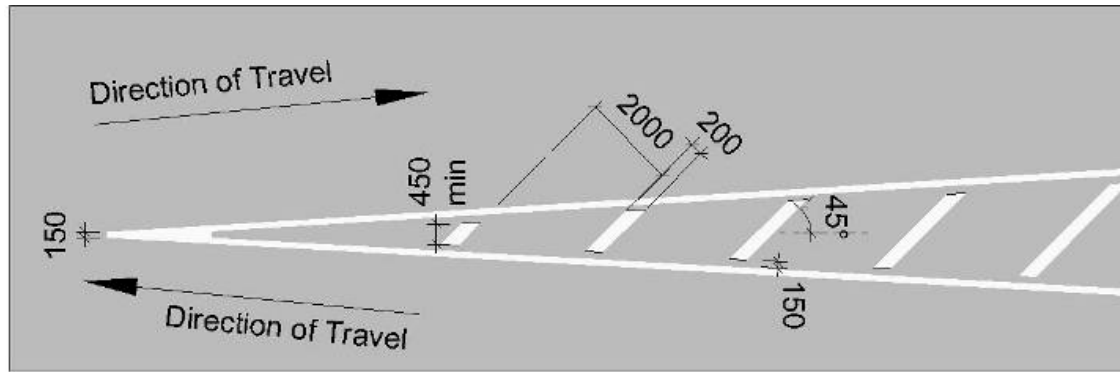

Figure 7.17:
Hatched and Chevron Markings for Roads
 $\leq 60\text{km/h}$
(Warning Lines)



**Figure 7.18: (RRM 021)
Hatch and Chevron Markings for Roads
other than Motorways and High-Quality Dual
Carriageways (>60 km/h)**

Note: For hatch dimensions see Table 7.5.

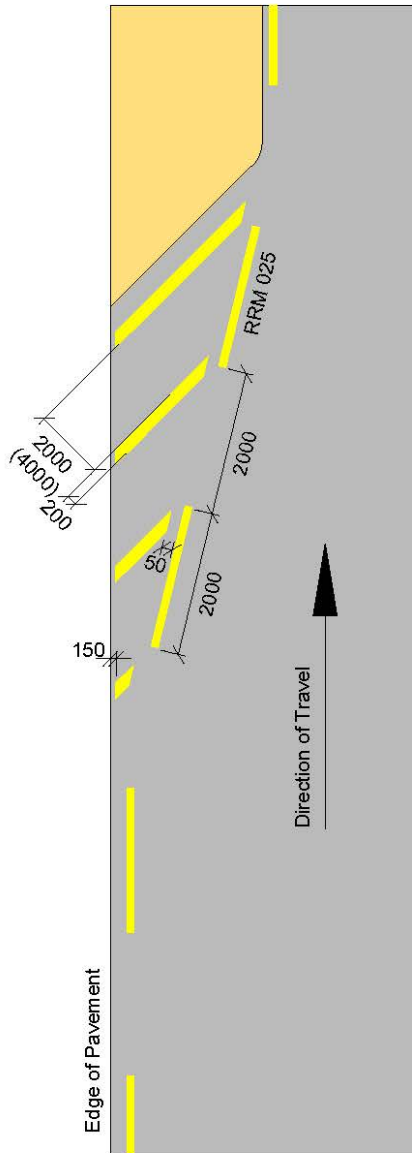

Figure 7.19:
Hatched Marking on
Nearside of
Carriageway
on Roads other than
Motorways and High-
Quality Duals

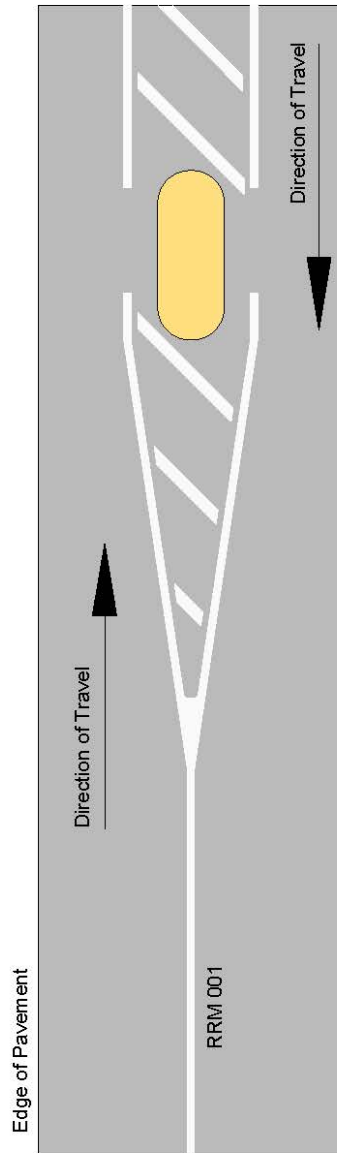

Figure 7.20:
Hatched Markings
on the Approach to a
Central Island or
Refuge

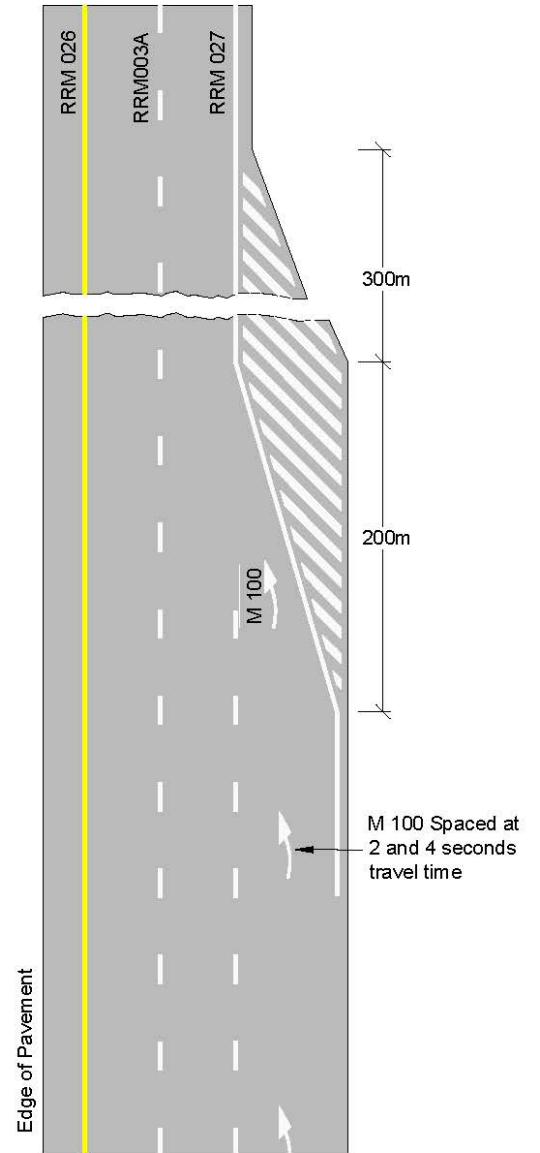

Figure 7.21:
Example of
Motorway Lane
Reduction Markings

Note:
For hatch dimensions see Table 7.5.

7.5 Worded and Diagrammatic Markings

- 7.5.1 Various worded markings are prescribed. Some augment kerbside signs, others indicate areas of the carriageway intended for a particular function (e.g. Loading), for classes of vehicle (e.g. Bus), or to be kept clear (e.g. School). The markings are generally white, but certain diagrams are yellow in colour as indicated.
- 7.5.2 The basic characters for the capitals, numerals and the apostrophe are from the Transport Medium Alphabet, elongated to compensate for foreshortening. There are two standard alphabet sizes, 1600mm and 2800mm (see Appendix 7A). However, some worded markings such as 'TAXIS', 'SCOIL', etc. do not require such compensation, and therefore use the 'base font' of the Transport Medium Alphabet, scaled to give the overall height indicated in the various figures.

STOP (M 114)

- 7.5.3 The worded STOP marking (M 114) may only be used to supplement the transverse Stop Line (RRM 017) or No Entry Line (RRM 019) when used at a road junction in conjunction with the Stop Sign (RUS 027). It must not be used in any other circumstances, such as at signal-controlled stop lines. The wording shall be formed from the letters detailed in Appendix 7A; the height may be 1600mm or 2800mm; the larger size is recommended for use on high-speed approaches.



**M 114:
Worded STOP
Marking**

TRIANGULAR YIELD MARKING (M 115)

- 7.5.4 The hollow triangular YIELD marking (M 115) may only be used at junctions when a transverse Yield Line (RRM 018) or No Entry Line (RRM 019) is provided and may be accompanied by a Yield Sign (RUS 026) or Mini-Roundabout Sign (RUS 049). It must not be used elsewhere.
- 7.5.5 Where triangular markings are used they should be positioned approximately in the centre of the traffic lane. Where the approach to the junction is divided into two or more lanes, a triangular marking should be provided in each lane.
- 7.5.6 At the end of a one-way street, triangular YIELD markings should be laid in each lane to give visual emphasis to drivers of the one-way operation. This is shown in Figure 7.37 (see Section 7.11). Worded NO ENTRY markings should not be used.
- 7.5.7 The Stop and Yield markings should normally be located 2.1m to 2.75m from the associated transverse marking, but exceptionally this distance may be increased to a maximum of 15m depending on the visibility at the junction, its layout, and the speed of traffic on the minor road.

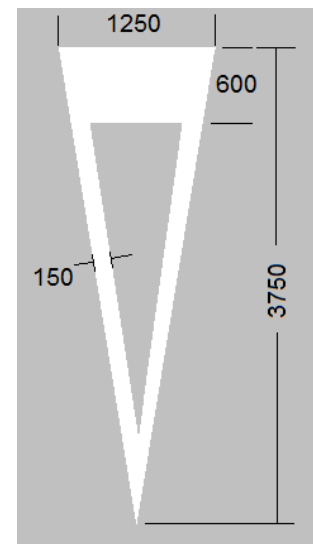

**M 115:
Triangular Yield
Marking**

SLOW (M 106)

- 7.5.8 The worded SLOW marking (M 106) may be used to supplement a warning sign on the approach to a hazard or road junction. The marking may be composed of either the 1600mm or 2800mm lettering: the larger size is recommended for use on high-speed approaches.
- 7.5.9 Discretion should be exercised in the use of this marking, to ensure that its impact is not reduced by proliferation. At particularly hazardous situations, for example on the approach to a bend at the end of a long straight section of high-speed road, the marking may be repeated, with its location related to travel time in a similar method to that described for deflection arrows in Paragraph 7.5.23.
- 7.5.10 The location of the marking will depend on the nature of the hazard. In general, it should be located sufficiently far back to enable a driver travelling at the normal speed of the road to reduce speed in time to negotiate the hazard in safety. In some instances, it may be possible to make use of a change in vertical grade to position the marking for increased conspicuity.



**M 106:
SLOW marking**

LOOK LEFT/RIGHT (M 107L/R)

- 7.5.11 The worded LOOK LEFT and LOOK RIGHT markings (M 107L and M 107R) are generally intended to warn pedestrians of approaching vehicular traffic at locations where traffic may be approaching from an unexpected direction, such as on a one-way street or between channelising islands. The marking consists of the words LOOK LEFT or LOOK RIGHT (FÉACH AR CHLÉ or FÉACH AR DHEIS respectively may be used as an alternative) painted on the carriageway in 300mm white letters, accompanied by a white arrow pointing in the relevant direction. It is usually provided at sites where pedestrians are encouraged to cross.

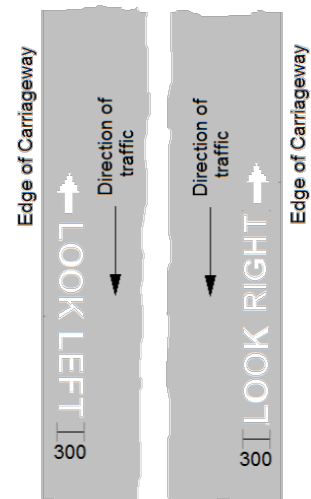

M 107: LOOK LEFT/RIGHT Marking

Permitted Variants:	1. The wording shall be LOOK LEFT, LOOK RIGHT, or FÉACH AR CHLÉ, FÉACH AR DHEIS.
---------------------	--

ARROWS

Lane Indication Arrows (RRM 004 to RRM 006, M 124 to M 126)

- 7.5.12 Figures 7.24 and 7.25 illustrate the two-Lane Indication Arrow types prescribed for use. Generally, with speeds of 60km/h or less, the arrow types shown in Figure 7.24 should be used. On faster roads the 5m arrows shown in Figure 7.25 are more appropriate.
- 7.5.13 On the approaches to junctions, Lane Indication Arrows may be used to give drivers advance indication of the correct lane to take. This is particularly important on the approaches to busy multi-lane junctions. Traffic must proceed in the direction of the arrow provided. However, careful judgement is needed to ensure that such markings are not used inappropriately, as this can reduce the flexibility of lane usage.
- 7.5.14 Normally two-Lane Indication Arrows should be used in sequence in each lane, occasionally three. The one nearest the junction should be between 15m and 25m from the Stop Line or entrance to the junction. For speeds of up to 60km/h the second arrow should be 30m to 50m further back from the first and a third arrow, if used, should be 30m to 50m back from the second. At speeds greater than 60km/h, these distances may be increased to the equivalent of 3 seconds travel time. The direction of each arrow head may be varied to suit the circumstances, but no more than two directions may be shown on any one arrow stalk.
- 7.5.15 On two lane approaches to a junction the arrangement of arrows indicating the lanes for straight ahead, left-turn and right-turn will depend on the relative traffic volumes making the movements and on the site conditions. Where, for instance, there is a very heavy right turn movement, the straight ahead and left-turn arrows should be combined in the nearside lane. Similarly, where there is a left filter arrow in a traffic signal installation, the filter lane should be marked by the left arrow marking alone in order to exclude non-filtering traffic.
- 7.5.16 Lane Indication Arrows may also be used to clarify the direction of traffic, for example at junctions with dual carriageways and one-way streets, as described in Section 7.2. However, care should be taken to avoid imposing conflicting requirements on the driver by the provision of inconsistent lane indication arrows and, in particular, side-by-side ahead and right-turn arrows should not be provided in the same lane on the approach to a junction

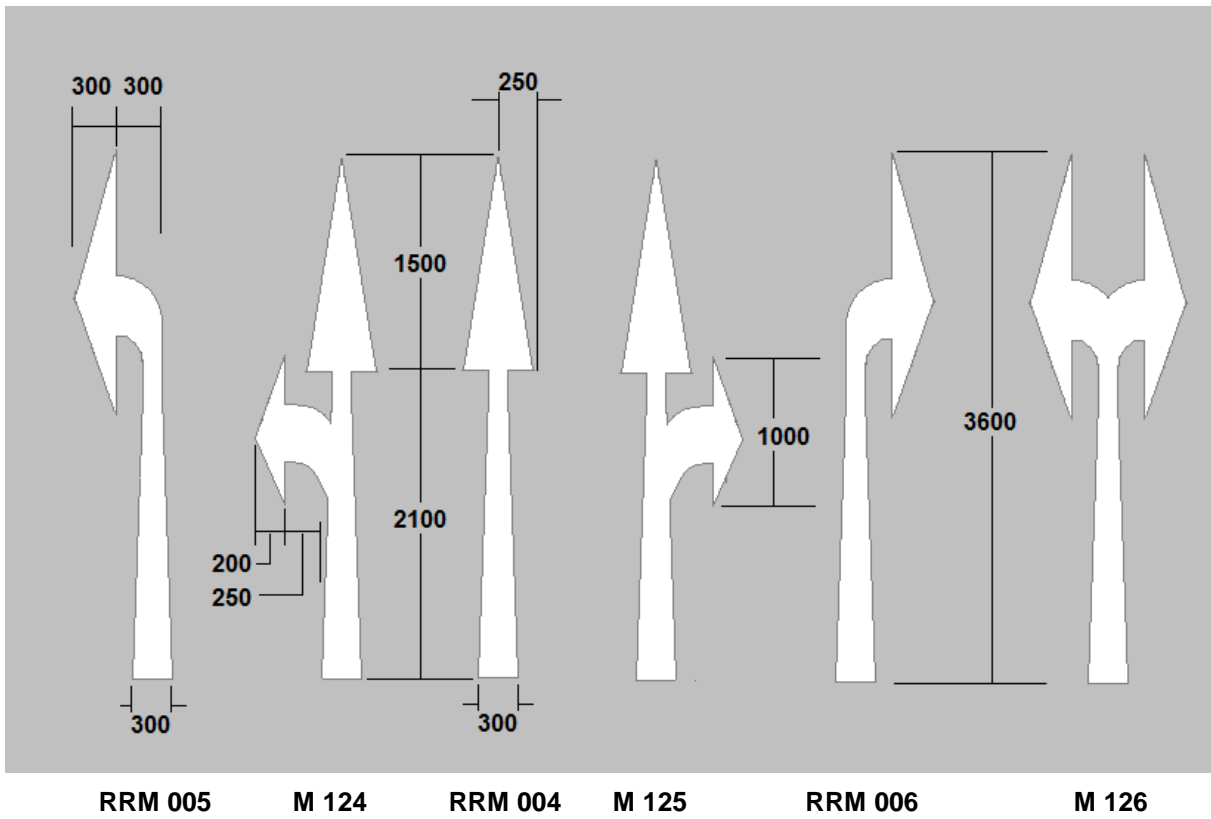

Figure 7.24:
Lane Indication Arrows ($\leq 60\text{km/h}$)

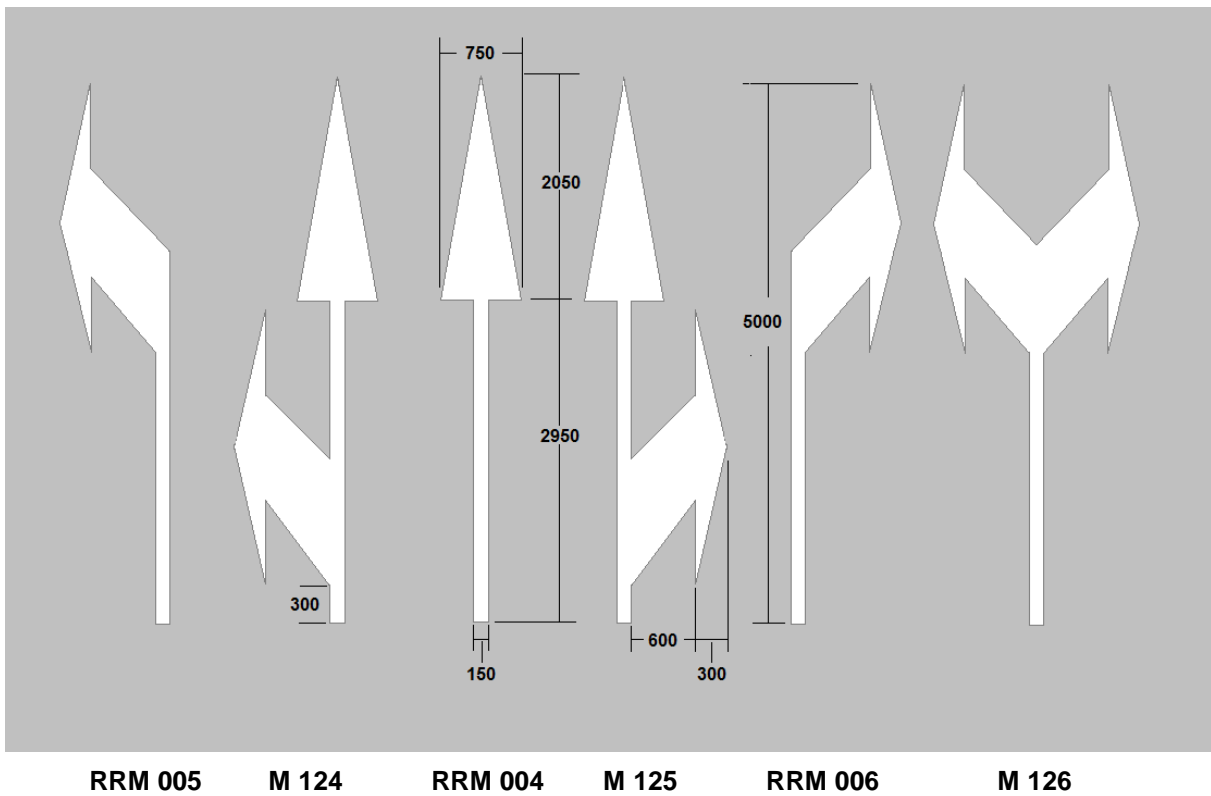
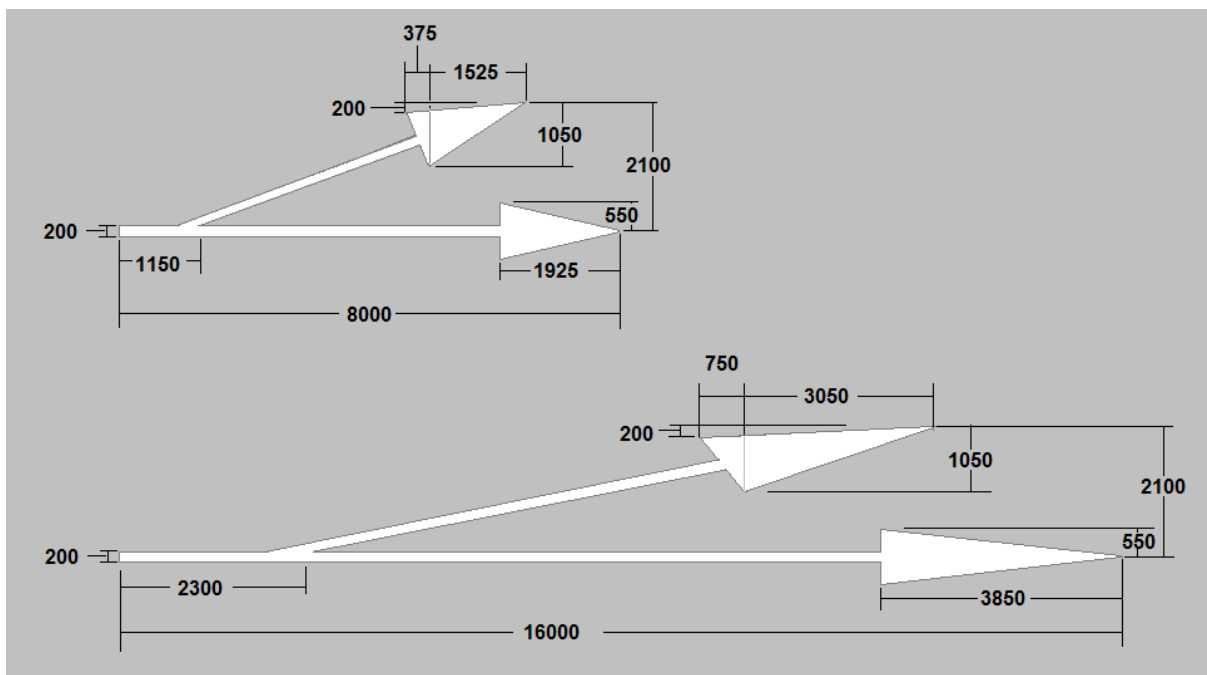

Figure 7.25:
Lane Indication Arrows ($> 60\text{km/h}$)

- 7.5.17 Bifurcation Arrows (M 102) should be provided at the commencement of deceleration lanes, and at the commencement of flares leading to dedicated turning lanes on the approaches to junctions.
- 7.5.18 Bifurcation Arrows serve to guide vehicles into the deceleration lane near its commencement ensuring that the full length of the lane is used to slow down for the junction without impeding through vehicles on the main carriageway.
- 7.5.19 The marking may be transposed to suit right turn movements into deceleration lanes in the central reserve of dual carriageways and dedicated right turn lanes on other roads.
- 7.5.20 Three sizes of Bifurcation Arrow are prescribed. The 16m arrow is generally used on motorways and high-speed dual carriageway roads, while the 8m arrow is for use on lesser roads. A 32m long bifurcation arrow (derived by doubling the longitudinal dimensions only of the 16m arrow) may be used in exceptional circumstances.



M 102: Bifurcation Arrows

Permitted Variants:	<ol style="list-style-type: none"> 1. The layout may be reversed to show diverge to the right. 2. The larger arrow may be 32m long.
---------------------	---

Deflection Arrows (M 100 and M 101)

- 7.5.21 Deflection arrows (M 100 and M 101) may only be used:
- Where there is a lane loss, e.g. end of a climbing lane or start of a bus lane.
 - In advance of a central hatched area, e.g. start of a climbing lane or a right turn lane.
- 7.5.22 The size of the Deflection Arrow is determined by the speed of the road. The 6m long marking is generally used for speeds of 60km/h or less and the 9m marking is used on higher speed roads, although it can also be used where greater emphasis is required.
- 7.5.23 The Deflection Arrow is positioned at 1 sec (28m @100km/h) in advance of the end of the lane or Continuous line, a second arrow is positioned at 2 sec (56m @ 100km/h) travel time in advance of the first arrow and a third arrow, if required, is positioned a further 2 sec travel time in advance of the second arrow.
- 7.5.24 The use of the Deflection Arrows is described in Sections 7.3 and 7.7. Although these are non-regulatory markings, it must be stressed that they should not be used in circumstances other than those described in the relevant sections. In particular, they should not be used for the purposes of providing advance warning of a bend

Two-Lane Arrows (M 103)

- 7.5.25 At the start of either a passing lane section on a Type 3 Dual Carriageway road or a climbing lane on a single carriageway road, a Two-Lane Arrow, M103, may be provided to indicate that vehicles may now overtake

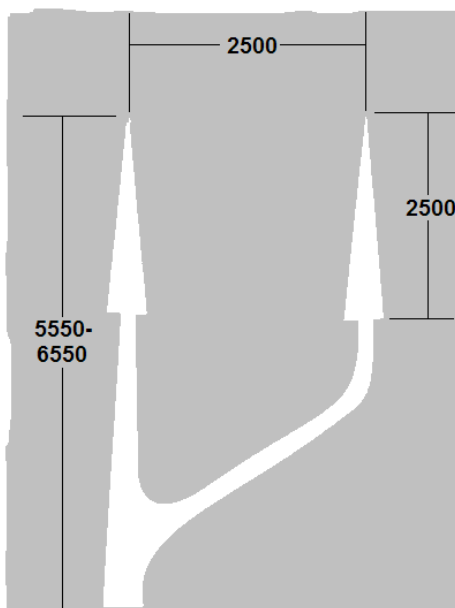

M 103 Two-Lane Arrow

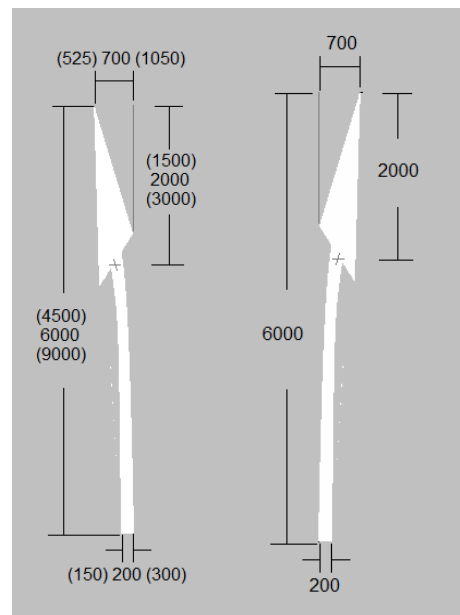

**M 100 & M 101:
Deflection Arrows**

LANE DESTINATION MARKINGS (M 105)

- 7.5.26 Worded Lane Destination Markings (M 105), repeating the route information shown on Advance Direction Signs, may, with advantage, be marked on the carriageway on the approaches to heavily trafficked junctions. The 1600mm elongated font shown in Appendix 7A should be used. Lane Destination Markings will normally be used in conjunction with the 3.6m Lane Indication Arrows, as at speeds greater than 60km/h the legends would not be readable. Besides indicating the correct lane to take, the markings also provide drivers with a useful supplementary indication to the Advance Direction Sign in the event of the latter being obstructed by tall vehicles.
- 7.5.27 For clarity, and avoidance of large areas of thermoplastic material on carriageways, it is recommended that only route numbers be marked in this way. To increase legibility on multi-lane approaches, the destinations may optionally be staggered.
- 7.5.28 The provision of Lane Destination Markings should normally commence as far back from the junction as the longest peak hour traffic queues, unless intervening junctions would lead to confusion. They may be repeated at intervals between this point and the associated Stop or Yield Line, in accordance with Paragraph 7.5.14, but in locations where heavy congestion is common the distance between successive markings may be reduced to less than 15m.
- 7.5.29 Lane Destination Markings are also available to show Airport (M 127) or Ferry Port (M 128) destinations. The larger size for the airport symbol is for use on motorways and high-quality dual carriageways.

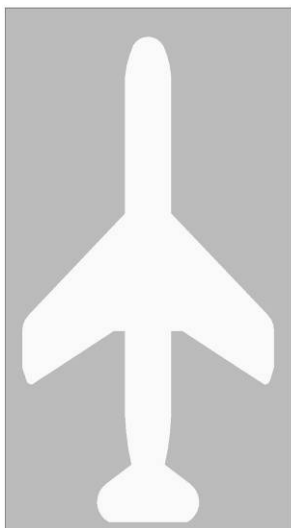

**M 127 (4800 x 2400)
Airport Symbol**



**M 127 (2400x 2400)
Airport Symbol**

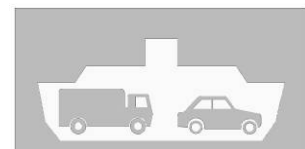

**Figure 7.30:
Markings Indicating
the Start of a Bus
Lane**

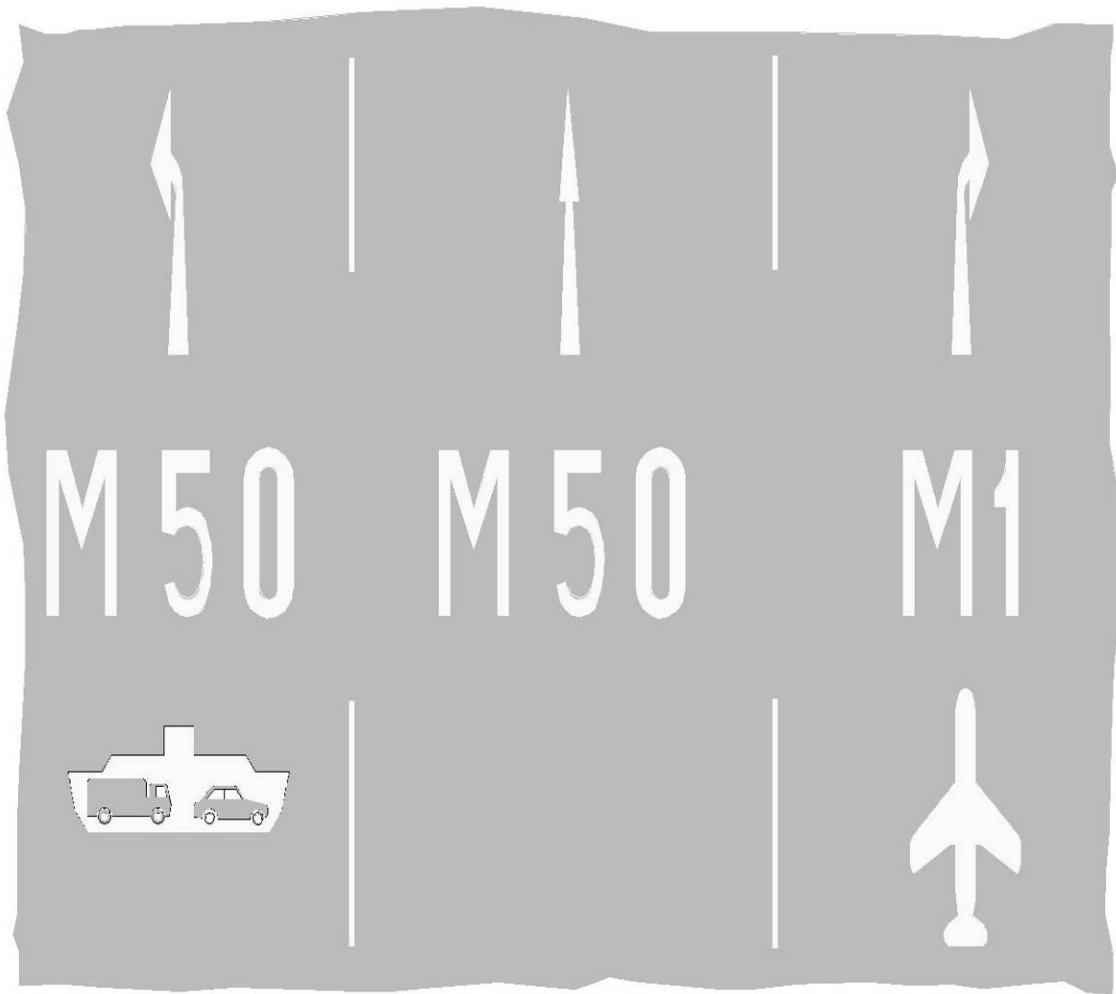

**M 105:
Typical Lane Destination Markings**

Permitted Variant:	The road numbers, arrows, symbols and text may be varied as required.
--------------------	---

Note: Lane Indication Arrows and Ferry and Airport Symbols also shown.

SCHOOL KEEP CLEAR MARKING (RRM 010)

- 7.5.30 The School Keep Clear Marking (RRM 010) consists of the word "SCOIL" painted on the carriageway in 700mm yellow letters with a zigzag pattern of yellow lines, the overall length of which should not be less than 14.6m (1¼ zigzag markings each side of the SCOIL wording). The overall length of the marking may be increased by increments of 6m by the addition of a complete zigzag pattern on each side of the marking (i.e. overall lengths of 14.6m, 20.6m, 26.6m, 32.6m and 38.6m) up to a maximum length of 38.6m. A vehicle may not stop or park where this marking is provided.
- 7.5.31 The length of the marking needs to be restricted to one which drivers will respect. Where a Road Authority wishes to lay a marking with an overall length greater than the maximum 38.6m, e.g. where the marking is to extend across two entrances which are wide apart, then two markings of any of the standard lengths may be joined together, omitting the transverse bars at the join to form one continuous marking.
- 7.5.32 Where two separate markings (either single or double as described above) are required to be laid in close proximity for school entrances on the same side of a length of road, a clear space of at least 7m must be left between the markings.
- 7.5.33 The marking should not normally be placed on both sides of the road but only the side on which the school entrance is situated.
- 7.5.34 The markings should not be laid in the controlled areas on the approaches to pedestrian crossings.
- 7.5.35 It is not intended that the markings be used outside all schools, but only where there is a clear need for them because of the hazard to school children due to parked vehicles.

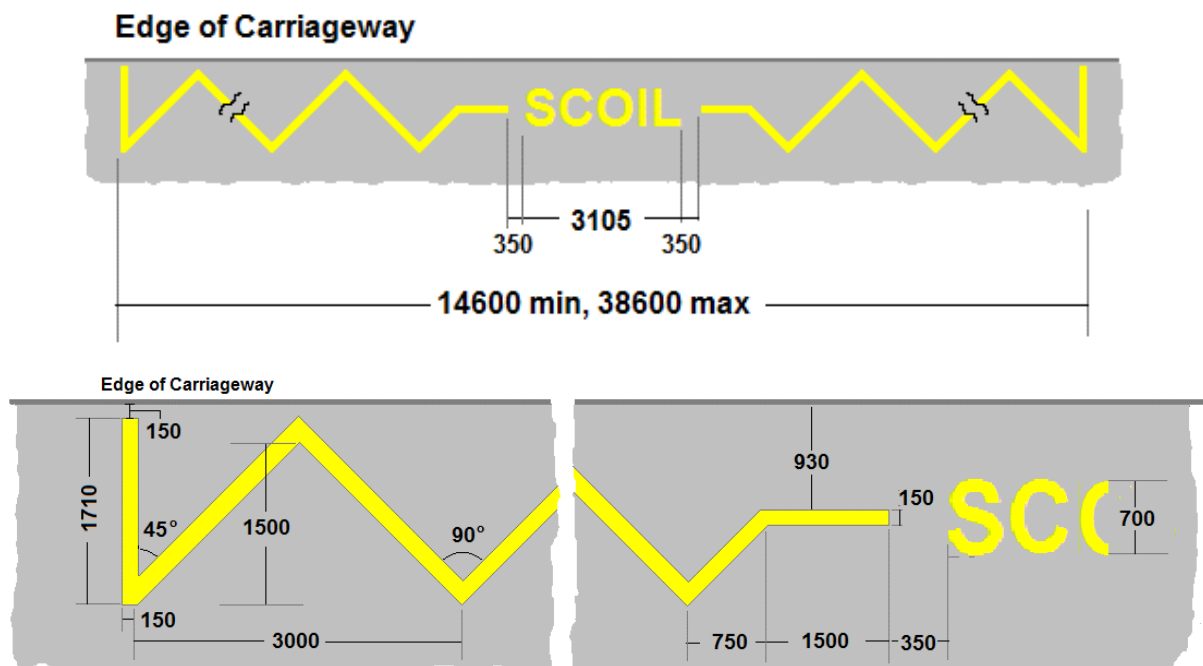

RRM 010: School Keep Clear Marking

SCHOOL WARDEN CROSSING PATROL POINT (M 121)

- 7.5.36 Where it is required to indicate the location of a School Warden Crossing Patrol Point, marking M 121 may be provided.
- 7.5.37 It is possible that markings M 121 will be used in the vicinity of RRM 010, School Keep Clear. Figure 7.26 illustrates how the two markings may be incorporated in such circumstances.

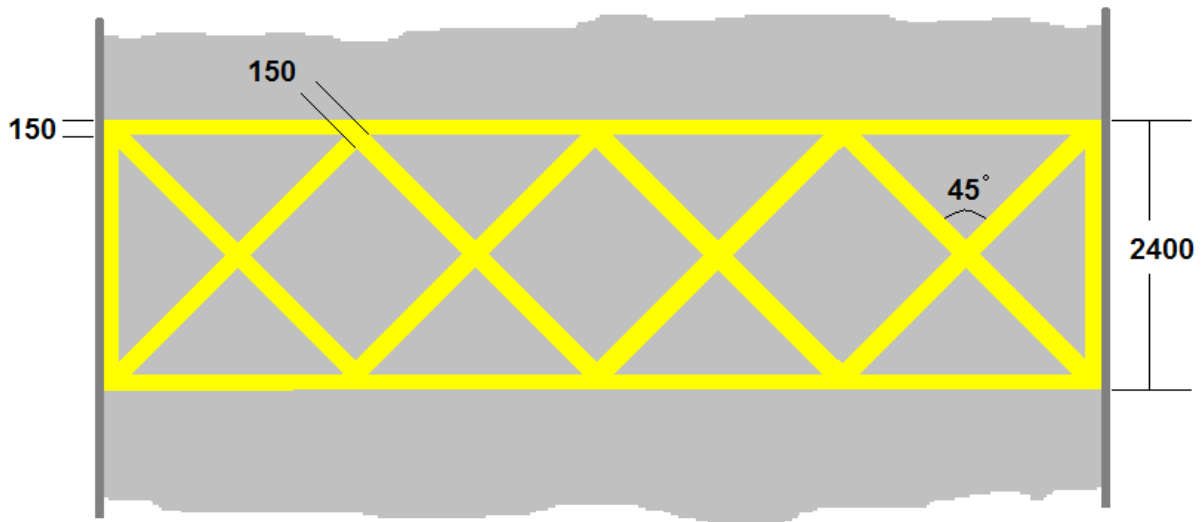

**M 121:
School Warden Crossing Patrol Point Marking**

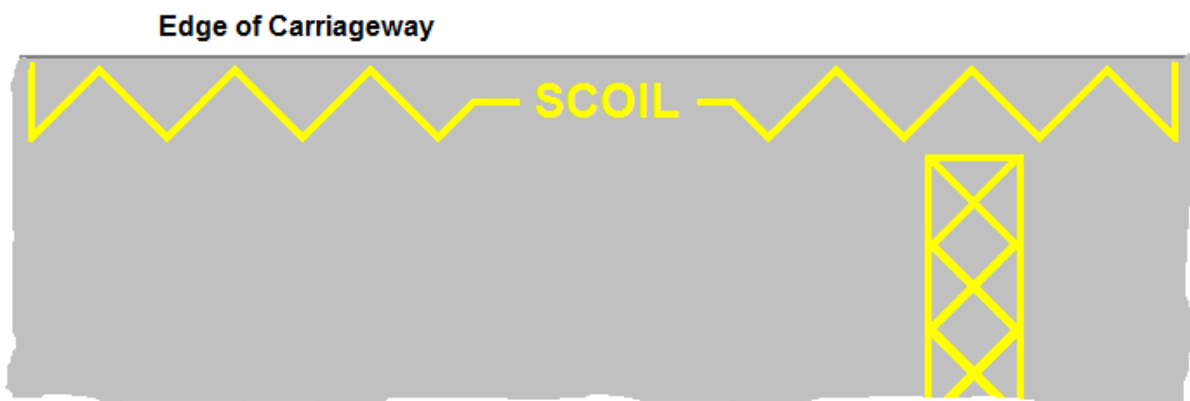

**Figure 7.26:
Combination of RRM 010 and M 121 Markings**

SPEED MARKINGS (M 108)

- 7.5.38 An indication of the mandatory speed limit may be placed on the carriageway using the marking M 108. The marking may be varied to suit the speed limit in force. This marking must not be used to indicate a cautionary speed.
- 7.5.39 The marking may be used where a speed limit changes, or in conjunction with upright repeater signs. It should only be used in situations where it is necessary to reinforce the upright signing for reasons of safety, such as the entrance to a village or where an unexpected reduction in speed limit occurs.
- 7.5.40 The size of the marking should be appropriate to the approach speed of traffic, the larger marking being used where approaching traffic is subject to a speed limit of greater than 50km/h.

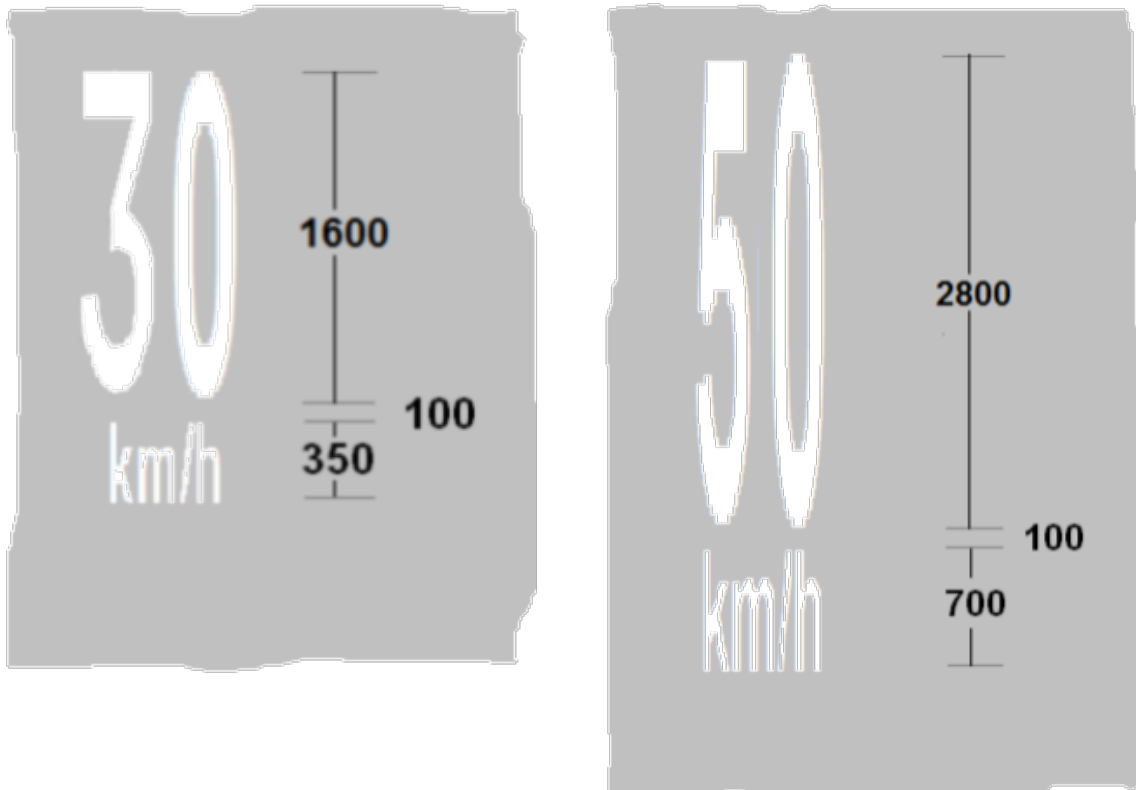

**M 108:
Speed Markings**

Permitted Variant:	Speed may be 30, 50, 60, 80 or 100km/h.
--------------------	---

EMERGENCY TELEPHONE AND CHAINAGE MARKINGS (M 120)

- 7.5.41 On motorways and high-speed dual carriageways, it may be desirable to provide an indication of the direction to the nearest emergency telephone. Additionally, chainage markings can aid the identification of the precise location. This is especially useful in the event of emergency incidents.
- 7.5.42 Marking M 120 may be provided on the hard shoulder at intervals of 100m. The figures indicate the road number, the direction of travel of that carriageway and the chainage (in the example, the marking is on Route 4, Northbound carriageway, at chainage 267.5km), and the arrow points in the direction of the nearest emergency telephone. See Chainage Marker Plates in Chapter 4.
- 7.5.43 To avoid confusion when providing this information to the emergency services, it is recommended that the chainage for each carriageway be measured from the same end of the road

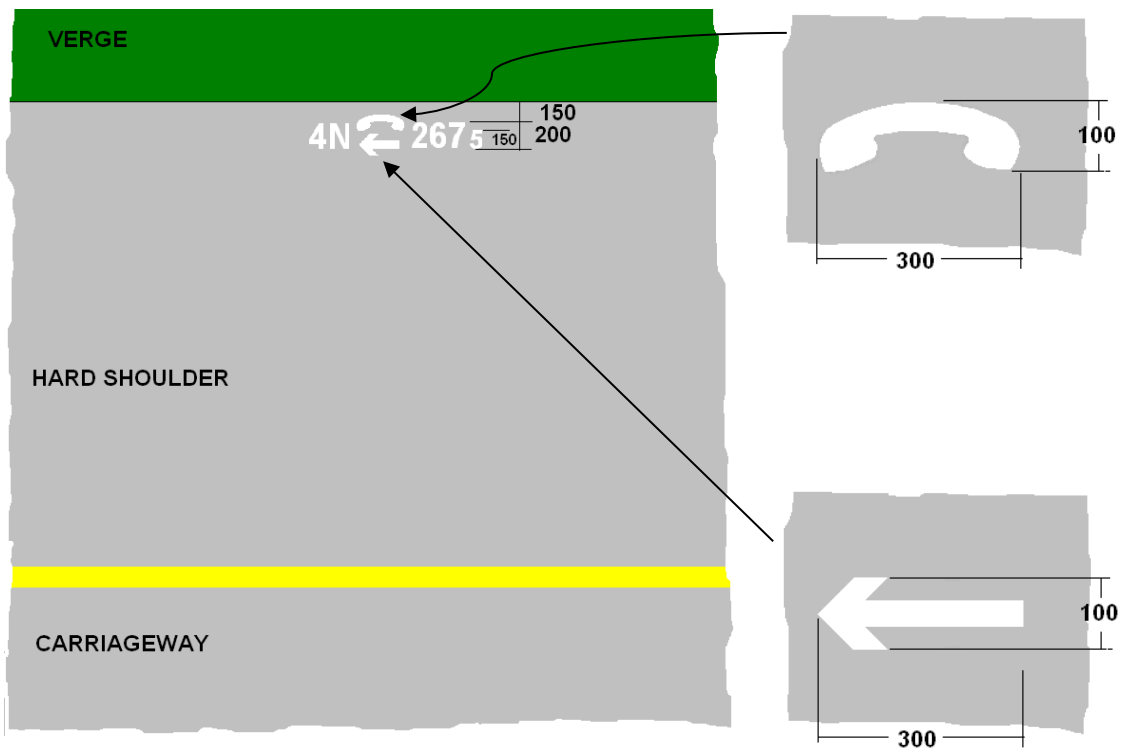

M 120: Chainage and Emergency Telephone Marking

Permitted Variants:	<ol style="list-style-type: none"> 1. The chainage, direction, and orientation of the arrow may be varied as required. 2. The telephone symbol and arrow may be omitted on non-motorway locations or elsewhere where emergency telephones are not provided.
---------------------	---

7.6 Parking Restrictions and Parking Bays

PARKING RESTRICTIONS

- 7.6.1 Yellow lines at the edge of the carriageway are used to define the extent of parking prohibitions or restrictions. Where appropriate, the lines must be supplemented by the regulatory signs described in Chapter 5.

Parking Restrictions – Single Yellow Line (RRM 007)

- 7.6.2 A continuous Single Yellow Line (RRM 007) indicates that parking of vehicles is prohibited or restricted at certain times on that side of the road. The line shall be 100mm wide extending along the edge of a roadway and situated approximately 150mm to 300mm from that edge.
- 7.6.3 The prohibition or restriction, e.g. the times and days, must be displayed on signs as described in Chapter 5.

Parking Restrictions - Double Yellow Line (RRM 008)

- 7.6.4 A continuous Double Yellow Line (RRM 008) indicates that parking of vehicles is prohibited at any time on that side of the road. The line shall consist of two parallel continuous yellow lines approximately 100mm apart extending along the edge of a roadway, each line being approximately 100mm wide and the line nearest the edge of the roadway being situated approximately 150mm to 300mm from that edge.
- 7.6.5 There is no requirement to provide upright signs to supplement this marking. However, it should be noted that if the double yellow line is laid to reinforce the standard prohibition on stopping within 5m of a road junction, this may lead to misinterpretation that loading is generally permitted.

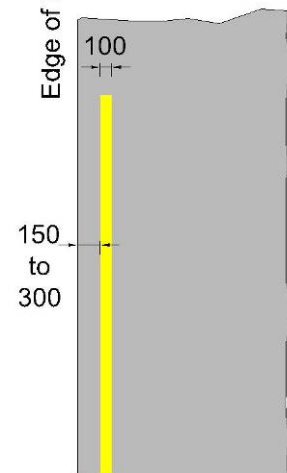
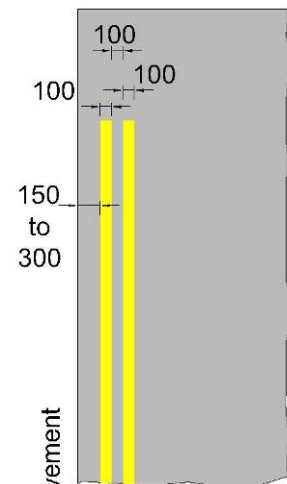

**RRM 007
and
RRM 008:
Parking Restriction
Markings**

PARKING BAYS

7.6.6 Five patterns of parking bay marking are prescribed, three to indicate the limits for parallel parking, one for perpendicular parking and one for angled parking bays. All of these markings may be used outside or inside controlled parking zones. The markings consist of 50mm wide white lines in all cases.

Parallel Parking (RRM 011, RRM 012 and RRM 016)

7.6.7 Three types of marking are prescribed for parallel parking:

- Individual parking bays, RRM 011;
- Individual parking bays with buffer zones, RRM 012; and
- Continuous parking not marked into individual bays, RRM 016.

7.6.8 In all cases, two continuous terminal markings 100mm apart indicate the limits of the length of road reserved for vehicle parking. A single continuous transverse line should be used to mark the ends of individual parking spaces (RRM 011 and RRM 012). Where individual bays are not demarcated (RRM 016) a continuous longitudinal line marks the outer edge of the parking area. Where appropriate, parking signs (RUS 018 and/or RUS 019) should be mounted at the kerbside to indicate the extents and periods during which parking is permitted and/or prohibited.

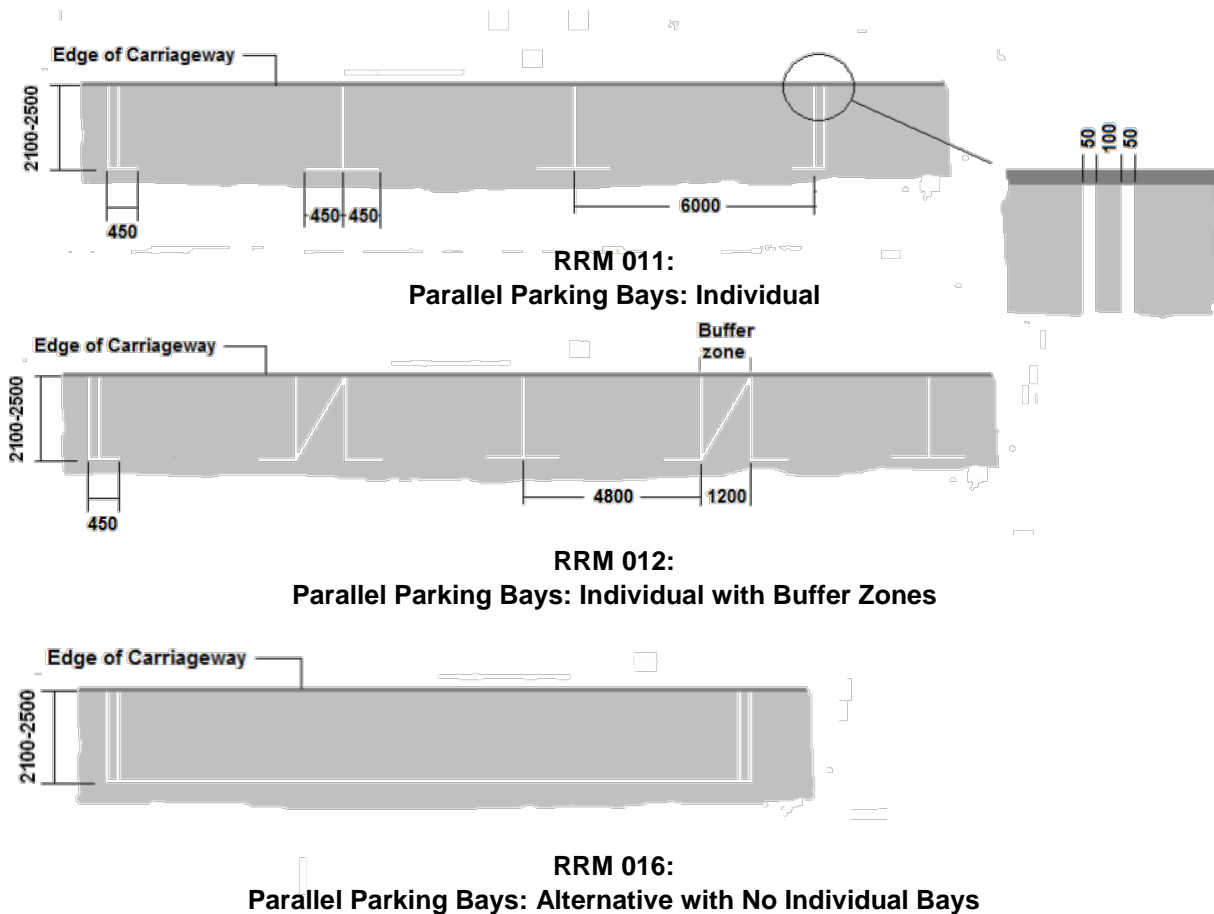

Perpendicular and Angled Parking (RRM 013 and RRM 014)

7.6.9 The markings for Perpendicular Parking (RRM 013) and Angled Parking (RRM 014) differ only in the angle of the markings to the kerb. Individual parking bays are marked, at an angle to the kerb which may be varied from about 30 to 90 degrees according to the width of road available. It should be noted that the width of each bay (2400mm) is non-prescriptive and is given as a preferred bay width.

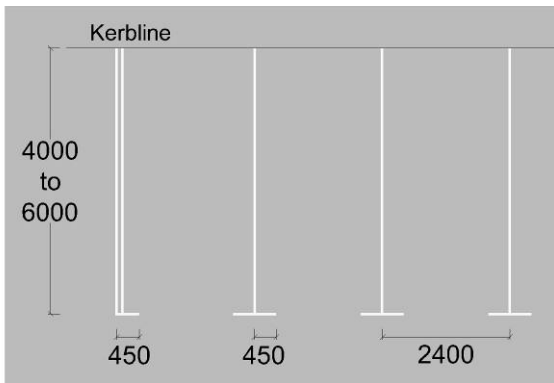

RRM 013:
Perpendicular Parking Bay Markings

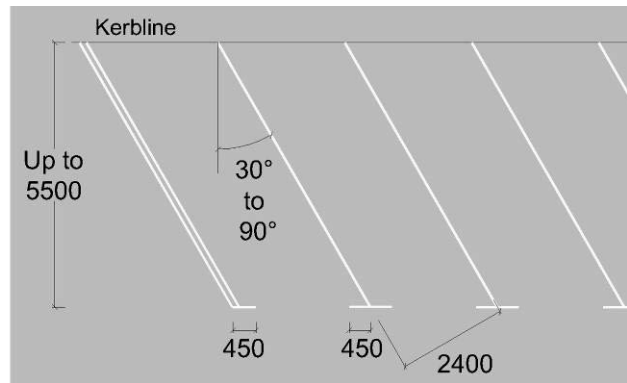

RRM 014:
Angled Parking Bay Markings

Permitted Variant:	The width of parking bays may be varied to suit specific site conditions.
--------------------	---

Disabled Persons' Parking (RRM 015)

7.6.10 Parallel, angled or perpendicular Disabled Persons' Parking Bays may be provided in isolation, or as part of a series of parallel, angled or perpendicular parking bays. The dimensions of disabled persons' bays are shown in Figure 7.27, together with examples of how the markings may be incorporated with adjacent parking bays.

7.6.11 Care should be taken to ensure that adequate space is provided between a disabled persons' parking bay and adjacent parking bays to permit a wheelchair to be manoeuvred safely. It is recommended that buffer zones be provided as shown to permit easy access. Note that when two or more disabled persons' parking bays abut, the buffer zone between them can be shared.

7.6.12 Disabled persons' parking bays shall be indicated by the Disabled Persons' Parking Bay Symbol, RRM 015, marked in white and located on the outer edge of each bay, and may be accompanied by the upright Disabled Persons' Parking information sign (F 205 – see Chapter 4). The bays may also have blue surfacing applied within the limits of the bay, but this should not be extended into the adjacent carriageway or any buffer zones. The provision of dropped kerbs should also be considered to enhance accessibility.

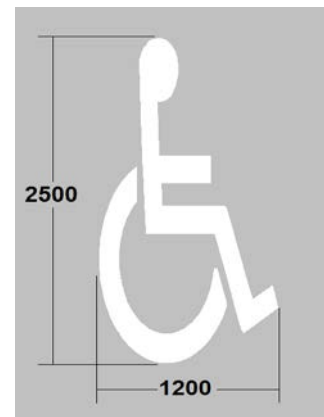

RRM 015:
Disabled Persons' Parking Bay Symbol

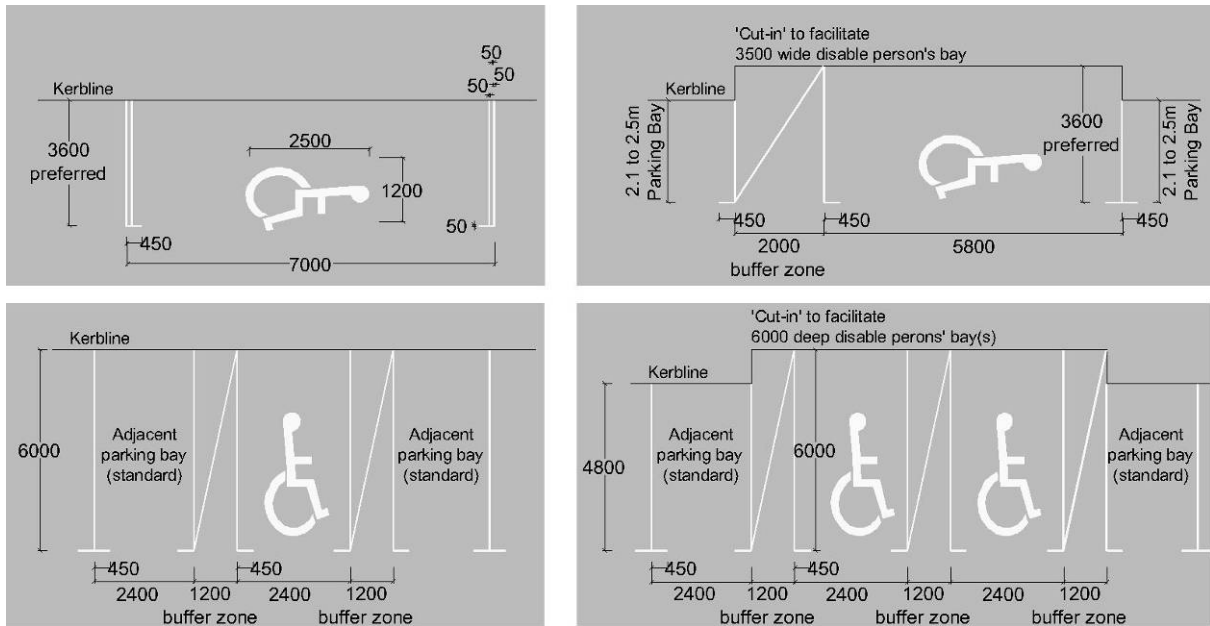
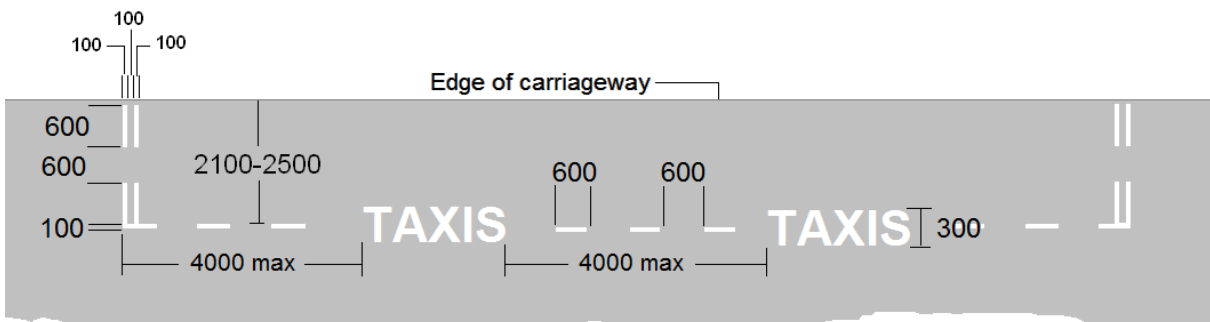

Figure 7.27: Typical Examples of Disabled Persons' Parking Bays

TAXI STAND (RRM 029)

7.6.13 A Taxi Stand is indicated by the markings to RRM 029 shown below. The lines forming the taxi stand shall be white and 100mm wide. The wording 'TAXIS' shall appear at least once in each stand, repeated at intervals of not more than 4m, and shall be parallel to the kerb and facing towards the centre of the roadway. The terminal points of the taxi stand shall be indicated by double broken markings consisting of 600mm lines and 600mm gaps perpendicular to the kerb.



**RRM 029:
Taxi Stand Markings**

LOADING BAY (RRM 009)

7.6.14 A Loading Bay is indicated by the markings to RRM 009 shown below. The lines forming the loading bay shall be white and 100mm wide. The wording 'LOADING' shall appear at least once in each loading bay but shall be repeated on bays greater than 10m in length and shall be parallel to the kerb and facing towards the centre of the roadway. The terminal points of the loading area shall be indicated by double continuous lines perpendicular to the kerb.

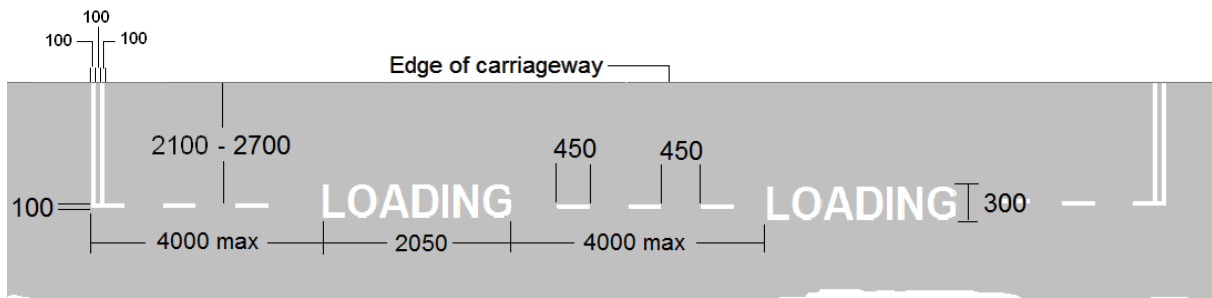

RRM 009:
Loading Bay Markings

ELECTRIC VEHICLE RECHARGING BAY (RRM 034)

7.6.15 An Electric Vehicle Recharging Bay is indicated by road marking RRM 034, marked in white and located on the outer edge of each bay and should be accompanied by the upright Electric Vehicle Parking Bay regulatory sign (RUS 020a – see Chapter 5). The bays may also have green surfacing applied within the limits of the bay, but this should not be extended into the adjacent carriageway or any buffer zones.

7.6.16 Parallel, angled or perpendicular Electric Vehicle Recharging Bays may be provided in isolation, or as part of a series of parallel, angled or perpendicular parking bays. The dimensions of such bays are shown in Figure 7.27, together with examples of how the markings may be incorporated with adjacent parking bays.

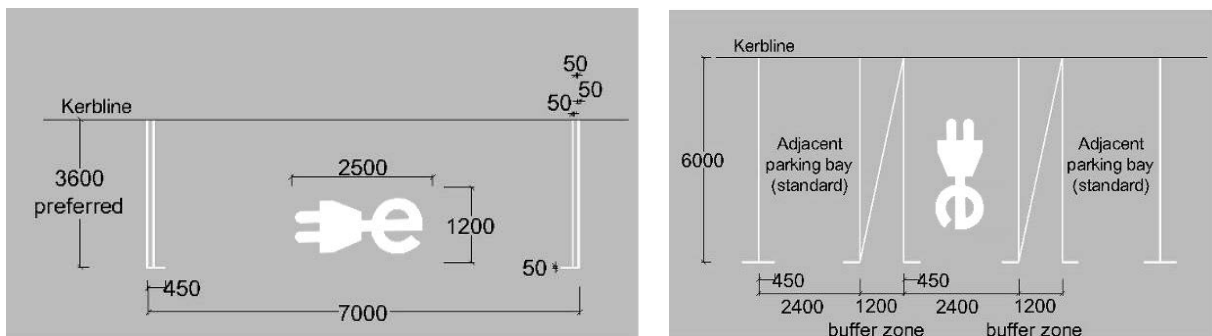

RRM 034:
Electric Vehicle Recharging Bay Markings

7.7 Bus and Tram Markings

BUS STOP (RRM 030)

- 7.7.1 Bus Stop Markings, RRM 030, shall only be used to indicate the location of a bus stop, where they supplement a kerbside upright Bus Stop Sign (RUS 031), or to indicate the location of a bus stand. They indicate the area within which vehicles other than buses may not stop or park.

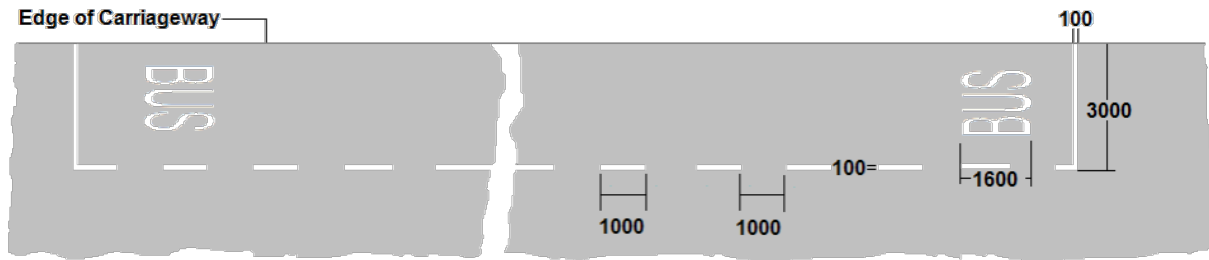

**RRM 030:
Bus Stop Markings**

- 7.7.2 It is important that buses should be able to dock parallel to and close to the kerb, to assist passengers, particularly those with a mobility handicap, to board and alight with ease. This can frequently be made difficult, especially in urban areas, by a variety of factors, some of which may be overcome by careful design.
- 7.7.3 The major factor in achieving parallel docking at a bus stop is the entry and exit distance required. At a typical roadside bus stop, a conventional 12m European standard bus requires a minimum overall clearance of 37m of unimpeded access (see Figure 7.28); an articulated bus needs 49m. Vehicles parked or loading adjacent to the bus stop can result in buses failing to achieve parallel docking or having to stop too far from the kerb, requiring passengers to step into the carriageway to board and alight.

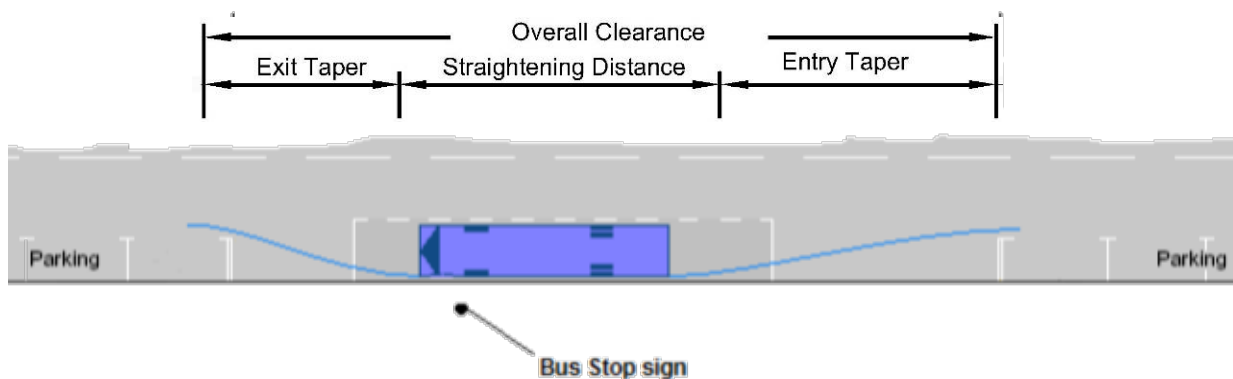

**Figure 7.28:
Clearance at Bus Stop Required for Parallel Docking (12m Rigid Bus)**

- 7.7.4 The extent of the bus bay marking should, therefore, be determined after careful consideration of the site, including demands for kerbside parking and loading activities. It is suggested that the parking and loading restrictions adjacent to bus stops should be reviewed to ensure that the bus stop is accessible to buses throughout their operating period.
- 7.7.5 There are instances where site conditions make a short Bus Stop Marking acceptable, for example where a bus boarder has been constructed to minimise the impact of the bus stop on frontage parking (see Figure 7.29). In these cases, the bus bay marking should be no shorter than the length of the bus type that uses it (12m in the case of a standard bus).

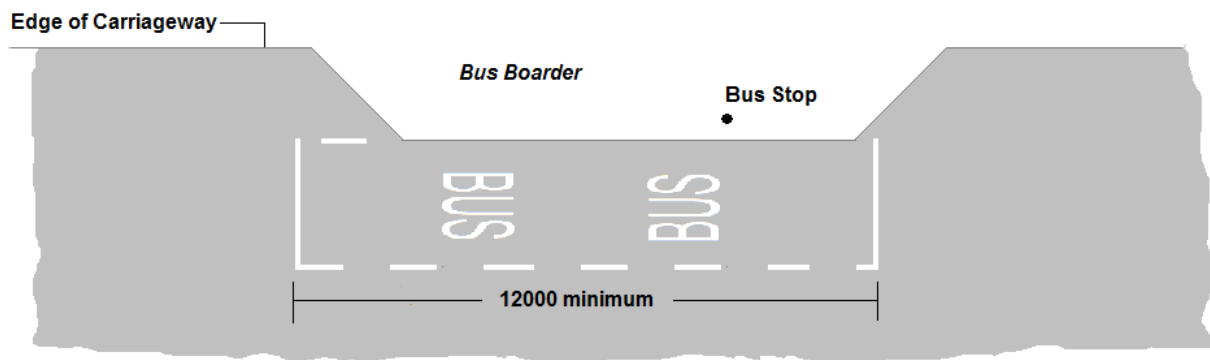

Figure 7.29:
Bus Stop Marking at a Bus Boarder

BUS LANES

7.7.6 Bus lanes may be either 'with-flow' or 'contra-flow', and the markings used in each case are described in the following paragraphs. The associated regulatory signs are shown in Chapter 5.

7.7.7 The edge(s) of the bus lane that segregate(s) it from lanes of general traffic shall be marked by a continuous white Bus Lane Line, part of RRM 024, which shall be 250mm wide.

With-Flow Bus Lanes

7.7.8 A 250mm wide Broken Bus Lane Line, M 129, shall be laid from the kerb to the start of the full width lane to deflect other traffic from the bus lane (see Figure 7.30). The taper at which the line is laid should not normally exceed 1:10, but in exceptional cases may be reduced to 1:5.

7.7.9 Where general traffic has to be deflected to the right, Right Deflection Arrows, M 101, shall be provided on the nearside lane about 15m and 30m in advance of the start of the bus lane.

7.7.10 Where a bus lane commences just beyond a junction, adequate length should be left for the taper to commence at the junction so that the inclined line does not extend across the junction mouth.

7.7.11 The legend LÁNA BUS, part of RRM 024, shall be marked on the carriageway across the lane close to its start and repeated after each junction. Where junctions are more than 300m apart this legend should be repeated between junctions at approximately 150m intervals.

7.7.12 Where a side road joins on the nearside of the road, the Continuous Bus Lane Line, part of RRM 024, should be discontinued across the junction or, if required, replaced with a Broken Bus Lane Line, M 129, across the junction.

7.7.13 Beyond each junction carrying emerging traffic, a curved Broken Bus Lane Line, M 129, should be provided across the bus lane to continue the line of a normal left-turn out of the side road (see Figure 7.32).

7.7.14 The Continuous Bus Lane Line should end in advance of any junction with a major left-turning flow, to allow traffic to position itself correctly on the carriageway. The continuous line should be replaced by a Broken Bus Lane Line with a double-headed Bus Lane Ends Arrow variant, M 130L, placed to inform motorists that it is permissible to enter the bus lane prior to making the left-turn.

7.7.15 At the end of a bus lane, a double-headed Bus Lane Ends Arrow, M 130, should be provided to indicate that the nearside lane may be used by all traffic. In cases where the nearside lane is restricted to left turning traffic, the left-turn variant M 130L should be used. If the offside lane becomes a right-turn only lane, the right turn variant M 130R should be used.

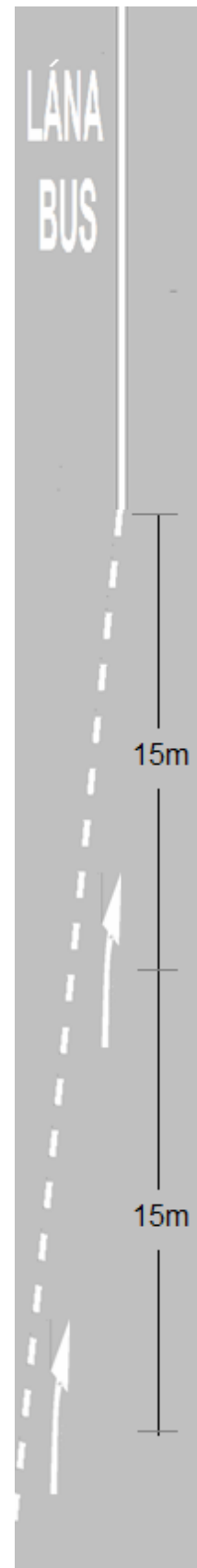
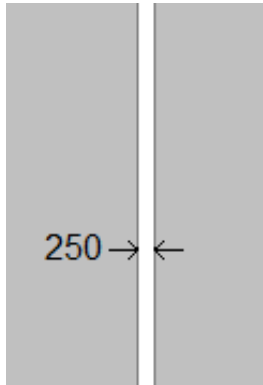

Figure 7.30:
Markings Indicating
the Start of a Bus Lane

7.7.16 In cases where obstruction by other traffic makes it difficult for buses to re-enter the general traffic stream at the end of a bus lane, Yellow Box Markings (RRM 020) may be provided as shown in Figure 7.31 (see also Section 7.9).

7.7.17 A composite sketch showing typical treatment for a with-flow bus lane is shown in Figure 7.32.



**Part of RRM 024:
Continuous
Bus Lane Line**

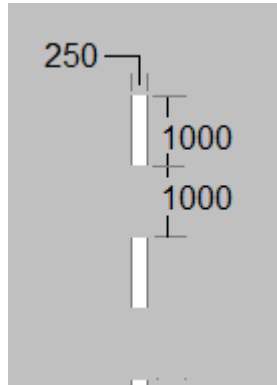

**M 129:
Broken
Bus Lane Line**

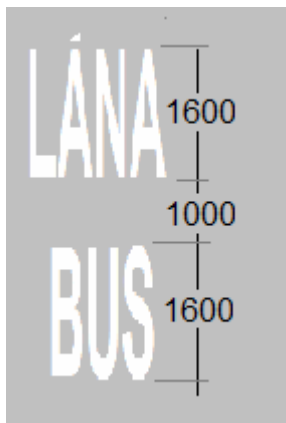

**Part of RRM 024:
Worded LÁNA BUS
Marking**

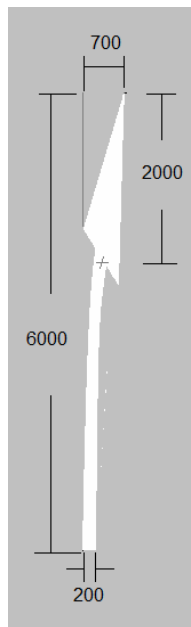

**M 101:
Right Deflection Arrow**

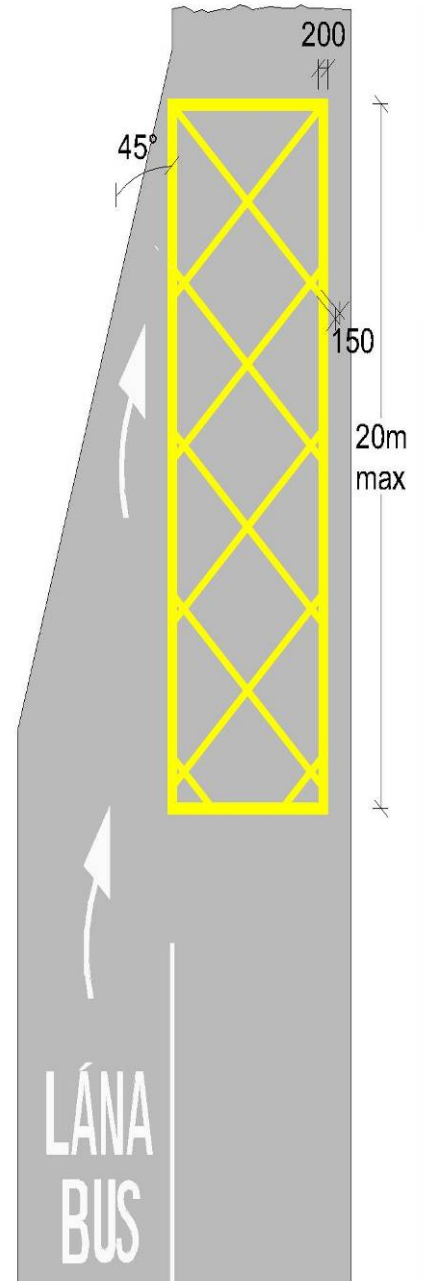

**Figure 7.31:
Yellow Box Markings at
the End of a Bus Lane**



**M 130:
Double-headed
Bus Lane Ends Arrow**

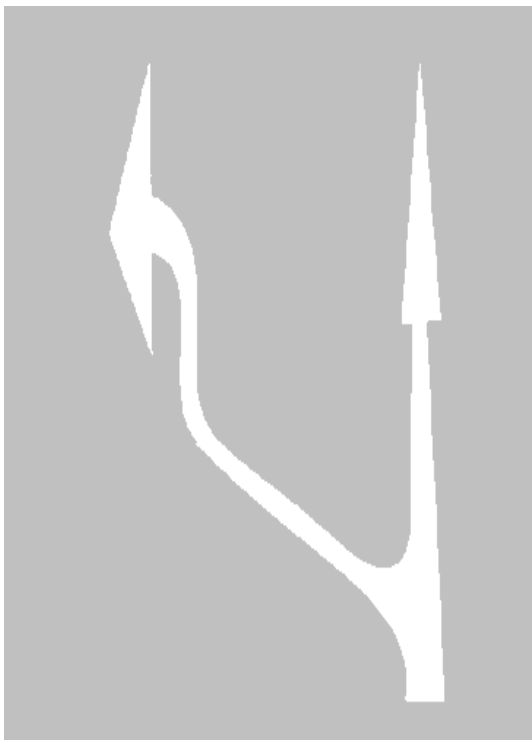

M 130L

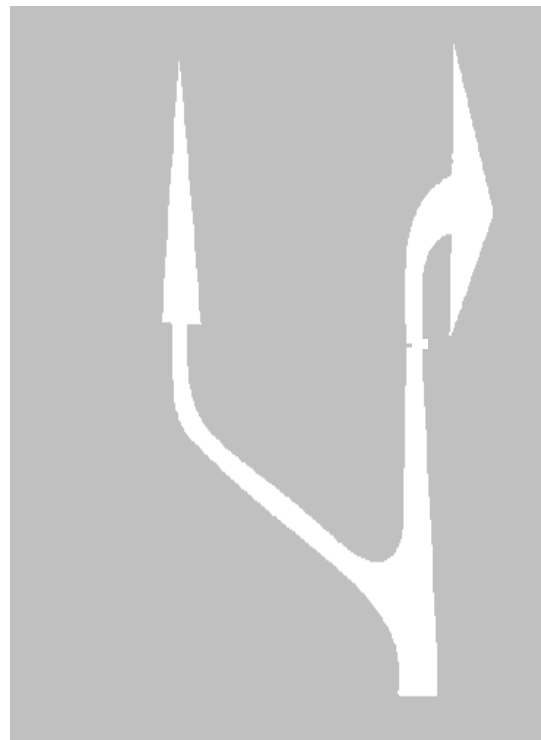

M 130R

**Left and Right Turn Variants of
Bus Lane Ends Arrow**

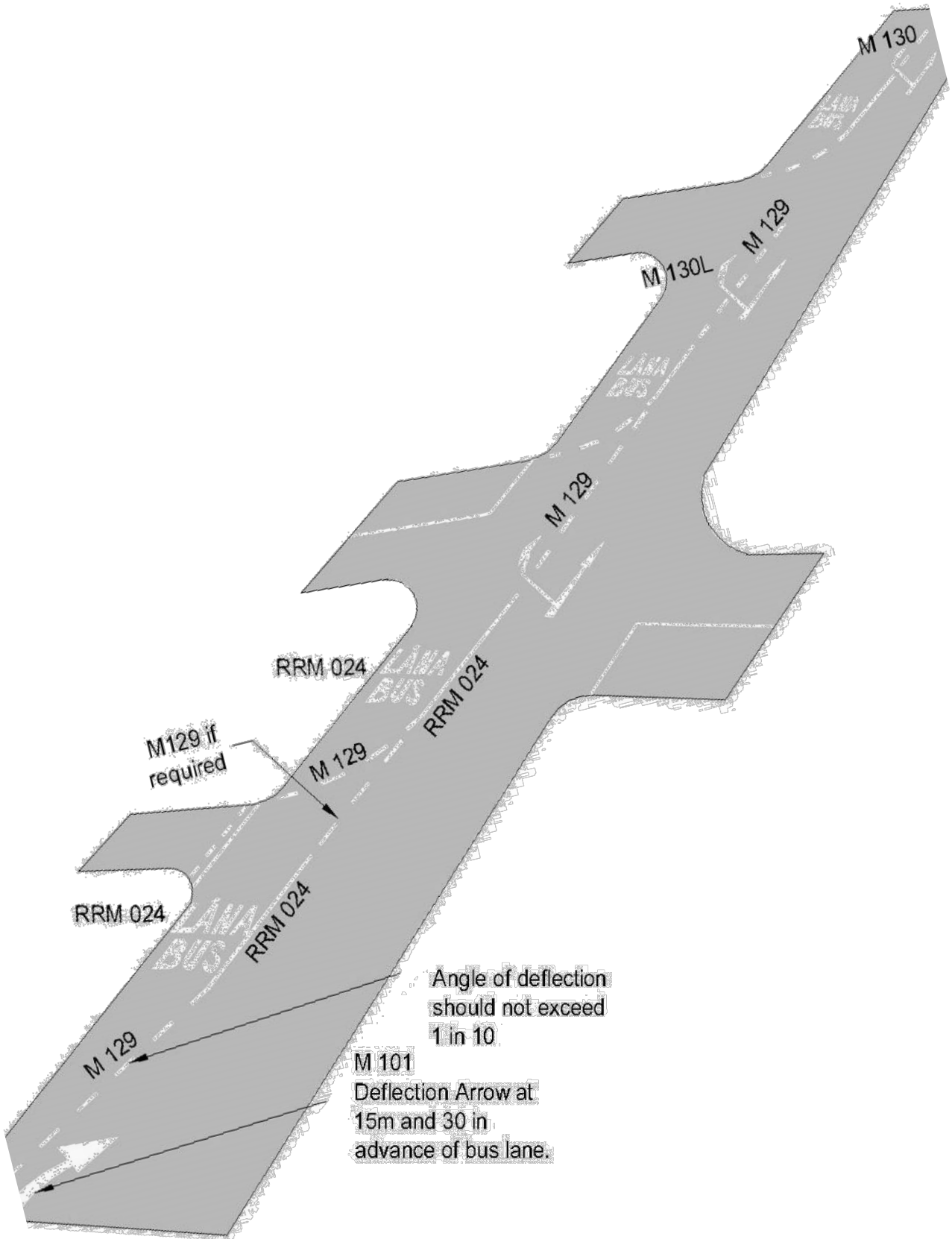

Figure 7.32:
Typical Road Markings for a With-Flow Bus Lane

Contra-flow Bus Lanes

- 7.7.18 The road markings are as described for with-flow bus lanes, with a continuous Bus Lane Line, part of RRM 024, separating the bus lane from other lanes. However, additional 'LÁNA BUS' worded markings, together with Directional Arrows, RRM 004, should be provided in such locations that they are readable by road users travelling in the direction of general traffic or joining from side roads (see Figure 7.33).
- 7.7.19 Physical separation is advisable between the contra-flow bus lane and general traffic. This can either be a continuous kerbed Island or pedestrian refuges at appropriate intervals. While ensuring that other vehicles do not enter the lane, this may introduce potential difficulties, such as:
- Causing pavement rutting if the lane is narrow; and
 - Creating difficulties for buses having to take avoiding action in emergency or breakdown.
- 7.7.20 At the beginning of a contra-flow bus lane, a No Straight Ahead sign (RUS 011) should be used with Supplementary Plate P 050, Except Buses (see Chapter 5).
- 7.7.21 Contra-flow bus lanes should not normally be less than 3.0m wide.
- 7.7.22 Directional Arrows, RRM 004, or LOOK LEFT/RIGHT Markings, M 107L/R, may be laid at pedestrian crossing points, to warn pedestrians that traffic may be approaching from both directions.

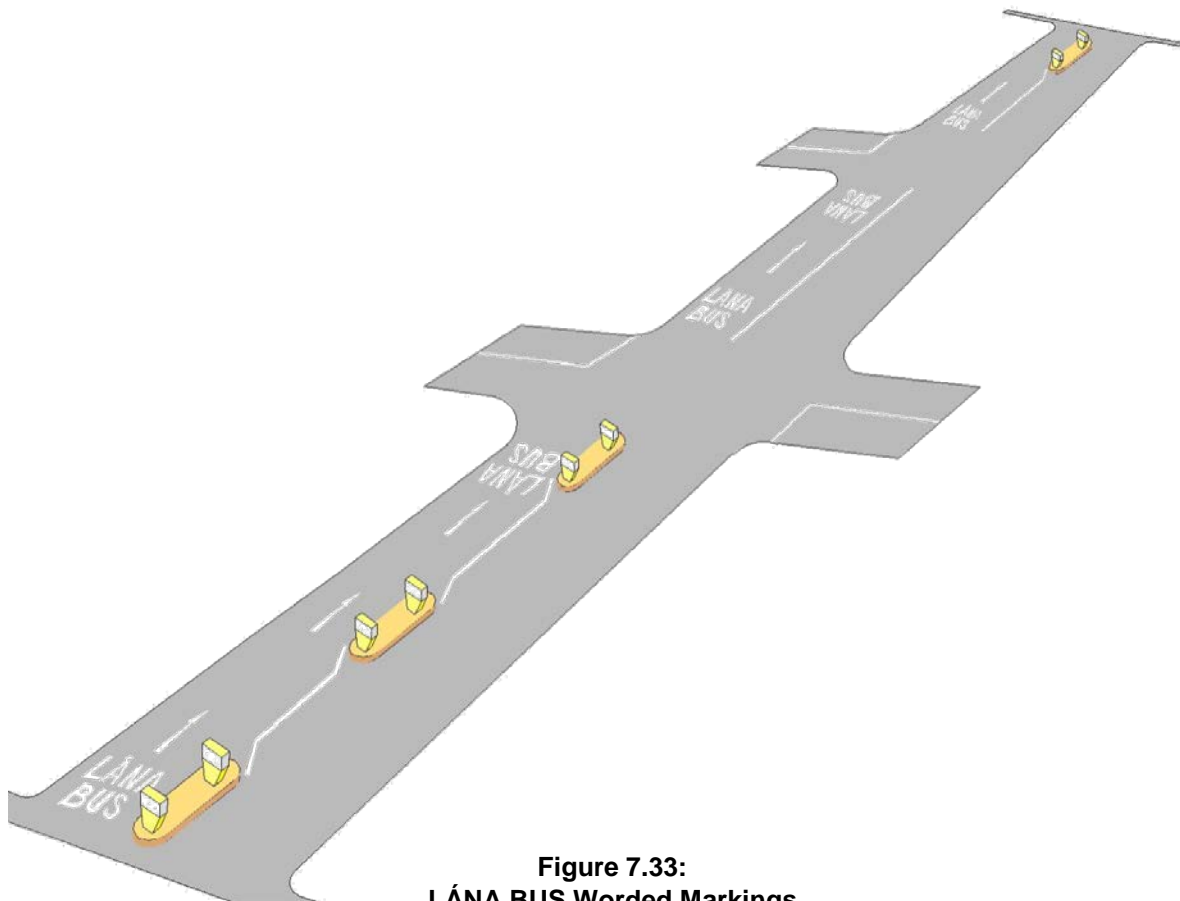
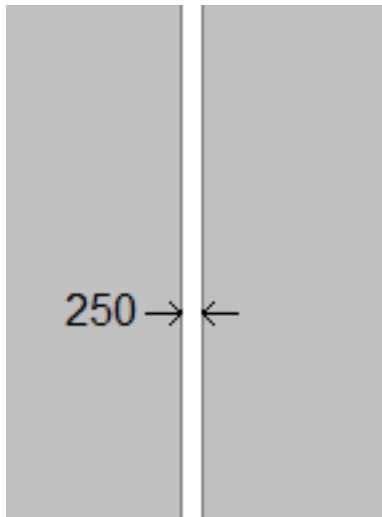

Figure 7.33:
LÁNA BUS Worded Markings
Used in a Contra-flow Bus Lane at a Junction

TRAM LANES

- 7.7.23 Where trams (Light Rapid Transit vehicles) operate on the carriageway adjacent to lanes trafficked by other vehicles, the extent of the tram lane shall be indicated by a 250mm wide continuous white line or lines (RRM 032), except where this coincides with the centre line of a roadway between the tram way and an adjacent traffic lane.
- 7.7.24 To clarify the area of carriageway used by trams, the 'LÁNA TRAM' Worded Marking, M 109, should be laid at appropriate locations, in the same manner as LÁNA BUS Worded Markings.



RRM 032:
Continuous Tram Lane Boundary Line

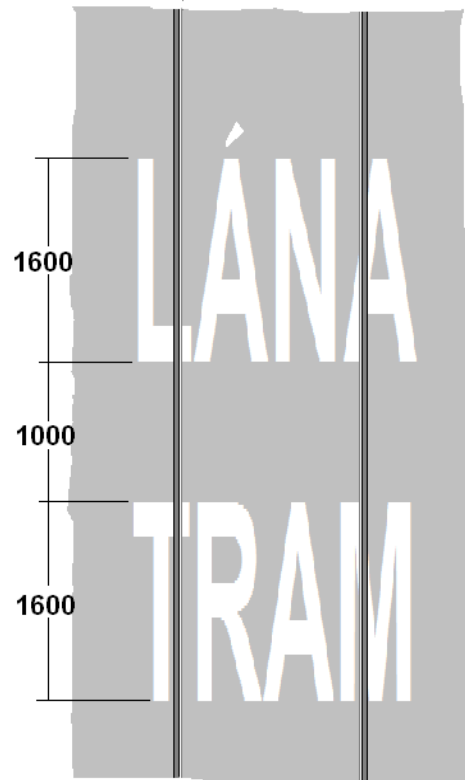

M 109:
LÁNA TRAM Worded Marking

- 7.7.25 Light Rapid Transit vehicles are normally significantly wider than the tracks on which they run, and the degree of overhang increases on curves and with tram motion. It is, therefore, necessary at some locations to indicate the area of the carriageway which will be occupied by the tram. This area is referred to as the 'swept path'.
- 7.7.26 The tram driver needs to be able to identify whether the tram's swept path is clear of vehicles. In some places, the swept path can be indicated by the Tram Lane Line, RRM 032, or Yellow Box Markings, RRM 020. However, these markings could cause confusion to other drivers at some locations, such as junctions and sharp curves. The Swept Path Marking, M 110, is available for use in such circumstances. The marking consists of round or square yellow marks of between 55mm and 100mm diameter or width, spaced at 1.5m intervals. The markings need to be positioned on or just outside the edge of the swept path; close liaison with the light rail operator will be required to ensure that the swept path envelope is accurately delineated.

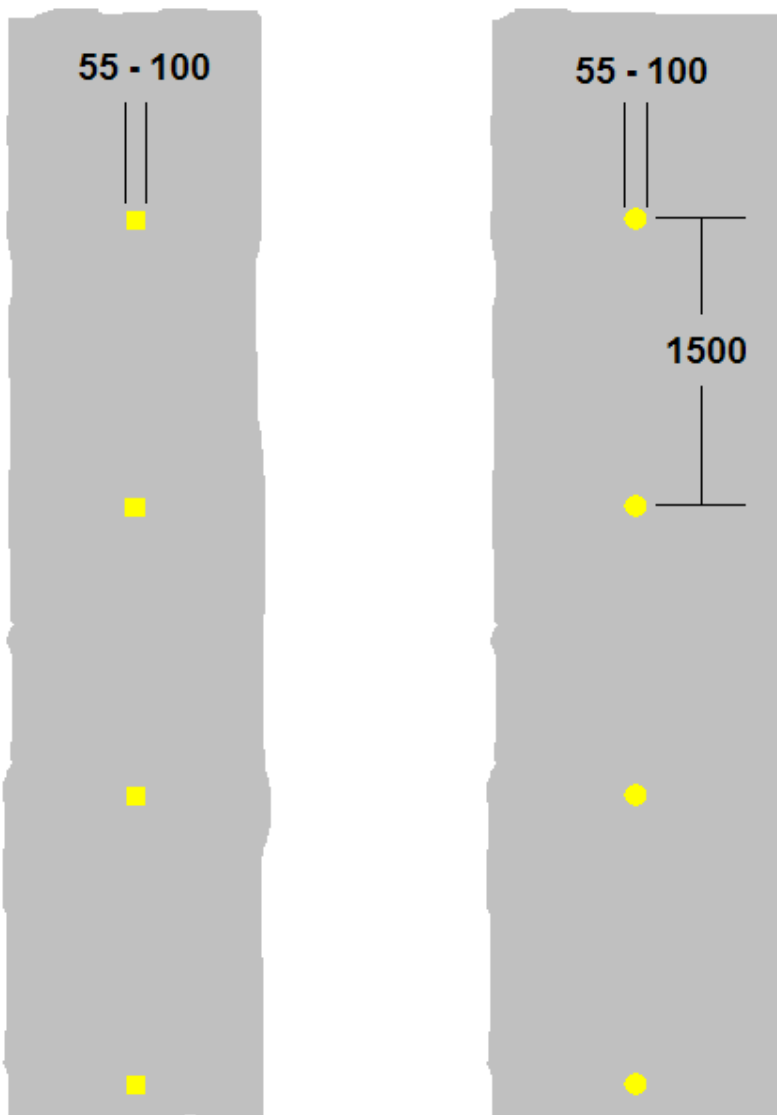

**M 110:
Light Rail Swept Path Marking**

7.8 Cycle Tracks

- 7.8.1 The markings prescribed for use in cycle tracks are:
- Cycle Track Edge Line, RRM 022;
 - Cycle Track Broken Edge Line, RRM 023;
 - Cycle Track Yield Line, RRM 018C;
 - Cycle Track Triangular Yield Marking, M 115C
 - Cycle Track Direction Arrows, M 117, M 118, M 119;
 - Cycle Symbol, M 116; and
 - Pedestrian Symbol, M 111.
- 7.8.2 Cycle track markings may be used in conjunction with other road markings and should be accompanied by the regulatory signs specified in Chapter 5.
- 7.8.3 Cycle track markings are white, and some are smaller versions of markings used for general traffic. These include 1800mm long direction arrows (M 117, M 118 and M 119) and reduced-scale Broken Edge Line (RRM 023) and Yield (RRM 018C and M 115C) markings. These markings are used when specific cycle facilities have been provided. See also the Advanced Cycle Stop Line described in Section 7.2.

WITH-FLOW CYCLE TRACKS

- 7.8.4 Where a cycle track is marked on the nearside of the carriageway, the outer edge should be indicated by a continuous white Cycle Track Edge Line, RRM 022, 100mm wide (150mm on roads with traffic speeds greater than 60km/h). Other vehicles are prohibited from crossing the line. If the cycle track is only operative during certain periods, or where it is necessary for general traffic to cross the boundary of the cycle track (for example, across a priority junction or on the approach to an Advanced Cycle Stop Line), a Cycle Track Broken Edge Line, RRM 023, should be used on either side.
- 7.8.5 The Cycle Symbol, M 116, should be marked on the carriageway across the cycle track at its commencement and repeated after each junction. The symbol, which is available in two sizes, should be repeated at intervals and may be supplemented by a Direction Arrow, M 118. The Cycle Track Broken Edge Line, RRM 023, consisting of a 100mm (or 150mm) wide broken marking with 750mm lines and 750mm gaps, should be laid from the kerb to the start of the full width cycle track to deflect other traffic from the cycle track.
- 7.8.6 One or two Right Deflection Arrows, M 101, should be provided on the approach to the start of a cycle track, except in the case of a short 'feeder' lane leading to an Advance Stop Line.

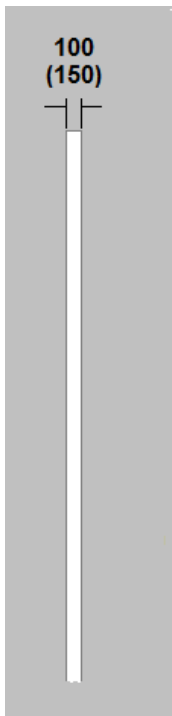

RRM 022
Edge Line

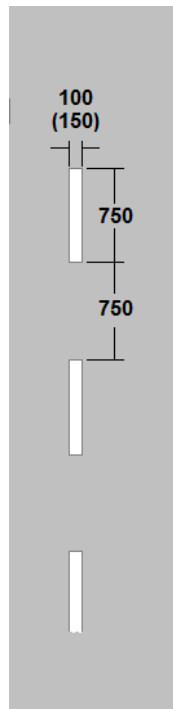

RRM 023
Broken Edge Line

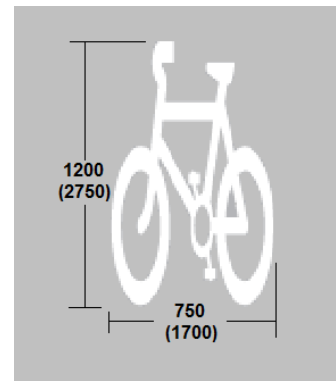

M 116 – Cycle Symbol

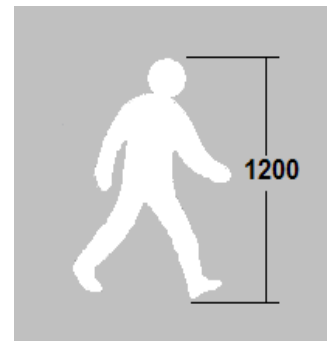

M 111 – Pedestrian Symbol

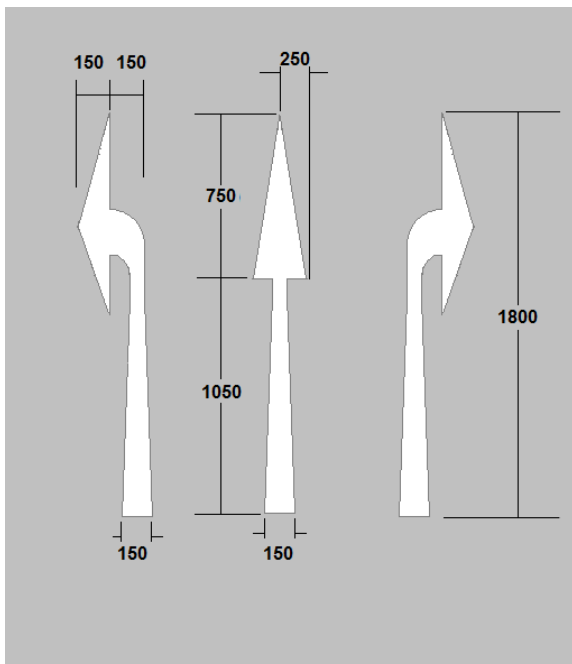

M 117 M 118 M 119
Cycle Track Direction Arrows

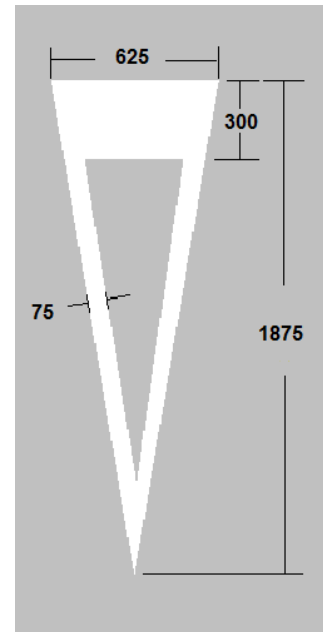

M115C
Cycle Track Yield Marking

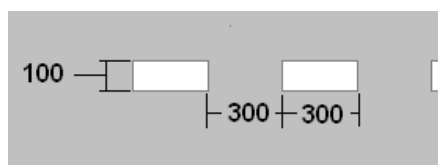

RRM 018C
Cycle Track Yield Line

- 7.8.7 Where a cycle track is marked on a rural road with no hard shoulder and no street lighting, it is recommended that the yellow bi-directional studs that would normally be located on the edge marking (RRM 025) should instead be located on the trafficked side of the cycle track marking (RRM 022), approximately 25mm to 50mm from the line.

CONTRA-FLOW CYCLE TRACKS

- 7.8.8 A contra-flow cycle track may be designated on a road which is one-way to all other traffic. These shall be designed such that cyclists using the track observe the required rules of the road (specifically, that they should keep to the left of the carriageway, whilst oncoming traffic passes to their right).
- 7.8.9 Generally, there will be physical separation between the cyclists and oncoming vehicles at the commencement of such a cycle track, either by refuges, islands or other kerbed features to provide an entry gate, which may be repeated at intervals. Between such features, the cycle track shall be segregated from the opposing traffic lane by a 150mm wide Continuous line RRM 022. In addition, arrows to M 118 and cycle symbols to M 116 shall be provided at intervals of not more than 100m, and at any point where it is necessary to clarify to all road users the direction of the cycle track.
- 7.8.10 At junctions, the edge of the cycle track shall be designated by RRM 023 for that section where general traffic crosses the cycle track.
- 7.8.11 Special regulatory signing is required for contra-flow cycle tracks. This is described in Chapter 5.
- 7.8.12 Examples of with-flow and contra-flow cycle tracks are shown in Figure 7.34.

CYCLE TRACKS NOT ON THE CARRIAGEWAY

- 7.8.13 Where a segregated cycle track is provided on a footway or footpath, the cycle track may be delineated either by means of a pair of parallel RRM 022 markings indicating the limits of the cycle track, or by a single continuous marking RRM 022 indicating the division of the path into cycle track and footway. The Cycle Symbol, M 116, should be provided at the commencement of the cycle track and at intervals along it. The Pedestrian Symbol, M 111, should also be provided on the pedestrian section of the path, adjacent to the Cycle Symbol.
- 7.8.14 The use of Cycle Track Direction Arrows (M 117, M 118 and M 119), the Pedestrian Symbol (M 111) and the Cycle Track Yield Line and Triangle (RRM 018C and M 115C) are discretionary and should be used to clarify priorities and directions of flow as appropriate. Similarly, the Cycle Symbol (M 116) may be used in addition to the specific applications described in Paragraph 7.8.5 to clarify the operation of shared or segregated cycling facilities.

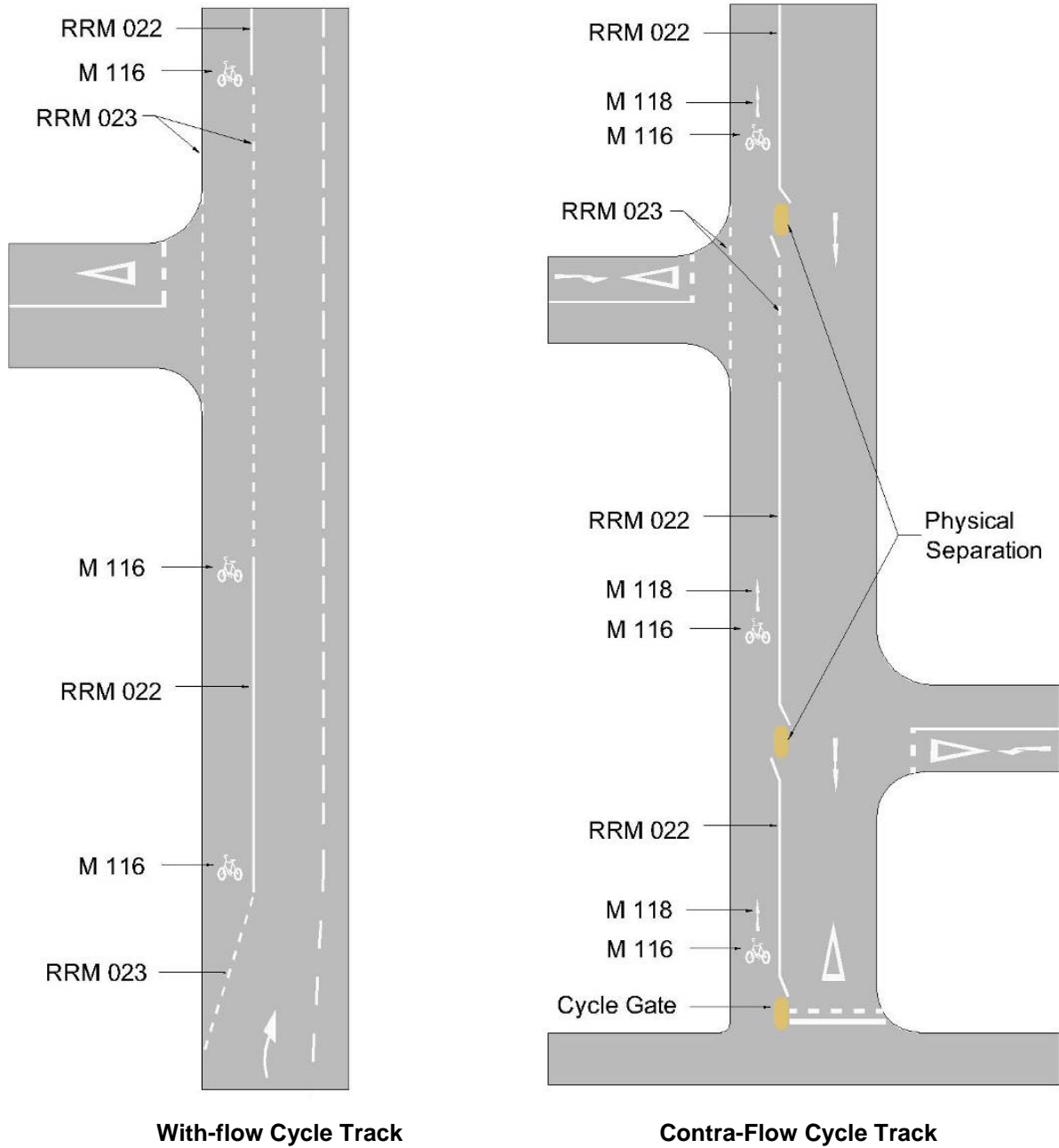

Figure 7.34:
Sample Cycle Track Layouts

7.9 Yellow Box Markings

- 7.9.1 Yellow Box Markings, RRM 020, are provided to aid traffic flow. They may be used at road junctions (including roundabouts), at junctions with tram tracks, at railway level crossings, the exits to bus lanes, or other locations as deemed appropriate by the road authority, where blocking back affecting a cross flow is a significant problem.
- 7.9.2 The carriageway is marked with yellow lines to form a box enclosing yellow cross-hatched diagonal lines.
- 7.9.3 Not all locations are suitable for treatment and it is necessary to apply certain criteria before deciding whether a particular site should be marked. The following points would be relevant:
- Yellow boxes are expensive to maintain and should be used only where other solutions will not work.
 - Linked signals can help to keep a junction clear. In addition, it is possible to provide detectors at a location after a vehicle passes through a junction. This can pick up 'tailbacks' from the next junction and prompt the traffic signals to change thus preventing obstruction of the junction by vehicles.
 - Sometimes a yellow box is not needed at a junction controlled by signals but is needed at an adjacent junction which does not have signals and is affected by queues from the signal-controlled junction.
 - The carriageway beyond the yellow box should be free from obstruction (this may require the imposition of parking restrictions or the relocation of a bus stop).
 - Where a succession of locations gives rise to blocking a series of yellow boxes may be considered provided at least 20m storage can be maintained between successive boxes.
 - There should preferably not be a high proportion of right turning vehicles.
- 7.9.4 The use of half boxes (in which only half the area of the junction is marked) is appropriate at "T" junctions and other locations where traffic only blocks back from one direction only.

Layout

- 7.9.5 The boundaries of a yellow box marking are formed by 200mm wide continuous yellow lines. Two diagonal lines join opposite corners, or projected corners, of the box, and lines are then drawn parallel to each diagonal to form cross-hatched marking in yellow. The diagonal lines are 150mm wide and spaced 2000mm apart where the shortest boundary line of the box is 9000mm or less, and 2500mm apart where the shortest boundary line of the box is greater than 9000mm. Box junctions should usually have four straight sides transverse to the traffic flow on the approaches, although up to 10% of the length of any side may be cut away as shown in the diagram to accommodate corner kerbs. The overall shape of the marking and the number of cross hatching lines will vary to accord with the circumstances at the site.

Special Cases

- 7.9.6 When used at a railway level crossing, the boundary markings shall be 300mm wide, and the diagonal markings 200mm wide. Section 7.15 provides further details.
- 7.9.7 Where a Light Rapid Transit (LRT) line enters a road used by general traffic, it may be advantageous to install a yellow box to maintain free access for the LRT vehicles. In such cases, the boundary lines of the box may follow the swept path envelope of the LRT vehicle.
- 7.9.8 Where there is an identified issue of general traffic blocking the exit from a bus lane, a yellow box may be laid to provide a facility for buses to enter the general traffic stream (see also Figure 7.31). In this circumstance, the diagonal lines shall form an angle of 45° with the direction of travel.

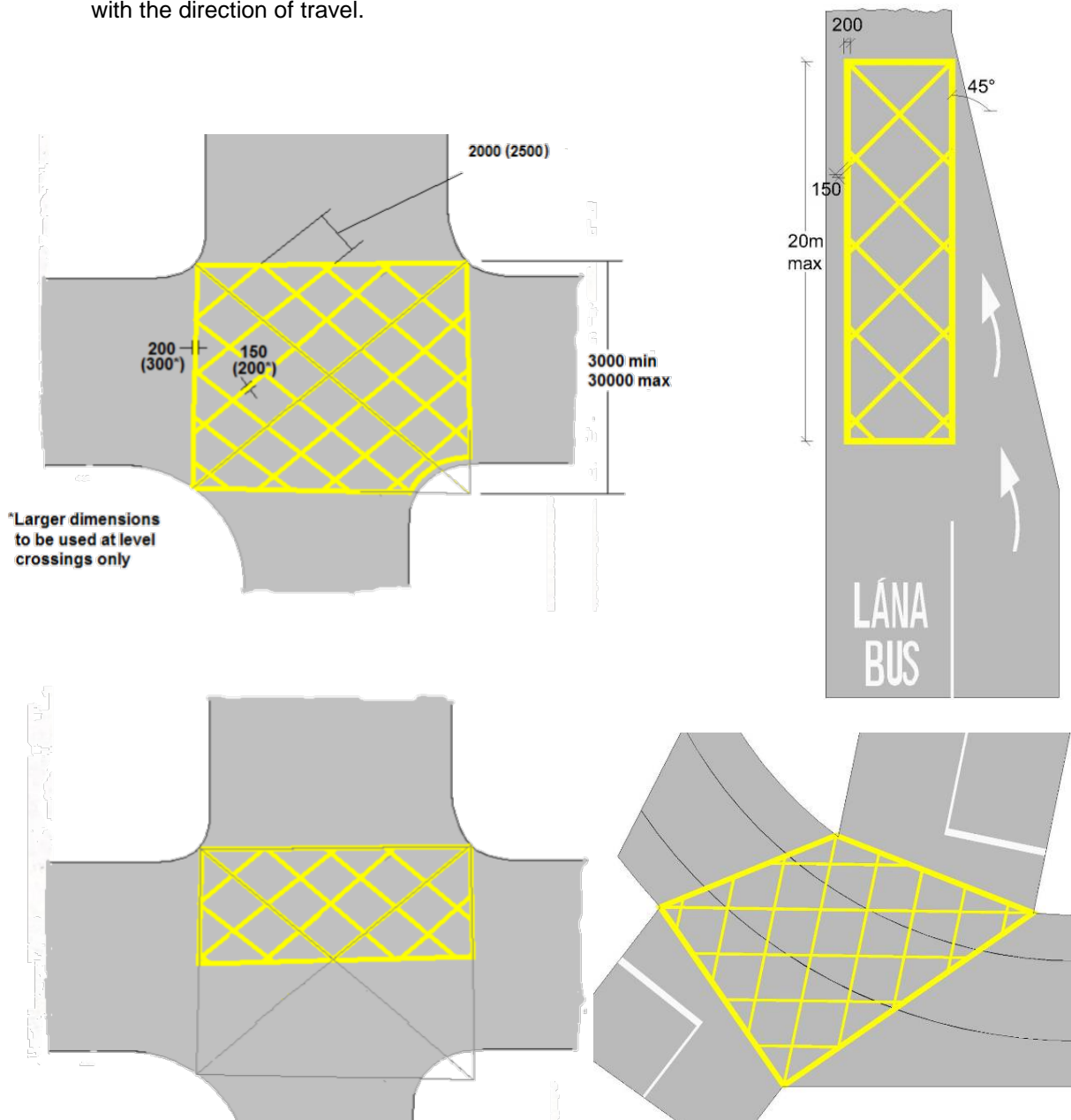

**RRM 020:
 Yellow Box Markings**

7.10 Reflecting Road Studs

- 7.10.1 Road studs shall comply with EN Standards and should be of a type approved for use by Transport Infrastructure Ireland for national roads, or the Department of Transport for other roads.
- 7.10.2 In urban speed limit zones, where street lighting is provided, studs will not generally be necessary. However, in the case of higher speed urban and rural roads and rural national roads, lit and unlit, all centre lines, lane lines, edge of carriageway lines and hatching should have reflecting road studs on the mainline and on all associated road links such as slips, interchange links and loops.
- 7.10.3 The standard spacing of studs for various line types are given in Table 7.6. The following paragraphs provide greater detail on the types of stud for specific applications and note where special spacing would be appropriate.

Table 7.6: Road Stud Spacings

Marking	Reference	Stud Colour	Uni/Bi-directional	Stud Spacing (m)	Notes
Centre Line	Continuous RRM 001	White	Bi	6	See 7.10.4 for Double Line Systems
	Broken RRM 002A RRM 002B			12	
	Warning RRM 002C RRM 002D			12/6	See 7.10.7
Lane Line	RRM 003A	White	Uni	12	See 7.10.6 for stud colour and spacing
	RRM 003B	White / Green		12/8	
	RRM 028	Green		8	
Edge Line	RRM 025	Yellow	Bi / Uni	12	Bi-directional on single carriageway; uni on dual and ramp.
		Green / Yellow	Bi		Single carriageway junction approach; See 7.10.9.
		Green	Uni		Dual carriageway and ramp junction approach; See 7.10.9.
	RRM 026 RRM 027	Yellow	Uni		
Hatched Markings	RRM 021	White or Yellow	Uni	12/8/6	See 7.10.11 and 7.10.12

-
- 7.10.4 Double Line System.** For the standard double line markings, white reflecting bi-directional studs should be laid centrally between the lines. If a Double Line System contains a Continuous Line, the stud spacing should be 6m; it should otherwise be 12m. Where lines are splayed to enclose a hatched area between them, the studs should be located in both of the lines, should be uni-directional, and should be spaced as appropriate to the more restrictive boundary line type.
- 7.10.5 Broken Centre Line (RRM 002A and B).** White reflecting bi-directional road studs should be placed centrally within line gaps at 12m spacing.
- 7.10.6 Lane Lines (RRM 003A and B).** Where lane lines are indicated white uni-directional studs should be placed centrally within line gaps at 12m spacings. Where right turn pockets and left turn deceleration lanes are indicated, green uni-directional studs should be placed centrally within gaps at 8m spacings (on the left-hand side only in the case of a right-turn lane).
- 7.10.7 Warning Lines (RRM 002C and D).** White reflecting bi-directional studs should be placed centrally within line gaps at 12m centres. However, where Warning Line is used in lieu of extensive sections of Continuous Line on lower quality rural roads, as described in 7.3.24, studs may be at 6m centres.
- 7.10.8 Merge/Diverge Lane Lines (RRM 028).** Where Merge/Diverge Lane Lines indicate the division between the nearside lane of a high-quality dual carriageway or motorway and a merging or diverging lane, green unidirectional studs should be placed centrally within line gaps at 8m spacing.
- 7.10.9 Edge of Carriageway (RRM 025, RRM 026 & RRM 027).** Where studs are provided at the nearside edge of carriageway in combination with a Broken Edge of Carriageway Line, RRM 025, they should be yellow, bi-directional (except on dual carriageways, where uni-directional should be used) and placed centrally within line gaps at 12m centres.
- 13 green studs should be provided at 12m centres on RRM025 Edge Lines in advance of junctions (bi-directional green/yellow on single carriageways; uni-directional green on dual), but not when they are otherwise provided on adjacent lane lines. In the case of single carriageways, they should be provided on both approaches to the junction arm on the side on which the junction is located. See Figures 7.38 to 7.40. The Continuous Edge of Carriageway Line, RRM 026 and RRM 027, should have uni-directional yellow studs at 12m centres.
- 7.10.10** The studs may be offset from the continuous edge lines RRM 026 and RRM 027 by 25mm on the trafficked side of the marking. This is especially appropriate when raised profile markings are used, as the studs provide additional audible warning to drivers of the edge of carriageway. Offsetting the studs also facilitates easier maintenance of the road markings, and the increased level of over-running by traffic contributes to self-cleaning of the lenses. However, before this arrangement is applied, regard should be had to the minimum clear lane width as detailed in the TII design standards.

- 7.10.11 **Hatched markings.** Stud provision is determined by the type and colour of the bounding lines, and the location of the lines. Continuous boundary markings should be provided with reflecting uni-directional studs at 6m spacing. On Warning boundary lines, the spacing should be 12m. If greater conspicuity is required 8m or 6m spacing may be used for urban and rural roads respectively.
- 7.10.12 On Motorways and high-quality dual carriageways, yellow uni-directional studs should be provided at 6m centres on the boundary to chevron-hatched areas.

Hazard Markers

- 7.10.13 Where the provision of road studs at the edge of carriageway is impracticable (for example, on narrow rural roads with thin pavement), Hazard Markers (W 180) may be provided instead. These are reflectors mounted on short posts in the verge and are described in Chapter 6.

7.11 Priority Junctions

- 7.11.1 Road markings at priority junctions consist of transverse markings indicating the requirement to stop or yield, together with associated centre lines and other markings to guide and inform drivers of the junction layout. In the case of a one-way street, the No Entry Marking, RRM 019, shall be used.
- 7.11.2 The edge of the transverse line nearest to the major road should not be closer than 600mm to the line of the back of the paved area of the major road. On two-way roads, the Stop or Yield Line, RRM 017 or RRM 018, must be accompanied by a central Single Continuous Line, RRM 001, normally extending longitudinally back from the junction for a minimum distance of 20m from the transverse line, but this may be reduced to 8m as site conditions require. However, on roads less than 5.3m wide this distance may be reduced to 2m (see Section 7.2).
- 7.11.3 Additional markings may be provided on the minor road to supplement the transverse markings as appropriate. These include the worded STOP Marking, M 114, and the triangular Yield Marking, M 115.
- 7.11.4 On the major road, Warning Lines, RRM 002C or D, may be used in place of the standard Broken Centre Line, RRM 002A or B, to emphasise the junction to drivers on the major road.
- 7.11.5 Figures 7.35 to 7.37 illustrate the layout of some simple junctions. Figures 7.38 and 7.39 show typical edge line treatments at junctions where the main road has a hard shoulder.

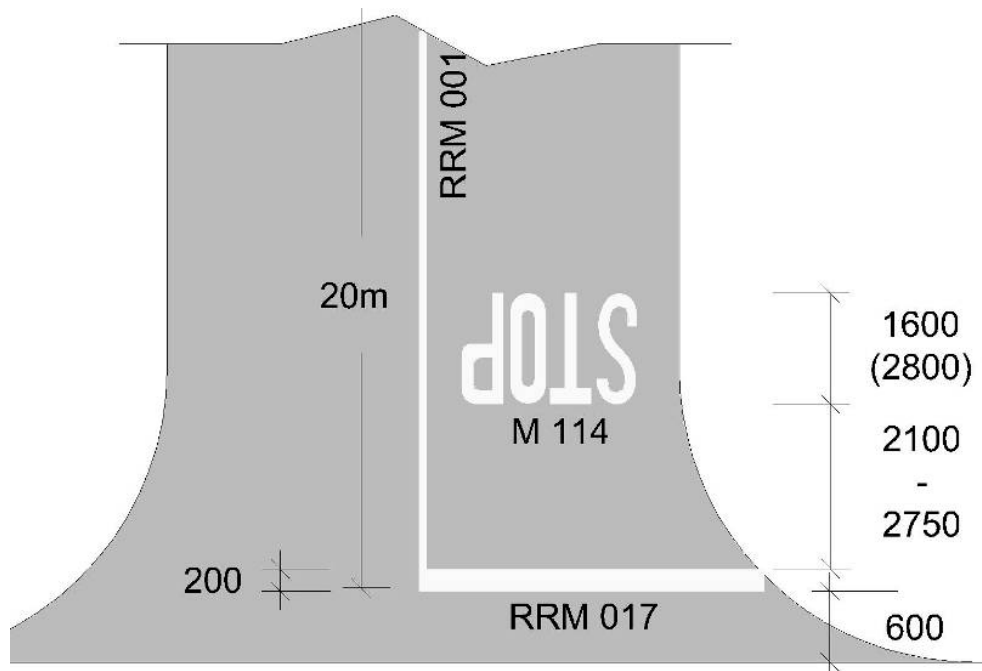

Figure 7.35: Example of Priority-Controlled Stop Junction

Note: See Paragraph 7.11.2

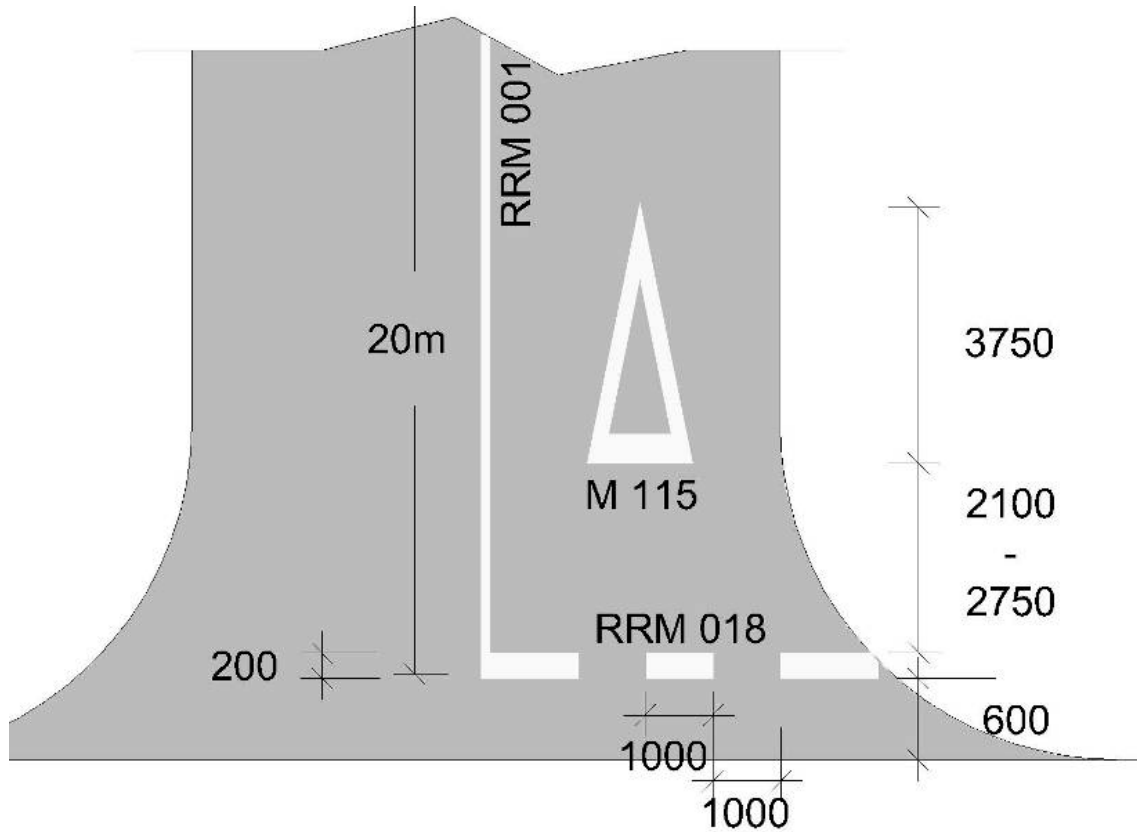

Figure 7.36: Example of Priority-Controlled Yield Junction

Note: See Paragraph 7.11.2

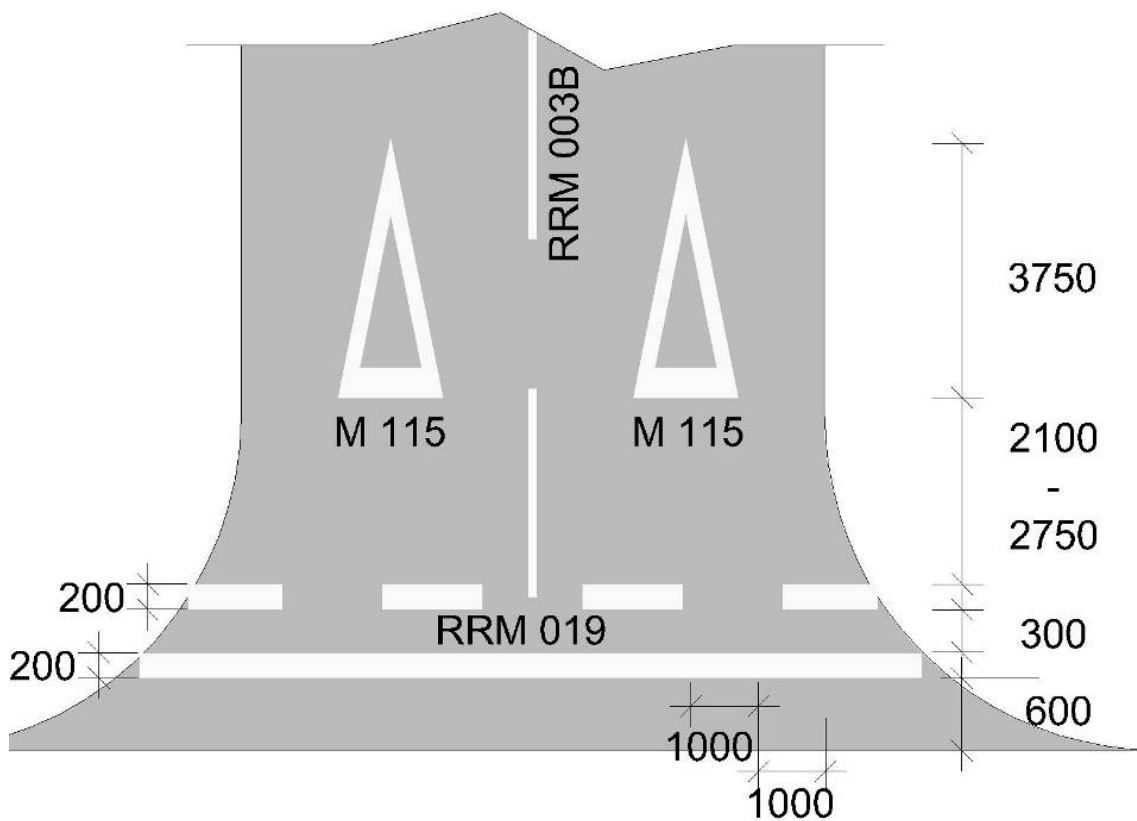
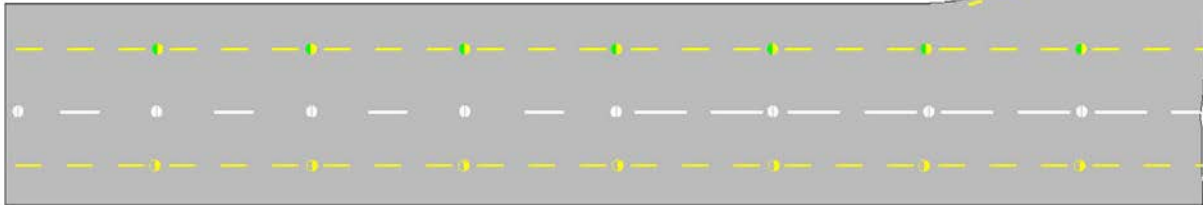

Figure 7.37: Example of Markings at Mouth of One-way Street

Note: See Paragraph 7.11.2

Single Carriageway

Edge of Pavement



or

Dual Carriageway

Edge of Pavement



Central Reserve

Figure 7.38:
Permitted Edge Line Arrangements on Approach to a Junction
on an All Purpose Road
(Similar Arrangements on a Single Carriageway)

Note 1: One half of dual carriageway shown.

Note 2: All studs on a dual carriageway shall be uni-directional

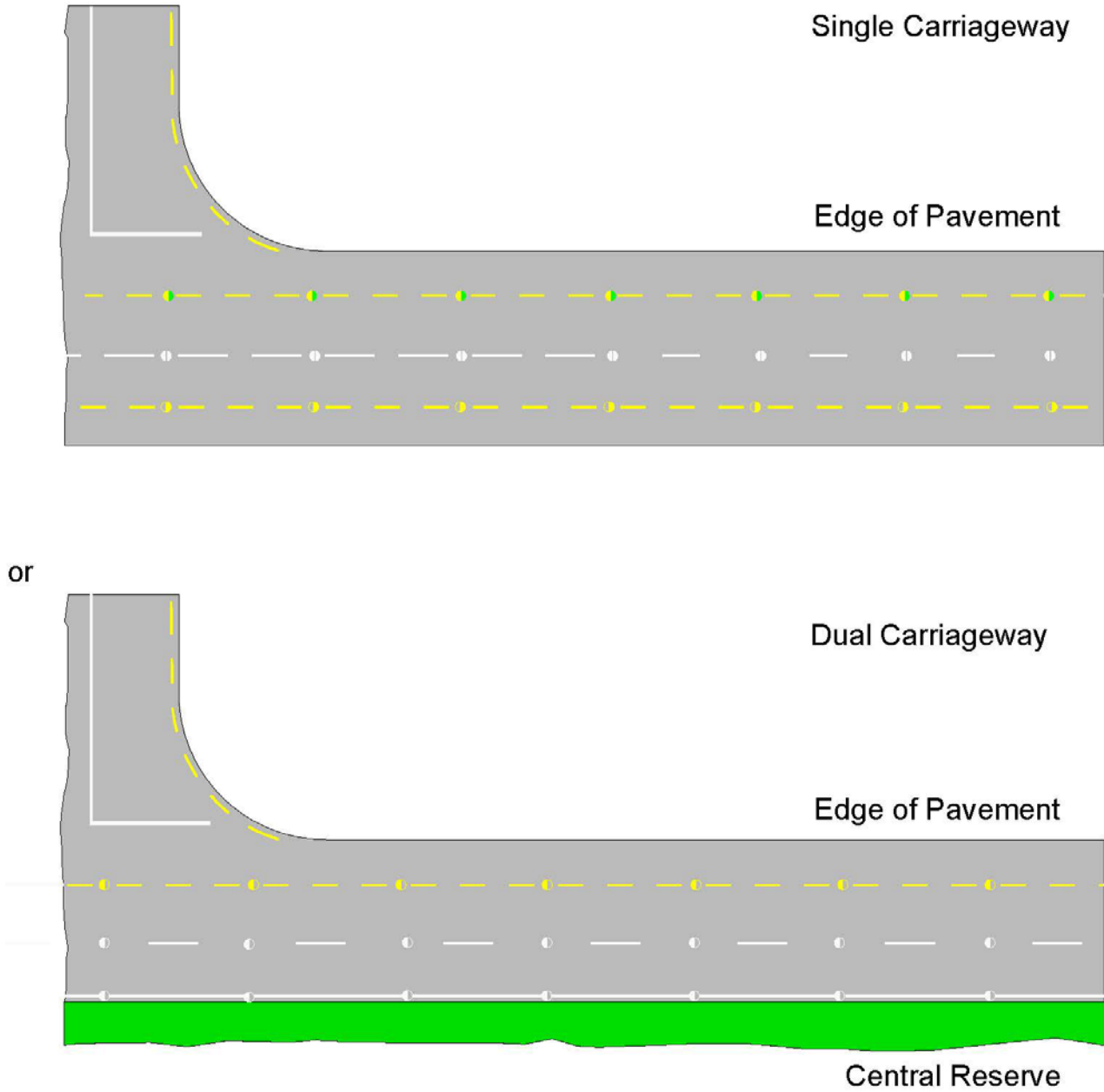

Figure 7.39:
Permitted Edge Line Arrangements
Exiting from a Side Road onto an All-Purpose Road

GHOST ISLAND JUNCTIONS

- 7.11.6 Ghost island junctions are usually provided to afford right-turning vehicles some protection and assist free flow of major road through traffic. Detailed guidance for the design and application of these junctions is contained in TII Standard DN-GEO-03043. Traffic flow warrants for the provision of ghost island junctions are provided in the TII design standards ⁵. It is important to have regard to these warrants when considering the provision of a ghost island. A typical layout of a ghost island junction is shown in Figure 7.40.
- 7.11.7 Ghost islands are normally defined by the continuous boundary marking, which prohibits vehicles from entering the hatched area. In circumstances where it is considered acceptable for traffic to enter the hatched area, the broken line boundary marking may be used (see also Section 7.4).
- 7.11.8 On single carriageways without hard shoulders, the road is sometimes widened at a junction to allow nearside passing of a right-turning vehicle. This should be delineated as shown in Figure 7.41.

RIGHT-TURN JUNCTIONS ON DUAL CARRIAGEWAYS

- 7.11.9 An example of the road markings required where traffic turns right across the central reserve of a dual carriageway is shown in Figure 7.42.

⁵ Transport Infrastructure Ireland. *TII Publications (Standards)*. TII, Dublin.

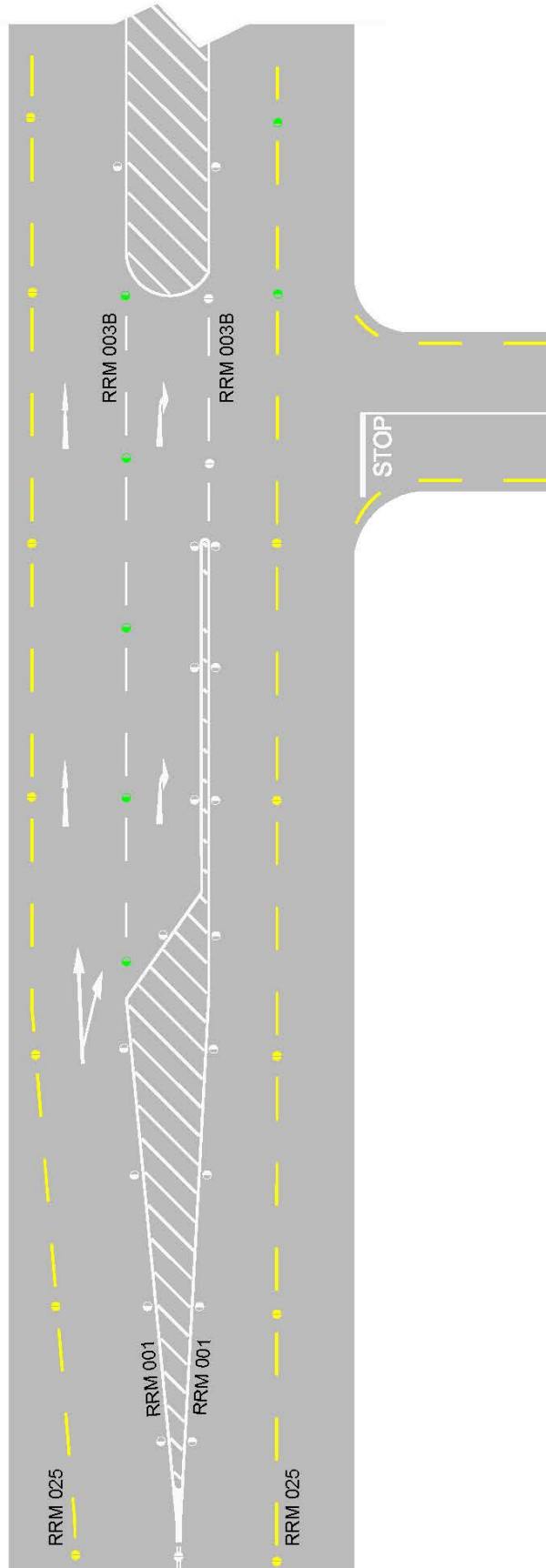

Figure 7.40:
Single Carriageway with Ghost Island and High Volume Right Turn Traffic

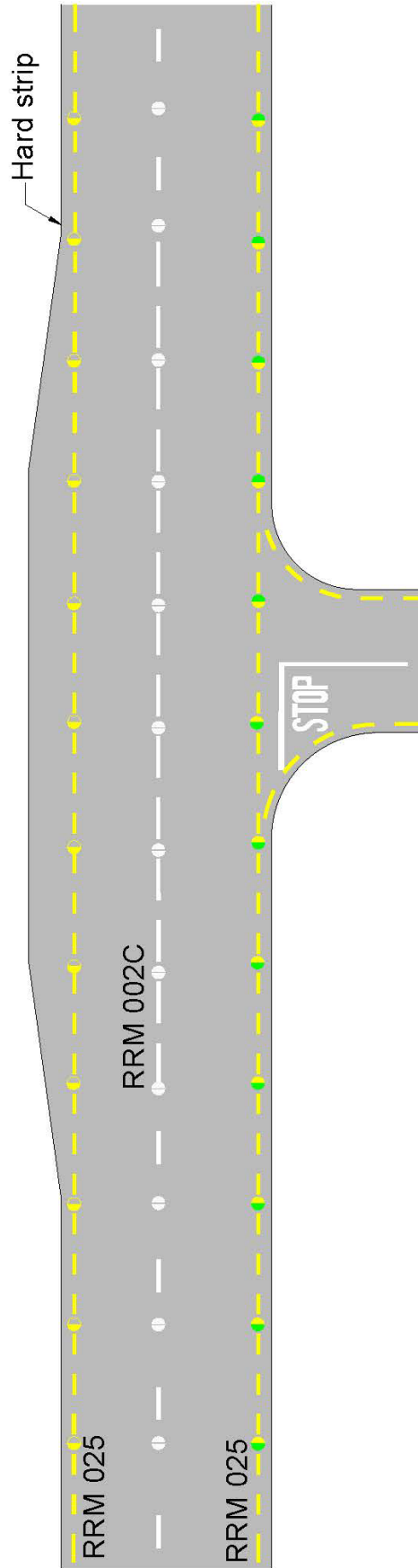

Figure 7.41:
Single Carriageway with Low Volume Right Turn Traffic

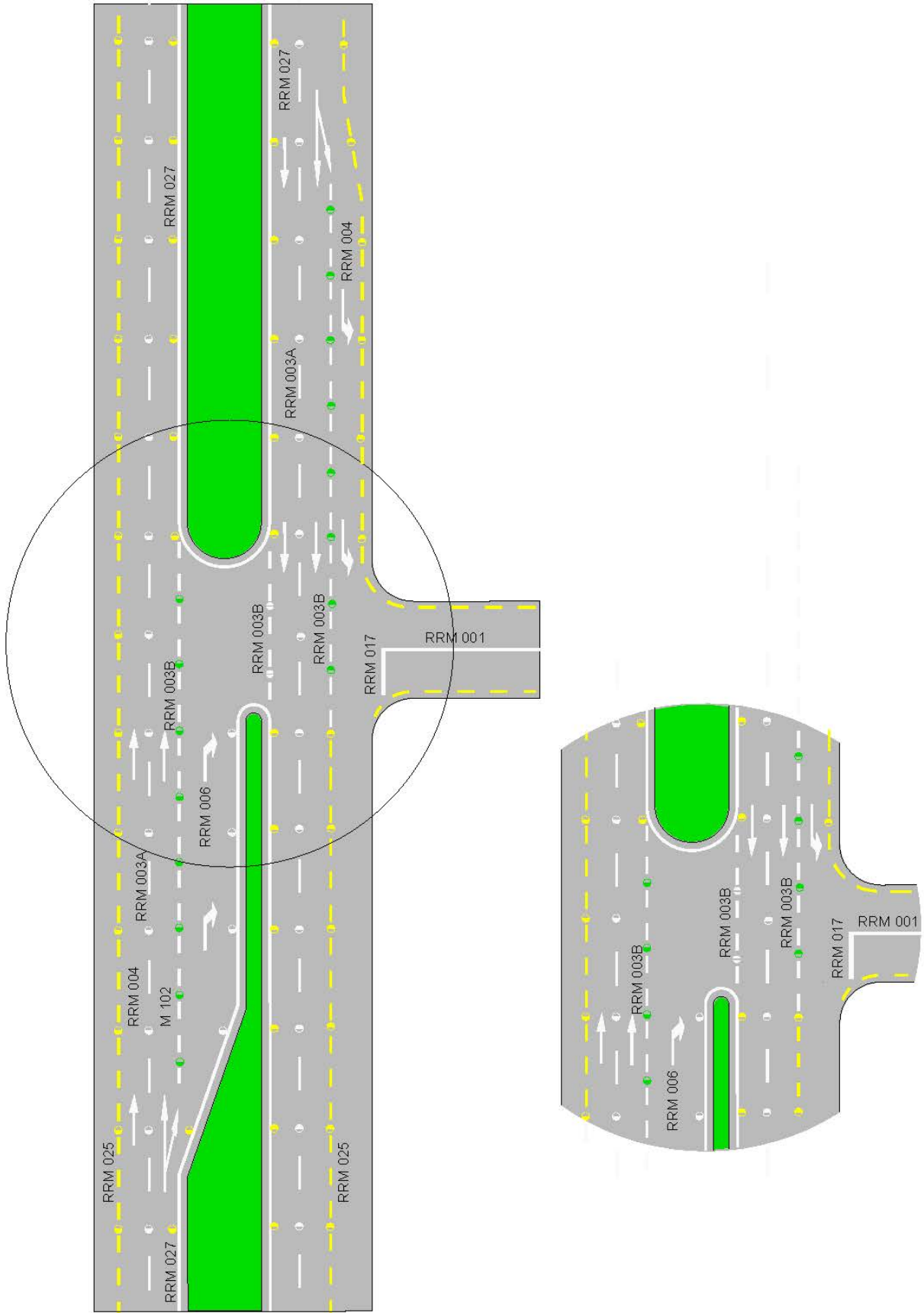

Figure 7.42: Dual Carriageway with Right Turn Lane

7.12 Signal Controlled Junctions

7.12.1 Adequate and proper marking of the approaches to signal-controlled junctions is essential if the junctions are to operate at maximum efficiency. The requirements are:

- The Stop Line must be sited as near as practicable to the intersection, consistent with vehicle and pedestrian needs, and drivers waiting at the Stop Line must have an uninterrupted view of at least one traffic signal;
- Lane Lines should be arranged to secure the maximum use of available carriageway space consistent with adequate lane width; and
- Drivers need to be given guidance as to the correct lane to take in good time before reaching the junction.

7.12.2 Figure 7.43 shows the standard road markings at an urban signal-controlled junction having differing numbers of lanes on each approach. It shows a typical arrangement of lane and centre of carriageway markings for a six-lane road subject to a 60km/h speed limit and a four-lane road subject to a 50km/h speed limit. Chapter 9 contains details of the traffic signals, and an explanation of the symbols used. Chapter 9 also includes additional sample layouts.

Stop Line

7.12.3 The Stop Line, RRM 017, is normally located 2m in advance of the left-hand side primary signal. It should normally be at right angles to the centre line of the carriageway, even at skew junctions. Advanced Cycle Stop Lines may be introduced as appropriate on some or all of the approaches (see Section 7.2).

Lane Lines and Centre Line

7.12.4 Two patterns of Lane Lines, RRM 003, are used. The normal Lane Lines (RRM 003A, 12 metre module) change to closer space markings (RRM 003B, 4 metre module) on the approach to the signals. A minimum of 5 of the closer markings should be provided on roads subject to a speed limit of 50km/h, and 7 markings on roads with a higher speed limit. A Continuous Centre Line, RRM 001, should be provided for at least 20m on the approach to each Stop Line.

Pedestrian Crossings at Signals

7.12.5 Where pedestrian facilities are provided at a signal-controlled junction, a pair of Pedestrian Lines, M 131, should be laid across the carriageway to delineate the place for pedestrians to cross. A Pedestrian Line consists of a continuous transverse white line 100mm wide (see Section 7.16).

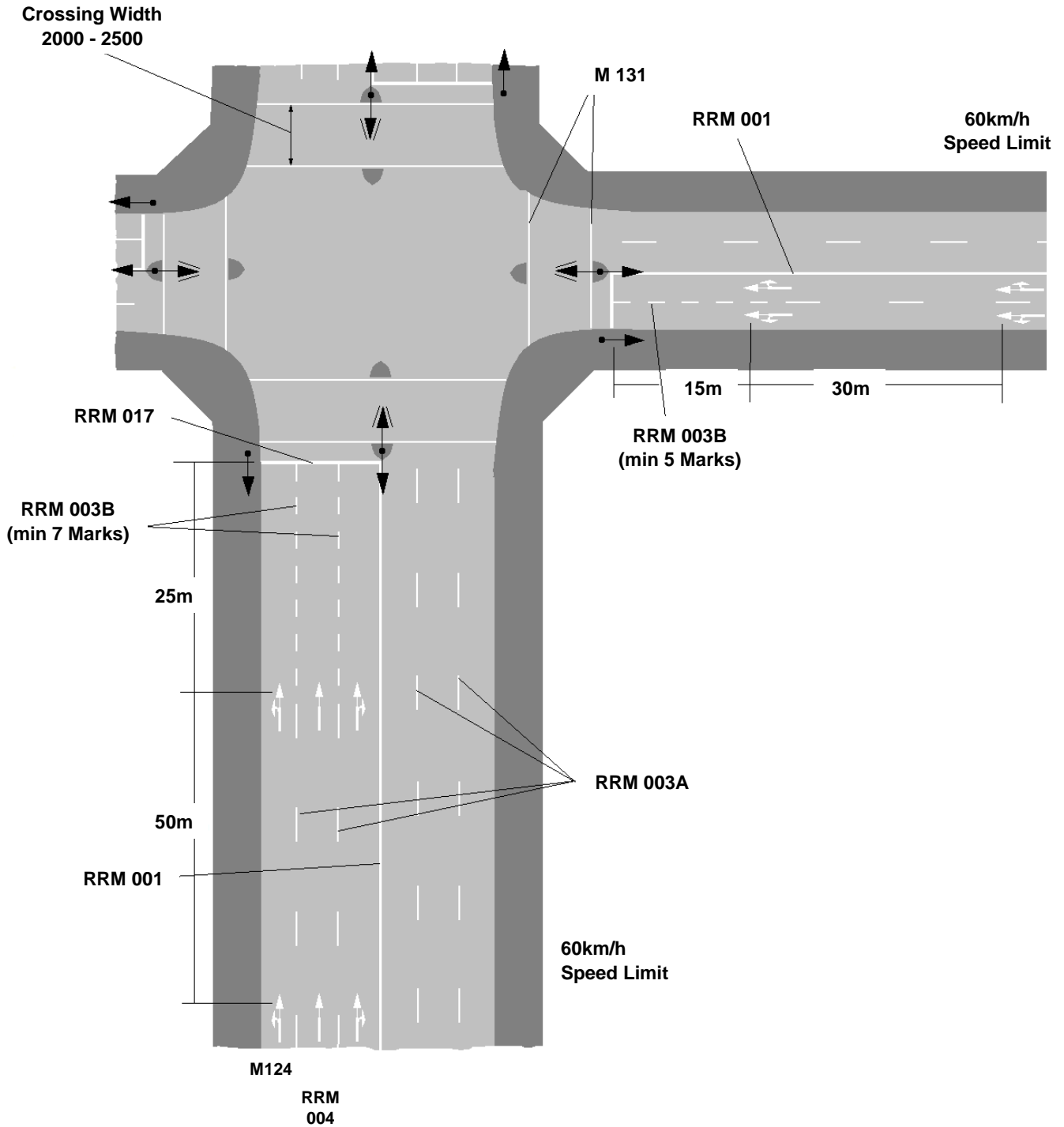

Figure 7.43:
Markings at an Urban Signal-Controlled Junction

7.13 Roundabouts

7.13.1 The most common roundabouts in general use are normal, mini and urban roundabouts. They are defined as:

- **Normal Roundabout:** A roundabout having a one-way circulatory carriageway around a kerbed central island 4m or more in diameter and usually with flared approaches to allow multiple vehicle entry; and
- **Mini-Roundabout:** A roundabout having a one-way circulatory carriageway around a flush or slightly raised circular marking less than 4m in diameter and with or without flared approaches.
- **Urban Roundabout (Continental style):** A roundabout having a one-way circulatory carriageway around a kerbed central island 4m or more in diameter with single lane entry and a single circulatory lane and tight radii. These roundabouts are useful in controlling traffic speeds.

7.13.2 Detailed guidance for the geometric design of roundabouts is contained in DN-GEO-03060 ⁶.

7.13.3 At all roundabouts, the No Entry Line, RRM 019, should be laid at each entry and should connect the splitter island to the nearside edge. The No Entry Line should follow approximately the line of the inscribed circle in order to maintain visibility from each approach lane. In general, Lane Indication Arrows should not be used as they have legal effect and restrict flexibility of lane use for variable traffic conditions.

7.13.4 It is important to provide adequate vehicular deflections through the roundabout. Where raised traffic deflection islands are provided to achieve such deflection, the vertical surfaces may be painted in alternate black and amber bands 300mm in length to improve their conspicuity.

NORMAL ROUNDABOUTS

7.13.5 The No Entry Line shall be used on every entry. The lines shall be 200mm wide and should be accompanied by a Triangular Yield Markings, M 115, as described in Section 7.5. Figure 7.44 shows the options available.

7.13.6 If an approach to the junction is divided into two or more lanes, the Triangular Yield Marking should be placed in each lane on that approach.

7.13.7 A single Continuous Line, RRM 001, should be provided adjacent to the central island, approximately 300mm from the edge of carriageway (see Figure 7.44).

⁶ Transport Infrastructure Ireland. *DN-GEO-03060 - Geometric Design of Junctions (priority junctions, direct accesses, roundabouts, grade separated and compact grade separated junctions)*. Part of the TII Design Manual for Roads and Bridges. NRA, Dublin.

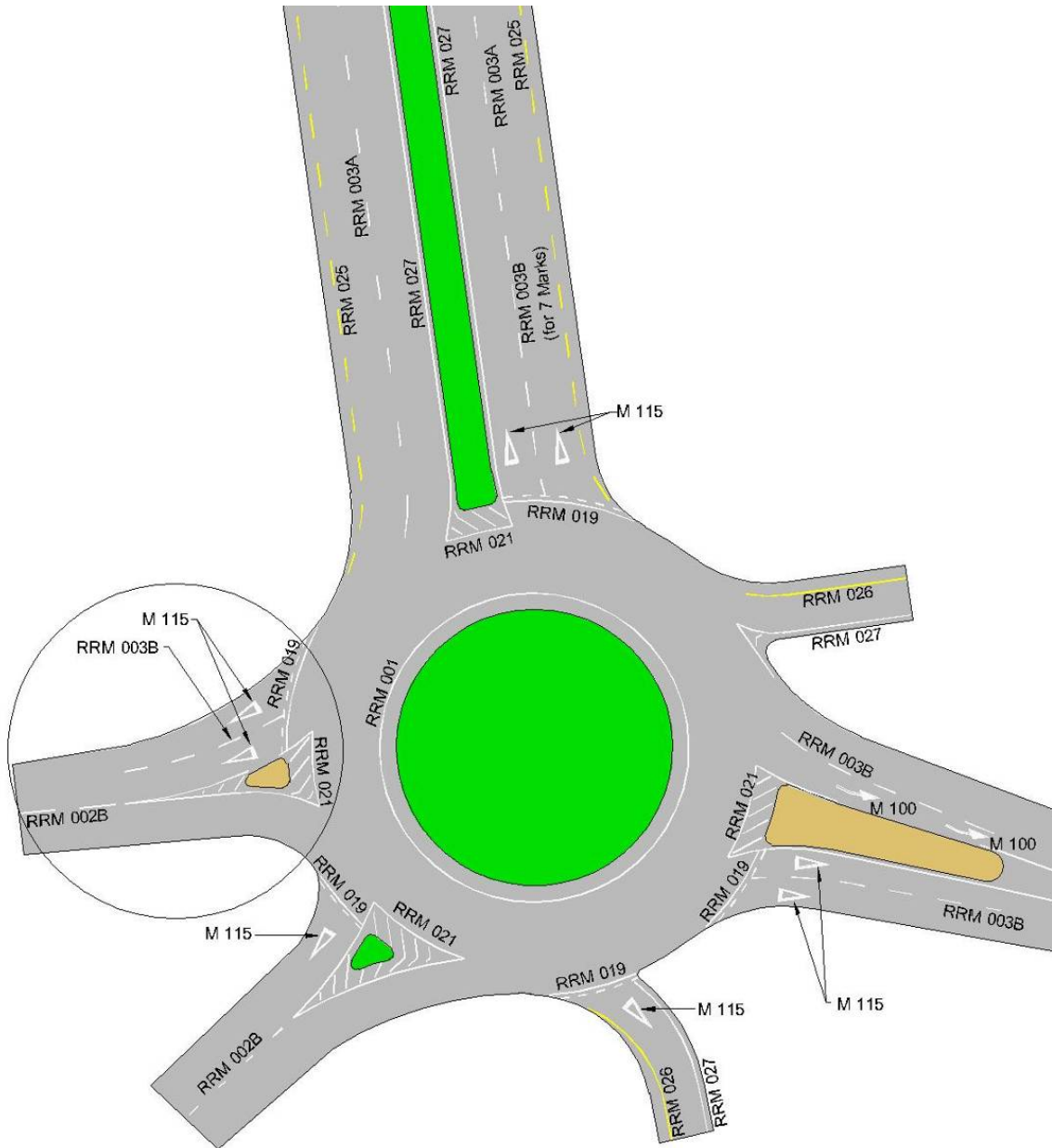
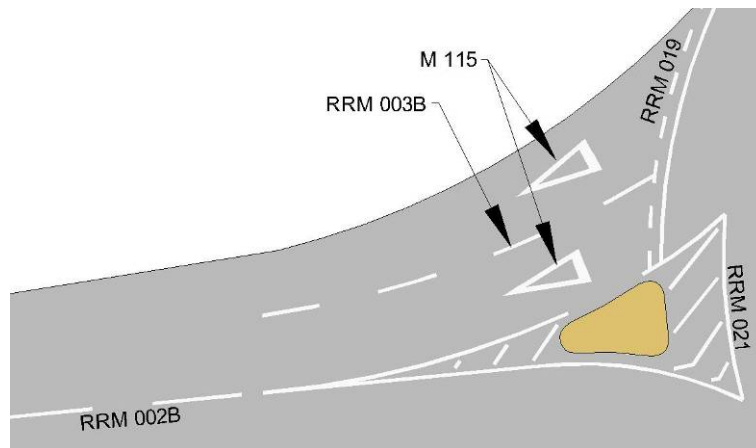

Figure 7.44:
Markings at a Normal Roundabout



Extract from Figure 7.44:
Markings at a Roundabout Entry Arm

7.13.8 Where a wide circulatory carriageway exists, provision of circulatory markings can help to reduce driver confusion and provide well defined paths through the junction. There are four basic configurations of circulatory road marking:

1. Concentric markings (Figure 7.45) trace a complete path around the circulatory carriageway, dividing it into the number of circulating lanes that the carriageway width will allow;

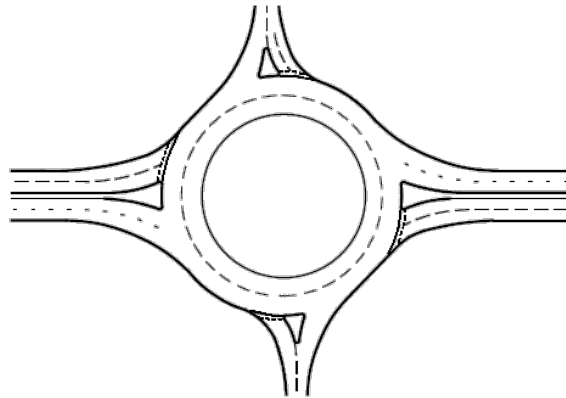

Figure 7.45: Concentric Circulatory Markings

2. Partial concentric markings (Figure 7.46) vary from concentric in that their continuity around the circulatory carriageway is broken, usually adjacent to the entries and/or exits of the roundabout;

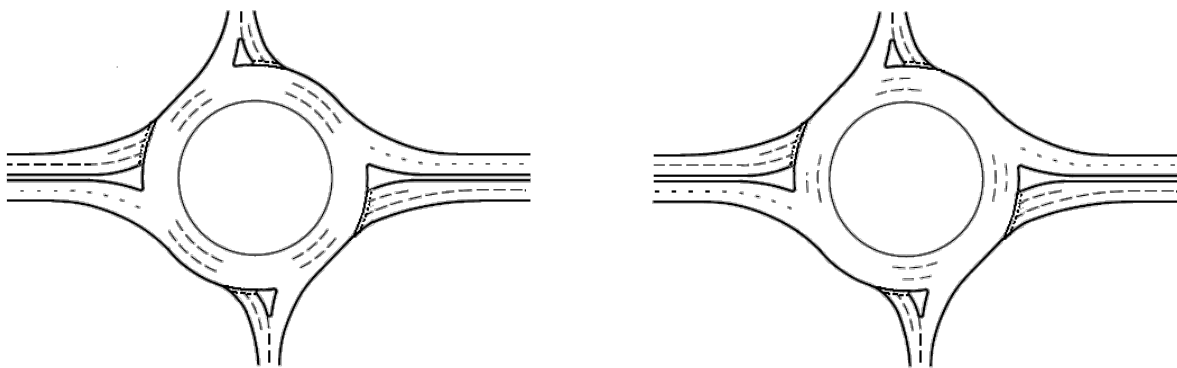

Figure 7.46: Partial Concentric Circulatory Markings

3. Concentric spiral markings (Figure 7.47) are a hybrid. The purpose is to direct off the outermost circulating lane or lanes, where the exit width allows, by running the circulatory marking smoothly into the road markings on the exit concerned;

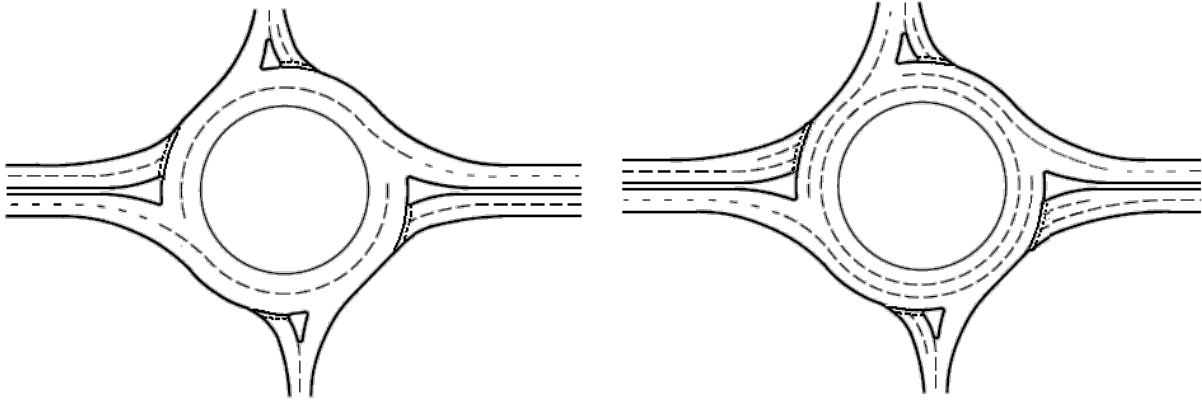

Figure 7.47: Concentric Spiral Circulatory Markings

4. Spiral markings (Figure 7.48) involve a series of lane gains and lane drops around the circulatory carriageway so that drivers enter in the lane appropriate for their desired exit and follow the lane around the roundabout to be led off at that exit.

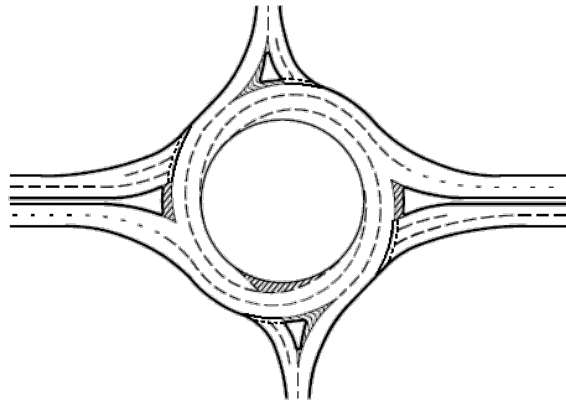

Figure 7.48: Spiral Circulatory Markings

7.13.9 The marking used to delineate lanes within the circulating carriageway shall be the Lane Line, RRM 003B, consisting of a 100mm wide 2m segment and 2m gap.

7.13.10 In certain circumstances it may be necessary to provide lane guidance markings for two conflicting traffic flows, for example on the circulating carriageway of signalised roundabouts. If it is considered that using the same marking for both traffic flows could cause confusion, then the less dominant flow (in the case of a signalised roundabout, the entering traffic) may be divided into lanes using the Modified Lane Line, RRM 003C, as shown in Figure 7.49.

7.13.11 Where hatching is provided, for example on spiral circulatory systems, this shall have broken line boundaries (see Section 7.4).

7.13.12 Worded Lane Destination Markings, e.g. route numbers, are useful on the approaches to roundabouts and on the circulatory carriageway to aid lane discipline (see Section 7.5).

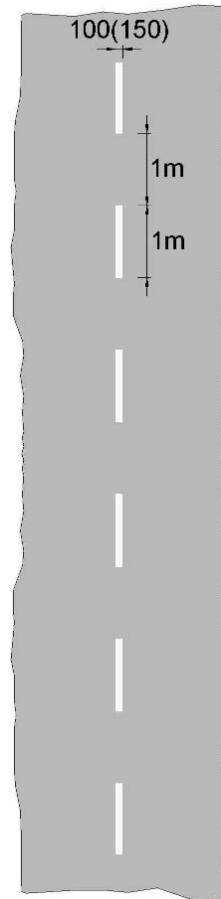

**RRM 003C:
 Lane
 Guidance
 Line**

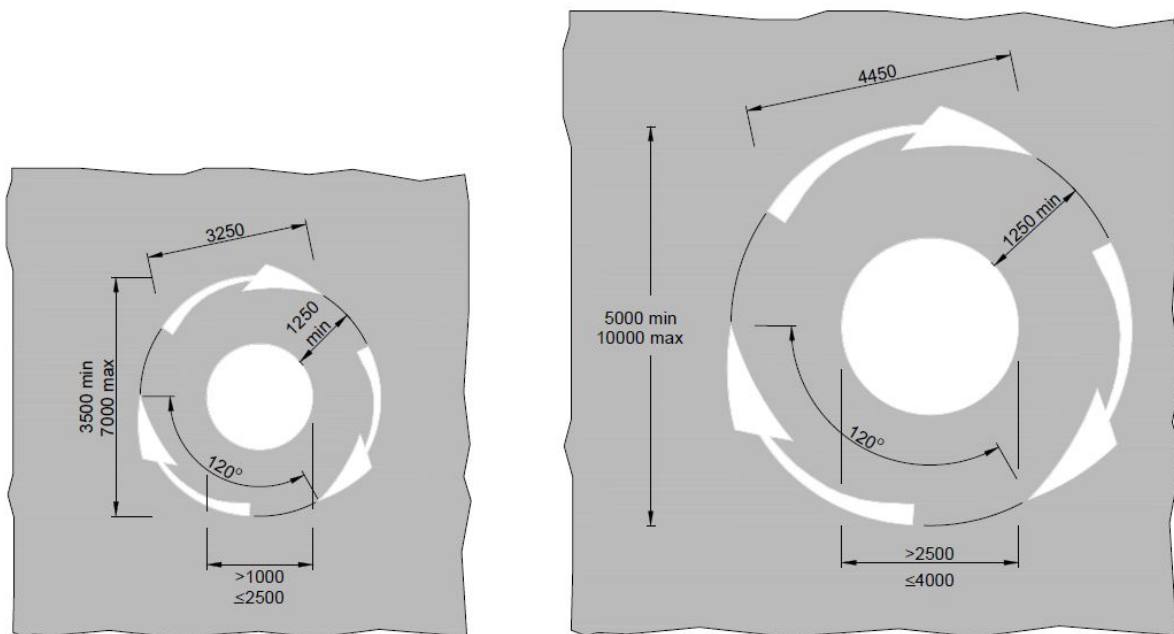

**Figure 7.49:
 Use of Lane Guidance Line, RRM 003C, on a Signalised Roundabout**

MINI-ROUNDBABOUTS, RRM 033

7.13.13 Mini-roundabouts consist of a one-way circulatory carriageway around a flush or slightly raised central disc, between 1m and 4m diameter, with or without flared approaches. The Mini-roundabout Marking, RRM 033, consists of three arrows around the central disc to indicate the direction of circulation. The central disc may be domed up to a maximum of 125mm above the adjacent road surface but must not exceed 6mm at the perimeter.

7.13.14 Two sizes of the Mini-roundabout Marking RRM 033 are prescribed. The smaller, (3250mm) is used for circular central islands up to and including 2500mm in diameter. The larger, (4450mm) is for use with circular central islands more than 2500mm in diameter, up to including maximum of 4000mm in diameter. The choice will depend on the road space available and the need for conspicuity. The larger variant should be used wherever it is needed to provide adequate deflection and deter straight-through movement. The smaller variant may be adequate at more constricted sites where the marking would otherwise occupy too large a part of the carriageway space and might be confusing, or where frequent overrunning would result in excessive maintenance costs



RRM 033: Mini-Roundabout Markings

- 7.13.15 Under no circumstances should annular rings be added around the central disc. If a more conspicuous central marking is necessary, a larger disc, up to a maximum of 4 m should be used. If the junction area is very large, the diameter of the circulatory arrow marking should be increased to a maximum of 10 m, with the length of the arrows correspondingly increased to 4.45 m. Conspicuity may be further enhanced by replacing the normal central warning line on the approach with a hatched marking.
- 7.13.16 The central disc marking should be capable of withstanding overrunning by large vehicles. Because of this it is not possible to site the mandatory signs normally associated with a normal roundabout on the central area. Chapter 5 provides information on the relevant mandatory signs to use at a mini-roundabout.
- 7.13.17 The layout of a mini-roundabout should be designed so that drivers are made aware in good time that they are approaching a roundabout. Their conspicuity may be enhanced where necessary by the use of warning signs (W 044) or map-type advance direction signs. In general, mini-roundabouts should only be used when traffic speeds on all approaches are 50km/h or less.
- 7.13.18 The No Entry Line, RRM 019, at mini-roundabouts is the same as that used at normal roundabouts.
- 7.13.19 Road markings or small traffic islands should be placed so as to ensure some vehicle deflection on the approaches; hatched markings can often help. Physical islands should be kept free of all furniture except the Keep Left bollards and other essential signs. Where an existing junction is being converted to a mini-roundabout, it may not be practicable to achieve the ideal amount of deflection. However, this may be acceptable if approach speeds are low.
- 7.13.20 Where suitable deflection cannot be achieved, traffic entering the roundabout might, because of its approach speed, disregard the Yield requirement of the No Entry Line. In such cases, the Yield Sign (RUS 026) may be mounted on the same post and above the Mini-roundabout sign (RUS 049).

7.14 Grade-Separated Junctions

7.14.1 Grade-separated junctions may involve merging and diverging lanes, the gain or loss of lanes, or a combination of these. As junctions become more complex, so road marking layouts become more complicated. It is therefore not possible to detail all possibilities, but the standard principles should be followed. Reference should be made to Standard DN-GEO-03035⁷ for further guidance. When designing a complex junction, it should be borne in mind that it must be capable of being signed and marked in a way that drivers can readily understand.

7.14.2 The layout of markings at the simplest grade-separated junction is shown in Figure 7.50. Comprehensive details of the longitudinal markings and stud spacings are given in Sections 7.3 and 7.10. This arrangement is suitable for one or two-lane exit slip roads and one-lane entry slip roads.

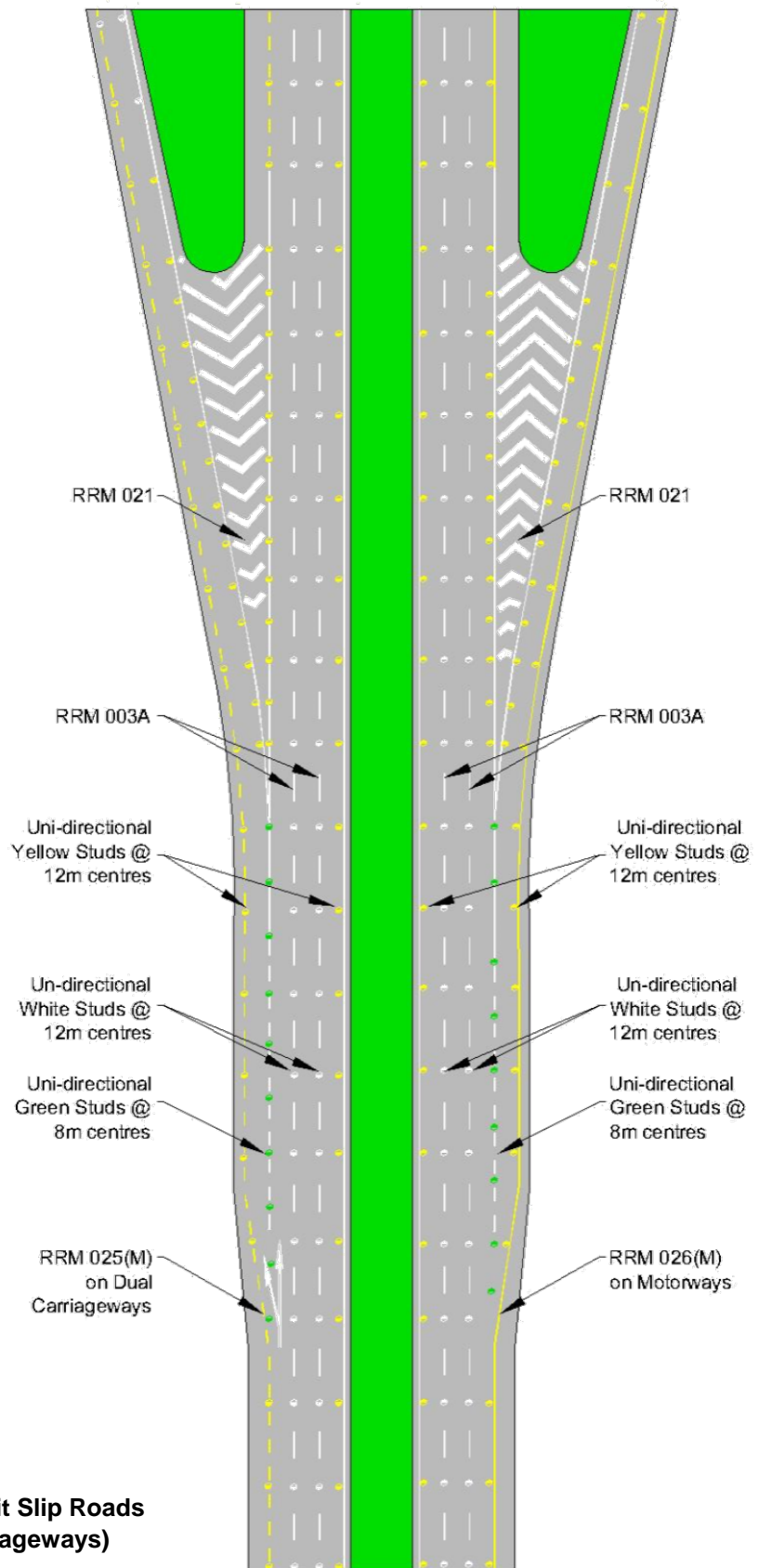

**Figure 7.50: Entry and Exit Slip Roads
 (Dual Three Lane Carriageways)**

⁷ Transport Infrastructure Ireland. *DN-GEO-03035 Layout of Grade Separated Junctions*. TII Dublin.

7.15 Level Crossings

7.15.1 The markings associated with a railway level crossing are shown in Figure 7.51. The markings comprise:

1. Yellow Box Marking, RRM 020, indicating the area to be kept clear of stationary traffic. Note that at railway level crossings the boundary lines shall be 300mm wide; the diagonal lines shall be 200mm wide and 1400mm apart, and set at an angle of 60° relative to each other, irrespective of the geometry of the boundary lines;
2. Transverse vehicle Stop Line, RRM 017. A special line width of 300mm shall be used, which must be at right angles to the direction of vehicular travel. Where the approach carriageway width is insufficient for centre line markings, the Stop Line shall extend across the full width of the road on both sides of the crossing;
3. Transverse Exit Boundary Line, M 122, indicating the extent of the crossing on the exit side. This line shall be 300mm wide with 900mm marks and 450mm gaps;
4. Approach carriageway continuous Centre Line, RRM 001, extending back at least 20m from the Stop Line, but this may be reduced to a minimum of 8m as site conditions require. On roads less than 5.3m width only, the centre line marking may be reduced to 2m;
5. Internal carriageway centre Warning Line, RRM 002D, extending between the two vehicle Stop Lines. This marking may only be omitted in cases where the carriageway width across the level crossing is less than 5.3m;
6. Edge of Carriageway Markings, RRM 025, shall be laid between the two vehicle Stop Lines, to define the edge of the vehicle running lanes through the level crossing. They may also serve to indicate the segregation of pedestrian and vehicle paths, as it is not possible to maintain a level difference between footway and carriageway through the crossing; and
7. If appropriate, a Back of Footway Line, M 123, may be used to designate the back of the pedestrian footway through the level crossing. This is a 100mm wide continuous white marking.

7.15.2 The example shown in Figure 7.51 illustrates a simple level crossing with a single railway line. In the case of multiple lines or an acute crossing angle, the box marking may be extended as shown in Figure 7.52.

7.15.3 The warning signs associated with level crossings are described in Chapter 6 and the signals in Chapter 9.

7.15.4 Road studs shall be provided for Centre Line and Edge of Carriageway Markings as prescribed in Section 7.10, but any stud laid within 2m of a running rail shall be of plastic construction.

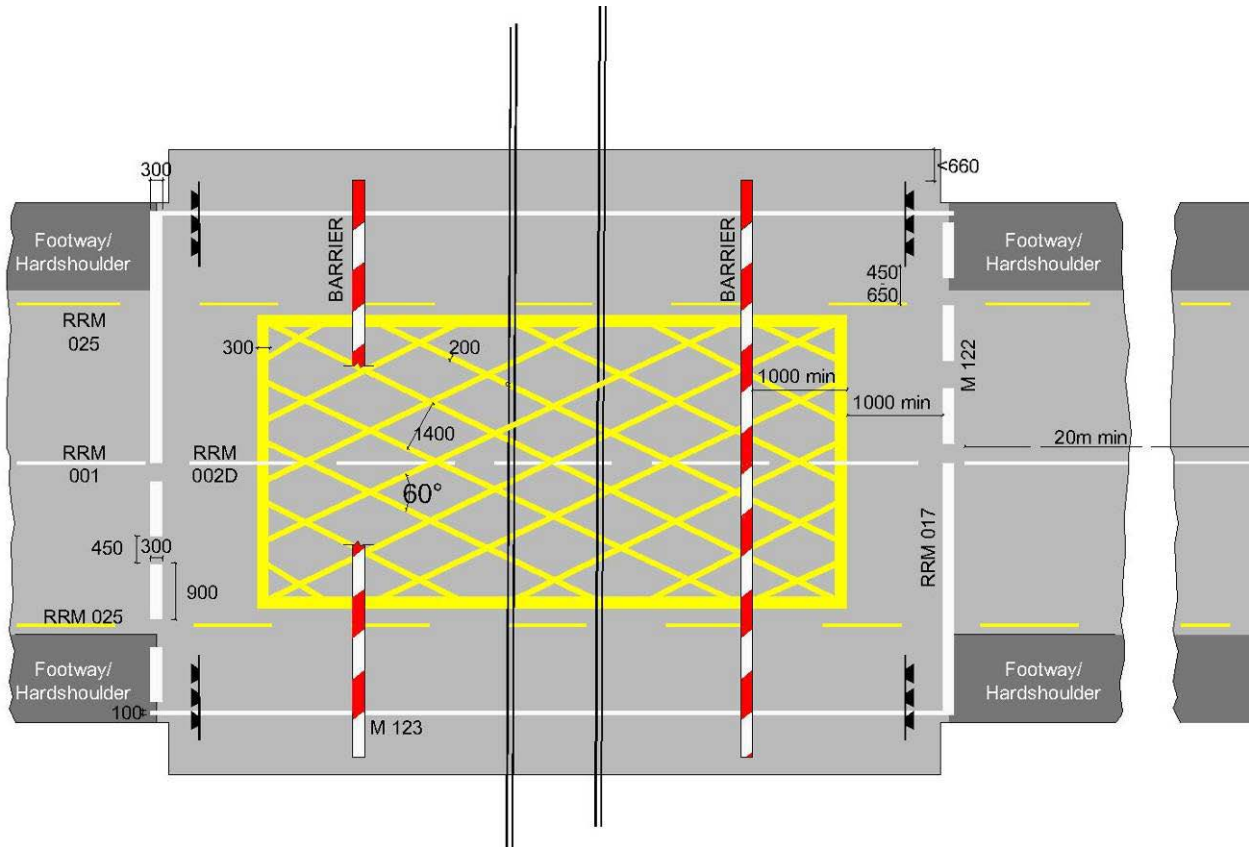

Figure 7.51:
Markings at a Level Crossing

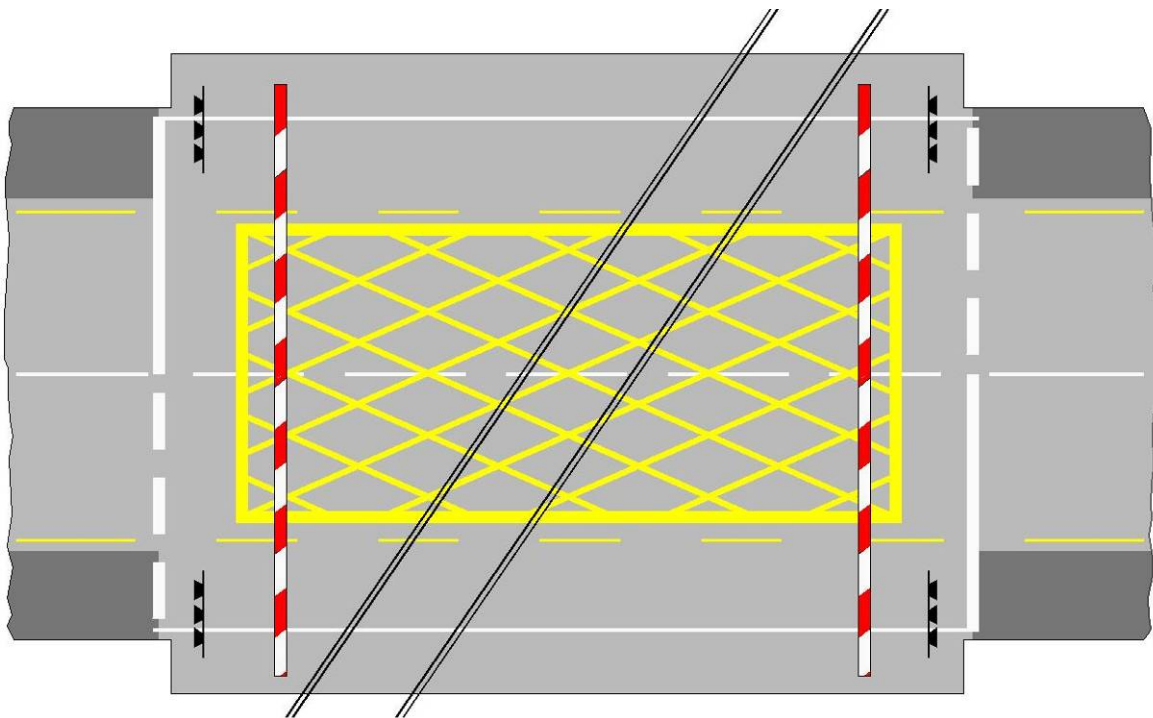

Figure 7.52:
Extended Yellow Box Marking at a Level Crossing

7.16 Pedestrian Crossings

7.16.1 A series of road markings is prescribed to delineate Zebra or Signalised Pedestrian Crossings. Additional Zigzag Markings are available to define 'controlled areas' adjacent to the crossings.

ZEBRA CROSSING (RPC 001)

7.16.2 A set of Pedestrian Lines, Transverse Lines, Stripes, and Pedestrian Crossing Beacons together form a Zebra Crossing, RPC 001. These markings are laid out as follows:

7.16.3 **Pedestrian Lines:** Pedestrian lines indicate the limits of the pedestrian crossing area. They consist of two lines across the carriageway at a minimum distance of 2.0m apart (normally 2.4m apart). The lines are white, continuous and 100mm wide.

7.16.4 The width of a pedestrian crossing may be dictated by site conditions. However, where space permits the width of 2.0m should be increased by an additional 500mm for every 125 pedestrians per hour above 600, averaged over four peak hours, up to a maximum of 5m or, in exceptional circumstances, 10m.

7.16.5 The **Transverse Line** consists of a single white broken line comprising 500mm segment and 500mm gaps. The marks are 200mm wide. This line is normally sited 1m to 2m from and parallel to the Pedestrian Line used to indicate the limits of the crossing and should extend across the approach lanes.

7.16.6 **Stripes:** The stripes should be laid in an alternate black and white pattern across the full width of the carriageway and positioned centrally between the two Pedestrian Lines.

7.16.7 The stripe immediately adjacent to the kerb on both sides of the road should be black and should not be less than 500mm nor more than 1300mm wide. The intermediate black and white stripes should be not less than 500mm nor more than 715mm wide and should normally be of equal width.

7.16.8 If the road surface is dark (e.g. bituminous macadam) between the pedestrian lines, then the surface colour itself will be sufficient to constitute the 'black' stripes. However, with the increasing use of high skid-resistant surfacing in a variety of light colours, care must be exercised to ensure that there is sufficient visual contrast between alternating stripes to indicate clearly the presence of the crossing.

7.16.9 The prescribed Zebra Crossing must include Pedestrian Crossing Beacons, located on either side of the road (and on a refuge where provided), on the side of the stripes from which traffic approaches. For details of the beacons, see Chapter 9.

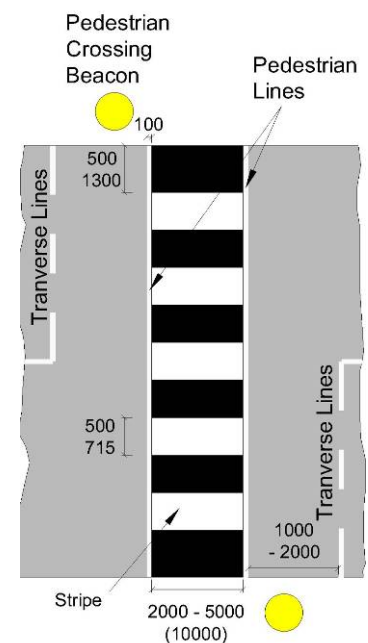

**RPC 001:
 Zebra Crossing**

SIGNALISED PEDESTRIAN CROSSING

- 7.16.10 Pedestrian crossings may also be controlled by pedestrian-operated traffic signals (RPC 003 or RPC 004), as described in Chapter 9. These may be Pelican Crossings or conventional signalised pedestrian crossings. Toucan Crossings provide a combined signalled crossing facility for pedestrians and cyclists. The markings for all these are identical.
- 7.16.11 The carriageway markings used to indicate a signalised pedestrian crossing are as follows:
- 7.16.12 **Pedestrian Lines, M 131**, between 2000mm and 5000mm apart, as described for Zebra Crossings, to indicate the limits of the crossing. In exceptional circumstance, where very large pedestrian flows occur, the width may be increased to a maximum of 10m.
- 7.16.13 **Stop Lines, RRM 017**, to indicate where traffic should stop when signalled to do so (see Section 7.2).
- 7.16.14 Where the road carries two-way traffic and the crossing is uninterrupted, the Stop Line should extend from the edge to the centre of the carriageway, parallel to the Pedestrian Line, and placed not less than 1.0m or more than 5m from the Pedestrian Line (normally 2.0m).
- 7.16.15 On a one-way street where the crossing is uninterrupted, the Stop Line should extend from one edge of the carriageway to the other edge, positioned as above.
- 7.16.16 On a two-way road the Stop Line should always be accompanied by a **Continuous Centre Line, RRM 001**, extending longitudinally back from the junction (see Section 7.2).
- 7.16.17 Where the crossing caters for cyclists as well as pedestrians, the same signals and road markings are used, together with Cyclist Signals RTS 006 and RTS 007 (see Chapter 9).

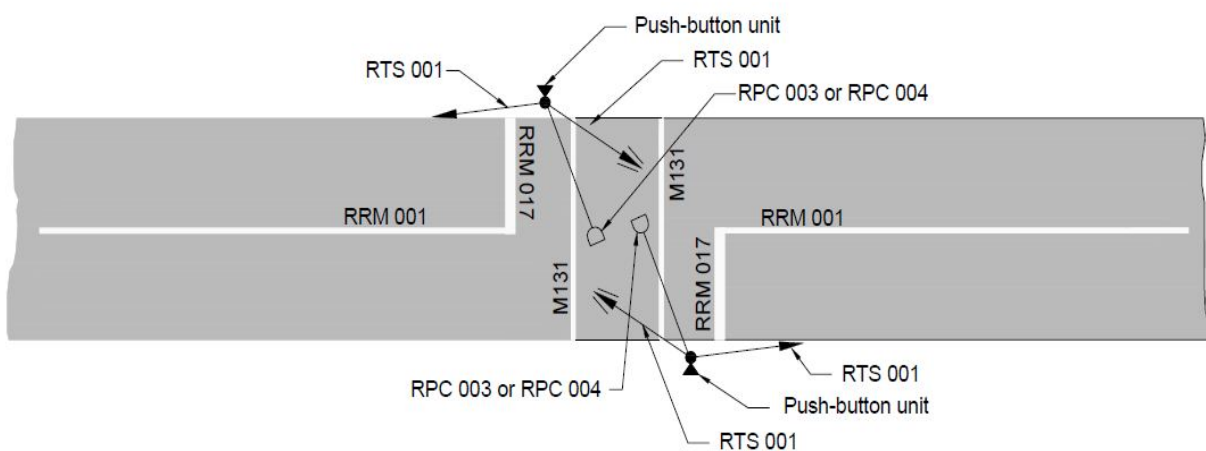

Figure 7.53:
Signalised Pedestrian Crossing

ZIG-ZAG MARKINGS (RPC 002)

7.16.18 Both Zebra Crossings and Signalised Pedestrian Crossings may be accompanied by Zigzag Markings and Terminal Lines (RPC 002) along the edge of carriageway before and after the crossing. Zigzag Markings serve the dual purpose of indicating that part of the road (the 'controlled area') where vehicles are not permitted to park in the vicinity of a pedestrian crossing and providing visual warning to drivers of the location of a crossing.

7.16.19 The length of each zigzag mark is 2m measured parallel to the adjacent kerb.

7.16.20 The "standard" controlled area is designated by eight 2m zigzag marks laid adjacent to the nearside kerb on the approach to a crossing, and a minimum of three zigzag marks adjacent to the kerb on the exit to the crossing; this may be extended as required by site conditions. A gap of 200mm to 250mm should be left between the kerb and the nearest part of the Zigzag Markings. Where a longer approach warning is required, e.g. due to poor visibility or speed of traffic, the number of zigzag marks may be increased to a maximum of eighteen. Where the siting of a crossing makes it impracticable to provide eight zigzag marks on the approach, the number may be reduced to a minimum of three marks. At the end of the Zigzags Markings remote from the crossing, a transverse Terminal Line, 600mm long by 200mm wide, shall be provided.

7.16.21 Within the 'controlled area' of a Zebra Crossing, pedestrians are prohibited from crossing the roadway other than on the pedestrian crossing, and the parking of vehicles is restricted. Together with the markings to indicate a Pedestrian Crossing, RPC 001, the Zigzag Markings and Terminal Lines, RPC 002, indicate the extent of the controlled area (see Figure 7.54).

7.16.22 Zigzag Markings and Terminal Lines shall be provided on each side of the carriageway, on the approaches and departures, to create the 'controlled area'.

7.16.23 On carriageways greater than 6.2m wide a third Zigzag Marking shall be laid along the centre of the road for the same length as the longer of the two edge Zigzag Markings. Where there is a pedestrian refuge, a double row of Zigzag Markings should be laid, one either side of the refuge.

7.16.24 Where traffic approaches or leaves the crossing in two or more lanes, the lanes shall be segregated with Lane Lines, RRM 003B, 100mm wide, with 2m marks and 2m gaps for the length of the controlled area.

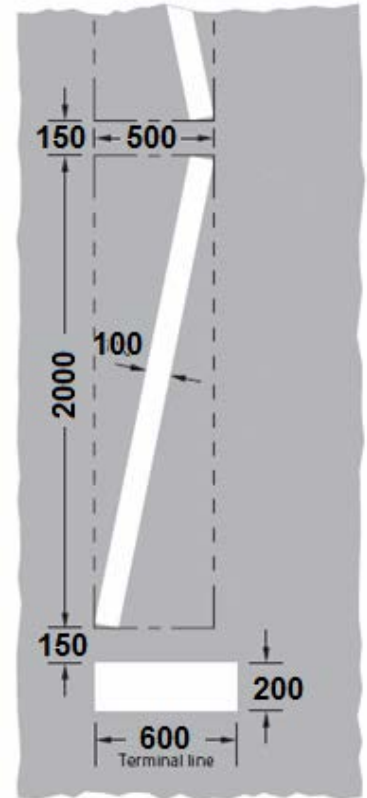

RPC 002:
Zigzag and Terminal
Line

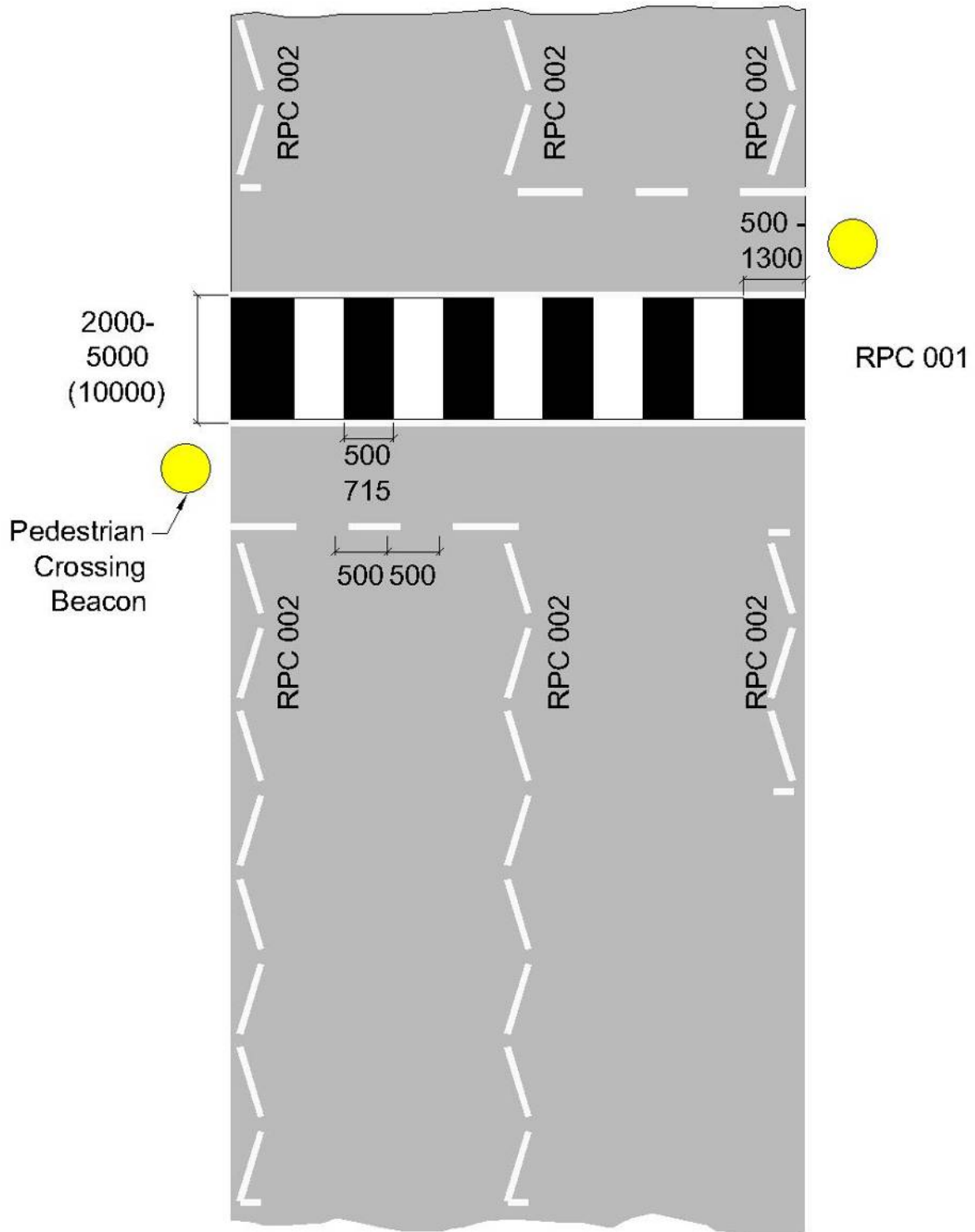

Figure 7.54:
Zebra Pedestrian Crossing with RPC002

7.16.25 Zigzag Markings and Terminal Lines, RPC 002, may also be used to define a controlled area adjacent to a Signalised Pedestrian Crossing. The requirements are the same as for these markings adjacent to a Zebra Crossing (see Figure 7.55).

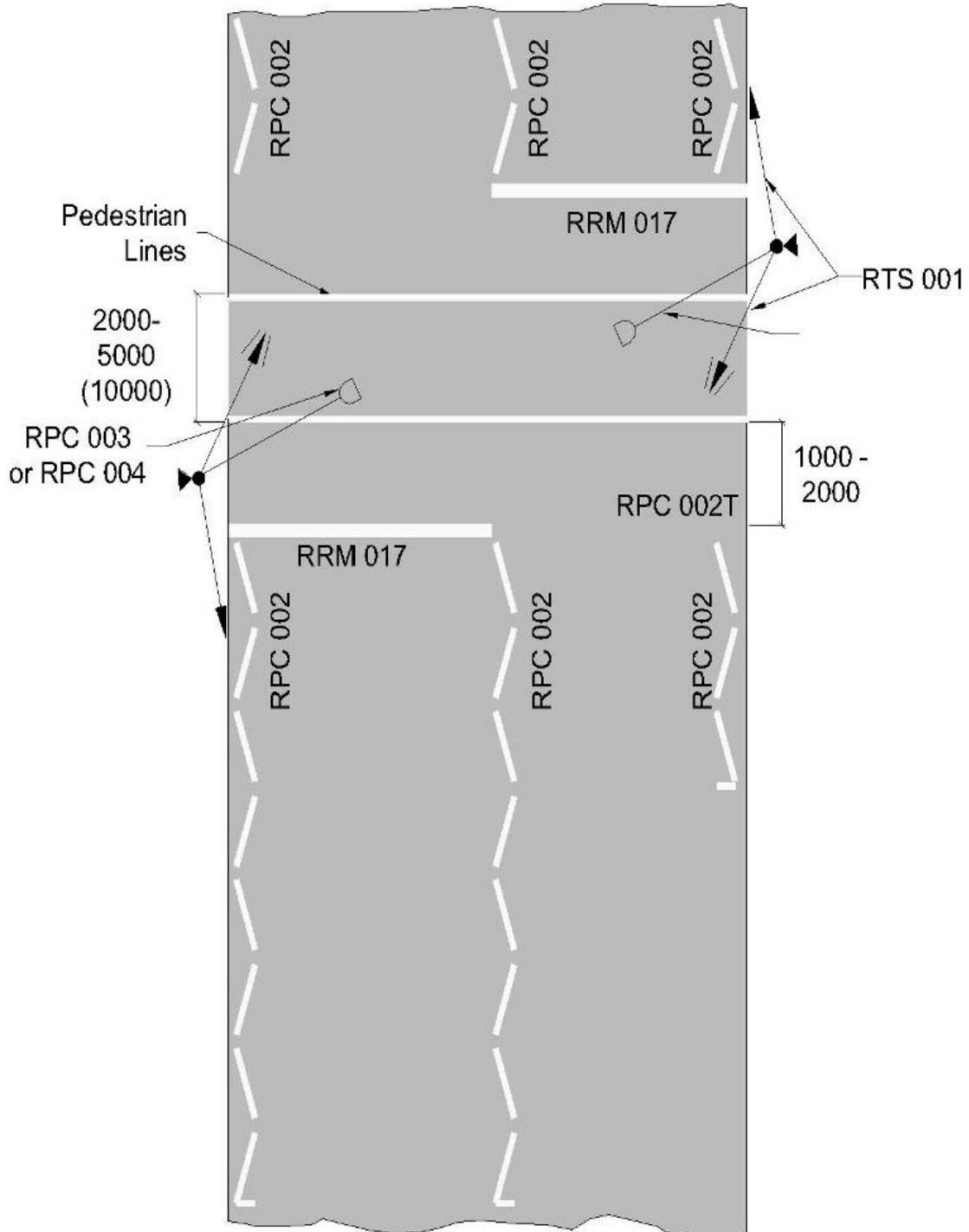

Figure 7.55:
Signalised Pedestrian Crossing with RPC 002

7.16.26 In cases where a build-out has been provided to enhance pedestrian visibility, or alternatively where a lay-by exists or can be constructed, it is acceptable to permit parking or loading between the edge Zigzag marking and the kerb. However, such bays shall be no closer than 8m from the crossing. Figure 7.56 shows a typical layout with a build-out on the approach to a Zebra Crossing.

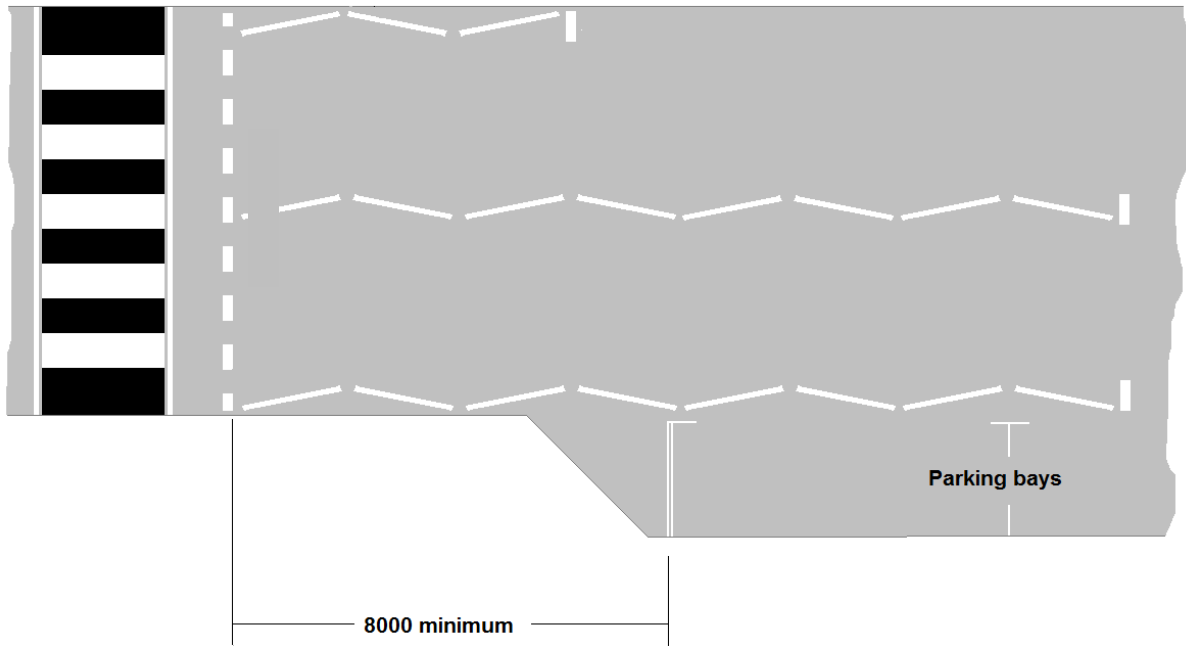
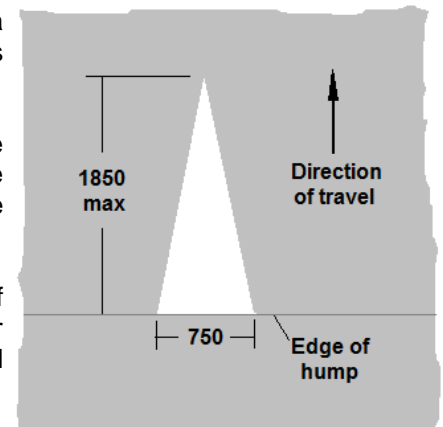

Figure 7.56:
Parking on the Approach to a Zebra Crossing with Build-out

7.17 Traffic Calming

- 7.17.1 The Traffic Calming Triangle, M 112, is used on the approach side of vertical traffic calming features. It should extend from the leading edge of the hump or cushion to the highest point (or for a maximum distance of 1850mm). Figure 7.57 illustrates its application in specific circumstances.
- 7.17.2 At speed cushions, a single M 112 marking should be used on the approach ramp. Where vehicles from both directions might be driven over the same cushion, the triangular marking should be used on both approach ramps.
- 7.17.3 At road humps, the marking M 112 should extend for the length of the ramp, or for a maximum distance of 1850mm. Two triangular marks should be used in each lane; in one-way roads they should be placed only on the approach side of a road hump.
- 7.17.4 Except on roads with a 30km/h speed limit, lengths of road with road humps should be provided with Road Hump warning signs, W 130, at either end (see Chapter 6).



M 112
Traffic Calming Triangle

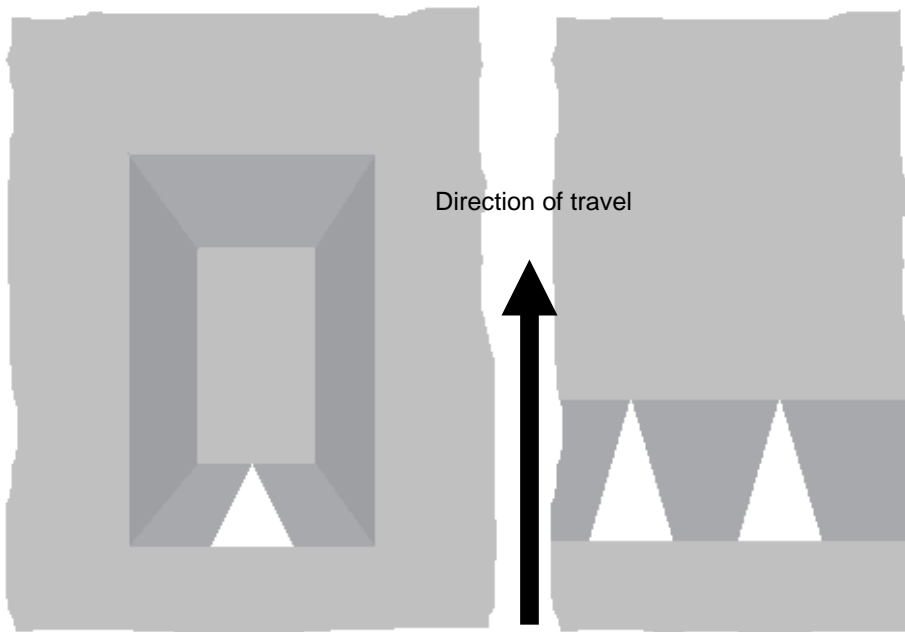

Figure 7.57:
Traffic Calming Triangle on Speed Cushion and Speed Hump

7.18 Yellow Bar Markings

7.18.1 Yellow Bar Markings, M 113, are used in certain conditions on high speed approaches to roundabouts, either on the main carriageway or on an exit slip road. They have been shown to be effective in reducing collisions associated with speed adaptation, i.e. where drivers have been travelling at sustained high speed for long periods. The types of collisions most likely to be influenced are single vehicle and overrun collisions.

7.18.2 Yellow Bar Markings should not be used in an attempt to reduce speeds at sharp bends or other hazards. They are not normally appropriate on slip roads if there is a segregated left-turn lane for the roundabout, or at roundabouts controlled by traffic signals. On approaching a green signal, some drivers will slow down in response to the markings, while others will maintain speed in an attempt to beat a change to red. Markings are unlikely to be appropriate in such cases unless the collision justification is strong.

7.18.3 Before use of Yellow Bar Markings is contemplated, it is essential to ensure that all standard signing has been correctly installed. The warning signs described in Chapter 6 should be provided and be of the appropriate sizes. All signs should be checked to ensure they are in good condition, not obscured, e.g. by vegetation, and are sited at the correct distances from the junction. Only then should treatment with Yellow Bar Markings be considered.

7.18.4 Yellow Bar Markings should only be used where the following criteria are satisfied:

- The carriageway on which they are to be laid is a one-way approach to a roundabout (i.e. a dual carriageway or an exit slip road);
- There is at least 3km of dual carriageway in advance of the site, with no major intersections or curves with a horizontal radius less than the desirable minimum for a 100km/h design speed (see DN-GEO-03031);
- The road is subject to a speed limit of 100km/h or 120km/h; and
- The collision record for the roundabout includes at least three collisions involving personal injury during the preceding three years, in which speed on the relevant approach was a contributory factor.

7.18.5 Each approach to a given roundabout shall be treated as a separate site and the use of the markings on each approach should be justified independently. The application of the criteria in the previous paragraph will ensure that the markings are used only at sites where they are likely to make a positive contribution to safety.

7.18.6 Yellow Bar Markings consists of a series of yellow transverse bars across the carriageway. The bars are 600mm wide and are laid at right angles to the centre line of the carriageway. The bar closest to the roundabout (D1) is laid at a distance of 50m, measured along the centre line of the carriageway, in advance of the No Entry Line. Successive bars are spaced in accordance

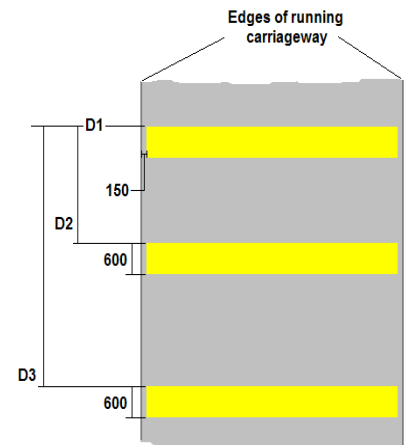

**M 113:
Yellow Bar Markings**

with the running measurements given in Table 7.7. The 45 marks spaced as specified are designed to reduce the approach speed of traffic from an entry speed of 120km/h at D45 to about 40km/h at D1 (i.e. 50m from the No Entry Line) and extend for an overall distance of 200m (see Figure 7.58).

- 7.18.7 To assist surface water drainage, each end of each bar should be terminated about 150mm from the edge of the carriageway or the Edge of Carriageway Line if provided. This may be increased to 750mm where there is a particular drainage problem, or if there are significant numbers of cyclists. Bars should not be extended across hard strips or hard shoulders as this would give the impression that these are traffic lanes.
- 7.18.8 The bars should not exceed 5mm in thickness, and the combined thickness of the bars and any superimposed marking must not exceed 6mm. Although thinner markings might need more frequent renewal, they are less likely to result in noise levels which would be unacceptable to local residents. Drop-on glass beads should not be applied.

Table 7.7: Spacing of Yellow Bar Markings

Bar No.	Distance from D1 (m)	Bar No.	Distance from D1 (m)	Bar No.	Distance from D1 (m)
D1	0.00	D16	47.60	D31	112.85
D2	2.55	D17	51.25	D32	118.00
D3	5.35	D18	55.00	D33	123.30
D4	8.20	D19	58.85	D34	128.70
D5	11.15	D20	62.80	D35	134.20
D6	14.20	D21	66.85	D36	139.80
D7	17.30	D22	71.00	D37	145.50
D8	20.45	D23	75.25	D38	151.35
D9	23.65	D24	79.60	D39	157.35
D10	26.90	D25	84.05	D40	163.55
D11	30.20	D26	88.60	D41	170.00
D12	33.55	D27	93.25	D42	176.70
D13	36.95	D28	98.00	D43	183.90
D14	40.45	D29	102.85	D44	191.60
D15	44.00	D30	107.80	D45	200.00

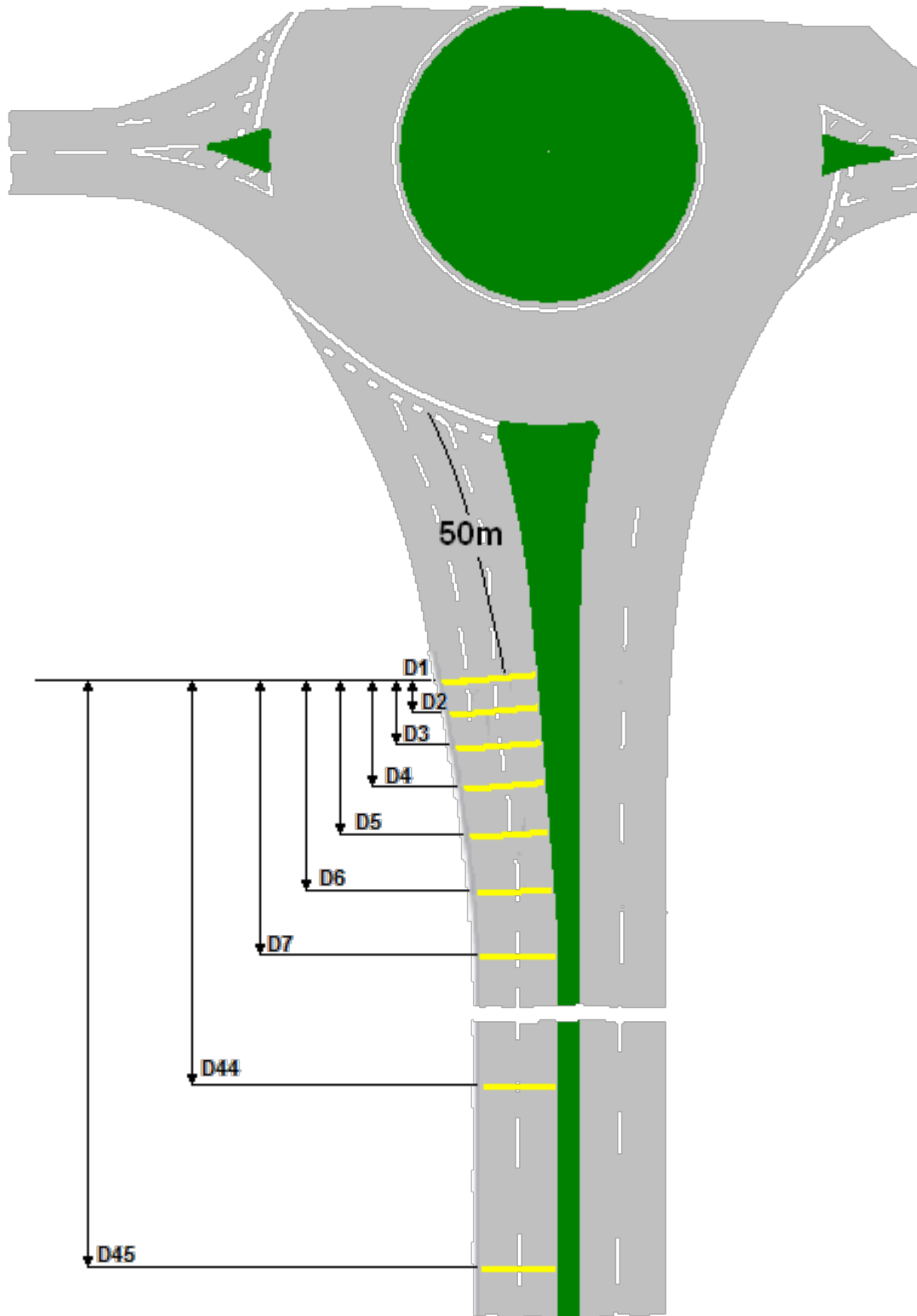

Figure 7.58:
Yellow Bar Markings on Approach to Roundabout

Appendix 7A: Lettering for Worded Markings

- 7A.1 The characters used for worded road markings are the capital letters, numerals, ampersand (&), forward slash (/), apostrophe and fada from the Transport Medium alphabet. The base font is shown in Figure 7.60 with an x-height of 400mm (capital letter height 560mm), although it may be scaled as necessary for specific letter heights (e.g. 300mm capital letter height for 'LOADING' in RRM 009).
- 7A.2 To produce the elongated fonts as specified in a number of markings (e.g. 'STOP', M 114), the 400mm x-height base font is stretched vertically by ratios of 200/70 and 350/70 (see Figure 7.59) to produce capital letters of 1600 and 2800mm as required. The elongated fonts are shown in Figures 7.61 and 7.62.

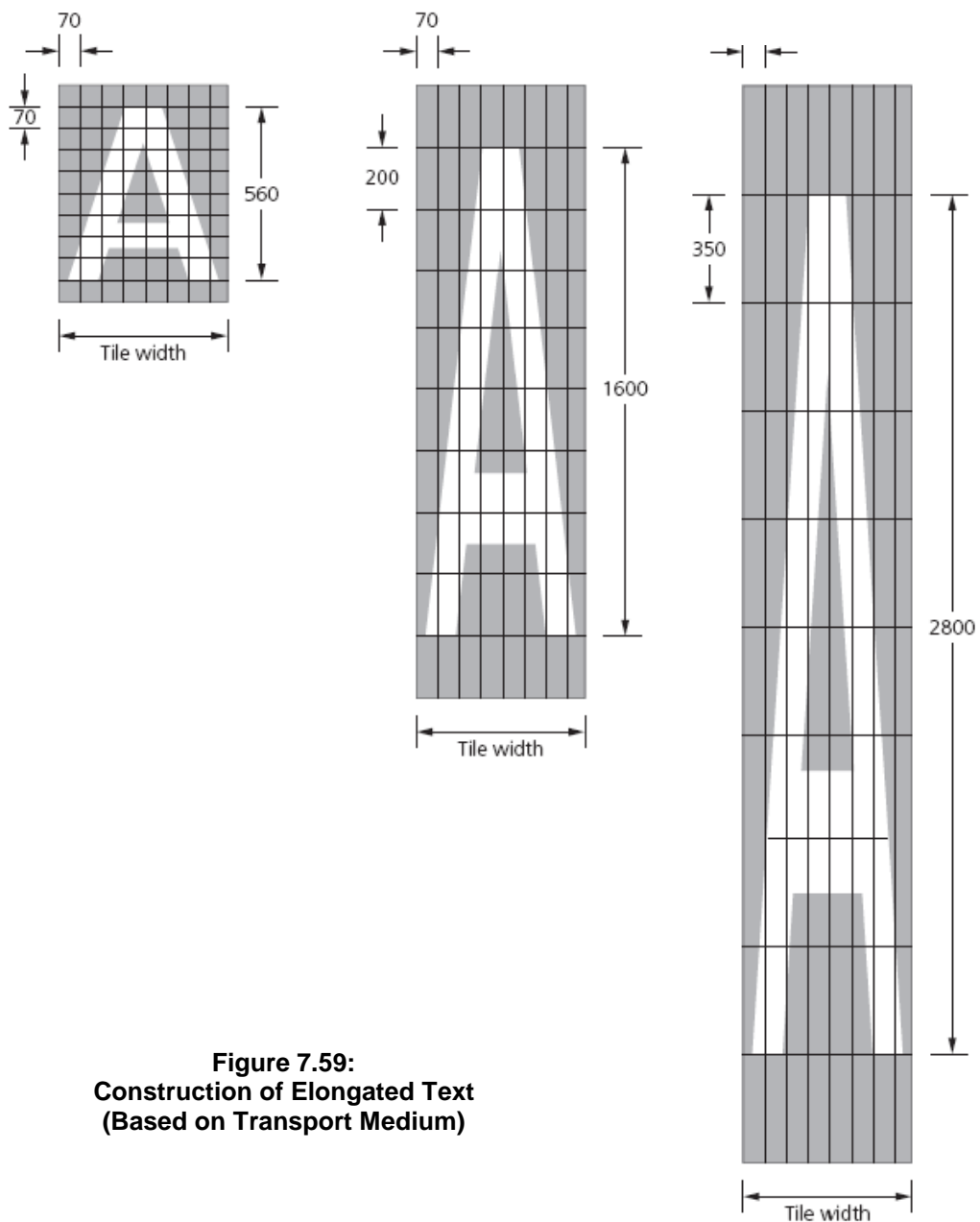

Figure 7.59:
Construction of Elongated Text
(Based on Transport Medium)

7A.3 To ensure correct letter spacing when forming a word, the characters are placed on imaginary tiles which vary in width according to the size of the character and the tiles butted up to each other to make the legend. The tile width for each letter is shown in Table 7.8 and will be the same for both the elongated letter heights and for the 560mm high base font. The distance between the tiles of separate words when marked on a single line is 400 mm, measured to the edge of the tiles and not to the actual characters.

Table 7.8: Character Tile Widths

Letter	Width (mm)	Letter	Width (mm)	Letter	Width (mm)
A	544	N	672	1	316
B	588	O	624	2	480
C	592	P	520	3	508
D	616	Q	632	4	528
E	528	R	564	5	488
F	476	S	548	6	504
G	620	T	436	7	416
H	640	U	616	8	520
I	292	V	520	9	512
J	372	W	732	0	532
K	552	X	512	'	156
L	428	Y	492	&	504
M	736	Z	476	/	420

7A.4 The fada accent (shown inset above the letter 'A' in each of the following figures) can apply to any vowel and should be ignored when spacing words vertically. It will therefore have no effect on either the tile width or height of the corresponding letter.

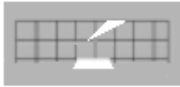

Figure 7.60:
Transport Medium Base Font

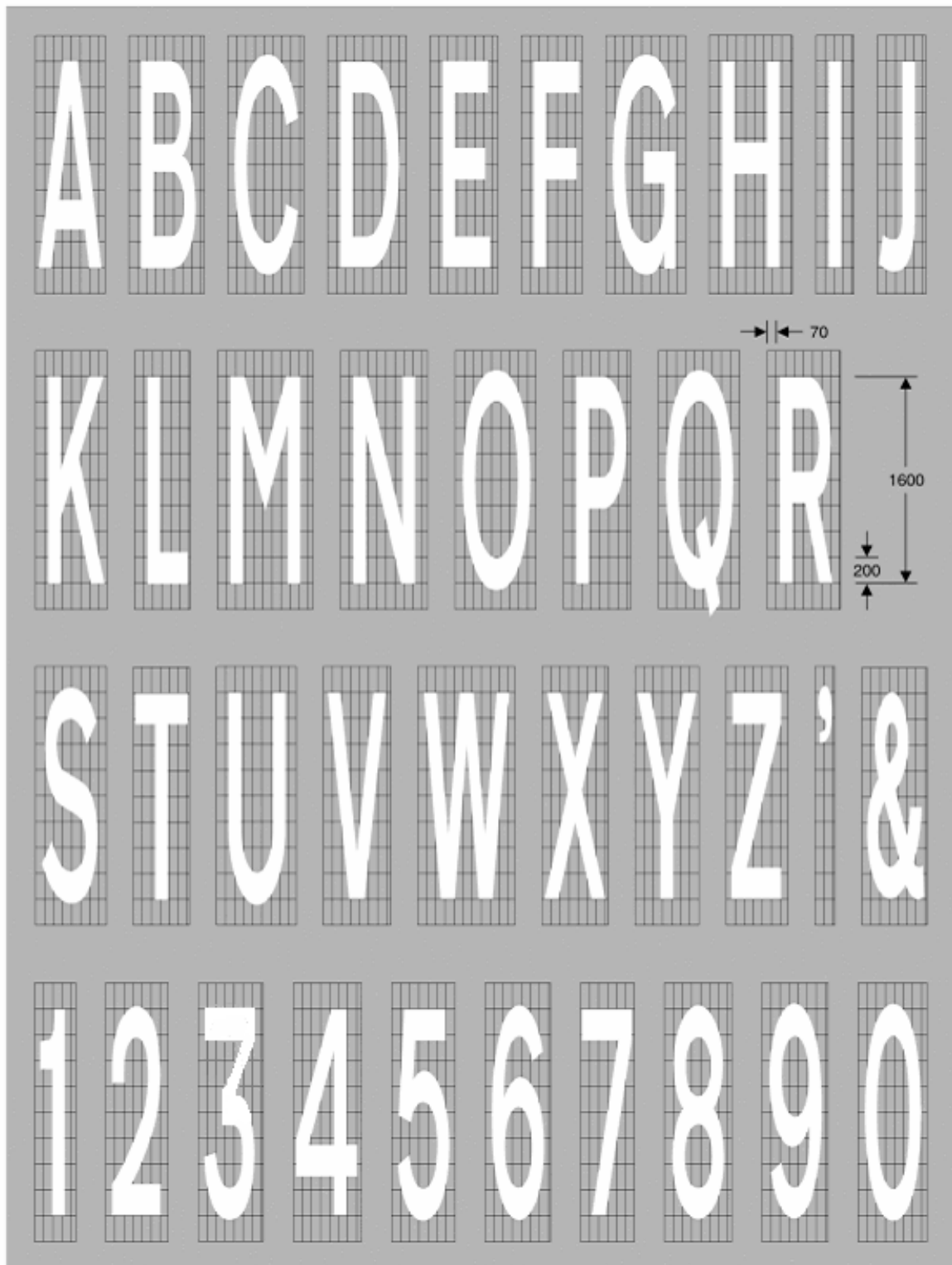

Figure 7.61:
1600mm Elongated Font

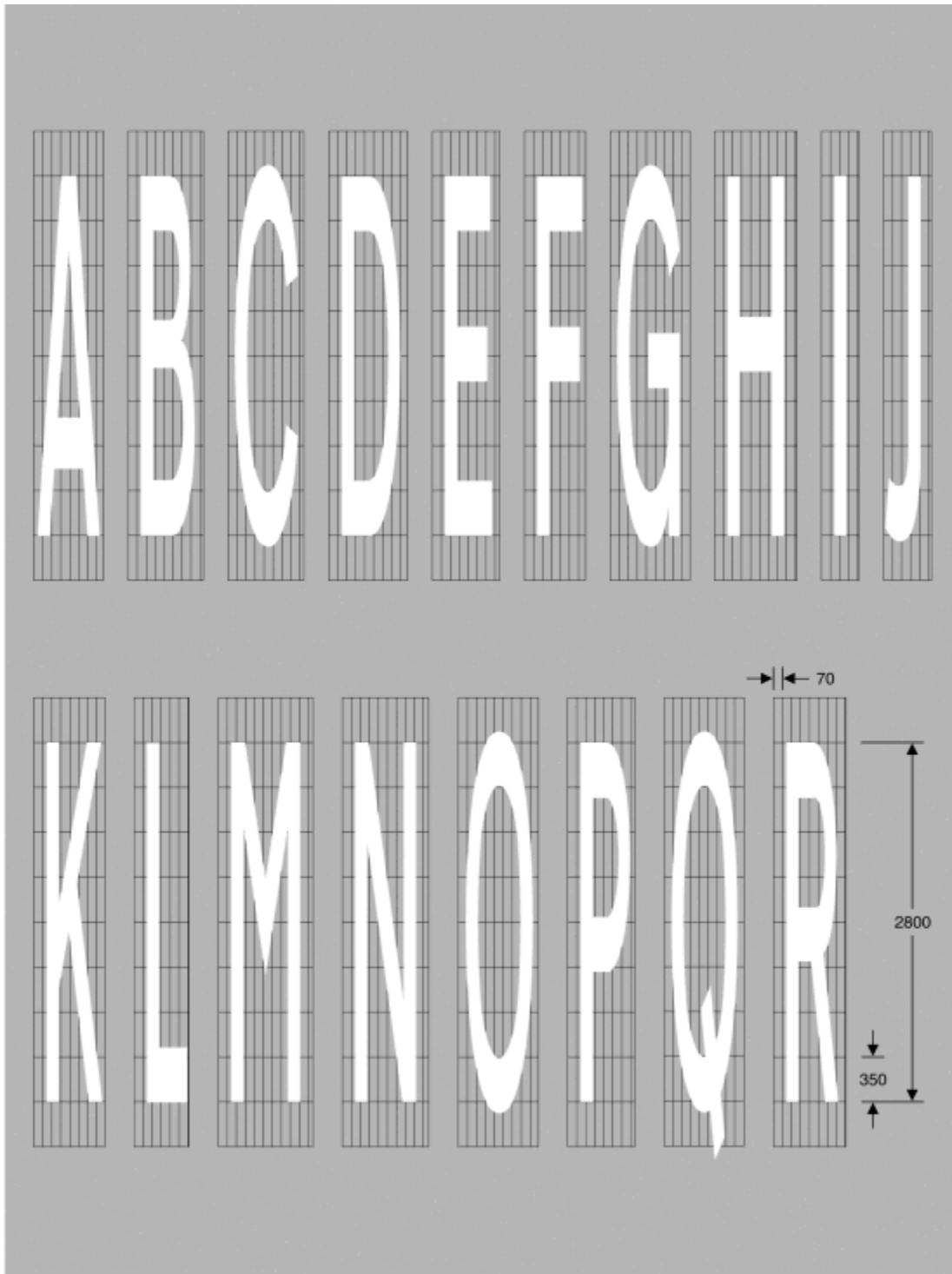
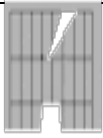

Figure 7.62:
2800mm Elongated Font

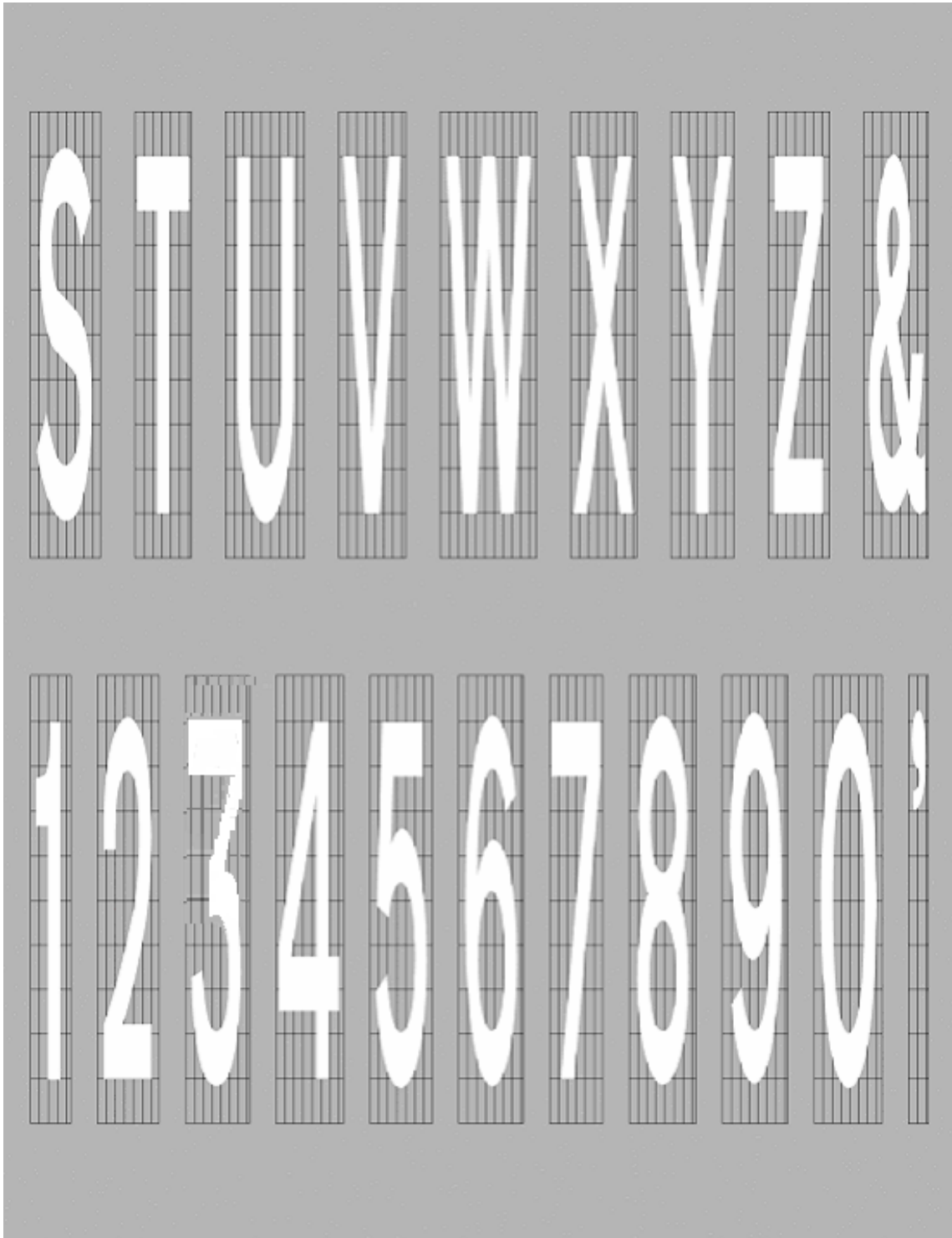
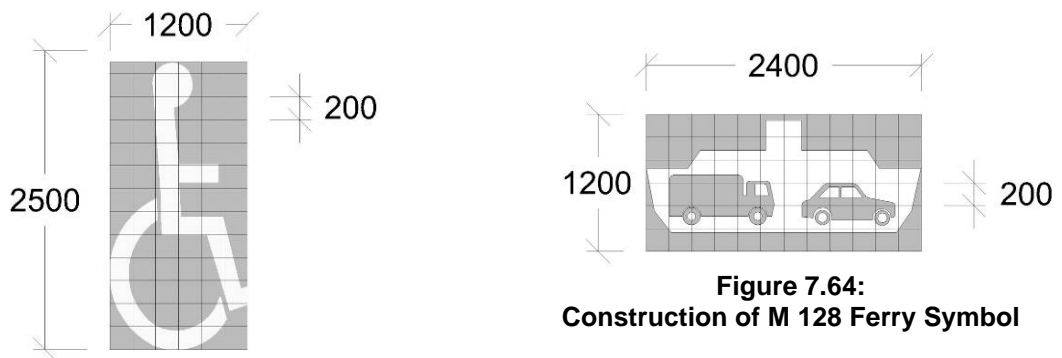
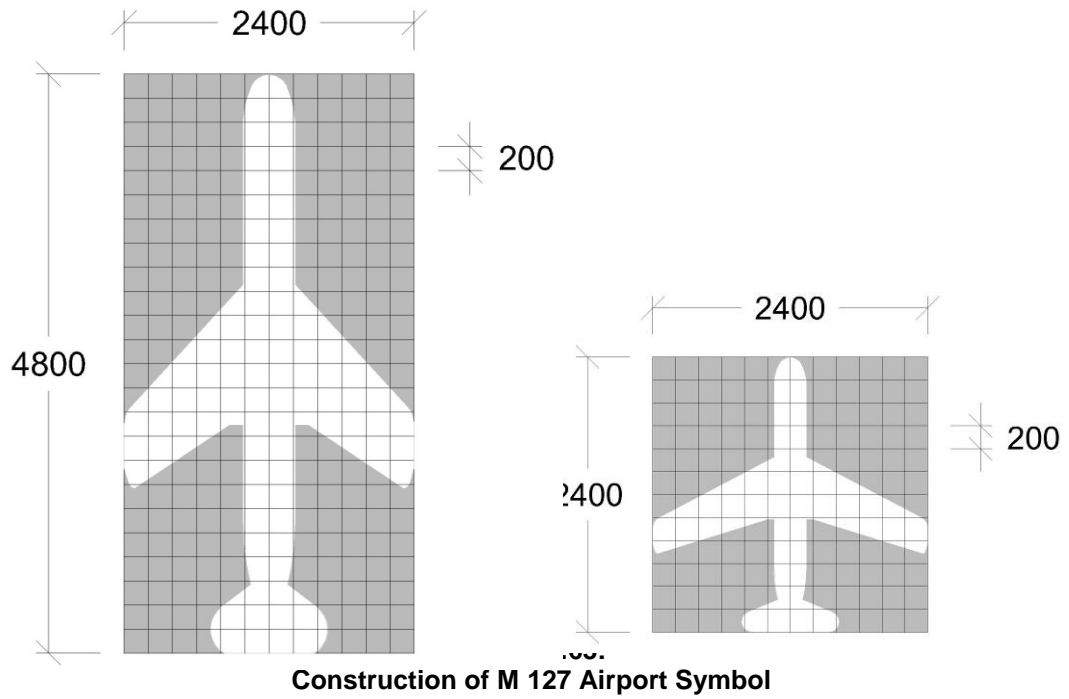

Figure 7.62:
2800mm Elongated Font (Continued)

Appendix 7B: Airport, Ferry and Disabled Persons Symbols



**Figure 7.65:
Construction of RRM 015
Disabled Persons Symbol**

Appendix 7C: Schedule of Road Markings

Sign Number	Description	See Section
Regulatory Road Markings		
RRM 001	Continuous Single Centre Line	7.3 (7.2, 7.4, 7.10 – 7.12, 7.15, 7.16)
RRM 002A & B	Broken Centre Line	7.3 (7.10, 7.11, 7.13, 7.15)
RRM 002C & D	Centre Warning Line	7.3 (7.4, 7.10, 7.11, 7.15)
RRM 003A & B	Lane Line	7.3 (7.4, 7.10 – 7.14, 7.16)
RRM 003C	Modified Lane Line	7.13 (7.3)
RRM 004	Direction Arrow – Straight Ahead	7.5 (7.7, 7.11, 7.12)
RRM 005	Direction Arrow – Left	7.5 (7.11)
RRM 006	Direction Arrow – Right	7.5 (7.11)
RRM 007	Single Yellow Line	7.6
RRM 008	Double Yellow Line	7.6
RRM 009	Loading Bay	7.6 (App 7A)
RRM 010	School Keep Clear	7.5
RRM 011	Parking Bays – Parallel	7.6
RRM 012	Parking Bays – Parallel with Buffer Zone	7.6
RRM 013	Parking Bays – Perpendicular	7.6
RRM 014	Parking Bays – Angled	7.6
RRM 015	Disabled Persons Symbol	7.6 (App 7B)
RRM 016	Parking Bays – Unsegregated	7.6
RRM 017	Stop Line	7.2 (7.3, 7.5, 7.11, 7.12, 7.15, 7.16)
RRM 018	Yield Line	7.2 (7.3, 7.5, 7.11)
RRM 018C	Cycle Track Yield Line	7.8 (7.2)
RRM 019	No Entry Line	7.2 (7.5, 7.11, 7.13)
RRM 020	Yellow Box Marking	7.9 (7.7, 7.15)
RRM 021	Hatch Marking	7.4 (7.3, 7.10, 7.13, 7.14)
RRM 022	Cycle Track Edge Line	7.8
RRM 023	Cycle Track Broken Edge Line	7.8
RRM 024	Bus Lane Line and LÁNA BUS Marking	7.7
RRM 025	Edge of Carriageway Line (Broken)	7.3 (7.4, 7.8, 7.10, 7.11, 7.13 – 7.15)
RRM 026	Edge of Carriageway Line (Continuous)	7.3 (7.4, 7.10)

Sign Number	Description	See Section
RRM 027	Edge of Carriageway Line (Continuous White)	7.3 (7.4, 7.10, 7.11, 7.13, 7.14)
RRM 028	Merge/Diverge Lane Line	7.3 (7.10, 7.14)
RRM 029	Taxi Rank Marking	7.6
RRM 030	Bus Stop Marking	7.7
RRM 031	Tram Stop Line	7.2
RRM 032	Tram Lane Line	7.7
RRM 033	Mini-Roundabout Marking	7.13
RRM 034	Electric Vehicle Recharging Bay Markings	7.6

Sign Number	Description	See Section
Non-regulatory Road Markings		
M 100	Deflection Arrow (Left)	7.5 (7.3, 7.4)
M 101	Deflection Arrow (Right)	7.5 (7.7, 7.8)
M 102	Bifurcation Arrow	7.5
M 103	Two-Lane Arrow	7.5
M 104	Diagonal Hatch Marking within Double Line System	7.3
M 105	Lane Destination Marking	7.5
M 106	SLOW Worded Marking	7.5
M 107L & R	LOOK LEFT / LOOK RIGHT Marking	7.5 (7.7)
M 108	Speed Marking	7.5
M 109	LÁNA TRAM Worded Marking	7.7
M 110	Swept Path Marking	7.7
M 111	Pedestrian Symbol	7.8
M 112	Traffic Calming Triangle	7.17
M 113	Yellow Bar Markings	7.18
M 114	STOP Worded Marking	7.5 (7.2, 7.11, App 7A)
M 115	Triangular Yield Marking	7.5 (7.2, 7.11, 7.13)
M 115C	Cycle Track Triangular Yield Marking	7.8
M 116	Cycle Symbol	7.8
M 117	Cycle Track Direction Arrow – Left	7.8
M 118	Cycle Track Direction Arrow – Straight Ahead	7.8
M 119	Cycle Track Direction Arrow – Right	7.8

Sign Number	Description	See Section
M 120	Chainage and Emergency Telephone Marking	7.5
M 121	School Crossing Patrol Point	7.5
M 122	Exit Boundary Line at Level Crossing	7.15
M 123	Back of Footway Line at Level Crossing	7.15
M 124	Direction Arrow – Ahead & Left	7.5 (7.12)
M 125	Direction Arrow – Ahead & Right	7.5 (7.12)
M 126	Direction Arrow – Left & Right	7.5
M 127	Airport Destination Marking	7.5 (App 7B)
M 128	Ferry Port Destination Marking	7.5 (App 7B)
M 129	Broken Bus Lane Line	7.7
M 130	Bus Lane Ends Arrow	7.7
M 130L & R	Bus Lane Ends Arrow – L and R Variants	7.7
M 131	Pedestrian Line	7.16 (7.12)

Sign Number	Name	See Section
Pedestrian Crossings (Regulatory)		
RPC 001	Zebra Pedestrian Crossing	7.16 (7.2)
RPC 002	Zigzag Markings	7.16